



---

# User's Guide

# RIGOL

Publication number UGA07107-1110

July 2008

## **DS1000E, DS1000D Series Digital Oscilloscopes**

DS1102E, DS1052E, DS1102D, DS1052D



- © 2008 **RIGOL** Technologies, Inc. All Rights Reserved
- **RIGOL** products are protected by patent law in and outside of P.R. China.
- Information in this publication replaces all previously corresponding material.
- **RIGOL** Technologies, Inc. reserves the right to modify or change part of or all the specifications and pricing policies at company's sole decision.

**NOTE:** **RIGOL** is registered trademark of **RIGOL** Technologies, Inc.

## Safety Notices

Review the following safety precautions carefully before operating the instrument to avoid any personal injuries or damages to the instrument and any products connected to it. To avoid potential hazards use the instrument as specified by this user's guide only.

**The instrument should be serviced by qualified personnel only.**

### To Avoid Fire or Personal Injury

**Use Proper Power Cord.** Use the power cord designed for the instrument and authorized in your country only.

**Connect and Disconnect Accessories.** Do not connect or disconnect probes or test leads while they are connected to a voltage source

**Ground The Instrument.** The oscilloscope is grounded through the grounding conductor of the power cord. To avoid electric shock the instrument grounding conductor(s) must be grounded properly. Before making connections to the input or output terminals of the instrument.

**Connect The Probe.** The probes' ground terminals are at the same voltage level of the instrument ground. Do not connect the ground terminals to a high voltage.

**Observe All Terminal Ratings.** To avoid fire or shock hazard, observe all ratings and marks on the instrument. Follow the user's guide for further ratings information before making connections to the instrument.

**Do Not Operate Without Covers.** Do not operate the instrument with covers or panels removed.

**Use Proper Fuse.** Use the fuse of the type, voltage and current ratings as specified for the instrument.

**Avoid Circuit or Wire Exposure.** Do not touch exposed connections and components when power is on.

**Do Not Operate With Suspected Failures.** If suspected damage occurs with the instrument, have it inspected by qualified service personnel before further operations.

**Provide Proper Ventilation.** Refer to the installation instructions for proper ventilation of the instrument.

**Do not operate in wet/damp conditions**

**Do not operate in an explosive atmosphere**

**Keep product surfaces clean and dry**

**The disturbance test of all the models meet the limit values of A in the standard of EN 61326: 1997+A1+A2+A3, but can't meet the limit values of B.**

### **Measurement Category**

The DS1000E, DS1000D series Digital Oscilloscope is intended to be used for measurements in Measurement Category I.

### **Measurement Category Definitions**

Measurement Category I is for measurements performed on circuits not directly connected to MAINS. Examples are measurements on circuits not derived from MAINS, and specially protected (internal) MAINS derived circuits. In the latter case, transient stresses are variable; for that reason, the transient withstand capability of the equipment is made known to the user.

### **WARNING**

IEC Measurement Category I. The input terminals may be connected to circuit terminal in IEC Category I installations for voltages up to 300 VAC. To avoid the danger of electric shock, do not connect the inputs to circuit's voltages above 300 VAC. Transient overvoltage is also present on circuits that are isolated from mains. The DS1000E, DS1000D series Digital Oscilloscopes is designed to safely withstand occasional transient overvoltage up to 1000Vpk. Do not use this equipment to measure circuits where transient overvoltage could exceed this level.

## Safety Terms and Symbols

**Terms in This Guide.** These terms may appear in this guide:



---

**WARNING:** Warning statements identify conditions or practices that could result in injury or loss of life.

---



---

**CAUTION:** Caution statements identify conditions or practices that could result in damage to this product or other property.

---

**Terms on the Product:** These terms may appear on the product:

**DANGER** indicates an injury hazard may be immediately accessible.

**WARNING** indicates an injury hazard may be not immediately accessible.

**CAUTION** indicates that a potential damage to the instrument or other property might occur.

**Symbols on the Product:** These symbols may appear on the Instrument:



**Hazardous  
Voltage**



**Refer to  
Instructions**



**Protective  
Earth Terminal**



**Grounding  
Terminal of  
Chassis**



**Test  
Grounding  
Terminal**

## General-Purpose Oscilloscopes

This book covers the following four types of DS1000E, DS1000D Series Digital Oscilloscopes:

DS1102E, DS1052E,  
DS1102D, DS1052D. (With Logic Analyzer)

**RIGOL** DS1000E, DS1000D Series Digital Oscilloscopes provide exceptional waveform viewing and measurements in a compact, lightweight package. The DS1000E, DS1000D series is ideal for production test, field service, research, design, education and training applications involving analog/digital circuits test and troubleshooting, as well as education and training.

Features of DS1000E, DS1000D Series:

- Dual Channel, Bandwidth:  
100MHz (DS1102E, DS1102D)  
50MHz (DS1052E, DS1052D)
- Optional 16 digital channels (DS1000D series), each channel can be turned on or off independently, or in a 8 bit group
- Mono/Color TFT LCD Displays at 320×234 resolution
- USB storage and printing supports, software upgradeable via USB connectivity
- Adjustable waveform intensity, more effective waveform viewing
- One-touch automatic setup for ease of use (AUTO)
- Saves 10 Waveforms, 10 setups, supports CSV and bitmap format
- Newly designed Delayed Scan Function, easy to give attention to both details and overview of a waveform
- 20 Automatic measurements
- Automatic cursor tracking measurements
- Waveform recorder, record and replay dynamic waveforms
- User selectable fast offset calibration
- Built-in FFT function, Frequency Counter
- Digital filters, includes LPF, HPF, BPF, BRF
- Pass/Fail Function, optically isolated Pass/Fail output
- Add, Subtract and Multiply Mathematic Functions
- Advanced trigger types include: Edge, Video, Pulse width, Slope, Alternative,

Pattern and Duration (DS1000D series)

- Adjustable trigger sensitivity
- Multiple Language User Interface
- Pop-up menu makes it easy to read and easy to use
- Built-in Chinese and English help system
- Easy-to-use file system supports Chinese & English characters input



# Content

Safety Notices .....	II
General-Purpose Oscilloscopes .....	V
<b>Chapter 1 : Getting Started .....</b>	<b>1-1</b>
The Front Panel and User Interface .....	1-2
To Inspect the Instrument .....	1-5
To Perform a Functional Check.....	1-6
To Compensate Probes.....	1-8
Digital Leads (DS1000D Series) .....	1-9
To Display a Signal Automatically .....	1-11
To Understand the Vertical System .....	1-12
To Understand the Horizontal System .....	1-14
To Trigger the Oscilloscope.....	1-16
<b>Chapter 2 : Operating Your Oscilloscope .....</b>	<b>2-1</b>
To Set up the Vertical System .....	2-2
Settings of the Channels .....	2-2
Math Functions .....	2-13
Using REF .....	2-16
Set up LA Channel (DS1000D Series) .....	2-23
Turn on/off Channels.....	2-28
Set up Vertical Position and Scale .....	2-29
To Set up the Horizontal System.....	2-30
To Set up the Trigger System.....	2-36
Settings for Edge Trigger .....	2-38
Settings for Pulse Width Trigger.....	2-39
Settings for Video Trigger.....	2-41
Slope Trigger .....	2-45
Alternative Trigger.....	2-47
Pattern Trigger (DS1000D Series) .....	2-51
Duration Trigger (DS1000D Series) .....	2-53
Trigger Setup.....	2-55
To Set up the Sampling System.....	2-61
To Set up the Display System.....	2-65
To Store and Recall .....	2-67
To Set up the Utility .....	2-75

---

The I/O setup .....	2-77
Preference .....	2-78
Self-Calibration.....	2-79
Pass/Fail .....	2-80
Mask Setting .....	2-81
Print Setting.....	2-85
Waveform Recorder .....	2-86
Language .....	2-91
To Measure Automatically .....	2-92
The automatic measurement of voltage parameters.....	2-96
The automatic measurement of time parameters.....	2-97
To Measure with Cursors.....	2-98
Manual Mode .....	2-99
Track Mode.....	2-102
Auto mode.....	2-104
To Use Run Control Buttons .....	2-105
<b>Chapter 3 : Application &amp; Examples .....</b>	<b>3-1</b>
Example 1: Taking Simple Measurements .....	3-1
Example 2: View a Signal Delay Caused by a Circuit.....	3-2
Example 3: Capture a Single-Shot Signal .....	3-3
Example 4: To Reduce the Random Noise on a Signal .....	3-4
Example 5: Making Cursor Measurements.....	3-6
Example 6: The application of the X-Y operation .....	3-8
Example 7: Triggering on a Video Signal.....	3-10
Example 8: FFT Cursor measurement .....	3-12
Example 9: Pass/Fail Test.....	3-14
Example 10: Triggering on a Digital Signal.....	3-15
<b>Chapter 4 : Prompt Messages &amp; Troubleshooting .....</b>	<b>4-1</b>
Prompting Message .....	4-1
Troubleshooting .....	4-3
<b>Chapter 5 : Specifications .....</b>	<b>5-1</b>
Specifications.....	5-2
General Specifications.....	5-6
<b>Chapter 6 : Appendix .....</b>	<b>6-1</b>
Appendix A: Accessories.....	6-1

Appendix B: Warranty .....6-2  
Appendix C: Care and Cleaning .....6-3  
Appendix D: Contact RIGOL.....6-4  
**Index ..... 6-1**



# Chapter 1 : Getting Started

This chapter covers the following topics:

- The front panel and user interface
- To inspect the instrument
- To perform a functional check
- To compensate probes
- To use digital leads
- To display a signal automatically
- To understand the vertical system
- To understand the horizontal system
- To trigger the oscilloscope

# The Front Panel and User Interface

The first thing to do with a new oscilloscope is to know its front panel. This chapter helps to be familiar with the layout of the knobs and keys and how to use them. Read the chapter carefully before further operations.

Figure 1- 1, Front Panel; the knobs are used most often and are similar to the knobs on other oscilloscopes. The buttons allow you to use some of the functions directly but also bring up soft button menus on the screen, which enable the access to many measurement features associated with advanced functions, mathematics, and reference or to run control features.

- The front panel of DS1000E:

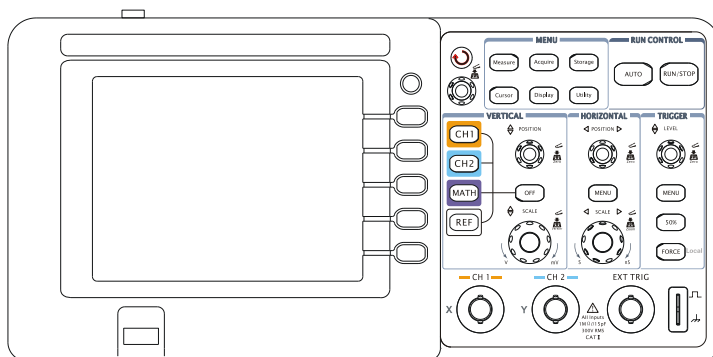

- The front panel of DS1000D:

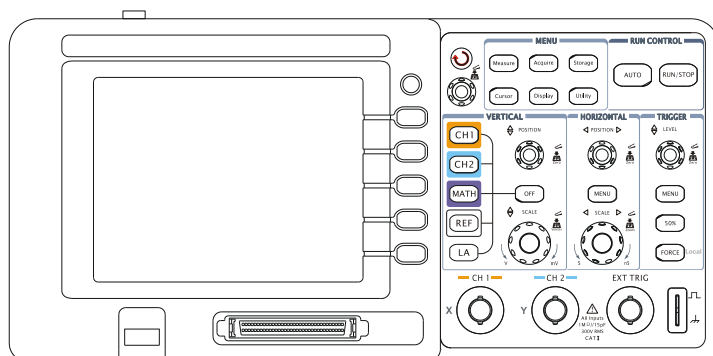

Figure 1- 1  
Front Panel Figure of DS1000E, DS1000D Series Oscilloscope

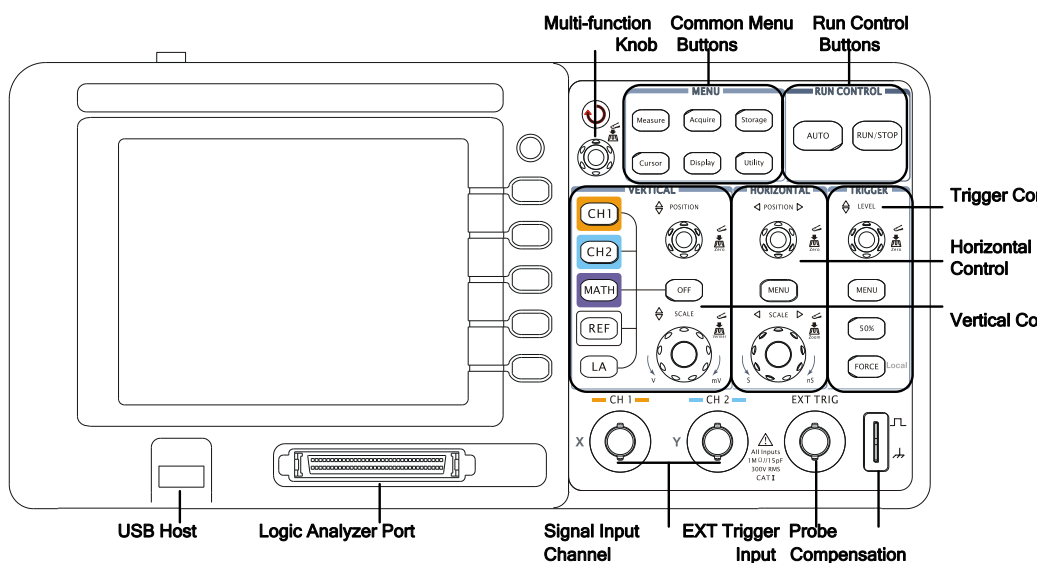

Figure 1- 2  
Front Panel Instruction

### Notation definitions in this User's Guide:

Throughout this manual, notation symbols of buttons and knobs are the same to those on front-panel.

- A box around the name of the key denotes MENU function buttons on front-panel, such as **Measure**.
- (↻) denotes the multi-function knob (↻).
- (⊙) POSITION denotes the two POSITION knobs.
- (⊙) SCALE denotes the two SCALE knobs.
- (⊙) LEVEL denotes the LEVEL knob.
- The name with a drop shadow denotes the menu operating key, such as **WAVEFORM** soft key in STORAGE menu.

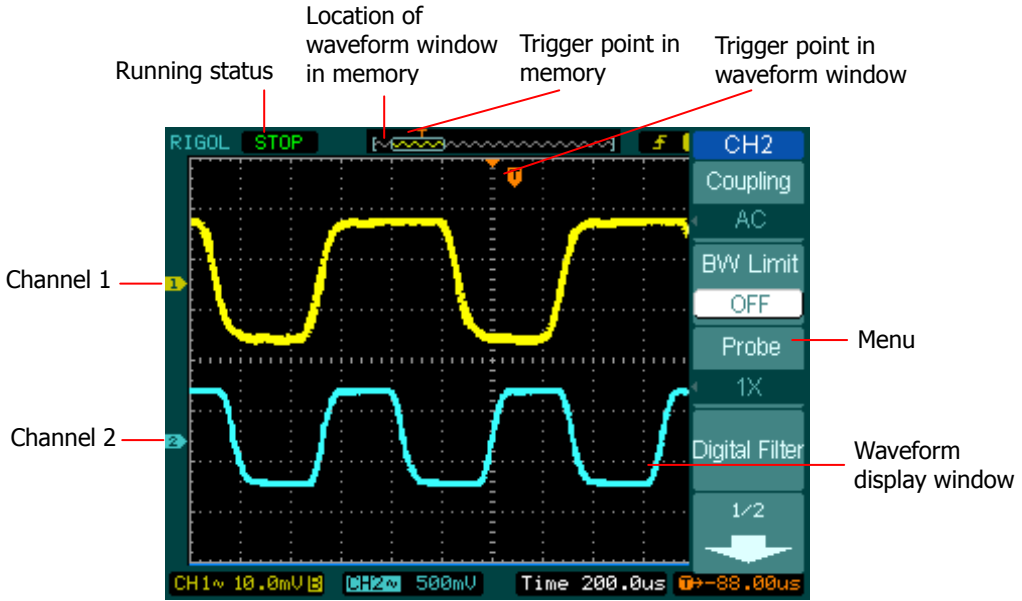

Figure 1- 3  
Display screen (Analog channels only)

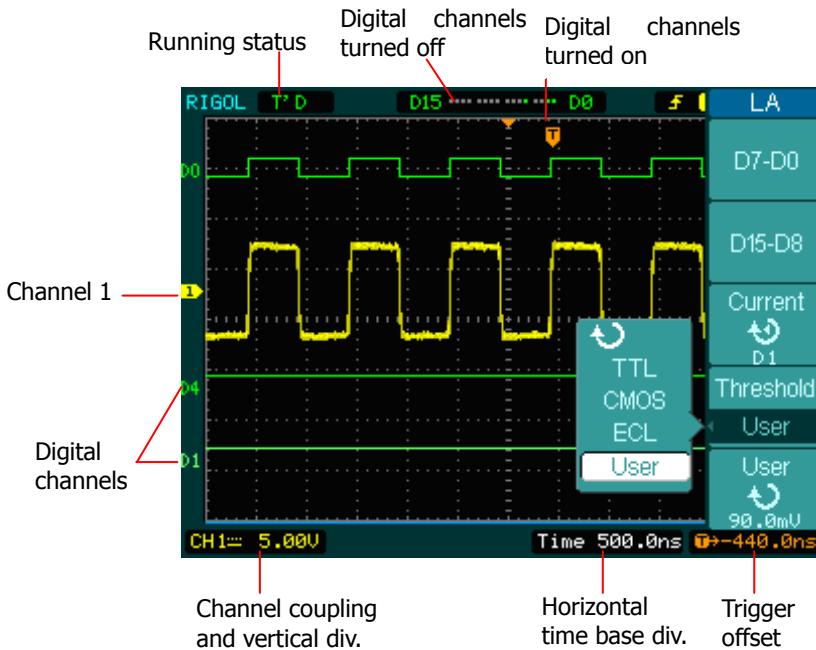

Figure 1- 4  
User Interface (Analog and Digital channels)



## To Inspect the Instrument

When you get a new DS1000E, DS1000D series oscilloscope, please inspect the instrument according to the following steps:

### 1. Inspect the shipping container for damage.

Keep a damaged shipping container or cushioning material until the contents of the shipment have been checked for completeness and the instrument has been checked mechanically and electrically.

### 2. Check the accessories.

Accessories supplied with the instrument are listed in "*Appendix A: Accessories*" in this guide.

If the contents are incomplete or damaged, please notify your **RIGOL** Sales Representative.

### 3. Inspect the instrument.

In case there is any mechanical damage or defect, or the instrument does not operate properly or fails performance tests, please notify the **RIGOL** Sales Representative.

If the shipping container is damaged, or the cushioning materials show signs of stress, please notify the carrier as well as the **RIGOL** sales office. Keep the shipping materials for the carrier's inspection.

**RIGOL** offices will arrange for repair or replacement at **RIGOL**'s option without waiting for claim settlement.

## To Perform a Functional Check

Perform this quick functional check to verify that the instrument is operating correctly.

### 1. Turn on the instrument.

- Use the power cord designed for the oscilloscope only.
- Use a power source that delivers 100 to 240 VAC<sub>RMS</sub>, 45Hz to 440Hz.
- Turn on the instruments, and wait until the display shows the waveform window.
- Push the **Storage** button, select **Storage** in the top menu box and push the **Factory** menu box.

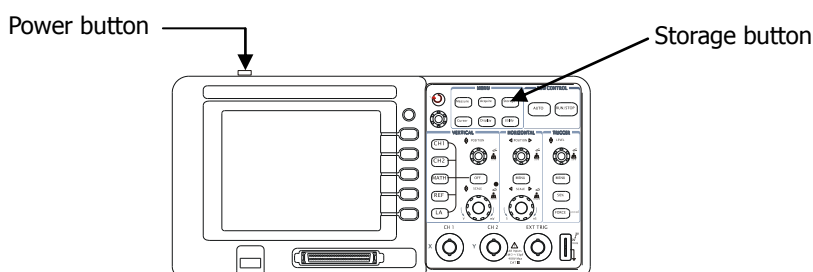

Figure 1- 5  
Turn on and Check the instrument



### **WARNING:**

To avoid electric shock, be sure the oscilloscope is properly grounded.

### 2. Input a signal to a channel of the oscilloscope

DS1000E series: 2 channels input + 1 external trigger channel input

DS1000D series: 2 channels input + 1 external trigger channel input +16 channels digital input

#### Do the following steps:

- ① Set the switch on the probe to 10X and connect the probe to Channel 1 on the

oscilloscope:

- Align the slot in the probe connector with the key on the CH 1 BNC.
  - Push to connect, and twist to the right to lock the probe in place.
- Attach the probe tip and ground lead to the PROBE COMP connector.

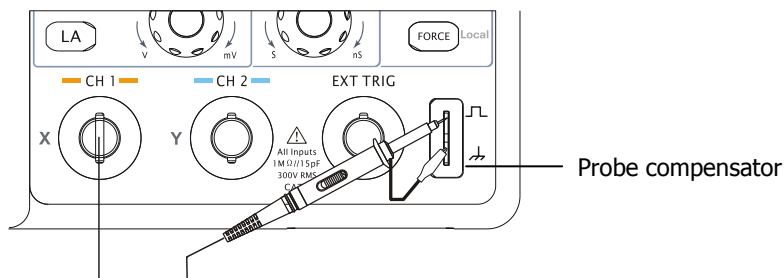

Figure 1- 6  
Attach the probe

- ② Set the probe attenuation to 10X. To do this, push **CH1** → **Probe** → **10X**.

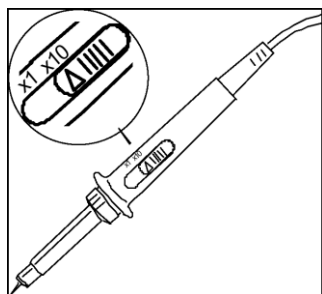

Figure 1- 7  
Set attenuation on the probe

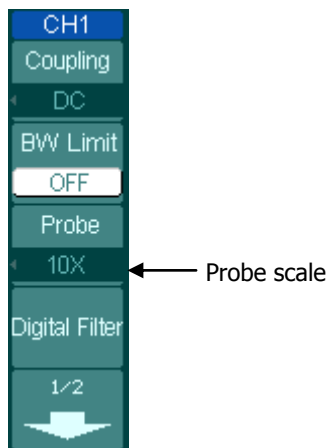

Figure 1- 8  
Set attenuation in the menu

- ③ Push the **AUTO** button. Within a few seconds, a square wave will display.
- ④ Push the **OFF** button or push the **CH1** button again to turn off Channel 1. Push the **CH2** button to turn on channel 2, repeat steps 2 and 3.

**NOTE:** The signal output from Probe compensator should only be used for probe compensation, not for calibration.

## To Compensate Probes

Perform this adjustment to match the characteristics of the probe and the channel input. This should be performed whenever attaching a probe to any input channel for the first time.

1. From CH1 menu, set the Probe attenuation to 10X (press **CH1** → **Probe** → **10X**). Set the switch to 10X on the probe and connect it to CH1 of the oscilloscope. When using the probe hook-tip, inserting the tip onto the probe firmly to ensure a proper connection.  
Attach the probe tip to the Probe compensator connector and the reference lead to the ground pin, Select CH1, and then press **AUTO**.

2. Check the shape of the displayed waveform.

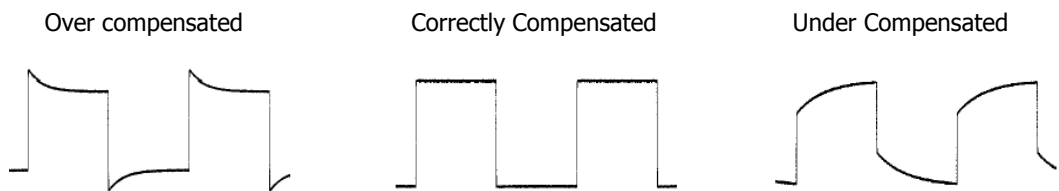

Figure 1- 9  
Probe Compensation

3. If necessary, use a non-metallic tool to adjust the trimmer capacitor on the probe for the flattest square wave possible as displayed on the oscilloscope.
4. Repeat as necessary.



**WARNING:** To avoid electric shock while using the probe, be sure the perfection of the insulated cable, and do not touch the metallic portions of the probe head while it is connected with a voltage source.

## Digital Leads (DS1000D Series)

Digital leads are provided only for DS1000D series which have Logic Analyzer.

1. Switch off power supply of the device under test if necessary to avoid short circuit. Since no voltage is applied to the leads at this step, you may keep the oscilloscope on.
2. Connect one end of the flat cable FC1868 to the Logic Analyzer Input; connect the other end to Logic Head LH1116. An identifier is located on each end of the flat cable; it can only be connected in one way. It is unnecessary to switch off power supply of your oscilloscope when connecting the cable.

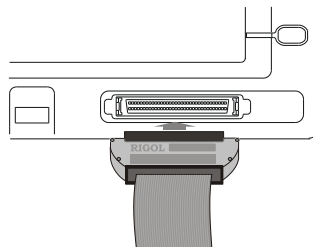

Figure 1- 10  
Connect the digital leads



**CAUTION:** Use only FC1868, LH1116, TC1100 and LC1150 made by **RIGOL** for specified DS1000D series.

3. Connect a test clip to one lead wire; make sure it's connection good.

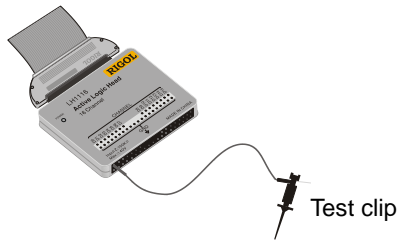

Figure 1- 11

4. Test your device with the clip.

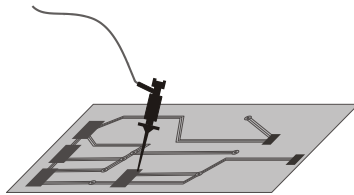

Figure 1- 12

5. Remember to connect Ground Channel to the DUT's ground terminal.

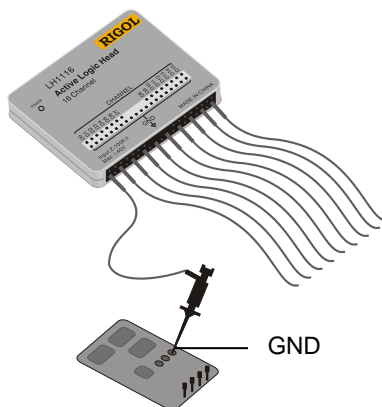

Figure 1- 13

## To Display a Signal Automatically

The oscilloscope has an automated feature to display the input signal best-fit. The input signal should be 50Hz or higher and a duty cycle is greater than 1%.

Press the **AUTO** button, the oscilloscope automatically sets up VERTICAL, HORIZONTAL and TRIGGER controls to display the input signal. Adjust the controls manually to get the best results if necessary.

Connect a signal to the Channel 1 (CH1).

1. Connect a signal to the oscilloscope as described above.
2. Press **AUTO**.

The oscilloscope may change the current settings to display the signal; and adjusts the vertical and horizontal scaling, the trigger coupling, type, position, slope, level, and mode.

## To Understand the Vertical System

Figure 1- 14 shows the VERTICAL controls, **CH1**, **CH2**, **MATH**, **REF**, and **OFF** buttons and vertical **POSITION**, **SCALE** knobs. Following the exercise of the buttons, knobs, and the status bar to be familiar with the vertical parameters settings.

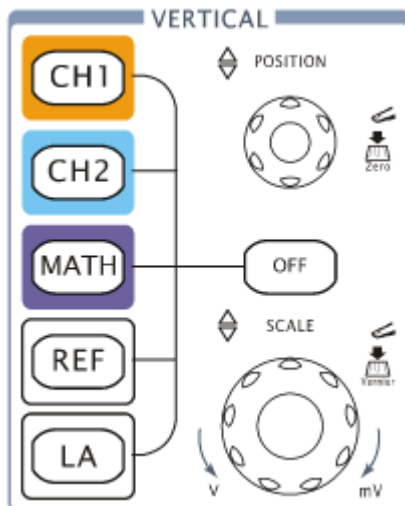

Figure 1- 14  
The vertical window

### 1. Center the signal on the display with the **POSITION** knob.

The **POSITION** knob moves the signal vertically, and it is calibrated. Note that turning the **POSITION** knob, a voltage value is displayed for a short time indicating its value with respect to the ground reference located at the center of the screen. Also notice that the ground symbol on the left side of the display moves in conjunction with the **POSITION** knob.



#### Measurement hints

If the channel is DC coupled, measuring the DC component of the signal by simply noting its distance from the ground symbol.



If the channel is AC coupled, the DC component of the signal is blocked, allow you to use greater sensitivity to display the AC component of the signal.



**Vertical offset back to 0 shortcut key**

Turn the  POSITION knob to change the vertical display position of channel and press the  POSITION knob to set the vertical display position back to 0 as a shortcut key, this is especially helpful when the trace position is far out of the screen and want it to get back to the screen center immediately.

**2. Change the vertical setup and notice that each change affects the status bar differently.**

- View the status bar which is on the bottom of the screen to understand the vertical scale.
- Change the vertical scale by turning the  SCALE knob and notice the change in the status bar.
- Press  button to turn off the channel.

**Coarse/Fine Shortcut key**

The Coarse/Fine vertical control can be set by simply pressing the vertical  SCALE knob.

## To Understand the Horizontal System

Figure 1- 15 shows the HORIZONTAL controls: **MENU** button, **POSITION** and **SCALE** knobs of horizontal system. Following the exercise to familiarize with the buttons, knobs, and status bar.

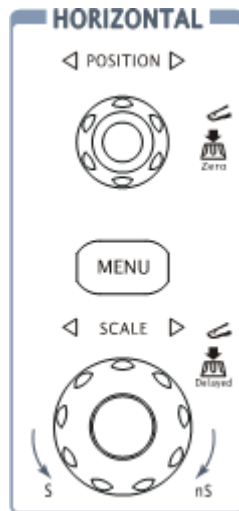

Figure 1- 15  
The horizontal system

### 1. Turn the **SCALE** knob and notice the change in the status bar.

The horizontal **SCALE** knob changes the sweep speed in a 1-2-5 step sequence, and displays the value in the status bar. The time base ranges of the oscilloscope is from 2ns/div\* to 50s/div.

\* **NOTE:** The speed of horizontal scan varies by different models.

#### Delayed Scan Shortcut key

To press the **SCALE** knob in the horizontal control area on the front-panel is another way to enter or exit Delayed Scan mode and it is equal to the following menu operations, **MENU** → Delayed → ON.

## 2. The horizontal POSITION knob moves displayed signal horizontally on waveform window

### Horizontal offset back to 0 shortcut key

Press the  POSITION knob to set the horizontal offset to 0 as a shortcut key, this is especially helpful when the trigger point is far out of the screen and want it to get back to the screen center immediately.

## 3. Press the **MENU** key to display the TIME menu.

To enter or exit the Delayed Scan mode, set the display to Y-T, X-Y or ROLL mode, and turn the horizontal  POSITION knob to adjust trigger offset.

### Horizontal position control

Trig-Offset: In this setting, the trigger position will be changed horizontally when you turn the  POSITION knob.

## To Trigger the Oscilloscope

Figure 1- 16 shows the trigger control: MENU, 50%, FORCE and a  LEVEL trigger level knob. Following the exercise to familiarize with the buttons, trigger level knob and status bar.

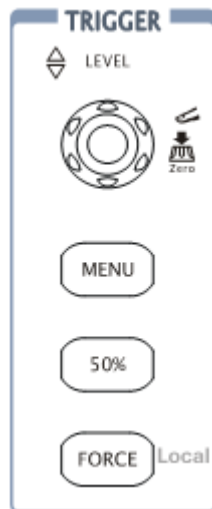



Figure 1- 16



The trigger control window

### 1. Turn the trigger Level knob and notice the changes on the display.

As you turn the  LEVEL knob or pressing the **50%** button, two things will happen on the display for a short time.

- First, the trigger level value is displayed at the bottom-left of the screen. If the trigger is DC coupled, it is displayed as a voltage value. If the trigger is AC coupled or LF reject, it is displayed as a percentage of the trigger range.
- Second, a line is displayed showing the location of the trigger level (as long as AC coupling or low frequency reject are not selected).

#### Trigger Level to 0 Shortcut key

Turn the  LEVEL knob to change trigger level value and press the  LEVEL knob to set trigger level back to 0 as a shortcut key.

## 2. Change the trigger setup and notice these changes in the status bar.

Press **MENU** button in the Trigger control.

A soft button menu appears on the display showing the trigger setting choices as shown in

Figure 1- 17 .

Figure 1- 17

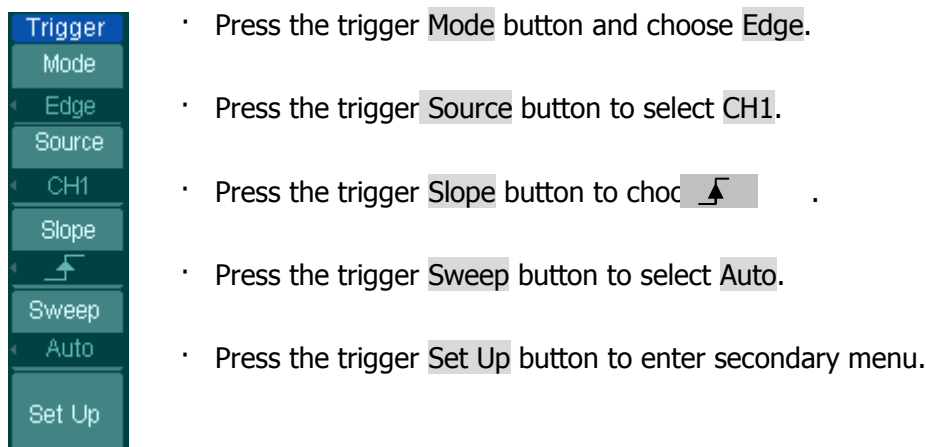

**NOTE:** The trigger type, slope and source change in conjunction with the status bar on the top-right of the screen.

### 3. Press **50%**

The **50%** button sets the trigger level to the center of the signal.

### 4. Press **FORCE**

Starting an acquisition regardless of an adequate trigger signal, usually used in "Normal" or "Single" trigger mode. This button has no effect if the acquisition is already stopped.

#### **Key point:**

**Holdoff:** A time interval before the oscilloscope response to next trigger signal. During this holdoff period, the trigger system becomes "blind" to trigger signals. This function helps to view complex signals such as an AM waveform. Press **Holdoff** button to activate  knob, then turn it to adjust Holdoff time.



## Chapter 2 : Operating Your Oscilloscope

By now, a user should understand the VERTICAL, HORIZONTAL and TRIGGER control systems and knows how to determine the system setup by status bar of a DS1000E, DS1000D series digital oscilloscope.

This chapter will go through all groups of front-panel buttons, knobs and menus; and further the knowledge of the operation by hints in this guide.

It is recommended to perform all of the following exercises to get the most of the powerful measurement capabilities of the oscilloscope.

This chapter covers the following topics:

- To set up the vertical system ( **CH1**, **CH2**, **MATH**, **REF**, **LA**, **OFF**,  
Vertical **POSITION**, Vertical **SCALE** )
- To set up the horizontal system ( **MENU**, Horizontal **POSITION**,  
Horizontal **SCALE** )
- To set up the trigger system ( **LEVEL**, **MENU**, **50%**, **FORCE** )
- To set up the sampling system ( **Acquire** )
- To set up the display system ( **Display** )
- To save and recall waveforms, CSV format, bmp format and other setups ( **Storage** )
- To set up utility ( **Utility** )
- To measure automatically ( **Measure** )
- To measure with cursors ( **Cursor** )
- To use run control buttons ( **AUTO**, **RUN/STOP** )

# To Set up the Vertical System

## Settings of the Channels

Each channel has an operation menu and it will pop up after pressing **CH1** or **CH2** button. The settings of all items in the menu are shown in the table below.

Figure 2- 1 Table 2- 1 The Channel menu (Page 1/2)





Menu	Settings	Comments
Coupling	AC	Blocks the DC component of the input Signal
	DC	Passes both AC and DC components of the input signal
	GND	Disconnects the input signal
BW Limit	ON	Limits the channel bandwidth to 20MHz to reduce display noise.
	OFF	Get full bandwidth.
Probe	1X	Set this to match your probe attenuation factor to make the vertical scale readout correct
	5X	
	10X	
	50X	
	100X	
	500X	
1000X		
Digital filter		Setup digital filter (See table 2-4)
	1/2	Go to the next menu page (The followings are the same, no more explanation)



Figure 2- 2



Table 2- 2 The Channel menu (Page 2/2)

Menu	Settings	Comments
	2/2	Back to the previous menu page (The followings are the same, no more explanation)
Volts/Div	Coarse Fine	Selects the resolution of the  SCALE knob Defines a 1-2-5 sequence. To change the resolution to small steps between the coarse settings.
Invert	ON OFF	Turn on the invert function. Restore original display of the waveform.

### 1. Channel coupling

To use Channel 1 as an example, input a sine wave signal with DC shift.

Press **CH1** → **Coupling** → **AC** to set "AC" coupling. It will pass AC component blocks the DC component of the input signal.

The waveform is displayed as Figure 2- 3:

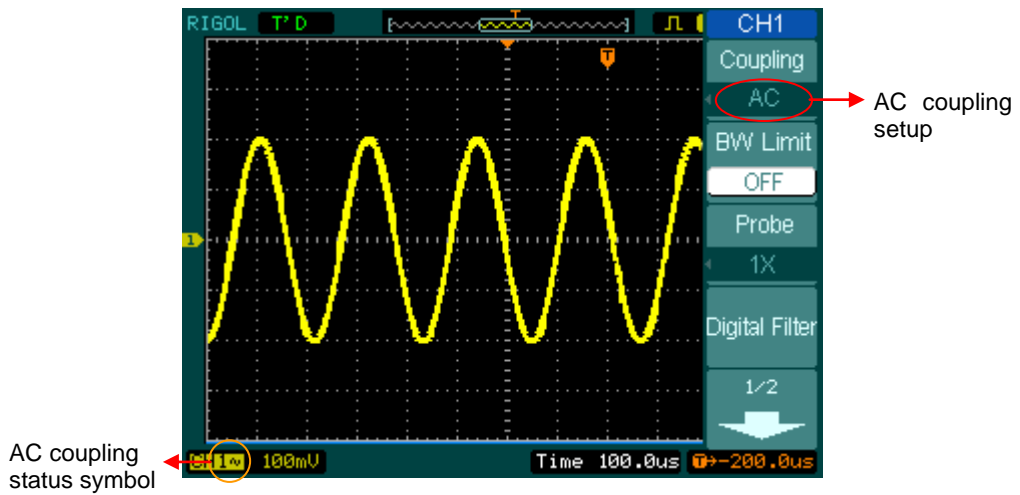

Figure 2- 3  
AC coupling setting

Press **CH1** → **Coupling** → **DC**, to set "DC" coupling. It will pass both AC and DC components of the input signal.

The waveform is displayed as Figure 2- 4:

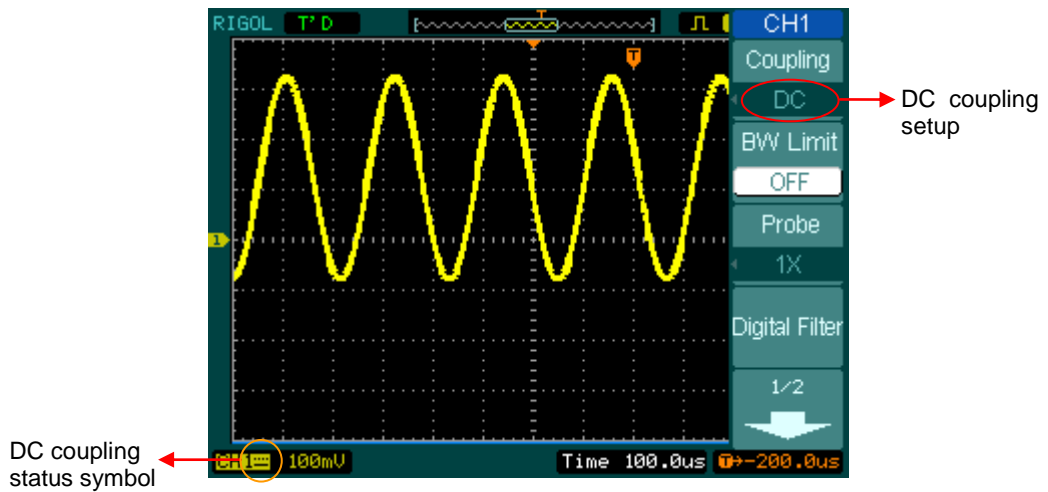

Figure 2- 4  
DC coupling setting

Press **CH1** → **Coupling** → **GND**, to set "GND" coupling, it disconnects the input signal.

The screen displays as Figure 2-5:

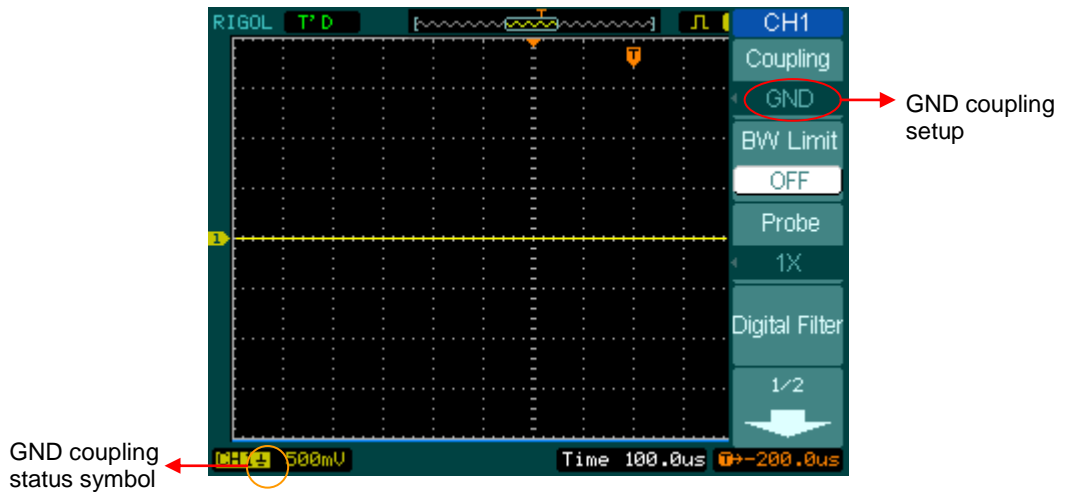

Figure 2- 5  
GND coupling setting

## 2. Set up the channel bandwidth limit

To use Channel 1 as an example, input a signal containing high frequency component.

Press **CH1** → **BW Limit** → **OFF**, to set up bandwidth limit to "OFF" status. The oscilloscope is set to full bandwidth and passing the high frequency component in the signal.

The waveform is displayed as Figure 2- 6:

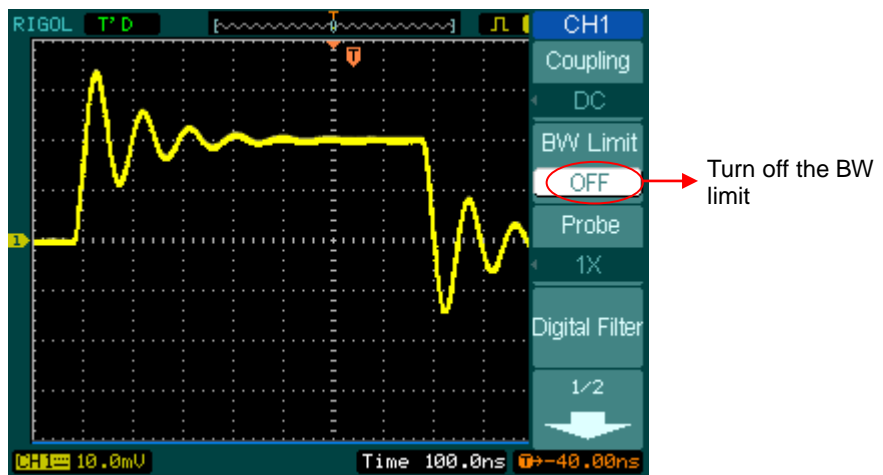

Figure 2- 6  
Turn off the BW limit

Press **CH1** → **BW Limit** → **ON**, to set up bandwidth limit to "ON" status. It will reject the frequency component higher than 20MHz.

The waveform is displayed as Figure 2- 7:

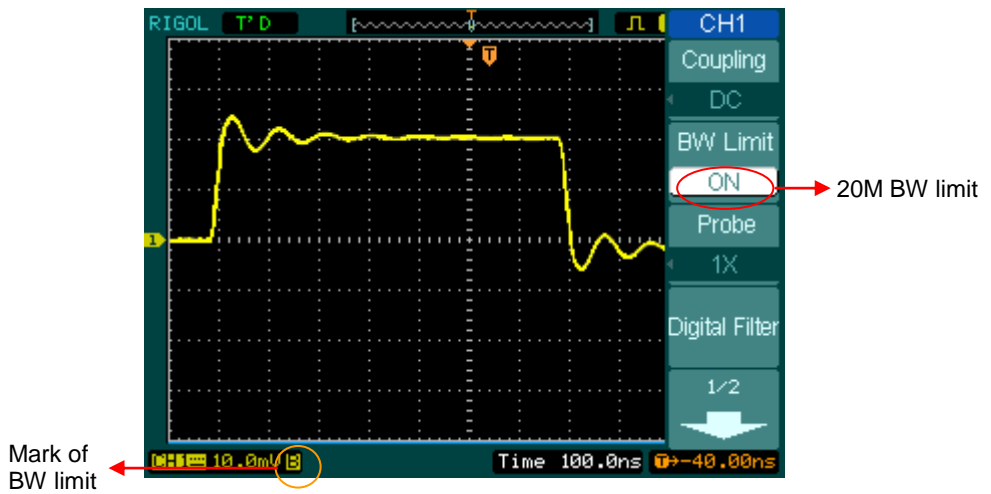

Figure 2- 7  
Turn on the BW limit

### 3. Probe Attenuation Setting

The oscilloscope allows selecting the attenuation factor for the probe. The attenuation factor changes the vertical scaling of the oscilloscope so that the measurement results reflect the actual voltage levels at the probe tip.

To change (or check) the probe attenuation setting, press the **CH1** or **CH2** button (according to which channel is using). Toggle the **Probe** soft button to match the attenuation factor of the probe.

This setting remains in effect until changed again.

Figure 2-8 shows an example for using a 1000:1 probe and its attenuation factor.

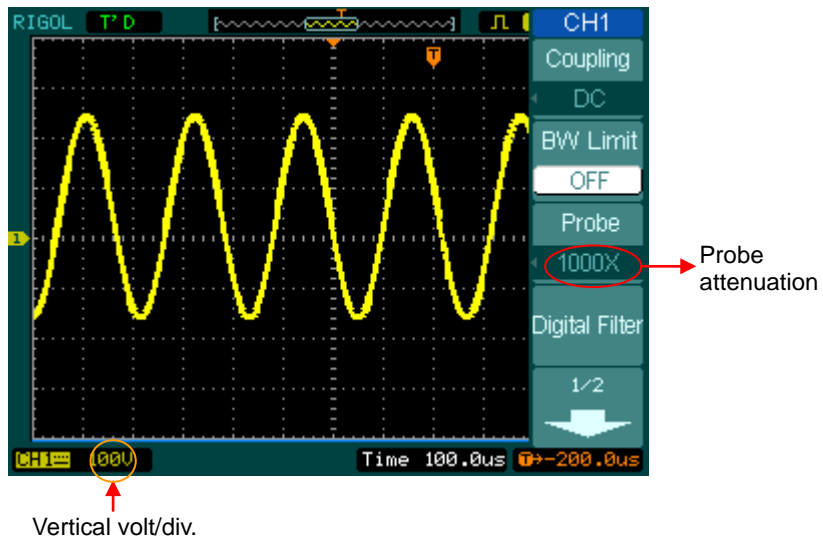

Figure 2- 8  
Use the 1000:1 attenuation

Table 2- 3 Probe setting

Probe attenuation factors	Corresponding settings
1:1	1X
5:1	5X
10:1	10X
50:1	50X
100:1	100X
500:1	500X
1000:1	1000X

#### 4. Volts/Div settings

The **Volts/Div** control has **Coarse** or **Fine** configuration. The Vertical Sensitivity is 2mV/div - 10V/div.

**Coarse:** It is the default setting of Volts/Div in a 1-2-5-step sequence from 2mV/div、5mV/div、10mV/div、20mV/div.....10V/div.

**Fine:** This setting changes the vertical scale to small steps between the coarse settings. It will be helpful to adjust the waveform in smooth steps.

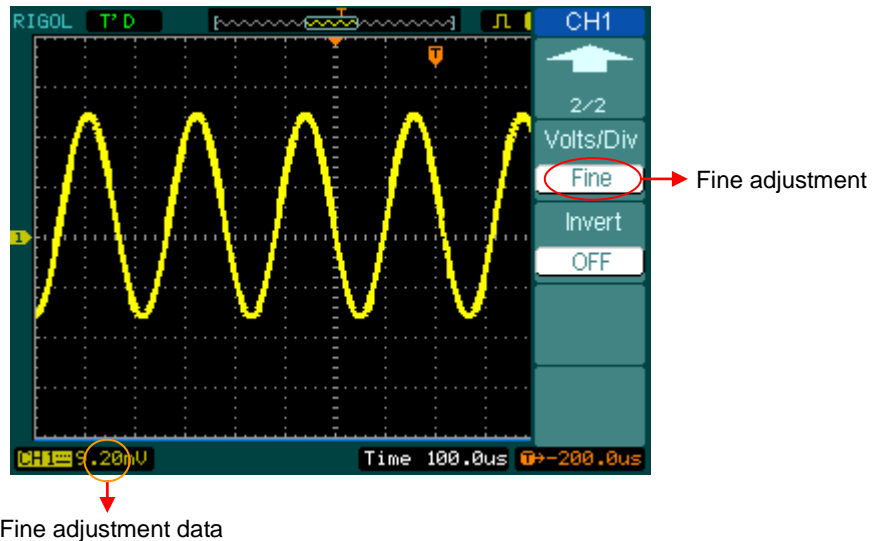



Figure 2- 9  
Fine configurations

#### Coarse/Fine Shortcut key:

To change Coarse/Fine setting, not only by menu but also by pressing vertical  **SCALE** knob

### 5. To invert a waveform

Invert turns the displayed waveform 180 degrees, as respect to the ground level. When the oscilloscope is triggered on the inverted signal, the trigger is also inverted.

Figure 2- 10 and Figure 2- 11 show the changes after inversion.

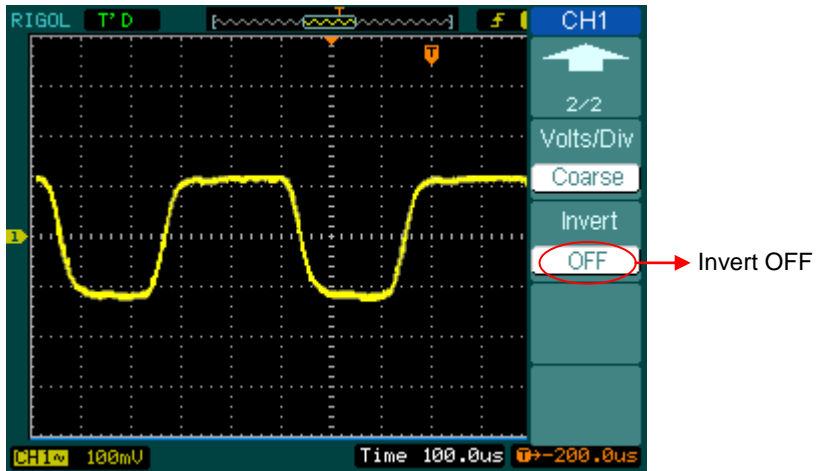

Figure 2- 10  
The waveform before inversion

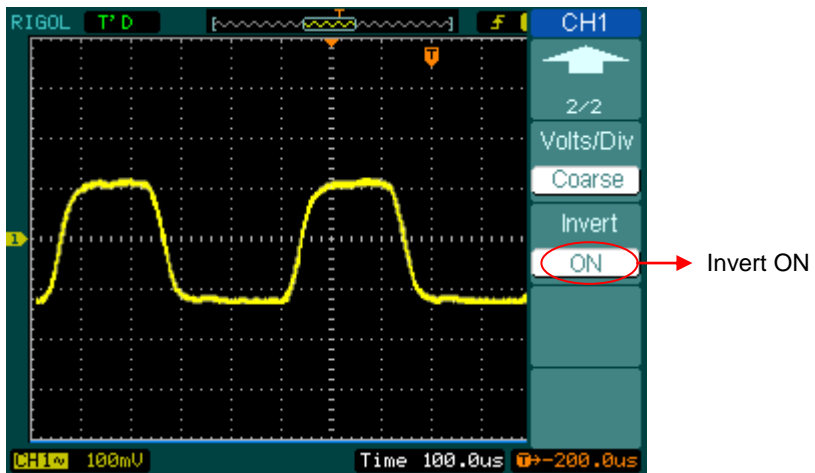

Figure 2- 11  
The waveform after inversion



## Digital Filter:

Press **CH1** → Digital filter, display the digital filter menu. Turn (↻) knob to set high and low limit of frequency.

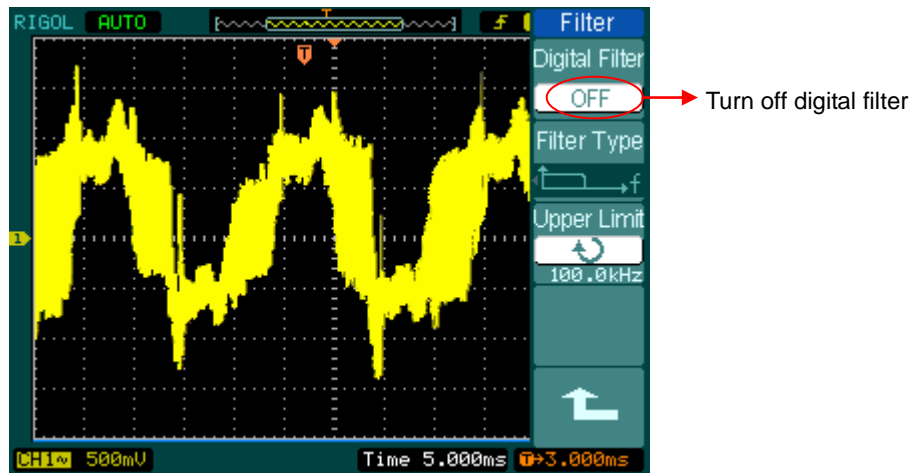

Figure 2- 12

The waveform when turning off digital filter

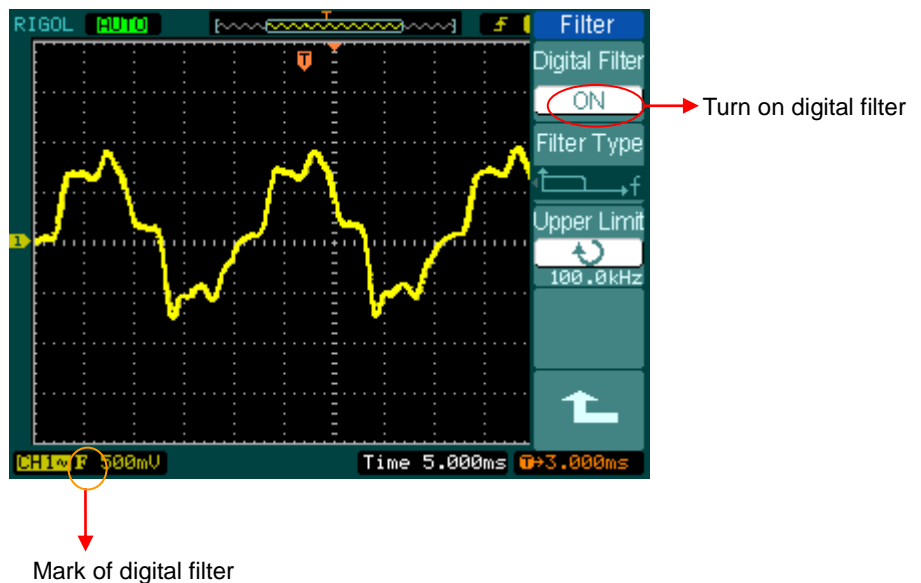
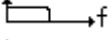
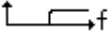
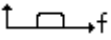
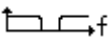







Figure 2- 13

The waveform when turning on digital filter

Figure 2- 14 Table 2- 4 The Filter menu



Menu	Settings	Comments
Digital Filter	ON OFF	Turn on the digital filter Turn off the digital filter
Filter Type	 f  f  f  f	Setup as LPF (Low Pass Filter) Setup as HPF (High Pass Filter) Setup as BPF (Band Pass Filter) Setup as BRF (Band Reject Filter)
Upper limit	 <frequency>	Turn (  ) knob to set high limit
Lower limit	 <frequency>	Turn (  ) knob to set low limit
		Back to higher level menu (The followings are the same, no more explanation)

## Math Functions

The mathematic functions include “add”, “subtract”, “multiply” and “FFT” for Channel 1 and Channel 2. The mathematic result can be measured by grid and cursor.

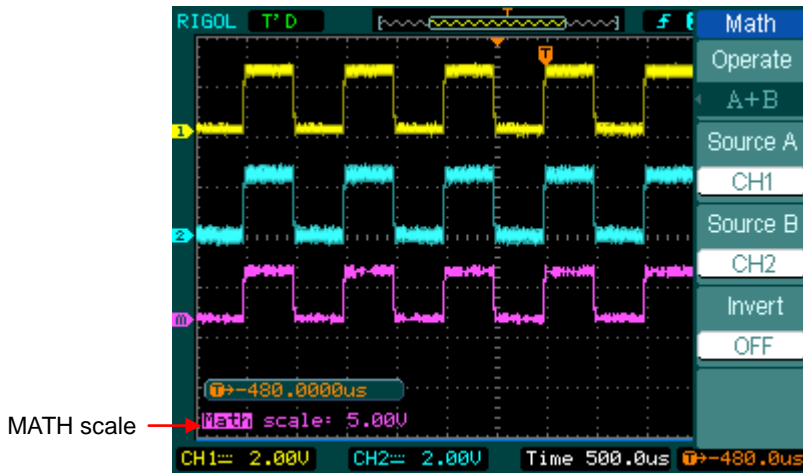

Figure 2- 15  
The Math function

Figure 2- 16 Table 2- 5 The Math menu



Menu	Settings	Comments
Operation	A+B	Add source A and source B
	A-B	Subtract source B from source A
	A×B	Multiply source B by source A
	FFT	Fast Fourier Transform
Source A	CH1	Define CH1 or CH2 as source A
	CH2	
Source B	CH1	Define CH1 or CH2 as source B
	CH2	
Invert	ON	Invert the MATH waveform. Restore to original waveform display.
	OFF	

## Using the FFT

The FFT (Fast Fourier Transform) process converts a time-domain signal into its frequency components mathematically. FFT waveforms are useful in the following applications:

- Measuring harmonic content and distortion in systems
- Characterizing noise in DC power supplies
- Analyzing vibration

Figure 2- 17



Table 2- 6 The FFT menu

Menu	Settings	Comments
Operate	A+B	Add source A to source B
	A-B	Subtract source B from source A
	A x B	Multiply source B by source A
	FFT	Fast Fourier Transform
Source	CH1 CH2	Define CH1 or CH2 as FFT source
Window	Rectangle Hanning Hamming Blackman	Select window for FFT
Display	Split	Display FFT waveform on half screen
	Full screen	Display FFT waveform on full screen
Scale	Vrms	Set "Vrms " as vertical unit
	dBVrms	Set "dBVrms " as vertical unit

### Key points for FFT

1. Signals that have a DC component or offset can cause incorrect FFT waveform component magnitude values. To minimize the DC component, choose AC Coupling on the source signal.
2. To reduce random noise and aliases components in repetitive or single-shot events, set the oscilloscope acquisition mode to average.
3. To display FFT waveforms with a large dynamic range, use the dBVrms scale. The dBVrms scale displays component magnitudes using a log scale.

## Selecting an FFT Window

The oscilloscopes provide four FFT windows. Each window is a trade-off between frequency resolution and amplitude accuracy. What you want to measure and your source signals characteristics help determine which window to use. Use the following guidelines to select the best window.

Table 2- 7 FFT Windows

Window	Features	Best for measuring
Rectangle	Best frequency Resolution and worst magnitude resolution. This is essentially the same as no window.	Transients or bursts, the signal levels before and after the event are nearly equal. Equal-amplitude sine waves with fixed frequencies. Broadband random noise with a relatively slow varying spectrum.
Hanning Hamming	Better frequency, poorer magnitude accuracy than Rectangular. Hamming has slightly better frequency resolution than Hanning.	Sine, periodic, and narrow-band random noise. Transients or bursts where the signal levels before and after the events are significantly different.
Blackman	Best magnitude, worst frequency resolution.	Single frequency waveforms, to Find higher order harmonics.

### Key points:

**FFT Resolution:** the quotient between sampling rate and number of FFT points. With a fixed FFT points, the lower sampling rate results in better resolution.

### Nyquist Frequency

The highest frequency that any real-time digitizing oscilloscope can acquire without aliasing. It's normally half of the sample rate. This frequency is called the Nyquist frequency. Frequency above the Nyquist frequency will be under sampled, causing a situation known as aliasing.

## Using REF

Reference Waveforms are saved waveforms to be selected for display. The reference function will be available after saving the selected waveform to non-volatile memory.

Press **REF** button to display reference waveform menu.

Figure 2- 18 Table 2- 8 REF menu when using internal memory

REF	Source	CH1	Location	Internal	Save	Imp./Exp.	Reset
Menu	Settings	Comments					
Source	CH1	Select channel1 as REF channel					
	CH2	Select channel2 as REF channel					
	MATH/FFT	Select Math/FFT as REF channel					
	LA	Select LA as REF channel (DS1000D series)					
Location	Internal	Select memory location in scope					
	External	Select memory location out scope					
Save		Save REF waveform					
Imp./Exp.		Go to import/export menu(see table 2-10)					
Reset		Reset REF waveform					

Figure 2- 19 Table 2- 9 REF menu when using external memory

REF	Source	CH1	Location	External	Save	Import	Reset
Menu	Settings	Comments					
Source	CH1	Select channel1 as REF channel					
	CH2	Select channel2 as REF channel					
	MATH/FFT	Select Math/FFT as REF channel					
	LA	Select LA as REF channel (DS1000D series)					
Location	Internal	Select memory location in scope					
	External	Select memory location out scope					
Save		Save REF waveform to outer memory location					
Import		Go to import menu(see table 2-14)					
Reset		Reset REF waveform					

## Import and Export

Press **REF** → **Imp./Exp.** and go to the following menu.

Figure 2- 20 Table 2- 10 The Imp./Exp. menu

Menu	Settings	Comments
Explorer	Path Directory File	Switch to Path, directory or file
Export		Export the REF file from internal memory to export memory (see table 2-11)
Import		Import the REF file to internal memory
Delete File		Delete file

The figure of import and export as following



Figure 2- 21  
Import of export the figure

## Export

Press **REF** → **Imp./Exp.** → **Export** and go to the following menu.

Figure 2- 22



Table 2- 11 The Export menu

Menu	Settings	Comments
↑		Move the cursor up
↓		Move the cursor down
X		To delete chosen letter
Save		Execute the operation

The figure of export as following.



Figure 2- 23  
Figure export



## Save to External Memory

Press **REF** → **Save** and go to the following menu.

Figure 2- 24 Table 2- 12 The Save menu

Menu	Settings	Comments
Explorer	Path Directory File	Switch among Path, Directory and File
New File (Folder)		Set up new file in Path and File. Set up new folder in directory.
Delete File(Folder)		Delete file(Folder)



The figure of Save as following:

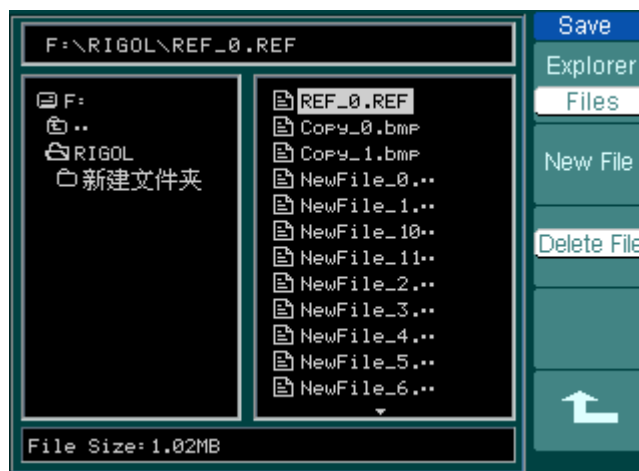

Figure 2- 25  
Save the figure

## New File (or New Folder)

Press **REF** → **Save** → **New File** (or **New Folder**) and go to the following menu.

Figure 2- 26 Table 2- 13 The New File menu



Menu	Settings	Comments
↑		Move the cursor up
↓		Move the cursor down
X		To delete chosen letter
Save		Execute the operation

The figure of key in as following

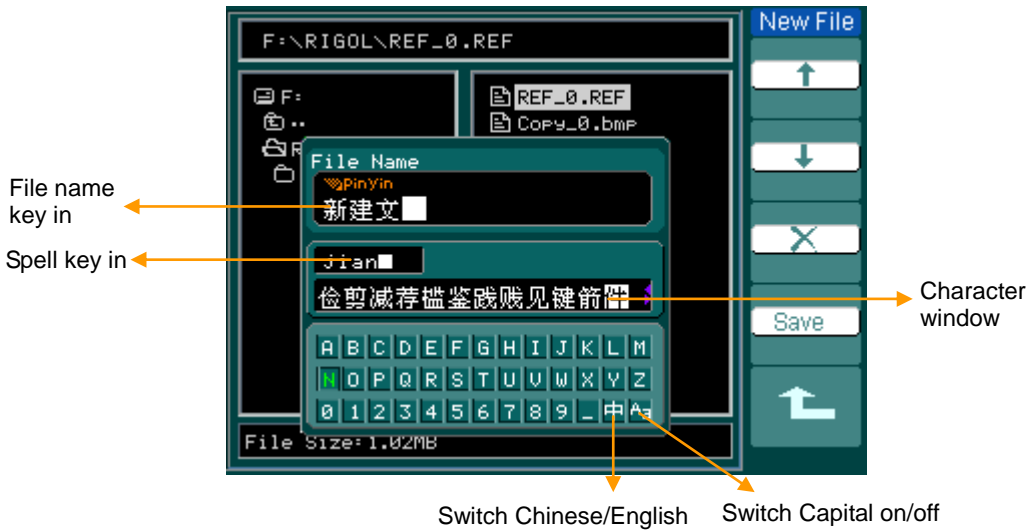

Figure 2- 27  
Chinese Input

## Import

Press **REF** → **Import** and go to the following menu.

Figure 2- 28 Table 2- 14 The Import menu



Menu	Settings	Comments
Explorer	Path Directory File	Switch among Path, Directory and File
Import		Import the REF file into internal memory

The figure of import as following.



Figure 2- 29  
Figure import

## Displaying a Reference Waveform

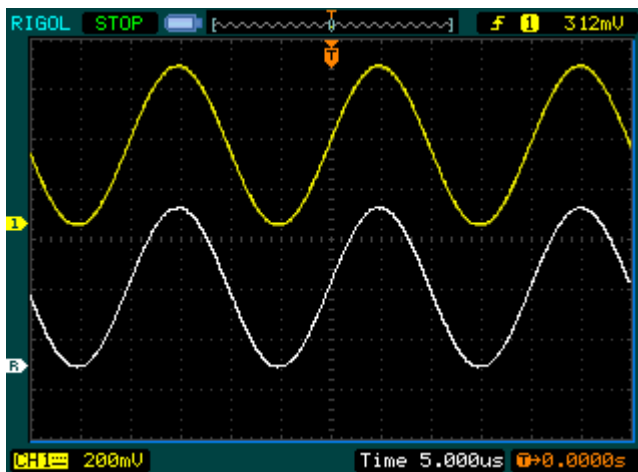

Figure 2- 30  
Reference waveform display

1. Push **REF** button to show the reference waveform menu.
2. Press soft button No.1 to select the reference channel: **CH1**, **CH2**, **MATH**, **FFT** or **LA** (DS1000D series).
3. Turn vertical **POSITION** and vertical **SCALE** to adjust the REF waveform to a suitable position.
4. Press soft button No.2 to select the save location of REF waveform.
5. Press soft button No.3 to save the waveform as REF.

**NOTE:** The reference function is not available in X-Y mode.

## Set up LA Channel (DS1000D Series)

Single channel or group channels can be chosen ON or OFF, and also can set the size of waveform. Change display location of digital channel on screen and select threshold style.

Press **LA** function button and go to the following menu.

Figure 2- 31 Table 2- 15 The LA menu

LA	Menu	Settings	Comments
D7-D0	D7-D0		Set up channel group D7-D0 (see table 2-16)
D15-D8	D15-D8		set up channel group D15-D8 (see 2-17)
Current ↻ D15	Current	↻ <D15-D0>	Select channel by turning (↻) knob
Threshold User	Threshold	TTL CMOS ECL User	Select mode of whole digital channels. The threshold voltage can set by user when in user-defined style.
User ↻ -10.0mV	User	↻ <Threshold Voltage>	Set threshold voltage by turning (↻) knob.

### 1. Display and re-line up the digital channels

- (1) Press **LA** → **D7-D0** or **D15-D8** and go to the group channel setting menu. Turn on or turn off the display of the digital channels.
- (2) Press **LA** → **current** and choose digital channel by turning (↻) knob. The chosen channel will display in red color.
- (3) Turn vertical **POSITION** knob to re-position the channel in screen.

The figure of menu shows as follow.

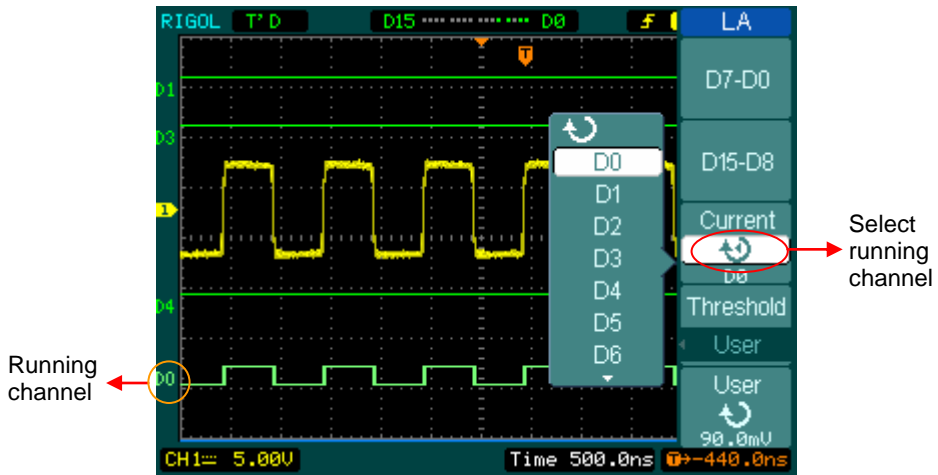

Figure 2- 32  
Turn on the digital channel

## 2. Set threshold mode of digital channels

Press **LA** → **Threshold**, select logic standard or **User** to define your own threshold voltage.

The figure of menu shows as follow.

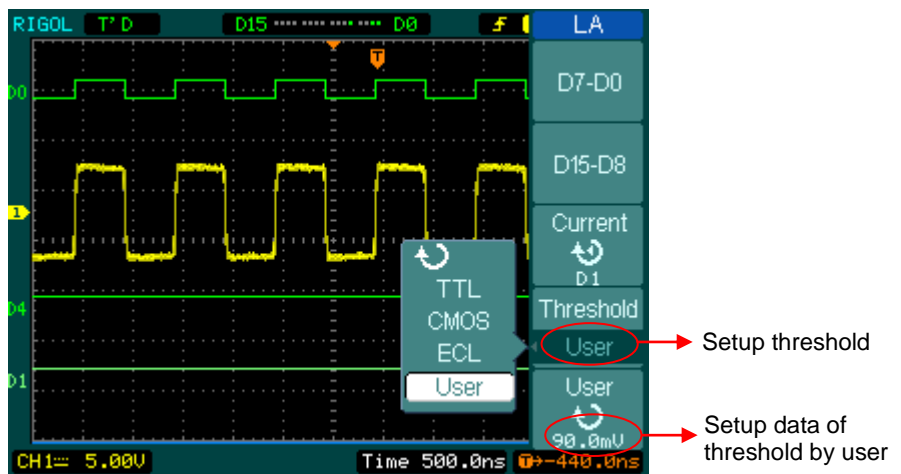

Figure 2- 33  
Set the threshold



**Threshold explanation**

LOGIC STANDARD	THRESHOULD VLOTAGE
TTL	1.4V
CMOS	2.5V
ECL	-1.3V
User	-8V to +8V

## Set up Channel Group

Press **LA** → **D7-D0** or **D15-D8**; turn on/off the channel single, or in a group. Also you can change the size of waveforms in 8 bits as a group. See table 2-16 and 2-17

Figure 2- 34 Table 2- 16 The Digital Channel menu (Page 1)

Menu	Settings	Comments
channel	D7-D0	Turn on or off single channel of D7-D0
D7-D0	Turn on Turn off	Turn on or off all 8 channels together
Size	 	Display 8 channels in a single screen Display 16 channels in a single screen
Reset		Reset waveform of channel D7-D0







Figure 2- 35 Table 2- 17 The Digital Channel menu (Page 2)

Menu	Settings	Comments
channel	D15-D8	Turn on or off single channel of D15-D8
D15-D8	Turn on Turn off	Turn on or off 8 channels together
Size	 	Display 8 channels in a single screen Display 16 channels in a single screen
Reset		Reset waveform of channel D15-D8





### 1. Turn on or off a single logic channel

Press **[LA]**→**D7-D0**→**Channel**, and choose the wanted channel by turning (↻) knob. Press No. 1 soft button or push down (↻) knob to turn on /off the channel. When the channel is on, we can see the mark (■). When the channel is turned off; the mark will display as (□).

As figure 2-36 shows.

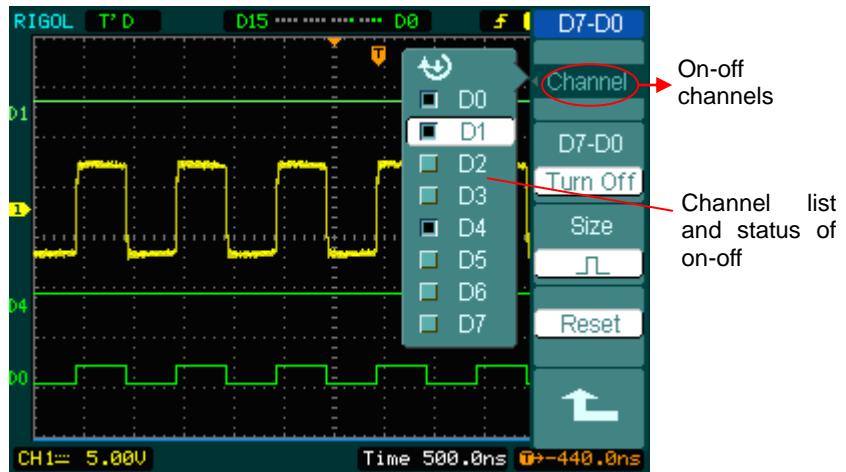



Figure 2- 36

Turn on or off the digital channel

### 2. Force turn on or off all logic channels

Press **[LA]**→**D7-D0**→**Turn On / Turn Off** (or **D15-D8** →**Turn On / Turn Off**) will force to turn all the channels on/off. If you want to turn on/off any single channel instead, select the **Channel** by turning (↻) knob, then press No. 1 soft button or (↻) knob.

### 3. Set up the viewing size of logic channels:

Press **[LA]**→**D7-D0**→**Size**, or **D15-D8**→**Size**, to select wave size of logic channels. Select  to view 8 channels on the screen; Select  to view all of the 16 channels on the screen.

### 4. Reset the logic channels display:

Press **[LA]**→**D7-D0**→**Reset**, or **D15-D8**→**Reset** to reset the display of logic channels.

## Turn on/off Channels

The CH1, CH2, Ext. Trigger and LA (DS1000D series) channels are input channels. All functionalities applied will be based on operating the instrument with channels. So MATH and REF can be regarded as relatively isolated channels.

To turn on/off any one of the channels, press the corresponding button on the front panel. The key backlight indicates the channel is currently active. Press the button again to turn the channel off. Or when channel is currently selected, press **OFF** will turn the channel off as well, and the key backlight also goes off.

Table 2- 18 Status of the channels

Channel Mode	Settings	Status Indicator
Channel 1 (CH1)	ON	CH1 (black letter)
	Selected	CH1 (yellow letter)
	OFF	No indicator
Channel 2 (CH2)	ON	CH2 (black letter)
	Selected	CH2 (blue letter)
	OFF	No indicator
MATH	ON	Math (black letter)
	Selected	Math (purple letter)
	OFF	No indicator

### NOTE:

The channel status symbol is displayed at the lower-left of the screen. Pressing **LA** will turn all the digital channels on/off.

## Set up Vertical Position and Scale

You can use the vertical controls to display waveforms, adjust vertical **SCALE** and **POSITION**, and set input parameters.

1. Using vertical **POSITION** knob.

The vertical **POSITION** control changes the position of signal waveforms in all channels (including MATH and REF). The resolution changes according to the vertical level set. Pressing this knob will clear the channel offset to zero. (The function is available for DS1000D series, but not includes digital channel.)

2. Using vertical **SCALE** knob.

The vertical **SCALE** can change the vertical sensitivity of waveforms in all channels (including MATH and REF, excluding LA). If the Volts/Div is set to "Coarse", the waveform scales in a 1-2-5 step sequence from 2 mV to 5 V. If the Volts/Div is set to "Fine", it scales to small steps between the coarse settings.

3. Channels can be adjusted by the vertical **POSITION** and **SCALE** only when they are selected.
4. During the vertical position, a position message is displayed on the left bottom of the screen, in the same color as the corresponding channel. The unit is V (Volts).

## To Set up the Horizontal System

The oscilloscope shows the time per division in the scale readout. Since all active waveforms use the same time base, the oscilloscope only displays one value for all the active channels, except when using Delayed Scan, or Alternative Trigger.

The horizontal controls can change the horizontal scale and position of waveforms. The horizontal center of the screen is the time reference for waveforms. Changing the horizontal scale causes the waveform to expand or contract about the screen center.

Horizontal position changes the displayed waveform position, relative to the trigger point.

### The Horizontal Knobs

**POSITION**: The horizontal **POSITION** knob adjusts the horizontal position of all channel (include Math) waveforms. The resolution of this control varies with the time base. Pressing this button clears trigger offset and moves the trigger point to the horizontal center of the screen.

**SCALE**: Use **SCALE** to select the horizontal time/div (scale factor) for the main or the Delayed Scan time base. When Delayed Scan is enabled, it changes the width of the window zone by changing the Delayed Scan time base.

### Horizontal Menu.

Press the horizontal **MENU** button to display the horizontal menu. The settings of this menu are listed in the following table.

Figure 2- 37 Table 2- 19 The Horizontal menu



Menu	Settings	Comments
Delayed	ON	Turn on Delayed Scan mode
	OFF	Turn off the Delayed Scan mode
Time Base	Y-T	Show the relative relation between vertical voltage and horizontal time.
	X-Y	Show CH1 value at X axis; CH2 value at Y axis.
	Roll	In Roll Mode, the waveform display updates from right to left.
Sa Rate		Show system sample rate
Trig-offset Reset		Adjust to the center

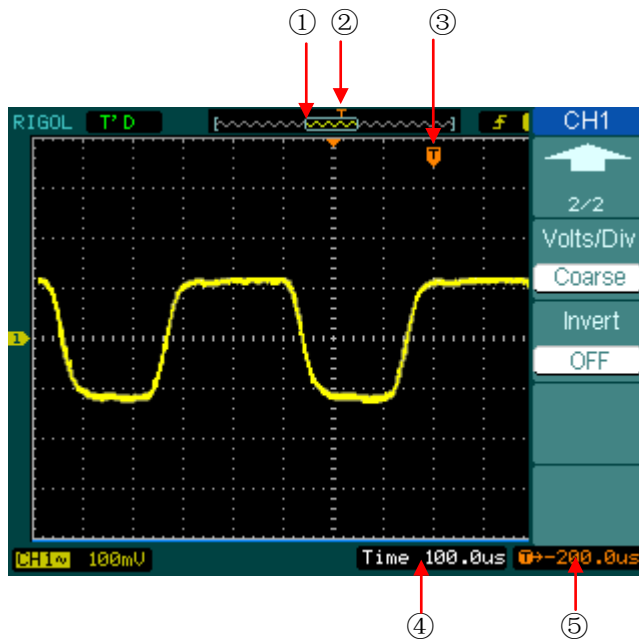

Figure 2- 38  
Status bar and mark for Horizontal control

## Marks Indicator

- ① The current waveform window's position in the memory.
- ② The trigger position in the memory.
- ③ The trigger position in the current waveform windows.
- ④ The horizontal time base (main time base).
- ⑤ The trigger's horizontal offset according to the center of the window.

### Key Points

**Y-T:** The conventional oscilloscope display format. It shows the voltage of a waveform record (on the vertical axis) as it varies over time (on the horizontal axis).

**X-Y:** XY format displays channel 1 in the horizontal axis and channel 2 in the vertical axis.

**Roll Mode:** In this mode, the waveform display rolls from right to left. No trigger or horizontal offset control of waveforms is available during Roll Mode, and it's only available when set to 500 ms/div or slower.

**Slow Scan Mode:** This mode is available when the horizontal time base is set to 50ms/div or slower. In this mode, the oscilloscope acquires sufficient data for the left part to the trigger point, then wait for trigger, when trigger occurs, it continues to draw the rest part from the trigger point to the end of the right side. When choosing this mode to view low frequency signals, it is recommended that the channel coupling be set as DC.

**Time/Div:** Horizontal scale. If the waveform acquisition is stopped (using the **RUN/STOP** button), the Time/Div control expands or compresses the waveform.

## Delayed Scan:

The Delayed Scan is a magnified portion of the main waveform window. Use Delayed Scan to locate and horizontally expand part of the main waveform window for a more detailed (higher horizontal resolution) analysis of signal. The Delayed Scan time base setting cannot be set slower than the Main time base setting.

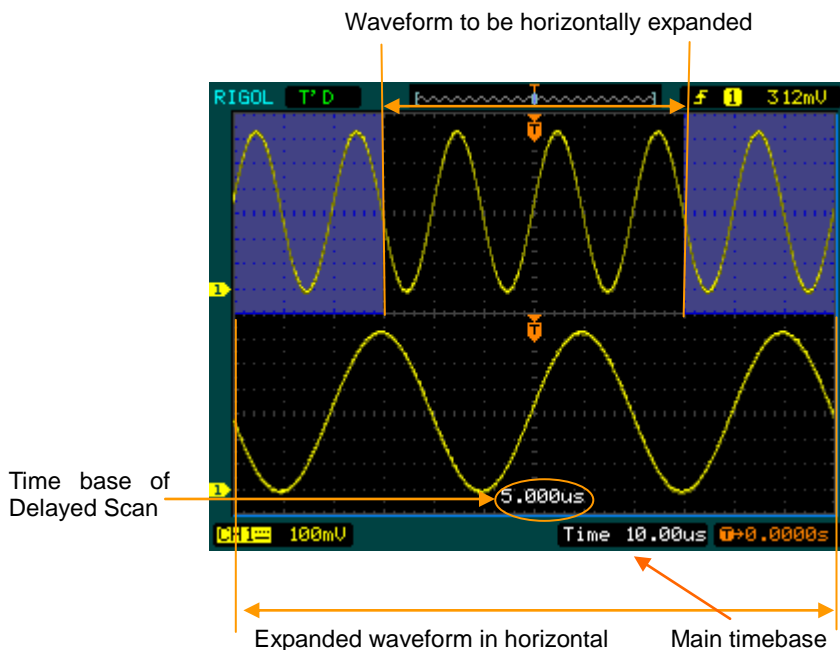



Figure 2- 39  
Delayed Scan window

The following steps show you how to use Delayed Scan.

1. Connect a signal to the oscilloscope and obtain a stable display.
2. Press horizontal **MENU** → **Delayed** → **ON** or press horizontal **SCALE** knob to enter Delayed Scan mode.

The screen splits into two parts. The upper half displays the main waveform window and the lower half displays an expanded portion of the main waveform window. This expanded portion of the main window is called the Delayed Scan window. Two blocks shaded at the upper half; the un-shaded portion is expanded in the lower half. The horizontal **POSITION** and **SCALE** knobs control the size and position of the Delayed Scan. The value at bottom of the screen is the main time base and the

value on the center bottom means the Delayed Scan time.

- Use the horizontal  POSITION knob to change the position of the expanded portion.
- Use the horizontal  SCALE knob to adjust the Delayed Scan resolution.
- To change the main time base, turn off the Delayed Scan mode.
- Since both the main and Delayed Scan are displayed; there are half as many vertical divisions so the vertical scaling is doubled. Notice the changes in the status bar.

**Delayed Scan Shortcut Key:**

Delayed Scan function can be activated not only by menu but also by pressing horizontal  SCALE knob.



## X-Y Format

This format is useful for studying phase relationships between two signals.

Channel 1 in the horizontal axis(X) and channel 2 in the vertical axis(Y), the oscilloscope uses a none-trigger acquisition mode, data is displayed as dots.

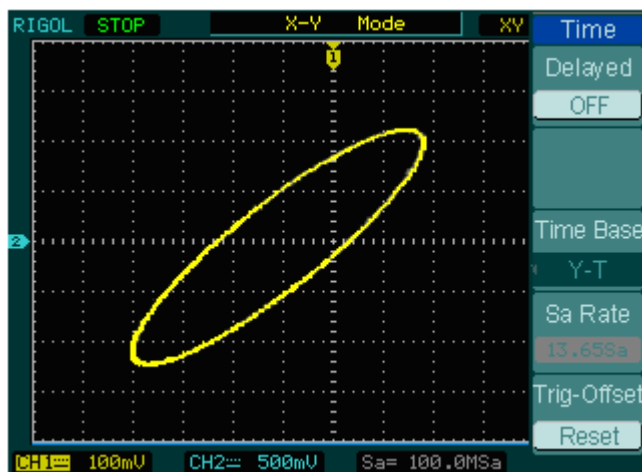



Figure 2- 40  
X-Y display format

**NOTE:** In Y-T format, all sample rates are available. But in X-Y format, 100 MSa/s is not available. In common, decreasing the sample rate can display the waveform better.

The following modes or functions will not work in X-Y format.

- LA Function (DS1000D series)
- Automatic Measurements
- Cursor Measurements
- REF and MATH Operations
- Delayed Scan Mode
- Vector Display Mode
- Horizontal  POSITION knob
- Trigger Controls

## To Set up the Trigger System

The trigger determines when the oscilloscope starts to acquire data and display a waveform. When a trigger is set up properly, it can convert unstable displays or blank screens into meaningful waveforms.

When the oscilloscope starts to acquire a waveform, it collects enough data so that it can draw the waveform to the left of the trigger point. The oscilloscope continues to acquire data while waiting for the trigger condition to occur. After it detects a trigger, the oscilloscope continues to acquire enough data so that it can draw the waveform to the right of the trigger point.

The trigger control area on the front panel includes a knob and three buttons:

**LEVEL**: The knob that set the trigger level; press the knob and the level will reset to zero.

**50%**: The instant execute button setting the trigger level to the vertical midpoint between the peaks of the trigger signal

**FORCE**: Force to create a trigger signal and the function is mainly used in Normal and Single mode

**MENU**: The button that activates the trigger controls menu.

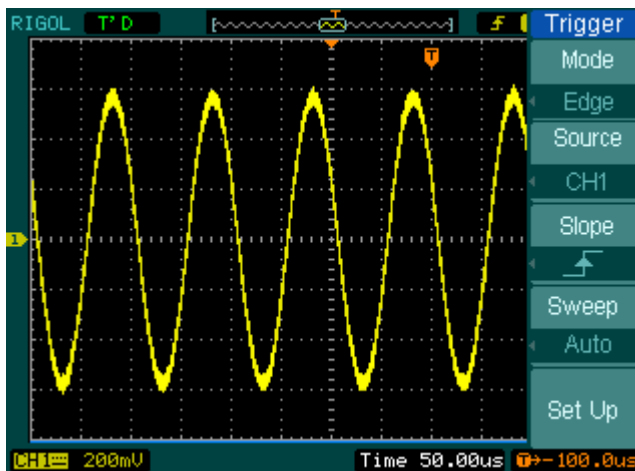

Figure 2- 41  
Trigger controls

---

## Trigger Modes

The oscilloscope provides seven trigger modes: Edge, Pulse, Slope, Video, Alternative, Pattern (only for DS1000D series) and Duration trigger (only for DS1000D series).

**Edge:** An edge trigger occurs when the trigger input passes through a specified voltage level in the specified slope direction.

**Pulse:** Use this trigger type to catch pulses with certain pulse width.

**Video:** Use video trigger on fields or lines for standard video signals.

**Slope:** The oscilloscope begins to trigger according to the signal rising or falling speed.

**Alternative:** Trigger on non-synchronized signals

**Pattern:** To Trigger through detecting a specified code.



**Duration:** To trigger within a specified time on the conditions of a specified code

## Settings for Edge Trigger

An edge trigger determines whether the oscilloscope finds the trigger point on the rising or the falling edge of a signal. Select Edge trigger Mode to trigger on Rising edge, falling edge or rising & falling edge.

Figure 2- 42 Table 2- 20 The Edge Trigger menu



Menu	Settings	Comments
Source	CH1 CH2 EXT AC Line D15-D0	Select CH1 as trigger signal Select CH2 as trigger signal Select EXT TRIG as trigger signal Select power line as trigger signal Select a digital channel in D15-D0 as trigger source (for DS1000D series)
Slope	 Rising  Falling ↑↓Rising & Falling	Trigger on rising edge Trigger on falling edge Trigger on both ring & falling edge
Sweep	Auto Normal Single	Acquire waveform even no trigger occurred Acquire waveform when trigger occurred. When trigger occurs, acquire one waveform then stop
Set up	/	To go to Set Up menu, see table 2-38

## Settings for Pulse Width Trigger

Pulse trigger occurs according to the width of pulse. The abnormal signals can be detected through setting up the pulse width condition.

Figure 2- 43 Table 2- 21 The Pulse Trigger menu (page 1/2)







Menu	Settings	Comments
Source	CH1 CH2 EXT D15-D0	Selects CH1 as trigger signal Select CH2 as trigger signal Select EXT TRIG as trigger signal Select a digital channel in D15-D0 as trigger source( Only for DS1000D series)
When	 (+Pulse width less than)  (+Pulse width more than)  (+Pulse width equal to)  (-Pulse width less than)  (-Pulse width more than)  (-Pulse width equal to)	To select pulse condition
Settings	 <Width>	Set required pulse width

Figure 2- 44 Table 2- 22 The Pulse Trigger menu (page 2/2)



Menu	Settings	Comments
Sweep	Auto	Acquire waveform even no trigger occurred
	Normal Single	Acquire waveform when trigger occurred. When trigger occurs, acquire one waveform and then stop
Set Up		To go to Set Up menu, see table 2-38

**NOTE:** The Pulse width adjust range is 20ns ~ 10s. When the condition is met, it will trigger and acquire the waveform.

## Settings for Video Trigger

Choose video trigger to trigger on fields or lines of NTSC, PAL, or SECAM standard video signals. Trigger coupling preset to DC.

Figure 2- 45 Table 2- 23 The Video Trigger menu (Page 1/2)

Trigger	Menu	Settings	Comments
Mode	Source	CH1	Selects CH1 as trigger source
Video		CH2	Select CH2 as trigger source
Source		EXT	Select EXT TRIG as trigger source
CH1	Polarity	<input type="checkbox"/> Normal polarity	Triggers on negative going sync pulses
Polarity		<input type="checkbox"/> Inverted polarity	Triggers on positive going sync pulses
Sync	Sync	All Lines	Trigger on all lines
All Lines		Line Num	Trigger on an specified line
1/2		Odd field	Select to trigger on odd field
↓	Even field	Select to trigger on even field	

Figure 2- 46 Table 2- 24 The Video Trigger menu (Page 2/2, when Sync is set as the specified line)



Menu	Settings	Comments
Line Num	↻ < Line sync >	Select the specified line number for sync
Standard	PAL/SECM NTSC	Select Video standard
Sweep	Auto  Normal Single	Acquire waveform even no trigger occurred Acquire waveform when trigger occurred. When trigger occurs, acquire one waveform and then stop
Set Up		To go to set up menu, see table 2-39



Figure 2- 47 Table 2- 25 The Video menu (When the Sync is set as All lines, Odd field and Even field)



Menu	Settings	Comments
Standard	PAL/SECAM NTSC	Select Video standard
Sweep	Auto Normal Single	Acquire waveform even no trigger occurred Acquire waveform when trigger occurred. When trigger occurs, acquire one waveform and then stop
Set Up		To go to set up menu, see table 2-39

**Key points**

**Sync Pulses:** When Normal Polarity is selected, the trigger always occurs on negative-going sync pulses. If the video signal has positive-going sync pulses, use the inverted Polarity selection.

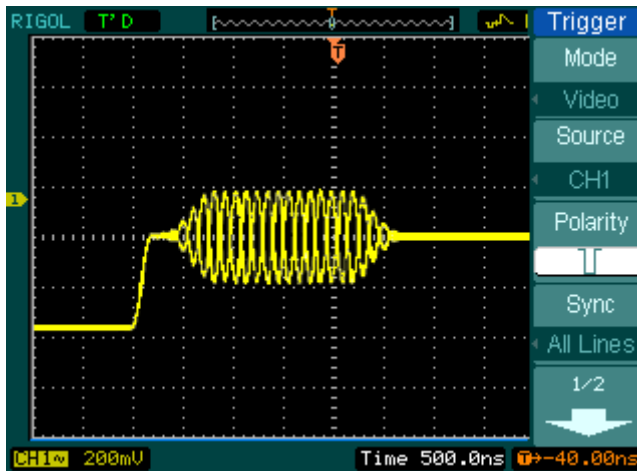

Figure 2- 48  
Video Trigger: Line Synchronization

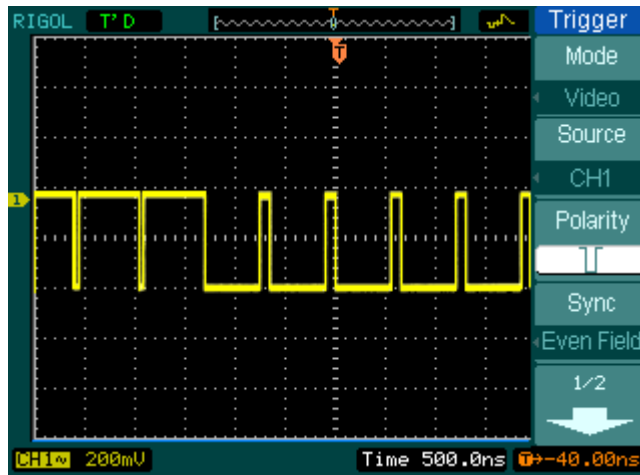

Figure 2- 49  
Video Trigger: Field Synchronization

## Slope Trigger

Slope trigger sets the oscilloscope as the positive/negative slope trigger within the specified time.

Figure 2- 50 Table 2- 26 The Slope Trigger menu (Page 1/2)

	Menu	Settings	Comments
	Source	CH1 CH2 EXT	Set channel 1 as trigger source Set channel 2 as trigger source Set EXT. channel as trigger source
	When		To select the pulse condition
	Time	 <Time Set >	To set slope time

Figure 2- 51 Table 2- 27 The Slope Trigger menu (Page2/2)

	Menu	Settings	Comments
	Vertical		Select the level that can be adjusted by  LEVEL.
	Sweep	Auto Normal Single	Acquire waveform even when no trigger condition is met. Acquire waveform when trigger condition is met. When trigger condition is met, acquire one waveform and then stop
	Set Up		To go to set up menu. See table 2-38

**NOTE:** Slope time can be set from 20ns to 10s. When a signal meets the trigger condition, scope will execute the acquisition. You can adjust LEVEL A/ LEVEL B or both simultaneous by turning the  LEVEL knob.

## Alternative Trigger

When alternative trigger is on, the trigger sources come from two vertical channels. This mode can be used to observe two non-related signals. You can choose two different trigger modes for the two vertical channels. The options are as follows: Edge, Pulse, Slope and video. The info of the trigger level of the two channels will be displayed on the upper-right of the screen.

Figure 2- 52 Table 2- 28 The Alternative menu (Trigger Type: Edge)



Menu	Settings	Comments
Select	CH1 CH2	Set trigger mode for Channel 1 Set trigger mode for Channel 2
Type	Edge	Set Edge Trigger as the trigger type
Slope	 (Rising)  (Falling)	Trigger on rising edge Trigger on falling edge
Set Up		To go to set up menu. See table 2-38

Figure 2- 53 Table 2- 29 (Trigger Type: Pulse, Page 1/2)







Trigger	Mode	<b>Menu</b>	<b>Settings</b>	<b>Comments</b>
Alternative	Select			
CH1	Type	Select	CH1 CH2	Set trigger mode for Channel 1 Set trigger mode for Channel 2
Pulse	When	Type	Pulse	Set Pulse Trigger for the channel
1/2	↓	When	 (+Pulse width less than)  (+Pulse width more than)  (+Pulse width equal to)  (-Pulse width less than)  (-Pulse width more than)  (-Pulse width equal to)	To select pulse condition

Figure 2- 54 Table 2- 30 The Alternative menu (Trigger Type: Pulse, Page 2/2)

Trigger	Setting	<b>Menu</b>	<b>Settings</b>	<b>Comments</b>
2/2	Set Up			
1.00us	↺	Setting	↺ <pulse width>	Set the width of the pulse
Set Up	↺	Set Up	↗	To go to set up menu. See table 2-38

Figure 2- 55 Table 2- 31 The Alternative menu (Trigger Type: Slope, Page 1/2)



Menu	Settings	Comments
Select	CH1 CH2	Set trigger mode for Channel 1 Set trigger mode for Channel 2
Type	Slope	Set Slope Trigger for the vertical channel
When		Set trigger condition

Figure 2- 56 Table 2- 32 The Alternative menu (Trigger Type: Slope Page 2/2)



Menu	Settings	Comments
Time	 <Time Set >	Set slope time
Vertical		Select the level to be adjusted by <b>LEVEL</b>
Set Up		To go to set up menu. See table 2-38

Figure 2- 57 Table 2- 33 The Alternative menu (Trigger Type: Video, Page 1/2)







Menu	Settings	Comments
Select	CH1 CH2	Set trigger mode for Channel 1 Set trigger mode for Channel 2
Type	Video	Video Trigger for the channel
Polarity	 Normal polarity  Inverted polarity	Triggers on negative going sync pulses Triggers on positive going sync pulses

Figure 2- 58 Table 2- 34 The Alternative menu (Trigger Mode: Video, Page 2/2)



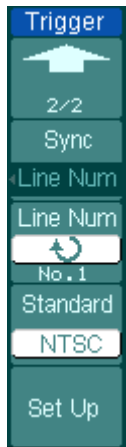

Menu	Settings	Comments
Sync	ALL lines	Trigger on all lines
	Line Num	Trigger on an specified line
Line Num	Odd field	Select to trigger on odd field or even field
	Even field	
Line Num	 <Lines Set >	Select the specified line number for sync
Standard	PAL/SECM NTSC	Select Video standard
Set Up	/	To go to set up menu, see table 2-39



## Pattern Trigger (DS1000D Series)

Pattern trigger identifies trigger terms by checking appointed code. The code is logical relationship of all channels, with high (H), low (L) and ignore(X).

Figure 2- 59 Table 2- 35 The Pattern Trigger menu



Menu	Settings	Comments
Select	D15-D0	Choose digital channel for Pattern trigger
Code	H L X  	High Low Ignore Rising Edge Falling Edge
Sweep	Auto Normal Single	Acquire waveform even no trigger occurred Acquire waveform when trigger occurred When trigger occurs, acquire one waveform and then stop
Set Up		To go to set up menu, see table 2-40

### Key Points:

**H (High):** Logic high: voltage is higher than threshold setting.

**L (Low):** Logic low: voltage is lower than threshold setting.

**X (Ignore):** Don't care. If all the channels are ignored, the oscilloscope won't be triggered.

**Rising Edge () or Falling Edge (

© 2008 RIGOL Technologies, Inc.**

**Edge of appointed code**

You can only appoint one code as edge. If you have appointed an edge, then appointed another edge in a different channel, and the first appointed edge will be set to X (Ignore).

## Duration Trigger (DS1000D Series)

Trigger in appointed time when code terms are satisfied.

Figure 2- 60 Table 2- 36 The Duration Trigger menu (Page 1/2)



Menu	Settings	Comments
Select	D15-D0	Choose digital channel for Duration Trigger
Code	H L X	High Low Ignore
Qualifier	< > =	Set time limit terms

Figure 2- 61 Table 2- 37 The Duration Trigger menu (Page 2/2)



Menu	Settings	Comments
Time	↻ <Time Setting>	Set duration and limit symbol time
Sweep	Auto Normal Single	Acquire waveform even no trigger occurred Acquire waveform when trigger occurred When trigger occurs, acquire one waveform and then stop
Set Up		To go to set up menu, see table 2-40

**Key Points:**

**H (High):** Logic high: voltage is higher than threshold setting.

**L (Low):** Logic low: voltage is lower than threshold setting.

**X (Ignore):** Don't care. If all the channels are ignored, the oscilloscope won't be triggered.

**Qualifier:** A timer begins when code terms are satisfied. Duration trigger occurred in the time set by the qualifier.

## Trigger Setup

Set up different trigger settings according to different trigger modes. When choosing source as D15-D0 in the mode of Edge and Pulse (DS1000D series), only Holdoff is adjustable. When source is non-digital channel and in slope trigger, only trigger coupling, trigger sensitivity and Holdoff can be set. For video trigger, Sensitivity and Holdoff can be set. For the pattern trigger and the duration trigger (DS1000D series), only Holdoff is adjustable.

Figure 2- 62 Table 2- 38 The Trigger Set Up menu (Settings for trigger coupling, trigger sensitivity and holdoff)



Menu	Settings	Comments
Coupling	DC AC HF Reject LF Reject	Allow all signals pass Block DC signals Reject high frequency signals Reject DC and low frequency signals
Sensitivity	↻ <Sensitivity Setting>	Set trigger sensitivity
Holdoff	↻ <Holdoff Setting>	Set time slot before another trigger event
Holdoff Reset		Reset Holdoff time to 100ns

Figure 2- 63 Table 2- 39 The Trigger Set Up menu (Settings for sensitivity and holdoff)



Menu	Settings	Comments
Sensitivity	↻ <Sensitivity Setting>	Set trigger sensitivity
Holdoff	<Holdoff Setting>	Set time slot before another trigger event
Holdoff Reset		Reset Holdoff time to 100ns

Figure 2- 64 Table 2- 40 The Trigger Set Up menu (Settings only for holdoff)



<b>Menu</b>	<b>Settings</b>	<b>Comments</b>
Holdoff	↻ <Holdoff Setting>	Set time slot before another trigger event
Holdoff Reset		Reset Holdoff time to 100ns

## Trigger Holdoff

Trigger Holdoff can stabilize complex waveform, such as the pulse range. Holdoff time is the oscilloscope's waiting period before starting a new trigger. During Holdoff, oscilloscope will not trigger until Holdoff ends. For instance: To trigger on the first pulse on a group of them, users can set the holdoff time to Pulse cluster width.

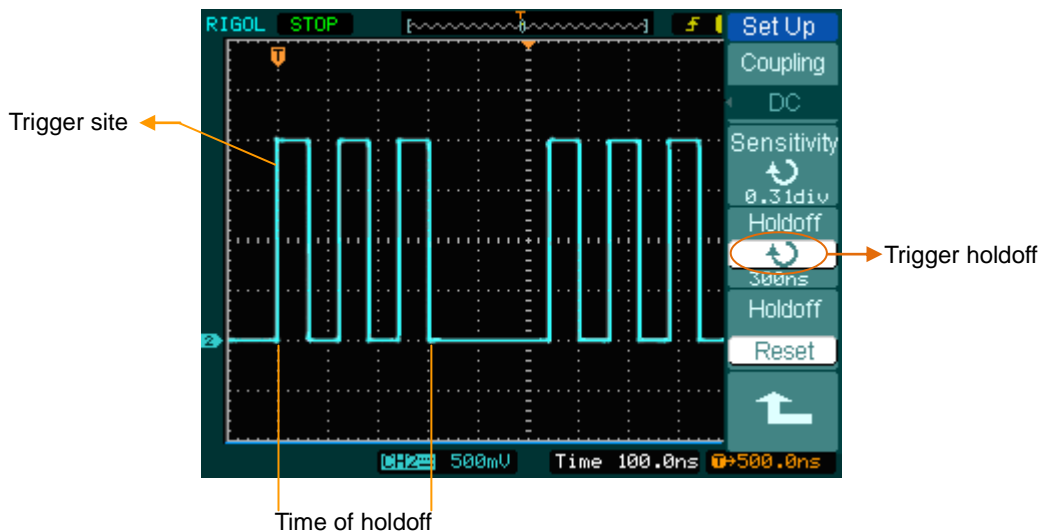

Figure 2- 65  
Trigger Holdoff

To use trigger Holdoff:

1. Press the trigger **MENU** button to display Trigger Menu.
2. Press **Set Up** key to display trigger set up menu.
3. Turn the multi function knob (↻) to change Holdoff time until waveform is stable.
4. Pushing **Trigger Hold off reset** can reset the Holdoff time to its default value.

## Trigger Key points

### 1. Trigger Source:

Trigger can occur from several sources: Input channels (CH1 and CH2), AC Line, Ext.

- **CH1 or CH2:**

It is the most commonly used trigger source. The channel works when selected as a trigger source whatever displayed or not.

- **Ext Trig:**

The instrument can be triggered from a third source while acquiring data from CH1 and CH2. For example, to trigger from an external clock or with a signal from another part of the test circuit. The Ext trigger sources use an external trigger signal connected to the EXT TRIG connector. Ext uses the signal directly; it has a trigger level range of -1.2V to +1.2V.

- **AC Line:**

AC power can be used to display signals related to the power line frequency, such as lighting equipment and power supply devices. The oscilloscope gets triggered on its AC power input; an AC trigger signal is not required. When AC Line is selected as trigger source, the oscilloscope automatically set coupling to DC, set trigger level to 0V.

### 2. Sweep Mode:

The sweep mode determines how the oscilloscope behaves in the absence of a trigger event. The oscilloscope provides three trigger modes: Auto, Normal, and Single.

- **Auto:**

This sweep mode allows the oscilloscope to acquire waveforms even when it does not detect a trigger condition. If no trigger condition occurs while the oscilloscope is waiting for a specific period (as determined by the time-base setting), it will force itself to trigger.

When forcing invalid triggers, the oscilloscope cannot synchronize the waveform, and the waveform seems to roll across the display. If valid triggers occur, the display becomes stable on the screen.

Any factor results in the un-stability of waveforms can be detected by Auto



Trigger, such as the output of Power supply.

**NOTE:** When horizontal control is set under 50 ms/div, Auto mode allows the oscilloscope not to capture trigger signal.

- **Normal:**

The Normal mode allows the oscilloscope to acquire a waveform only when it is triggered. If no trigger occurs, the oscilloscope keeps waiting, and the previous waveform, if any, will remain on the display.

- **Single:**

In Single mode, after pressing the RUN/STOP key, the oscilloscope waits for trigger. While the trigger occurs, the oscilloscope acquires one waveform then stop.

### 3. Coupling:

Trigger coupling determines which signal component passing to the trigger circuit. Coupling types include AC, DC, LF Reject and HF Reject.

- **AC:** AC coupling blocks DC components and attenuates the signal below 10Hz.
- **DC:** DC coupling passes both AC and DC components.
- **LF Reject:** LF Reject coupling blocks DC component, and attenuates all signal with a frequency lower than 8 kHz.
- **HF Reject:** HF Reject coupling attenuates all signals with a frequency higher than 150 kHz.

### 4. Pre-trigger/delayed trigger:

The data collected before and after trigger.

The trigger position is typically set at the horizontal center of the screen. In the full-screen display the 6div data of pre-trigger and delayed trigger can be surveyed. More data (14div) of pre-trigger and 1s delayed trigger can be surveyed by adjusting the horizontal  POSITION knob.

This feature is very useful to study the events that led up to the trigger point. Everything to the right of the trigger point is called post-trigger information. The delay range (pre-trigger and post-trigger information) depends on the sweep speed selected.

## **5. Adjustable trigger sensitivity**

To avoid the influence of noise from the physical world, and get the stable trigger, the trigger circuit has adopted Stickiness. In DS1000E, DS1000D series, the stickiness is adjustable from 0.1div-1.0div, which means when it sets to 1.0div, the trigger circuit will not affect any signal with peak-peak amplitude less than 1.0div, so as to avoid the influence of the noise.

## To Set up the Sampling System

As figure 2-66 shows, the **Acquire** button at the MENU of the front panel.

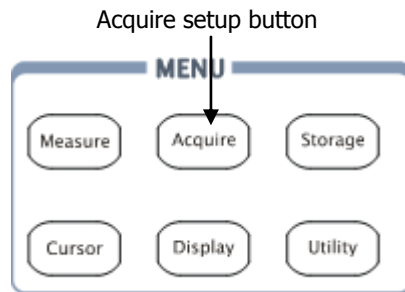

Figure 2- 66  
The Front panel MENU

Press the **Acquire** button, the interface menu as follows:

Figure 2- 67 Table 2- 41 The Acquire menu



Menu	Settings	Comments
Acquisition	Normal	Normal Acquisition mode
	Average	Average Acquisition mode
	Peak Detect	Peak Detect Acquisition mode
Averages	2 to 256	Step by multiple of two. Set average times from 2 to 256
Sampling	Real-Time	Real-time sampling mode
	Equ-Time	Equivalent sampling mode
Mem Depth	Long Mem	Set up memory as 512k or 1M
	Normal	Set up memory as 8k or 16k
Sinx/x	ON	Set the insert mode to sinx/x
	OFF	Set the insert mode to line

The waveform displayed on the screen will change in conjunction with the setting of Acquire menu.

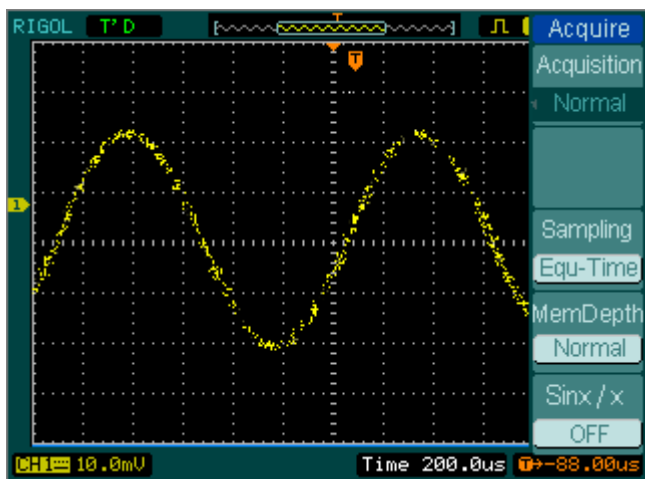

Figure 2- 68

Signal that contains noise, and without average sampling

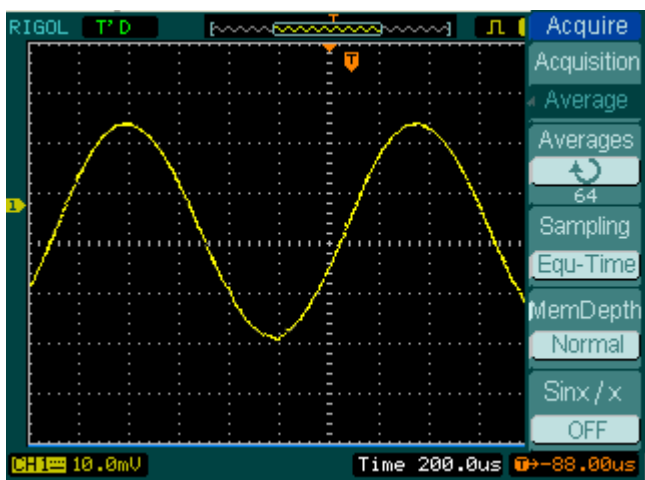

Figure 2- 69

Display signal after average sampling

**NOTE:**

- Select **Real-time** acquisition to observe the single-shot or pulse signals.
- Select **Equ-Time** to observe high frequency repetitive signals.
- To reduce the displayed random noise, select **Average** Acquisition. And this

mode would make the screen refresh slower.

- To Avoid signal aliasing, select Peak Detect Acquisition.

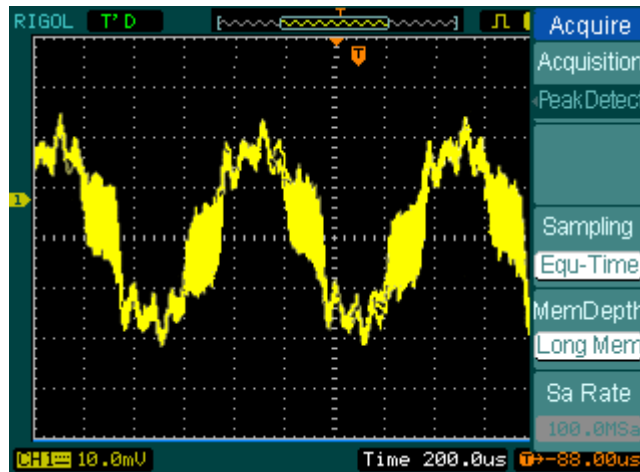

Figure 2- 70

Signal with Peak Detect Acquisition

The Peak Detect effect is shown as the figure above.

**Stop Acquisition:** When the scope is acquiring waveforms, the waveforms is in a live status; when acquisition is stopped, frozen waveform will be displayed, the position and scale can still be adjusted by vertical control and horizontal control.

**Key Points****Real-time Sampling:**

The oscilloscope has Real-time sampling rate up to 1GSa/s. At the time base 50ns or faster, the oscilloscopes use the sine(x)/x interpolation to expand the horizontal time base.

**Equivalent sampling:**

Known as Repetitive sampling to get up to 40ps of horizontal resolution (equivalent 25Gsa/s). This mode is good for observing repetitive signals, and it is not recommended for single-shot or pulse.

**Normal:**

Oscilloscope acquires signal by equal time interval.

**Average Acquisition:**

Apply averaging to your signal to remove uncorrelated noise and improve measurement accuracy. Reduces random or uncorrelated noise in the signal display. The averaged waveform is a running average over a specified number of acquisitions from 2 to 256.

**Peak Detect:**

Peak Detect mode captures the maximum and minimum values of a signal. Finds highest and lowest record points over many acquisitions.

## To Set up the Display System

Figure 2- 71 shows the menu button for the display system on the front panel.

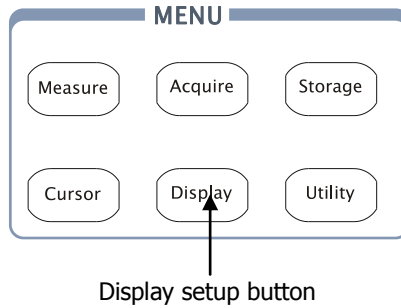

Figure 2- 71  
The Front Panel MENU

Press the **Display** button to pop up the menu for the settings of the display system.

Figure 2- 72 Table 2- 42 The Display menu (Page 1/2)







Menu	Setting	Comments
Type	Vectors Dots	Display waveforms as vectors Display waveforms as dots
Clear		Clear all existing waveforms from screen
persist	Infinite OFF	The sample points remain displayed until turn the persistence "OFF". Turn off the persistence function
Intensity	 <percentage >	Set up waveform intensity

Figure 2- 73 Table 2- 43 The Display menu (Page 2/2)



Menu	Settings	Comments
Grid	  	Display grids and coordinates on the screen Turn off the grids Turn off the grids and coordinates
Brightness	 < percentage >	Set up grid brightness
Menu Display	1s 2s 5s 10s 20s Infinite	Set the time before menu fades away. The menu will be hidden after the set time of last button pressing.

**Key points:**

**Display type:** Display type includes Vector and Dot. In vectors type, oscilloscope connects dots through digital interpolation including both linearity and  $\sin(x)/x$ .  $\sin(x)/x$  interpolation is suitable for Real-time sampling and will be more effective at 50ns or faster time base.

**Refresh rate:** It is an important performance of digital oscilloscopes. It means the number of display refreshing per second and it will affect the ability to observe signal.

**Adjusting waveform intensity**

Default setup of multi-function knob () is adjusting waveform intensity.



## To Store and Recall

Figure 2- 74 shows the menu button for the storage system on the front panel.

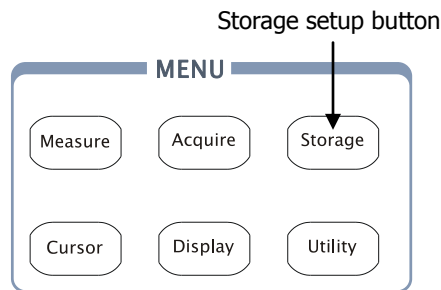

Figure 2- 74  
The Front Panel MENU

Press the **Storage** button to show the menu for the settings of the storage system. Waveforms and setups can be stored in and recalled from, both internal memory and external memory. The waveform file, setup file, bitmap and CSV file in external memory can be created and deleted. System supports English/Chinese key in.

Waveform and setup, the menu as following:

Figure 2- 75 Table 2- 44 The Storage menu



Menu	Settings	Comments
Storage	Waveform Setups Bit map CSV Factory	Store or recall waveform Store or recall instrument setups Create or delete bit map files Create or delete CSV files Recall factory setups
Internal		Go to menu for internal memory operation (see table 2-48)
External		Go to menu for external memory operation (see table 2-49)
Disk Mana.		Go to disk manage menu (see table 2-50)

For factory default setups, the menu is as following:

Figure 2- 76 Table 2- 45 The Storage menu



Menu	Settings	Comments
Storage	Waveform Setups Bit map CSV Factory	Store or recall waveform Store or recall instrument setups Create or delete bit map files Create or delete CSV files Recall factory setups
Load		Recall factory setups or files
Disk Mana.		Go to disk manage menu (see table 2-50)

Figure 2- 77 Table 2- 46 The Storage menu (For CSV)



Menu	Settings	Comments
Storage	Waveform Setups Bitmap CSV Factory	Store or recall waveform Store or recall setups Create or delete bit map files Create or delete CSV files Recall factory setups
Data Depth	Displayed Maximum	Save currently displayed waveform data to CSV file Save the whole waveform data in memory to CSV file
Para Save	On Off	Save the current oscilloscope settings in different format with the same file name
External		Go to menu for external memory operation (see table 2-49)
Disk Mana.		Go to disk manage menu (see table 2-50)

Figure 2- 78 Table 2- 47 The Storage menu (For bitmap)



Menu	Settings	Comments
Storage	Waveform Setups Bit map CSV Factory	Store or recall waveform Store or recall setups Create or delete bit map files Create or delete CSV files Recall factory setups
Para Save	On Off	Save the current oscilloscope settings in different format with the same file name
External		Go to menu for external memory operation(see table 2-49)
Disk Mana.		Go to disk manage menu (see table 2-50)

## Internal Memory

Press **Storage** → **Internal** to go to the following menu.

Figure 2- 79 Table 2- 48 The Internl Memory menu



Menu	Settings	Comments
Internal	Int_00 (N) . . . Int_09 (N)	Set up the location of files in internal memory
Load		Recall waveform files and setup files from the internal memory location
Save		Save waveform files and setup files to the internal memory location
Delete File (Folder)		Delete the selected location file (folder)

## External Memory

Press **Storage** → **External** to go to the following menu.

Figure 2- 80 Table 2- 49 The Memory menu

Menu	Settings	Comments
Explorer	Path Directory File	Switch among Path, Directory and File
New File (Folder)	/	To create new file or folder.
Delete File (Folder)	/	Delete the selected location file (folder)
Load	/	Recall waveform and setup from USB storage device.

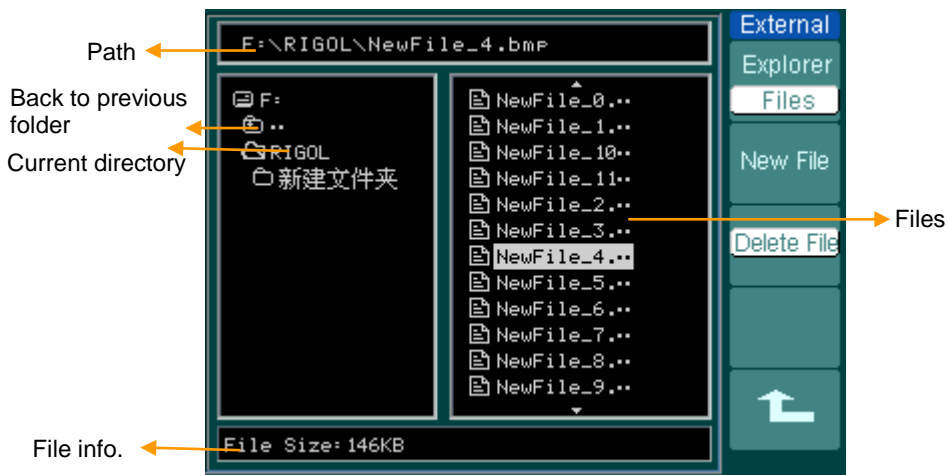

Figure 2- 81 File system

## Disk Manage

Press **Storage** → **Disk Mana.** to go to the following menu.

Figure 2- 82 Table 2- 50 The Disk Manage menu (Page 1/2)



Menu	Settings	Comments
Explorer	Path Directory File	Switch among Path, Directory and File
New folder		To create new folder( same as new files, see table 2-13)
Delete File		Delete file
Load		Recall waveform, setup, recorded waveform, Pass/Fail file

Figure 2- 83 Table 2- 51 The Disk Manage menu (Page 2/2)



Menu	Settings	Comments
Rename		To rename a file (see table 2-52)
Disk info		Display disk information

## Rename

Press **Storage** → **Disk Mana.** → **Rename** to go to the following menu.

Figure 2- 84



Table 2- 52 The Rename menu

Menu	Settings	Comments
↑		To move the cursor up
↓		To move the cursor down
X		To delete chosen letter
OK		Rename the file

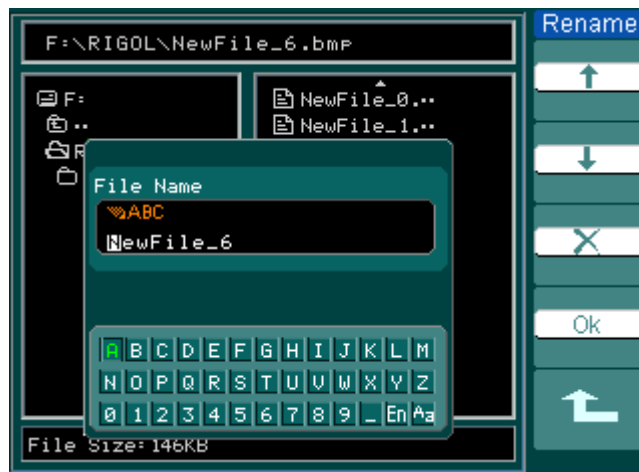

Figure 2- 85 Rename the file

**Factory**

The oscilloscope has default settings and can be recalled at anytime by user.

**Memory location**

Specify the memory location to save/recall the waveforms and setups.

**Load**

Recall saved waveforms, setups and default settings.

**Save**

Save waveforms and setups.

**NOTE:**

1. Select **Save** stores not only the waveforms, but also the current settings of the oscilloscope.
2. To ensure the setups being saved properly, only after the settings are changed for more than 5 seconds can the user turn off the instrument. The oscilloscope can store 10 settings permanently and can restore at anytime.



## To Set up the Utility

Figure 2- 86 shows the menu button for the Utility on the front panel.

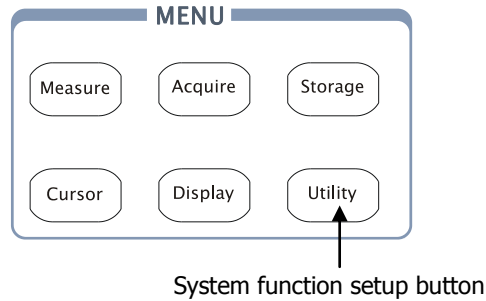

Figure 2- 86  
The Front panel MENU

Press the **Utility** button to pop up the menu for the settings of the Utility system.

Figure 2- 87 Table 2- 53 The Utility menu (Page 1/3)



Menu	Setting	Comments
I/O setting		Setup I/O configuration
Sound	(ON) (OFF)	Switch beeper sound on/off
Counter	OFF ON	Turn off Frequency Counter Turn on Frequency Counter
Language	简体中文 繁体中文 English 日本語 François ...	Select languages (More languages may be added in later firmware versions)

Figure 2- 88



Table 2- 54 The Utility menu (Page 2/3)

Menu	Settings	Comments
Pass/Fail		Setup Pass/Fail test
Record		Setup Waveform Recorder
Print set		Setup printing

Figure 2- 89



Table 2- 55 The Utility menu (Page 3/3)

Menu	Settings	Comments
Preference		Go to preference menu
Self-Cal		Execute Self-calibration
System Info		Display system information

**NOTE:**

**Self-Cal:** Oscilloscope will calibrate parameter of vertical system (CH1, CH2, and Ext), horizontal system and trigger system.

## The I/O setup

Press **Utility** → **I/O setting** to go to the following menu.

Figure 2- 90



Table 2- 56 The I/O Setup menu

Menu	Display	Comments
RS-232 Baud	300 . . 38400	Set RS-232 baud rate as 300, 2400, 4800, 9600, 19200 or 38400.
GPIB#	0-30	Set the GPIB address from 0-30.

## Preference

Press **Utility** → **Preference** to go to the following menu

Figure 2- 91 Table 2- 57 The Preference menu



Menu	Display	Comments
Screen saver	1 min . . 5 hour OFF	Set up screen saver timer
Expand Refer.	Ground Center	Set up waveform vertical expand reference
Sticky key		Set up sticky state of CH1, CH2, Math, Ref, Trig Level and Trig Offset
Skin	Classical Modern Tradition Succinct	Set up skin style

**NOTE:**

**Screen saver:** This function extends the life of LCD backlighting system.

**Expand reference:** When changing the volts/div. for channels, the signal expands or compresses around the signal ground level, or the center of the screen. When **Center** is selected, the waveform will expand or compress around the center of the display. When **Ground** is selected, the channel ground level will remain the same position on the display and waveform will zoom about the ground level.

**Sticky key:** If sticky feature is turned ON, when adjusting positions (CH1, CH2, Math, Ref, Trig level and Trig offset), the object will stop at zero position until next adjustment, for the ease of getting back to initial positions.

## Self-Calibration

The Self-Calibration adjusts the internal circuitry to get the best accuracy. Use these functions to calibrate the vertical and horizontal systems.

For maximum accuracy at any time, run this calibration if the ambient temperature changes by 5°C or more.

Before running this procedure, do these steps:

1. Disconnect any probes or cables from all channel inputs, otherwise failure or damage to the oscilloscope may occur.
2. Push the **Utility** button and select **Self-Cal**.

The self-calibration menu is displayed as Figure 2-92.

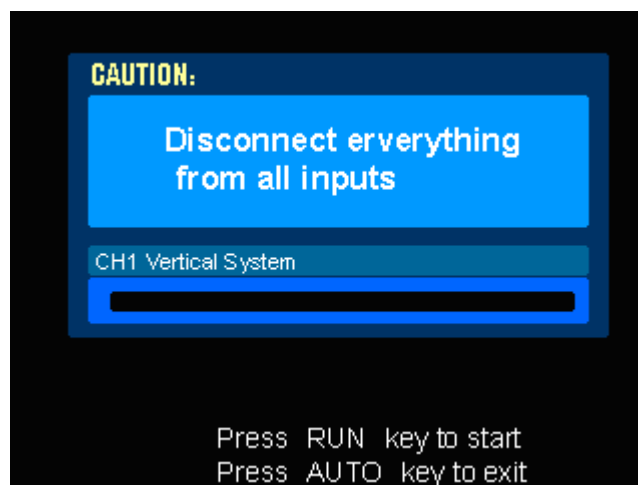

Figure 2- 92

### NOTE:

The oscilloscope must have been working or warm-up **at least 30-minutes** before running self-calibration to get best accuracy.

## Pass/Fail

The Pass/Fail function monitors changes of signals and output pass or fail signals by comparing the input signal that is within the pre-defined mask.

Press **Utility** → **Pass/Fail** to go to the following menu.

Figure 2- 93 Table 2- 58 The Pass/Fail menu (Page 1/2)



Menu	Setting	Comments
Enable Test	ON OFF	Turn on Pass/Fail test Turn off Pass/Fail test
Source	CH1 CH2	Select Pass/Fail test on CH1 Select Pass/Fail test on CH2
Operate	▶ (RUN) ■ (STOP)	Pass/Fail test stopped, press to run Pass/Fail test running, press to stop
Msg display	ON OFF	Turn on Pass/Fail information display Turn off Pass/Fail information display

Figure 2- 94 Table 2- 59 The Pass/Fail menu (Page 2/2)



Menu	Settings	Comments
Output	Fail Pass	Output when Fail condition detected Output when Pass condition detected
Stop on Output	ON OFF	Stop test when output occur Continue test when output occur
Mask Setting		Go to mask setting menu

## Mask Setting

Press **Utility** → **Pass/Fail** → **Mask Setting** to go to the following menu.

Figure 2- 95 Table 2- 60 The Mask setting menu (Page 1/2)



Menu	Settings	Comments
X Mask	< x div>	Set horizontal clearance to the waveform (0.04div-4.00div)
Y Mask	< y div>	Set vertical clearance to the waveform (0.04div-4.00div)
Create Mask		Create a test mask according to the above clearance
Location	Internal External	Set the memory location of the mask files.

Figure 2- 96 Table 2- 61 The Mask setting menu (Page 2/2)  
When the save as Internal memory



Menu	Settings	Comments
Save		Store created test mask into internal memory
Load		Recall mask setting file from internal memory
Imp./Exp.		Go to import/export menu (same as REF import/export menu. See table 2-10)

Figure 2- 97



Table 2- 62 The Mask setting menu (Page 2/2)  
When the save as external memory

Menu	Settings	Comments
Save		Go to save menu (same as REF save menu. See table 2-12)
Load		Go to load menu see table 2-63
Import		Go to import menu. (same as REF import menu see table 2-14)



## Load

Press **Utility** → **Pass/Fail** → **Mask Setting** → **Load** to go to the following menu.

Figure 2- 98



Table 2- 63 The Load menu

Menu	Settings	Comments
Explorer	Path Directory File	Switch among Path, Directory and File
Load		Recall the specified file

**NOTE:** Pass/Fail function is unavailable in X-Y mode.

## Pass/Fail connection

In Pass/Fail testing output circuit, the Oscilloscope adopts the technique of Optical Isolation. It needs to connect to another circuit to fulfill the function. Before connecting to an external circuit, make sure the maximum voltage/current does not exceed 400V/100mA. The output device has no polarity limit and can be connect arbitrarily.

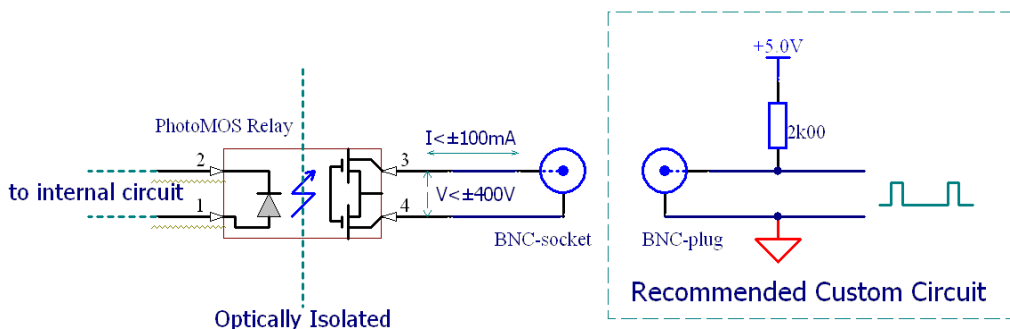

Figure 2- 99  
Schematic Diagram of Pass/Fail output

## Print Setting

The oscilloscope supports external printers.

Press **Utility** → **Print set** to go to the following menu.

Figure 2- 100 Table 2- 64 The Print Set menu



Menu	Settings	Comments
Print		Execute print function
Inverted	ON OFF	invert the color for print print original color
Palette	Gray scale Color	Set up print color

## Waveform Recorder

Waveform recorder records input waveforms from CH1 and CH2, with a maximum record length of 1000 frames. This performance can also be activated by the Pass/Fail test output, which makes this function especially useful to capture abnormal signals in long term without keeping an eye watching it.

Press **Utility** → **Record** → **Mode** → **Record** to go to the following menu.

**Waveform recorder:** Record the waveforms with specified interval.

Figure 2- 101 Table 2- 65 The Record menu (Page 1/2)



Menu	Settings	Comments
Mode	Record Play back Storage OFF	Select record mode Select play back mode Select storage mode Turn off all recorder functions
Source	CH1 CH2 P/F-OUT	Select record source channel
End Frame	 <1-1000>	Set number of record frames
Operate	(Run) (Stop)	Record stopped, press to Start recording Recording, press to stop

Figure 2- 102 Table 2- 66 The Record menu (Page 2/2)



Menu	Settings	Comments
Interval	 <1.00ms-1000s>	Set time interval

**Play back:** Play back the recorded waveforms.

Figure 2- 103 Table 2- 67 The Record menu (Page 1/2)



Menu	Settings	Comments
Operate	▶ (Run)	Play stopped, press to Start playback
	■ (Stop)	Playing, press to stop
Play mode		Set repeat play mode
		Set single time play mode
Interval	 <1.00ms-20s>	Set up interval

Figure 2- 104 Table 2- 68 The Record menu (Page 2/2)

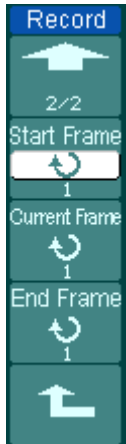

Menu	Settings	Comments
Start Frame	 <1-1000>	Set start frame
Current Frame	 <1-1000>	Select current frame to be played
End Frame	 <1-1000>	Set End frame

**NOTE:** the **RUN/STOP** button can also replay or continue the waveform display.

**Storage:** Store recorded waveforms to non-volatile memory according to setup frames.

Figure 2- 105 Table 2- 69 The Storage menu (Page 1/2)

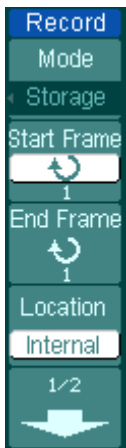

Menu	Settings	Comments
Start Frame	<1-1000>	Set first frame to be saved
End Frame	<1-1000>	Set last frame to be saved
Location	Internal external	Set up Store location

Figure 2- 106 Table 2- 70 The Storage menu (Page 1/2)

When the save to Internal memory



Menu	Settings	Comments
Save		Save recorded waveform to internal memory location
Load		Recall recorded waveform from internal memory location
Imp./Exp.		Go to import/export menu (same as REF import/export menu. See table 2-10)

Figure 2- 107



Table 2- 71 The Storage menu

When the save as external memory

Menu	Settings	Comments
Save		Go to save menu (same as REF save menu. See table 2-12)
Load		Go to load menu see table 2-63
Import		Go to import menu. (same as REF import menu see table 2-14)



## Language

The oscilloscopes have multi-language user menu, choose as your desire.

Press **Utility** → **Language** to select the language.

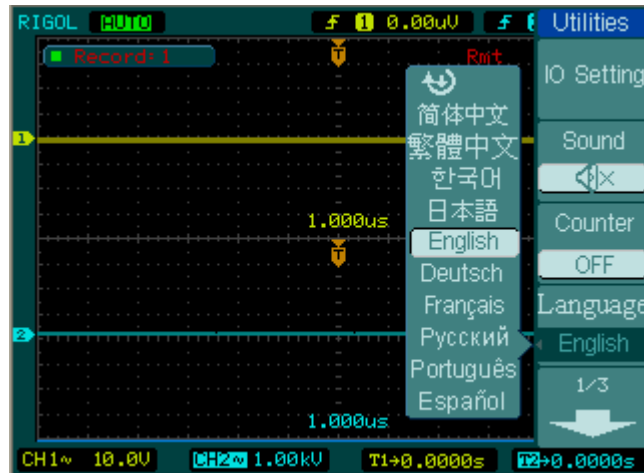

Figure 2- 108  
The Language menu

## To Measure Automatically

The **Measure** button in the menu area activates the automatic measurement function. The instruction below shows the powerful measurement function of the oscilloscopes.

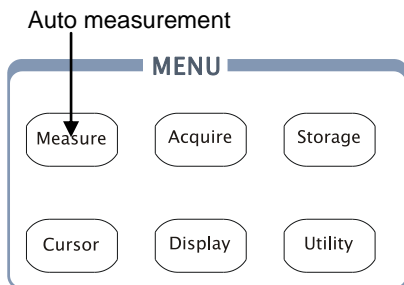

Figure 2- 109  
The Front Panel MENU

### Menu explanation:

Press the **Measure** button to display the menu for the settings of the Automatic Measurements.

The oscilloscopes provide 20 auto measurements: Vpp, Vmax, Vmin, Vtop, Vbase, Vamp, Vavg, Vrms, Overshoot, Preshoot, Freq, Period, Rise Time, Fall Time, Delay1-2 $\uparrow$ , Delay1-2 $\downarrow$ , +Width, -Width, +Duty, -Duty (10 voltage and 10 timing measurements).

Figure 2- 110      Table 2- 72 The Measure menu



Menu	Settings	Comments
Source	CH1 CH2	Select CH1 or CH2 as source channel for measurement
Voltage		Select to measure voltage parameter
Time		Select to measure time parameter
Clear		Clear measurement result on screen
Display	OFF	Turn off all measurement result
All	ON	Turn on al measurement result

## 1. Voltage Measurements

Figure 2- 111 Table 2- 73 The Voltage Measurements menu (Page 1/3)



Menu	Settings	Comments
Vmax		Measure maximum voltage of a waveform
Vmin		Measure minimum voltage of a waveform
Vpp		Measure Peak-to-Peak Voltage
Vtop		Measure a flat top voltage of a square waveform

Figure 2- 112 Table 2- 74 The Voltage Measurements menu (Page 2/3)



Menu	Settings	Comments
Vbase		Measure a flat base voltage of a square waveform
Vamp		Measure voltage between Vtop and Vbase
Vavg		Measure average voltage of a waveform
Vrms		Measure Root Mean Square Voltage of a waveform

Figure 2- 113 Table 2- 75 The Voltage Measurements menu (Page 3/3)



Menu	Settings	Comments
Overshoot		Measure overshoot in percentage of an edge
Preshoot		Measure preshoot in percentage of an edge

## 2. Time Measurements

Figure 2- 114 Table 2- 76 The Time Measurements menu (Page 1/3)



Menu	Settings	Comments
Period		Measure Period of a waveform
Freq		Measure Frequency of a waveform
Rise time		Measure Rise Time of a rising edge
Fall time		Measure Fall Time of a falling edge

Figure 2- 115 Table 2- 77 The Time Measurements menu (Page 2/3)

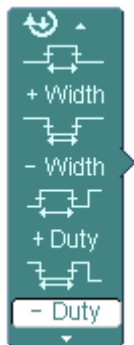

Menu	Settings	Comments
+Width		Measure +Pulse Width of a pulse wave
-Width		Measure -Pulse Width of a pulse wave
+Duty		Measure +Duty Cycle of a pulse wave
-Duty		Measure -Duty Cycle of a pulse wave

Figure 2- 116 Table 2- 78 The Time Measurements menu (Page 3/3)



Menu	Settings	Comments
Delay1→2f		Measure the signals delay between two channels at the rising edge
Delay1→2τ		Measure the signals delay between two channels at the falling edge

**NOTE:** The results of the automatic measurements will be displayed on the bottom of the screen. Maximum 3 results could be displayed at the same time. When there is no room, the next new measurement result will make the previous results moving left out of screen.

### 3. Using Automatic Measurement

1. Select the signal channel for measuring. CH1 or CH2 according to the signal of interest.

Press soft buttons as follows: **Measure** → **Source** → **CH1** or **CH2**.

2. To see all measurement values, set the **Display All** to **ON**. 18 measurement parameters will be displayed on the screen.
3. Select parameters page for measuring; select voltage or time parameters pages by pressing soft button as follows: **Measure** → **Voltage** or **time** → **Vmax**, **Vmin**.....
4. To get the measured value on the screen; select the parameters of interest by pressing the soft button on the right of the menu, and read the data on the bottom of the screen.

If the data is displayed as "\*\*\*\*\*", it means the parameter cannot be measured in current condition.

5. Clear the measure values: press **Clear** and all of the auto measure values would disappear from the screen.

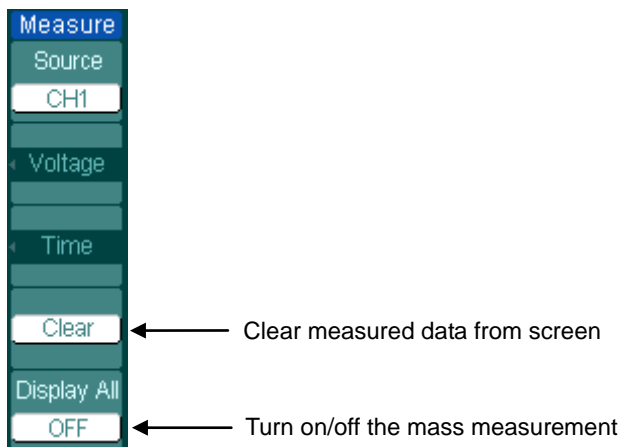

Figure 2- 117 Measurement display

## The automatic measurement of voltage parameters

The oscilloscope provides automatic voltage measurements including  $V_{pp}$ ,  $V_{max}$ ,  $V_{min}$ ,  $V_{avg}$ ,  $V_{amp}$ ,  $V_{rms}$ ,  $V_{top}$ ,  $V_{base}$ , Overshoot and Preshoot. Figure 2- 118 below shows a pulse with some of the voltage measurement points.

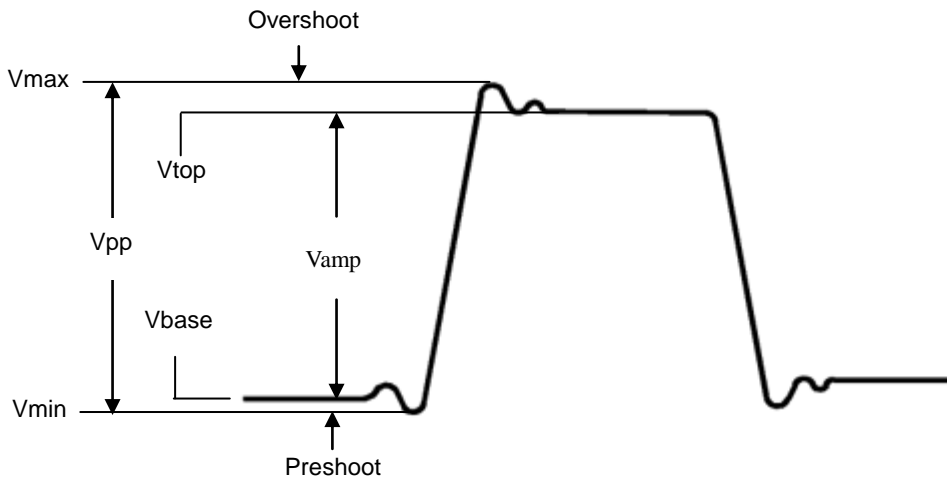

Figure 2- 118

Voltage parameters

**$V_{pp}$ :** Peak-to-Peak Voltage.

**$V_{max}$ :** The maximum amplitude. The most positive peak voltage measured over the entire waveform.

**$V_{min}$ :** The minimum amplitude. The most negative peak voltage measured over the entire waveform.

**$V_{amp}$ :** Voltage between  $V_{top}$  and  $V_{base}$  of a waveform

**$V_{top}$ :** Voltage of the waveform's flat top, useful for square/pulse waveforms.

**$V_{base}$ :** Voltage of the waveform's flat base, useful for square/pulse waveforms.

**Overshoot:** Defined as  $(V_{max}-V_{top})/V_{amp}$ , useful for square and pulse waveforms.

**Preshoot:** Defined as  $(V_{min}-V_{base})/V_{amp}$ , useful for square and pulse waveforms.

**Average:** The arithmetic mean over the entire waveform.

**$V_{rms}$ :** The true Root Mean Square voltage over the entire waveform.

## The automatic measurement of time parameters

The oscilloscope provides time parameters auto-measurements include Frequency, Period, Rise Time, Fall Time, +Width, -Width, Delay 1→2 $f$  , Delay 1→2 $t$  , +Duty and -Duty.

Figure 2- 119 shows a pulse with some of the time measurement points.

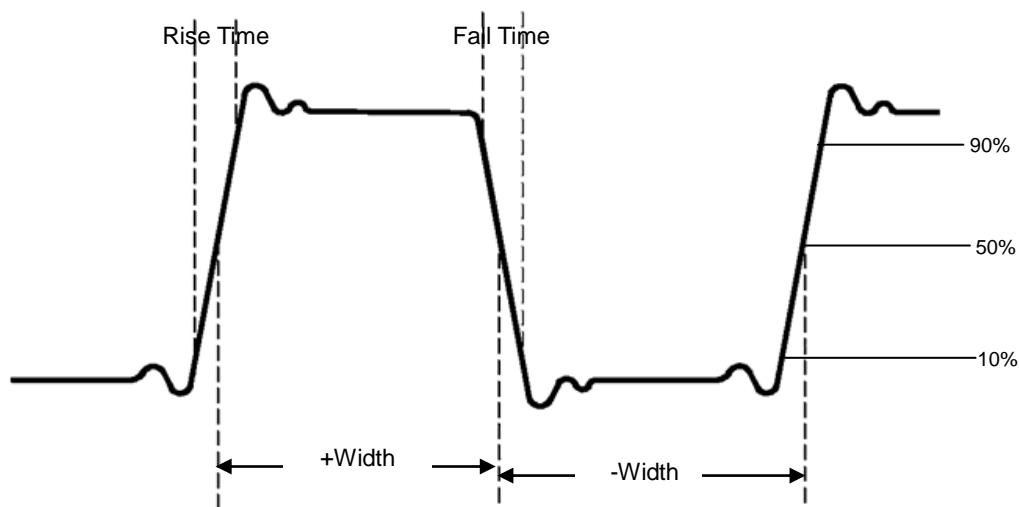

Figure 2- 119  
Time parameters

**Rise Time:** Time that the leading edge of the first pulse in the waveform takes to rise from 10% to 90% of its amplitude.

**Fall Time:** Time that the falling edge of the first pulse in the waveform takes to fall from 90% to 10% of its amplitude.

**+Width:** The width of the first positive pulse in 50% amplitude points.

**-Width:** The width of the first negative pulse in the 50% amplitude points.

**Delay 1→2 $f$  :** The delay between the two channels at the rising edge.

**Delay 1→2 $t$  :** The delay between the two channels at the falling edge.

**+Duty:** +Duty Cycle, defined as +Width/Period

**-Duty:** -Duty Cycle, defined as -Width/Period

## To Measure with Cursors

Figure 2- 120 displays the **Cursor** button on the front-panel.

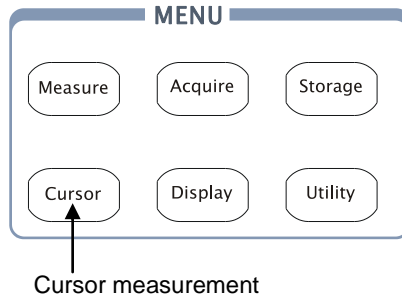

Cursor measurement

Figure 2- 120

The Front Panel MENU

The cursor measurement has three modes: Manual, Track and Auto Measure.

### 1. Manual:

In this mode, the screen displays two parallel cursors. Move the cursors to make custom voltage or time measurements of the signal. The values are displayed on the boxes below the menu. Before using cursors, make sure to set the Signal Source as the channel for measuring.

### 2. Track:

In this mode, the screen displays two cross cursors. The cross cursor sets the position on the waveform automatically. Adjust cursor's horizontal position on the waveform by rotating the multifunctional knob (↻). The oscilloscope displays the values of the coordinates on the boxes below the menu.

### 3. Auto Measure:

This mode will take effect with Automatic Measurements. The instruments will display cursors while measuring parameters automatically. These cursors demonstrate the electrical meanings of these measurements.

**NOTE:** The Auto Measure mode for Cursor measuring will take no effect without automatic measurements.



## Manual Mode

Figure 2- 121 Table 2- 79 The Manual Mode menu



Menu	Settings	Comments
Mode	Manual	Adjust the cursor to measure X/Y parameters manually
Type	X	Shown as vertical line to measure the horizontal parameters
	Y	Shown as horizontal line to measure the vertical parameters
Source	CH1 CH2 MATH/ FFT LA	Select the measurement signal source. (LA is only for DS1000D series)

In this mode, the oscilloscope measures the Y or X coordinate values of the cursors, and the increments between the two cursors.

### To do manual Cursor Measurements, please do as the following steps:

1. Select the Manual mode for cursor measurement by pressing soft button as: **Cursor** → **Mode** → **Manual**.
2. Select channel Source for measurements by pressing soft button as: **Cursor** → **Source** → **CH1**, **CH2**, **MATH (FFT)** or **LA** (DS1000D series)

**NOTE:** While measuring the channel of MATH, the results are valued with “d” (division) as units.

3. Select the cursors type by pressing soft button as **Cursor** → **Type** → **X** or **Y**.
4. Move the cursors to adjust the increment between the cursors: (Details in the following Table)

Table 2- 80 The Cursor menu

<b>Cursor</b>	<b>Increment</b>	<b>Operation</b>
Cursor A	X	Turn the multifunctional knob (↻) to move cursor A horizontally
	Y	Turn the multifunctional knob (↻) to move cursor A vertically
Cursor B	X	Turn the multifunctional knob (↻) to move cursor B horizontally
	Y	Turn the multifunctional knob (↻) to move cursor B vertically

**NOTE:** Cursor could be moved only when the curse function menu is displayed.

5. To get measurement values:

Position of Cursor 1 (time cursor centered on the midpoint of screen; Voltage cursor centered on channel ground level).

Position of Cursor 2 (same as above).

Horizontal space between cursor 1 and 2 ( $\Delta X$ ): Time between cursors ( $1/\Delta X$ ), units in Hz, kHz, MHz, GHz.

Vertical space between cursor 1 and 2 ( $\Delta Y$ ): Voltage between cursors

If you choose the source as LA (DS1000D series), the measurement value is as follows:

Position of Cursor 1 (time cursor centered on the midpoint of screen).

Position of Cursor 2 (time cursor centered on the midpoint of screen).

Cursor 1 value: Hex.

Cursor 1 value: Binary.

Cursor 2 value: Hex.

Cursor 2 value: Binary.

**NOTE:** The values will be automatically displayed on the right upper corner of screen when the cursor function menu is hidden or displaying other menus.

**Key Points**

**Cursor Y:** Cursors Y appear as horizontal lines on the display to measure vertical parameters. Usually it is used to measure the Volts. When the source is set as function, the units are assigned to the function.

**Cursor X:** Cursor X appears as vertical lines on the display to measure horizontal parameters. Usually it indicates the time of trigger excursion. When the source is set as FFT, X means frequency.

## Track Mode

Figure 2- 122 Table 2- 81 The Track Mode menu

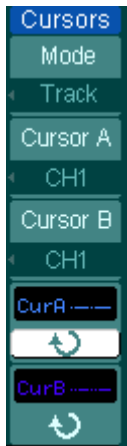

Menu	Settings	Comments
Mode	Track	Set Track mode in cursor measurement
Cursor A	CH1 CH2 None	Set Cursor A in conjunction with CH1, CH2 or turn off Cursor A
Cursor B	CH1 CH2 None	Set Cursor B in conjunction with CH1, CH2 or turn off Cursor B
CurA (Cursor A)	↻	Turn the multifunctional knob (↻) to move cursor A horizontally
CurB (Cursor B)	↻	Turn the multifunctional knob (↻) to move cursor B horizontally

In cursor track mode, the cursors move together with the selected waveform.

### To do Track mode Cursor Measurements, follow these steps:

1. Select the Track mode for cursor measurement by pressing soft button as: **Cursor** → **Mode** → **Track**.
2. Select channel Source for Cursor A and Cursor B by pressing soft button as: **Cursor** → **Cursor A** or **Cursor B** → **CH1**, **CH2** or **None**.
3. Move the cursors to adjust the horizontal positions of the cursors: (Details in the following Table)

Table 2- 82 The Cursor usage

Cursor	Operation
Cursor A	Turn the multifunctional knob (↻) to move cursor A horizontally
Cursor B	Turn the multifunctional knob (↻) to move Cursor B horizontally

**NOTE:** Moving cursor horizontally is not allowed when other (not tracking cursor) menu is activated.

4. To get measurement value:

Position of Cursor 1 (Time cursor centered on the midpoint of screen; Voltage cursor centered on channel ground level).

Position of Cursor 2 (Time cursor centered on the midpoint of screen; Voltage cursor centered on channel ground level).

Read the horizontal space between Cursor 1 and 2 ( $\Delta X$ ): Time between cursors, units in seconds.

( $1/\Delta X$ ), units in Hz, kHz, MHz, GHz.

Vertical space between cursor 1 and 2 ( $\Delta Y$ ): Voltage between cursors, units in V.

## Auto mode

Figure 2- 123



Table 2- 83 The Auto Mode menu

Menu	Settings	Comments
Mode	Auto	Display the cursors for the current automatic measuring. (See the following figure)

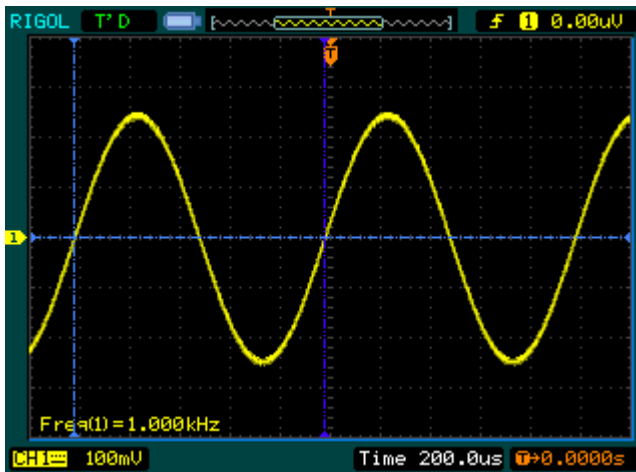

Figure 2- 124  
Auto Measure Mode of Cursor Measurement

There will be no cursor display if no parameters are chosen in Measure menu. The oscilloscope could move cursor automatically to measure 20 parameters in Measure menu.

## To Use Run Control Buttons

The run control buttons include **AUTO** (auto setting) and **RUN/STOP**.



### Auto:

The **AUTO** features automatic adjustments to produce a usable display of the input signal. Press **AUTO** button, the following menu appears.

Figure 2- 125

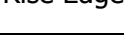
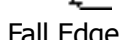

Table 2- 84 The Auto menu

Menu	Settings	Comments
 Multi-Cycle		Press to display multi-cycle waveform on the screen
 Single Cycle		Press to display single cycle waveform on the screen
 Rise Edge		Press to display the waveform's rising edge and measure its rise time automatically
 Fall Edge		Press to display the waveform's falling edge and measure its fall time automatically
 (Cancel)		Press to cancel all the Auto Set actions, the oscilloscope will recover to its previous status

## Auto-set functions

After the **AUTO** is pressed the oscilloscope is configured to the following defaults:

Table 2- 85 The Auto menu

Menu	Settings
Display format	Y-T
Acquire mode	Normal
Vertical coupling	Adjust to AC or DC according to the signal.
Vertical "V/div"	Adjusted
Volts/Div	Coarse
Bandwidth limit	Full
Signal Invert	OFF
Horizontal position	Center
Horizontal "S/div"	Adjust to right position
Trigger type	Edge
Trigger source	Find the channel with input signal automatically.
Trigger coupling	DC
Trigger voltage	Midpoint setting
Trigger mode	Auto
 POSITION knob	Trigger offset

## RUN/STOP:

Run or Stop waveform acquiring.

## NOTE:

In STOP status, the volts/div and horizontal time base can be adjusted in a fixed limit. That is, to zoom in/out the signal in vertical and horizontal directions.



## Chapter 3 : Application & Examples

### Example 1: Taking Simple Measurements

The function is used to observe an unknown signal; to display, measure frequency, and peak-to-peak amplitude.

#### To quickly display a signal, please do the steps as follow:

1. Set the probe and the channel attenuations to 10X
2. Connect signal to CH1 with the probe
3. Press the **AUTO** button

The oscilloscope sets the vertical, horizontal, and trigger controls at the best status automatically. To optimize the waveform display, adjust these controls manually to meet the requirements.

#### Selecting Automatic Measurements

The oscilloscope takes automatic measurements on most signals. To measure the frequency and the peak-to-peak amplitude, do these steps as follows:

1. Measure peak-to-peak amplitude

Press **Measure** → **Source** → **CH1** to set measurement source

Press **Voltage** → **Vpp** to select peak-to-peak measurements and the result will be displayed on the screen.

2. Measure frequency.

Press **Measure** → **Source** → **CH1** to set measurement source

Press **Time** → **Freq** to select frequency measurements and the result will be displayed on the screen.

**NOTE:** The frequency, period, and peak-to-peak measurements are shown on the screen and are updated periodically.

## Example 2: View a Signal Delay Caused by a Circuit

This example is to test the input and output signals of a circuit and observe the signal delay. First, set the probe and the channel attenuation to 10X and connect CH1 probe to the input, CH2 to the output of the circuit.

### Do these steps as follow:

1. Display the signals (CH1 and CH2):
  - (1) Press the **AUTO** button
  - (2) Adjust the vertical and the horizontal scale by turning the **SCALE** knobs to appropriate ranges for display.
  - (3) Press the **CH1** button to select Channel 1, and turn the vertical **POSITION** knob to adjust the vertical position of Channel 1 waveform.
  - (4) Press the **CH2** button to select Channel 2, and turn the vertical **POSITION** knob to adjust the vertical position of Channel 2 waveform.
2. Measure the delay time when a signal going through the circuit.

Auto-measuring the delay:

- (1) Press **Measure** → **Source** → **CH1** to set measurement source.
- (2) Press **Time** to select the measurement Type.
- (3) Press **Delay 1** → **2f** to display the result on the screen.

You can see the change of the waveform in the following figure:

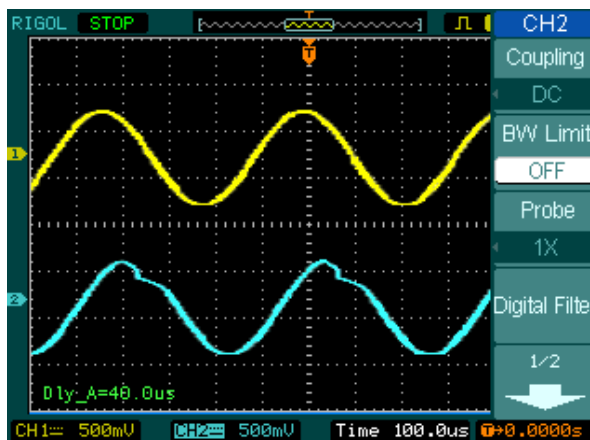

Figure 3- 1  
Delay of the signals

## Example 3: Capture a Single-Shot Signal

To capture a single event, it needs to gather some pre-test knowledge of the signal in order to set up the trigger level and slope correctly. For example, if the event is derived from TTL logic, a trigger level of 2 volts should work on a rising edge.

The following steps show how to use the oscilloscope to capture a single event.

1. Set the probe and the channel attenuations to 10X.
2. Set up the trigger.
  - (1) Press the **MENU** button in the Trigger control area to display the menu.
  - (2) Press **Edge** to select the trigger mode
  - (3) Press **Slope** to select **f**
  - (4) Press **Source** to select **CH1**
  - (5) Press **Sweep** to select **Single**
  - (6) Press **Set Up** → **Coupling** to select **DC**
3. Turn the vertical and horizontal **SCALE** knobs to adjust the Volts/Div and the Time base in a proper range for the signal
4. Turn the **LEVEL** knob to adjust trigger level
5. Press **RUN/STOP** button to start capturing. When the trigger conditions are met, data appears on the display representing the data points that the oscilloscope obtained with one acquisition.

This function helps to capture the occurrence easily, such as the noisy with large amplitude; set the trigger level higher a little above the normal level and press **RUN/STOP** and wait. When noise occurs, the instrument will record the waveform before and after the trigger. Adjust the **POSITION** button in the horizontal control area and change the level of the trigger position, will get the inverted delay trigger. It is useful to observe the waveform before the occurrence of the noise.

## Example 4: To Reduce the Random Noise on a Signal

If the signal is noisy (Figure 3- 2), set up the oscilloscope to reduce the noise on the waveform and avoid its interference to the signal.

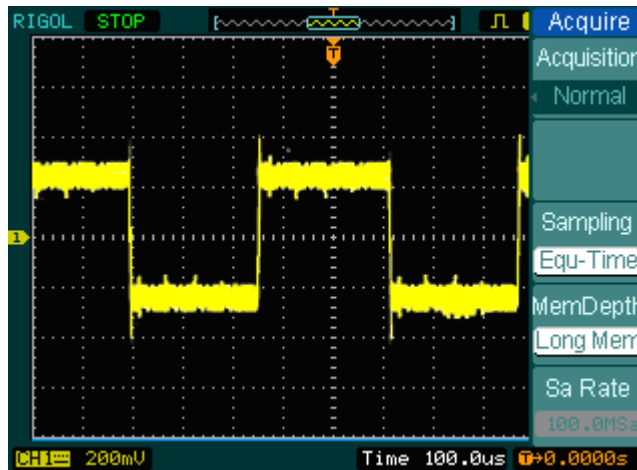

Figure 3- 2  
Waveform display

1. Set the probe and the channel attenuations to 10X.
2. Connect a signal to the oscilloscope and obtain a stable display.
3. Improve the trigger by setting the Coupling.
  - (1) Press the **MENU** in the Trigger control area.
  - (2) Press **Set Up**→**Coupling**→**LF Reject** or **HF Reject**

**HF Reject** (High frequency reject) adds a low pass filter with the -3 dB cut-off point at 150 kHz. Use HF rejects to remove high frequency noise such as AM or FM broadcast stations from the trigger path.

**LF Reject** (Low frequency reject) adds a high pass filter with the -3 dB cut-off point at 8 kHz. Use LF Reject to remove low frequency signals such as power line noise from the trigger path.

4. To reduce the noise by setting the acquisition type and adjust the waveform intensity.

- (1) If there is noise within the signal and the waveform looks too wide, in this case, choose average acquisition. In this mode the waveform will be thin and easy to observe and measure.

To use average follow these steps.

- Press soft button as **Acquire** → **Acquisition** → **Average**
- Toggle the **Averages** soft button to select the number of averages that best eliminates the noise from the displayed waveform. It can be adjusted from 2-256. (See Figure 3-3)

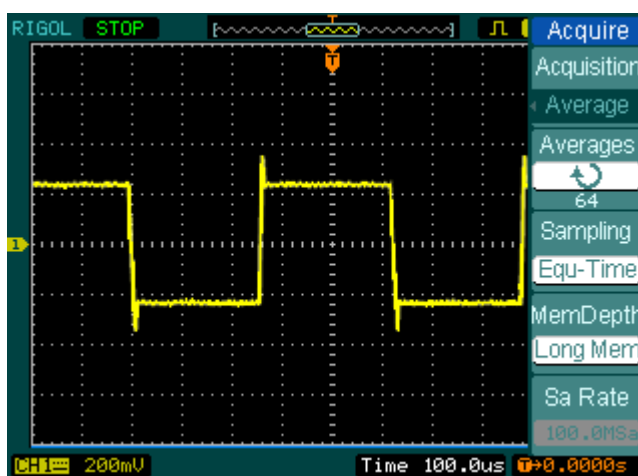

Figure 3- 3  
Waveform display

- (2) To reduce the noise it can also be achieved by reducing the intensity of the display.

**NOTE:** It is normal that the refresh rate will slow down when the average acquisition mode is ON.

## Example 5: Making Cursor Measurements

There are 20 build-in automatic measurements. They can also be conducted using cursors to make time and voltage measurements of a waveform quickly.

### Measure the Peak Frequency of the First Sinc Waveform

To measure the ringing frequency at the rising edge of a signal, do these steps:

1. Press **Cursor** key to see the Cursor menu.
2. Press **Mode** to set **Manual** mode.
3. Press **Type** to select **X**.
4. Turn (↻) knob to place cursor A on the first peak of the wave.
5. Turn (↻) knob to place cursor B on the second peak of the wave.

Observe the delta in time and frequency displayed on the screen.

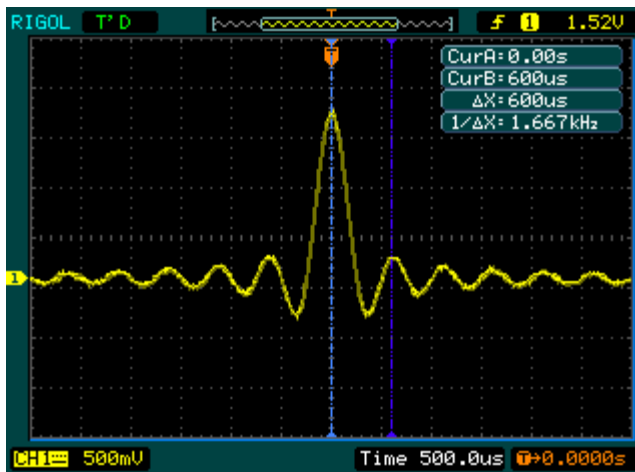

Figure 3- 4  
Waveform display

## Measure the Amplitude of the First Waveform Peak of the Sinc.

Please follow these steps:

1. Press **Cursor** key to see the Cursor menu.
2. Press **Mode** to set **Manual** mode
3. Press **Type** to select **Y**.
4. Turn (↻) knob to place cursor A on the first peak of the wave.
5. Turn (↻) knob to place cursor B on the second peak of the wave.

Observe the following measurements in the cursor menu: (See Figure 3-5)

- The delta voltage (peak-to-peak voltage of the waveform)
- The voltage at Cursor 1
- The voltage at Cursor 2

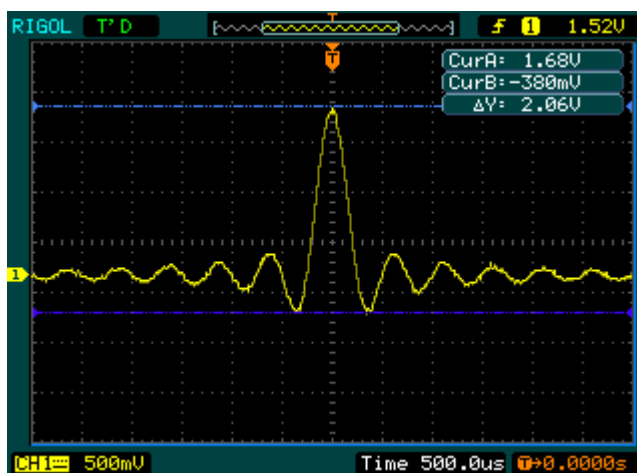

Figure 3- 5  
Waveform display

## Example 6: The application of the X-Y operation

### Viewing Phase Changes through a Network

Theme: Connect the oscilloscope to monitor the input and output of the circuit and capture the phase changes.

To view the input and output of the circuit in an X-Y display, do these steps:

1. From the probe menu set the attenuation to 10X. Set the switch to 10X on the probes.
2. Connect the CH 1 probe to the input of the network, and connect the CH 2 probe to the output.
3. If the channels are not displayed, press the **CH1** and **CH2** buttons.
4. Press the **AUTO** button
5. Adjust the vertical **SCALE** knob to display approximately the same amplitude signals on each channel
6. Press the **MENU** in horizontal control area to display the menu
7. Press the **Time Base** soft button to select **X-Y**

The oscilloscope displays a Lissajous pattern representing the input and output characteristics of the circuit

8. Adjust the vertical **SCALE** and **POSITION** knobs to a desirable waveform display.
9. Apply the Ellipse method to observe the phase difference between the two channels.

(See Figure 3-6)



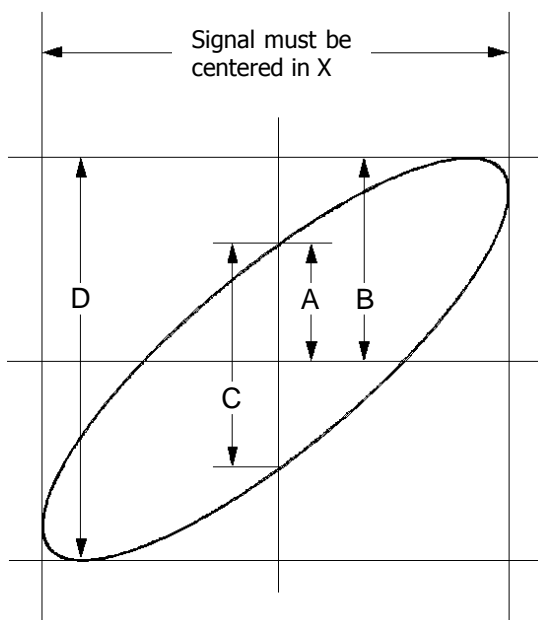

Figure 3- 6  
Ellipse method to observe the phase difference

**$\text{Sin}\theta = A/B$  or  $C/D$** , where  $\theta$  = phase shift (in degrees) between the two signals.  
From the formula above, you could get:

$$\theta = \pm \arcsine (A/B) \text{ or } \pm \arcsine (C/D)$$

If the main axis of the ellipse is at I and III quadrant,  $\theta$  must be in the range of  $(0 \sim \pi/2)$  or  $(3\pi/2 \sim 2\pi)$ . If the main axis is at II and IV quadrant,  $\theta$  must be in the range of  $(\pi/2 \sim \pi)$  or  $(\pi \sim 3\pi/2)$ .

## Example 7: Triggering on a Video Signal

Test a video circuit in the DVD set. Use video trigger to obtain a stable display.

### Triggering on Video Fields

To trigger on the video fields, please do as the following steps:

- 1 Press the **MENU** key in the Trigger control area to see the Trigger menu.
- 2 Press **Mode** to select **Video** mode.
- 3 Press **Source** to select **CH1** as trigger source.
- 4 Press **Polarity** to select **U**.
- 5 Press **Sync** as **Odd Field** or **Even Field**.
- 6 Adjust the **LEVEL** to set trigger level at the video sync pulse to get stable trigger.
- 7 Turn the horizontal **SCALE** knob to see a complete waveform on the screen.

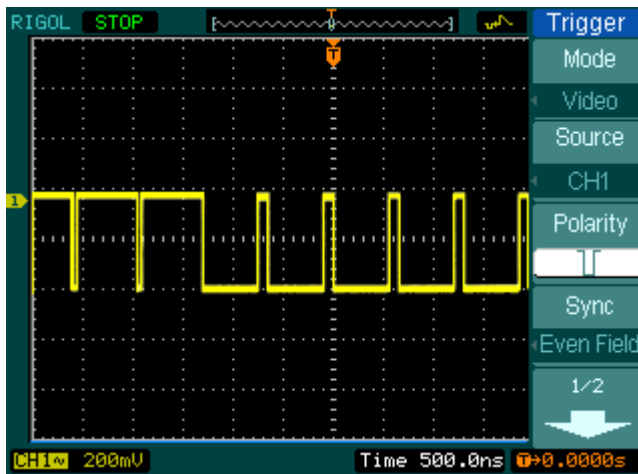

Figure 3- 7  
Waveform display

The oscilloscope triggers on the Odd field or Even field. To avoid confusion when Odd field and Even field trigger simultaneously, choose Odd field or Even field as in step 5 above.

### Triggering on the Video Lines

1. Press the **MENU** key in the Trigger control area to see the trigger menu.
2. Press **Mode** to select **Video**.
3. Press **Source** to select **CH1** as trigger source.
4. Press **Polarity** to select **↓**.
5. Press **Sync** to select **Line Num**.
6. Turn (↻) knob to trigger on a specified line number.
7. Adjust the **LEVEL** to set trigger level at the video sync pulse to get a stable trigger.
8. Turn the horizontal **SCALE** knob to observe a complete waveform on the screen.

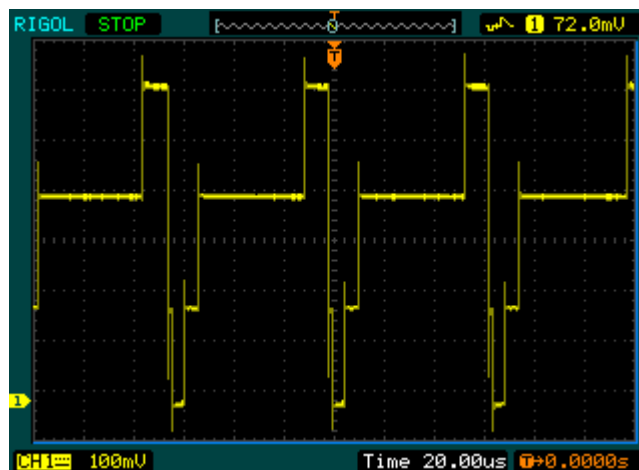

Figure 3- 8  
Waveform display

## Example 8: FFT Cursor measurement

FFT measurements include: Amplitude measurement (Vrms or dBVrms) and Frequency measurement (Hz).

Do these steps as follow:

1. Press **Cursor** → **Manual**.
2. Press **Type** to select **X** or **Y**.
3. Press **Source** to select **FFT**.
4. Turn (↻) knob to move the cursor to an interesting point.

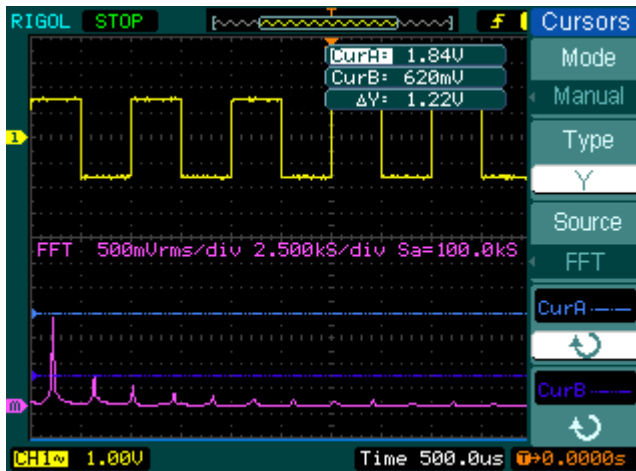

Figure 3- 9  
The example of Cursor measuring FFT amplitude

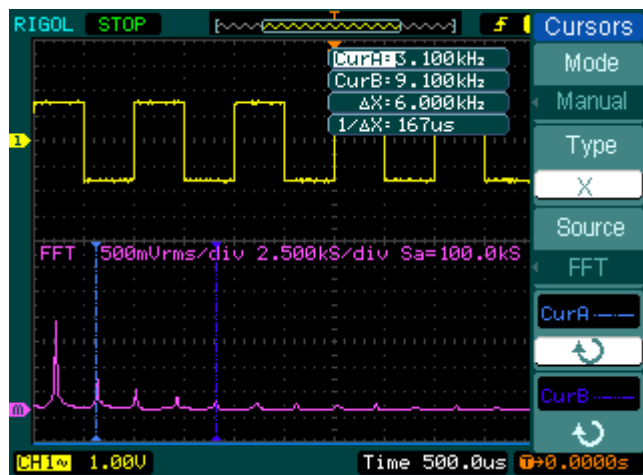

Figure 3- 10  
The example of Cursor measuring FFT frequency

## Example 9: Pass/Fail Test

When running test function the oscilloscope automatically examines the input signal, compared to the already built waveform mask. If the waveform “touches” the mask, a “Fail” occurs, otherwise the test passes. When needed, a programmable output can be used for external automatic control applications, such as the automatic failure product kick-out in a production line. The output is built in as a standard feature, and is optically isolated.

Do the steps as following:

1. Press **Utility** → **Pass/Fail**.
2. Press **Enable Test** and select **ON**.
3. Press **Mask Setting** → **Load**.
4. Press **Load** to recall the saved mask or press **X Mask** and **Y Mask** to adjust the horizontal limit and vertical limit then press **Create Mask** to create a new mask.
5. Press **Output** to select the expected outputting waveforms.
6. Press **Operate** to start the test.

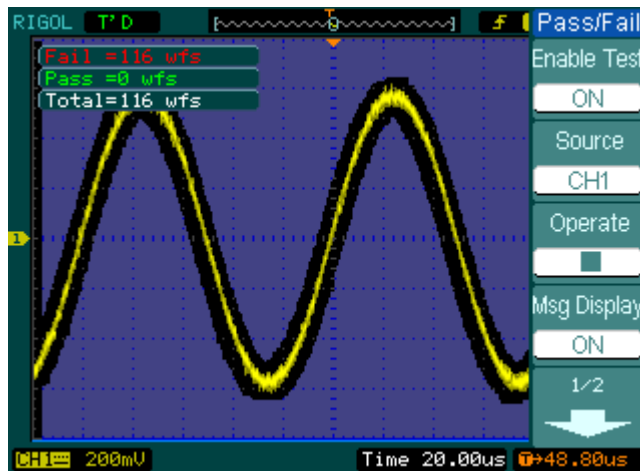

Figure 3- 11  
Waveform display

## Example 10: Triggering on a Digital Signal

The triggering way, especially to the **Digital Signal**, which the Pattern and Duration triggering are use for to carry on when triggering system was being used.

The two triggering ways are only allowed to a digital signal.

### Pattern

Do the steps as following:

1. Press the **MENU** key in the triggering control area to see the trigger menu
2. Press **Mode** to select **Pattern** mode
3. Turn (↻)knob to select the channel you want to set
4. Press **Code** to set Code Setting (H, L, X, ↗, or ↘)
5. Press **Sweep** to select trigger mode to: Auto, Normal, or Single
6. Press **Set Up** to adjust the Holdoff time.

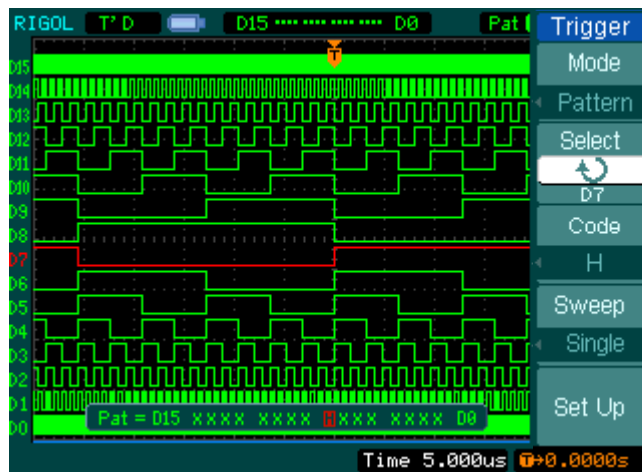

Figure 3- 12  
Pattern Trigger on a digital signal

## Duration

Do the steps as following:

1. Press the **MENU** key in the triggering control area to see the trigger menu
2. Press **Mode** to select **Duration** mode
3. Turn (**↻**) knob to select the channel you want to set
4. Press **Code** to set Code Setting (H, L, or X)
5. Press **Qualifier** to set time limit terms
6. Press **Time** to set duration and limit symbol time
7. Press **Sweep** to select trigger mode to: Auto, Normal, or Single
8. Press **Set Up** to adjust the Holdoff time.

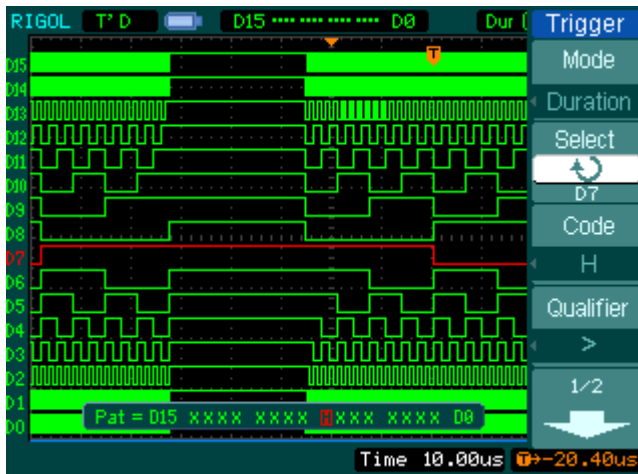

Figure 3- 13  
Duration Trigger on a digital signal



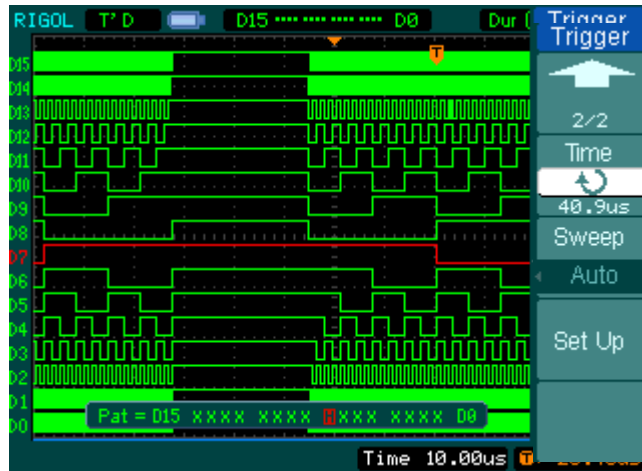



Figure 3- 14  
Duration Trigger on a digital signal





## Chapter 4 : Prompt Messages & Troubleshooting

### Prompting Message

**Setting at limit:** The setting is at limit, can not be adjusted any further.

**Trigger level at limit:** The trigger level is at limit while turning the  LEVEL knob.

**Trigger position at limit:** The trigger position is at the start or the end point of the memory space while turning the horizontal  POSITION knob to adjust the trigger offset.

**Volts/Div at limit:** The Volts/Div is at the limit of the full range while turning the vertical  SCALE knob.

**Vertical position at limit:** The vertical position of waveform is at full range while turning the vertical  POSITION knob.

**No active cursor:** The cursor source while using the Track cursor measurements.

**Delayed scale at limit:** It is at the full range of horizontal resolution under the Delayed Scan mode while turning the horizontal  SCALE knob.

**Delayed position at limit:** The horizontal position of the zoom window is at limit under the Delayed Scan mode while turning the horizontal  POSITION knob.

**Function not available:** This function is not available under current setting or the current setting is fixed without any adjustment.

**Sampling at limit:** The sampling rate is at limit under the X-Y mode.

**Real Time Div at limit:** The time base is up to the highest horizontal resolution under the Real-Time sampling mode.

**Time/div at limit:** The horizontal scale is up to the highest horizontal resolution under the Equivalent-sampling mode.

**Memory position at limit:** The Memo Offset is at the full range of the memory.

**Save finished:** The storage progress has finished.

**The storage is empty:** Current position of the memory is empty to recall saved waveforms or settings.

**Measurement already selected:** The measurement parameter you pressed is already displayed on screen.

**Dot display only:** Use Dots type for display under this setting.

**Failed operation on files:** Failed to operate on files in USB memory device

**Failed print:** Failed to perform print.

**Failed upgrade:** Failed to upgrade from a USB drive

**Files are covered:** The original file will be replaced by a new file when store a new file to the memory.

## Troubleshooting

### 1. After the oscilloscope is powered on, the screen remains dark (no display):

- (1) Check the power cable connection.
- (2) Ensure the power switch is turned on.
- (3) After the above inspection, restart the oscilloscope.
- (4) If the problem still remains, please contact **RIGOL** for help.

### 2. After the signal acquisition the waveform does not appear:

- (1) Check the probes connected with the signals.
- (2) Check the probes connected to the channels firmly.
- (3) Check the probes connected with the object being tested.
- (4) Check the circuit generates signal at the test point.
- (5) Repeat the acquisition.

### 3. The measurement result is 10 times higher or lower than the value expected.

Check if the probe attenuation is the same as the channel attenuation.

### 4. If the oscilloscope does not get a stable waveform display:

- (1) Check the **Trigger Source** and notice if it is set to the channel in use.
- (2) Check the **Trigger Type**. Use "Edge" for normal signals, and use "Video" for VIDEO signals.
- (3) Switch the **coupling** into HF Rejection or LF Rejection in order to filter the noise which disturbs trigger.
- (4) Adjust the trigger **Sensitivity** and the **hold off** time.

### 5. After pressing the **RUN/STOP** button, the oscilloscope does not display any waveform on screen.

Check whether the **Trigger Mode** is set to "Normal" or "Single" and see whether the trigger level is out of the signal range. If yes, set the trigger level in proper range by turning the **LEVEL** knob or pressing the **50%** button. Or set the Trigger Mode as "AUTO". Moreover, push **AUTO** button to display the waveform on screen.

**6. After the Acquisition is set to "Averages" or Display Persistence is set ON, the waveform refreshes slowly.**

It is normal in these settings.

**7. The signal is displayed as ladder like waveform.**

- (1) The time base setting maybe is too slow. Turn the horizontal SCALE knob to increase horizontal resolution to improve the display.
- (2) Maybe the display **Type** is set to "Vectors" set it to "Dots" mode to improve the display.

---

## Chapter 5 : Specifications

All specifications apply to DS1000E, DS1000D Series Oscilloscopes and a probe with the Attenuation switch set to 10X unless noted otherwise. To meet these specifications, two conditions must first be met:

- The instrument must have been operating continuously for thirty minutes within the specified operating temperature.
- Do perform the Self Cal operation, accessible through the Utility menu, if the operating temperature changes by more than 5°C.
- All specifications are guaranteed unless noted "typical".

## Specifications

<b>Acquisition</b>			
Sampling Modes	Real-Time	Equivalent	
Sampling Rate	1GSa/s, 200MSa/s <sup>[1]</sup>	DS1102X	DS1052X
		25GSa/s	10GSa/s
Averages	N time acquisitions, all channels simultaneously, N is selectable from 2, 4, 8, 16, 32, 64, 128 and 256.		

<b>Inputs</b>	
Input Coupling	DC, AC, GND
Input Impedance	1M $\Omega$ ±2%, in parallel with 15pF±3pF
Probe Attenuation Factors	1X, 5X, 10X, 50X, 100X, 500X, 1000X
Maximum Input Voltage	400V (DC+AC Peak, 1M $\Omega$ input impedance)
	40V (DC+AC Peak) <sup>[1]</sup>
Time delay between channel (typical)	500ps

<b>Horizontal</b>				
Sample Rate Range	Real-Time: 13.65Sa/s-1GSa/s			
	Equivalent: 13.65Sa/s-25GSa/s			
Waveform interpolation	Sin(x)/x			
Record Length	Channel Mode	Sample rate	Record Length (normal)	Record Length (long record)
	Single channel	1GSa/s	16Kpts	N.A.
	Single channel	500MSa/s Or lower	16 Kpts	1Mpts
	Double channel	500MSa/s Or lower	8 Kpts	512Kpts
Scan speed Range (Sec/div)	2ns/div~50s/div, DS1102X 5ns/div~50s/div, DS1052X 1-2-5 Sequence			
Sample Rate and Delay Time	±50ppm (over any 1ms time interval)			



Accuracy	
Delta Time Measurement Accuracy (Full Bandwidth)	Single-shot: $\pm(1 \text{ sample interval} + 50\text{ppm} \times \text{reading} + 0.6 \text{ ns})$ >16 averages: $\pm(1\text{sample interval} + 50\text{ppm} \times \text{reading} + 0.4 \text{ ns})$

<b>Vertical</b>	
A/D converter	8-bit resolution, each channel samples simultaneously <sup>[2]</sup>
Volts/div Range	2mV/div~10V/div at input BNC
Maximum Input	Analog channel maximum input voltage CAT I 300Vrms, 1000Vpk; instantaneous voltage 1000Vpk CAT II 100Vrms, 1000Vpk RP2200 10:1: CAT II 300Vrms RP3200 10:1: CAT II 300Vrms RP3300 10:1: CAT II 300Vrms
Offset Range	$\pm 40\text{V}(200\text{mV}-10\text{V}), \pm 2\text{V}(2\text{mV}-100\text{mV})$
Analog Bandwidth	100MHz (DS1102D, DS1102E) 50MHz (DS1052D, DS1052E)
Single-shot Bandwidth	80MHz (DS1102D, DS1102E) 50MHz (DS1052D, DS1052E)
Selectable Analog Bandwidth Limit (typical)	20MHz
Lower Frequency Limit (AC -3dB)	$\leq 5\text{Hz}$ (at input BNC)
Rise Time at BNC, typical	<3.5ns, <7ns, On (100M, 50M) respectively
DC Gain Accuracy	2mV/div-5mV/div: $\pm 4\%$ (Sample or Average acquisition mode) 10mV/div-10V/div: $\pm 3\%$ (Sample or Average acquisition mode)
DC Measurement Accuracy, Average Acquisition Mode	Average of $\geq 16$ Waveforms with vertical position at zero: $\pm(\text{DC Gain Accuracy} \times \text{reading} + 0.1\text{div} + 1\text{mV})$ Average of $\geq 16$ Waveforms with vertical position not at zero: $\pm[\text{DC Gain Accuracy} \times (\text{reading} + \text{vertical position}) + (1\% \text{ of vertical position}) + 0.2\text{div}]$ Add 2mV for settings from 2mV/div to 200 mV/div

**RIGOL**

	Add 50mV for settings from >200mV/div to 10V/div
Delta Volts Measurement Accuracy (Average Acquisition Mode)	Delta Volts between any two averages of 16 waveforms acquired under same setup and ambient conditions: $\pm(\text{DC Gain Accuracy} \times \text{reading} + 0.05 \text{ div})$

<b>Trigger</b>		
Trigger Sensitivity	0.1div~1.0div (adjustable)	
Trigger Level Range	Internal	$\pm 5$ divisions from center of screen
	EXT	$\pm 1.2\text{V}$
Trigger Level Accuracy (typical) applicable for the signal of rising and falling time $\geq 20\text{ns}$	Internal	$\pm(0.3\text{div} \times \text{V/div})(\pm 4 \text{ divisions from center of screen})$
	EXT	$\pm(6\% \text{ of setting} + 200 \text{ mV})$
Trigger Offset	Normal mode: pre-trigger (262144/ sampling rate), delayed trigger 1s	
	Slow Scan mode: pre-trigger 6div, delayed trigger 6div	
Trigger Holdoff range	100ns~1.5s	
Set Level to 50% (Typical)	Input signal frequency $\geq 50\text{Hz}$	
<b>Edge Trigger</b>		
Edge trigger slope	Rising, Falling, Rising + Falling	
<b>Pulse Trigger</b>		
Trigger condition	$(>, <, =)$ Positive pulse, $(>, <, =)$ negative pulse	
Pulse Width range	20ns ~10s	
<b>Video Trigger</b>		
Video standard & line frequency	Support standard NTSC, PAL and SECAM broadcast systems. Line number range: 1~525 (NTSC) and 1~625 (PAL/SECAM)	
<b>Slope Trigger</b>		
Trigger condition	$(>, <, =)$ Positive slope, $(>, <, =)$ negative slope	
Time setting	20ns~10s	
<b>Alternate Trigger</b>		
Trigger on CH1	Edge, Pulse, Video, Slope	
Trigger on CH2	Edge, Pulse, Video, Slope	
<b>Pattern Trigger</b> <sup>[1]</sup>		

Trigger mode	D0~D15 select H, L, X, $\bar{f}$ , $\bar{z}$
<b>Duration Trigger</b> <sup>[1]</sup>	
Trigger Type	D0~D15 select H, L, X
Qualifier	>, <, =
Time setup	20ns~10s

<b>Measurements</b>		
Cursor	Manual	Voltage difference between cursors ( $\Delta V$ ) Time difference between cursors ( $\Delta T$ ) Reciprocal of $\Delta T$ in Hertz ( $1/\Delta T$ )
	Track	Voltage value for Y-axis waveform Time value for X-axis waveform
	Auto	Cursors are visible for Automatic Measurement
Auto Measure	Vpp, Vamp, Vmax, Vmin, Vtop, Vbase, Vavg, Vrms, Overshoot, Preshoot, Freq, Period, Rise Time, Fall Time, +Width, -Width, +Duty, -Duty, Delay1→2 $\bar{f}$ , Delay1→2 $\bar{z}$	

[1] For DS1000D Series;

[2] When sampling is 1GSa/s, only single channel can be used.

## General Specifications

<b>Display</b>	
Display Type	5.7 in. (145 mm) diagonal TFT Liquid Crystal Display
Display Resolution	320 horizontal ×RGB×234 vertical pixels
Display Color	64K color
Display Contrast (typical)	150:1
Backlight Brightness(typical)	300 nit

<b>Probe Compensator Output</b>	
Output Voltage(typical)	Amplitude ~3Vp-p
Frequency(typical)	1kHz

<b>Power</b>	
Supply Voltage	100 ~ 240 VAC <sub>RMS</sub> , 45~440Hz, CAT II
Power Consumption	Less than 50W
Fuse	2A, T rating, 250 V

<b>Environmental</b>	
Ambient Temperature	Operating 10°C ~ 40°C
	Non-operating -20°C ~ +60°C
Cooling Method	Fan force air flow
Humidity	+35°C or below: ≤90% relative humidity
	+35°C ~ +40°C: ≤60% relative humidity
Altitude	Operating 3,000 m or below
	Non-operating 15,000 m or below

<b>Mechanical</b>		
Size	Width	303mm
	Height	154mm
	Depth	133 mm
Heavy	Without package	2.4 kg
	Packaged	3.8 kg

<b>IP Degree</b>
------------------

IP2X
------

<b>Calibration Interval</b>
-----------------------------

The recommended calibration interval is one year
--



## Chapter 6 : Appendix

### Appendix A: Accessories

#### Standard Accessories:

- Probex2 (1.5m), 1:1, (10:1) Passive Probes

The passive probes have a 6MHz bandwidth with a rating of 150V CAT II when the switch is in the 1X position, and a Full oscilloscope bandwidth with a rating of 300 V CAT II when the switch is in the 10X position.

- A Power Cord that fits the standard of destination country
- A USB Cable
- A Data Cable
- A Positive Logic Probe
- 20 Logic Testing Nips
- 20 Logic Testing Cables
- A CD-ROM (including User's Guide and Application Software)
- A User's Guide
- A Warranty Card

#### Optional Accessories:

- BNC Cable
- RS232 Cable
- DS1000E, DS1000D soft carrying case

All accessories (standard and optional) are available by contacting your local **RIGOL** office.

## **Appendix B: Warranty**

**RIGOL** warrants its products' mainframe and accessories in materials and workmanship within the warranty period. During the period concerned, **RIGOL** guarantees the free replacement or repair of products which are approved defective.

To get repair service or obtain a copy of the whole warranty statement, please contact with your nearest **RIGOL** sales and service office.

**RIGOL** do not provide any other warranty items except the one being provided by this summary and the warranty statement. The warranty items include but not being subjected to the hint guarantee items related to tradable characteristic and any particular purpose. **RIGOL** will not take any responsibility in cases regarding to indirect, particular and ensuing damage.



---

## Appendix C: Care and Cleaning

### General Care

Do not store or leave the instrument in where the LCD display will be exposed to direct sunlight for long periods of time.



---

**CAUTION:** To avoid damage to the instrument or probes, do not expose them to sprays, liquids, or solvents.

---

### Cleaning

If this instrument requires cleaning, disconnect it from all power sources and clean it with a mild detergent and water. Make sure the instrument is completely dry before reconnecting it to a power source.

To clean the exterior surface, perform the following steps:

1. Remove loose dust on the outside of the instrument and probes with a lint-free cloth. Take care to avoid scratching the clear plastic display filter.
2. Use a soft cloth dampened with water to clean the instrument.

**NOTE:** To avoid damage to the surface of the instrument or probes, do not use any abrasive or chemical cleaning agents.

## Appendix D: Contact RIGOL

If you have any problem or requirement during using our products, please contact **RIGOL** Technologies, Inc. or the local distributors.

**Domestic:** Please call

Tel: (86-10) 8070 6688

Fax: (86-10) 8070 5070

Service & Support Hotline: **800 810 0002**

9:00 am –5: 00 pm from Monday to Friday

Or by e-mail:

**service@rigol.com**

Or mail to:

**RIGOL** Technologies, Inc.

156# CaiHe Village, ShaHe Town, ChangPing District, Beijing, China

Post Code: 102206

**Overseas:** Contact the local **RIGOL** distributors or sales office.

For the latest product information and service, please visit our website:

[www.rigolna.com](http://www.rigolna.com)

## Index

50% .....	1-17, 2-36	Hanning Window .....	2-15
AC Coupling .....	2-4	HF Reject.....	2-59
AC Line.....	2-58	Horizontal .....	5-2
Accessories .....	6-1, 6-2	I/O setup .....	2-77
Acquire .....	2-61	Inputs .....	5-2
Acquisition .....	5-2	Instant Execute Key .....	2-105
Alternative Trigger .....	2-47	Invert a waveform .....	2-10
Appendix .....	6-1	Language.....	2-91
AUTO .....	1-11, 2-105, 2-106	LEVEL.....	2-36
Auto Trigger.....	2-58	LF Reject .....	2-59
Automatic Measurement.....	2-92	Math.....	2-13
Average Acquisition.....	2-64	Measurements.....	5-5
Bandwidth Limit.....	2-6	Normal Trigger .....	2-59
Blackman Window .....	2-15	Nyquist Frequency .....	2-15
Channel Coupling.....	2-4	Optional.....	6-1
Cleaning .....	6-3	Pattern Trigger .....	2-51
Coarse/Fine.....	1-13, 2-9	Power.....	5-6
Cursor .....	2-98	Pretrigger .....	2-59
Cursor Measurements.....	2-98, 3-6	Probe Attenuation.....	2-8
DC Coupling .....	2-4	Probe compensation.....	1-8
Display .....	5-6	Probe Compensator .....	5-6
Display System .....	2-65	Prompting messages.....	4-1
Duration Trigger .....	2-53	Pulse Trigger .....	2-39
Edge Trigger .....	2-38	Random Noise.....	3-4
Envelope.....	2-64	Realtime Sampling .....	2-64
Equivalent Sampling.....	2-64	Rectangle Window .....	2-15
Ext and Ext/5 .....	2-58	REF .....	2-16
Factory Setup.....	2-74	Roll Mode Display .....	2-32
FFT .....	2-14	RUN/STOP .....	2-105
FORCE.....	1-17, 2-36	Sampling System .....	2-61
Front panel .....	1-2	Save and Recal.....	2-67
Functional check.....	1-6	Self- Calibration.....	2-79
GND Coupling.....	2-5	Single Trigger.....	2-59
Hamming Window.....	2-15	Slope Trigger.....	2-45

**RIGOL**

---

STORAGE .....	2-67	Vertical .....	5-3
Sync Pulses .....	2-43	Vertical System .....	2-2
Trigger .....	5-4	Vertical Window .....	1-12
Trigger Control.....	1-16	Video Signal .....	3-10
Trigger System .....	2-36	Video Trigger .....	2-41
Troubleshooting .....	4-3	X-Y .....	2-32
UTILITY .....	2-75	Y-T .....	2-32

