

SAMSUNG

ENG IS

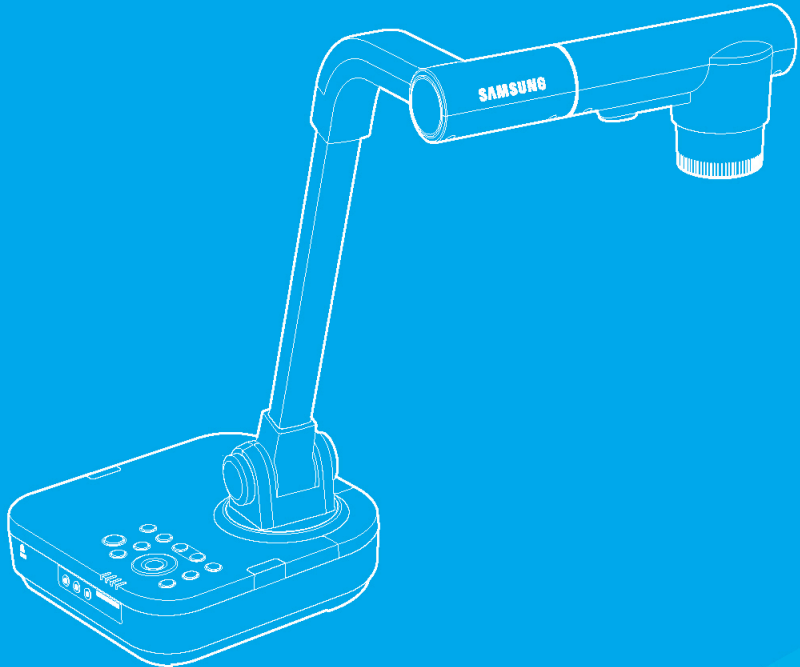
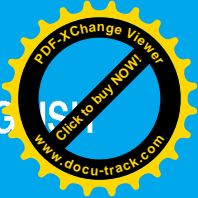

**Touchboards**

205 Westwood Ave. Long Branch, NJ 07740  
Phone: 866-94-BOARDS(26273) / (732)-222-1511  
Fax: (732)-222-7088 | E-mail: sales@touchboards.com

## DIGITAL PRESENTER USER'S MANUAL

# SDP-860

Before attempting to operate this product, Please read the instructions carefully.  
[www.samsungpresenter.com](http://www.samsungpresenter.com)

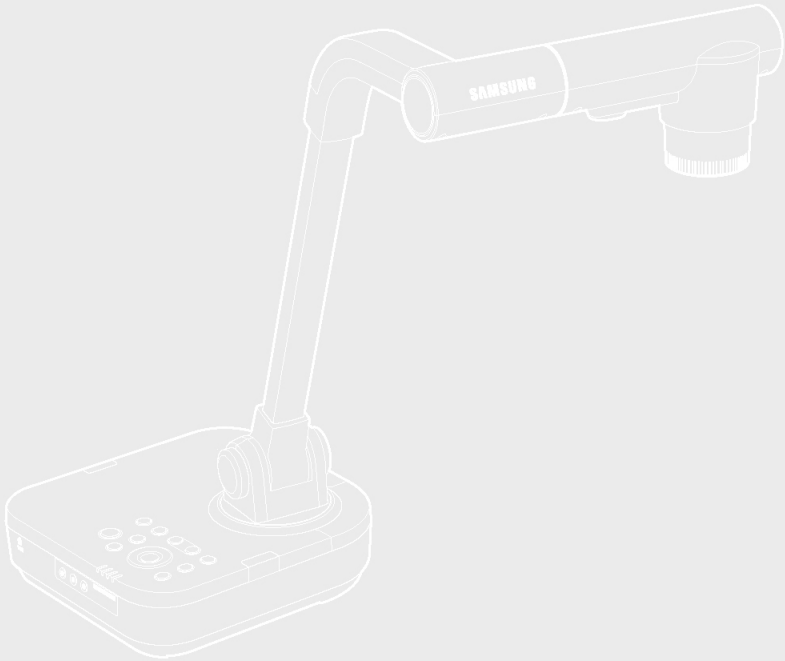
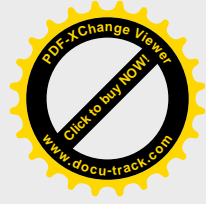
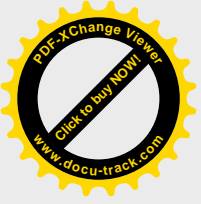

- This high-resolution projection system projects images on display devices such as PC monitors and projection screens.
- This user manual is for the SDP-860 product. Please read this manual and any supplementary document(s) thoroughly before attempting to install and/or operate the product.
- This manual and the software and hardware explained here are protected by copyright law. All copy, reprint and translation to other languages of a part of or all of the contents of this instruction manual without permission of Samsung Techwin Co., Ltd. are expressly prohibited except for fair use within the scope of copyright law.
- The specifications of this product are subject to change and upgrade without prior notice.

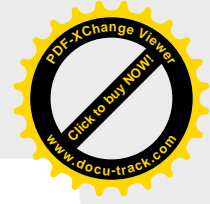
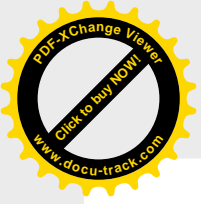

## Product Warranty and Limitations

The manufacturer of this product is not responsible for the sale of the product, nor does the manufacturer delegate such responsibility to a third party. The product warranty does not cover accidents, negligence, abuse, or improper use of the item in whole or in any part. Additionally, the manufacturer does not provide warranty for any additional part or piece that was not supplied by the manufacturer.

The product warranty period is for two years from the purchase date. However, the warranty does not cover any of the following problems, and a nominal service fee will be charged if:

- Malfunction due to user's negligence
- Dismantling or replacement by the user
- Product has been connected to power source that differs from that specified.
- Malfunction due to natural disasters (fire, flood, tsunami, etc.)
- To replace expendable components.

This warranty covers only the product supplied with the warranty.

After the warranty period (two years) has expired, a service fee will be charged for any inspection and/or repair for the product. During the warranty period, a service fee will be charged for repair and/or inspection for the product for any problems that are not covered by the warranty.

This product is not an anti-theft or fire-prevention device; the manufacturer is not responsible for any damage to property or personnel that may occur during its use.

This product must be installed by skilled and experienced personnel; self-installation by the user is prohibited. Self-installation by the user may result in fire, electrocution, and/or product malfunctions. Please contact your local dealer for assistance with the installation of the product.

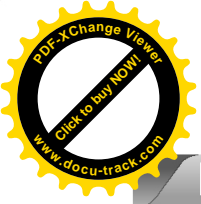

# Product Features

## 1,300k-pixel High-Resolution & High-Definition Image

Projects a real-time video at 30 frames per second and at 1,300k pixels high-resolution for live presentations.

## 2D/3D Dual Noise Reduction Technology

Equipped with our proprietary ISP chipset and 2D/3D dual noise reduction technology, this projection system depicts vivid colors even in the darkest places.

## Ultra-Macro Capacity

With 6x optical and 8x digital zooms, this system achieves a maximum of a 48x combined zoom for an excellent magnification power equal to a microscope. When equipped with an adapter lens, it also delivers ultra-close-up shots.

## Convenient Multimedia Options

The SDP-860 not only saves and plays still images and videos (VGA/30 fps) but also supports audio mixing for more versatile multimedia capabilities.

## Many Output Device Choices

The SDP-860 supports from XGA to UXGA for VGA/DVI outputs, offering various choices of output devices.

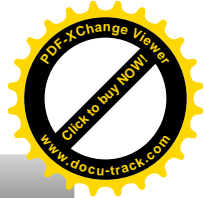

# Table of Contents

## Safety Precautions

<b>Warning</b> .....	6
<b>Caution</b> .....	7

## Product Information

<b>Package Contents</b> .....	8
<b>Part Names &amp; Functions (Main Frame)</b> .....	10
Front .....	10
Back (Rear Connection Terminals) .....	11
Side (Side Connection Terminals) .....	12
<b>Part Names &amp; Functions (Main Frame Control Board/Remote Controller)</b> .....	13
<b>Preparing Set</b> .....	15
<b>Settings Menus &amp; Default Values</b> .....	18

## Installation

<b>Connecting In/Output Devices</b> .....	20
Connecting Output Devices .....	20
Connecting Peripheral Devices .....	22
Connecting Computer for External Input .....	23
Watching Video from External Devices .....	24

## Operation

<b>Basic Operation (Functions)</b> .....	25
Output Resolution Setup (DVI/VGA Output Mode) .....	25
Enlarging/Minimizing .....	26
Adjusting Focus .....	27
Adjusting Brightness .....	28
Adjusting the Image .....	28
Preset Setting .....	31
<b>Basic Operation(Operation)</b> .....	32
Capturing Image & Videos .....	32
Freeze Mode Setting & Operation .....	39
Microscope Mode .....	39
System Reset .....	41
Checking System Version Information(VER. INFO) .....	41

## Miscellaneous (Appendix)

<b>Troubleshooting</b> .....	42
<b>Replacing Remote Controller Batteries</b> .....	43
<b>Product Specifications</b> .....	44

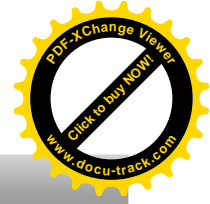
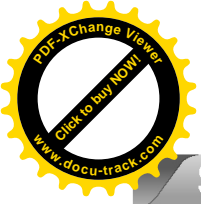

# Safety Precautions

To prevent possible user injury or damage to property, please read and follow all information below.

## Warning/Caution/Special Mark Messages



This warning symbol indicates death, grave personal injury, and/or damage to property as consequences for failure to comply.



This caution symbol indicates damage to the equipment, installed programs, and/or contained data as consequences for failure to comply.

### Warning

- **Do not connect multiple power cords to a single outlet.**
  - It is often the cause of short-circuits that may cause fire.
- **Do not place vessels containing water on the product.**
  - Water leakage can cause serious malfunctions in the product.
- **Do not forcibly bend the power cord or place a heavy object on the cord.**
  - It may result in fire.
- **Do not clean the product with water, paint thinner, or other organic solvent.**
  - To avoid product malfunctions and/or electric shock, wipe with a dry cloth.
- **Avoid installing the product in places with high humidity.**
  - It may result in electric shock and/or fire.
- **Do not pull the power cord forcibly off the outlet.**
  - A broken cord may lead to fire and/or electric shock.
- **Do not disassemble, attempt to fix, or alter the product yourself.**
  - There is a risk of malfunction, shock, and other dangers.
- **Do not touch the power plug with moisture on your hands.**
  - You may receive an electric shock injury.

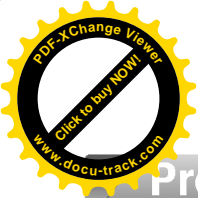

# Product Features

## Caution

- **Do not insert the power plug to a loose socket.**
  - It may result in electric shock and/or fire.
- **Avoid installing the product in places that are vulnerable to impact.**
  - Avoid installing the product in places that are exposed to powerful magnetic fields or vibrations.
- **Do not move the product while it is in operation.**
  - It may damage the product.
- **Do not insert or allow foreign objects to enter the product.**
  - It may damage the product.
- **Do not place heavy objects on the product.**
  - It may damage the product.
- **Allow good air circulation around the product.**
  - Keep the back panel at least 10cm off from a wall and the front panel 5cm away from other devices.
- **Avoid installing the product in places that are exposed to direct sunlight or heat sources.**
- **Install on a flat, stable platform.**
  - Failure to do so may result in product malfunctions.
- **Keep the power plug off when the product is not in use for an extended period of time, or during electrical storms.**
- **When detecting a strange noise or smell from the product, unplug the power cord immediately and contact our service center for assistance.**

### Caution

Random replacement of built-in battery by other types of batteries may cause explosion. The battery shall be replaced by the same battery. The used batteries shall be disposed carefully because they can cause environment pollutions.

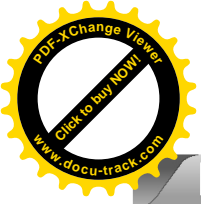

# Package Contents

The picture of the contents may differ from actual products, and certain contents may change if deemed necessary.

## Default Contents

Product Information



User's Manual



Remote Controller



Power Cable

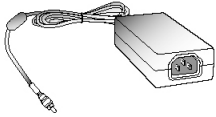

Power Adapter

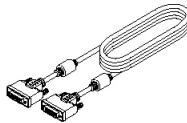

DVI Cable

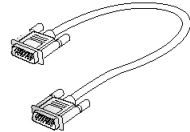

VGA Cable



USB Cable



CD



Program Manual

USB Program  
CD & Manual

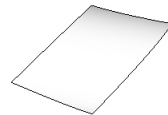

Diffuser Sheet  
(290x190)



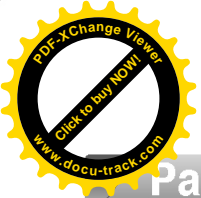

# Package Contents

## Accessories

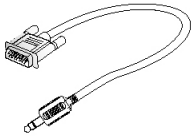

RS232C Cable



SD Card

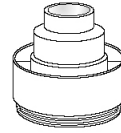

Adapter Lens

Product Information

### Caution

RS232C cables and adapter lenses from other brands may not be compatible with this product.



Samsung Techwin cares for the environment at all product manufacturing stages to preserve the environment, and is taking a number of steps to provide customers with more environmentally friendly products.

The Eco mark represents Samsung Techwin's will to create environmentally friendly products, and indicates that the product satisfies the EU RoHS Directive.

# Part Names & Functions (Main Frame)

## • Front

Product Information

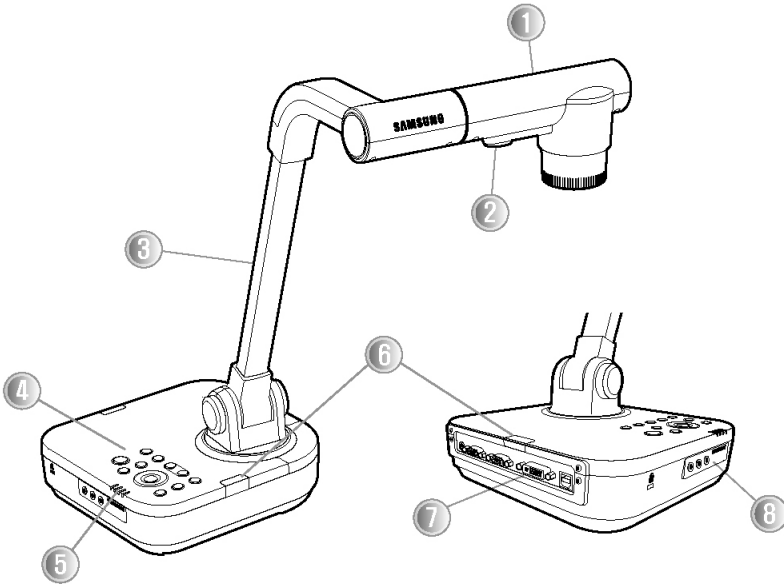



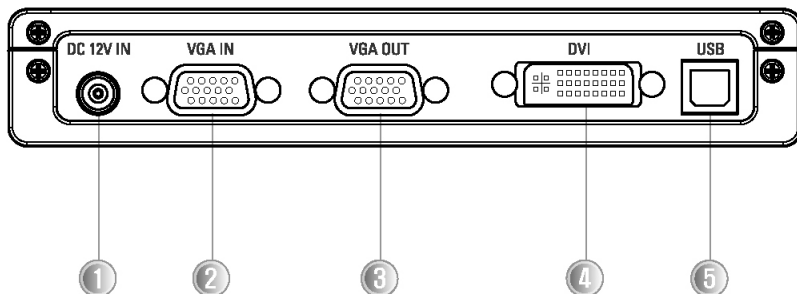

No.	Name
1	Lens
2	LED Light
3	Main Support
4	Main Frame Control Board <span style="float: right;">P.13</span>
5	Status LED
6	Remote Control Signal Receiver
7	Rear Connection Terminal <span style="float: right;">P.11</span>
8	Side Connection Terminal <span style="float: right;">P.12</span>

# Part Names & Functions (Main Frame)

## Back (Rear Connection Terminals)

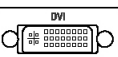

Product Information

No.	Terminal	Function
1		Connect the power adapter cable.
2		Connect the video output terminal of a VGA output device. When External Input is selected, video is displayed via this VGA video output terminal. <b>P.20</b>
3		Connect the RGB video output terminal of a PC monitor or a projector. <b>P.20</b>
4		Connect an LCD monitor or projector that supports DVI. <b>P.20</b>
5		Use this to connect to USB cable when transmitting image to a PC by USB port <b>P.21</b>

# Part Names & Functions (Main Frame)

## Side (Side Connection Terminals)

Product Information

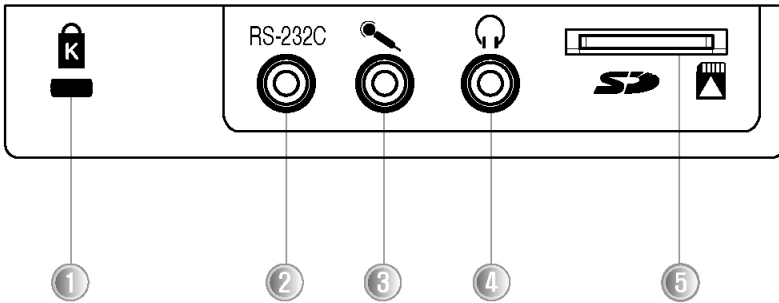

No.	Terminal	Function
①		Connect Kensington Security Slot.
②	RS-232C 	Connect a speaker or earphones for audio output signals. <span style="float: right;">P.21</span>
③		Connect an audio mixing mic for saving videos. <span style="float: right;">P.22</span>
④		Connect an RS-232C cable. <span style="float: right;">P.22</span>
⑤		Connect an SD/SDHC card for saving or importing videos and pictures. <span style="float: right;">P.22</span>

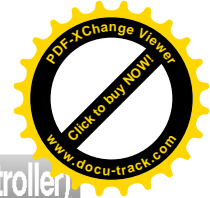
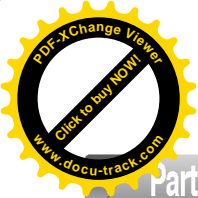

# Part Names & Functions (Main Frame Control Board/Remote Controller)

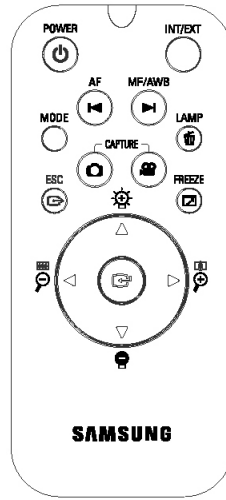
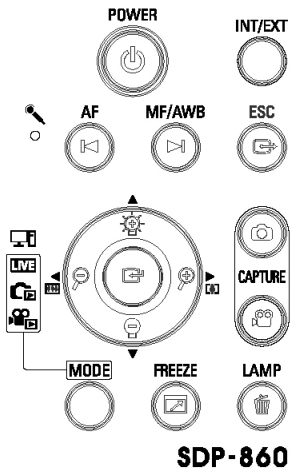

Product Information

No.	Button	Function
1		Turn On/Off Power
2		Select Internal/External Video <span style="float: right;">P.24</span>
3		( <b>LIVE</b> Mode) Auto Focus (  /  LIST Mode) Page DOWN (While Playing Video) Play Previous File <span style="float: right;">P.27</span>
4		( <b>LIVE</b> Mode) MF/Auto Color Adjustment (  /  LIST Mode) Page UP (While Playing Video) Play Next File <span style="float: right;">P.27</span>
5		Cancel Command

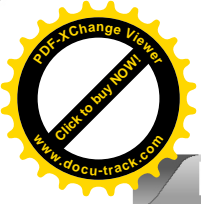

# Part Names & Functions (Main Frame Control Board/Remote Control)

No.	Button	Function
6		( <b>LIVE</b> Mode) Brighten/Darken Screen (  /  LIST Mode) Move Up/Down (While Playing Video) Adjust Volume <span style="float: right;">P.28</span>
7		( <b>LIVE</b> Mode) Enlarge/Minimize Screen (  /  LIST Mode) Move Left/Right (While Playing Video) Rewind/Fast Forward <span style="float: right;">P.26</span>
8		( <b>LIVE</b> Mode) Open Menu (  /  LIST Mode) Execute Selected Menu (While Playing Video) Play/Stop
9		( <b>LIVE</b> Mode) Capture Screen as Picture() / Video() File (SD Card Required) <span style="float: right;">P.32</span>
10		Switch to LIVE( <b>LIVE</b> ), Picture () , or Video ()Mode (Picture () and Video () Modes Require SD Card)
11		( <b>LIVE</b> Mode) Pause Screen (While Playing Video) Switch to Full Screen <span style="float: right;">P.39</span>
12		( <b>LIVE</b> Mode) Turn On/Off Light (  /  LIST Mode) Delete Picture & Video
13	 Status LED	In LIVE Mode, <b>LIVE</b> Blue LED In Still Image Mode,  Blue LED In Video Mode,  Blue LED In External Mode,  Blue LED

# Preparing Set

1. Face the lens straight down.

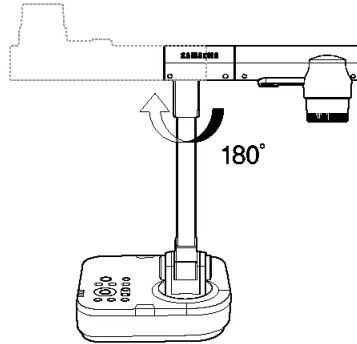
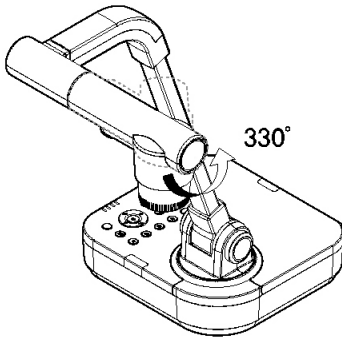

2. Adjust the main support to face the lens toward a document.

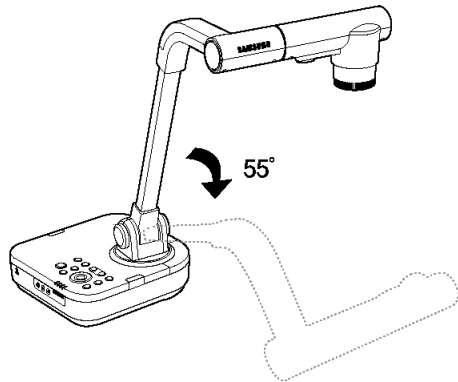
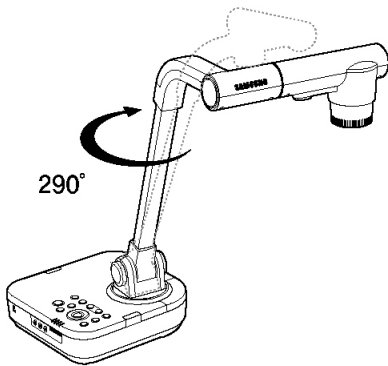

# Preparing Set

3. Connect a VGA OUT, DVI, or USB cable and the power cord. **P.20**

Product Information

To connect 110V, attach a 110V converter to the power plug.

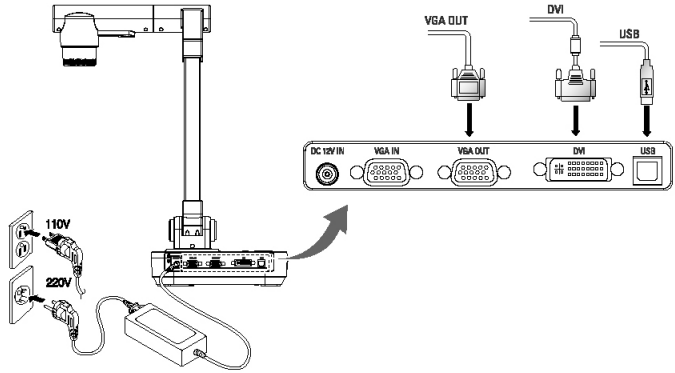

4. To turn on the power of the digital presenter, press the Power button on the digital presenter's control board or remote controller.

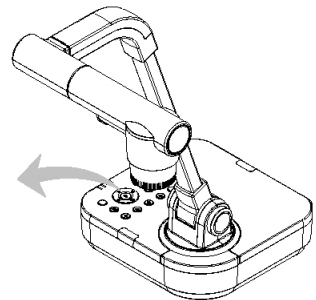
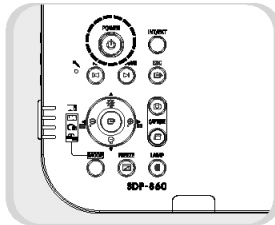
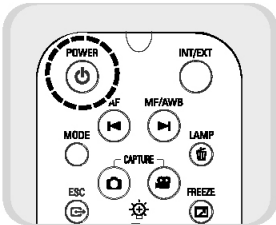





# Preparing Set

- ※ Pressing the Power button turns on the **LIVE** power LED light around the button and set status LED in blue.
- ※ Initial Screen

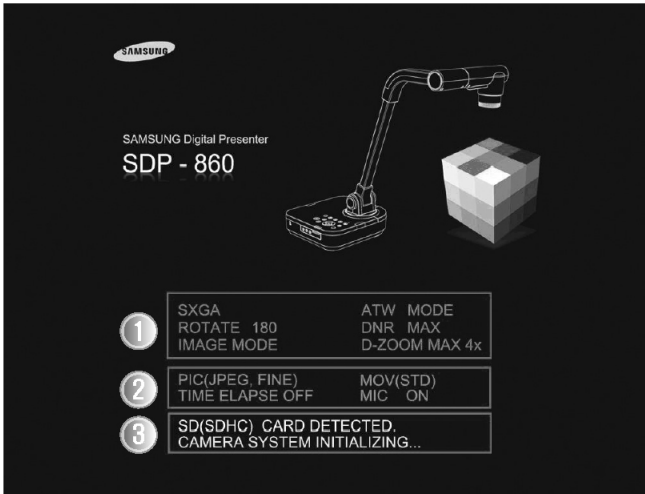

Product Information

- 1 Displays the current digital presenter settings.
- 2 Displays the current screen-capture settings.
- 3 Displays the operational status of an SD card and the system.

- SD (SDHC) CARD DETECTED: An SD card is inserted.
- SD (SDHC) CARD DOES NOT EXIST: No SD card is inserted.
- CAMERA SYSTEM INITIALIZING: In the process of initializing the system.
- SYSTEM FIRMWARE FILE EXISTS: System update files are available in an inserted SD card.
- PLEASE WAIT FOR UPDATE PROCESS: In the process of updating the system.
- UPDATE PROCESS DONE!: The system is updated.

## Caution

While the system is being updated, do not turn off the product or detach the SD card; it may cause system errors.

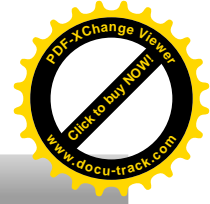
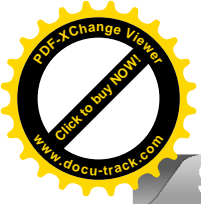

# Settings Menus & Default Values

Product Information

Setup Menu				Default Value /State
I	II	III	IV	
Output Resolution Settings (DVI/VGA Output Mode)	SXGA 1280x1024 4:3 UXGA 1600x1200 4:3 Up-Scaled XGA 1024x768 4:3 Down-Scaled 720p 1280x720 16:9 Window Cut-out 1080p 1920x1080 16:9 Window Cut-out 720p 1280x720 16:9 Stretched 1080p 1920x1080 16:9 Stretched			SXGA
Image Adjustment (IMAGE ADJUSTMENT)	WB Mode	ATW(Tracking)/AWB (One Push)/MANUAL		ATW
	DNR	OFF/AUTO(Dynamic Scene)/ MAX(Static Scene)		AUTO
	Rotation	0/180		0
	IMG Mode	TEXT		TEXT
		IMAGE		
CUSTOM	TONE - Very LOW / LOW / NORMAL / HIGH / Very High COLOR - LOW/MIDDLE/HIGH/B.W SHARPNESS - LOW/MIDDLE/HIGH			

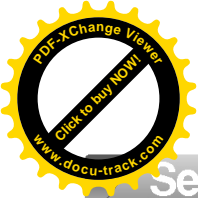

# Settings Menus & Default Values

Setup Menu				Default Value /State
I	II	III	IV	
<b>Enlarge/Minimize (ZOOM/FOCUS)</b>	Manual Focus			—
	MACRO Mode			—
	MICROSCOPE Mode			—
	D-ZOOM MAX	OFF/4x/8x		8x
<b>Screen Capture (CAPTURE SETTING)</b>	PIC Format	JPEG/BMP		JPEG
	JPG Quality	FINE/NORMAL/BEST		NORMAL
	MOV Quality	STANDARD/BEST		STANDARD
	Mic Mute	ON/OFF		OFF
	Time ELAPSE	OFF/5MIN/10MIN/15MIN/20MIN/30MIN/45MIN/1 HOUR		OFF
	Reset File Number	---		—
<b>Preset Settings (Preset SETTING)</b>	Preset-EXE	PRESET1/PRESET2/PRESET3/PRESET4		—
	Preset-SAV	PRESET1/PRESET2/PRESET3/PRESET4		—
	BOOT-Preset	OFF/PRESET1/PRESET2/PRESET3/PRESET4		OFF
<b>Miscellaneous Functions (Miscellaneous FUNCTION)</b>	Freeze	DVI,VGA / ONLY DISPLAY		DVI/VGA
	SYSTEM Reset	ON/OFF		OFF
	VER. INFO	---		—

Product Information

# Connecting In/Output Devices

## Connecting Output Devices

To use a normal or DVI monitor, you must connect the monitor to the digital presenter using a monitor or DVI cable.

### Connection

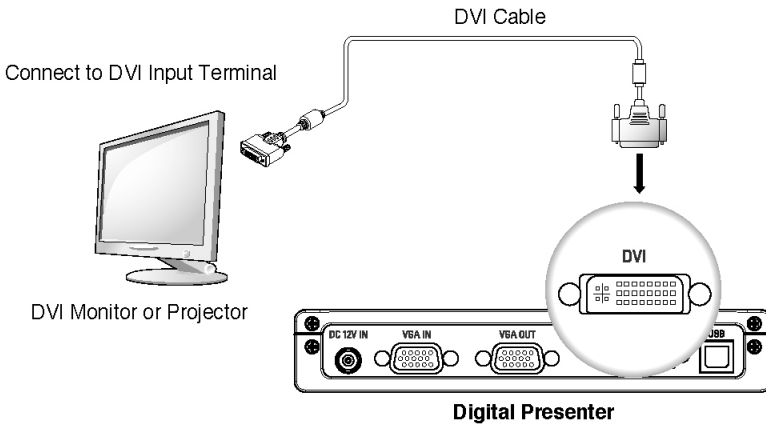
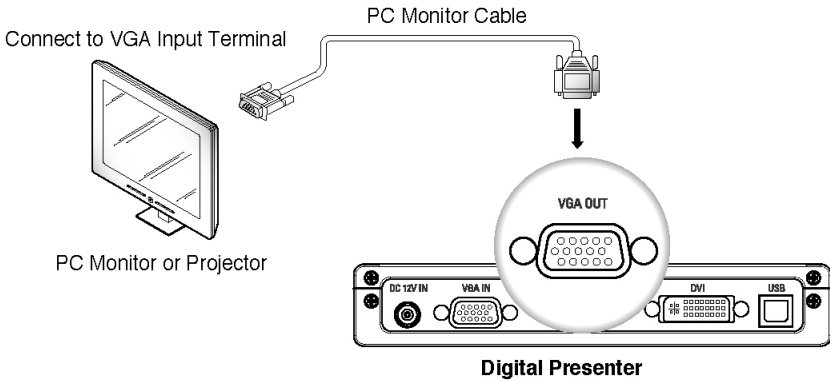

※ Depending on the specifications of the SDP-860 D/A converter and the monitor A/D converter, the color of RGB and DVI outputs may vary.

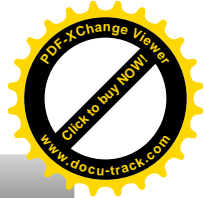
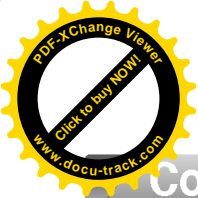

# Connecting In/Output Devices

## Connecting Computer for Output

You can watch projected images on a PC monitor by connecting the PC to the digital presenter via USB cable.

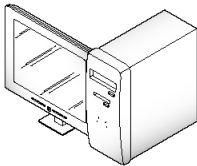

Connect this cable to the USB port on a computer.

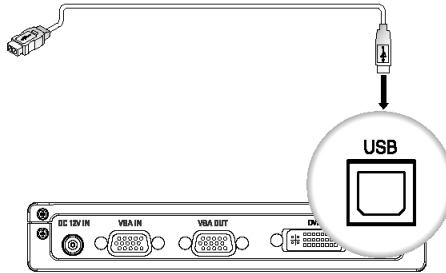

Digital Presenter

### Caution

For the USB cable connection, using a USB port on the main board of a computer is recommended. (Using an extended front port or wireless USB hub may cause errors depending on the computer brand and model.) Please do not use a USB cable longer than 4.0m for the connection between the projector and a computer.

Installation

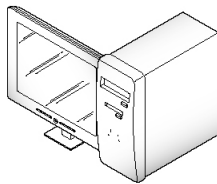

Connect this cable to the RS-232C port on a computer.

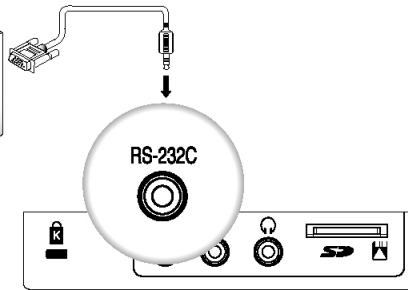

Digital Presenter

### Caution

A RS-232C cable is not included in the product package; please purchase it separately. RS-232C cables from other brands may not be compatible with this product.

- ※ When connecting via USB, install the included USB drivers and SDP-860 Viewer program in your computer. For instructions on installing the software, please read the manuals. For connecting via RS-232C cable, no extra program is provided; install and use an appropriate program.

# Connecting In/Output Devices

## Connecting Peripheral Devices

### Connecting SD/SDHC Storage Device

You can connect an SD/SDHC card for data storage.

1. Hold an SD card with the metal tip (golden finger) facing upward, and then insert to the projector.

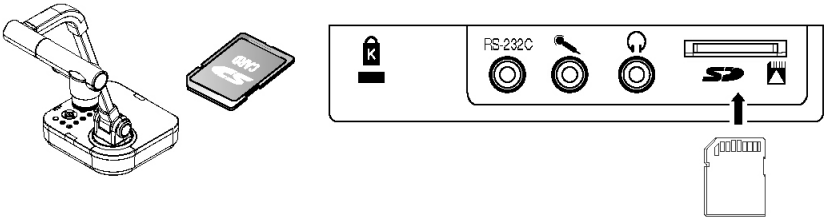

2. The "SD Card Detected" message displays on the screen. Once the card is ready to use, the Picture and Video Capture menus become available.

#### Caution

If the SD card is locked, the Video Capture menu cannot be used.

- ※ An SD/SDHC card is not included in the product package; please purchase it separately. MMS cards are not supported.

### Connecting Audio/Mic

Audio and mic use the 3.5 $\phi$  terminal.

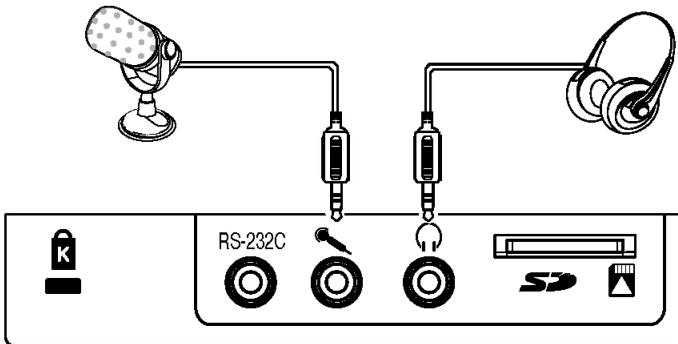

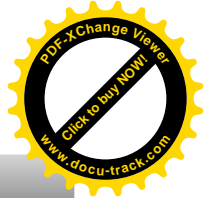
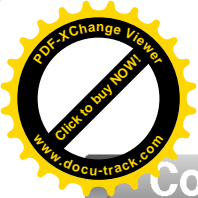

# Connecting In/Output Devices

## Connecting Kensington Security Slot

Kensington Security Slot is an anti-theft system that is integrated to the projector. Wind Kensington Security Cable around a fixture apparatus such as a rack, and then insert the end of the cable to the Kensington Security Slot in the projector.

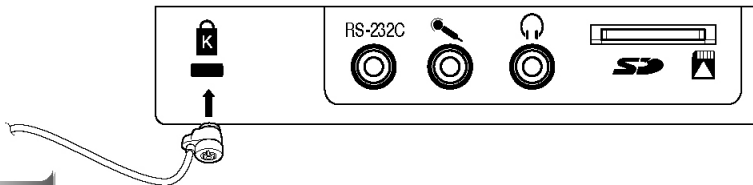

### Caution

Kensington Security Cable is not included in the product package; please purchase it separately.

## Connecting Computer for External Input

To watch VGA videos on a PC monitor, connect the digital presenter to the computer using the computer monitor cable.

※ DVI Output does not support this option.

Connect to VGA Input Terminal

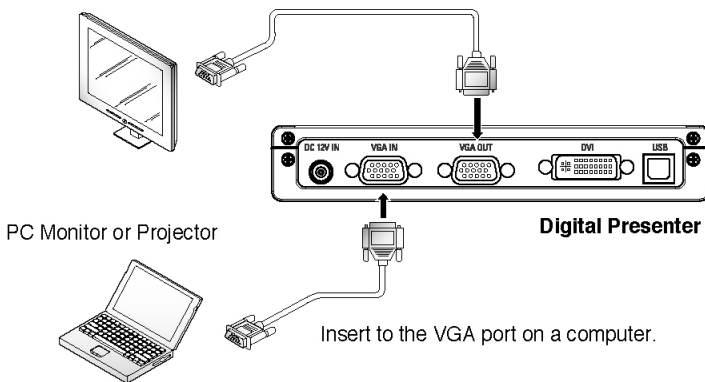

### Note

Bypass Option: Turn on the power of the digital presenter to output video from the VGA IN terminal to VGA OUT.

# Connecting In/Output Devices

## • Watching Video from External Devices

1. Install the digital presenter as instructed in this manual. **P.15**

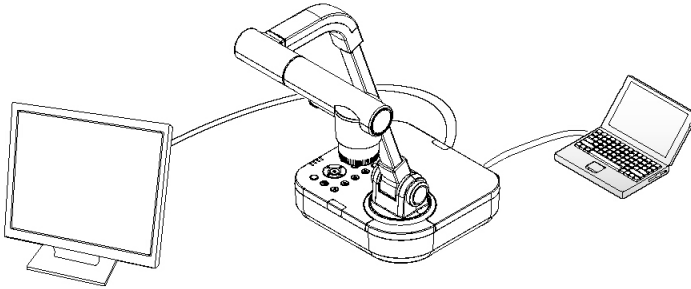

2. Select an Input option; press  on the digital presenter control board or remote controller to select an input.
  - External input or digital presenter video switches back and forth each time the button is pressed.

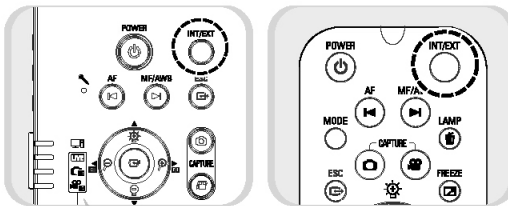

### • External Input Video [Ext]

- Enables watching video from an external VGA generator on a connected PC monitor or projector.

### • Digital Presenter Video [Int]

- Select to watch video directly from the digital presenter lens.

### Caution

- If an external input device is not connected, the output device displays only the black screen. In this case, check if the external input device is connected properly.
- Selecting the INT or EXT button does not display the current input status on the screen.



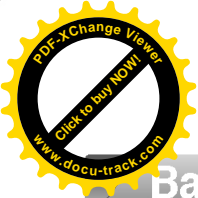

# Basic Operation (Functions)

## • Output Resolution Setup(DVI/VGA Output Mode)

• Various output resolutions are available depending on the output device: monitors or projectors.

- Available resolutions are as listed below.
  - SXGA (1280x1024)
  - UXGA (1600x1200)
  - XGA (1024x768)
  - 720p (1280x720)
  - 1080p (1920x1080)
  - 720p (1280x720)
  - 1080p (1920x1080)

1. Select DVI/VGA OUTPUT in the Menu.
2. To select a resolution, move the cursor (▶) between resolutions in the sub menu.

DVI/VGA OUTPUT MODE				
SXGA	280x1024	4:3		
UXGA	1600x1200	4:3	Up-Scaled	
▶ XGA	1024x768	4:3	Down-Scaled	
720p	1280x720	16:9	Window Cut-out	
1080p	1920x1080	16:9	Window Cut-out	
720p	1280x720	16:9	Stretched	
1080p	1920x1080	16:9	Stretched	
Return				
CURRENT: SXGA MODE				

Operation

### Caution

A resolution may not be available if an output device (monitor or projector) does not support it.

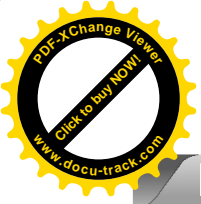

# Basic Operation (Functions)

## ● Enlarging/Minimizing

- You can zoom in and out on screen objects.
- To enlarge or shrink, press the (Enlarge) or (Minimize) button on the control board or remote controller (6x Optical Zoom & 8x Digital Zoom).
  - ※ When using the Enlarge and Minimize buttons, the blue gauge indicates the optical zoom portion while the red indicates digital.
  - ※ Holding down on the Enlarge button no longer enlarges an object once the 6x optical zoom gauge is at 6x. To zoom further with the digital zoom, press the Enlarge button once more. This also applies to zooming out on an object; to zoom out from the digital to optical zoom, press the Minimize button once more.
  - ※ Using the digital zoom may cause the degradation of image quality.

## Macro Mode

- You can capture documents from extremely close ranges within 1cm to 5cm.
- In the Menu, select ZOOM/FOCUS > MACRO Mode.

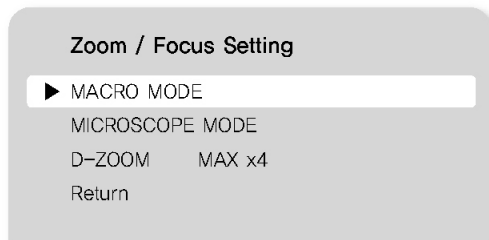

- To check the mode availability, press the AF button 1 to 5cm away from a document.
- cancels the Super Macro Mode.
- ※ In Macro mode, the optical zoom is disabled and only the digital zoom works.

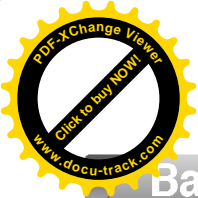

# Basic Operation (Functions)

## Maximizing Digital Zoom (D-Zoom Max)

- ☉ You can select a maximum digital zoom power.
- ☉ In the Menu, select ZOOM/FOCUS > D-ZOOM MAX.

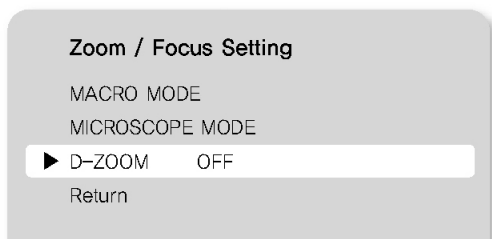



- ☉ Pressing the ► button changes the maximum zoom power to OFF > 4x > 8x.
- ☉ After selecting a D-ZOOM MAX value, press the ◀▶ main unit key in Live mode to check if the zoom value has been applied.

## Adjusting Focus

### Automatic Focus

- ☉ You can auto-focus on the Live mode screen.
- ☉ To auto-focus, press the  button on the control board or remote controller while in Live mode.

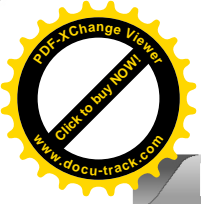

### Manual Focus

- ☉ You can manually focus on the Live mode screen.
- ☉ Press the  button and then ◀▶ to focus on the screen.
- ☉ Press  to finish.





## Basic Operation (Functions)

### ● Adjusting Brightness

- You can use the lens iris to adjust the brightness of an object; if the object is too dark, brighten it, and if it is too bright, darken it.
- To brighten: Press  on the control board or remote controller.
- To darken: Press  on the control board or remote controller.

#### Note

For glossy paper documents, turn off the upper light to use only natural light. For better visual quality, use   or the remote controller's Darken button to lower the brightness, and then adjust the position of the document.

### ● Adjusting the Image

#### White Balance

- You can automatically adjust the color of the Live mode screen.
- In the Menu, select IMAGE ADJUSTMENT > WB Mode.

#### IMAGE ADJUSTMENT

▶ WB Mode	AWB (KEY)
DNR	AUTO
Rotation	0
IMG Mode	CUSTOM
Return	

- Pressing the ▶ button changes the White Balance mode to ATW (Auto Tracking) > AWB (KEY) > MANUAL WB.
  - Auto Color Adjustment Method 1: AWB (KEY)
    - Automatically adjusts the color of the Live mode screen.
    - Select AWB (KEY), and then press the  button on the Live screen.

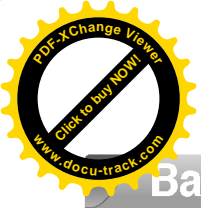

# Basic Operation (Functions)

- Select AWB between MF and AWB.

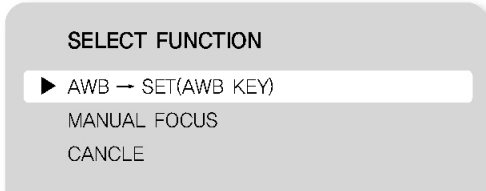

- Press  to adjust the color automatically.
- Save the settings and then exit to the Live screen.
- Auto Color Adjustment Method 2: ATW (Auto Tracking)
  - Automatically adjusts WB mode when the color temperature of a light source changes.
  - Select ATW (Auto Tracking).
  - Save the settings and then exit to the Live screen.
- How to Adjust Color Manually
  - Adjust the RED and BLUE gains manually to adjust the WB mode.
  - Select MANUAL WB.
  - Use the Up, Down, Left, and Right buttons to select a value.
  - Save the settings and then exit to the Live screen.

## Noise Reduction (DNR)

- ⦿ DNR stands for Digital Noise Reduction that uses 2D/3D noise filtering to achieve clear images.
- ⦿ In the Menu, select IMAGE ADJUSTMENT > DNR.

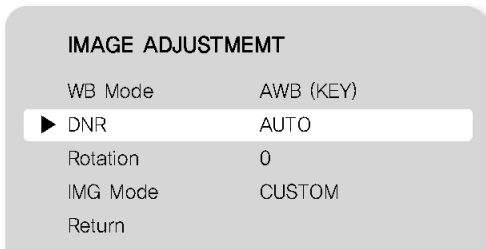

- ⦿ Pressing the ► button changes the Noise Reduction mode to OFF > AUTO > MAX.
  - AUTO: Automatically controls the NR amount depending on the lighting conditions.
  - MAX: Always keep the maximum NR amount.
  - ※ Selecting Auto may cause afterimages if there are many movements on one screen.

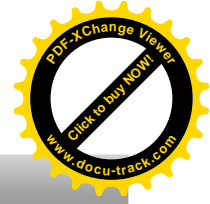
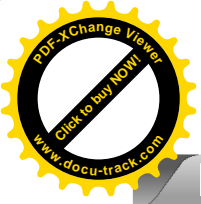

## Basic Operation (Functions)

### Rotating Image

- You can rotate images on the screen.
- In the Menu, select IMAGE ADJUSTMENT > Rotation.

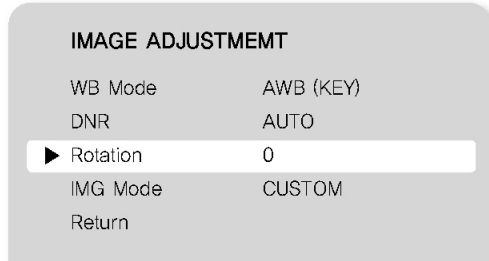

- Pressing the ▶ button brings up a screen that rotates an image from 0° to 180°.
- While rotating, press Screen Capture to save the image at the current rotation angle.

### Image Outline Adjustment (IMG Mode)

- This mode optimizes visual quality according to projection types.
- In the Menu, select IMAGE ADJUSTMENT > IMG Mode.

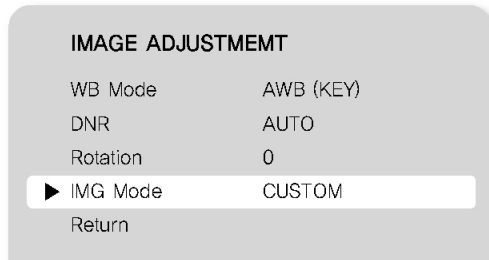

- Pressing the ▶ button changes to TEXT > IMAGE > CUSTOM.
- TEXT Mode: Optimizes the screen for documents with dense text.
- IMAGE Mode: Optimizes the screen for pictures and videos.

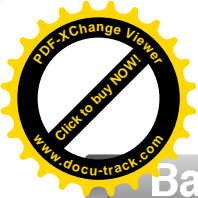

# Basic Operation (Functions)

When selecting CUSTOM Mode, the following sub menus appear.

CUSTOM IMAGE SETTING	
▶ TONE	LOW
COLOR	MIDDLE
SHARPNESS	HIGH
Return	

- ▶ TONE: Changes the gamma value of luminance. Pressing the ▶ button changes to Very LOW > LOW > NORMAL > HIGH > Very HIGH.
- ▶ COLOR: Change the gain. Pressing the ▶ button changes to LOW > MIDDLE > HIGH.
- ▶ SHARPNESS: Changes the sharpness of images (outline adjustment value). Pressing the ▶ button changes to LOW > MIDDLE > HIGH.

## Preset Setting

- You can save zoom and focus positions and brightness levels as presets.
- In the Menu, select PRESET SETTING.

PRESET SETTING	
Preset-EXE	PRESET1
▶ Preset-SAV	PRESET1
BOOT PRESET	OFF
Return	
P1: z: -11, F:1271, B:60	
P2: z: -11, F:1271, B:60	
P3: z: -11, F:1271, B:60	
P4: z: -11, F:1271, B:60	

Operation

- Select Preset-SAV, and then press the ▶ button to enter the current settings to a preset number.
  - To check the availability of the number, whether or not the number already contains a preset, select Preset-EXE in the menu, and then press the ▶ button.
  - The BOOT Preset menu automatically applies saved settings when turning on the projector.
- ※ Up to 4 presets can be saved.

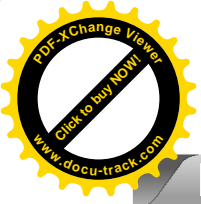

# Basic Operation (Operation)

## • Capturing Images & Videos

### Capture

- For screen captures, the image format and resolution can be configured.
- In the Menu, select CAPTURE SETTING.

CAPTURE SETTING	
▶ PIC Format	JPEG
JPG Quality	FINE
MOV Quality	STANDARD
MIC Mute	OFF
TIME ELAPSE	OFF
RESET FILE NUMBER	
Return	

- Selecting Capturing Image Format (PIC Format)
  - Press the ▶ button to select a format. Still image formats switch between JPEG > BMP.
- Selecting Image Resolution (JPG Quality)
  - Press the ▶ button to select a desired resolution. Still image resolutions change to FINE > NORMAL > BEST.
- Selecting Video Resolution (MOV Quality)
  - Press the ▶ button to select a desired resolution. Video resolutions switch between STANDARD > BEST.
- Enabling Mic (MIC Mute)
  - Press the ▶ button to use the Mic Mute option: OFF or ON.
- Time Elapse Setup (TIME ELAPSE)
  - Press the ▶ button to select a video recording duration from 5 minutes to 1 hour.
- Resetting Filename (RESET FILE NUMBER)
  - Resets the filename of an image or video capture.

### Caution

If an inserted SD card contains the same filename, the old file may be deleted. Please back up the SD card data before using this option.

- Press the Ⓜ button to reset the filename of an image or video capture.



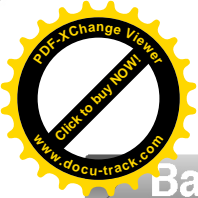



# Basic Operation (Functions)

## Capturing Images

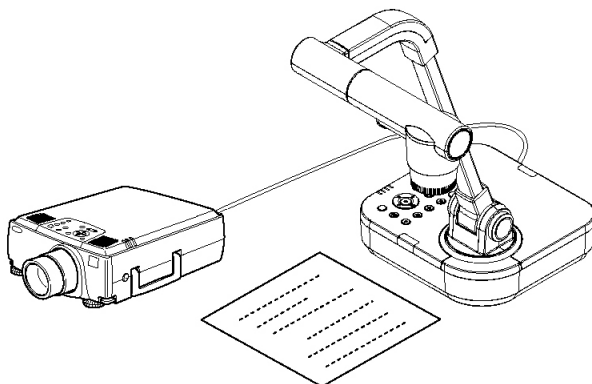
1. Install the digital presenter as instructed in this manual. **P.15**



2. Insert an SD card.
  3. To capture an image, press the  button on the control board or remote controller.
- ※ Once the image is captured, the screen goes back to Live mode.

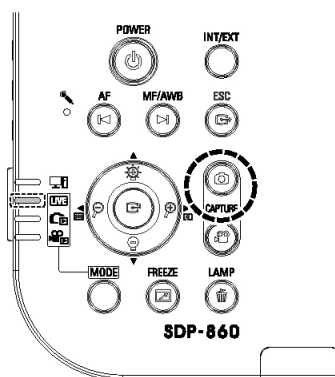

4. To check the captured image, press the  button to enter Picture List mode.

## Basic Operation (Operation)

### 5. Picture List Mode:

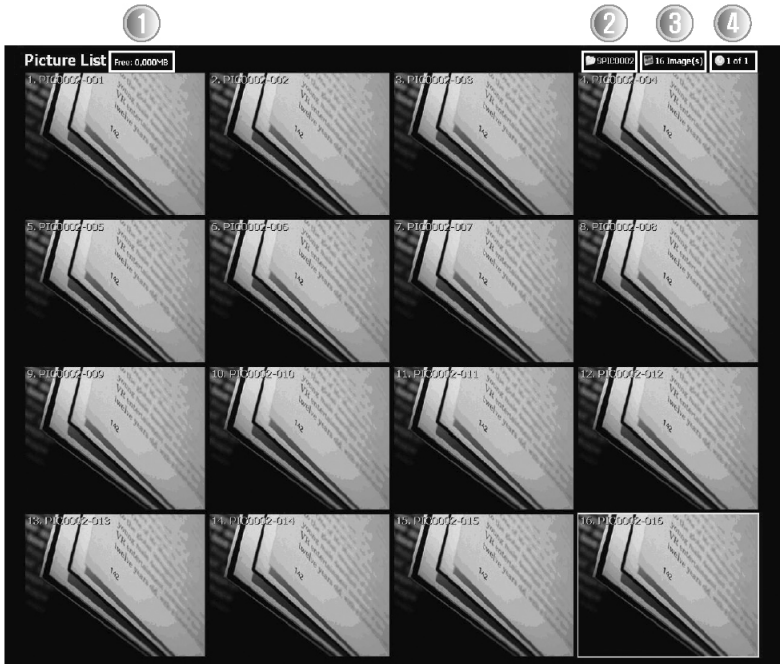

#### - Screen Description

- ① Indicates remaining free space of the current SD memory card.
- ② Indicates the current folder name.
- ③ Indicates the number of images in the current folder.
- ④ Indicates the current page and total pages in the current folder.

6. Press the ▲▼◀▶ buttons to select an image.  
(To move between pages, use the ◀ ▶ buttons.)



## Basic Operation (Operation)

7. Press or to check the captured image.

※ Full Screen

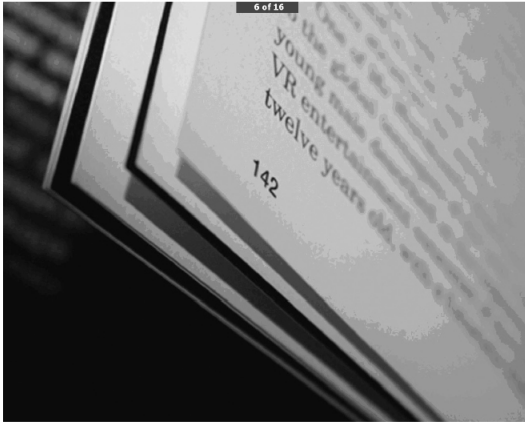

- While in full screen mode, use the Left and Right keys to move between images.
  - The AF button moves to the first file in the folder. The AWB button moves to the last file in the folder.
  - To exit full screen to Picture List mode, press the button.
8. To delete an image, select the image, and then press .

# Basic Operation (Operation)

## Capturing Video

1. Install the digital presenter as instructed in this manual.  
 ※ To record audio, connect a mic. **P.15**

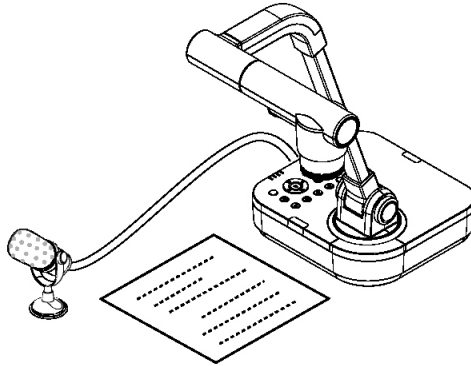

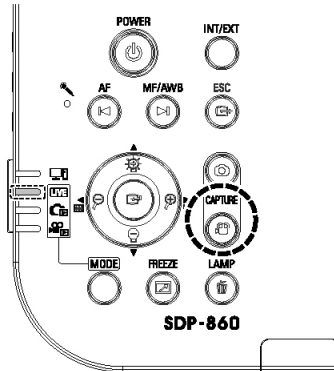

2. When the control board or remote controller is turned on, the projector activates LIVE mode (**LIVE**).





3. Insert an SD card.
4. To capture video, press the **CAPTURE** button on the control board or remote controller.  
 ※ While capturing video, the filename and running time display on the bottom of the screen.  
 If the video recording duration (TIME ELAPSE) is set, the remaining time displays instead of the running time.

## Basic Operation (Operation)

5. To finish capturing and go back to Live mode, press the  button.
6. To finish capturing and check the captured video, press the  button and enter Movie List mode.
7. Movie List Mode



- ① Indicates remaining free space of the current SD memory card.
- ② Indicates the current folder name.
- ③ Indicates the number of videos in the current folder.
- ④ Indicates the thumbnail of a selected video.

8. Press the  buttons to select a video.  
(To move between pages, use the   buttons.)

## Basic Operation (Operation)

9. Press  to play the captured video.

※ Playback Screen

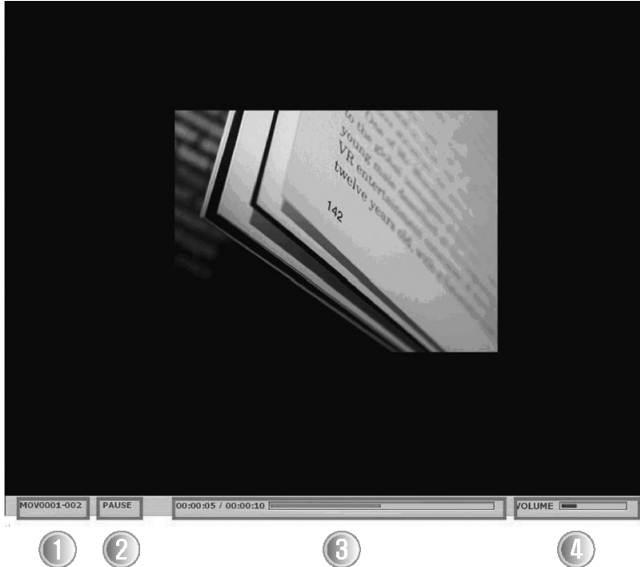

- Video is played at the original 640x480 size.
- The Left and Right keys play video 10 seconds forward or backward.
- To stop playing and go back to the Movie List, press the  button.
- Screen Description

- ① The file that is currently being played
- ② Playback Status (PLAY / PAUSE)
- ③ Video Running Time
- ④ Volume

※ For the Playback screen controls, refer to Control Board/Remote Controller Functions.  P.13

10. To delete a video, select the video, and then press .

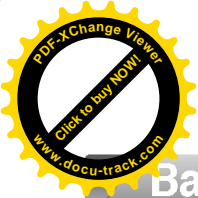

# Basic Operation (Operation)

## • Freeze Mode Settings & Operation

In the Menu, select ZOOM/FOCUS > MICROSCOPE Mode.

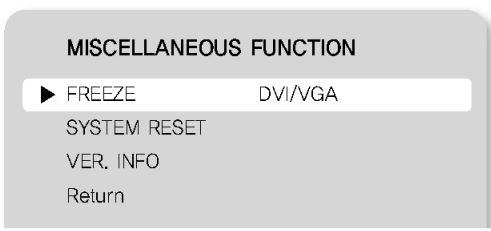

Select DVI/VGA or ONLY DISPLAY mode.

DVI/VGA Mode:

- The Freeze button pauses only video that is connected to a DVI/VGA output. It also plays external video, connected via USB, on the Live screen.

**Caution**

When capturing video, the Live screen is captured, not the Freeze screen.

ONLY DISPLAY Mode:

- The Freeze button pauses videos that are connected both from a DVI/VGA output and via USB.
- When capturing video, the Freeze screen is captured.

Operation

## • Microscope Mode

- ⦿ Attach a microscope adapter lens to the digital presenter lens part.

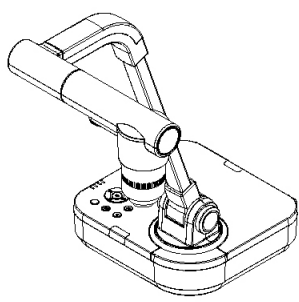

## Basic Operation (Operation)

- Bring the microscope adapter lens to the ocular part of the microscope that is properly focused, as close as possible. Adjust the position of the digital presenter to bring the circular image of an object in the center of the monitor.

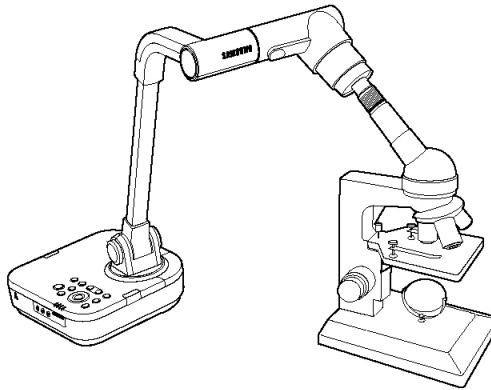

- In the Menu, select ZOOM/FOCUS > MICROSCOPE Mode.

### Zoom / Focus Setting

MACRO MODE

▶ MICROSCOPE MODE

D-ZOOM OFF

Return

- Check if the screen is focused properly. If not, adjust the micromanipulator of the microscope to refocus. Check if the screen is now focused.

- To cancel Microscope mode, press the button.

### ※ Ultra Macro Mode:

- When used in conjunction with an adapter lens, the projector can capture the screen at an extremely close range within 1cm.



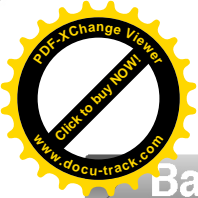

# Basic Operation (Operation)

## • System Reset

- Resets all current settings.
- In the Menu, select SPECIAL FUNCTION > SYSTEM RESET.

**Caution** This System Reset menu automatically executes Reset File Number under the Capture Settings. Please back up your SD card data before using this.

- Press the button to reset the system.



## • Checking System Version Information (VER. INFO)

- Displays the current system version of the product.
- In the Menu, select SPECIAL FUNCTION > VER.INFO.



Operation

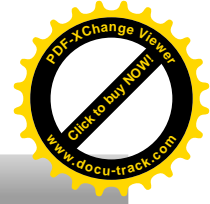
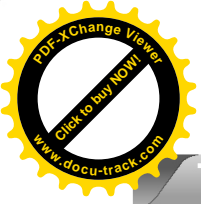

# Troubleshooting

Error	Solution
<b>Video doesn't display.</b>	<p>Please make sure that the resolution of the projector and product main unit are matched. (e.g. If the projector's resolution is set to the maximum SVGA while the main unit is XGA or SXGA, the screen cannot display video.</p> <ul style="list-style-type: none"><li>• Check if the output device is connected with a proper input type.</li><li>• Check if the screen is properly adjusted for brightness and focus.</li></ul> <p style="text-align: right;"><b>P.25</b></p>
<b>The projector doesn't communicate with a PC when connected via USB.</b>	<ul style="list-style-type: none"><li>• Check if the PC is installed with the SDP-860 program properly.</li><li>• Check if the PC operating system is Windows XP or higher. Older versions of the operating system may cause operational errors.</li><li>• For more detailed information about the SDP-860 program, please refer to the included manual.</li></ul>
<b>The remote controller doesn't work.</b>	<ul style="list-style-type: none"><li>• Check the remote controller's batteries. Replace with new ones if necessary.</li></ul> <p style="text-align: right;"><b>P.43</b></p>

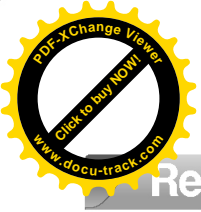

# Replacing Remote Controller Batteries

1. Remove the battery lid on the back of the remote controller.

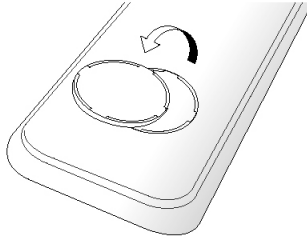

2. Insert batteries matching the + and - signals. (Battery Type: CR-2025)

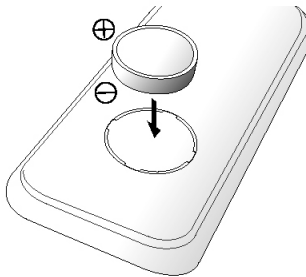

3. Close the lid.

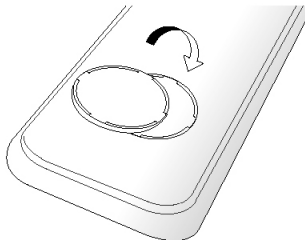

## Caution

Random replacement of built-in battery by other types of batteries may cause explosion. The battery shall be replaced by the same battery. The used batteries shall be disposed carefully because they can cause environment pollutions.

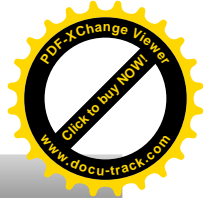
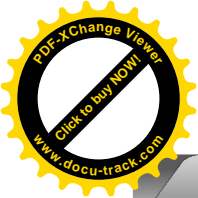

# Product Specifications

The following specifications are subject to change and upgrade without prior notice.

<b>SDP-860</b>		
<b>OPTICAL SYSTEM</b>		
Lens	F = 2.5(Wide) ~ 3.12(Tele), f = 4.1~ 24.6mm, 6X Zoom Lens	
Shooting Area	Max: 420 x 336mm	
Zoom	48X Zoom(Optical 6X / Digital 8X)	
Focus	Auto focus / Manual	
Iris	Auto (with fine level adjustment)	
<b>VIDEO</b>		
Pick-up Device	1/3" PS CMOS Sensor	
Total Number of Pixels	1,384(H) x 1,076(V), 1.49M pixels	
Number of Effective Pixels	1,329(H) x 1,049(V), 1.39M pixels	
Frame Rate	SXGA: 30fps	
VGA Output	SXGA (1,280 x 1,024), XGA (1,024 x 768), UXGA (1,600 x 1,200), HD (1028 x 720p) Full HD (1,920 x 1,080p)	
Resolutions	H: 700 TV Lines / V: 700 TV Lines	
<b>FUNCTIONS</b>		
White Balance	ATW / AWC(One-touch) / Manual	
Aperture Function	Image Mode / Text Mode / Custom Mode	
Noise Reduction	Available (Low Light presenter with 2D / 3D NR)	
Preset Function	Up to 4 User settings	
Image Freeze	Available	
Image Rotation	Available (180 degree)	
Image Save	Photo	MPEG-4 640 x 480@30fps with Audio (Mic)
	Movie	SDHC card (Up to 32GB)
Image Playback	Photo	4 x 4(16 Split)
	Movie	Internal Movie Player
USB	USB 2.0	
Input Selection	2 Channels (Internal: 1, External: 1)	
Illumination	LED Illumination System	
<b>INTERFACE</b>		
Input Port	VGA In	15 Pin DSUB Connector x 1
	Audio In	φ3.5 Jack x 1 (Built-in Microphone)
Output Port	VGA Out	15 Pin DSUB Connector x 1
	DVI Out	DVI Connector x 1
	Audio Out	φ3.5 Jack x 1
I/F Port	RS-232C	φ3.5 Jack x 1
	USB	USB B-type x 1
	Memory	SD Slot x 1
Power Port	12V DC In x 1	
<b>GENERAL</b>		
Operating Temperature	+5°C ~ +35°C	
Operating Humidity	30% ~ 90%	
Power	12V DC (Adaptor Input: 100V AC ~ 240V free voltage, 50/60Hz, Output: 12V, 4A)	
Dimensions	In-use 374(W) x 449(H) x 431(D)mm / 14.72"(W) x 17.68"(H) x 16.97"(D)mm	
Weight	3.7kg (8.16lb)	
Accessories	Supplied Accessories	Remote Controller, USB cable, DVI cable, VGA cable
	Optical Accessories	Microscope adaptor lens RS-232C cable, SD card

Miscellaneous  
(Appendix)

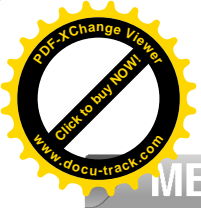

# MEMO

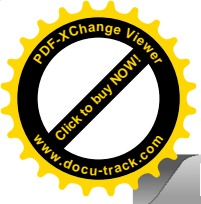

# MEMO

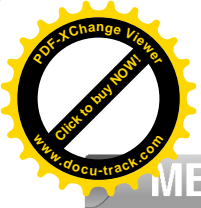

# MEMO

A large, empty rectangular area with rounded corners, intended for writing a memo.