



Measuring Instruments for Temperature



°C



Contents

Measurement technology

Measurement technology for temperature measurement	4
Infrared temperature measurement and its applications	8

Measuring instruments

Practical measuring instruments for contact measurements		Page
Thermometer strips	Self-adhesive foils	10
Clock indicators	Self-adhesive foils	10
Single indicators	Self-adhesive foils	11
Mini thermometer	Mini penetration thermometers	12
Mini thermometer	Mini surface thermometer	12
testo 905-T1	Penetration thermometer	13
testo 905-T2	Surface thermometer	13
Mini alarm thermometer	Mini thermometer with penetration probe and alarm	14
testo 103	The smallest folding temperature measuring instrument	15
testo 104	The first folding and waterproof temperature measuring instrument	16
testo 106	The Compact Food Thermometer With Alarm	17
testo 105	Robust one-hand thermometer	17
testo 110	Multi-Purpose Highly Accurate Monitoring Thermometer	18
testo 112	Calibratable Temperature Measuring Instrument	20
testo 926	Fast, Accurate All-Round Thermometer	22
testo 925 / testo 922	Fast Temperature Measurement with Wide Measurement Range	24
Ex-Pt 720	Highly accurate Ex-Pt thermometer	27
testo 720	Accurate Temperature Measurement	28
testo 735	Highly accurate temperature measuring instrument with data memory	30
testo 950	Highly accurate reference measuring instrument	34
Practical measuring instruments for non-contact measurements		Page
testo 810	Air temperature and infrared surface temperature in one instrument	41
testo 830-T1	Fast infrared thermometer with laser sighting (10:1 optics)	41
testo 830-T2	Infrared thermometer with 2-point laser sighting and probe socket (12:1 optics)	42
testo 830-T4	Infrared thermometer with 2-point laser marking and probe socket (30:1 optics)	43
testo 830-T3	Non-contact temperature measurement with close focus optics (2.51 optics)	44
testo 845	Infrared Thermometer with Switchable Optics (far-field/close focus)	45
testo 875 / 876 / 881 / 882	See more with the thermal imagers from Testo	48
testo 805	Mini infrared thermometer, pocket-size (1:1 optics)	60
testo 826-T1	Infrared food thermometer (6:1 optics)	61
testo 826-T2	Infrared food thermometer with laser sighting (6:1 optics)	61
testo 826-T3	Infrared thermometer with penetration probe (6:1 optics)	62
testo 826-T4	Infrared thermometer with penetration probe and laser sighting (6:1 optics)	62
testo 831	Distance thermometer for infrared monitoring measurements in the food sector (30:1 optics)	63
Measurement Data Monitoring System		Page
testo Saveris™	Measurement Data Monitoring System	64
Data loggers		
testo 174T	Mini data logger	72
testo 175 T1	Compact data logger	73
testo 175 T2	Compact data logger with internal sensor and probe connection	74
testo 175 T3	2 external temperature probe sockets	75
testo 176 T1	Data logger (in metal housing) with highly accurate temperature sensor	76
testo 176 T2	2 external temperature probe inputs	77
testo 176 T3	Data logger (in metal housing) with 4 external temperature probe inputs	78
testo 176 T4	Data logger with 4 external temperature probe inputs	79
Logger software	The right logger software for every application	80

Stationary measurement engineering

Stationary temperature probes	Overview standard probes	84
Configurator "Testo Celsius" on the internet	Temperature probe selection made easy	86
Custom temperature probes		89

Option: Radio

Overview	Radio probes for testo 110, testo 926, testo 922, testo 925, testo 735	87
Ordering data	Radio probes for testo 110, testo 926, testo 922, testo 925, testo 735	88

Sensor type selection

The probe type is determined by the measurement task. The selection of the most suitable temperature sensor is made according to the following criteria:

- Measurement range
- Accuracy
- Measurement site design
- Reaction time
- Durability

In order to be able to provide the right probe for your requirements, Testo offers a large selection of sensor elements and temperature measuring instruments:

- Thermocouples
- Resistance sensor (Pt100)
- Thermistors (NTC)

Thermocouples

Temperature measurement with thermocouples is based on the thermoelectric effect. Thermocouples consist of two wires spot-welded to each other and made of different metals or metal alloys. The basic values of the thermoelectric voltages and the permitted tolerances of thermocouples are defined in the norms IEC 584. The most common thermoelement is NiCr-Ni (type designation K).

Resistance sensors (Pt100)

When measuring temperature with resistance sensors, use is made of the temperature sensitive resistance change in the platinum „resistance“.

The measurement resistance is supplied with a constant current and the voltage drop, which changes with the resistance value via the temperature, is measured. Basic values and tolerances for resistance thermometers are defined in the IEC 751.

Thermistors (NTC)

Temperature measurement with thermistors is also based on a temperature-dependent change of resistance in the sensor element. Contrary to resistance thermometers, thermistors have a negative temperature coefficient (resistance becomes smaller with increasing temperature). Characteristic curves and tolerances are not normed.

Temperature measurement thermocouples

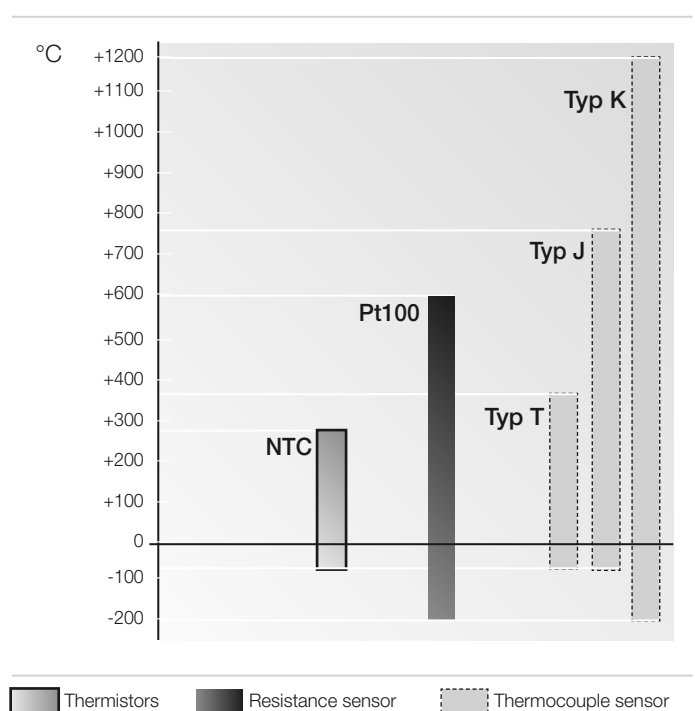

Accuracy data

Measurement value sensor	Temperature range	Class	Permitted tolerances	
			fixed value	Referred to temperature
Thermocouple	-40 ... +1000 °C	1	±1.5 °C	±0.004 • Itl
Typ K (NiCr-Ni)	-40 ... +1200 °C	2	±2.5 °C	±0.0075 • Itl
	-200 ... +40 °C	3	±2.5 °C (-167 ... +40 °C)	±0.015 • Itl (-200 to -167.1 °C)
Typ T	-40 ... +350 °C	1	±0.5 °C	±0.001 • Itl
Typ J	-40 ... +750 °C	1	±1.5 °C	±0.004 • Itl
Pt100	-200 ... +600 °C	B	± (0.3 + 0.005 • Itl)	
	-200 ... +600 °C	A	± (0.15 + 0.002 • Itl)	
NTC (Standard)	-50 ... -25.1 °C		±0.4 °C	
	-25 ... +74.9 °C	-	±0.2 °C	
	+75 ... +150 °C		±0.5 % of full scale value	
NTC (High temp.)	-30 ... -20.1 °C		±1 °C	
	-20 ... 0 °C		±0.6 °C	
	+0.1 ... +75 °C		±0.5 °C	
	+75.1 ... +275 °C	- °C	±0.5 °C ±0.5 % of full scale value	

Itl = measurement temperature value

Data for thermocouples according to EN 60584-2 (formerly IEC 584-1).

Data for Pt100 according to EN 60751 (formerly IEC 751). No standardization exists for NTC sensors.

Accuracy thermocouples

Data for thermocouples to EN 60584-2 (formerly IEC 584-1). Two values are given, one fixed value in °C and one formula. The larger value always applies.

For thermocouples of Class 1, the accuracies are specified for the measuring range -40 to +1000°C.

For thermocouples of Class 2, the accuracies apply for the measuring range -40 to +1200 °C

For thermocouples of Class 3, the accuracies apply for the measuring range -200 to +40.1 °C

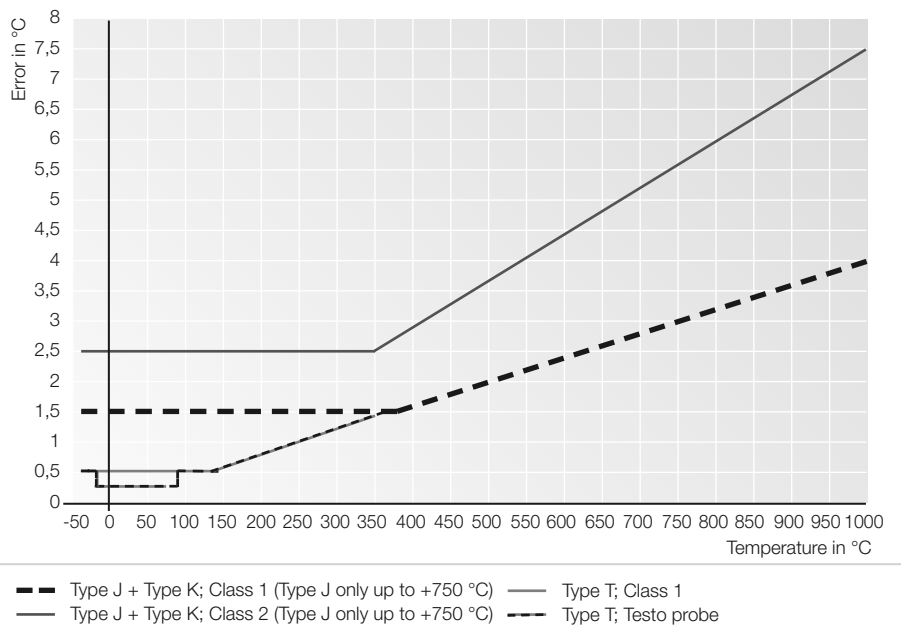

Accuracies Pt100/NTC

Data for Pt100 according to EN 60751 (formerly IEC 751). No standardization exists for NTC measurement values sensors.

In addition to fast and reliable thermocouple probes, Pt100 probes according to EN 60751 (formerly IEC 751) or selected high-precision probes based on Pt100 with 1/10 DIN accuracy are also available. These would precision sensors are 10 times more accurate than „normal“ Pt100 sensors, which are already very accurate. Applied to Class B, whose error is $\pm 0.3 + 0.005 \times I$ temperature I, this means an error of only $\pm 0.03 + 0.0005 \times I$ temperature I.

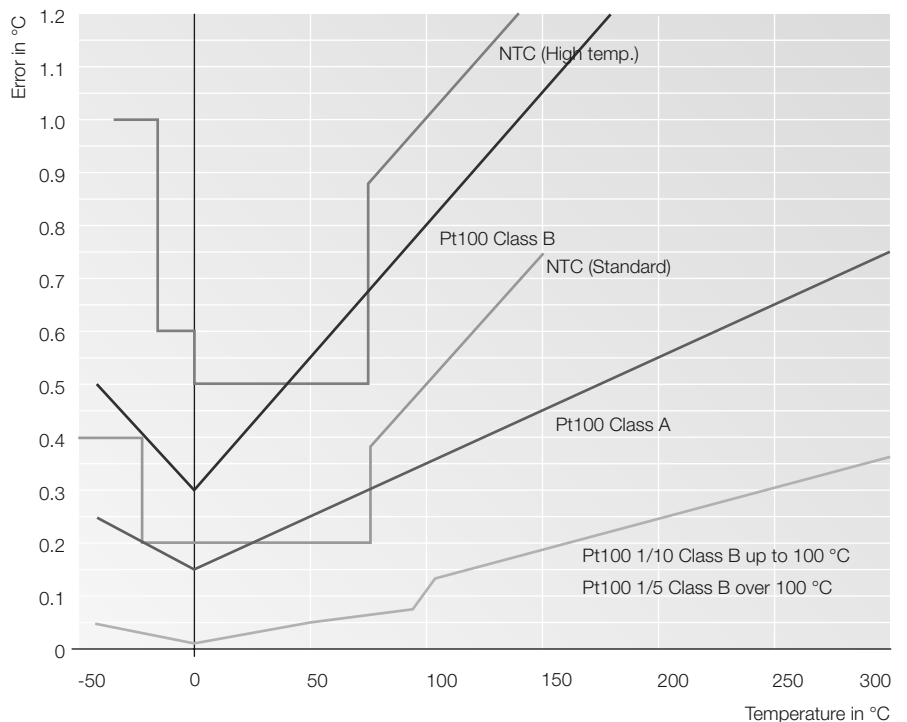

Probe design selection

Reaction time

t_{99} -Time = Time until probe shows 99% of temperature change

$t_{99} = 4.6 \times t_{63}$ - Time

$t_{99} = 2 \times t_{90}$ - Time

Immersion-penetration probe



Immersion probe (NiCr-Ni, Pt100, NTC) for measurements in liquids, but also for measurements in powdery substances or in air.



Penetration probes (NiCr-Ni, Pt100, NTC) for measurements in plastic or paste-like media.

Information

- The specified reaction time t_{99} is measured in moving liquid (water) at 60 °C.
- Generally, the thinner the probe, the faster it is and the shallower the necessary immersion depth into the measurement object.
- In order to be able to assume the real temperature of the measurement object, the probe must be immersed into the measurement object at least 10 x the diameter of the probe (better still 15 x diameter).
- However: The thinner the probe, the more carefully it has to be handled.
- Thermocouple probes can be manufactured with a very small diameter (0.25 mm) and are therefore ideal for fast measurements and measurements made on small objects.
- Resistance sensors can be manufactured at low cost with a diameter of 2 mm, but are usually more accurate than thermocouple probes.

Durability

The probe shaft of thermocouple probes is made of Inconel (2.4816). In all other designs, stainless steel V4A (1.4571) is used for the probe shaft. The high quality material used generally ensures sufficient resistance to corrosive substances. Testo offers glass-coated probes for applications in highly corrosive media.

Air probes

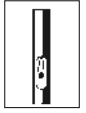

(NiCr-Ni, Pt100, NTC)

In order to enable fast measurement, the sensor usually lies bare.

- The specified reaction time t_{99} is measured in a wind tunnel at 2 m/s and 60 °C.
- Immersion/penetration probes can also be used for air measurements. However, the reaction time is 40 to 60 times higher than the specified value which was measured in water.

Surface probes

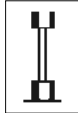

Design in NiCr-Ni, Cu-CuNi; Pt100; NTC probes. With a widened measurement tip for measurements on smooth, flat surfaces. For optimum heat transfer we recommend silicone conductive paste (Tmax 260 °C)

Advantage:

- Robust design
- Higher sensor accuracy

Disadvantage:

- Long reaction time
- Requires exact handling

Only suitable for smooth surfaces and objects with a high heat capacity, e.g. large metal objects.

Information

- The specified reaction times t_{99} are measured on polished steel or aluminium plates at 60 °C.
- The specified accuracies are sensor accuracies.
- The accuracy in your application is dependent on the surface texture (roughness), the material of the measurement object (heat capacity and heat transfer) as well as the sensor accuracy. Testo provides the corresponding calibration certificate for the deviations of the measurement system in your application. For this purpose, Testo uses a surface test rig developed in cooperation with the German Federal Physical and Technical Institute (PTB).



Design in NiCr-Ni probes

Our recommendation for fast measurements, also on rough surfaces: Use the patented cross-band measurement head with a sprung thermocouple band. The cross-band takes on the actual temperature of the measurement object in only a few seconds:

- Easy handling
(without silicon heat conductive paste)
- Fast measurement result

What is heat radiation?

Principles

It is a well-known fact in daily life that all bodies emit electromagnetic waves, or radiation, depending on their temperature. During dispersion of the radiation, energy is transported, a fact which means that radiation can be used to measure body temperature without contact. The radiated energy and its characteristic wavelengths are primarily dependent on the temperature of the radiating body. If, for example, you point a parabolic mirror with a match directly towards the sun, then it will ignite after a short period of time.

This is because of the heat radiation from the sun, which is concentrated by the parabolic mirror onto a point.

Examples of heat radiation

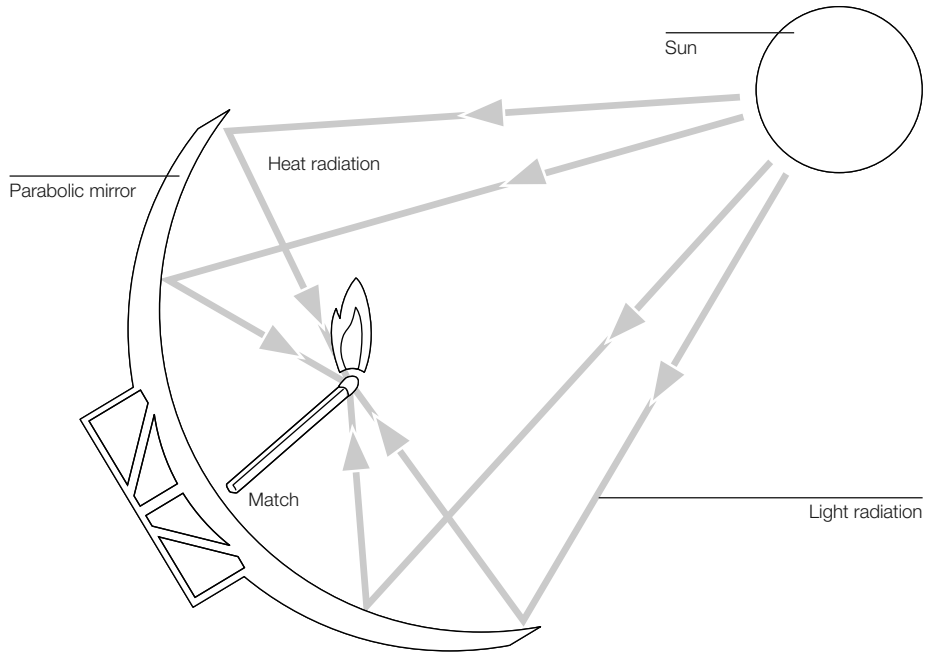

Advantages of IR measuring technology

- > Infrared measuring technology enables simple temperature recording of fast, dynamic processes. This is assisted by the short reaction time of sensors and systems.
- > No influence on the object being measured means that measurements can be performed on sensitive surfaces and sterile products, just as well as measurements on hazardous points or points that are difficult to access.

Infrared thermometers are particularly suitable for:

- > Poor heat conductors, such as ceramics, rubber, plastics etc. A probe for contact measurement can only display the correct temperature if it can take on the temperature of the measured body. In the case of poor heat conductors, this is not usually the case and/or the response times are very long.
- > Determining the surface temperature of gears, housings and bearings in large and small motors.
- > Moving parts, e.g. running paper webs, running sheet metal tracks etc.
- > Parts which cannot be touched, e.g. freshly painted parts, sterile parts or for corrosive substances.
- > Measuring very small and very large areas.
- > Live parts, e.g. electrical components, conductor rails, transformers etc.
- > Small and low-mass parts from which a contact probe would remove too much heat thus resulting in incorrect readings.

Applications and practical tips

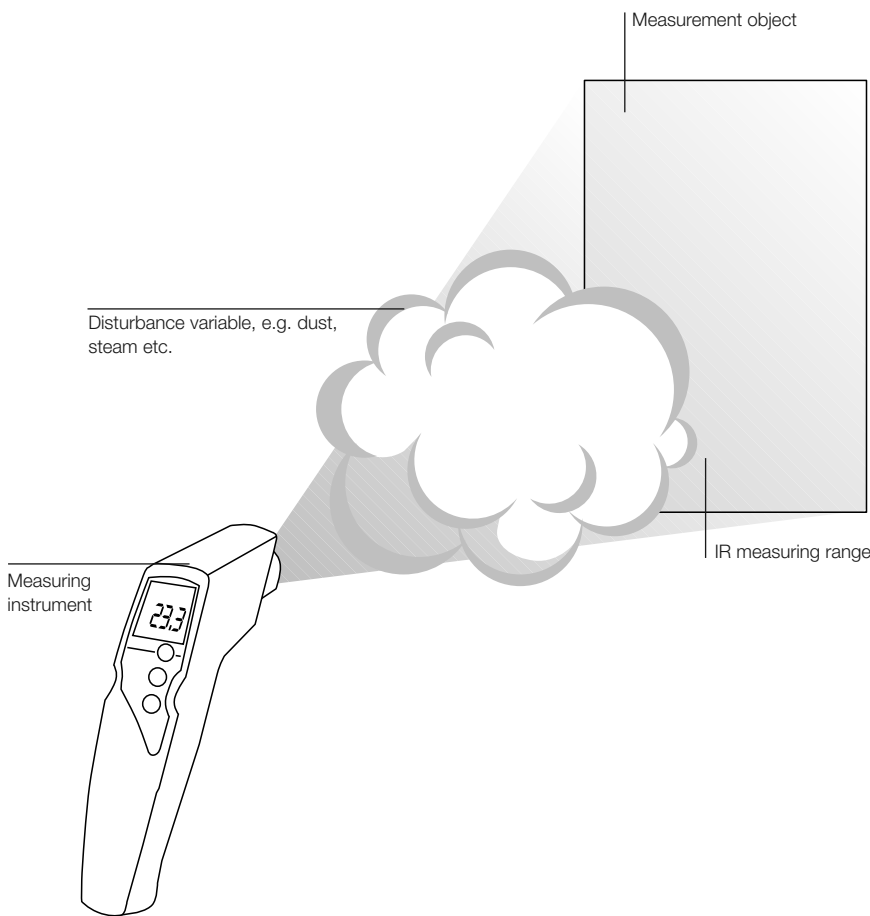

Emissivity table of important materials

Material	Temperature	E
Aluminium, bright-rolled	170 °C	0,04
Cotton	20 °C	0.77
Concrete	25 °C	0.93
Ice, smooth	0 °C	0.97
Iron, polished	20 °C	0.24
Iron with cast skin	100 °C	0.80
Iron with rolled skin	20 °C	0.77
Gypsum	20 °C	0.90
Glass	90 °C	0.94
Rubber, hard	23 °C	0.94
Rubber, soft grey	23 °C	0.89
Wood	70 °C	0.94
Cork	20 °C	0.70
Heat sink, black anodised	50 °C	0.98
Copper, lightly tarnished	20 °C	0.04
Copper, oxidised	130 °C	0.76
Plastics (PE, PP, PVC)	20 °C	0.94
Brass, oxidised	200 °C	0.61
Paper	20 °C	0.97
Porcelain	20 °C	0.92
Black paint (matt)	80 °C	0.97
Steel (heat-treated surface)	200 °C	0.52
Steel, oxidised	200 °C	0.79
Clay, fired	70 °C	0.91
Transformer paint	70 °C	0.94
Brick, mortar, plaster	20 °C	0.93

Error sources with infrared measurement

In the case of non-contact temperature measurement, the composition of the transmission path between the instrument and the object being measured can also have an effect on the measured result.

Disturbance variables include, e.g.

- Dust and dirt particles
- Moisture (rain), steam, gases

> Only measure if there are no disturbing variables

Incorrectly set, or too low emissivities can lead to significant errors.

- > Set emissivity using emissivity table or check via contact probe. A coating e.g. paint, oil or emission adhesive tape with a defined emissivity must be applied to the object being measured in the case of non-contact measurement on objects with low emissivity.

The measuring instrument is not yet acclimatized to the new temperature after a temperature change (cold junction). This can lead to significant errors.

- > If possible, store the instrument in the place where the measurement is to be performed. This will avoid the problem of adjustment time (but observe instrument operating temperature).

IR measurement is a purely optical measurement:

- > Clean lens is essential for accurate measurement.
- > Do not measure with fogged-up lens, e.g. due to steam

IR measurement is surface measurement

- > Always make sure that the surface is clean. If there is dirt, dust, grime etc. on the surface, only the top layer will be measured.

- > Do not measure at occlusions (e.g. in packaging)

Distance between IR measuring instrument and object being measured too far - measuring spot is bigger than object.

- > Keep distance between instrument and object being measured as small as possible.

Thermometer strips

testoterm thermometer strips are self-adhesive foils with temperature sensitive elements for temperature control and regulation. Used, for example, for measurements on moving parts, for long-term monitoring and on small parts.

+37 to +65 °C
Part no. 0646 0108
+71 to +110 °C
Part no. 0646 0916
+116 to +154 °C
Part no. 0646 1724
+161 to +204 °C
Part no. 0646 2532
+204 to +260 °C
Part no. 0646 3341
+249 to +280 °C
Part no. 0646 0005

Self-adhesive foils

- Irreversible change in colour within 2 seconds
- Practical booklet with 10 thermometer strips
- Thermometer strips available on rolls, from 5000 off

Technical data

Accuracy: From +43°C to +154°C: $\pm 1.5^\circ\text{C}$; from +160°C: $\pm 1\% \pm 1^\circ\text{C}$ of respective temperature reading
 Max. operating temperature corresponds to the respective measuring ranges
 Storage of clock indicators: Up to +65°C, max. 9 months; other measuring ranges: up to 2 years; max. storage temperature +25°C. Storage in a refrigerator is recommended.
 l x w: 50 x 18 mm or 39 x 18 mm

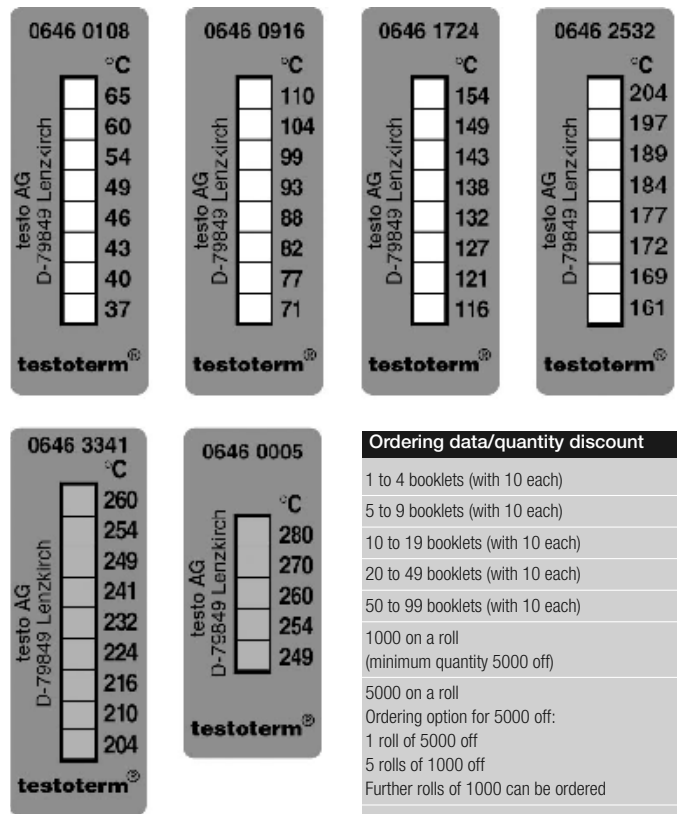

Actual size

Ordering data/quantity discount

1 to 4 booklets (with 10 each)
 5 to 9 booklets (with 10 each)
 10 to 19 booklets (with 10 each)
 20 to 49 booklets (with 10 each)
 50 to 99 booklets (with 10 each)
 1000 on a roll (minimum quantity 5000 off)
 5000 on a roll
 Ordering option for 5000 off:
 1 roll of 5000 off
 5 rolls of 1000 off
 Further rolls of 1000 can be ordered

Clock indicators

testoterm clock indicators are self-adhesive, temperature proof foils with temperature sensitive elements for temperature control and regulation. They are particularly suitable for monitoring temperature in small objects.

+40 to +54 °C
Part no. 0646 0071
+60 to +82 °C
Part no. 0646 0072
+88 to +110 °C
Part no. 0646 0073
+116 to +138 °C
Part no. 0646 0074
+143 to +166 °C
Part no. 0646 0075
+171 to +193 °C
Part no. 0646 0076
+199 to +224 °C
Part no. 0646 0077
+232 to +260 °C
Part no. 0646 0078

Self-adhesive foils



- Irreversible change in colour within 2 seconds
- Practical booklet with 10 clock indicators
- Clock indicators available on sheets from 5000 off (100 sheets of 50 off)

Technical data

Accuracy: From +43°C to +154°C: $\pm 1.5^\circ\text{C}$; from +160°C: $\pm 1\% \pm 1^\circ\text{C}$ of respective temperature reading
 Max. operating temperature corresponds to the respective measuring ranges
 Storage of clock indicators: Up to +65°C, max. 9 months; other measuring ranges: up to 2 years; max. storage temperature +25°C. Storage in a refrigerator is recommended.
 Ø 15 mm

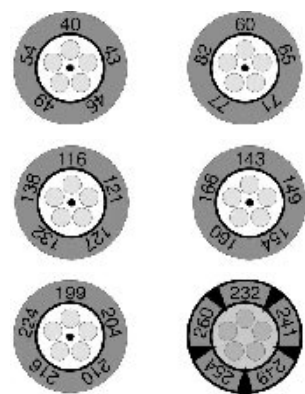

Actual size

Ordering data/quantity discount

1 to 4 booklets (with 10 each)
 5 to 9 booklets (with 10 each)
 10 to 19 booklets (with 10 each)
 20 to 49 booklets (with 10 each)
 50 to 99 booklets (with 10 each)
 1000 on sheets of 50 (Minimum quantity 5000 off)

Single indicators

testoterm single indicators are self-adhesive temperature sensitive foils with elements used for control of a given maximum temperature.

Single indicators

Measuring range: +46°C to +260°C
Part no. 0646 1... (...=reading)

Ordering examples:

Single indicator for +46°C: 0646 1046

Single indicator for +188°C: 0646 1188

- Irreversible change in colour within 1 second
- Practical single indicator booklet
- Single indicators available on rolls of 5000 or sheets

Self-adhesive foils

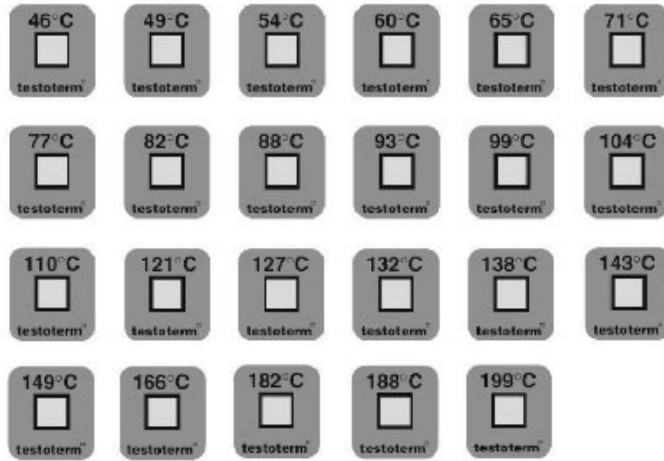

Ordering data/quantity discount

1 to 4 booklets (with 50 each)
5 to 9 booklets (with 50 each)
10 to 19 booklets (with 50 each)
20 to 49 booklets (with 50 each)
50 to 99 booklets (with 50 each)
5000 on rolls or sheets
Ordering option for 5000 off:
1 roll of 5000 off
5 rolls of 1000 off
Further rolls of 1000 can be ordered

In stock:

71 °C, 77 °C, 82 °C, 110 °C, 143 °C

Delivery time of 6 weeks for orders for more than 10 booklets of other single indicators (See Figure).

Technical data

Accuracy: From +43°C to +154°C: $\pm 1.5^\circ\text{C}$;
from +160°C: $\pm 1\% \pm 1^\circ\text{C}$ of respective temperature reading

Max. operating temperature corresponds to the respective measuring ranges

Storage of clock indicators: Up to +65°C, max. 9 months; other measuring ranges: up to 2 years; max. storage temperature +25°C. Storage in a refrigerator is recommended.

Larger quantities – Ask your Testo sales partner for more details.

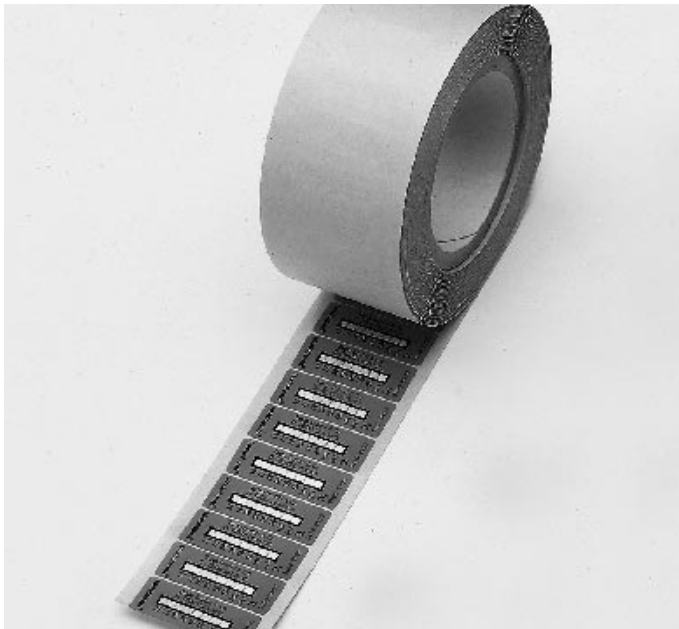

The delivery time for special quantities is 6 weeks.

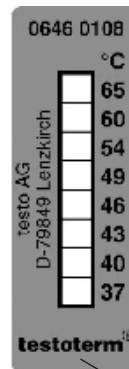

Company name

You can have your company name or logo printed on the testoterm thermometer strips and testoterm single indicators if you order more than 10 000 (per temp. value).

Actual size



Your company name/logo can be printed here

Mini thermometer

The quick-action immersion/penetration thermometer is ideal for measuring the temperature in air, soft or powdery substances and liquids.

1 Mini thermometer, 133 mm long, up to +150°C

with protective sleeve for probe shaft

Part no.

0560 1110

2 Mini thermometer, 213 mm long, up to +250°C

with protective sleeve for probe shaft

Part no.

0560 1111

3 Water-proof mini thermometer

Protective sleeve for probe shaft

Part no.

0560 1112

Quantity discounts available

Mini penetration thermometers

- Easy to read thanks to large display
- Can be used anywhere



Technical data			
	1	2	3
Meas. range	-50 to +150 °C	-50 to +250 °C	-40 to +230 °C
Accuracy	±1 °C (-10 to +99.9 °C)	±1 °C (-10 to +99.9 °C)	±1 °C (-20 to +99.9 °C)
±1 digit	±2 °C (-30 to -10.1 °C) ±2% of mv (+100 to +150 °C)	±2% of mv (+100 to +199.9 °C) ±3% of mv (+200 to +250 °C)	±2% of mv (+100 to +199.9 °C) ±3% of mv (+200 to +230 °C)
Resolution	0.1 °C (-19.9 to +150 °C) 1 °C (remaining range)	0.1 °C (-19.9 to +199.9 °C) 1 °C (remaining range)	0.1 °C (-19.9 to +199.9 °C) 1 °C (remaining range)
Oper. temp.	-10 to +50 °C	-10 to +50 °C	-10 to +50 °C
Battery type	Button cell LR44	Button cell LR44	Button cell LR44
Display	LCD, 1 line	LCD, 1 line	LCD, 1 line
Warranty	2 years	2 years	2 years

Accessories	Part no.
Button cell batteries, Type LR 44, 1.5 Volt (4 off)	0515 0032

Mini thermometer

Affordable. The surface thermometer has a widened measuring tip making it particularly suitable for surface measurements.

Mini surface thermometer with battery

Part no.

0560 1109

Mini surface thermometer

- Easy to read thanks to large display
- Ideal for surface measurements



Technical data	
Meas. range	-50 to +300 °C
Accuracy	±1 °C (-30 to +250 °C)
±1 digit	±2 °C (remaining range)
Resolution	0.1 °C (-19.9 to +199.9 °C) 1 °C (remaining range)
Oper. temp.	-10 to +50 °C
Battery type	Button cell LR44
Display	LCD, 1 line
Warranty	2 years

Accessories	Part no.
Button cell batteries, Type LR 44, 1.5 Volt (4 off)	0515 0032

testo 905-T1
Penetration thermometer

testo 905-T1 is one of the fastest mini-thermometers, with a broad measuring range of -50 to +350 °C short-term (1-2 minutes) up to +500 °C. Especially in the higher measuring range, it has a considerably better accuracy than most thermometers in this price class.

- Broad measurement range
- High accuracy
- Easy readout of measurement value due to rotatable display
- Professional industrial sensor (thermocouple Type K)
- Large, fast display
- High temperature measurement, short-term up to 500 °C

testo 905-T1: penetration thermometer incl. attachment clip, battery

Part no.
0560 9055

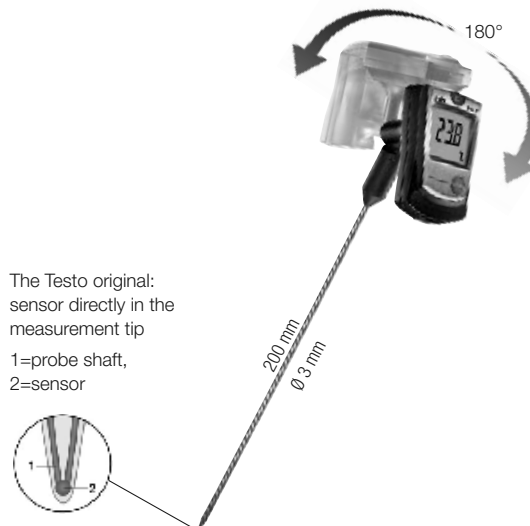

The Testo original: sensor directly in the measurement tip

1=probe shaft,
2=sensor

Technical data

Meas. range	-50 to +350 °C Short-term to +500 °C
Accuracy ±1 digit	±1 °C (-50 to +99.9 °C) ±1% of mv (remaining range)
Resolution	0.1 °C
Oper. temp.	0 to +40 °C
Storage temp.	-20 to +70 °C

Battery type	3 batteries Type AAA
Battery life	1000 h
Reaction time	10 s
Reaction type	t_{99} (in water)
Display	LCD, 1 line
Weight	80 g
Warranty	2 years

Accessories

	Part no.
ISO calibration certificate/temperature ; for air/immersion probes, calibration point 0°C	0520 0062
ISO calibration certificate/temperature ; for air/immersion probes, calibration point -18°C	0520 0061
ISO calibration certificate/temperature ; for air/immersion probes, calibration point +60°C	0520 0063
ISO calibration certificate/temperature ; for air/immersion probes, calibration points -18°C; 0°C; +60°C	0520 0001

testo 905-T2
Surface thermometer

testo 905-T2, the complete innovation. A surface thermometer in professional quality at the lowest price. The sprung thermocouple measurement head guarantees a very fast reaction time and high accuracy by always lying flat, even on rough surfaces.

- Very fast reaction time
- Easy readout of readings due to rotatable display
- Very simple to operate
- Auto-Off function

testo 905-T2: surface thermometer with cross-band probe, incl. attachment clip, battery

Part no.
0560 9056



Sprung thermocouple cross-band adapts to any surface

Technical data

Meas. range	-50 to +350 °C Short-term to +500 °C
Accuracy ±1 digit	±(1 °C ±1% of mv)
Resolution	0.1 °C
Oper. temp.	0 to +40 °C
Storage temp.	-20 to +70 °C

Battery type	3 batteries Type AAA
Battery life	1000 h
Reaction time	5 s
Reaction type	t_{99}
Display	LCD, 1 line
Weight	80 g
Warranty	2 years

Accessories

	Part no.
ISO calibration certificate/temperature ; single point calibration for surface thermometer; calibration point +120°C	0520 0073
ISO calibration certificate/temperature ; single point calibration for surface thermometer; calibration point +60°C	0520 0072
ISO calibration certificate/temperature ; meas. instr. with surface probe; calibration points +60°C; +120°C; +180°C	0520 0071
ISO calibration certificate/temperature ; meas. instruments with surface probe; calibration points selectable from -15 to +480°C	0520 0121

Mini alarm thermometer

The affordable mini thermometer with Min/Max alarm. Small in size but big on quality! The penetration probe is attached to the instrument (80 cm cable) and is suitable for measuring the temperature in air, in soft, powdery substances and in liquids.

Mini thermometer, battery included

Part no.
0900 0530

Mini thermometer with penetration probe and alarm

- Permanently attached probe
- Adjustable Min/Max alarm
- With clip for positioning, for mounting on the wall and for attachment



Ordering data/quantity discount

Mini thermometer, from 5 off
Mini thermometer, from 10 off
Mini thermometer, from 25 off
Mini thermometer, from 50 off

Technical data

Meas. range	-50 to +150 °C
Accuracy	±1 °C (-10 to +100 °C) ±1 digit ±2 °C (remaining range)
Resolution	0.1 °C (-19.9 to +150 °C) 1 °C (-50 to -20 °C)
Oper. temp.	0 to +50 °C
Storage temp.	-20 to +70 °C

Battery type	2 AAA micro batteries
Battery life	100 h
Display	LCD, 1 line
Material/Housing	ABS
Warranty	2 years

Accessories

Accessories	Part no.
ISO calibration certificate/temperature ; for air/immersion probes, calibration point -18°C	0520 0061
ISO calibration certificate/temperature ; for air/immersion probes, calibration point 0°C	0520 0062

testo 103
The smallest folding temperature measuring instrument

At 11 cm, the testo 103 is the smallest folding thermometer of its class. It fits into any hand and any pocket. Its narrow probe tip is ideal for spot check measurements. It has an easy-to-clean, white ABS housing. This guarantees hygienically faultless temperature measurements.

testo 103 fulfils protection class IP55

- Handy, hygienic, suitable for food measurements of all kinds
- Robust probe with narrow probe tip, suitable for spot check measurements
- Easy-to-clean, white ABS housing
- Protection class IP 55

testo 103 folding thermometer

Order no.
0560 0103



Technical data	
Measurement unit	Temperature (°C/°F)
Sensor type	NTC
Measuring range	-30 ... +220 °C
Accuracy	± 0.5 °C (-30 to +99.9 °C) ± 1 % of the measurement value (+100 to +220 °C)
Resolution	0.1 °C/°F
Operating temperature	-20 ... +60 °C
Storage temperature	-30 ... +70 °C
Battery type	2 x CR2032 Lithium batteries
Life	300 h (typical)
Dimensions (LxWxH)	189 x 35 x 19 mm (probe folded out)
Probe length / diameter	75 mm / ø 3 mm
Probe tip / diameter	22 mm / ø 2.3 mm
Display	LCD, 1-line, not illuminated
Response time	t ₉₉ = 10 sec
Switching on/off	With folding mechanism (ca. 30°) / Auto Off after 60 mins
Housing material	ABS
Weight	49 g (incl. battery)
Protection class	IP55
Warranty	2 years
Certificate	EN 13485

testo 104

The testo 104 is ideally suited to core temperature measurements thanks to a robust metal folding joint and a long, stable measurement probe. Protection class IP65 allows cleaning under running water. The rubber-coated surface guarantees non-slip handling. The especially large, illuminated display allows fast and error-free readout of the measurement values. Automatic final value recognition thanks to Auto Hold.

testo 104 folding thermometer

Order no.
0563 0104

The first folding and waterproof temperature measuring instrument

- Robust folding metal joint with long, stable measurement probe, ideally suited for core temperature measurements in foods
- Automatic final value recognition (Auto-Hold)
- Minimum/maximum value store
- Protection class IP 65
- Rubber-coated surface for non-slip handling
- Especially large backlit display
- Coloured strips for individual instrument differentiation (included in delivery)



Technical data

Measurement unit	Temperature (°C / °F / °R)
Sensor type	NTC
Measuring range	-50 ... +250 °C
Accuracy	± 1,0 °C (-50 to -30,1 °C) ± 0,5 °C (-30 to +99,9 °C) ± 1 % of the measurement value (+100 to +250 °C)
Resolution	0,1 °C / °F / °R
Operating temperature	-20 ... +60 °C
Storage temperature	-30 ... +70 °C
Battery type	2 x AAA batteries
Life	100 h (typical)
Dimensions (LxWxH)	265 x 48 x 19 mm (probe folded out)
Probe length / diameter	106 mm / ø 3 mm
Probe tip / diameter	32 mm / ø 2,3 mm
Display	LCD, 1-line, illuminated
Response time	t ₉₀ = 10 sec
Other functions	Auto Hold, Hold, Min / Max
Switching on/off	With folding mechanism (ca. 30°) / Auto Off after 60 mins
Housing material	ABS / TPE / PC, diecast zinc, stainless steel
Weight	165 g (incl. battery)
Protection class	IP65
Warranty	2 years
Certificate	EN 13485

testo 106
The Compact Food Thermometer With Alarm

The core thermometer testo 106 with a thin, robust measuring tip, excellently suited for fast core temperature monitoring in gastronomy, in hotels, large kitchens, supermarkets etc.

- TopSafe (optionally or in a set), waterproof and dishwasher-safe protective case (IP 67)
- Fast measurement (2 measurements per second)
- Almost invisible penetration hole due to special food probe
- Small, handy and always close to hand
- Automatic recognition of final value (Auto-Hold)

testo 106, core thermometer incl. probe protecting cap and battery



Only in combination with TopSafe

Part no.

0560 1063

Technical data

Meas. range	-50 to +275 °C
Accuracy	±1 % of mv (+100 to +275 °C) ±0.5 °C (-30 to +99.9 °C) ±1 °C (-50 to -30.1 °C)
Resolution	0.1 °C
Oper. temp.	-20 to +50 °C
Storage temp.	-40 to +70 °C
t ₉₉	10 s
Battery type	3V button cell (CR 2032)
Battery life	350 h
Dimensions	215 x 34 x 19 mm
Display	LCD, 1 line
Material/Housing	ABS
Weight	80 g
Protection class	IP 67 with TopSafe
Warranty	2 years

Set	Part no.	Accessories	Part no.
Set testo 106, core thermometer incl. TopSafe (waterproof protective case, IP 67), belt clip, probe protecting cover and battery	0563 1063	ISO calibration certificate/temperature ; for air/immersion probes, calibration point +60°C	0520 0063
		ISO calibration certificate/temperature ; for air/immersion probes, calibration point -18°C	0520 0061
		ISO calibration certificate/temperature ; for air/immersion probes, calibration point 0°C	0520 0062
		ISO calibration certificate/temperature ; for air/immersion probes, calibration points -18°C; 0°C	0520 0041
		ISO calibration certificate/temperature ; for air/immersion probes, calibration points -8°C; 0°C; +40°C	0520 0181
Accessories	Part no.		
Frozen food drill; loss-proof attachment to belt clip	0554 0826		
TopSafe (indestructible protection case); waterproof and dishwasher-safe protection case (IP67)	0516 8265		
Holding clip with probe protection cap	0554 0825		

testo 105
Robust one-hand thermometer

The robust food thermometer with interchangeable measurement tips for control measurements in abattoirs, refrigerated storerooms, lorries etc.

- 2 user-defined limit values, visual or audible alarm
- Built-in display illumination
- Audible key feedback
- 1 line display
- Waterproof (IP 65) and robust



testo 105, One-hand thermometer with standard measurement tip, incl. battery and belt/wall holder

Part no.

0563 1051

Technical data

Meas. range	-50 to +275 °C
Accuracy	±0.5 °C (-20 to +100 °C) ±1 °C (-50 to -20.1 °C) ±1 % of mv (+100.1 to +275 °C)
Resolution	0.1 °C
Oper. temp.	-20 to +50 °C
Storage temp.	-40 to +70 °C
Battery type	4 x Button cell LR44
Battery life	80 h
Auto Off	10 min
Dimensions	145 x 38 x 195 mm
Display	LCD, 1 line
Weight	139 g
Protection class	IP65
Warranty	2 years

Set	Part no.	Accessories	Part no.
One-hand thermometer with standard measurement tip, frozen food tip, long measurement tip and belt/wall holder in aluminium case	0563 1052	1 Standard measurement tip, 100 mm long	0613 1051
		2 Frozen food tip, 90 mm long	0613 1052
		3 Long measurement tip, 200 mm long	0613 1053
testo 105 with frozen food measurement tip, belt/wall holder and batteries	0563 1054	Aluminium case for the testo 105 one-hand thermometer and accessories	0554 1051
		ISO calibration certificate/temperature, for air/immersion probes, calibration points -18°C; 0°C	0520 0041
		Button cell batteries, Type LR 44, 1.5 Volt (4 off)	0515 0032

testo 110

Multi-Purpose Highly Accurate Monitoring Thermometer

The highly accurate, versatile testo 110 temperature measuring instrument is ideal for applications in rough conditions on account of its protective case, TopSafe. The engineering used is specially designed for measurements in refrigerated store rooms, cabinets and for outdoors.

Minimum and maximum values are shown on a clear 2 line, backlit display or, if required, are printed on site on a Testo printer.

In addition to the wide range of standard handheld probes available (optional), a wireless radio probe can be used simultaneously.

- Wireless measurement with radio probes possible (optional)
- Measurement data printout on site on Testo fast printer (optional)
- TopSafe, the indestructible protective case (optional)
- Audible alarm (adjustable alarm limits)
- Minimum/maximum value memory
- Large backlit display
- Auto-Hold automatically recognises full-scale value



Only in combination with TopSafe



testo 110, 1 channel temperature measuring instrument NTC, audible alarm, connection to an optional radio probe, with battery and calibration protocol

Part no.
0560 1108

Air probes	Illustration	Meas. range	Accuracy	t99	Part no.
<ul style="list-style-type: none"> • Efficient, robust NTC air probe 		-50 to +125 °C ²⁾	±0.2 °C (-25 to +80 °C) ±0.4 °C (remaining range)	60 s	0613 1712
Surface probes	Illustration	Meas. range	Accuracy	t99	Part no.
<ul style="list-style-type: none"> • Waterproof NTC surface probe for flat surfaces 		-50 to +150 °C ²⁾	±0.5% of mv (+100 to +150 °C) ±0.2 °C (-25 to +74.9 °C) ±0.4 °C (remaining range)	35 s	0613 1912
Pipe wrap probe with Velcro for pipe diameter to max. 75 mm, Tmax. +75 °C, NTC		-50 to +70 °C ²⁾	±0.2 °C (-25 to +70 °C) ±0.4 °C (-50 to -25.1 °C)	60 s	0613 4611
Immers./penetr. probes	Illustration	Meas. range	Accuracy	t99	Part no.
<ul style="list-style-type: none"> • Waterproof NTC immersion/penetration probe 		-50 to +150 °C	±0.5% of mv (+100 to +150 °C) ±0.2 °C (-25 to +74.9 °C) ±0.4 °C (remaining range)	10 s	0613 1212
Food probes	Illustration	Meas. range	Accuracy	t99	Part no.
<ul style="list-style-type: none"> • Stainless steel NTC food probe (IP65) with PUR cable 		-50 to +150 °C ²⁾	±0.5% of mv (+100 to +150 °C) ±0.2 °C (-25 to +74.9 °C) ±0.4 °C (remaining range)	8 s	0613 2211
<ul style="list-style-type: none"> • Stainless steel NTC food probe (IP67) with PTFE cable to +250 °C 		-50 to +150 °C ²⁾	±0.5% of mv (+100 to +150 °C) ±0.2 °C (-25 to +74.9 °C) ±0.4 °C (remaining range)	8 s	0613 3311
<ul style="list-style-type: none"> • Robust NTC food penetration probe with special handle, reinforced PUR cable 		-25 to +150 °C ²⁾	±0.5% of mv (+100 to +150 °C) ±0.2 °C (-25 to +74.9 °C) ±0.4 °C (remaining range)	7 s	0613 2411
<ul style="list-style-type: none"> • Frozen food probe NTC, corkscrew design (incl. plug-in wire) 		-50 to +140 °C ²⁾	±0.5% of mv (+100 to +140 °C) ±0.2 °C (-25 to +74.9 °C) ±0.4 °C (remaining range)	20 s	0613 3211

• The measuring instrument inside TopSafe is waterproof with this probe.

2) Long-term measurement range +125 °C, short-term +150 °C or +140 °C (2 minutes)

testo 110
Accessories / Technical data

Accessories	Part no.	Technical data	
Accessories for measuring instrument		Oper. temp.	-20 to +50 °C
9V rech. battery for instrument instead of battery	0515 0025	Storage temp.	-40 to +70 °C
Recharger for 9V rechargeable battery for external recharging of 0515 0025 battery	0554 0025	Battery type	9V block battery, 6F22
Lithium battery, button cell, type CR 2032 for wireless probes	0515 0028	Battery life	200 h (connected probe, backlight off) 45 h (radio mode, backlight off) 68 h (connected probe, backlight always on) 33 h (radio mode, backlight always on)
Printer and Accessories		Dimensions	182 x 64 x 40 mm
Testo fast printer with wireless infrared interface, 1 roll thermal paper and 4 AA batteries	0554 0549	Weight	171 g
Spare thermal paper for printer (6 rolls) measurement data documentation legible for up to 10 years	0554 0568	Material/Housing	ABS
Spare thermal paper for printer (6 rolls)	0554 0569	Warranty	2 years
External fast charger for 1-4 AA rech. batteries, incl. 4 Ni-MH rech. batteries with individual cell charging and charge control display, incl. impulse trickle charging, integrated discharge function, with built-in international mains plug, 100-240 V, 300 mA, 50/60 Hz	0554 0610	Probe type	NTC
Transport and Protection		Meas. range	-50 to +150 °C
TopSafe, protects from impact and dirt (incl. 2 attachment magnets)	0516 0221	Accuracy ±1 digit	±0.2 °C (-20 to +80 °C) ±0.3 °C (remaining range)
Case for measuring instrument and probes	0516 0210	Resolution	0.1 °C
Transport case for meas. instr. and probes (405 x 170 x 85 mm)	0516 0201		
Transport case for measuring instrument, 3 probes and accessories (430 x 310 x 85 mm)	0516 0200		
Calibration certificates			
ISO calibration certificate/temperature for air/immersion probes, calibration points -18°C; 0°C; +60°C	0520 0001		
ISO calibration certificate/temperature single point calibration for surface thermometer; calibration point +60°C	0520 0072		
ISO calibration certificate/temperature single point calibration for surface thermometer; calibration point +120°C	0520 0073		
DAkkS calibration certificate/temperature*, meas. instr. with air/immersion probe; calibration points -20°C; 0°C; +60°C	0520 0211		

*Successor organization of the DKD

See back flap for radio probes

testo 112

The calibratable testo 112 precision temperature measuring instrument was designed specially for official inspection measurements. The instrument is approved for official measurements by food inspectors, assessors and official authorities on account of its PTB design approval and the option of calibrating it. A built-in self-test indicates correct functioning before measurement begins.

Owing to its wide measuring range, testo 112 is the ideal temperature measuring instrument for all areas of food monitoring. NTC probes (thermistor probes) and Pt100 probes (platinum resistance probes) can both be attached to the probe input, so that a wide temperature range is covered, ranging from deep-frozen products to deep-fat fryer monitoring.

In order to document readings, testo 112 provides the possibility of printing data directly on site with date and time. This is particularly interesting for food hygiene inspectors. If adjustable high or low limit values are exceeded, the instrument immediately sounds an audible alarm.

Minimum and maximum limit values can be conveniently called up in the two-line display.

It is possible to print out readings on site on the Testo printer (optional).

testo 112, 1 channel temperature measuring instrument NTC/Pt100, calibratable, with battery

Part no.

0560 1128

Calibratable Temperature Measuring Instrument

- The instrument for official food inspections
- Data printout on site on the Testo fast printer (optional)
- TopSafe, indestructible protection case (optional)
- Large, backlit display with 14 mm high characters
- Call up max/min values at the touch of a button
- Highly accurate, officially calibratable temperature measuring instrument
- Minimum/maximum value memory





Air probes	Illustration	Meas. range	Accuracy	t99	Part no.
<ul style="list-style-type: none"> • Efficient, robust NTC air probe 		-50 to +125 °C ²⁾	±0.2 °C (-25 to +80 °C) ±0.4 °C (remaining range)	60 s	0613 1712
Surface probes	Illustration	Meas. range	Accuracy	t99	Part no.
<ul style="list-style-type: none"> • Waterproof NTC surface probe for flat surfaces 		-50 to +150 °C ²⁾	±0.5% of mv (+100 to +150 °C) ±0.2 °C (-25 to +74.9 °C) ±0.4 °C (remaining range)	35 s	0613 1912
Pipe wrap probe with Velcro for pipe diameter to max. 75 mm, Tmax. +75 °C, NTC		-50 to +70 °C	±0.2 °C (-25 to +70 °C) ±0.4 °C (-50 to -25.1 °C)	60 s	0613 4611
Immersion/penetr. probes	Illustration	Meas. range	Accuracy	t99	Part no.
<ul style="list-style-type: none"> • Waterproof NTC immersion/penetration probe 		-50 to +150 °C ²⁾	±0.5% of mv (+100 to +120 °C) ±0.2 °C (-25 to +74.9 °C) ±0.4 °C (remaining range)	10 s	0613 1212
Food probes	Illustration	Meas. range	Accuracy	t99	Part no.
<ul style="list-style-type: none"> • Stainless steel NTC food probe (IP65) with PUR cable 		-50 to +150 °C ²⁾	±0.5% of mv (+100 to +150 °C) ±0.2 °C (-25 to +74.9 °C) ±0.4 °C (remaining range)	8 s	0613 2211
<ul style="list-style-type: none"> • Stainless steel NTC food probe (IP67) with PTFE cable to +250 °C 		-50 to +150 °C ²⁾	±0.5% of mv (+100 to +150 °C) ±0.2 °C (-25 to +74.9 °C) ±0.4 °C (remaining range)	8 s	0613 3311
<ul style="list-style-type: none"> • Robust NTC food penetration probe with special handle, reinforced PUR cable 		-25 to +150 °C ²⁾	±0.5% of mv (+100 to +150 °C) ±0.2 °C (-25 to +74.9 °C) ±0.4 °C (remaining range)	7 s	0613 2411
<ul style="list-style-type: none"> • Frozen food probe NTC, corkscrew design (incl. plug-in wire) 		-50 to +140 °C ²⁾	±0.5% of mv (+100 to +140 °C) ±0.2 °C (-25 to +74.9 °C) ±0.4 °C (remaining range)	20 s	0613 3211

• The measuring instrument inside TopSafe is waterproof with this probe.

2) Long-term measurement range +125 °C, short-term +150 °C or +140 °C (2 minutes)

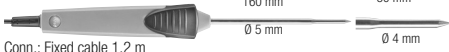
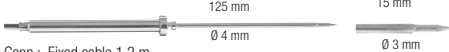
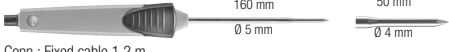
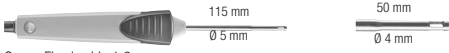
testo 112
Accessories / Technical data
Calibratable probes

Pt100	Illustration	Meas. range	Accuracy	t ₉₉	Part no.
♣ Waterproof Pt100 immersion/penetration probe, calibratable  160 mm 50 mm Ø 5 mm Ø 4 mm Conn.: Fixed cable 1.2 m	-50 to +300 °C	Class A	12 s	0614 1272	
♣ Robust stainless steel Pt100 food probe IP65, calibratable  125 mm 15 mm Ø 4 mm Ø 3 mm Conn.: Fixed cable 1.2 m	-50 to +300 °C	Class A	10 s	0614 2272	
NTC	Illustration	Meas. range	Accuracy	t ₉₉	Part no.
♣ Waterproof NTC immersion/penetration probe, calibratable  160 mm 50 mm Ø 5 mm Ø 4 mm Conn.: Fixed cable 1.2 m	-25 to +120 °C	±0.5% of mv (+100 to +120 °C) ±0.2 °C (-25 to +74.9 °C) ±0.4 °C (remaining range)	10 s	0614 1212	
♣ Accurate, robust NTC air probe, calibratable  115 mm 50 mm Ø 5 mm Ø 4 mm Conn.: Fixed cable 1.2 m	-25 to +120 °C	±0.5% of mv (+100 to +120 °C) ±0.2 °C (-25 to +74.9 °C) ±0.4 °C (remaining range)	60 s	0614 1712	
♣ Stainless steel NTC food probe (IP65) with PUR cable  125 mm 15 mm Ø 4 mm Ø 3 mm Conn.: Fixed cable	-25 to +120 °C	±0.5% of mv (+100 to +150 °C) ±0.2 °C (-25 to +74.9 °C) ±0.4 °C (remaining range)	8 s	0614 2211	
♣ Robust NTC food penetration probe with special handle, reinforced PUR cable  115 mm 30 mm Ø 5 mm Ø 3.5 mm Conn.: Fixed cable	-25 to +120 °C	±0.5% of mv (+100 to +120 °C) ±0.2 °C (-25 to +74.9 °C) ±0.4 °C (remaining range)	7 s	0614 2411	

♣ The measuring instrument inside TopSafe is waterproof with this probe.

Accessories	Part no.
Accessories for measuring instrument	
9V rech. battery for instrument instead of battery	0515 0025
Recharger for 9V rechargeable battery for external recharging of 0515 0025 battery	0554 0025
Printer and Accessories	
Testo fast printer with wireless infrared interface, 1 roll thermal paper and 4 AA batteries	0554 0549
Spare thermal paper for printer (6 rolls) measurement data documentation legible for up to 10 years	0554 0568
Spare thermal paper for printer (6 rolls)	0554 0569
External fast charger for 1-4 AA rech. batteries, incl. 4 Ni-MH rech. batteries with individual cell charging and charge control display, incl. impulse trickle charging, integrated discharge function, with built-in international mains plug, 100-240 V, 300 mA, 50/60 Hz	0554 0610
Transport and Protection	
TopSafe, protects from impact and dirt	0516 0220
Case for measuring instrument and probes	0516 0210
Transport case for meas. instr. and probes (405 x 170 x 85 mm)	0516 0201
Transport case for measuring instrument, 3 probes and accessories (430 x 310 x 85 mm)	0516 0200

Technical data		
Probe type	NTC	Pt100
Meas. range	-50 to +120 °C	-50 to +300 °C
Accuracy ±1 digit	±0.2 °C (-25 to +40 °C) ±0.3 °C (+40.1 to +80 °C) ±0.5 °C (remaining range)	±0.2 °C (-50 to +200 °C) ±0.3 °C (remaining range)
Resolution	0.1 °C	0.1 °C
Oper. temp.	-20 to +50 °C	Dimensions 182 x 64 x 40 mm
Storage temp.	-30 to +70 °C	Weight 171 g
Battery life	100 h	Material/Housing ABS
Battery type	9V block battery, 6F22	Warranty 2 years

testo 926

Fast, Accurate All-Round Thermometer

The fast-action, efficient temperature measuring instrument, testo 926, for the food sector. The optional TopSafe protection case renders it insensitive to dirt, therefore making it the ideal partner for large-scale kitchens, hotels, restaurants or the food industry. Besides measuring minimum and maximum values, readings can also be printed on site on the Testo fast printer. In addition to the wide range of standard probes with cable, a wireless radio probe can be used simultaneously, if required.

- Measurement parameters °C, °F, °R
- Fast-action probes for every application
- Wireless measurement with radio probes possible (optional)
- Measurement data printout on site on the Testo fast printer
- TopSafe, the indestructible protection case (optional)
- Minimum/maximum value memory
- Large backlit display
- Auto-Hold automatically recognises full-scale value
- Audible alarm (adjustable alarm limits)



testo 926-1, 1 channel food temperature measuring instrument T/C Type T, audible alarm, connection to an optional radio probe, with battery and calibration protocol

Part no.
0560 9261

testo 926, Starter set

testo 926, Starter set, 1 channel food temperature measuring instrument T/C Type T, incl. TopSafe, standard immersion/penetration probes, battery and calibration protocol

Part no.
0563 9262

Food probes	Illustration	Meas. range	Accuracy	t99	Part no.
Robust food penetration probe with special handle, reinforced cable (PVC), T/C Type T	115 mm 0.5 mm 30 mm 0.5 mm Conn.: Fixed cable	-50 to +350 °C	±0.2 °C (-20 to +70 °C) Class 1 (remaining range)*	6 s	0603 2492
Frozen food probe, corkscrew design, T/C Type T	110 mm 0.8 mm 30 mm 0.4 mm Conn.: Plug-in cable	-50 to +350 °C	±0.2 °C (-20 to +70 °C) Class 1 (remaining range)*	8 s	0603 3292
Stainless steel food probe (IP67) with PUR cable, T/C Type T	125 mm 0.4 mm 30 mm 0.3.2 mm Conn.: Fixed cable	-50 to +350 °C	±0.2 °C (-20 to +70 °C) Class 1 (remaining range)*	7 s	0603 2192
Waterproof precision immersion/penetration probe without visible penetration hole, T/C Type T	70 mm 0.5 mm 15 mm 0.1.5 mm Conn.: Fixed cable 1.2 m	-50 to +350 °C	±0.2 °C (-20 to +70 °C) Class 1 (remaining range)*		0603 2693
Stainless steel food probe (IP67), with PTFE cable to +250 °C, TC Type T	125 mm 0.4 mm 30 mm 0.3.2 mm Conn.: Fixed cable	-50 to +350 °C	±0.2 °C (-20 to +70 °C) Class 1 (remaining range)*	7 s	0603 3392
Waterproof, super-quick needle probe for measurements without visible penetration hole, T/C Type T	150 mm 0.1.4 mm 30 mm Conn.: Fixed cable	-50 to +250 °C	±0.2 °C (-20 to +70 °C) Class 1 (remaining range)*	2 s	0628 0027
Quick needle probe to monitor cooking in oven, T/C Type T	60 mm 0.1.4 mm 30 mm Conn.: Fixed cable	-50 to +250 °C	±0.2 °C (-20 to +70 °C) Class 1 (remaining range)*	2 s	0628 0030
Measurement tip with T/C adapter Type T, ideal for fast-action measurement on incoming goods	500 mm 0.1.5 mm 30 mm	-50 to +350 °C	Class 1*	5 s	0628 0023
Flexible oven probe, Tmax +250 °C, PTFE cable	2000 mm 0.1.5 mm 30 mm	-50 to +250 °C	Class 1*		0603 0646

The measuring instrument inside TopSafe is waterproof with this probe.

* According to standard EN 60584-2, the accuracy of Class 1 refers to -40 to +350 °C (Type T).

testo 926
Accessories / Technical data

Air probes	Illustration	Meas. range	Accuracy	t99	Part no.
Robust, affordable air probe, T/C Type T	<p>Conn.: Fixed cable 1.2 m</p>	-50 to +350 °C	±0.2 °C (-20 to +70 °C) Class 1 (remaining range)*	25 s	0603 1793
Surface probes	Illustration	Meas. range	Accuracy	t99	Part no.
Waterproof surface probe with widened measurement tip for flat surfaces, T/C Type T	<p>Conn.: Fixed cable 1.2 m</p>	-50 to +350 °C	±0.2 °C (-20 to +70 °C) Class 1 (remaining range)*	30 s	0603 1993
Immersion./penetr. probes	Illustration	Meas. range	Accuracy	t99	Part no.
Waterproof standard immersion/penetration probe, T/C Type T	<p>Conn.: Fixed cable</p>	-50 to +350 °C	±0.2 °C (-20 to +70 °C) Class 1 (remaining range)*	7 s	0603 1293

Accessories	Part no.
Accessories for measuring instrument	
9V rech. battery for instrument, instead of battery	0515 0025
Recharger for 9V rechargeable battery, for external recharging of 0515 0025 battery	0554 0025
Printer and Accessories	
Testo fast printer with wireless infrared interface, 1 roll thermal paper and 4 AA batteries	0554 0549
Spare thermal paper for printer (6 rolls), measurement data documentation legible for up to 10 years	0554 0568
Spare thermal paper for printer (6 rolls)	0554 0569
External fast charger for 1-4 AA rech. batteries, incl. 4 Ni-MH rech. batteries with individual cell charging and charge control display, incl. impulse trickle charging, integrated discharge function, with built-in international mains plug, 100-240 V, 300 mA, 50/60 Hz	0554 0610
Transport and Protection	
TopSafe, protects from impact and dirt	0516 0220
Transport case for measuring instrument, 3 probes and accessories (430 x 310 x 85 mm)	0516 0200
Transport case for meas. instr. and probes (405 x 170 x 85 mm)	0516 0201
Case for measuring instrument and probes	0516 0210
Calibration certificates	
ISO calibration certificate/temperature for air/immersion probes, calibration points -18°C; 0°C; +60°C	0520 0001
ISO calibration certificate/temperature for air/immersion probes, calibration point -18°C	0520 0061
ISO calibration certificate/temperature for air/immersion probes, calibration point 0°C	0520 0062
ISO calibration certificate/temperature for air/immersion probes, calibration point +60°C	0520 0063
ISO calibration certificate/temperature for air/immersion probes, calibration points -8°C; 0°C; +40°C	0520 0181
ISO calibration certificate/temperature meas. instr. with surface probe; calibration points +60°C; +120°C; +180°C	0520 0071
ISO calibration certificate/temperature single point calibration for surface thermometer; calibration point +60°C	0520 0072
ISO calibration certificate/temperature single point calibration for surface thermometer; calibration point +120°C	0520 0073

Technical data	
Probe type	Type T (Cu-CuNi) or NTC and Type K if radio immersion/penetration probes are used
Parameters	°C, °F, °R
Meas. range	-50 to +400 °C
Accuracy	±0.3 °C (-20 to +70 °C) ±(0.7 °C ±0.5% of mv) (remaining range)
Resolution	0.1 °C (-50 to +199.9 °C) 1 °C (remaining range)
Oper. temp.	-20 to +50 °C
Storage temp.	-40 to +70 °C
Battery type	9V block battery, 6F22
Battery life	200 h (connected probe, backlight off) 45 h (radio mode, backlight off) 68 h (connected probe, backlight always on) 33 h (radio mode, backlight always on)
Dimensions	182 x 64 x 40 mm
Material/Housing	ABS
Weight	171 g
Warranty	2 years

See back flap for radio probes

testo 922

The differential thermometer records temperature values from 2 connected thermocouple probes and displays them simultaneously. The reading from an additional temperature probe can also be wirelessly displayed in the testo 922 measuring instrument; i.e. measurement data is transmitted by radio.

Differential temperature can be called up immediately. Current measurement data such as max/min data can be printed on the Testo fast printer on site. It is possible to print measurement data once a minute, for example, on the printer if cyclical printing is in operation.

testo 922, 2 channel temperature measuring instrument T/C Type K, connection of an optional radio probe, with battery and calibration protocol

Part no.
0560 9221

testo 925

The one channel temperature measuring instrument for connection to reliable, fast-action thermocouple probes. An additional temperature probe can be displayed in testo 925; data is transmitted by radio, i.e. wirelessly. An audible alarm sounds if limit values are exceeded. Current measurement data as well as max/min data can be printed on site on the Testo fast printer.

testo 925, 1 channel temperature measuring instrument T/C Type K, audible alarm, connection of an optional radio probe, with battery and calibration protocol

Part no.
0560 9250

Fast Temperature Measurement with Wide Measurement Range

Common Advantages testo 922, 925

- On site printout on Testo fast printer
- Continuous display of max/min values
- Hold button to freeze reading
- TopSafe, indestructible case, protects from dirt and impact (optional)
- Display light

testo 922

- 2 channel measuring instrument with optional radio probe
- Displays differential temperature
- Cyclical printing of readings, e.g. once a minute

testo 925

- 1 channel measuring instrument with optional radio probe
- An audible alarm sounds when limit values are exceeded



Air probes	Illustration	Meas. range	Accuracy	t99	Part no.
<ul style="list-style-type: none"> • Robust air probe, T/C Type K 		-60 to +400 °C	Class 2*	25 s	0602 1793
Immersion/penetr. probes	Illustration	Meas. range	Accuracy	t99	Part no.
<ul style="list-style-type: none"> • Efficient and fast-action immersion probe, waterproof, TC Type K 		-60 to +1000 °C	Class 1*	2 s	0602 0593
<ul style="list-style-type: none"> • Fast-action, waterproof immersion/penetration probe, TC Type K (Calibration not possible over +300 °C) 		-60 to +800 °C	Class 1*	3 s	0602 2693
Immersion tip, flexible, TC Type K		-200 to +1000 °C	Class 1*	5 s	0602 5792
Immersion measurement tip, flexible, for measurements in air/exhaust gases (not suitable for measurements in smelters), TC Type K		-200 to +1300 °C	Class 1*	4 s	0602 5693
Immersion tip, flexible, TC Type K		-200 to +40 °C	Class 3*	5 s	0602 5793
<ul style="list-style-type: none"> • Waterproof immersion/penetration probe, TC Type K 		-60 to +400 °C	Class 2*	7 s	0602 1293

The measuring instrument inside TopSafe is waterproof with this probe.

*According to standard EN 60584-2, the accuracy of Class 1 refers to -40 to +1000 °C (Type K), Class 2 to -40 to +1200 °C (Type K), Class 3 to -200 to +40 °C (Type K).

testo 922 / testo 925
Probes

Surface probes	Illustration	Meas. range	Accuracy	t99	Part no.
<ul style="list-style-type: none"> Fast-reaction paddle surface probe, for measurements in inaccessible places, e.g. narrow apertures and slots, TC Type K 	<p>Conn.: Fixed cable</p>	0 to +300 °C	Class 2*	5 s	0602 0193
<ul style="list-style-type: none"> Fast-action surface probe with sprung thermocouple strip, also for uneven surfaces, measurement range short-term to +500°C, TC Type K 	<p>Conn.: Fixed cable 1.2 m</p>	-60 to +300 °C	Class 2*	3 s	0602 0393
<ul style="list-style-type: none"> Waterproof surface probe with widened measurement tip for flat surfaces, T/C Type K 	<p>Conn.: Fixed cable 1.2 m</p>	-60 to +400 °C	Class 2*	30 s	0602 1993
<ul style="list-style-type: none"> Fast-action surface probe with sprung thermocouple strip, bent, also for uneven surfaces, measurement range short-term to +500°C, TC Type K 	<p>Conn.: Fixed cable 1.2 m</p>	-60 to +300 °C	Class 2*	3 s	0602 0993
<ul style="list-style-type: none"> Efficient, waterproof surface probe with small measurement head for flat surfaces, TC Type K 	<p>Conn.: Fixed cable 1.2 m</p>	-60 to +1000 °C	Class 1*	20 s	0602 0693
Flat head surface probe with telescopic handle max. 680 mm for measurements at hard-to-access points, TC Type K	<p>Conn.: Fixed cable, 1.6 m, (correspondingly shorter when telescope extended)</p>	-50 to +250 °C	Class 2*	3 s	0602 2394
Magnetic probe, adhesive force approx. 20 N, with magnets, for measurements on metal surfaces, TC Type K	<p>Conn.: Fixed cable</p>	-50 to +170 °C	Class 2*	150 s	0602 4792
Magnetic probe, adhesive force approx. 10 N, with magnets, for higher temp., for measurements on metal surfaces, TC Type K	<p>Conn.: Fixed cable</p>	-50 to +400 °C	Class 2*		0602 4892
Pipe wrap probe with Velcro strip, for temperature measurement on pipes with diameter up to max. 120 mm, Tmax +120°C, TC Type K	<p>Conn.: Fixed cable</p>	-50 to +120 °C	Class 1*	90 s	0628 0020
Pipe wrap probe for pipe diameter 5 to 65 mm, with exchangeable measuring head. Meas. range short-term to +280°C, TC Type K	<p>Conn.: Fixed cable</p>	-60 to +130 °C	Class 2*	5 s	0602 4592
Spare meas. head for pipe wrap probe, TC Type K		-60 to +130 °C	Class 2*	5 s	0602 0092
Clamp probe for measurements on pipes, pipe diameter 15 to 25 mm (max. 1"), meas. range short-term up to +130°C, TC Type K	<p>Conn.: Fixed cable</p>	-50 to +100 °C	Class 2*	5 s	0602 4692
Food probes	Illustration	Meas. range	Accuracy	t99	Part no.
<ul style="list-style-type: none"> Waterproof food probe made of stainless steel (IP65), TC Type K 	<p>Conn.: Fixed cable</p>	-60 to +400 °C	Class 2*	7 s	0602 2292
Robust food probe with special handle, IP 65, reinforced cable (PUR), T/C Type K	<p>Conn.: Fixed cable</p>	-60 to +400 °C	Class 1*	6 s	0602 2492
Waterproof robust immersion/penetration probe with metal protection hose Tmax +230°C, e.g. for monitoring temp. in cooking oil, T/C Type K	<p>Conn.: Fixed cable</p>	-50 to +230 °C	Class 1*	15 s	0628 1292
Thermocouples	Illustration	Meas. range	Accuracy	t99	Part no.
Thermocouple with TC adapter, flexible, 800mm long, fibre glass, TC Type K		-50 to +400 °C	Class 2*	5 s	0602 0644
Thermocouple with TC adapter, flexible, 1500mm long, fibre glass, TC Type K		-50 to +400 °C	Class 2*	5 s	0602 0645
Thermocouple with TC adapter, flexible, 1500mm long, PTFE, TC Type K		-50 to +250 °C	Class 2*	5 s	0602 0646

* The measuring instrument inside TopSafe is waterproof with this probe. *According to standard EN 60584-2, the accuracy of Class 1 refers to -40 to +1000 °C (Type K), Class 2 to -40 to +1200 °C (Type K), Class 3 to -200 to +40 °C (Type K).

See back flap for radio probes

Accessories	Part no.
Accessories for measuring instrument	
9V rech. battery for instrument instead of battery	0515 0025
Recharger for 9V rechargeable battery for external recharging of 0515 0025 battery	0554 0025
Printer and Accessories	
Testo fast printer with wireless infrared interface, 1 roll thermal paper and 4 AA batteries	0554 0549
Spare thermal paper for printer (6 rolls) measurement data documentation legible for up to 10 years	0554 0568
Transport and Protection	
TopSafe, protects from impact and dirt (testo 922) (incl. 2 attachment magnets)	0516 0222
TopSafe, protects from impact and dirt (testo 925)	0516 0221
Transport case for measuring instrument, 3 probes and accessories (430 x 310 x 85 mm)	0516 0200
Transport case for meas. instr. and probes (405 x 170 x 85 mm)	0516 0201
Case for measuring instrument and probes	0516 0210
Other features	
Handle for attachable measurement tips (0602 5792/0644/0645/0646)	0409 1092
Extension cable, 5m, for thermocouple probe Type K	0554 0592
Silicone heat paste (14g), T _{max} = +260°C improves heat transfer in surface probes	0554 0004

Accessories	Part no.
Calibration certificates	
ISO calibration certificate/temperature for air/immersion probes, calibration points -18°C; 0°C; +60°C	0520 0001
ISO calibration certificate/temperature** Meas. instr. with air/immersion probe; cal. points 0°C; +150°C; +300°C **(Applies only to immersion/penetration probe 0602 2693)	0520 0021
ISO calibration certificate/temperature meas. instr. with air/immersion probe; calibration points 0°C; +300°C; +600°C	0520 0031
ISO calibration certificate/temperature meas. instr. with surface probe; calibration points +60°C; +120°C; +180°C	0520 0071
DAkkS calibration certificate/temperature* meas. instr. with air/immersion probe; calibration points -20°C; 0°C; +60°C	0520 0211
DAkkS calibration certificate/temperature* contact surface temperature probes; calibration points +100°C; +200°C; +300°C	0520 0271

*Successor organization of the DKD

Technical data		
Probe type	Type K (NiCr-Ni)	Battery type
Meas. range	-50 to +1000 °C	9V block battery, 6F22
Accuracy	±(0.5 °C +0.3% of mv) (-40 to +900 °C) ±1 digit	Battery life
Resolution	0.1 °C (-50 to +199.9 °C) 1 °C (remaining range)	200 h (connected probe, backlight off) 45 h (radio mode, backlight off) 68 h (connected probe, backlight always on) 33 h (radio mode, backlight always on)
Oper. temp.	-20 to +50 °C	Dimensions
Storage temp.	-40 to +70 °C	182 x 64 x 40 mm
Material/Housing	ABS	Weight
		171 g
		Warranty
		2 years

Ex-Pt 720
Highly accurate Ex-Pt thermometer

Ex-Pt 720 for fast and accurate temperature measurements in hazardous areas up to Zone 0.

Ex-Pt 720 is the ideal measuring instrument for control measurements due to its wide measuring range and accurate four-wire technology.

- Highly accurate
- Wide range of probes
- Fast custom-designed probes service
- Approval in accordance with European and American Standards

Ex-Pt 720, temperature measuring instrument with holder strap, incl. battery and calibration protocol

Part no.
0560 7236



Easy to read thanks to large display

LS. Class I Div 1 ABCD T4

Class 1 Zone 0 AEx ia IIC T4

II 2(1) G EEx ia IIC T4

TÜV 01 ATEX 1757 X

Probes	Illustration	Meas. range	Accuracy	t99	Part no.
Robust, water-proof immersion/penetration probe for Zone 1 and 2, PUR cable	<p>110 mm 30 mm Ø 4 mm Ø 3.2 mm</p> <p>Conn.: Fixed cable</p>	-50 to +400 °C	Class A (-50 to +300 °C), Class B (remaining range)*	12 s	0628 1232
Robust, water-proof surface probe for Zone 1 and 2, with widened measuring tip for flat surfaces, PUR cable	<p>140 mm Ø 4 mm Ø 9 mm</p> <p>Conn.: Fixed cable</p>	-50 to +400 °C	Class B*	40 s	0628 1932
Robust immersion/penetration probe (IP 65) for Zone 0, 1 and 2, stainless steel, PUR cable can be used for up to +80°C, IP 54 plug-in connection	<p>126 mm Ø 4 mm 15 mm Ø 3 mm</p> <p>Conn.: Fixed cable</p>	-50 to +400 °C	Class A (-50 to +300 °C), Class B (remaining range)*	10 s	0628 2232
Robust immersion probe (IP 67), for Zone 0, 1 and 2, stainless steel, FEP cable can be used at up to 205°C. Application: temperature measurement in petrol and oil tanks. Cable: 25 m long	<p>73 mm Ø 15 mm</p> <p>Conn.: Fixed cable</p>	-50 to +400 °C	Class A (-50 to +300 °C), Class B (remaining range)*	15 s	0628 2432

*According to standard EN 60751, the accuracies of Class A and B refer to -200 to +600 °C (Pt100)

Accessories	Part no.
Transport and Protection	
Case for measuring instrument and probes	0516 0210
Transport case for meas. instr. and probes (405 x 170 x 85 mm)	0516 0201
Transport case for measuring instrument, 3 probes and accessories (430 x 310 x 85 mm)	0516 0200
Calibration certificates	
ISO calibration certificate/temperature, for air/immersion probes, calibration points -18°C; 0°C; +60°C	0520 0001
ISO calibration certificate/temperature, Meas. instr. with air/immersion probe; cal. points 0°C; +150°C; +300°C	0520 0021
ISO calibration certificate/temperature, meas. instr. with air/immersion probe; calibration points 0°C; +300°C; +600°C	0520 0031
DAkkS calibration certificate/temperature*, meas. instr. with air/immersion probe; calibration points -20°C; 0°C; +60°C	0520 0211
DAkkS calibration certificate/temperature*, Meas. instr. with air/immersion probe; cal. points 0°C; +100°C; +200°C	0520 0221
ISO calibration certificate/temperature, meas. instr. with surface probe; calibration points +60°C; +120°C; +180°C	0520 0071
DAkkS calibration certificate/temperature*, contact surface temperature probes; calibration points +100°C; +200°C; +300°C	0520 0271

*Successor organization of the DKD

Technical data		
Probe type	Pt100	
Meas. range	-50 to +400 °C	Oper. temp. -10 to +50 °C
Accuracy	±0.2% of mv (+200 to +400 °C)	Storage temp. -20 to +70 °C
±1 digit	±0.2 °C (-50 to +199.9 °C)	Battery type 9 V, IEC 6LR61
		Battery life 100 h
		Dimensions 190 x 57 x 42 mm
		Weight 200 g
Resolution	0.1 °C (-50 to +199.9 °C) 1 °C (+200 to +400 °C)	Material/Housing Housing: ABS, coated
		Other features °C/°F
		Warranty 2 years

testo 720

Accurate Temperature Measurement

Testo 720 is the single channel measuring instrument for demanding measurements in laboratories and in industry. Air, immersion and surface probes in a measurement range from -100 to +800 °C can be attached to the thermometer for different measuring tasks.

In combination with the indestructible TopSafe, testo 720 is resistant to corrosive media. The glass-coated probe has proved its worth in day-to-day use in the laboratory, as it too is resistant to corrosive media.

An audible alarm sounds when limit values are exceeded. Current measurement data, as well as min/max data can be printed out on site on the Testo printer.

- On site printout on Testo printer
- Continuous display of max/min values
- Hold button to freeze readings
- Display light
- Audible alarm (adjustable limit values)
- Resistant to corrosive media with TopSafe (optional)



testo 720, 1 channel temperature measuring instrument Pt100/NTC, with battery and calibration protocol

Part no.
0560 7207

Laboratory probes	Illustration	Meas. range	Accuracy	t99	Part no.
Laboratory probe Pt100, glass-coated, exchangeable glass pipe (Duran 50), resistant to corrosive substances	<p>Fixed cable</p>	-50 to +400 °C	Class A (-50 to +300 °C), Class B (remaining range)*	45 s 12 s ¹⁾	0609 7072
Air probes	Illustration	Meas. range	Accuracy	t99	Part no.
• Efficient, robust NTC air probe	<p>Conn.: Fixed cable 1.2 m</p>	-50 to +125 °C	±0.2 °C (-25 to +80 °C) ±0.4 °C (remaining range)	60 s	0613 1712
• Efficient, robust air probe, Pt100	<p>Fixed cable</p>	-50 to +400 °C	Class A (-50 to +300 °C), Class B (remaining range)*	70 s	0609 1773
Surface probes	Illustration	Meas. range	Accuracy	t99	Part no.
• Waterproof NTC surface probe for flat surfaces	<p>Conn.: Fixed cable 1.2 m</p>	-50 to +150 °C	±0.5% of mv (+100 to +150 °C) ±0.2 °C (-25 to +74.9 °C) ±0.4 °C (remaining range)	35 s	0613 1912
Pipe wrap probe with Velcro for pipe diameter to max. 75 mm, Tmax. +75 °C, NTC	<p>Conn.: Fixed cable</p>	-50 to +70 °C	±0.2 °C (-25 to +70 °C) ±0.4 °C (-50 to -25.1 °C)	60 s	0613 4611
• Robust, waterproof surface temperature probe, Pt100	<p>Fixed cable</p>	-50 to +400 °C	Class B*	40 s	0609 1973
Immers./penetr. probes	Illustration	Meas. range	Accuracy	t99	Part no.
• Waterproof NTC immersion/penetration probe	<p>Conn.: Fixed cable</p>	-50 to +150 °C	±0.5% of mv (+100 to +150 °C) ±0.2 °C (-25 to +74.9 °C) ±0.4 °C (remaining range)	10 s	0613 1212
• Robust, waterproof Pt100 immersion/penetration probe	<p>Fixed cable</p>	-50 to +400 °C	Class A (-50 to +300 °C), Class B (remaining range)*	12 s	0609 1273

¹⁾ Without protective glass

• The measuring instrument inside TopSafe is waterproof with this probe.

*According to standard 60751, the accuracies of Class A and B refer to -200 to +600 °C (Pt100)

testo 720
Accessories / Technical data

Food probes	Illustration	Meas. range	Accuracy	t ₉₉	Part no.
• Stainless steel NTC food probe (IP65) with PUR cable		-50 to +150 °C ²⁾ -25 to +120 °C	±0.5% of mv (+100 to +150 °C) ±0.2 °C (-25 to +74.9 °C) ±0.4 °C (remaining range)	8 s	0613 2211
• Stainless steel NTC food probe (IP67) with PTFE cable to +250°C		-50 to +150 °C	±0.5% of mv (+100 to +150 °C) ±0.2 °C (-25 to +74.9 °C) ±0.4 °C (remaining range)	8 s	0613 3311
• Robust NTC food penetration probe with special handle, reinforced PUR cable		-25 to +150 °C ²⁾	±0.5% of mv (+100 to +150 °C) ±0.2 °C (-25 to +74.9 °C) ±0.4 °C (remaining range)	7 s	0613 2411
• Frozen food probe NTC, corkscrew design (incl. plug-in wire)		-50 to +140 °C ²⁾	±0.5% of mv (+100 to +140 °C) ±0.2 °C (-25 to +74.9 °C) ±0.4 °C (remaining range)	20 s	0613 3211
• Robust, Pt100 stainless steel food probe (IP65)		-50 to +400 °C	Class A (-50 to +300 °C), Class B (remaining range) [*]	10 s	0609 2272

• The measuring instrument inside TopSafe is waterproof with this probe.

²⁾ Long-term measurement range +125°C, short-term +150°C or +140°C (2 minutes)
^{*}According to standard 60751, the accuracies of Class A and B refer to -200 to +600 °C (Pt100)

Accessories	Part no.
Accessories for measuring instrument	
9V rech. battery for instrument instead of battery	0515 0025
Recharger for 9V rechargeable battery for external recharging of 0515 0025 battery	0554 0025
Printer and Accessories	
Testo fast printer with wireless infrared interface, 1 roll thermal paper and 4 AA batteries	0554 0549
Spare thermal paper for printer (6 rolls) measurement data documentation legible for up to 10 years	0554 0568
Transport and Protection	
TopSafe, protects from impact and dirt (incl. 2 attachment magnets)	0516 0221
Case for measuring instrument and probes	0516 0210
Transport case for meas. instr. and probes (405 x 170 x 85 mm)	0516 0201
Transport case for measuring instrument, 3 probes and accessories (430 x 310 x 85 mm)	0516 0200
Other features	
Silicone heat paste (14g), T _{max} = +260°C improves heat transfer in surface probes	0554 0004
Calibration certificates	
ISO calibration certificate/temperature for air/immersion probes, calibration points -18°C; 0°C; +60°C	0520 0001
ISO calibration certificate/temperature Meas. instr. with air/immersion probe; cal. points 0°C; +150°C; +300°C	0520 0021
ISO calibration certificate/temperature meas. instr. with air/immersion probe; calibration points 0°C; +300°C; +600°C	0520 0031
DAkkS calibration certificate/temperature* meas. instr. with air/immersion probe; calibration points -20°C; 0°C; +60°C	0520 0211
ISO calibration certificate/temperature meas. instr. with surface probe; calibration points +60°C; +120°C; +180°C	0520 0071
DAkkS calibration certificate/temperature* contact surface temperature probes; calibration points +100°C; +200°C; +300°C	0520 0271

*Successor organization of the DKD

Technical data	Pt100	NTC
Probe type	Pt100	NTC
Meas. range	-100 to +800 °C	-50 to +150 °C
Accuracy ±1 digit	±0.2% of mv (+200 to +800 °C) ±0.2 °C (remaining range)	±0.2 °C (-25 to +40 °C) ±0.3 °C (+40.1 to +80 °C) ±0.4 °C (+80.1 to +125 °C) ±0.5 °C (remaining range)
Resolution	0.1 °C	0.1 °C
Oper. temp.	-20 to +50 °C	
Storage temp.	-30 to +70 °C	
Battery type	9V block battery	
Battery life	70 h	
Dimensions	182 x 64 x 40 mm	
Weight	171 g	
Material/Housing	ABS	
Warranty	2 years	

testo 735-1

The robust and compact measuring instrument with a probe socket for highly accurate Pt100 probes and two sockets for fast-action thermocouple probes. Readings from up to three additional temperature probes can be shown on the instrument's clear display; measurement data transmission is by radio i.e. wireless. A total of six channels can be collected in this way by the instrument. Using the highly accurate, plug-in Pt100 immersion/penetration probe, a system accuracy of 0.05 °C with a resolution of 0.001 °C is reached. The measurement system is therefore ideally suited for use as a working standard. Data measured by testo 735-1 can be transmitted by infrared to the Testo printer for documentation purposes. If cyclical printing is used, it is also possible to print data on the printer once every minute, for example.

testo 735-1, 3 channel temperature measuring instrument T/C Type K/T/J/S/Pt100, audible alarm, connection for max. 3 optional radio probes, incl. battery and calibration protocol

Part no.
0560 7351

testo 735-2

The robust and compact measuring instrument with a probe socket for highly accurate Pt100 probes and two sockets for fast-action thermocouple probes. Readings from up to three additional temperature probes can be displayed in the testo 735-2 measuring instrument's clear display; data transmission is by radio, i.e. wireless. The measurement values can be simultaneously transferred to a PC and stored there. In this way, a total of 6 channels is recorded by the measuring instrument. A system accuracy of 0.05 °C with a resolution of 0.001 °C is reached using the plug-in highly accurate Pt100 immersion/penetration probe. The measuring instrument is therefore ideally suited for use as a working standard.

Temperature characteristics are recorded in the instrument and then analysed in graphics and tables on your PC/Notebook. Data is printed on site on the Testo fast printer using infrared.

Selectable user profiles, i.e. allocation of specific function buttons to an application facilitate intuitive and fast operation. Individual protocols or measurement series can be stored according to site. Up to 99 sites can be stored in the instrument. The storage cycle is user-defined between 0.5 seconds and 24 hours.

testo 735-2, 3 channel temp. meas. instr. T/C Type K/T/J/S/Pt100, audible alarm, connection for max. 3 optional radio probes, with readings memory, PC software and USB data transmission cable, with battery and calibration protocol

Part no.
0563 7352

Highly accurate temperature measuring instrument with data memory

- System accuracy up to 0.05 °C
- Testo printer prints measurement data on site (optional)
- Cyclical printing of readings once every minute, for example (testo 735-1)
- Instrument memory for 10,000 readings (testo 735-2)
- PC software for filing and documenting measurement data (testo 735-2)
- Displays, saves and prints Delta T, min, max and mean values
- Audible alarm when limit values are exceeded
- Protection class IP65
- Accuracy over the entire measurement range thanks to system adjustment
- The measurement values can be displayed in the instrument and simultaneously transferred to a PC and stored (testo 735-2)



Technical data			
Probe type	Pt100 with probe 0614 0235	Pt100	Type K (NiCr-Ni)
Meas. range	-40 to +300 °C	-200 to +800 °C	-200 to +1370 °C
Accuracy ±1 digit	See probe data	±0.2 °C (-100 to +199.9 °C) ±0.2% of mv (remaining range)	±0.3 °C (-60 to +60 °C) ±(0.2 °C + 0.3% of mv) (remaining range)
Resolution	0.001 °C (-40 to +199.999 °C) 0.01 °C (remaining range)	0.05 °C	0.1 °C
Battery life	Approx. 60 h	Approx. 250 h	Approx. 300 h
Probe type	Type T (Cu-CuNi)	Type J (Fe-CuNi)	Type S (Pt10Rh-Pt)
Meas. range	-200 to +400 °C	-200 to +1000 °C	0 to +1760 °C
Accuracy ±1 digit	±0.3 °C (-60 to +60 °C) ±(0.2 °C + 0.3% of mv) (remaining range)	±0.3 °C (-60 to +60 °C) ±(0.2 °C + 0.3% of mv) (remaining range)	±1 °C (0 to +1760 °C)
Resolution	0.1 °C	0.1 °C	1 °C
Battery life	Approx. 300 h	Approx. 300 h	Approx. 300 h
Oper. temp.	-20 to +50 °C	Protection class IP65	
Storage temp.	-30 to +70 °C	Dimensions 220 x 74 x 46 mm	
Battery type	Alkali manganese, mignon, Type AA	Weight 428 g	
		Material/Housing ABS/TPE/Metal	
		Warranty 2 years	

testo 735
Probes

Laboratory probes	Illustration	Meas. range	Accuracy	t ₉₉	Part no.
Laboratory probe Pt100, glass-coated, exchangeable glass pipe (Duran 50), resistant to corrosive substances	<p>Fixed cable</p>	-50 to +400 °C	Class A (-50 to +300 °C), Class B (remaining range)**	45 s 12 s ¹⁾	0609 7072
					1) Without protective glass
Air probes	Illustration	Meas. range	Accuracy	t ₉₉	Part no.
Robust air probe, T/C Type K	<p>Fixed cable</p>	-60 to +400 °C	Class 2*	25 s	0602 1793
Efficient, robust air probe, Pt100	<p>Fixed cable</p>	-50 to +400 °C	Class A (-50 to +300 °C), Class B (remaining range)**	70 s	0609 1773
Robust, affordable air probe, T/C Type T	<p>Conn.: Fixed cable 1.2 m</p>	-50 to +350 °C	±0.2 °C (-20 to +70 °C) Class 1 (remaining range)*	25 s	0603 1793
Surface probes	Illustration	Meas. range	Accuracy	t ₉₉	Part no.
Robust, waterproof surface temperature probe, Pt100	<p>Fixed cable</p>	-50 to +400 °C	Class B**	40 s	0609 1973
Fast-action surface probe with sprung thermocouple strip, also for uneven surfaces, measurement range short-term to +500°C, TC Type K	<p>Fixed cable</p>	-60 to +300 °C	Class 2*	3 s	0602 0393
Fast-reaction paddle surface probe, for measurements in inaccessible places, e.g. narrow apertures and slots, TC Type K	<p>Conn.: Fixed cable</p>	0 to +300 °C	Class 2*	5 s	0602 0193
Efficient, waterproof surface probe with small measurement head for flat surfaces, TC Type K	<p>Fixed cable</p>	-60 to +1000 °C	Class 1*	20 s	0602 0693
Fast-action surface probe with sprung thermocouple strip, bent, also for uneven surfaces, measurement range short-term to +500°C, TC Type K	<p>Fixed cable</p>	-60 to +300 °C	Class 2*	3 s	0602 0993
Flat head surface probe with telescopic handle max. 680 mm for measurements at hard-to-access points, TC Type K	<p>Fixed cable, 1.6 m (correspondingly shorter when telescope extended)</p>	-50 to +250 °C	Class 2*	3 s	0602 2394
Magnetic probe, adhesive force approx. 20 N, with magnets, for measurements on metal surfaces, TC Type K	<p>Fixed cable</p>	-50 to +170 °C	Class 2*	150 s	0602 4792
Magnetic probe, adhesive force approx. 10 N, with magnets, for higher temp., for measurements on metal surfaces, TC Type K	<p>Fixed cable</p>	-50 to +400 °C	Class 2*		0602 4892
Waterproof surface probe with widened measurement tip for flat surfaces, T/C Type K	<p>Fixed cable</p>	-60 to +400 °C	Class 2*	30 s	0602 1993
Pipe wrap probe with Velcro strip, for temperature measurement on pipes with diameter up to max. 120 mm, Tmax +120°C, TC Type K	<p>Fixed cable</p>	-50 to +120 °C	Class 1*	90 s	0628 0020
Pipe wrap probe for pipe diameter 5 to 65 mm, with exchangeable measuring head. Meas. range short-term to +280°C, TC Type K	<p>Fixed cable</p>	-60 to +130 °C	Class 2*	5 s	0602 4592
Spare meas. head for pipe wrap probe, TC Type K		-60 to +130 °C	Class 2*	5 s	0602 0092
Clamp probe for measurements on pipes, pipe diameter 15 to 25 mm (max. 1"), meas. range short-term up to +130°C, TC Type K	<p>Fixed cable</p>	-50 to +100 °C	Class 2*	5 s	0602 4692
Waterproof surface probe with widened measurement tip for flat surfaces, T/C Type T	<p>Conn.: Fixed cable 1.2 m</p>	-50 to +350 °C	±0.2 °C (-20 to +70 °C) Class 1 (remaining range)*	30 s	0603 1993

*According to standard EN 60584-2, the accuracy of Class 1 refers to -40 to +1000 °C (Type K), Class 2 to -40 to +1200 °C (Type K), Class 3 to -200 to +40 °C (Type K).

**According to standard 60751, the accuracies of Class A and B refer to -200 to +600 °C (Pt100)

Immers./penetr. probes	Illustration	Meas. range	Accuracy	t99	Part no.
Robust, waterproof Pt100 immersion/penetration probe	114 mm 50 mm Ø 0.5 mm Ø 3.7 mm Fixed cable	-50 to +400 °C	Class A (-50 to +300 °C), Class B (remaining range)**	12 s	0609 1273
Highly accurate Pt100 immersion/penetration probe incl. calibration protocol (test points 0 °C and +157 °C)	295 mm Ø 0.4 mm Fixed cable	-40 to +300 °C	±0.05 °C (+0.01 to +100 °C) ±(0.05 °C +0.05% of mv) (remaining range)	60 s	0614 0235
Efficient and fast-action immersion probe, waterproof, TC Type K	300 mm Ø 1.5 mm Fixed cable	-60 to +1000 °C	Class 1*	2 s	0602 0593
Fast-action, waterproof immersion/penetration probe, TC Type K	60 mm 14 mm Ø 0.5 mm Ø 1.5 mm Fixed cable	-60 to +800 °C	Class 1*	3 s	0602 2693
Immersion tip, flexible, TC Type K	500 mm Ø 1.5 mm Fixed cable	-200 to +1000 °C	Class 1*	5 s	0602 5792
Immersion tip, flexible, TC Type K	500 mm Ø 1.5 mm Fixed cable	-200 to +40 °C	Class 3*	5 s	0602 5793
Immersion measurement tip, flexible, for measurements in air/exhaust gases (not suitable for measurements in smelters), TC Type K	1000 mm Ø 3 mm Fixed cable	-200 to +1300 °C	Class 1*	4 s	0602 5693
Waterproof immersion/penetration probe, TC Type K	114 mm 50 mm Ø 0.5 mm Ø 3.7 mm Fixed cable	-60 to +400 °C	Class 2*	7 s	0602 1293
Flexible, low-mass immersion measurement tip, ideal for measurements in small volumes such as petri dishes, or for surface measurements (e.g. attached with adhesive tape), TC Type K	500 mm Ø 0.25 mm Fixed cable Conn.: 2 m, FEP insulated thermal wire, temperature proof up to 200 °C, oval wire with dimensions: 2.2 mm x 1.4 mm	-200 to +1000 °C	Class 1*	1 s	0602 0493
Thermocouples	Illustration	Meas. range	Accuracy	t99	Part no.
Thermocouple with TC adapter, flexible, 800mm long, fibre glass, TC Type K	800 mm Ø 1.5 mm	-50 to +400 °C	Class 2*	5 s	0602 0644
Thermocouple with TC adapter, flexible, 1500mm long, fibre glass, TC Type K	1500 mm Ø 1.5 mm	-50 to +400 °C	Class 2*	5 s	0602 0645
Thermocouple with TC adapter, flexible, 1500mm long, PTFE, TC Type K	1500 mm	-50 to +250 °C	Class 2*	5 s	0602 0646
Food probes	Illustration	Meas. range	Accuracy	t99	Part no.
Robust, Pt100 stainless steel food probe (IP65)	125 mm 15 mm Ø 0.4 mm Ø 3 mm Fixed cable	-50 to +400 °C	Class A (-50 to +300 °C), Class B (remaining range)**	10 s	0609 2272
Waterproof food probe made of stainless steel (IP65), TC Type K	125 mm 30 mm Ø 0.4 mm Ø 3.2 mm Fixed cable	-60 to +400 °C	Class 2*	7 s	0602 2292
Robust food probe with special handle, IP 65, reinforced cable (PUR), T/C Type K	115 mm 30 mm Ø 0.5 mm Ø 3.5 mm Fixed cable	-60 to +400 °C	Class 1*	6 s	0602 2492
Waterproof super-fast needle probe, highly accurate measurements without visible penetration hole. Specially for food, ideal for hamburgers, steaks, pizza, eggs etc., T/C Type K	150 mm 15 mm Ø 0.14 mm Ø 0.1 mm Fixed cable	-60 to +250 °C	Class 1*	1s	0628 0026
Waterproof robust immersion/penetration probe with metal protection hose Tmax +230°C, e.g. for monitoring temp. in cooking oil, T/C Type K	240 mm Ø 0.4 mm Fixed cable	-50 to +230 °C	Class 1*	15 s	0628 1292
Stable, robust surface probe with PTFE standing area and metal protection hose Tmax +230 °C for cooking surfaces, heating and baking trays, T/C Type K	120 mm Ø 60 mm Fixed cable	-50 to +230 °C	Class 2*	45 s	0628 9992

*According to standard EN 60584-2, the accuracy of Class 1 refers to -40 to +1000 °C (Type K), Class 2 to -40 to +1200 °C (Type K), Class 3 to -200 to +40 °C (Type K).

**According to standard 60751, the accuracies of Class A and B refer to -200 to +600 °C (Pt100)

testo 735
Probes / Accessories

Food probes	Illustration	Meas. range	Accuracy	¹⁹⁹	Part no.
Robust food penetration probe with special handle, reinforced cable (PVC), T/C Type T		-50 to +350 °C	±0.2 °C (-20 to +70 °C) Class 1 (remaining range)*	6 s	0603 2492
Frozen food probe, corkscrew design, T/C Type T		-50 to +350 °C	±0.2 °C (-20 to +70 °C) Class 1 (remaining range)*	8 s	0603 3292
Stainless steel food probe (IP67) with PUR cable, T/C Type T		-50 to +350 °C	±0.2 °C (-20 to +70 °C) Class 1 (remaining range)*	7 s	0603 2192
Waterproof precision immersion/penetration probe without visible penetration hole, T/C Type T		-50 to +350 °C	±0.2 °C (-20 to +70 °C) Class 1 (remaining range)*		0603 2693
Stainless steel food probe (IP67), with PTFE cable to +250 °C, TC Type T		-50 to +350 °C	±0.2 °C (-20 to +70 °C) Class 1 (remaining range)*	7 s	0603 3392
Waterproof, super-quick needle probe for measurements without visible penetration hole, T/C Type T		-50 to +250 °C	±0.2 °C (-20 to +70 °C) Class 1 (remaining range)*	2 s	0628 0027
Quick needle probe to monitor cooking in oven, T/C Type T		-50 to +250 °C	±0.2 °C (-20 to +70 °C) Class 1 (remaining range)*	2 s	0628 0030
Measurement tip with T/C adapter Type T, ideal for fast-action measurement on incoming goods		-50 to +350 °C	Class 1*	5 s	0628 0023
Flexible oven probe, Tmax +250 °C, PTFE cable		-50 to +250 °C	Class 1*		0603 0646
Waterproof standard immersion/penetration probe, T/C Type T		-50 to +350 °C	±0.2 °C (-20 to +70 °C) Class 1 (remaining range)*	7 s	0603 1293

The measuring instrument inside TopSafe is waterproof with this probe.

* According to standard EN 60584-2, the accuracy of Class 1 refers to -40 to +350 °C (Type T).

See back flap for radio probes

Accessories	Part no.
Accessories for measuring instrument	
Plug-in mains adapter, 5 VDC 500 mA with European adapter, 100-250 VAC, 50-60 Hz	0554 0447
Printer and Accessories	
Testo fast printer with wireless infrared interface, 1 roll thermal paper and 4 AA batteries	0554 0549
Spare thermal paper for printer (6 rolls), measurement data documentation legible for up to 10 years	0554 0568
Spare thermal paper for printer (6 rolls)	0554 0569
External fast charger for 1-4 AA rech. batteries, incl. 4 Ni-MH rech. batteries with individual cell charging and charge control display, incl. impulse trickle charging, integrated discharge function, with built-in international mains plug, 100-240 V, 300 mA, 50/60 Hz	0554 0610
Transport and Protection	
Service case for basic equipment of measuring instrument and probes, dimensions: 400 x 310 x 96 mm	0516 0035
Service case for measuring instrument, probes and accessories, dimensions 520 x 380 x 120 mm	0516 0735
Other features	
Handle for attachable measurement tips	0409 1092
Extension cable, 5m, for thermocouple probe Type K	0554 0592
Silicone heat paste (14g), Tmax = +260°C improves heat transfer in surface probes	0554 0004

Accessories	Part no.
Calibration certificates	
ISO calibration certificate/temperature, for air/immersion probes, calibration points -18°C; 0°C; +60°C	0520 0001
ISO calibration certificate/temperature, Meas. instr. with air/immersion probe; cal. points 0°C; +150°C; +300°C	0520 0021
ISO calibration certificate/temperature, meas. instr. with surface probe; calibration points +60°C; +120°C; +180°C	0520 0071
DAkkS calibration certificate/temperature*, meas. instr. with air/immersion probe; calibration points -20°C; 0°C; +60°C	0520 0211
DAkkS calibration certificate/temperature*, contact surface temperature probes; calibration points +100°C; +200°C; +300°C	0520 0271
4-point adjustment, incl. ISO calibration certificate, calibration points freely selectable for probe 0614 0235	0520 0142
4-point adjustment, incl. DAkkS calibration certificate, calibration points freely selectable for probe 0614 0235*	0520 0241

Calibration certificates incl. adjustment for testo 735-2	
2-point adjustment incl. ISO calibration certificate, calibration points freely selectable	0520 0178
4-point adjustment incl. ISO calibration certificate, calibration points freely selectable	0520 0142
2-point adjustment incl. DAkkS calibration certificate, calibration points freely selectable*	0520 0278
4-point adjustment incl. DAkkS calibration certificate, calibration points freely selectable*	0520 0241

*Successor organization of the DKD

testo 950

Highly accurate reference measuring instrument

Precision reference class measuring instruments have everything the professional user needs to complete complicated measurement tasks efficiently, accurately and conveniently.

testo 950 includes the basic parameters temperature, CO₂, rpm, current and voltage. testo 950 can be upgraded to the multi-function measuring instrument, testo 400.

The measuring instrument can keep up with the measurement tasks at hand thanks to upgrades. Intelligent electronics ensure the latest technology is used thanks to software updates.

Upgradable and teachable, highly reliable and of the highest quality - they are the properties which guarantee that the customer is equipped for the future.

Incl Mass memory up to 500,000 readings!



Attachable printer
Readings are printed on site in seconds

Clear graphics display

Data communication with PC
Barcode reader

3 user defined function buttons

Saves (max. 500,000 readings) or prints at the touch of a button

User-friendly operation with cursor

Mains connection/quick battery recharging
2 user defined probe sockets, automatic recognition of all connected probes

testo 950, reference temperature meas. instr., with battery, Li cell and calibration protocol

Part no.
0563 9501

Recommended set

Precision measuring instrument with up to 0.05 °C system accuracy

- testo 950, reference temperature meas. instr., with battery, Li cell and calibration protocol, 2 channel instrument (thermocouple, Pt100, NTC) with option of connecting CO, CO₂, rpm and mV/mA transmitter (Part no. 0563 9501)
- Highly accurate immersion/penetration probe incl. calibration protocol (test points 0 °C, Plug-in head, connection cable 0430 0143 or 0430 0145 required (Part no. 0614 0240)
- Cable, 1.5 m long, connects probe with plug-in head to meas. instrument, PUR coating material (Part no. 0430 0143)
- Attachable printer (securely attached) including 1 roll of thermal paper and batteries, quickly prints readings on location (Part no. 0554 0570)
- System case (plastic) for measuring instrument, probes and accessories, probes in lid make it easy to find parts in case (540 x 440 x 130 mm) (Part no. 0516 0400)

We recommend:

4-point adjustment for probe 0614 0240, incl. ISO certificate at -40, 0, +100, +300 °C	0520 0142
4-point adjustment, incl. DAKkS calibration certificate, calibration points freely selectable*	0520 0241
ComSoft 3 - Professional with data management, incl. database, analysis and graphics function, data analysis, trend curve	0554 0830
RS232 cable, connects instrument to PC (1.8 m) for data transfer	0409 0178

*Successor organization of the DKD

Recommended set

Data management

- ComSoft 3 - Professional with data management, incl. database, analysis and graphics function, data analysis, trend curve (Part no. 0554 0830)
- RS232 cable, connects instrument to PC (1.8 m) for data transfer (Part no. 0409 0178)
- Barcode reader to read in measurement locations, quick and accurate allocation of reading to site (Part no. 0554 0460)

testo 950
Suitable probes at a glance

Probes Type K (NiCr-Ni)	Illustration	Meas. range	Accuracy	t99	Part no.
Thermocouple, made of fibre-glass insulated thermal pipes, pack of 5	2000 mm Please order adapter 0600 1693	-200 to +400 °C	Class 1**	5 s	0644 1109
Quick-action surface probe with sprung thermocouple strip, measuring range short-term to +500 °C	150 mm Conn.: Plug-in head, connection cable 0430 0143 or 0430 0145 required	-200 to +300 °C	Class 2**	3 s	0604 0194
Super quick-action surface probe, probe tip at 90° angle, with sprung thermocouple strip	100 mm Conn.: Plug-in head, connection cable 0430 0143 or 0430 0145 required	-200 to +300 °C	Class 2**	3 s	0604 0994
Robust surface probe with sprung thermocouple strip for high temperature range up to +700°C	200 mm Conn.: Fixed cable, coiled	-200 to +700 °C	Class 2**	3 s	0600 0394
Roller surface probe for measurements on rollers and rotating drums, max. circumferential velocity 18 to 400m/min	274 mm Conn.: Fixed cable, coiled	-50 to +240 °C	Class 2**		0600 5093
Magnetic probe, adhesive power approx. 20 N, with magnets, for measurements on metal surfaces	35 mm Conn.: Fixed cable	-50 to +170 °C	Class 2**	150 s	0600 4793
Magnetic probe, adhesive power approx. 10 N, with magnets, for higher temperatures, measures on metal surfaces	75 mm Conn.: Fixed cable	-50 to +400 °C	Class 2**		0600 4893
Adhesive thermocouple, pack of 2, carrier material: aluminium foil	Diameter extension 2 x 0.2 mm, 0.1 mm thick	-200 to +200 °C	Class 1**		0644 1607
Is fixed at the measuring point using conventional adhesives or silicone heat paste 0554 0004 . Please order adapter 0600 1693.					
Fast response immersion/penetration probe	150 mm Conn.: Plug-in head, connection cable 0430 0143 or 0430 0145 required	-200 to +400 °C	Class 1**	3 s	0604 0293
Super quick-action immersion/penetration probe for measurements in liquids	150 mm Conn.: Plug-in head, connection cable 0430 0143 or 0430 0145 required	-200 to +600 °C	Class 1**	1 s	0604 0493
Super quick-action immersion/penetration probe for high temperatures	470 mm Conn.: Plug-in head, connection cable 0430 0143 or 0430 0145 required	-200 to +1100 °C	Class 1**	1 s	0604 0593
Robust immersion/penetration probe made of V4A stainless steel, waterproof and oven-proof, e.g. for the food sector	150 mm Conn.: Fixed cable	-200 to +400 °C	Class 1**	3 s	0600 2593
Smelting probe for measurements in non-ferrous melting baths, with exchangeable measuring tip (Measurement tip lifetime: up to 500 measurements in aluminium smelter)	1100 mm Conn.: Fixed cable	-200 to +1250 °C	Class 1**	60 s	0600 5993
Pipe wrap probe for pipes with diameter of up to 2", for flow/return temp. meas. in hydronic systems	Conn.: Fixed cable	-60 to +130 °C	Class 2**	5 s	0600 4593
Spare meas. head for pipe wrap probe, TC Type K	15 mm 35 mm	-60 to +130 °C	Class 2**	5 s	0602 0092
Robust surface probe	150 mm Conn.: Plug-in head, connection cable 0430 0143 or 0430 0145 required	-200 to +600 °C	Class 1*	25 s	0604 9993 0614 9993*
Robust surface probe, at 90° angle, suitable for inaccessible places	130 mm Conn.: Plug-in head, connection cable 0430 0143 or 0430 0145 required	-200 to +600 °C	Class 1**	25 s	0604 9893 0614 9893*
Miniature surface probe for measurements on electronic components, small motors...	270 mm Conn.: Plug-in head, connection cable 0430 0143 or 0430 0145 required	-200 to +400 °C	Class 2*	3 s	0600 1494
Super quick-action immersion/penetration probe for measurements in gases and liquids with a low-mass tip	150 mm Conn.: Plug-in head, connection cable 0430 0143 or 0430 0145 required	-200 to +600 °C	Class 1*	1 s	0604 9794 0614 9794*

*with EEPROM: Precision adjustment for each probe at a measuring point; measuring range limits are saved in probe; t95 extrapolation; surface allowance in surface probe can be adapted to measuring task

** According to standard EN 60584-2, the accuracy of Class 1 refers to -40 to +1000 °C (Type K), Class 2 to -40 to +1200 °C (Type K), Class 3 to -200 to +40 °C (Type K).

Probes Type K (NiCr-Ni)	Illustration	Meas. range	Accuracy	t99	Part no.
Plug-in measuring tip, 750mm long, flexible, for high temperatures, outer casing: stainless steel 1.4541	750 mm Ø 3 mm	-200 to +900 °C	Class 1**	4 s	0600 5393
Please order handle with Part no. 0600 5593					
Plug-in measuring tip, 550mm long, flexible, for high temperatures, outer casing: Inconel 2.4816	550 mm Ø 3 mm	-200 to +1100 °C	Class 1**	4 s	0600 5793
Please order handle with Part no. 0600 5593					
Plug-in measuring tip, 1030mm long, flexible, for high temperatures, outer casing: Inconel 2.4816	1030 mm Ø 3 mm	-200 to +1100 °C	Class 1**	4 s	0600 5893
Please order handle with Part no. 0600 5593					

Probes Pt100	Illustration	Meas. range	Accuracy	t99	Part no.	
Standard air probe	150 mm Ø 3 mm	-200... +600 °C	Class A***	75 s	0604 9773	
Conn.: Plug-in head, connection cable 0430 0143 or 0430 0145 required						
Precision air probe	150 mm Ø 3 mm	-100 to +400 °C	1/10 Class B (0 to 100°C) 1/5 Class B (rem. range) to EN 60751***	75 s	0628 0017	
Conn.: Plug-in head, connection cable 0430 0143 or 0430 0145 required						
Robust surface probe	150 mm Ø 4 mm	-50 to +400 °C	Class B***	40 s	0604 9973	
Conn.: Plug-in head, connection cable 0430 0143 or 0430 0145 required						
Velcro probe for pipes with diameter of max. 75 mm	280 mm	-50 to +150 °C	Class B***	40 s	0628 0019	
Conn.: Fixed cable						
Standard immersion/penetration probe	200 mm Ø 3 mm	Stainless Steel	-200 to +400 °C	Class A***	20 s	0604 0273
Conn.: Plug-in head, connection cable 0430 0143 or 0430 0145 required						
Standard immersion/penetration probe	200 mm Ø 3 mm	Nickel	-200 to +550 °C	Class A***	20 s	0604 0274
Conn.: Plug-in head, connection cable 0430 0143 or 0430 0145 required						
Highly accurate immersion/penetration probe incl. calibration protocol (test points 0 °C)	295 mm Ø 4 mm	Stainless Steel	-40 to +300 °C	±0.05 °C (+0.01 to +100 °C) ±(0.05 °C ±0.05% of mv) (-40 to 0 °C) ±(0.05 °C ±0.05% of mv) (+100.01 to +300 °C)	60 s	0614 0240
Conn.: Plug-in head, connection cable 0430 0143 or 0430 0145 required						
Highly accurate immersion/penetration probe	200 mm Ø 3 mm		-100 to +400 °C	1/10 Class B (0 to 100°C) 1/5 Class B (rem. range) to EN 60751***	30 s	0628 0015
Conn.: Plug-in head, connection cable 0430 0143 or 0430 0145 required						
Flexible precision immersion probe, cable heat-proof up to +300°C	1000 mm Ø 3.5 mm	50 mm Ø 6 mm	-100 to +265 °C	1/10 Class B (0 to 100°C) 1/5 Class B (rem. range) to EN 60751***	80 s	0628 0016
Conn.: Plug-in head, connection cable 0430 0143 or 0430 0145 required						
Robust immersion/penetration probe with sharpened measuring tip, waterproof and oven-proof	150 mm Ø 3.5 mm	Ø 3 mm	-200 to +400 °C	Class A***	30 s	0604 2573
Conn.: Fixed cable						





Probes NTC	Illustration	Meas. range	Accuracy	t99	Part no.
Highly accurate air probe for air and gas temperature measurements with bare, mechanically protected sensor	150 mm Ø 9 mm	-40 to +130 °C	To UNI curve	60 s	0610 9714
Conn.: Fixed cable					
Globe thermometer to measure radiant heat	Ø 150 mm	0 to +120 °C	±0.5 °C (0 to +49.9 °C) ±1 °C (+50 to +120 °C) Accuracy corresponds to ISO 7243, ISO 7726, DIN EN 27726, DIN 33403 requirements		0554 0670
Conn.: Fixed cable					

*with EEPROM: Precision adjustment for each probe at a measuring point; measuring range limits are saved in probe; t99 extrapolation; surface allowance in surface probe can be adapted to measuring task

** According to standard EN 60584-2, the accuracy of Class 1 refers to -40 to +1000 °C (Type K), Class 2 to -40 to +1200 °C (Type K), Class 3 to -200 to +40 °C (Type K).

*** According to standard 60751, the accuracies of Class A and B refer to -200 to +600 °C (Pt100)

testo 950
More probes / Accessories

More probes	Illustration	Meas. range	Accuracy	Part no.
Ambient CO probe, for detecting CO in buildings and rooms	 Conn.: Fixed cable, 1.5 m	0 to +500 ppm CO	±5% of mv (+100.1 to +500 ppm CO) ±5 ppm CO (0 to +100 ppm CO)	0632 3331
CO ₂ probe measures indoor air quality and monitors the workplace. With plug-in head, connection cable 0430 0143 or 0430 0145 required	 Conn.: Plug-in head, connection cable 0430 0143 or 0430 0145 required	0 ... +1 Vol. % CO ₂ 0 ... +10000 ppm CO ₂	±(50 ppm CO ₂ ±2% of mv)(0 to +5000 ppm CO ₂) ±(100 ppm CO ₂ ±3% of mv)(+5001 to +10000 ppm CO ₂)	0632 1240
Mechanical rpm probe with plug-in head Included 2 probe tips Ø 8 and Ø 12 mm 1 hollow cone Ø 8 mm 1 surface speed disc Ø 19 mm to measure rotational speed: rpm = rotational speed in mm/s	 Conn.: Plug-in head, connection cable 0430 0143 or 0430 0145 required	20 to 20000 rpm	±1 digit	0640 0340
Current/voltage cable (±1 V, ±10 V, 20 mA)		0 to +1000 mV 0 to +10 V 0 to +20 mA	±1 mV (0 to +1000 mV) ±0.01 V (0 to +10 V) ±0.04 mA (0 to +20 mA)	0554 0007
4 to 20 mA interface for connection and intermittent power supply to transmitters (scaling via hand-held instrument), in robust metal housing with impact protection, incl. magnet for fast attachment	 Conn.: Plug-in head, connection cable 0430 0143 or 0430 0145 required	Channels 1 Auxiliary energy output 18V DC ± 20% max. connection load 30 mA	±0.04 mA	0554 0528

Accessories Probes	Part no.
Cable, 1.5 m long, connects probe with plug-in head to meas. instrument, PUR coating material	0430 0143
Cable, 5 m long, connects probe with plug-in head to measuring instrument, PUR coating material	0430 0145
Extension cable, 5 m long, between plug-in head cable and instrument, PUR coating material	0409 0063
Telescopic handle, max. 1 m, for probe with plug-in head, cable: 2.5 m long, PUR coating material	0430 0144
Adapter to connect NiCr-Ni thermocouples and probes with open wire ends	0600 1693
Handle for plug-in measuring tip	0600 5593
Silicone heat paste (14g), T _{max} = +260°C, improves heat transfer in surface probes	0554 0004
Spare measuring tip for smelting probe	0363 1712

Accessories	Part no.
Transport and Protection	
SoftCase (protects instrument from impact) with carrier strap, magnetic holder and probe holder, protects against impact and falls	0516 0401
SoftCase for attachable printer (protects printer from dirt/impact), protects from impact and falls	0516 0411
System case (plastic) for measuring instrument, probes and accessories, probes in lid make it easy to find parts in case (540 x 440 x 130 mm)	0516 0400
System case (aluminium) for measuring instrument, probes and accessories, probes in lid make it easy to find parts in case	0516 0410
Printer and accessories	
Attachable printer (securely attached) including 1 roll of thermal paper and batteries, quickly prints readings on location	0554 0570
Testo fast printer with wireless infrared interface, 1 roll thermal paper and 4 AA batteries	0554 0549
Fast testo 575 printer, incl. 1 roll of thermal paper and batteries, infrared thermal line printer with graphics function	0554 1775
External fast charger for 1-4 AA rech. batteries, incl. 4 Ni-MH rech. batteries with individual cell charging and charge control display, incl. impulse trickle charging, integrated discharge function, with built-in international mains plug, 100-240 V, 300 mA, 50/60 Hz	0554 0610
Spare thermal paper for printer (6 rolls)	0554 0569
Spare thermal paper for printer (6 rolls), measurement data documentation legible for up to 10 years	0554 0568
Label thermal paper (Testo patent) for testo 575 printer (6 rolls), can be applied directly	0554 0561
Additional accessories and spare parts	
Rech. batt. set for instr. (2 rech. 2.4V/1100mAh)	0554 0196
Lithium battery, button cell, type CR 2032, Spare Li cell to save RAM data, when changing battery and rech. battery	0515 0028
Update	
Humidity/pressure module , Upgrade via service (updates testo 950 to testo 650)	0450 4002
Velocity module, incl. volume flow, degree of turbulence... , upgrade via service (updates testo 650 to testo 400)	0450 4003
Barcode and Accessories	
Adhesive pockets (50 off) for printout, paper barcode labels...	0554 0116
Software and accessories	
ComSoft 3 - Professional with data management, incl. database, analysis and graphics function, data analysis, trend curve	0554 0830
RS232 cable, connects instrument to PC (1.8 m) for data transfer	0409 0178
Ethernet adapter, RS232 - Ethernet incl. software driver, mains unit, facilitates data communication in network	0554 1711

Accessories	Part no.
Calibration certificates	
ISO calibration certificate/temperature, for air/immersion probes, calibration points -18°C; 0°C; +60°C	0520 0001
ISO calibration certificate/temperature, Meas. instr. with air/immersion probe; cal. points 0°C; +150°C; +300°C	0520 0021
ISO calibration certificate/temperature, meas. instr. with surface probe; calibration points +60°C; +120°C; +180°C	0520 0071
4-point adjustment , incl. ISO calibration certificate , calibration points freely selectable for probe 0614 0240	0520 0142
4-point adjustment , incl. DAKkS calibration certificate, calibration points freely selectable for probe 0614 0240	0520 0241
DAkKS calibration certificate/temperature*, meas. instr. with air/immersion probe; calibration points -20°C; 0°C; +60°C	0520 0211
DAkKS calibration certificate/temperature*, contact surface temperature probes; calibration points +100°C; +200°C; +300°C	0520 0271

ISO/DAkKS calibration certificates for testo 950 are possible at user defined points within the measuring range.

*Successor organization of the DKD

testo 950
Technical data

Technical data			
Probe type	Pt100	Pt100 with probe 0614 0240	NTC
Meas. range	-200 to +800 °C	-40 to +300 °C	-40 to +150 °C
Accuracy ±1 digit	±0.1 °C (-49.9 to +99.9 °C) ±(0.1 °C + 0.1% of mv) remaining range	See probe data	±0.2 °C (-10 to +50 °C) ±0.4 °C (-40 to -10.1 °C) ±0.4 °C (+50.1 to +150 °C)
Resolution	0.01 °C (-99.9 to +300 °C) 0.1 °C (-200 to -100 °C) 0.1 °C (+300.1 to +800 °C)	Display 0.001°C (-40.000 to +300.000 °C) Instrument store 0.01°C ComSoft 3 0.01°C	0.1 °C

Probe type	Type K (NiCr-Ni)	Type S (Pt10Rh-Pt)	Type J (Fe-CuNi)
Meas. range	-200 to +1370 °C	0 to +1760 °C	-200 to +1000 °C
Accuracy ±1 digit	±(0.3 °C + 0.1% of mv)	±1 °C	±0.4 °C (-150 to +150 °C) ±1 °C (-200 to -150.1 °C) ±1 °C (+150.1 to +1000 °C)
Resolution	0.1 °C (-200 to +1370 °C)	1 °C	0.1 °C

Probe type	CO2 probe	CO probe	Mechanical
Meas. range	0 to +1 Vol. % CO ₂ 0 to +10000 ppm CO ₂	0 to +500 ppm CO	20 to 20000 rpm
Accuracy ±1 digit	See probe data	±5% of mv (0 to +500 ppm CO)	±1 digit
Resolution			1 rpm

Probe type	Current measurement	Voltage measurement
Meas. range	0 to +20 mA	0 to +10 V
Accuracy ±1 digit	±0.04 mA	±0.01 V
Resolution	0.01 mA	0.01 V

Oper. temp.	0 to +50 °C	Memory space: 1 MB, corresponds to approx. 500,000 readings Other features: automatic recognition of all connected probes Power supply: Battery/rech. batt., alternatively 8V mains unit Battery life in continuous operation with 2 TC probes: 18 h
Storage temp.	-25 to +60 °C	
Display	LCD, 4 lines	
Battery type	1,5 V AA	
Battery life	18 h	
Weight	500 g	
PC	RS232 interface	
Material/Housing	ABS	
Warranty	3 years	

testo 810
Air temperature and infrared surface temperature in one instrument

testo 810 allows the measurement of air temperature and simultaneous non-contact surface temperature measurement in one instrument

testo 810; 2-channel temperature measuring instrument with infrared thermometer with laser spot marking and integrated NTC air thermometer, incl. protective cap, batteries and calibration protocol

Part no.
0560 0810

- Infrared measurement with 1-point laser spot marking and 6:1 optics
- Display of difference between air and surface temperature
- Hold function and min./max. values
- Emissivity adjustable
- Display illumination
- Protective cap for safe storage
- Incl. wrist strap and belt holder
- Incl. calibration protocol

Technical data

Probe type	Infrared	NTC
Meas. range	-30 to +300 °C	-10 to +50 °C
Accuracy ±1 digit	±2.0 °C (-30 to +100 °C) ±2% of mv (remaining range)	±0.5 °C
Measurement rate	0.5 s	0.5 s
Resolution	0.1 °C	0.1 °C
Distance to measurement spot	6:1	
Meas. spot marking	1-point laser	
Emissivity	Adjustable 0.2 to 0.99	
Spectral range	8 to 14 µm	
		Oper. temp. -10 to +50 °C
		Battery type 2 batteries Type AAA
		Battery life 50 h (average, without display illumination)
		Dimensions 119 x 46 x 25 mm (incl. protective cap)
		Weight 90 g (incl. battery and protective cap)

Accessories

	Part no.
Adhesive tape, e.g. for bare surfaces (roll, L.: 10 m, W.: 25 mm), E = 0.95, temperature resistant to +250 °C	0554 0051
ISO calibration certificate/temperature, Infrared thermometers, calibration points -18°C, 0°C, +60°C	0520 0401
ISO calibration certificate/temperature, infrared thermometer; calibration points +60°C; +120°C; +180°C	0520 0002
ISO calibration certificate/temperature; for air/immersion probes, calibration points -8°C; 0°C; +40°C	0520 0181

testo 830-T1
Fast infrared thermometer with laser sighting (10:1 optics)

The fast and universal infrared thermometer with 1-point laser sighting and 10:1 optics in ergonomic "pistol design"

testo 830-T1, Infrared thermometer with 1 point laser sighting, adjustable limit values and alarm function, incl. batteries

Part no.
0560 8301

- Display of current value and Hold value
- Fast readings
- Laser sighting
- Adjustable alarm limits
- Audible and visual alarm if limits are exceeded
- User-friendly thanks to "Pistol design"
- Backlit display
- Adjustable emission factor (0.2 to 1.0)

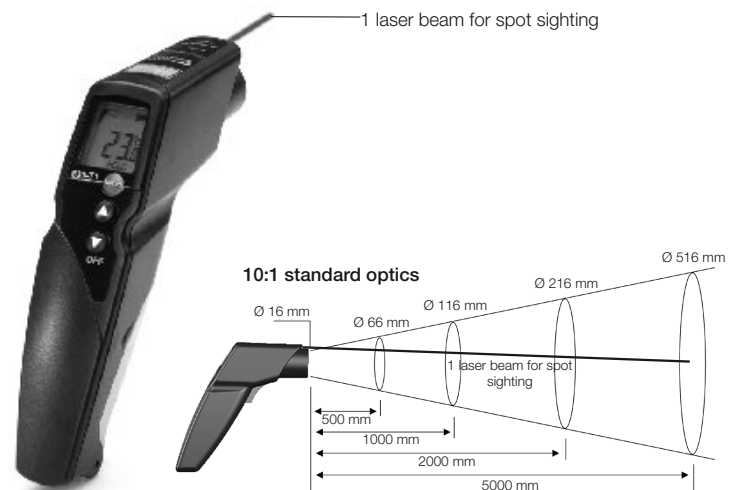
Technical data

Probe type	Infrared	
Spectral range	8 to 14 µm	Distance to measurement spot 10:1
Meas. range	-30 to +400 °C	Meas. spot marking 1-point laser
Accuracy ±1 digit	±1.5 °C or 1.5 % of mv (+0.1 to +400 °C) ±2 °C or ±2 % of mv (-30 to 0 °C) The larger value applies	Emissivity Adjustable 0.2 to 1.0
Measurement rate	0.5 s	Oper. temp. -20 to +50 °C
Resolution	0.5 °C	Storage temp. -40 to +70 °C
		Battery type 9V block battery
		Battery life 15 h
		Material/Housing ABS
		Dimensions 190 x 75 x 38 mm
		Weight 200 g

Accessories

	Part no.
Adhesive tape, e.g. for bare surfaces (roll, L.: 10 m, W.: 25 mm), E = 0.95, temperature resistant to +250 °C	0554 0051
Leather case to protect measuring instrument, including belt holder	0516 8302
9V rech. battery for instrument instead of battery	0515 0025
Recharger for 9V rechargeable battery for external recharging of 0515 0025 battery	0554 0025
ISO calibration certificate/temperature, infrared thermometer; calibration points +60°C; +120°C; +180°C	0520 0002

testo 830-T2

Infrared thermometer with 2-point laser sighting and probe socket (12:1 optics)

The fast and versatile infrared thermometer with 2-point laser marking and 12:1 optics. Possibility of connecting an external Type K probe for contact measurement.

In addition to the benefits of testo 830-T1:

- 2-point laser sighting
- Contact measurement with connectable temperature probe
- Emissivity determination with external TC probe

testo 830-T2, Infrared thermometer with 2-point laser sighting, adjustable limit values, alarm function and connection of external probes, incl. batteries

Part no.
0560 8302

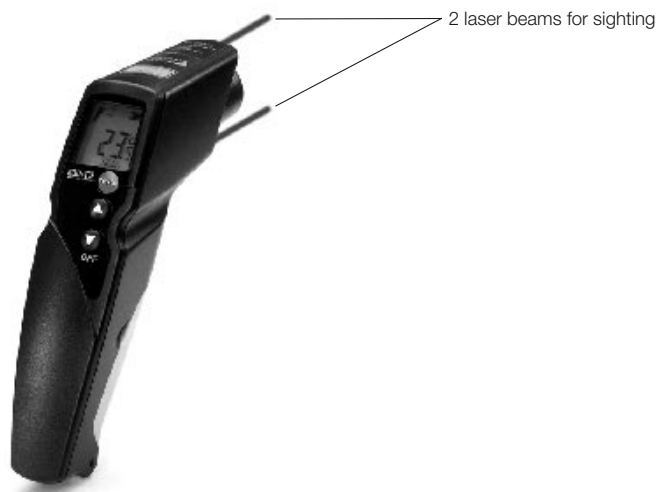

Fast measurement value recording at 2 measurements per second

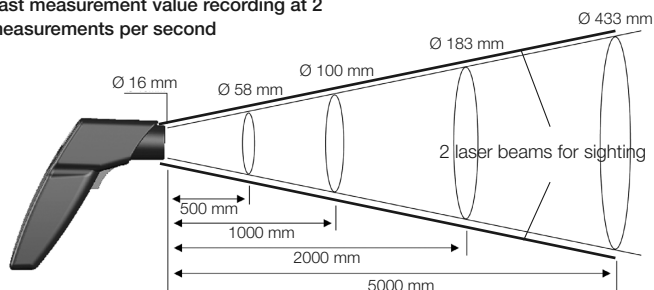

Set	Part no.
testo 830-T2 Set	0563 8302
<ul style="list-style-type: none"> - testo 830-T2, Infrared thermometer with 2-point laser sighting, adjustable limit values, alarm function and connection of external probes, incl. batteries - Fast-action surface probe with sprung thermocouple strip, also for uneven surfaces, measurement range short-term to +500°C, TC Type K - Leather case to protect measuring instrument, including belt holder 	

Technical data		
Probe type	Infrared	Type K (NiCr-Ni)
Spectral range	8 to 14 µm	
Meas. range	-30 to +400 °C	-50 to +500 °C
Accuracy ±1 digit	±1.5 °C or ±1.5% of mv (+0.1 to +400 °C) ±2 °C or ±2% of mv (-30 to 0 °C) The larger value applies	±0.5 °C +0.5% of mv
Resolution	0.5 °C	0.1 °C
Measurement rate	0.5 s	1.75 s
Meas. spot marking	2-point laser	
Emissivity	Settable 0.2 to 1.0	
Distance to measurement spot	12:1	

Oper. temp.	-20 to +50 °C	Battery life	15 h
Storage temp.	-40 to +70 °C	Dimensions	190 x 75 x 38 mm
Battery type	9V block battery	Weight	200 g

Accessories	Part no.
Adhesive tape, e.g. for bare surfaces (roll, L.: 10 m, W.: 25 mm), E = 0.95, temperature resistant to +250 °C	0554 0051
Leather case to protect measuring instrument, including belt holder	0516 8302
9V rech. battery for instrument instead of battery	0515 0025
Recharger for 9V rechargeable battery for external recharging of 0515 0025 battery	0554 0025
ISO calibration certificate/temperature, infrared thermometer; calibration points +60°C; +120°C; +180°C	0520 0002
ISO calibration certificate/temperature, for air/immersion probes, calibration point +60°C	0520 0063
ISO calibration certificate/temperature, for air/immersion probes, calibration points -18°C; 0°C; +60°C	0520 0001
ISO calibration certificate/temperature, meas. instr. with surface probe; calibration points +60°C; +120°C; +180°C	0520 0071
ISO calibration certificate/temperature, Meas. instr. with air/immersion probe; cal. points 0°C; +150°C; +300°C (Applies only to immersion/penetration probe 0602 2693)	0520 0021

Air probes	Illustration	Meas. range	Accuracy	t99	Part no.
Robust air probe, T/C Type K	Conn.: Fixed cable 1.2 m	-60 to +400 °C	Class 2*	25 s	0602 1793
Immersion/penetr. probes	Illustration	Meas. range	Accuracy	t99	Part no.
Waterproof immersion/penetration probe, TC Type K	Conn.: Fixed cable 1.2 m	-60 to +400 °C	Class 2*	7 s	0602 1293
Surface probes	Illustration	Meas. range	Accuracy	t99	Part no.
Fast-action surface probe with sprung thermocouple strip, also for uneven surfaces, measurement range short-term to +500°C, TC Type K	Conn.: Fixed cable 1.2 m	-60 to +300 °C	Class 2*	3 s	0602 0393

*According to standard 60584-2, the accuracy of Class 2 refers to -40 to +1200 °C (Type K).

Further probes see page 46/47

testo 830-T4

The fast and versatile infrared thermometer with 2-point laser marking and 30:1 optics. The surface temperature, also of smaller objects, can be measured at a safe distance. The diameter of the measurement spot is only 36 mm at a distance of 1 m. Possibility of connecting external temperature probes.

Infrared thermometer with 2-point laser marking and probe socket (30:1 optics)

- Display of current value and Hold value
- 30:1 optics for measuring temperature at a distance, even on small objects
- 2 laser beams for marking the measurement spot
- °C contact measurement with connectable TC probe
- Emissivity determination with external temperature probe
- Fast measurement value recording at two measurements per second
- Input of upper and lower limit value
- Audible and optical alarm when limit values are exceeded
- Display illumination



IR temperature measuring instrument with 30:1 optics and 2-point laser measurement spot sighting, incl. battery and factory calibration certificate with the meas. points +80 °C and +350 °C

Part no.
0560 8304

Set testo 830-T4

testo 830-T4 set, consisting of testo 830-T4 with protective leather case, incl. cross-band surface probe, battery and factory calibration certificate with the measurement points +80 °C and +350 °C

Part no.
0563 8304

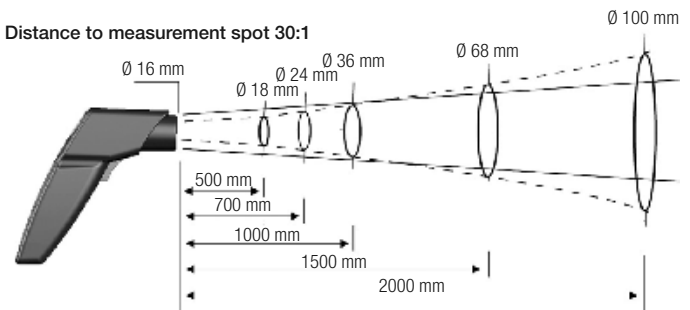
Distance to measurement spot 30:1

Technical data

Probe type	Infrared	Type K (NiCr-Ni)
Spectral range	8 to 14 µm	
Meas. range	-30 to +400 °C	-50 to +500 °C
Accuracy ±1 digit	±1,5 °C (-20 to 0 °C) ±2 °C (-30 to -20,1 °C) ±1 °C or 1% of mv (remaining range)	±0,5 °C +0,5% of mv
Resolution	0,1 °C	0,1 °C
Measurement rate	0,5 s	1,75 s
Meas. spot marking	2-point laser	
Emissivity	Settable 0.2 to 1.0	
Distance to measurement spot	30:1 (typical at a distance of 0.7 m to the measurement object 24 mm @ 700 mm (90%))	

Oper. temp.	-20 to +50 °C
Storage temp.	-40 to +70 °C
Battery type	9V block battery
Battery life	15 h

Material/Housing	ABS
Dimensions	190 x 75 x 38 mm
Weight	200 g

Accessories

	Part no.
Adhesive tape, e.g. for bare surfaces (roll, L.: 10 m, W.: 25 mm), E = 0.95, temperature resistant to +250 °C	0554 0051
Leather case to protect measuring instrument, including belt holder	0516 8302
9V rech. battery for instrument instead of battery	0515 0025
Recharger for 9V rechargeable battery for external recharging of 0515 0025 battery	0554 0025
ISO calibration certificate/temperature, infrared thermometer; calibration points +60°C; +120°C; +180°C	0520 0002
ISO calibration certificate/temperature, meas. instr. with surface probe; calibration points +60°C; +120°C; +180°C	0520 0071
ISO calibration certificate/temperature, for air/immersion probes, calibration point +60°C	0520 0063
ISO calibration certificate/temperature, for air/immersion probes, calibration points -18°C; 0°C; +60°C	0520 0001
ISO calibration certificate/temperature, Meas. instr. with air/immersion probe; cal. points 0°C; +150°C; +300°C (Applies only to immersion/penetration probe 0602 2693)	0520 0021

Surface probes

Fast-action surface probe with sprung thermocouple strip, also for uneven surfaces, measurement range short-term to +500°C, TC Type K

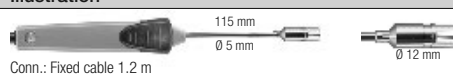
Illustration

Meas. range	Accuracy	t99	Part no.
-60 to +300 °C	Class 2*	3 s	0602 0393

*According to standard 60584-2, the accuracy of Class 2 refers to -40 to +1200 °C (Type K).

Probes see page 46/47

testo 830-T3

Non-contact temperature measurement with close focus optics (2.51 optics)

The fast infrared thermometer testo 830-T3 is especially suited to temperature measurements on surfaces with a small diameter. A two-point laser marks the measurement point exactly.

- Small measurement point of 2 mm, distance 25 mm
- °C contact measurement with attachable TC probe
- Backlit display
- Audible and optical alarm when limit values are exceeded
- Emissivity adjustable 0.2 to 1.0

IR temperature measuring instrument with close focus optics, incl. 2 point laser sighting, adjustable limit values and alarm function, contact temperature probe attachable, incl. battery

Part no.
0560 8303

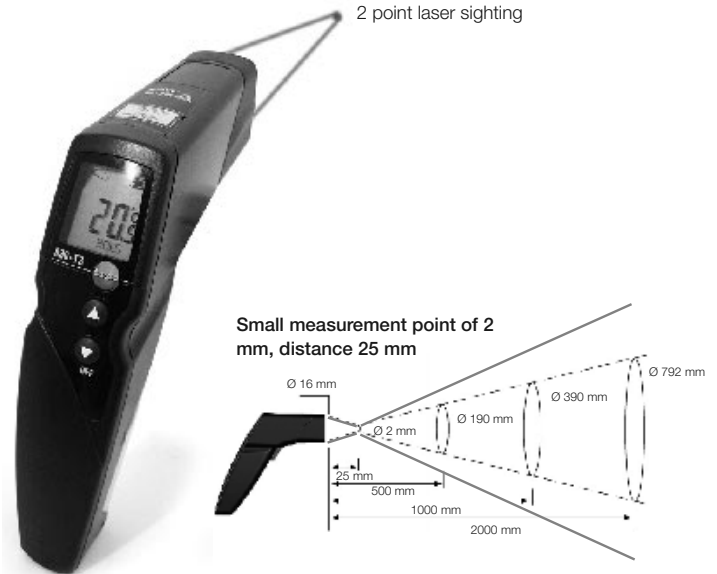

Technical data		
Probe type	Infrared	Type K (NiCr-Ni)
Spectral range	8 to 14 μm	
Meas. range	-25 to +400 °C	-50 to +500 °C
Accuracy ± 1 digit	± 1 °C (-20 to +100 °C) ± 2 °C or $\pm 2\%$ of mv (remaining range)	± 0.5 °C +0.5% of mv
Resolution	0.5 °C	0.1 °C
Measurement rate	0,5 s	1,75 s
Distance to measurement spot	2.5:1 2 mm @ 25 mm (90%)	
Meas. spot marking	2-point laser	
Emissivity	Settable 0.2 to 1.0	
Oper. temp.	-20 to +50 °C	Dimensions 155 x 136 x 38 mm
Storage temp.	-40 to +70 °C	Weight 200 g
Battery type	9V block battery	Warranty 2 years
Battery life	15 h	

Accessories	Part no.
Adhesive tape, e.g. for bare surfaces (roll, L.: 10 m, W.: 25 mm), E = 0.95, temperature resistant to +250 °C	0554 0051
Leather case to protect measuring instrument, including belt holder	0516 8302
9V rech. battery for instrument instead of battery	0515 0025
Recharger for 9V rechargeable battery for external recharging of 0515 0025 battery	0554 0025
ISO calibration certificate/temperature, infrared thermometer; calibration points +60°C; +120°C; +180°C	0520 0002
ISO calibration certificate/temperature, for air/immersion probes, calibration point +60°C	0520 0063
ISO calibration certificate/temperature, for air/immersion probes, calibration points -18°C; 0°C; +60°C	0520 0001
ISO calibration certificate/temperature, meas. instr. with surface probe; calibration points +60°C; +120°C; +180°C	0520 0071
ISO calibration certificate/temperature, Meas. instr. with air/immersion probe; cal. points 0°C; +150°C; +300°C (Applies only to immersion/penetration probe 0602 2693)	0520 0021

Air probes	Illustration	Meas. range	Accuracy	t99	Part no.
Robust air probe, T/C Type K		-60 to +400 °C	Class 2*	25 s	0602 1793
Immersion/penetr. probes	Illustration	Meas. range	Accuracy	t99	Part no.
Waterproof immersion/penetration probe, TC Type K		-60 to +400 °C	Class 2*	7 s	0602 1293
Surface probes	Illustration	Meas. range	Accuracy	t99	Part no.
Fast-action surface probe with sprung thermocouple strip, also for uneven surfaces, measurement range short-term to +500°C, TC Type K		-60 to +300 °C	Class 2*	3 s	0602 0393

*According to standard 60584-2, the accuracy of Class 2 refers to -40 to +1200 °C (Type K).

Further probes see page 46/47

testo 845
Infrared Thermometer with Switchable Optics (far-field/close focus)

For the first time, surface temperatures with smallest diameters can be measured accurately at short and long distances. The switchable optics for far-field and close focus measurement make this possible. Measurements in the far-field are made with an optical resolution of 75:1. Surface temperatures can thus be measured accurately even at greater distances from the object to be measured. At a distance of 1.2 metres from the object, the measurement point diameter is only 16 mm. A cross laser marks the measurement point exactly.

For measurements at a small distance from the object to be measured, the close focus optics provide a measurement point diameter of only 1 mm at a distance of 70 mm! Two laser points mark the measurement point.

- Switchable optics for far-field measurements (75:1) and close focus (1 mm, 70 mm distance)
- Especially bright cross laser sighting for indicating the actual measuring point
- Reference accuracy $\pm 0.75\text{ }^{\circ}\text{C}$ with super-fast measurement technology (scanning 100 ms)
- Backlit display (3-line) showing $^{\circ}\text{C}$, min./max. values, alarm limit values and degree of emission
- Optical and audible alarm when limit values are exceeded
- Probe socket for TC probes for determining emissivity
- Instrument memory for 90 measurement protocols
- PC software for archiving and documenting measurement data (included in delivery)
- Tripod fitting for online measurement via USB cable (included in delivery)
- Measurement data documentation on site with testo report printer
- Aluminium case for instrument and accessories (included)

testo 845, infrared temperature measuring instrument with cross laser marking and switchable optics for far-field and close focus measurement, incl. PC software with USB data transfer cable, aluminium case, battery and calibration protocol

Part no.
0563 8450

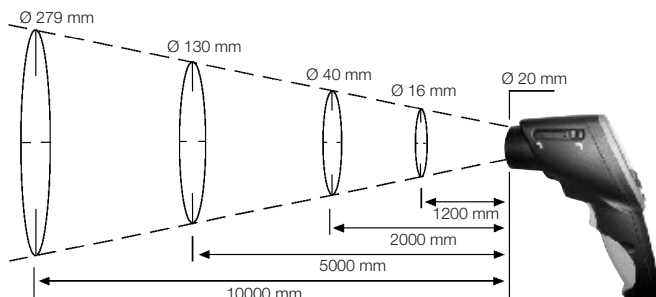
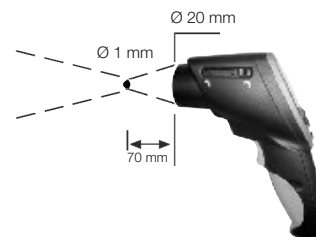
Far-field measurement

Close focus measurement

Switch to far-field measurement at a measurement distance > 250 mm.

Technical data

Probe type	Infrared	Type K (NiCr-Ni)
Meas. range	-35 to +950 $^{\circ}\text{C}$	-35 to +950 $^{\circ}\text{C}$
Spectral range	8 to 14 μm	
Accuracy ± 1 digit	$\pm 2.5\text{ }^{\circ}\text{C}$ (-35 to -20.1 $^{\circ}\text{C}$) $\pm 1.5\text{ }^{\circ}\text{C}$ (-20 to +19.9 $^{\circ}\text{C}$) $\pm 0.75\text{ }^{\circ}\text{C}$ (+20 to +99.9 $^{\circ}\text{C}$) $\pm 0.75\%$ of mv (+100 to +950 $^{\circ}\text{C}$)	$\pm 0.75\text{ }^{\circ}\text{C}$ (-35 to +75 $^{\circ}\text{C}$) $\pm 1\%$ of mv (+75.1 to +950 $^{\circ}\text{C}$)
Resolution	0.1 $^{\circ}\text{C}$	0.1 $^{\circ}\text{C}$
Measurement rate	t ₉₅ : 150 ms; Scanning Max/Min/Alarm: 100 ms	
Meas. spot marking	Cross-laser in the far-field 2-point laser in close focus	
Emission factor	Adjustable 0.1 to 1.0	
Distance to measurement spot	Far field: 75:1 16 mm @ 1200 mm (90%) Close focus: 1 mm @ 70 mm (90%)	
		Oper. temp. -20 to +50 $^{\circ}\text{C}$ Storage temp. -40 to +70 $^{\circ}\text{C}$ Battery type 2 AA batteries Battery life 25 h (without laser), 10 h (with laser without light), 5 h (with laser and 50% light)
		Material/Housing black/gray, metal screen
		Dimensions 155 x 58 x 195 mm Weight 465 g Warranty 2 years

Accessories

	Part no.
Humidity module, upgradeable for testo 845	0636 9784
Plug-in mains adapter, 5 VDC 500 mA with European adapter, 100-250 VAC, 50-60 Hz	0554 0447
External fast charger for 1-4 AA rech. batteries, incl. 4 Ni-MH rech. batteries with individual cell charging and charge control display, incl. impulse trickle charging, integrated discharge function, with built-in international mains plug, 100-240 V, 300 mA, 50/60 Hz	0554 0610
Testo fast printer with wireless infrared interface, 1 roll thermal paper and 4 AA batteries, for printing out measurements on site	0554 0549
Spare thermal paper for printer (6 rolls), measurement data documentation legible for up to 10 years	0554 0568
testo saline pots for control and humidity adjustment of humidity probes, 11.3 %RH and 75.3 %RH with adapter for humidity probe, quick checks or calibration of humidity probe	0554 0660
Adhesive tape, e.g. for bare surfaces (roll, L.: 10 m, W.: 25 mm), E = 0.95, temperature resistant to +250 $^{\circ}\text{C}$	0554 0051
Silicone heat paste (14g), T _{max} = +260 $^{\circ}\text{C}$, improves heat transfer in surface probes	0554 0004
ISO calibration certificate/temperature, infrared thermometer; calibration points +60 $^{\circ}\text{C}$; +120 $^{\circ}\text{C}$; +180 $^{\circ}\text{C}$	0520 0002
ISO calibration certificate/temperature, Infrared thermometers, calibration points -18 $^{\circ}\text{C}$, 0 $^{\circ}\text{C}$, +60 $^{\circ}\text{C}$	0520 0401
ISO calibration certificate/temperature, Meas. instr. with air/immersion probe; cal. points 0 $^{\circ}\text{C}$; +150 $^{\circ}\text{C}$; +300 $^{\circ}\text{C}$ (Applies only to immersion/penetration probe 0602 2693)	0520 0021

Probes see page 46/47

Air probes	Illustration	Meas. range	Accuracy	t99	Part no.
Robust air probe, T/C Type K	<p>115 mm Ø 4 mm</p> <p>Conn.: Fixed cable 1.2 m</p>	-60 to +400 °C	Class 2*	25 s	0602 1793
Immers./penetr. probes	Illustration	Meas. range	Accuracy	t99	Part no.
Efficient and fast-action immersion probe, waterproof, TC Type K	<p>Ø 1.5 mm 300 mm</p> <p>Conn.: Fixed cable 1.2 m</p>	-60 to +1000 °C	Class 1*	2 s	0602 0593
Fast-action, waterproof immersion/penetration probe, TC Type K (Calibration not possible over +300 °C)	<p>60 mm Ø 5 mm</p> <p>14 mm Ø 1.5 mm</p> <p>Conn.: Fixed cable 1.2 m</p>	-60 to +800 °C	Class 1*	3 s	0602 2693
Immersion tip, flexible, TC Type K	<p>Ø 1.5 mm 500 mm</p>	-200 to +1000 °C	Class 1*	5 s	0602 5792
Immersion measurement tip, flexible, for measurements in air/exhaust gases (not suitable for measurements in smelters), TC Type K	<p>Ø 3 mm 1000 mm</p>	-200 to +1300 °C	Class 1*	4 s	0602 5693
Immersion tip, flexible, TC Type K	<p>Ø 1.5 mm 500 mm</p>	-200 to +40 °C	Class 3*	5 s	0602 5793
Waterproof immersion/penetration probe, TC Type K	<p>114 mm Ø 5 mm</p> <p>50 mm Ø 3.7 mm</p> <p>Conn.: Fixed cable 1.2 m</p>	-60 to +400 °C	Class 2*	7 s	0602 1293
Surface probes	Illustration	Meas. range	Accuracy	t99	Part no.
Fast-reaction paddle surface probe, for measurements in inaccessible places, e.g. narrow apertures and slots, TC Type K	<p>145 mm Ø 8 mm</p> <p>40 mm Ø 7 mm</p> <p>Conn.: Fixed cable</p>	0 to +300 °C	Class 2*	5 s	0602 0193
Fast-action surface probe with sprung thermocouple strip, also for uneven surfaces, measurement range short-term to +500°C, TC Type K	<p>115 mm Ø 5 mm</p> <p>Ø 12 mm</p> <p>Conn.: Fixed cable 1.2 m</p>	-60 to +300 °C	Class 2*	3 s	0602 0393
Waterproof surface probe with widened measurement tip for flat surfaces, T/C Type K	<p>115 mm Ø 5 mm</p> <p>Ø 6 mm</p> <p>Conn.: Fixed cable 1.2 m</p>	-60 to +400 °C	Class 2*	30 s	0602 1993
Fast-action surface probe with sprung thermocouple strip, bent, also for uneven surfaces, measurement range short-term to +500°C, TC Type K	<p>80 mm Ø 5 mm</p> <p>50 mm Ø 12 mm</p> <p>Conn.: Fixed cable 1.2 m</p>	-60 to +300 °C	Class 2*	3 s	0602 0993
Efficient, waterproof surface probe with small measurement head for flat surfaces, TC Type K	<p>150 mm Ø 2.5 mm</p> <p>Ø 4 mm</p> <p>Conn.: Fixed cable 1.2 m</p>	-60 to +1000 °C	Class 1*	20 s	0602 0693
Flat head surface probe with telescopic handle max. 680 mm for measurements at hard-to-access points, TC Type K	<p>680 mm Ø 2.5 mm</p> <p>12 mm Ø 2.5 mm</p> <p>Conn.: Fixed cable, 1.6 m (correspondingly shorter when telescope extended)</p>	-50 to +250 °C	Class 2*	3 s	0602 2394
Magnetic probe, adhesive force approx. 20 N, with magnets, for measurements on metal surfaces, TC Type K	<p>35 mm Ø 20 mm</p> <p>Conn.: Fixed cable</p>	-50 to +170 °C	Class 2*	150 s	0602 4792
Magnetic probe, adhesive force approx. 10 N, with magnets, for higher temp., for measurements on metal surfaces, TC Type K	<p>75 mm Ø 21 mm</p> <p>Conn.: Fixed cable</p>	-50 to +400 °C	Class 2*		0602 4892
Pipe wrap probe with Velcro strip, for temperature measurement on pipes with diameter up to max. 120 mm, Tmax +120°C, TC Type K	<p>395 mm 20 mm</p> <p>Conn.: Fixed cable</p>	-50 to +120 °C	Class 1*	90 s	0628 0020
Pipe wrap probe for pipe diameter 5 to 65 mm, with exchangeable measuring head. Meas. range short-term to +280°C, TC Type K	<p>Conn.: Fixed cable</p>	-60 to +130 °C	Class 2*	5 s	0602 4592
Spare meas. head for pipe wrap probe, TC Type K	<p>35 mm 13 mm</p>	-60 to +130 °C	Class 2*	5 s	0602 0092
Clamp probe for measurements on pipes, pipe diameter 15 to 25 mm (max. 1"), meas. range short-term up to +130°C, TC Type K	<p>Conn.: Fixed cable</p>	-50 to +100 °C	Class 2*	5 s	0602 4692

*According to standard EN 60584-2, the accuracy of Class 1 refers to -40 to +1000 °C (Type K), Class 2 to -40 to +1200 °C (Type K), Class 3 to -200 to +40 °C (Type K)

testo 830-T2/-T3/-T4 • testo 845
Probes

Food probes	Illustration	Meas. range	Accuracy	t ₉₉	Part no.
Waterproof food probe made of stainless steel (IP65), TC Type K		-60 to +400 °C	Class 2*	7 s	0602 2292
Robust food probe with special handle, IP 65, reinforced cable (PUR), T/C Type K		-60 to +400 °C	Class 1*	6 s	0602 2492
Waterproof robust immersion/penetration probe with metal protection hose T _{max} +230°C, e.g. for monitoring temp. in cooking oil, T/C Type K		-50 to +230 °C	Class 1*	15 s	0628 1292

Thermocouples	Illustration	Meas. range	Accuracy	t ₉₉	Part no.
Thermocouple with TC adapter, flexible, 800mm long, fibre glass, TC Type K		-50 to +400 °C	Class 2*	5 s	0602 0644
Thermocouple with TC adapter, flexible, 1500mm long, fibre glass, TC Type K		-50 to +400 °C	Class 2*	5 s	0602 0645
Thermocouple with TC adapter, flexible, 1500mm long, PTFE, TC Type K		-50 to +250 °C	Class 2*	5 s	0602 0646

*According to standard EN 60584-2, the accuracy of Class 1 refers to -40 to +1000 °C (Type K), Class 2 to -40 to +1200 °C (Type K), Class 3 to -200 to +40 °C (Type K)

testo 875 / testo 876

See more – more flexibility – more security...

The thermal imager testo 875 is the reliable, solid tool for your daily use. With a temperature resolution of $< 80 \text{ mK}$, exchangeable lenses and an integrated digital camera, you discover weak spots in buildings quickly and securely with the thermal imager testo 875. You localize leakage precisely, and detect defective insulation directly.

The thermal imager testo 876 stands out thanks to its large rotatable display. This allows you to keep the display in view when thermographing in any position, securely reaching every corner. Thanks to exchangeable lenses, you can guarantee that you always have the right image section in your display.

- High image quality due to NETD $< 80 \text{ mK}$
- Exchangeable lenses
- Integrated digital camera
- Automatic Hot/Cold Spot Recognition
- Special measurement mode for detecting areas with danger of mould
- Lens protection glass
- Flexible rotatable display (testo 876)
- Motor focus for one-hand operation (testo 876)
- Voice recording with the practical headset (testo 876)
- Min/Max on Area calculation (testo 876)



The Testo thermal imagers stand out thanks to:



Professional analysis software

The clearly structured and user-friendly PC software allows the comprehensive analysis and evaluation of thermograms. You can now process, analyze and document several parallel infrared images in a report together with their respective real images. In order to achieve precise analysis results, it is possible to correct the thermal image according to the different emissivities of the various materials by area, right up to individual pixels. The pro software is included in delivery with all Testo thermal imagers.



Exchangeable lenses for more flexibility

A wide-angle and a telephoto lens allow adaptation to the different sizes and distances of measurement objects. The 32° standard lens shows a large image section, ensuring a fast overview. The 9° telephoto lens offer the possibility of detecting smaller details reliably, even from a greater distance. The Testo exchangeable lenses for individual thermography.



fold-out, rotatable display

Thanks to the fold-out, rotatable display, you have clear view in any position when thermographing



Motor focus for one-hand operation

With the motor focus, you can focus any infrared image quickly and easily.

testo 881 / testo 882
... with the thermal imagers from Testo

The thermal imager testo 881 with the best thermal sensitivity of < 50 mK provides highest image quality. This allows you to measure even the smallest temperature differences, and obtain high resolution IR images at any time. A wide-angle and a telephoto lens allow adaptation to the different sizes and distances of measurement objects.

The thermal imager testo 882 in ergonomic pistol design, with 320 x 240 pixels, stands out thanks to even more precise infrared images. With 76,800 temperature measuring points, it sees every detail on the measured object. This makes it even easier for you to detect anomalies and weaknesses from greater distances.

- High image quality due to NETD <50mK (testo 881)
- High image quality due to NETD <60mK (testo 882)
- Exchangeable lenses (testo 881)
- Built-in digital camera with power LEDs
- Special measurement mode for detecting areas with danger of mould
- Voice recording with the practical headset
- Image sensor with 320 x 240 pixels (testo 882)
- Large field of view thanks to 32° lens
- Isotherm display in instrument
- Min/Max on Area calculation
- Measuring range up to 550 °C optionally possible



The Testo thermal imagers stand out thanks to:

Soft-Case for your thermal imager

The thermal imager is always safely transported with the practical Soft-Case. It no longer needs to be held in your hand or stored in the case between measurements, but can be toted easily using the shoulder strap – day-to-day work is more flexible, both hands are free.

Intuitive menu

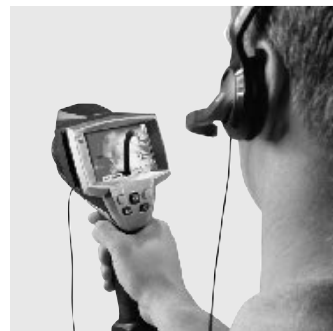
The one-hand operation, with motor focus and 5-way joystick, offers a fast and exact limitation of possible damage, and supports targeted maintenance. The easy creation of file structures reduces to a minimum the administrative effort for the planning and management of the images, measurement sites and tours.

Voice recording with the practical headset

With the integrated voice recording, you can comment any infrared image directly during the application. This valuable information is stored together with the thermal image.

Built-in digital camera with power LEDs

In addition to the infrared recording, you store a parallel real image of the measurement site with all thermal imagers with an integrated digital camera. The power LEDs (testo 881 and testo 882) guarantee you optimum illumination of dark areas when recording real images.

testo 875

The thermal imager testo 875 is the reliable, solid tool for your daily use. With a temperature resolution of < 80 mK, exchangeable lenses and an integrated digital camera, you discover weak spots in buildings quickly and securely with the thermal imager testo 875. You localize leakage precisely, and detect defective insulation directly.

For you, that means: You see more and have more reliability when thermographing!

The thermal imager for daily use

- High image quality due to NETD < 80 mK
- Exchangeable lenses
- Integrated digital camera
- Automatic Hot/Cold Spot Recognition
- Special measurement mode for detecting areas with danger of mould
- Lens protection glass



testo 875-1

- Detector 160 x 120 pixels
- NETD < 80 mK
- Temperature range -20 to $+280$ °C
- Image refresh rate 9 Hz
- Standard lens $32^\circ \times 23^\circ$
- Auto Hot/Cold Spot Recognition

Order no.

0560 8751

testo 875-2

- Detector 160 x 120 pixels
- NETD < 80 mK
- Temperature range -20 to $+280$ °C
- Image refresh rate 9 Hz
- Standard lens $32^\circ \times 23^\circ$
- Exchangeable telephoto lens $9^\circ \times 7^\circ$ (optional)
- Integrated digital camera
- Display of surface moisture distribution
- Auto Hot/Cold Spot Recognition

Order no.

0560 8752

Set testo 875-2

In addition to the equipment of the testo 875-2, the testo 875-2 set also includes:

- Telephoto lens $9^\circ \times 7^\circ$
- Lens protection glass
- Additional battery
- Fast battery charger
- Sun Shield

Order no.

0563 8752



The imager is delivered in a robust case incl. pro software, SD card, USB cable, mains unit, Li ion rechargeable battery and tripod adapter.

testo 876

The thermal imager testo 876 stands out thanks to its large rotatable display. This allows you to keep the display in view when thermographing in any position, securely reaching every corner. Thanks to exchangeable lenses, you can guarantee that you always have the right image section in your display.

For you, that means: You see more and have more flexibility when thermographing!

The thermal imager in flexible camcorder design

- Fold-out, rotatable display
- High image quality due to NETD < 80 mK
- Exchangeable lenses
- Integrated digital camera
- Motor focus for one-hand operation
- Voice recording with the practical headset
- Special measurement mode for detecting areas with danger of mould
- Min/Max on Area calculation
- Lens protection glass



testo 876

- Detector 160 x 120 pixels
NETD < 80 mK
- Temperature range -20 to +280 °C
- Image refresh rate 9 Hz
- Standard lens 32° x 23°
- Exchangeable telephoto lens 9° x 7° (optional)
- Integrated digital camera
- Voice recording using headset
- Motor focus
- Display of surface moisture distribution
- Isotherm display in instrument
- Min-/Max on Area calculation
- Auto Hot/Cold Spot Recognition

Order no.

0560 8761

testo 876 set

In addition to the equipment of the testo 876-2, the testo 876-2 set also includes:

- Telephoto lens 9° x 7°
- Lens protection glass
- Additional battery
- Fast battery charger

Order no.

0560 8762



The imager is delivered in a robust case incl. pro software, carrying strap, SD card, USB cable, mains unit, and Li ion rechargeable battery.

testo 881

The thermal imager testo 881 with the best thermal sensitivity of 50 mK provides highest image quality. This allows you to measure even the smallest temperature differences, and obtain high resolution IR images at any time. A wide-angle and a telephoto lens allow adaptation to the different sizes and distances of measurement objects.

For you, that means: You see more and discover even more when thermographing!

The thermal imager with the best NETD 50 mK

- Highest image quality due to NETD 50 mK
- Voice recording with the practical headset
- Built-in digital camera with power LEDs
- Exchangeable lenses
- Isotherm display in instrument
- Min/Max on Area calculation
- Lens protection glass
- Measuring range up to 550 °C (optionally possible)
- Special measurement mode for detecting areas with danger of mould



testo 881-1

- Detector 160 x 120 pixels NETD < 50 mK
- Temperature range -20 to +350 °C
- Image refresh rate 33 Hz*
- Lens 32° x 23°
- Integrated digital camera
- Laser**
- Auto Hot/Cold Spot Recognition

Order no.

0563 0881 V1

Set testo 881-2

In addition to the equipment of the testo 881-2, the set also includes:

- Telephoto lens 9° x 7°
- Additional battery
- Charger
- Soft case

Order no.

0563 0881 V6

testo 881-2

- Detector 160 x 120 pixels NETD < 50 mK
- Temperature range -20 to +350 °C
- Image refresh rate 33 Hz*
- Lens 32° x 23°
- Exchangeable telephoto lens 9° x 7° (optional)
- High temperature measurement up to 550 °C (optional)
- Integrated digital camera
- Integrated power LEDs
- Voice recording using the headset
- Laser**
- Motor focus
- Display of surface moisture distribution
- Isotherm display in instrument
- Min-/Max on Area calculation
- Auto Hot/Cold Spot Recognition
- Germanium lens protection glass
- Special measurement mode for detecting areas with danger of mould

Order no.

0563 0881 V5

Order suitable accessories in a case:

	Order no.	t881-1	t881-2	t881-2 set
Exchangeable telephoto lens 9° x 7°	A1		(✓)	✓
Germanium lens protection glass	C1	(✓)	✓	✓
Additional battery	D1	(✓)	(✓)	✓
Fast battery charger	E1	(✓)	(✓)	✓
Soft case	H1	(✓)	(✓)	✓
High temperature measurement up to 550 °C	G1		(✓)	(✓)



(✓) Optional ✓ Standard

* inside the EU, outside 9 Hz

** excepting USA, China and Japan

testo 882

The thermal imager testo 882 in ergonomic pistol design, with 320 x 240 pixels, stands out thanks to even more precise infrared images. With 76,800 temperature measuring points, it sees every detail on the measured object. This makes it even easier for you to detect anomalies and weaknesses from greater distances, and you work even more quickly.

For you, that means: You see more and have more security when thermographing!

The thermal imager with 320 x 240 pixels

- Image sensor with 320 x 240 pixels
- Large field of view due to 32° lens
- High image quality due to NETD 60 mK
- Voice recording with the practical headset
- Built-in digital camera with power LEDs
- Min/Max on Area calculation
- Lens protection glass
- Measuring range up to 550 °C (optionally possible)
- Special measurement mode for detecting areas with danger of mould
- Isotherm display in instrument



testo 882

- Detector 320 x 240 pixels
NETD < 60 mK
- Temperature range -20 to +350 °C
- Image refresh rate 33 Hz*
- Lens 32° x 23°
- High temperature measurement up to 550 °C (optional)
- Integrated digital camera
- Integrated power LEDs
- Voice recording using the headset
- Laser**
- Motor focus
- Display of surface moisture distribution
- Isotherm display in instrument
- Min-/Max on Area calculation
- Auto Hot/Cold Spot Recognition

Order no.

0560 0882

Order suitable accessories in a case:

	Order no.
Germanium lens protection glass	C1
Additional battery	D1
Fast battery charger	E1
Soft case	H1
High temperature measurement up to 550 °C	G1



* inside the EU, outside 9 Hz

** excepting USA, China and Japan

The imager is delivered in a robust case incl. pro software, SD card, USB cable, mains unit, Li ion rechargeable battery and tripod adapter.

testo 875	Part no.
Fast battery charger; Desktop charging station for two rechargeable batteries for the optimization of the charging time	0554 8801
Additional battery Additional Lithium ion rechargeable battery for extending the operating time	0554 8802
Lens protection glass Special Germanium protective glass for optimum protection of the lens from dust and scratching	0554 8805
Retrofit telephoto lens (testo 875-2 only). Please contact our customer service	-
Sun Shield Special sun shield for the display of the thermal imager in bright surroundings	0554 8806
Soft case Practical carrying option for the thermal imager incl. carrying strap	0554 8814
Aluminium tripod Professional, extremely light and stable aluminium tripod with Quick-Release legs and 3-way tripod head	0554 8804
Emissivity adhesive tape Adhesive tape e. g. for shiny surfaces (roll, L.: 10 m, W.: 25 mm), E=0.95, temperature-proof up to +250 °C	0554 0051
Car charging adapter Practical charging option for the thermal imager when travelling by car – can be used anywhere	0554 8817
ISO calibration certificates Calibration points at 0 °C, 25 °C, 50 °C	0520 0489
Calibration points at 0 °C, 100 °C, 200 °C	0520 0490
Freely selectable calibration point in the range -18 °C to 250 °C	0520 0495

testo 876	Part no.
Fast battery charger; Desktop charging station for two rechargeable batteries for the optimization of the charging time	0554 8851
Additional battery Additional Lithium ion rechargeable battery for extending the operating time	0554 8852
Lens protection glass Special Germanium protective glass for optimum protection of the lens from dust and scratching	0554 8805
Retrofit telephoto lens Please contact our customer service	-
Aluminium tripod Professional, extremely light and stable aluminium tripod with Quick-Release legs and 3-way tripod head	0554 8804
Emissivity adhesive tape Adhesive tape e. g. for shiny surfaces (roll, L.: 10 m, W.: 25 mm), E=0.95, temperature-proof up to +250 °C	0554 0051
Car charging adapter Practical charging option for the thermal imager when travelling by car – can be used anywhere	0554 8817
ISO calibration certificates Calibration points at 0 °C, 25 °C, 50 °C	0520 0489
Calibration points at 0 °C, 100 °C, 200 °C	0520 0490
Freely selectable calibration point in the range -18 °C to 250 °C	0520 0495

testo 875 / 876 / 881 / 882
Aluminium tripod

Lens protection glass

Sun Shield

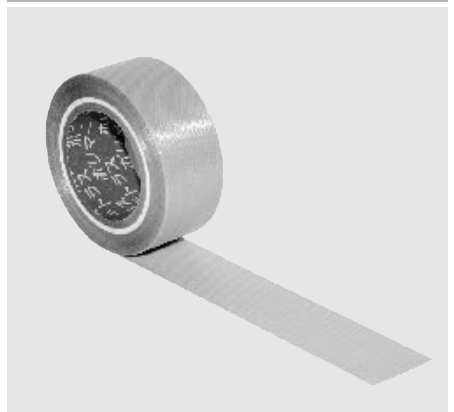
Emissivity adhesive tape

testo 881	Part no.
Fast battery charger; Desktop charging station for two rechargeable batteries for the optimization of the charging time	0554 8801
Additional battery Additional Lithium ion rechargeable battery for extending the operating time	0554 8802
Lens protection glass Special Germanium protective glass for optimum protection of the lens from dust and scratching	0554 8805
Retrofit telephoto lens (testo 882 only). Please contact our customer service	-
Retrofit high temperature measurement (testo 881-2 only) Please contact our customer service	-
Sun Shield Special sun shield for the display of the thermal imager in bright surroundings	0554 8806
Soft case Practical carrying option for the thermal imager incl. carrying strap	0554 8814
Aluminium tripod Professional, extremely light and stable aluminium tripod with Quick-Release legs and 3-way tripod head	0554 8804
Emissivity adhesive tape Adhesive tape e. g. for shiny surfaces (roll, L.: 10 m, W.: 25 mm), E=0.95, temperature-proof up to +250 °C	0554 0051
Car charging adapter Practical charging option for the thermal imager when travelling by car – can be used anywhere	0554 8817
ISO calibration certificates Calibration points at 0 °C, 25 °C, 50 °C	0520 0489
Calibration points at 0 °C, 100 °C, 200 °C	0520 0490
Freely selectable calibration point in the range -18 °C to 250 °C	0520 0495

testo 882	Part no.
Fast battery charger; Desktop charging station for two rechargeable batteries for the optimization of the charging time	0554 8801
Additional battery Additional Lithium ion rechargeable battery for extending the operating time	0554 8802
Lens protection glass Special Germanium protective glass for optimum protection of the lens from dust and scratching	0554 8805
Retrofit high temperature measurement Please contact our customer service	-
Sun Shield Special sun shield for the display of the thermal imager in bright surroundings	0554 8806
Soft case Practical carrying option for the thermal imager incl. carrying strap	0554 8814
Aluminium tripod Professional, extremely light and stable aluminium tripod with Quick-Release legs and 3-way tripod head	0554 8804
Emissivity adhesive tape Adhesive tape e. g. for shiny surfaces (roll, L.: 10 m, W.: 25 mm), E=0.95, temperature-proof up to +250 °C	0554 0051
Car charging adapter Practical charging option for the thermal imager when travelling by car – can be used anywhere	0554 8817
ISO calibration certificates Calibration points at 0 °C, 25 °C, 50 °C	0520 0489
Calibration points at 0 °C, 100 °C, 200 °C	0520 0490
Freely selectable calibration point in the range -18 °C to 250 °C	0520 0495

testo 875 / 876 / 881 / 882
Soft case

Battery and fast charger

Battery and fast charger

Car charging adapter

testo 875 / testo 876 **Technical data**

	testo 875-1	testo 875-2	testo 876
Product data			
Image output			
Infrared			
Detector type	FPA 160 x 120 pixels, a.Si		
Thermal sensitivity (NETD)	< 80 mK at 30 °C		
Field of view / min. focusing distance	32° x 23° / 0.1 m (standard lens)	32° x 23° / 0.1 m (standard lens) 9° x 7° / 0.5 m (telephoto lens)	
Geometric resolution (IFOV)	3.3 mrad (standard lens)	3.3 mrad (standard lens) 1.0 mrad (telephoto lens)	
Image refresh rate	9 Hz		
Focus	manual		manual and motor focus
Spectral range	8 to 14 µm		
Visual			
Image size / min. focusing distance	–	640 x 480 pixels / 0.4 m	
Image presentation			
Image display	3,5" LCD with 320 x 240 pixels		
Display options	IR image only		IR image only / real image only / IR and real image
Video output	USB 2.0		
Colour palettes	4 options: iron, rainbow, blue-red, shades of grey		
Measurement			
Temperature range	-20 °C ... 100 °C / 0 ° to +280 °C (switchable)		
Accuracy	±2 °C, ±2% of m. v. (-20 °C to +280 °C)		
Emissivity / reflected temperature compensation	0.01 to 1 / manual		
Imager equipment			
Digital camera	–		✓
Power LEDs		–	
Motor focus	–		✓
Standard lens (32° x 23°)	–	optional	optional
Telephoto lens (9° x 7°)	–	–	–
Laser measuring spot marking	–		✓
Voice recording	–		yes (using manual input)
Display of surface moisture distribution	–		yes (using manual input)
Measuring functions			
Measurement	Centre point		Standard measurement (1-point)
Hot/Cold Spot Recognition		✓	
Isotherms	–		✓
Min-/Max on Area	–		✓
Image storage			
File format	.bmt; export options in .bmp, .jpg, .png, .csv, .xls		
Storage device	SD card 2GB (approx. 3.000 images)		
Power supply			
Battery type	Fast-charging, Li-ion battery can be changed on-site		
Operating time	approx. 4 hours		
Charging options	in instrument or optionally in charger, with car adapter		
Mains operation		✓	
Ambient conditions			
Operating temperature range	-15 °C to +40 °C		
Storage temperature range	-30 °C to +60 °C		
Air humidity	20% to 80% non-condensing		
Housing protection class	IP54		
Vibration (IEC 68-2-6)	2G		
Physical features			
Weight	approx. 900 g		
Dimensions (L x W x H) in mm	152 x 108 x 262 mm		approx. 210 x 85 x 97
Tripod mounting	yes, with adapter		✓
Housing	ABS		
PC software			
System requirements	Windows XP (Service Pack 2), Windows Vista, Windows 7, interface USB 2.0		
Standards, tests, warranty			
EU Directive	2004 / 108 / EC		
Warranty	2 years		

testo 881 / testo 882
Technical data

Product data	testo 881-1	testo 881-2	testo 882
Image output			
Infrared			
Detector type	FPA 160 x 120 pixels, a.Si		FPA 320 x 240 pixels, a.Si
Thermal sensitivity (NETD)	< 50 mK at 30 °C		< 60 mK at 30 °C
Field of view / min. focusing distance	32° x 23° / 0,1 m	32° x 23° / 0.1 m (standard lens) 9° x 7° / 0.5 m (telephoto lens)	32° x 23° / 0,2 m
Geometric resolution (IFOV)	3.3 mrad (standard lens)	3.3 mrad (standard lens) 1.0 mrad (telephoto lens)	1.7 mrad
Image refresh rate	33 Hz for EU, otherwise 9 Hz		
Focus	manual	manual and motor focus	
Spectral range	8 to 14 µm		
Visual			
Image size / min. focusing distance	640 x 480 pixels / 0.4 m		
Image presentation			
Image display	3,5" LCD with 320 x 240 pixels		
Display options	IR image only / real image only/ IR and real image		
Video output	USB 2.0		
Colour palettes	9 options: iron, rainbow, cold-hot, blue-red, grey, inverted grey, sepia, Testo, iron HT		
Measurement			
Temperature range	-20 °C ... 100 °C / 0 °to +350 °C (switchable)		
High temperature measurement (optional)	–	+350 °C ... +550 °C	
Accuracy		±2 °C, ±2% of m. v. (-20 °C to +350 °C)	
	–	±3% of m.v. (+350 °C to +550 °C)	
Emissivity / reflected temperature compensation	0.01 to 1 / manual		
Imager equipment			
Digital camera		✓	
Power LEDs	–		✓
Motor focus	–		✓
Standard lens (32° x 23°)		✓	
Telephoto lens (9° x 7°)	–	optional	–
Laser measuring spot marking		(Laser classification 635 nm, Cl.2)*	
	–		✓
Voice recording	–		yes (using manual input)
Display of surface moisture distribution	–		
Measuring functions			
Measurement	Standard measurement (1-point) / Two-point measurement		
Hot/Cold Spot Recognition		✓	
Isotherms	–		✓
Min-/Max on Area	–		✓
Image storage			
File format	.bmt; export options in .bmp, .jpg, .png, .csv, .xls		
Storage device	SD card 2GB (approx. 3.000 images)		
Power supply			
Battery type	Fast-charging, Li-ion battery can be changed on-site		
Operating time	approx. 4 hours		
Charging options	in instrument or optionally in charger, with car adapter		
Mains operation		✓	
Ambient conditions			
Operating temperature range	-15 °C to +40 °C		
Storage temperature range	-30 °C to +60 °C		
Air humidity	20% to 80% non-condensing		
Housing protection class	IP54		
Vibration (IEC 68-2-6)	2G		
Physical features			
Weight	approx. 900 g		
Dimensions (L x W x H) in mm	152 x 108 x 262		
Tripod mounting	yes, with adapter		
Housing	ABS		
PC software			
System requirements	Windows XP (Service Pack 2), Windows Vista, Windows 7, interface USB 2.0		
Standards, tests, warranty			
EU Directive	2004 / 108 / EC		
Warranty	2 years		

* excepting USA, China and Japan

Feature	testo 875-1	testo 875-2	testo 876	testo 881-1	testo 881-2	testo 882
Detector size (in pixels)	160 x 120					320 x 240
Thermal sensitivity (NETD)	< 80 mK		< 50 mK		< 60 mK	
Temperature measuring range	-20 °C to +280 °C		-20 °C to +350 °C			
Image refresh rate	9 Hz		33 Hz*			
Standard lens 32°	✓	✓	✓	✓	✓	✓
Exchangeable telephoto lens 9°	-	(✓)	(✓)	-	(✓)	-
Rotatable display	-	-	✓	-	-	-
High temperature up to 550 °C	-	-	-	-	(✓)	(✓)
Auto Hot/Cold Spot Recognition	✓	✓	✓	✓	✓	✓
Min-/Max on Area calculation	-	-	✓	-	✓	✓
Isotherm function	-	-	✓	-	✓	✓
Display of surface moisture via manual input	-	✓	✓	-	✓	✓
Voice recording	-	-	✓	-	✓	✓
Integrated digital camera	-	✓	✓	✓	✓	✓
Integrated LEDs	-	-	-	-	✓	✓
Motor focus	-	-	✓	-	✓	✓
Laser**	-	-	-	✓	✓	✓

(✓) Optional ✓ Standard

* within the EU, outside 9 Hz ** excepting USA, China and Japan.

Your practical benefit

The detector size indicates the number of temperature measurement points with which the thermal imager is equipped. The more pixels, the more detailed and clearer are the measurement objects presented.

The NETD displays the smallest temperature difference which can be resolved by the imager. A low NETD guarantees the resolution of the smallest temperature differences. The rule of thumb is: the smaller this value is, the better is the measurement resolution.

The temperature range of your thermal imager informs you, up to which temperature your imager is able to record and measure the heat radiation of objects.

The display refresh rate informs as to how frequently the thermal imager is refreshed per second.

The 32° lens records a large image section, creating an ideal overview of the temperature distribution of a measurement object – there is more in the image at a glance.

The exchangeable telephoto lens assists in the measurement of smaller details and visualizes them even at greater distances in your thermal image.

Thanks to the rotatable display, you can thermograph with assurance from any position. Undesired reflections on the display are now avoided.

With the high temperature option, the measuring range can be flexibly extended. Thanks to a high temperature filter, the measurement of temperatures up to 550 °C is possible.

The coldest and the hottest spot of your measurement object are automatically marked in the thermal image in the imager display – critical heat spots are detected at a glance.

The minimum and maximum values of an image section can be determined directly on site and at a glance.

The optical colour alarm localizes critical areas easily and directly in the thermal image. All points whose temperature values are within a pre-defined range, are marked in colour.

Via the manual input of ambient temperature, air humidity and dewpoint, mould risk spots are visualized in the thermal image at a glance.

Localized weak spots can be easily commented using voice recording. You thus document valuable additional information directly on site.

Faster and easier object inspection thanks to the display of infrared and real image. The digital photo is automatically stored in addition to every infrared image.

The power LEDs guarantee you optimum illumination of dark areas when recording real images.

The dynamic motor focus allows you to focus the infrared image with one hand.

The perfect support for orientation as to which part of the object is being measured.



testo 875



testo 876



testo 881



testo 882

testo 805

Mini infrared thermometer, pocket-size (1:1 optics)

The compact 80 mm infrared thermometer fits into any pocket and is always within reach e.g. for measurements in Incoming goods and for checking the cold shelves in supermarkets. Also ideal for rapid measurements in the food industry and in the home.

- Practical and compact, pocket-size
- High accuracy in the critical range for food
- Water-proof and robust on account of dishwasher-safe protection sleeve TopSafe (IP65)
- Minimum and maximum value display
- Scan mode for long-term measurements



testo 805, Mini infrared thermometer and battery

Part no.
0560 8051

Technical data

Probe type	Integrated infrared sensor		
Meas. range	-25 to +250 °C	Oper. temp.	0 to +50 °C
Accuracy	±3 °C (-25 to -21 °C)	Storage temp.	-20 to +65 °C
±1 digit	±2 °C (-20 to -2.1 °C)	Material/Housing	ABS
	±1 °C (-2 to +40 °C)	Battery type	1 x lithium type: CR 2032
	±1.5 °C (+40.1 to +150 °C)	Battery life	40 h (typical)
	±2% of mv (+150.1 to +250 °C)	Reaction time	< 1.0 s
Distance to measurement spot	1:1	Emissivity	0.95 (adjustable to 0.95 or 1.00)
Resolution	0.1 °C (-9.9 to +199.9 °C)	Dimensions	80 x 31 x 19 mm
	1 °C (remaining range)	Weight	28 g

Set

	Part no.
Set for fast inspections	
testo 805 Mini infrared thermometer, TopSafe and battery	0563 8051
Accessories	Part no.
TopSafe, robust, waterproof protection case (IP65)	0516 8051
ISO calibration certificate/Temperature, Infrared thermometers, calibration points 0°C, +60°C	0520 0452

testo 826-T1
Infrared food thermometer (6:1 optics)

testo 826-T1 for non-contact and quick temperature checks on food - packaging is not damaged. The adjustable alarm (flashing display) indicates immediately if a limit value has been exceeded.

- Screening test - measurement, without damaging the packaging
- Small and practical
- Upper and lower limit value monitoring with optical alarm (flashing display)
- Included: TopSafe (IP67) protection case, robust and hygienic, dishwasher-safe
- TopSafe case protects the instrument from dust, dirt and water ingress
- Wall/belt holder included
- Water-proof and robust thanks to TopSafe (IP67)



testo 826-T1, Infrared thermometer without sighting, with TopSafe and wall/belt holder

Part no.
0563 8261

Technical data

Meas. range	-50 to +300 °C
Spectral range	8 to 14 µm
Accuracy ±1 digit	±1.5 °C (-20 to +100 °C) ±2 °C or 2% of mv (remaining range)
Resolution	0.5 °C
Measurement rate	0,5 s
Distance to measurement spot	6:1
Emissivity	0.95 to 1

Oper. temp.	0 to +50 °C
Storage temp.	-40 to +70 °C
Battery type	2 lithium batteries (CR2032)
Battery life	Approx. 150 h
Dimensions	148 x 34.4 x 19 mm
Display	LCD, 1 line
Weight	80 g
Warranty	2 years

Accessories

ISO calibration certificate/temperature, Infrared thermometers, calibration points -18°C, 0°C, +60°C

Part no.

0520 0401

testo 826-T2
Infrared food thermometer with laser sighting (6:1 optics)

In addition to the above advantages of testo 826-T1, testo 826-T2 has laser sighting and an audible alarm which signals when a fixed limit value has been exceeded.

- Screening test - measurement, without damaging the packaging
- Small and practical
- Upper and lower limit value monitoring with optical alarm (flashing display)
- Included: TopSafe (IP67) protection case, robust and hygienic, dishwasher-safe
- TopSafe case protects the instrument from dust, dirt and water ingress
- Wall/belt holder included
- Water-proof and robust thanks to TopSafe (IP67)



Spot is marked by laser beam

Audible alarm if limit value is exceeded

testo 826-T2, Infrared thermometer with laser sighting and audible alarm, incl. TopSafe and wall/belt holder

Part no.
0563 8262

Technical data

Meas. range	-50 to +300 °C
Spectral range	8 to 14 µm
Accuracy ±1 digit	±1.5 °C (-20 to +100 °C) ±2 °C or 2% of mv (remaining range)
Resolution	0.5 °C
Measurement rate	0,5 s
Distance to measurement spot	6:1
Emissivity	0.95 to 1
Meas. spot marking	1-point laser

Oper. temp.	-20 to +50 °C
Storage temp.	-40 to +70 °C
Battery type	2 AAA micro batteries
Battery life	Approx. 20 h
Dimensions	148 x 34.4 x 19 mm
Display	LCD, 1 line
Weight	80 g
Warranty	2 years

Accessories

ISO calibration certificate/temperature, Infrared thermometers, calibration points -18°C, 0°C, +60°C

Part no.

0520 0401

testo 826-T3

Infrared thermometer with penetration probe (6:1 optics)

testo 826-T3, quick non-contact measurement and core temperature measurement in one instrument. The surface temperature is measured with the infrared side while the measuring tip on the penetration side is used to determine the core temperature.

testo 826-T3, 2 in 1 thermometer incl. TopSafe, wall/belt holder, probe protection cap and frozen food drill

Part no.
0563 8263

- Penetration thermometer and non-contact infrared thermometer in one compact instrument
- Spot check with infrared side without damaging packaging
- Core temperature measurement with thin, robust measuring tip
- Upper and lower limit value monitoring with optical alarm (flashing display)
- TopSafe case protects instrument from dust, dirt, impact and water ingress



Only in combination with TopSafe

Technical data		
Probe type	Infrared	NTC
Meas. range	-50 to +300 °C	-50 to +230 °C
Spectral range	8 to 14 µm	
Accuracy ±1 digit	±1.5 °C (-20 to +100 °C) ±2 °C or 2% of mv (remaining range)	±0.5 °C (-20 to +99.9 °C) ±1 °C or 1% of mv (remaining range)
Resolution	0.5 °C	0.1 °C
Measurement rate	0,5 s	1,25 s
Emissivity	0.95 to 1	
Distance to measurement spot	6:1	
Battery life		
	Oper. temp.	0 to +50 °C
	Storage temp.	-40 to +70 °C
	Battery type	2 lithium batteries (CR2032)
	Display	LCD, 1 line
	Weight	80 g
	Dimensions	148 x 34.4 x 19 mm
	Warranty	2 years

Accessories	Part no.
ISO calibration certificate/temperature, for air/immersion probes, calibration point -18°C	0520 0061
ISO calibration certificate/temperature, for air/immersion probes, calibration point 0°C	0520 0062
ISO calibration certificate/temperature, For air/immersion probes, calibration points -18°C; +60°C	0520 0043
ISO calibration certificate/temperature, for air/immersion probes, calibration points -18°C; 0°C; +60°C	0520 0001
ISO calibration certificate/temperature, Infrared thermometers, calibration points -18°C, 0°C, +60°C	0520 0401
ISO calibration certificate/temperature, Infrared thermometers, calibration points 0°C, +60°C	0520 0452

testo 826-T4

Infrared thermometer with penetration probe and laser sighting (6:1 optics)

testo 826-T4 is the top model from the testo 826 series. In addition to the above-mentioned benefits of testo 826-T3, testo 826-T4 also has a laser sighting and a reliable audible alarm.

testo 826-T4, 2 in 1 thermometer with laser and alarm, TopSafe, wall/belt holder, protection cap and frozen food drill

Part no.
0563 8264

- Penetration thermometer and non-contact infrared thermometer in one compact instrument
- Spot check with infrared side without damaging packaging
- Core temperature measurement with thin, robust measuring tip
- Upper and lower limit value monitoring with optical alarm (flashing display)
- TopSafe case protects instrument from dust, dirt, impact and water ingress



Only in combination with TopSafe

Technical data		
Probe type	Infrared	NTC
Meas. range	-50 to +300 °C	-50 to +230 °C
Spectral range	8 to 14 µm	
Accuracy ±1 digit	±1.5 °C (-20 to +100 °C) ±2 °C or 2% of mv (remaining range)	±0.5 °C (-20 to +99.9 °C) ±1 °C or 1% of mv (remaining range)
Resolution	0.5 °C	0.1 °C
Measurement rate	0,5 s	1,25 s
Distance to measurement spot	6:1	
Emissivity	0.95 to 1	
Meas. spot marking	1-point laser	
Battery type		
	Oper. temp.	-20 to +50 °C
	Storage temp.	-40 to +70 °C
	Display	LCD, 1 line
	Weight	80 g
	Dimensions	148 x 34.4 x 19 mm
	Warranty	2 years

Accessories	Part no.
ISO calibration certificate/temperature, for air/immersion probes, calibration point -18°C	0520 0061
ISO calibration certificate/temperature, for air/immersion probes, calibration point 0°C	0520 0062
ISO calibration certificate/temperature, For air/immersion probes, calibration points -18°C; +60°C	0520 0043
ISO calibration certificate/temperature, for air/immersion probes, calibration points -18°C; 0°C; +60°C	0520 0001
ISO calibration certificate/temperature, Infrared thermometers, calibration points -18°C, 0°C, +60°C	0520 0401
ISO calibration certificate/temperature, Infrared thermometers, calibration points 0°C, +60°C	0520 0452

testo 831
Distance thermometer for infrared monitoring measurements in the food sector (30:1 optics)

Thanks to its 30:1 optics, the measurement spot diameter is only 3.6 cm at a distance of 1 m. This means that even small objects such as yoghurt pots can be easily measured at a distance. Measurement errors are avoided due to a 2-point laser which indicates the exact measurement spot. At two measurements per second, the testo 831 is so fast that measurements on palletes or refrigerated shelves can be carried out in seconds.

- Infrared thermometer with 30:1 optics
- Broad measurement range of -30 to +210 °C
- Backlit display
- Alarm limit values can be set and are optically and audibly indicated
- Including belt holder and factory calibration certificate
- Also available as a set with the core thermometer testo 106



testo 831, infrared thermometer including belt holder, battery, instruction manual and factory calibration certificate with the measurement points -20 and +80 °C

Set with testo 831 and testo 106

Set testo 831 and testo 106 - Infrared thermometer including belt holder, battery, instruction manual and factory calibration certificate with the measurement points -20 and +80 °C, and penetration thermometer testo 106 including TopSafe, belt holder, battery and instruction manual

Part no.
0560 8310

Part no.
0563 8310

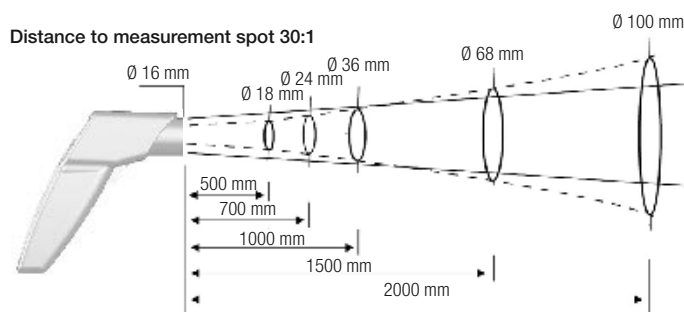
Technical data

Probe type	Infrared
Meas. range	-30 to +210 °C
Spectral range	8 to 14 μm
Accuracy ±1 digit	±1,5 °C or ±1,5% of mv (-20 to +210 °C) ± 2 °C or ±2% of mv (remaining range)
Resolution	0,5 °C
Measurement rate	0,5 s
Distance to measurement spot	30:1
Emissivity	Adjustable 0.2 to 1.0

Oper. temp.	-20 to +50 °C
Storage temp.	-40 to +70 °C
Battery type	9V block battery
Battery life	15 h
Display	Illuminated LCD
Protection class	IP30
Dimensions	190 x 75 x 38 mm
Weight	200 g
Warranty	2 years

Accessories

Accessories	Part no.
ISO calibration certificate/temperature, Infrared thermometers, calibration points -18°C, 0°C, +60°C	0520 0401
ISO calibration certificate/Temperature, Infrared thermometers, calibration points 0°C, +60°C	0520 0452
9V rech. battery for instrument instead of battery	0515 0025
Recharger for 9V rechargeable battery for external recharging of 0515 0025 battery	0554 0025

testo Saveris base

The base is the heart of testo Saveris and can save 40,000 readings per measurement channel independent of the PC. This corresponds to around one year of memory capacity at a measuring rate of 15 minutes. An emergency battery ensures that an alarm is transmitted and that no existing data is lost in the event of a power failure.

The system data and alarms are visible via the display of the Saveris base. Even without the PC running, the base issues an alarm by means of an LED if the limit value is exceeded, or optionally via SMS and via a relay output to which an alarm transmitter can be connected.

In total, a base can incorporate 150 radio and Ethernet probes or 254 measurement channels. The Saveris base is connected to the PC either via USB or Ethernet cable. The Saveris base thereby offers flexibility with the highest data security.

testo Saveris wireless probe

The testo Saveris radio probes measure temperature and humidity. In the measuring cycle, the probes save the recorded measurement data and send it to the central base at regular intervals. If a limit value is exceeded, a radio link is established immediately. Through bidirectional transmission, the radio probe and the base are in mutual contact. This therefore ensures that the measurement data is only recorded by the base and is not interfered with by other radio systems.

An alarm sounds in the event that the radio link is interrupted by obstacles. The memory in the probe ensures that the measurement data is not lost in the event of an interference in the radio link. An optimized battery design ensures a long running life of the probe memory.

In free field, the transmission path is approx. 300 m at a frequency of 868 MHz and approx. 100 m at a frequency of 2.4 GHz. In buildings, the transmission path is strongly influenced by structural conditions such as walls, refrigerator doors or metal doors. The radio link can be improved or lengthened under poor structural conditions by using a router. Because the radio probe and the router show the quality of their radio link, the probe can personally be positioned optimally by the user.

Probe versions with internal and external sensors allow the adaptation to every application. The radio probes are available with or without a display as an option. Current measurement data, the battery status and the quality of the radio link are shown on the display.

testo Saveris analog coupler

The two versions of the analog coupler (wireless/Ethernet) allow the inclusion of further measurement parameters into the testo Saveris monitoring system, by integrating all transmitters with standardized current/voltage interfaces, e. g. 4 to 20 mA or 0 to 10 V.

testo Saveris wireless probe

testo Saveris router
testo Saveris wireless probe

testo Saveris analog coupler (Wireless)
testo Saveris wireless probe
Saveris set
Set 868 MHz

Set 1: 868 MHz, consisting of base 0572 0120, 3 NTC radio probes without display 0572 1110, mains unit for base 0554 1096 and SBE software 0572 0180 incl. USB cable

Part no.

0572 0110
Set 2.4 GHz

Set 1: 2.4 GHz, consisting of base 0572 0160, 3 NTC radio probes without display 0572 1150, mains unit for base 0554 1096 and SBE software 0572 0180 incl. USB cable

Part no.

0572 0150

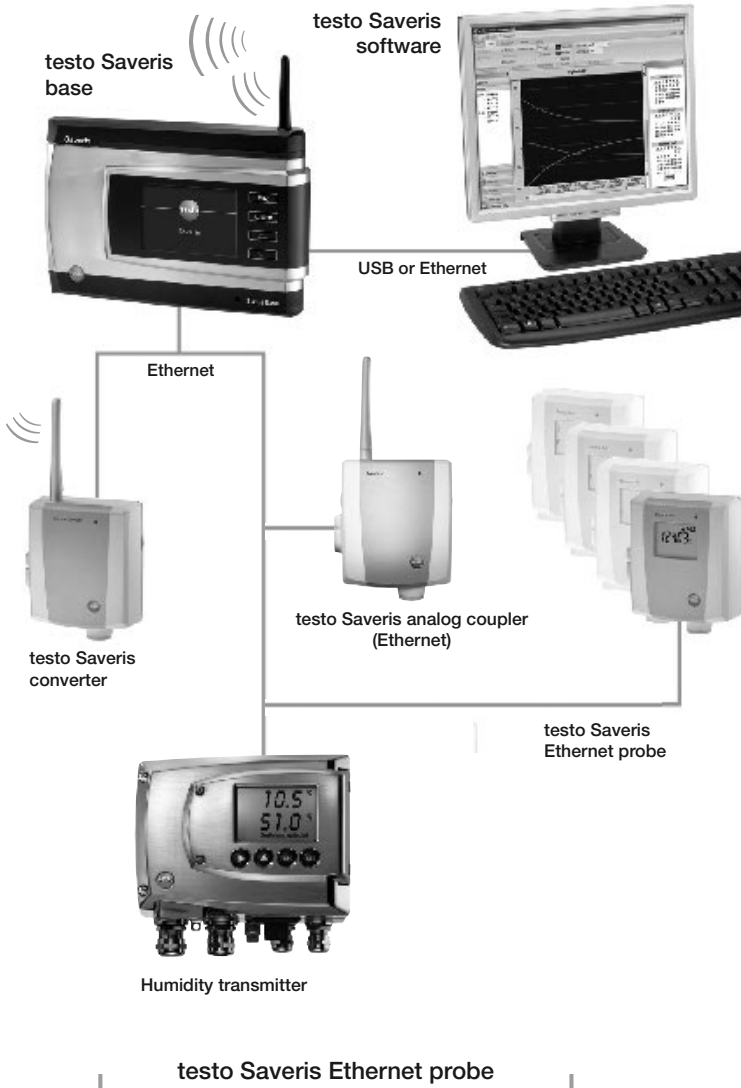
testo Saveris™

testo Saveris software

The measurement data is transmitted from the base to a PC on which the testo Saveris software is installed within just a few minutes using an installation assistant. The initial system and probe configuration is also performed using the software.

All measurement are saved centrally in the software's database and can be called up any time as a table or a graph. All alarms that occur are listed in a table as a history. The automatic creation of PDF reports in defined intervals also simplifies the documentation. Using the calendar function and the consolidation of probes into groups, the operation of the software is simple and intuitive.

In the event of an alarm the user can choose between receiving a message via e-mail, SMS or an alarm directly on the screen.

Die PROF (Professional) software version has interesting additional functions over and above the attractive basic functions of the SBE Basic version, e.g.:

- Client server concept: Measurement data can be monitored by different PCs integrated into the network.
- Photographs of machines or rooms can be saved as an image. In these images, the respective measurement values are shown directly at the position of the probe in the room or at the machine. The link between the location and the measurement value is thus very easily visualized (s. picture).
- A comprehensive alarm management offers the option of alarming more than two people at the same time or in succession. Depending on the day of the week and the time, you can freely choose whether an alarm is sent via e-mail or SMS.

Overview of software versions	SBE	PROF	CFR
Simple installation and configuration	•	•	•
Diagrams / tables / alarm overview / PDF reports	•	•	•
Calendar management	•	•	•
Representation of probe groups	•	•	•
Transmission of alarms (e-mail, SMS, relay)	•	•	•
Comprehensive alarm management		•	•
Automatic refresh of measurement data ("Online mode")		•	•
Measurement data on background photo of locations		•	•
Integration into network (client server)		•	•
Allocation of access rights to probe groups		•	•
Conform to 21CFR11 (validatable)			•
Electronic signature			•
Audit trail			•
Allocation of access rights on 3 user levels			•

testo Saveris Ethernet probe

In addition to the radio probes, probes can be used that are directly connected to the Ethernet. The existing LAN infrastructure can be used through this. This allows the data transfer from the probe to the base, even over long distances.

Ethernet probes can be used over any long periods since they are connected to the mains and therefore work independently of batteries. The internal memory guarantees that the existing measurement data is not lost, even with failure of the mains or the LAN connection.

A display informs about the current measurement data as well as the probe status. Different probe versions (probe partially plug-in) adapt to the conditions of the application.

Through the connection of a converter to an Ethernet jack, the signal of a radio probe can be converted into an Ethernet signal. This combines the flexible connection of the radio probe with the use of the existing Ethernet even over long transmission paths.

**Humidity/differential pressure transmitters
testo 6651/6681/6351/6381**

Thanks to the integration of the humidity transmitter, measurement data monitoring is possible parallel to the control. This provides the solution for highest accuracy as well as for special applications (high humidity, trace humidity etc.) in compressed air, drying and air conditioning technology.

Find out more at www.testo.com/transmitter

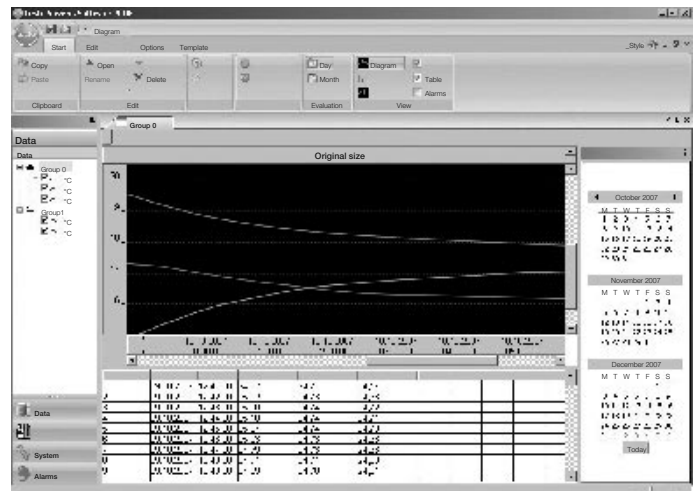

Probe versions with internal and external temperature sensors and with humidity sensors allow the adaptation to every application. The radio probes are available with or without a display as an option. Current measurement data, the battery status and the quality of the radio link are shown in the display.

		°C / °F			
	Radio	NTC internal 81 mm	NTC internal 81 mm	NTC external 81 mm	TC external 81 mm
		Saveris T1 Radio probe with internal NTC	Saveris T2 Radio probe with external probe connection and internal NTC, door contact	Saveris T3 2-channel radio probe with 2 external TC probe connections (Choice of TC characteristics)	Saveris Pt Radio probe with 1 external Pt100 probe connection
Internal sensor	Probe type	NTC			
	Meas. range	-35 to +50 °C			
	Accuracy	±0.4 °C (-25 to +50 °C) ±0.8 °C (remaining range)			
	Resolution	0.1 °C			
External probe	Probe type	NTC	TC type K	TC type J	Pt100
	Meas. range (Instrument)	-50 to +150 °C	-195 to +1350 °C	-100 to +750 °C	-200 to +600 °C
	Accuracy (Instrument)	±0.2 °C (-25 to +70 °C) ±0.4 °C (remaining range)	±0.5 °C or 0.5% of mv		at 25 °C ±0.1 °C (0 to +60 °C) ±0.2 °C (-100 to +200 °C) ±0.5 °C (remaining range)
	Resolution (Instrument)	0.1 °C	0.1 °C / TC type S 1 °C		0.01 °C
Conn.		NTC via mini-DIN socket, door contact connection cable included in delivery (1.80 m)	2 TCs via TC socket, max. difference in potential 2 V		1 Pt100 via mini-DIN socket
Dimensions (housing):	80 x 85 x 38 mm				
Weight	Approx. 240 g				
Battery life (Type: 4 AA batteries)	Battery life at +25 °C, 3 years; for freezer applications, 3 years with L91 Photo lithium Energizer batteries				
Material/Housing	Plastic				
Protection class	IP68		IP54		IP68
Radio frequency	868 MHz / 2.4 GHz				
Measuring rate	Standard 15 min, 1 min to 24 h can be set				
Conformity with standards	DIN EN 12830				
Oper. temp.	-35 to +50 °C		-20 to +50 °C		
Storage temp.	-40 to +55 °C				
Display (optional)	LCD, 2 lines; 7-segment with symbols				
Transmission distance	approx. 300 m free field at a frequency of 868 MHz, approx. 100 m free field at a frequency of 2.4 GHz				
Wall bracket	included				

Ordering data Wireless probes	Part no.		Part no.	
	Version without display		Version with display	
	868 MHz	2.4 GHz	868 MHz	2.4 GHz
Saveris T1 Radio probe with internal NTC	0572 1110	0572 1150	0572 1120	0572 1160
Saveris T2 Radio probe with external probe connection and internal NTC, door contact	0572 1111	0572 1151	0572 1121	0572 1161
Saveris T3 2-channel radio probe with 2 external TC probe connections (Choice of TC characteristics)	0572 9112	0572 9152	0572 9122	0572 9162
Saveris Pt Radio probe with 1 external Pt100 probe connection	0572 7111	0572 7151	0572 7121	0572 7161

The alkali manganese batteries AA (0515 0414) are included in these ordering data (analog coupler excluded). Saveris probes are delivered with a calibration protocol of the factory adjustment data. Calibration certificates must be ordered separately.

Radio

		°C / °F and %RH				mA and V			
		%RH NTC external		%RH NTC internal		%RH NTC external		mA V interno	
		Saveris H2D Wireless humidity probe		Saveris H3 Humidity radio probe		Saveris H4D Wireless probe with 1 external humidity probe connection		Saveris U1 Wireless probe with current/voltage output	
Internal sensor	Probe type			NTC	Humidity sensor			1 channel: current/voltage input	
	Meas. range			-20 to +50 °C	0 to 100 %RH			2-wire: 4 to 20 mA, 4-wire: 0/4 to 20 mA, 0 to 1/5/10 V, load: max. 160 Ω at 24 V DC	
	Accuracy			±0.5 °C	±3 %RH			Current ±0.03 mA / 0.75 µA Voltage 0 to 1 V ±1.5 mV/39 µV Voltage 0 to 5 V ±7.5 mV / 0.17 mV Voltage 0 to 10 V ±15 mV / 0.34 mV ±0.02% of. m.v./K deviating from nominal temperature 22 °C	
	Resolution			0.1 °C	0.1 °C / 0.1 °C td				
External probe	Probe type	NTC	Humidity sensor			NTC	Humidity sensor		
	Meas. range (Instrument)	-20 to +50 °C	0 to +100 %RH*			-20 to +70 °C	0 to +100 %RH*		
	Accuracy (Instrument)	±0.5 °C	to 90 %RH: ±2 %RH > 90 %RH: ±3 %RH			±0.2 °C	see probes		
	Resolution (Instrument)	0.1 °C	0.1% / 0.1 °C td			0.1 °C	0.1% / 0.1 °C td		
Conn.	non-exchangeable stump probe					1 x external humidity probe mini DIN socket		2 or 4-wire current/voltage output Service interface mini DIN for adjustment	
Dimensions (housing):	85 x 100 x 38 mm			80 x 85 x 38 mm			Approx. 85 x 100 x 38 mm		
Weight	Approx. 256 g			Approx. 245 g			Approx. 240 g		
Battery life (Type: 4 AA batteries)	Battery life at +25 °C, 3 years; for freezer applications, 3 years with L91 Photo lithium Energizer batteries						Supply: Mains unit 6.3 V DC, 2 to 30 V DC max. 25 V AC		
Material/Housing	Plastic								
Protection class	IP54			IP42			IP54		
Radio frequency	868 MHz / 2.4 GHz								
Measuring rate	Standard 15 min, 1 min to 24 h can be set								
Oper. temp.	-20 to +50 °C								
Storage temp.	-40 to +55 °C								
Display (optional)	LCD, 2 lines; 7-segment with symbols						(no display)		
Transmission distance	approx. 300 m free field at a frequency of 868 MHz, approx. 100 m free field at a frequency of 2.4 GHz								
Wall bracket	included								

*not for continuous high-humidity applications

Ordering data Wireless probes	Part no.		Part no.	
	Version without display		Version with display	
	868 MHz	2.4 GHz	868 MHz	2.4 GHz
Saveris H3 Wireless probe with internal humidity sensor	0572 6110	0572 6150	0572 6120	0572 6160
Saveris H2D Wireless probe with external humidity sensor 2%RH, radio frequency 868 MHz (with display)			0572 6122	0572 6162
Saveris H4D Wireless humidity probe with external probe connection, radio frequency 868 MHz (with display)			0572 6124	0572 6164
Saveris U1 Analog coupler with 1 current/voltage output (order mains unit separately)	0572 3110	0572 3150		

The alkali manganese batteries AA (0515 0414) are included in these ordering data (analog coupler excluded). Saveris probes are delivered with a calibration protocol of the factory adjustment data. Calibration certificates must be ordered separately.

The existing LAN infrastructure can be used through the Ethernet probe. This allows the data transfer from the probe to the base, even over long distances. Ethernet probes have a display.

		°C		
		NTC external	TC external	Pt 100 external
 Ethernet		 Saveris T1E Ethernet probe with 1 external probe connection NTC	 Saveris T4 E 4-channel Ethernet probe with 4 external TC probe connections	 Saveris Pt E Ethernet probe with external Pt100 probe connection
External probe	Probe type	NTC	TC type K	Pt100
	Meas. range (Instrument)	-50 to +150 °C	TC type J TC type T	-200 to +600 °C
	Accuracy (Instrument)	±0.2 °C (-25 to +70 °C) ±0.4 °C (remaining range)	-195 to +1350 °C -100 to +750 °C -200 to +400 °C	at 25 °C ±0.1 °C (0 to +60 °C) ±0.2 °C (-100 to +200 °C) ±0.5 °C (remaining range)
	Resolution (Instrument)	0.1 °C	TC type S 0 to +1760 °C	0.01 °C
Conn.	1 x NTC via mini DIN socket	4 TCs via TC socket, max. difference in potential 50 V		1 Pt100 via mini-DIN socket
Mini-DIN service interface for adjustment is accessible externally				
Dimensions (housing):	Approx. 85 x 100 x 38 mm			
Weight	Approx. 220 g			
Power	6.3 V DC mains unit; alternatively via 24 V AC/DC plug-in/screw terminals, PoE			
Buffer battery	Li-ion			
Material/Housing	Plastic			
Protection class	IP54			
Measuring rate	2 s to 24 h			
Oper. temp.	-20 to +60 °C			
Storage temp.	-40 to +60 °C			
Power consumption	PoE Class 0 (typical ≤ 3 W)			
Display (optional)	LCD, 2 lines; 7-segment with symbols			
Wall bracket	included			

Ordering data Ethernet probes

	Part no.
Saveris T1E Ethernet probe with 1 external probe connection NTC	0572 1191
Saveris T4 E 4-channel Ethernet probe with 4 external TC probe connections (With display)	0572 9194
Saveris Pt E Ethernet probe with external Pt100 probe connection (With display)	0572 7191
Saveris H1 E Humidity Ethernet probe 1% (With display)	0572 6191
Saveris H2 E Humidity Ethernet probe 2 % (With display)	0572 6192
Saveris H4E Ethernet humidity probe with external probe connection (with display)	0572 6194
Saveris U1E Etheret analog coupler with 1 current/voltage output	0572 3190

Saveris probes are delivered with a calibration protocol of the factory adjustment data. Calibration certificates must be ordered separately. Mains units are not included in delivery.

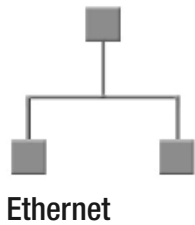

Ethernet

°C / °F and %RH			mA and V	
%RH	NTC	external	external	internal
Saveris H1 E Humidity Ethernet probe 1%		Saveris H2 E Humidity Ethernet probe 2%		Saveris U1E Ethernet probe with current/voltage

Internal sensor	Probe type							1 channel: current/voltage
	Meas. range							2-wire: 4 to 20 mA, 4-wire: 0/4 to 20 mA, 0 to 1/5/10V, load: max. 160 Ω at 24 V DC
	Accuracy							Current ±0.03 mA / 0.75 µA Voltage 0 to 1 V ±1.5 mV / 39 µV Voltage 0 to 5 V ±7.5 mV / 0.17 mV Voltage 0 to 10 V ±15 mV / 0.34 mV ±0.02% of. m.v./K deviating from nominal temperature 22 °C
	Resolution							
External probe	Probe type	NTC	Humidity sensor	NTC	Humidity sensor	NTC	Humidity sensor	
	Meas. range (Instrument)	-20 to +70 °C	0 to 100 %RH*	-20 to +70 °C	0 to 100 %RH*	-20 to +70 °C	0 to 100 %RH*	
	Accuracy (Instrument)	±0.2 °C (0 to +30 °C) ±0.5 °C (remaining range)	to 90 %RH: ±(1 %RH + 0.7 % of mv) at +25 °C > 90 %RH: ±(1.4 %RH + 0.7 % of mv) at +25 °C	±0.2 °C (0 to +30 °C) ±0.5 °C (remaining range)	to 90 %RH: ±(1 %RH + 0.7 % of mv) at +25 °C > 90 %RH: ±(1.4 %RH + 0.7 % of mv) at +25 °C	±0.2 °C (-20 to +70 °C)	see external probes	
Resolution (Instrument)	0.1 °C	0.1% / 0.1 °C td	0.1 °C	0.1% / 0.1 °C td	0.1 °C	0.1% / 0.1 °C td		
Conn.						1 x external Ethernet humidity probe mini DIN socket	1 x 2- or 4-wire current/voltage	
Mini-DIN service interface is accessible externally								
Dimensions (housing):	Approx. 85 x 100 x 38 mm							
Weight	Approx. 230 g		Approx. 254 g			Approx. 240 g		
Power	6.3 V DC mains unit; alternatively via 24 V AC/DC plug-in/screw terminals, PoE							
Buffer battery	Li-ion							
Material/Housing	Plastic							
Protection class	IP54							
Measuring rate	2 s to 24 h							
Oper. temp.	-20 to +60 °C							
Storage temp.	-40 to +60 °C							
Power consumption	PoE Class 0 (typical ≤ 3 W)							
Display (optional)	LCD, 2 lines; 7-segment with symbols					no display		
Wall bracket	included							

*not for continuous high-humidity applications

Sintered caps for Saveris H1 E, H2 E and H2 D Ethernet probes
Illustration
Part no.

Metal protection cage, Ø 12 mm for humidity probes, for measurement in flow velocities of less than 10 m/s

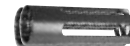

0554 0755

Stainless steel sintered cap, Ø 12 mm, is screwed onto humidity probe, for measurements at higher flow velocities or in contaminated air



0554 0647

Cap with wire mesh filter, Ø 12 mm



0554 0757

Sintered PTFE filter, Ø 12 mm, for corrosive media, High humidity range (long-term measurements), high flow velocities.



0554 0756

testo saline pots for control and humidity adjustment of humidity probes, 11.3 %RH and 75.3 %RH with adapter for humidity probe, quick checks or calibration of humidity probe

0554 0660

testo Saveris™ Base	Part no.
Saveris base, radio frequency 868 MHz	0572 0120
Saveris base, radio frequency 868 MHz, GSM module integrated (for SMS alarm)	0572 0121
Saveris base, radio frequency 2.4 GHz	0572 0160
Saveris base, radio frequency 2.4 GHz, GSM module integrated (for SMS alarm)	0572 0161

No mains units or aeriels with magnetic base are contained in this ordering data.

Technical data Base	
Memory	40,000 values per channel (total max. 10,160,000 values)
Dimensions	225 x 150 x 49 mm
Weight	Approx. 1510 g
Protection class	IP42
Material/Housing	Diecast zinc / plastic
Radio frequency	868 MHz / 2.4 GHz
Power supply (absolutely necessary)	6.3 V DC mains unit; alternatively via 24 V AC/DC plug-in/screw terminals, power consumption < 4 W
Rech. batt.	Li-ion battery (for data back-up and for emergency SMS if power supply fails)
Oper. temp.	-10 to +50 °C
Storage temp.	-40 to +60 °C
Display	graphical display, 4 control keys
Interfaces	USB, radio, Ethernet
Connectable radio probe	max. 15 probes can be directly connected via radio interface, max. 150 total via radio / router / converter / Ethernet, max. 254 channels
Alarm relay	max. 1 A, max. 30 W, max. 60/25 V DC/AC, NC or NO contact
GSM module	850 / 900 / 1800 / 1900 MHz not valid for Japan and South Korea
Set up	Table base and wall bracket included

Power supply	Part no.
Battery for radio probe (4 AA alkali manganese mignon batteries)	0515 0414
Battery for radio probe for use below -10 °C (4 Energizer L91 Photo lithium)	0515 0572
100-240 V AC / 6.3 V DC international mains unit; for mains operation or battery charging in instrument	0554 1096
Mains unit (top-hat rail mounting) 90 to 264 VAC/24 VDC (2.5 A)	0554 1749
Mains unit (desk-top) 110 to 240 VAC/24 VDC (350mA)	0554 1748

Other features	Part no.
Magnetic foot aerial (dualband) with 3 m cable, for base with GSM module (not suitable for USA, Canada, Chile, Argentina, Mexico)	0554 0524
Magnetic foot aerial (quadband) for base with GSM module	0554 0525
Alarm module (visual + acoustic), can be connected to base alarm relay, Ø 70 x 164 mm, 24 V AC/DC / 320 mA, perm. light: red, perm. tone: buzzer approx. 2.4 kHz (Mains unit 0554 1749 required)	0572 9999 ID-Nr. 0699 6111/1
Programming adapter (from mini-DIN to USB) for Ethernet probe and converter (necessary if no DHCP server available)	0440 6723

testo Saveris™ Router	Part no.
Saveris router, 868 MHz, radio transmission medium	0572 0119
Saveris router, 2.4 GHz, radio transmission medium	0572 0159
testo Saveris™ Converter	Part no.
Saveris converter, 868 MHz, converts the radio transmission medium to Ethernet	0572 0118
Saveris converter, 2.4 GHz, converts the radio transmission medium to Ethernet	0572 0158

No mains units are contained in this ordering data.

Technical data	Router	Converter
Dimensions	Approx. 85 x 100 x 38 mm	Approx. 85 x 100 x 35 mm
Weight	Approx. 180 g	Approx. 190 g
Power supply	6.3 V DC mains unit; alternatively via 24 V AC/DC plug-in/screw terminals, power consumption < 0.5 W	6.3 V DC mains unit; alternatively via 24 V AC/DC plug-in/screw terminals, PoE, power consumption < 2 W
Oper. temp.	-20 to +50 °C	-20 to +50 °C
Storage temp.	-40 to +60 °C	-40 to +60 °C
Material/Housing	Plastic	Plastic
Protection class	IP54	IP54
Interfaces	Radio	Radio, Ethernet
Connectable radio probe	max. 5	max. 15
Wall bracket	included	included

Note on the radio frequencies

868 MHz:	EU countries and certain other countries (e.g. CH, NOR)	2.4 GHz:	non-EU countries (country list can be called up under www.testo.com/saveris)
----------	---	----------	--

Software	Part no.
SBE software, incl. USB connecting cable base-PC	0572 0180
PROF software, incl. USB connecting cable base-PC	0572 0181
CFR software, incl. Ethernet connection cable PC to Base	0572 0182
Saveris adjustment software incl. connection cable for wireless and Ethernet probes	0572 0183

Calibration Certificates	Part no.
ISO calibration certificate/temperature; Temperature probes; calibration points -8 °C; 0 °C; +40 °C per channel/instrument (suitable for Saveris T1/T2)	0520 0171
ISO calibration certificate/temperature; Temperature probes; calibration points -18 °C; 0 °C; +60 °C; per channel/instrument (not suitable for Saveris T1/T2)	0520 0151
DAkKs calibration certificate/Temperature*; Temperature probes; calibration points -20 °C; 0 °C; +60 °C; per channel/instrument (not suitable for Saveris T1/T2)	0520 0261
ISO calibration certificate humidity ; calibration points 11.3 %RH and 75.3 %RH at +25 °C/+77 °F; per channel/instrument	0520 0076
DAkKs calibration certificate humidity*; humidity data logger; cal. points 11.3%RH and 75.3%RH at +25°C; per channel/instrument	0520 0246

*Successor organization of the DKD

Pt100 Plug-in probes	Illustration	Meas. range	Accuracy	t99	Part no.
● Robust, Pt100 stainless steel food probe (IP65)		-50 to +400 °C	Class A (-50 to +300 °C), Class B (remaining range)	10 s	0609 2272
● Penetration probe Pt100 with ribbon cable, cable length 2 m, IP 54		-50 to +180 °C	Class A	10 s	0572 7001
● Robust, waterproof Pt100 immersion/penetration probe		-50 to +400 °C	Class A (-50 to +300 °C), Class B (remaining range)	12 s	0609 1273
Connection cable for unlimited Pt100 stationary probes with screw terminals (4-wire technology), max. cable length: 20 m					0554 0213

● The specified accuracy class of the Saveris radio and Ethernet probe is achieved using these external probes.

testo Saveris™
Accessories: External temperature probes

TC Plug-in probes	Illustration	Meas. range	Accuracy	t99	Part no.
Stationary probe with stainless steel sleeve, TC Type K		-50 to +205 °C	Class 2*	20 s	0628 7533
Robust air probe, T/C Type K		-60 to +400 °C	Class 2*	25 s	0602 1793
Penetration probe TC with ribbon cable, Type K, cable length 2 m, IP 54		-40 to +220 °C	Class 1	7 s	0572 9001
Magnetic probe, adhesive force approx. 20 N, with magnets, for measurements on metal surfaces, TC Type K		-50 to +170 °C	Class 2*	150 s	0602 4792
Magnetic probe, adhesive force approx. 10 N, with magnets, for higher temp., for measurements on metal surfaces, TC Type K		-50 to +400 °C	Class 2*		0602 4892
Pipe wrap probe for pipe diameter 5 to 65 mm, with exchangeable measuring head. Meas. range short-term to +280°C, TC Type K		-60 to +130 °C	Class 2*	5 s	0602 4592
Pipe wrap probe with Velcro strip, for temperature measurement on pipes with diameter up to max. 120 mm, Tmax +120°C, TC Type K		-50 to +120 °C	Class 1*	90 s	0628 0020
Thermocouple with TC adapter, flexible, 800mm long, fibre glass, TC Type K		-50 to +400 °C	Class 2	5 s	0602 0644
Thermocouple with TC adapter, flexible, 1500mm long, fibre glass, TC Type K		-50 to +400 °C	Class 2*	5 s	0602 0645
Thermocouple with TC adapter, flexible, 1500mm long, PTFE, TC Type K		-50 to +250 °C	Class 2*	5 s	0602 0646
Immersion tip, flexible, TC Type K		-200 to +1000 °C	Class 1*	5 s	0602 5792
Immersion measurement tip, flexible, for measurements in air/exhaust gases (not suitable for measurements in smelters), TC Type K		-200 to +1300 °C	Class 1*	4 s	0602 5693

*According to standard EN 60584-2, the accuracy of Class 1 refers to -40 to +1000 °C (Type K), Class 2 to -40 to +1200 °C (Type K), Class 3 to -200 to +40 °C (Type K).

NTC Plug-in probes	Illustration	Meas. range	Accuracy	t99	Part no.
Stub probe, IP 54		-20 to +70 °C	±0.2 °C (-20 to +40 °C) ±0.4 °C (+40.1 to +70 °C)	15 s	0628 7510
Stationary probe with aluminium sleeve, IP 65		-30 to +90 °C	±0.2 °C (0 to +70 °C) ±0.5 °C (remaining range)	190 s	0628 7503*
Accurate imm./pen. probe, 6m cable, IP 67		-35 to +80 °C	±0.2 °C (-25 to +74.9 °C) ±0.4 °C (remaining range)	5 s	0610 1725*
Accurate immersion/penetration probe, cable: 1.5 m long, IP 67		-35 to +80 °C	±0.2 °C (-25 to +74.9 °C) ±0.4 °C (remaining range)	5 s	0628 0006*
Penetration probe NTC with ribbon cable, cable length 2 m, IP 54		-40 to +125 °C	±0.5 % of mv (+100 to +125 °C) ±0.2 °C (-25 to +80 °C) ±0.4 °C (remaining range)	8 s	0572 1001
Wall surface temperature probe, e.g. to prove damage in building material		-50 to +80 °C	±0.2 °C (0 to +70 °C)	20 s	0628 7507
Stainless steel NTC food probe (IP65) with PUR cable		-50 to +150 °C ²⁾	±0.5% of mv (+100 to +150 °C) ±0.2 °C (-25 to +74.9 °C) ±0.4 °C (remaining range)	8 s	0613 2211*
Waterproof NTC immersion/penetration probe		-50 to +150 °C	±0.5% of mv (+100 to +150 °C) ±0.2 °C (-25 to +74.9 °C) ±0.4 °C (remaining range)	10 s	0613 1212
Pipe wrap probe with Velcro for pipe diameter to max. 75 mm, Tmax. +75°C, NTC		-50 to +70 °C	±0.2 °C (-25 to +70 °C) ±0.4 °C (-50 to -25.1 °C)		0613 4611

* Probe tested to EN 12830 for suitability in the transport and storage sectors

²⁾ Long-term measurement range +125°C, short-term +150°C or +140°C (2 minutes)

%RH Plug-in probes	Illustration	Meas. range	Accuracy	Part no.
Humidity / Temperature Probe 12mm		-20 to +70 °C, 0 to +100 %RH	±0.3 °C, ±2 %RH (2 to 98 %RH)	0572 6172
Humidity / Temperature Probe 4 mm		0 to +40 °C, 0 to +100 %RH	±0.3 °C, ±2 %RH (2 to 98 %RH)	0572 6174

♣ The specified accuracy class of the Saveris radio and Ethernet probe is achieved using these external probes.

testo 174T

Mini data logger

The testo 174T mini temperature data logger is ideal for accompanying transports. The logger is simply placed beside the product e.g. in aeroplanes, containers, refrigerated rooms etc. and constantly monitors the fluctuations in temperature unobtrusively.

- Reliable temperature measurement for the monitoring of cold chains and sensitive products in storage and transport
- Easy readout of the data, and transfer to a PC via Testo USB interface



Actual size

testo 174T, 1-channel temperature logger with internal sensor (NTC) incl. wall holder, batteries and calibration protocol

Part no.
0572 1560

Technical data			
Probe type	NTC	Protection class	IP65
Channels	1 x internal	Meas. cycle	1 min - 24 h
Measurement units	°C, °F	Memory	16.000 readings
Measuring range	-30 to +70 °C	Software	ComSoft Basic 5 ComSoft Professional 4
Accuracy	±0.5 °C (-30 to +70 °C)		
	±1 digit		
Resolution	0.1 °C		
Battery life (at +25 °C)	500 days at 15 min. meas. rate		
Oper. temp.	-30 to +70 °C		
Storage temp.	-40 to +70 °C		
Dimensions	60 x 38 x 18,5 mm		
Battery type	2 x CR 2032 Lithium		

Bundles	Part no.
testo 174T mini data logger set, 1-channel, incl. USB interface for programming and reading out the logger, wall bracket, battery (2 x CR 2032 lithium) and calibration protocol	0572 0561
Accessories	Part no.
testo 174D - USB interface for programming and reading out the loggers testo 174	0572 0500
Battery testo 174 - Lithium button battery CR 2032 for testo 174 (please order two batteries per logger)	0515 0028
Software	
ComSoft Basic 5 - CD ComSoft Basic 5 (if free, registration-mandatory download not wanted)	0572 0580
ComSoft Professional 4 - Pro software incl. data archiving	0554 1704
Calibration Certificates	
ISO temperature calibration certificate; temperature probe; calibration points: -18 °C, 0 °C, +40 °C; per channel/instrument	0520 0153

testo 175 T1
Compact data logger

The testo 175 T1 temperature data logger, ideal for accompanying goods, guarantees uninterrupted documentation of the complete refrigeration chain.

- Professional temperature monitoring for refrigerated and deep-freeze rooms
- Compact data logger for long-term monitoring of temperature, e. g. during transport of goods

testo 175 T1, 1-channel temperature logger with internal sensor (NTC) incl. wall holder, lock, batteries and calibration protocol

Part no.

0572 1751



Technical data		
Probe type	NTC	Storage temp. -35 to. +55 °C
Channels	1 x internal	Dimensions 89 x 53 x 27 mm
Measurement units	°C, °F	Battery type 3 x AlMn Type AAA or Energizer
Measuring range	-35 to +55 °C intern	Protection class IP 65
Accuracy ± 1 digit	±0,5 °C (-35 to +55 °C)	Meas. cycle 10 sec - 24 h
Resolution	0.1 °C	Memory 1 mio. measurement values
Battery life (at +25 °C)	3 years at 15 min. meas. rate	Software ComSoft Basic 5 ComSoft Professional 4 ComSoft CFR 21 Part 11
Oper. temp.	-35 to. +55 °C	

Accessories	Part no.
USB cable - Cable for connecting the data loggers testo 175 and testo 176 with a PC, mini USB to USB	0449 0047
SD card - SD card for collecting the measurement data from the data loggers testo 175, application range to -20 °C	0554 8803
Wall holder - Wall holder (black) with padlock for testo 175	0554 1702
Battery for testo 175 - Application range below -10 °C, alkaline manganese microcells AAA (please order 3 batteries per logger)	0515 0009
Battery for testo 175 - Application range below -10 °C, Energizer L92 microcells AAA (please order 3 batteries per logger)	0515 0042

Accessories	Part no.
Software	
ComSoft Basic 5 - CD ComSoft Basic 5 (if free, registration-mandatory download not wanted)	0572 0580
ComSoft Professional 4 - Pro software incl. data archiving	0554 1704
ComSoft CFR 21 Part 11 - Software for requirements according to CFR 21 Part 11 for Testo data loggers	0554 1705
Calibration Certificates	
ISO temperature calibration certificate; temperature probe; calibration points: -18 °C, 0 °C, +40 °C; per channel/instrument	0520 0153
DKD temperature calibration certificate; temperature probe; calibration points: -18 °C, 0 °C, +60 °C; per channel/instrumenta	0520 0261

testo 175 T2

Compact data logger with internal sensor and probe connection

With an additional external probe connection, the testo 175 T2 temperature data logger provides a further temperature measurement option.

- Simultaneous monitoring of air and product temperature
- External probe input for easy connection, e. g. of a permitted food probe for measuring the core temperature of the goods



testo 175 T2, 2-channel temperature data logger with internal (NTC), and external sensor connection (NTC) incl. wall holder, lock, batteries and calibration protocol

Part no.
0572 1752



Technical data		
Probe type	NTC	Storage temp. -35 to +55 °C
Channels	1 x internal, 1 x external	Dimensions 89 x 53 x 27 mm
Measurement units	°C, °F	Battery type 3 x AIMn Type AAA or Energizer
Measuring range	-35 to +55 °C internal -40 to +120 °C external	Protection class IP65
Accuracy	±0.5 °C (-35 to +55 °C) internal ±0.3 °C (-40 to +120 °C) external	Meas. cycle 10 sec - 24 h
±1 digit		Memory 1 mio. measurement values
Resolution	0.1 °C	Software ComSoft Basic 5 ComSoft Professional 4 ComSoft CFR 21 Part 11
Battery life (at +25 °C)	3 years at 15 min. meas. rate	

Accessories	Part no.
Software	
ComSoft Basic 5 - CD ComSoft Basic 5 (if free, registration-mandatory download not wanted)	0572 0580
ComSoft Professional 4 - Pro software incl. data archiving	0554 1704
ComSoft CFR 21 Part 11 - Software for requirements according to CFR 21 Part 11 for Testo data loggers	0554 1705
Calibration Certificates	
ISO temperature calibration certificate; temperature probe; calibration points: -18 °C, 0 °C, +40 °C; per channel/instrument	0520 0153
DKD temperature calibration certificate; temperature probe; calibration points: -18 °C, 0 °C, +60 °C; per channel/instrument	0520 0261

Accessories	Part no.
USB cable - Cable for connecting the data loggers testo 175 and testo 176 with a PC, mini USB to USB	0449 0047
SD card - SD card for collecting the measurement data from the data loggers testo 175, application range to -20 °C	0554 8803
Wall holder - Wall holder (black) with padlock for testo 175	0554 1702
Battery for testo 175 - Application range below -10 °C, alkaline manganese microcells AAA (please order 3 batteries per logger)	0515 0009
Battery for testo 175 - Application range below -10 °C, Energizer L92 microcells AAA (please order 3 batteries per logger)	0515 0042

Probes (NTC)	Illustration	Meas. range	Accuracy	t99	Part no.
Stub probe, IP 54	35 mm Ø 0.3 mm	-20 to +70 °C	±0.2 °C (-20 to +40 °C) ±0.4 °C (+40.1 to +70 °C)	15 s	0628 7510
Stationary probe with aluminium sleeve, IP 65	40 mm Ø 0.6 mm Conn.: Fixed cable; Cable/length: 2.4 m	-30 to +90 °C	±0.2 °C (0 to +70 °C) ±0.5 °C (remaining range)	190 s	0628 7503*
Stainless steel NTC food probe (IP65) with PUR cable	125 mm Ø 0.4 mm 15 mm Ø 0.3 mm Conn.: Fixed cable; Cable/length: 1.6 m	-50 to +150 °C**	±0.5% of mv. (+100 to +150 °C) ±0.2 °C (-25 to +74.9 °C) ±0.4 °C (remaining range)	8 s	0613 2211*
Accurate immersion/penetration probe, cable: 1.5 m long, IP 67	40 mm Ø 0.3 mm Conn.: Fixed cable; Cable/length: 1.5 m	-35 to +80 °C	±0.2 °C (-25 to +74.9 °C) ±0.4 °C (remaining range)	5 s	0628 0006*
Waterproof NTC immersion/penetration probe	115 mm Ø 0.5 mm 50 mm Ø 0.4 mm Conn.: Fixed cable; Cable/length: 1.2 m	-50 to +150 °C	±0.5% of mv. (+100 to +150 °C) ±0.2 °C (-25 to +74.9 °C) ±0.4 °C (remaining range)	10 s	0613 1212

◆ The specified seal class of the data loggers is achieved with these probes.

* Probe tested to EN 12830 for suitability in the transport and storage sectors
** Long-term measurement range +125°C, short-term +150°C or +140°C (2 minutes)



testo 175 T3

The 175 T3 temperature data logger logs temperature at 2 different points simultaneously over a period of several days, weeks or even months.

testo 175 T3, 2-channel temperature data logger with external sensor connections (TC Type T and Type K) incl. wall holder, lock, batteries and calibration protocol

Part no.
0572 1753

2 external temperature probe sockets

- Parallel monitoring and recording of two temperature measurement sites
- Easy monitoring and documentation, e. g. of the flow and return temperature of a heating system



Technical data		
Probe type	TE (Types T and K)	Oper. temp. -20 to +55 °C
Channels	2 x external	Storage temp. -20 to +55 °C
Measurement units	°C, °F	Dimensions 89 x 53 x 27 mm
Measuring range	-50 to +400 °C (Type T) -50 to +1000 °C (Type K)	Battery type 3 x AlMn Typ AAA or Energizer
Accuracy ± 1 digit	±0,5 °C (-50 to +70 °C) ±0,7 % of mv. (+70,1 .to +1000 °C)	Protection class IP 65
Resolution	0.1 °C	Meas. cycle 10 sec - 24 h
Battery life (at +25 °C)	3 years at 15 min. meas. rate	Memory 1 mio. measurement values
		Software ComSoft Basic 5 ComSoft Professional 4 ComSoft CFR 21 Part 11

Accessories	Part no.
Software	
ComSoft Basic 5 - CD ComSoft Basic 5 (if free, registration-mandatory download not wanted)	0572 0580
ComSoft Professional 4 - Pro software incl. data archiving	0554 1704
ComSoft CFR 21 Part 11 - Software for requirements according to CFR 21 Part 11 for Testo data loggers	0554 1705
Calibration Certificates	
ISO temperature calibration certificate; temperature probe; calibration points: -18 °C, 0 °C, +40 °C; per channel/instrument	0520 0153
DKD temperature calibration certificate; temperature probe; calibration points: -18 °C, 0 °C, +60 °C; per channel/instrumenta	0520 0261

Accessories	Part no.
USB cable - Cable for connecting the data loggers testo 175 and testo 176 with a PC, mini USB to USB	0449 0047
SD card - SD card for collecting the measurement data from the data loggers testo 175, application range to -20 °C	0554 8803
Wall holder - Wall holder (black) with padlock for testo 175	0554 1702
Battery for testo 175 - Application range below -10 °C, alkaline manganese microcells AAA (please order 3 batteries per logger)	0515 0009
Battery for testo 175 - Application range below -10 °C, Energizer L92 microcells AAA (please order 3 batteries per logger)	0515 0042

Probes (Thermocouple)	Illustration	Meas. range	Accuracy	t99	Part no.
Stationary probe with stainless steel sleeve, TC Type K	40 mm Ø 6 mm Conn.: Fixed cable 1.9 m	-50 to +205 °C	Class 2*	20 s	0628 7533
Pipe wrap probe with Velcro tape for temperature measurements on pipes diameter to max. 120 mm, Tmax. +120 °C, TC Type K	395 mm 20 mm Conn.: Fixed cable 1.5 m	-50 to +120 °C	Class 1*	90 s	0628 0020
Pipe wrap probe for pipe diameters 5 to 65 mm, with exchangeable measuring head, measuring range briefly up to +280 °C, TC type K	75 mm Conn.: Fixed cable 1.2 m	-60 to +130 °C	Class 2*	5 s	0602 4592
Magnet probe, adhesion approx. 10 N, with magnets, for higher temperatures, for measurements on metal surfaces, TC type K	75 mm Ø 21 mm Conn.: Fixed cable 1.6 m	-50 to +400 °C	Class 2*		0602 4892
Thermocouple with TC plug flexible, length 1500 mm, fibreglass, TC Type K	1500 mm Ø 1.5 mm	-50 to +400 °C	Class 2*	5 s	0602 0645
Superfast needle probe for monitoring cooking times in ovens, TC Type T	60 mm Ø 1.4 mm Conn.: Fixed cable	-50 to +250 °C	±0.2 °C (-20 ... +70 °C) Class 1 (remaining measuring range)*	2 s	0628 0030

*Acc. to norm 60584-2, the accuracy of Class 1 refers to -40 to -100 °C (Type K), Class 2 to -40 to +1200 °C (Type K), Class 3 to -200 to +40 °C (Type K)

testo 176 T1

Data logger (in metal housing) with highly accurate temperature sensor

testo 176 T1 is a temperature data logger in a full-metal housing with built-in temperature probe. A long life is guaranteed even in tough conditions.

- Highly accurate temperature measurement under extreme conditions
- Robust metal housing protects from mechanical influences such as impact



testo 176 T1, 1-channel temperature logger in metal housing with highly accurate internal sensor (Pt100) incl. wall holder, lock, battery and calibration protocol

Part no.
0572 1761

Technical data			
Probe type	Pt100 class A	Storage temp.	-40 to +85 °C
Channels	1 x internal	Dimensions	103 x 63 x 33 mm
Measurement units	°C, °F	Battery type	1 x Lithium (TL-5903)
Measuring range	-35 to +70 °C	Protection class	IP68
Accuracy	±0.2 °C (-35 to +70 °C)	Meas. cycle	1 sec - 24 h
Resolution	0.01 °C	Memory	2 mio. measurement values
Battery life (at +25 °C)	8 years at 15 min. meas. rate	Software	ComSoft Basic 5 ComSoft Professional 4 ComSoft CFR 21 Part 11
Oper. temp.	-35 to +70 °C		

Accessories	Part no.
USB cable - Cable for connecting the data loggers testo 176 with a PC, mini USB to USB	0449 0047
SD card - for collecting the measurement data from the data loggers testo 176, application range to -20 °C	0554 8803
Wall holder - (black) with padlock for testo 176	0554 1703
Battery for testo 176 - 1 x TL-5903 AA cell	0515 1760

Accessories	Part no.
Software	
ComSoft Basic 5 - CD ComSoft Basic 5 (if free, registration-mandatory download not wanted)	0572 0580
ComSoft Professional 4 - Pro software incl. data archiving	0554 1704
ComSoft CFR 21 Part 11 - Software for requirements according to CFR 21 Part 11 for Testo data loggers	0554 1705
Calibration Certificates	
ISO temperature calibration certificate; temperature probe; calibration points: -18 °C, 0 °C, +40 °C; per channel/instrument	0520 0153
DKD temperature calibration certificate; temperature probe; calibration points: -18 °C, 0 °C, +60 °C; per channel/instrument	0520 0261



testo 176 T2

2 external temperature probe inputs

The 176 T2 temperature data logger logs temperature at 2 different points simultaneously over a period of several days, weeks or even months.

- Highly accurate temperature measurement in the food sector and in laboratories
- Temperature monitoring e. g. in refrigerators with highly accurate Pt100 probes

testo 176 T2, 2-channel temperature logger with connections for highly accurate external sensor (Pt100) incl. wall holder, lock, battery and calibration protocol

Part no.
0572 1762



Technical data		
Probe type	Pt100 class A	
Channels	2 x external	Oper. temp. -35 to +70 °C
Measurement units	°C, °F	Storage temp. -40 to +85 °C
Measuring range	-50 to +400 °C	Dimensions 103 x 63 x 33 mm
Accuracy	±0,2 °C (-50 to +200 °C)	Battery type 1 x Lithium (TL-5903)
±1 digit	±0,3 °C (+200,1 to +400 °C)	Protection class IP 65
Resolution	0.01 °C	Meas. cycle 1 sec - 24 h
Battery life (at +25 °C)	8 years at 15 min. meas. rate	Memory 2 mio. measurement values
		Software ComSoft Basic 5 ComSoft Professional 4 ComSoft CFR 21 Part 11

Accessories	Part no.
Software	
ComSoft Basic 5 - CD ComSoft Basic 5 (if free, registration-mandatory download not wanted)	0572 0580
ComSoft Professional 4 - Pro software incl. data archiving	0554 1704
ComSoft CFR 21 Part 11 - Software for requirements according to CFR 21 Part 11 for Testo data loggers	0554 1705
Calibration Certificates	
ISO temperature calibration certificate; temperature probe; calibration points: -18 °C, 0 °C, +40 °C; per channel/instrument	0520 0153
DKD temperature calibration certificate; temperature probe; calibration points: -18 °C, 0 °C, +60 °C; per channel/instrumenta	0520 0261

Accessories	Part no.
USB cable - Cable for connecting the data loggers testo 176 with a PC, mini USB to USB	0449 0047
SD card - for collecting the measurement data from the data loggers testo 176, application range to -20 °C	0554 8803
Wall holder - (black) with padlock for testo 176	0554 1703
Battery for testo 176 -1 x TL-5903 AA cell	0515 1760

Probe (Pt100)	Illustration	Meas. range	Accuracy	t99	Part no.
◆ Waterproof Pt100 immersion/penetration probe, calibratable		-50 to +300 °C	Class A	12 s	0614 1272
◆ Robust stainless steel Pt100 food probe IP65, calibratable		-50 to +300 °C	Class A	10 s	0614 2272
Laboratory probe Pt100, glass-coated, Glass tube (Duran 50) exchangeable, resistant to corrosive media		-50 to +400 °C	Class A (-50 to +300 °C), Class B (rem. meas. range)	45 s 12 s**	0609 7072

◆ The specified tightness class for data loggers is fulfilled with these probes.

* Probe tested according to EN 12830 for suitability for the areas of transport and storage
** without protective glass

testo 176 T3

Data logger (in metal housing) with 4 external temperature probe inputs

testo 176 T3 with up to 4 external temperature probes is used for simultaneous temperature recording at different locations e.g. in production processes or in storage areas.

- Parallel temperature measurement at up to four measurement sites using different connectable thermocouple probes for different applications
- Robust metal housing protects from mechanical influences such as impact



testo 176 T3, 4-channel temperature data logger in metal housing with external sensor connection (TC Type T, Type K and Type J) incl. wall holder, lock, batteries and calibration protocol

Part no.
0572 1763

Technical data		
Probe type	TE (Types T, K and J)	Oper. temp. -20 to +70 °C
Channels	4 x external	Storage temp. -40 to +85 °C
Measurement units	°C, °F	Dimensions 103 x 63 x 33 mm
Measuring range	-200 to +400 °C (Type T) -195 to +1000 °C (Type K) -100 to +750 °C (Type J)	Battery type 1 x Lithium (TL-5903)
Accuracy ±1 digit	±1% of m.v. (-200 to -100.1 °C) ±0.3 °C (-100 to +70 °C) ±0.5% of m.v. (+70.1 to +1000 °C)	Protection class IP 65
Resolution	0.1 °C	Meas. cycle 1 sec - 24 h
Battery life (at +25 °C)	8 years at 15 min. meas. rate	Memory 2 mio. measurement values
		Software ComSoft Basic 5 ComSoft Professional 4 ComSoft CFR 21 Part 11

Accessories	Part no.
Software	
ComSoft Basic 5 - CD ComSoft Basic 5 (if free, registration-mandatory download not wanted)	0572 0580
ComSoft Professional 4 - Pro software incl. data archiving	0554 1704
ComSoft CFR 21 Part 11 - Software for requirements according to CFR 21 Part 11 for Testo data loggers	0554 1705
Calibration Certificates	
ISO temperature calibration certificate; temperature probe; calibration points: -18 °C, 0 °C, +40 °C; per channel/instrument	0520 0153
DKD temperature calibration certificate; temperature probe; calibration points: -18 °C, 0 °C, +60 °C; per channel/instrument	0520 0261

Accessories	Part no.
USB cable - Cable for connecting the data loggers testo 176 with a PC, mini USB to USB	0449 0047
SD card - for collecting the measurement data from the data loggers testo 176, application range to -20 °C	0554 8803
Wall holder - (black) with padlock for testo 176	0554 1703
Battery for testo 176 - 1 x TL-5903 AA cell	0515 1760

Probes (Thermocouple)	Illustration	Meas. range	Accuracy	t ₉₉	Part no.
Stationary probe with stainless steel sleeve, TC Type K		-50 to +205 °C	Class 2*	20 s	0628 7533
Pipe wrap probe with Velcro tape for temperature measurements on pipes diameter to max. 120 mm, T _{max.} +120 °C, TC Type K		-50 to +120 °C	Class 1*	90 s	0628 0020
Pipe wrap probe for pipe diameters 5 to 65 mm, with exchangeable measuring head, measuring range briefly up to +280 °C, TC type K		-60 to +130 °C	Class 2*	5 s	0602 4592
Magnet probe, adhesion approx. 10 N, with magnets, for higher temperatures, for measurements on metal surfaces, TC type K		-50 to +400 °C	Class 2*		0602 4892
Thermocouple with TC plug flexible, length 1500 mm, fibreglass, TC Type K		-50 to +400 °C	Class 2*	5 s	0602 0645
Superfast needle probe for monitoring cooking times in ovens, TC Type T		-50 to +250 °C	±0.2 °C (-20 ... +70 °C) Class 1 (remaining measuring range)*	2 s	0628 0030

*Acc. to norm 60584-2, the accuracy of Class 1 refers to -40 to -100 °C (Type K), Class 2 to -40 to +1200 °C (Type K), Class 3 to -200 to +40 °C (Type K)

testo 176 T4
Data logger with 4 external temperature probe inputs

The testo 176 T4 professional data logger with up to 4 external temperature probe connections for simultaneous temperature measurement at different sites.

testo 176 T4, 4-channel temperature data logger with external sensor connections (TC Type T, Type K and Type J) incl. wall holder, lock, batteries and calibration protocol

Part no.
0572 1764

- Parallel temperature measurement at up to four measurement sites using different connectable thermocouple probes for different applications
- Easy monitoring and documentation, e. g. of the flow and return temperature of an underfloor heating system at up to four measurement sites simultaneously



Technical data		
Probe type	TE (Types T, K and J)	Oper. temp. -20 to +70 °C
Channels	4 x external	Storage temp. -40 to +85 °C
Measurement units	°C, °F	Dimensions 103 x 63 x 33 mm
Measuring range	-200 to +400 °C (Type T)	Battery type 1 x Lithium (TL-5903)
	-195 to +1000 °C (Type K)	Protection class IP 65
	-100 to +750 °C (Type J)	Meas. cycle 1 sec - 24 h
Accuracy ± 1 digit	±1% of reading (-200 to -100.1 °C)	Memory 2 mio. measurement values
	±0.3 °C (-100 to +70 °C) ±0.5% of m.v. (+70.1 to +1000 °C)	Software ComSoft Basic 5 ComSoft Professional 4 ComSoft CFR 21 Part 11
Resolution	0.1 °C	
Battery life (at +25 °C)	8 years at 15 min. meas. rate	

Accessories	Part no.
Software	
ComSoft Basic 5 - CD ComSoft Basic 5 (if free, registration-mandatory download not wanted)	0572 0580
ComSoft Professional 4 - Pro software incl. data archiving	0554 1704
ComSoft CFR 21 Part 11 - Software for requirements according to CFR 21 Part 11 for Testo data loggers	0554 1705
Calibration Certificates	
ISO temperature calibration certificate; temperature probe; calibration points: -18 °C, 0 °C, +40 °C; per channel/instrument	0520 0153
DKD temperature calibration certificate; temperature probe; calibration points: -18 °C, 0 °C, +60 °C; per channel/instrument	0520 0261

Accessories	Part no.
USB cable - Cable for connecting the data loggers testo 176 with a PC, mini USB to USB	0449 0047
SD card - for collecting the measurement data from the data loggers testo 176, application range to -20 °C	0554 1700
Wall holder - (black) with padlock for testo 176	0554 1703
Battery for testo 176 - 1 x TLH-5903 AA cell	0515 1760

Probes (Thermocouple)	Illustration	Meas. range	Accuracy	t99	Part no.
Stationary probe with stainless steel sleeve, TC Type K		-50 to +205 °C	Class 2*	20 s	0628 7533
Pipe wrap probe with Velcro tape for temperature measurements on pipes diameter to max. 120 mm, Tmax. +120 °C, TC Type K		-50 to +120 °C	Class 1*	90 s	0628 0020
Pipe wrap probe for pipe diameters 5 to 65 mm, with exchangeable measuring head, measuring range briefly up to +280 °C, TC type K		-60 to +130 °C	Class 2*	5 s	0602 4592
Magnet probe, adhesion approx. 10 N, with magnets, for higher temperatures, for measurements on metal surfaces, TC type K		-50 to +400 °C	Class 2*		0602 4892
Thermocouple with TC plug flexible, length 1500 mm, fibreglass, TC Type K		-50 to +400 °C	Class 2*	5 s	0602 0645
Superfast needle probe for monitoring cooking times in ovens, TC Type T		-50 to +250 °C	±0.2 °C (-20 ... +70 °C) Class 1 (remaining measuring range)*	2 s	0628 0030

*Acc. to norm 60584-2, the accuracy of Class 1 refers to -40 to -100 °C (Type K), Class 2 to -40 to +1200 °C (Type K), Class 3 to -200 to +40 °C (Type K)

Logger software

Three software versions are available for programming and reading out the data loggers, as well as for the analysis of the data. Depending on the requirement, Testo offers the right software solution. The ComSoft Basic 5 with new graphic user interface offers all the basic functions of a standard logger software. Independently of where the data loggers are used – the ComSoft Basic 5 facilitates the configuration and readout of the instruments as well as the analysis of the data. User-friendliness and intuitive operation are paramount here. Requirements over and above this, such as the correlation of measurement data which have been recorded at different sites, are optimally fulfilled by the ComSoft Professional 4. The pharmaceutical industry makes very special demands, whose fulfilment is guaranteed by the ComSoft CFR21 Part 11.

CD ComSoft Basic 5, if free, registration-mandatory download not wanted

Order no.:
0572 0580

ComSoft Professional 4 – for demanding users

- The ComSoft Professional 4 offers analysis and presentation possibilities over and above the basic functions
- Many measurement sites and data loggers can be organized in a clear tree structure, for example

Order no.:
0554 1704

ComSoft CFR 21 Part 11 – specially for the requirements of the pharmaceutical industry

- The ComSoft CFR 21 Part 11 is a validation-capable software, and fulfils all the stipulations of the FDA (Food and Drug Administration) in the framework of a closed system
- Conformity with the CFR guidelines is confirmed by an independent institute

Order no.:
0572 6560

The right logger software for every application

ComSoft Basic 5 – for easy operation and convenient analysis

- The ComSoft Basic 5 offers all the basic functions of a logger software
- Free download of the ComSoft Basic 5 with mandatory registration
- Graphic user interface guides the user step by step through the individual processes
- Convenient export functions, e. g. for further processing of the data in Microsoft Excel, or the generation of a PDF which can be made available to other users

ComSoft Professional 4 – for demanding users

- The ComSoft Professional 4 offers analysis and presentation possibilities over and above the basic functions
- Many measurement sites and data loggers can be organized in a clear tree structure, for example

ComSoft CFR 21 Part 11 – specially for the requirements of the pharmaceutical industry

- The ComSoft CFR 21 Part 11 is a validation-capable software, and fulfils all the stipulations of the FDA (Food and Drug Administration) in the framework of a closed system
- Conformity with the CFR guidelines is confirmed by an independent institute

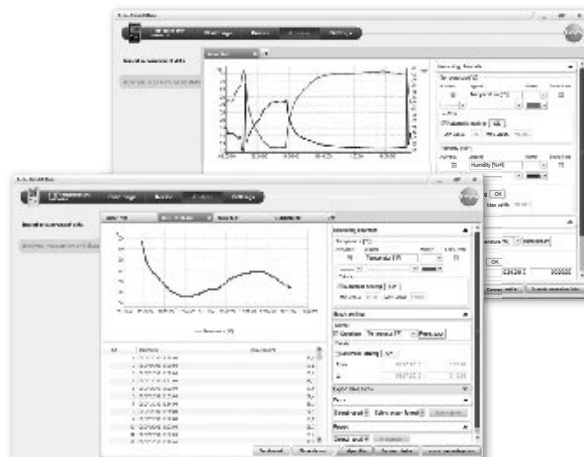
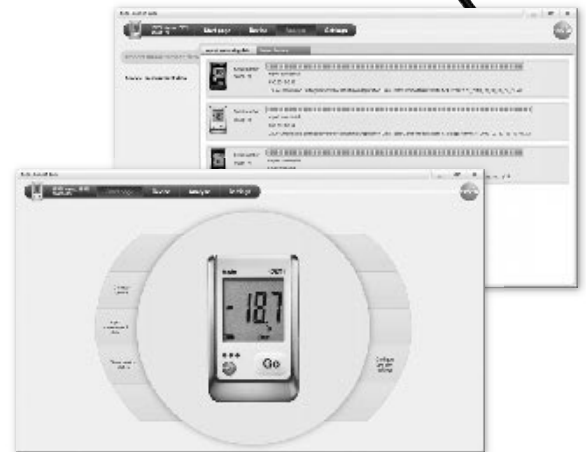

Stationary temperature probes

Testo has been offering stationary temperature probes for over 20 years, not only as standard probes, but also as customized probes. A overview of the standard probes is given on the following pages. Details of the temperature probes can be found on the internet at www.testo-celcius.com or in the brochure "Stationary Measurement Solutions for Air Conditioning and Process"

Overview standard probes



in air



in gases

non-corrosive gases

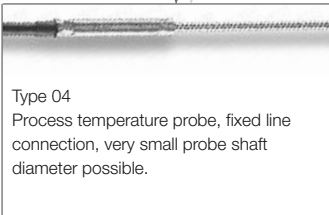

Type 04
Process temperature probe, fixed line connection, very small probe shaft diameter possible.

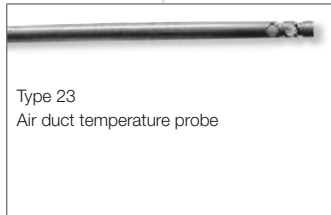

Type 23
Air duct temperature probe

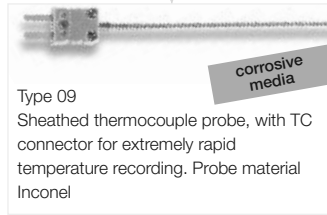

Type 09
Sheathed thermocouple probe, with TC connector for extremely rapid temperature recording. Probe material Inconel

corrosive media

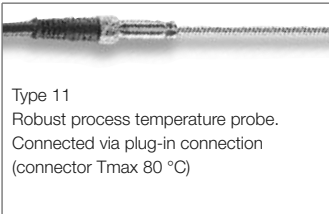

Type 11
Robust process temperature probe. Connected via plug-in connection (connector Tmax 80 °C)

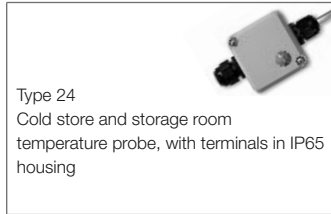

Type 24
Cold store and storage room temperature probe, with terminals in IP65 housing

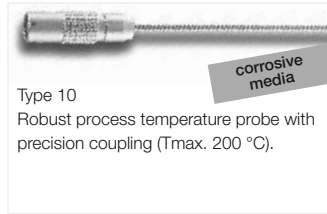

Type 10
Robust process temperature probe with precision coupling (Tmax. 200 °C).

corrosive media

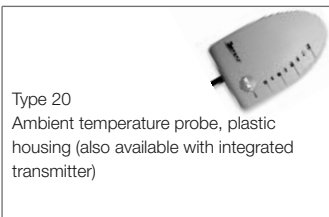

Type 20
Ambient temperature probe, plastic housing (also available with integrated transmitter)

Stationary temperature probes

Overview standard probes

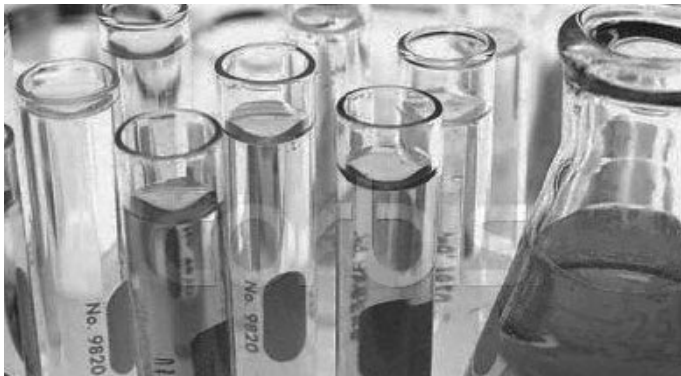

in liquids



on surfaces

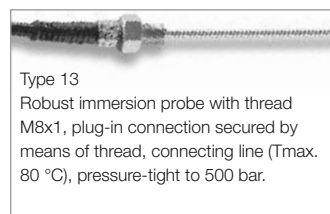
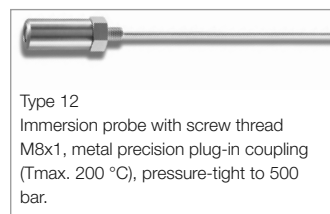
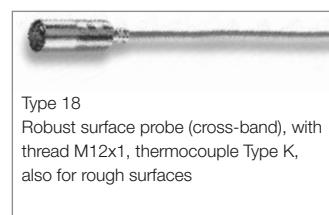
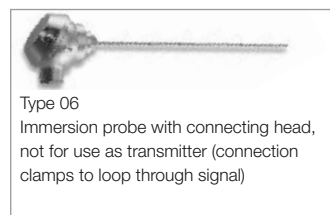
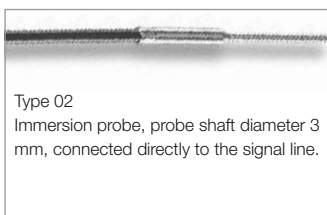
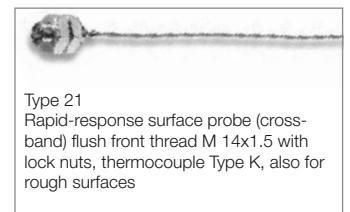
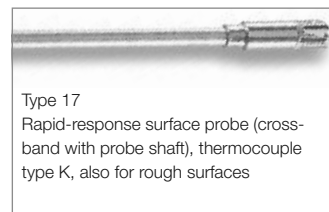
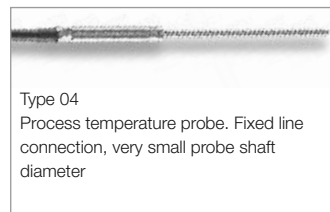
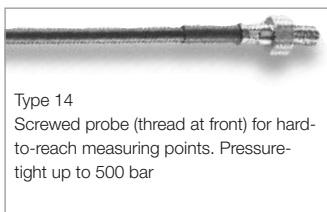
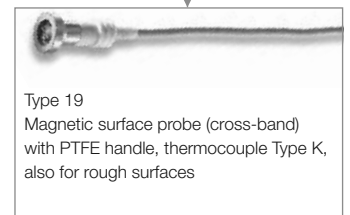
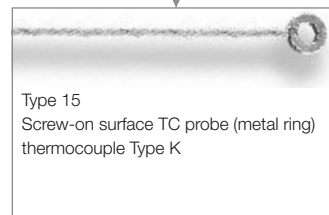
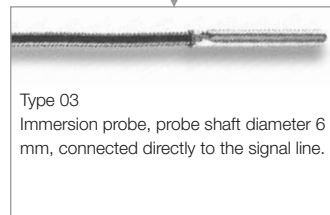
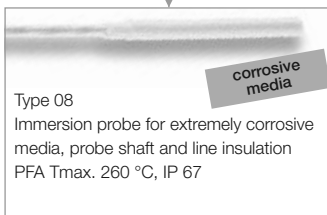

Configurator "Testo Celsius" on the internet

Temperature probes often have to be obtained at short notice: A system is at a stillstand and requires a replacement probe. Or a „second source“ needs to be found for a new type of machine.

Finding the right probe which meets the requirements of the process quickly and easily, is in most cases difficult because of the large variety of types. Specialized knowledge of measurement technology is often a prerequisite for being able to select the right probe.

Clear specifications in a few clicks of the mouse

The selection assistance „Testo Celcius“ on the Testo homepage solves this problem in a very customer-friendly way. The user is guided through the selection possibilities with simple questions.

After selecting the probe, the user can send the probe very directly to Testo Sales by e-mail. In addition to this, after selecting the temperature probe, a suitable temperature measurement transmitter (testo 55) or display (testo 54) can also be found..

The configurator is to be found under www.testo-celsius.com

Just click in !

Temperature probe selection made easy

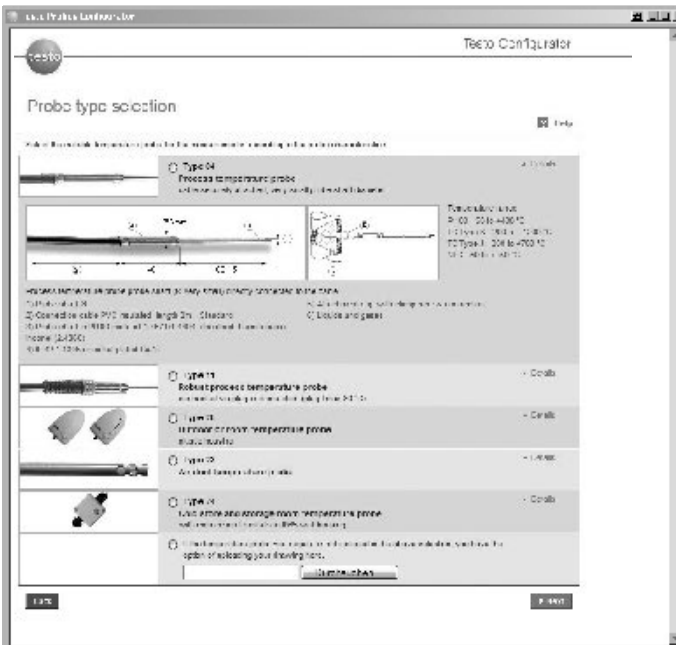
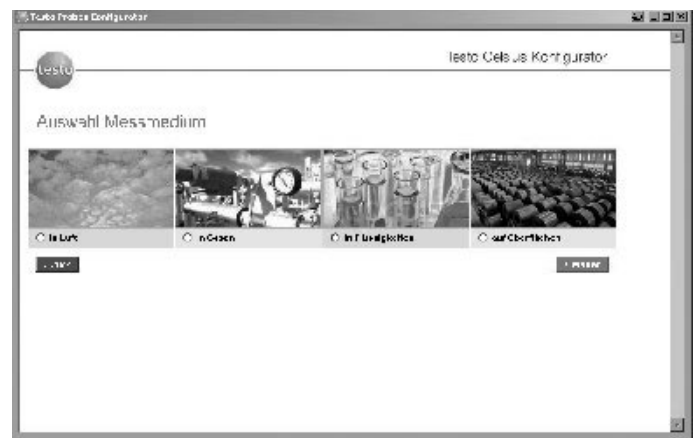

Can't find the right sensor for your application?
Configure your individual temperature probe!

Radio range up to 20 metres
(without obstruction)

Radio module
A

Upgrading the measuring instrument with radio option. Simply plug into the instrument.



Radio temperature probes can be connected to the following measuring instruments:
testo 110
testo 926
testo 925
testo 922
testo 735

Versatility through radio probes

In addition to conventional probes with cable attached, the new Compact and Professional Line instruments can also communicate optionally with radio probes, i.e. readings are transmitted wirelessly from the radio probe to a measuring instrument. The distance between measuring instrument and measurement location can be up to 20 metres. Awkward probe cables are therefore a thing of the past.

Data is transmitted from the probe to the measuring instrument via the radio module plugged into the instrument. Up to three radio probes can communicate with the instrument. The measuring rate is selectable (0.5 s or 10 s), the setting is made directly in the handle. The probe battery life is 2 months when used in continuous measurement.

B
Radio probe for immersion/penetration measurements



Affordable NTC radio probe for immersion/penetration measurements

C
Radio handle with special probe heads

The radio handle is simply fitted with exchangeable probe heads. Two special T/C probe heads for air/immersion/penetration and surface measurements are available.

D
Radio handle with T/C adapter for conventional T/C probes

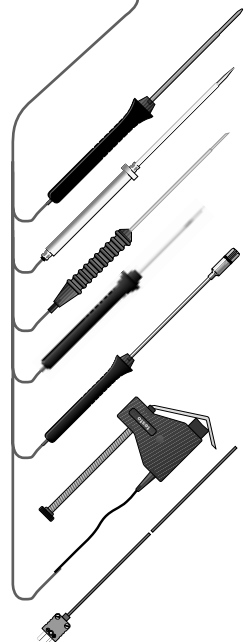

All conventional thermocouple probes of Type K can be attached to the radio handle via the T/C adapter included in delivery.





Option: Radio
Ordering data

A Radio module for upgrading measuring instrument with radio option		
Country versions	Radio freq.	Part no.
Radio module for measuring instrument, 869.85 MHz, approval for the countries: DE, FR, UK, BE, NL, ES, IT, SE, AT, DK, FI, HU, CZ, PL, GR, CH, PT, SI, MT, CY, SK, LU, EE, LT, IE, LV, NO	869.85 MHz FSK	0554 0188
Radio module for measuring instrument, 915.00 MHz FSK, approval for USA, CA, CL	915.00 MHz FSK	0554 0190

B Radio probes for immersion/penetration measurements					
Radio immersion/penetration probes	Meas. range	Accuracy	Resolution	99	
Radio immersion/penetration probe, NTC 	-50 to +275 °C	±0.5 °C (-20 to +80 °C) ±0.8 °C (-50 to -20.1 °C) ±0.8 °C (+80.1 to +200 °C) ±1.5 °C (remaining range)	0.1 °C	t ₉₉ (in water) 12 s	
Country versions	Radio freq.	Part no.			
Radio immersion/penetration probe, NTC, approval for the countries: DE, FR, UK, BE, NL, ES, IT, SE, AT, DK, FI, HU, CZ, PL, GR, CH, PT, SI, MT, CY, SK, LU, EE, LT, IE, LV, NO	869.85 MHz FSK	0613 1001			
Radio immersion/penetration probe, NTC, approval for USA, CA, CL	915.00 MHz FSK	0613 1002			

C Assembled for you: Radio handles with probe head					
Radio handles with probe head for air-/ immersion-penetration-meas.	Meas. range	Accuracy	Resolution	99	
Radio handle for attachable probe heads with T/C probe head for air and immersion/penetration measurement 	-50 to +350 °C Short-term to +500 °C	Radio handle: ±(0.5 °C +0.3% of mv) (-40 to +500 °C) ±(0.7 °C +0.5% of mv) (remaining range) T/C probe head: Class 2	0.1 °C (-50 to +199.9 °C) 1.0 °C (remaining range)	t ₉₉ (in water) 10 s	
Country versions	Radio freq.	Part no.			
Radio handle for plug-in probe heads, incl. T/C adapter, approval for the countries: DE, FR, UK, BE, NL, ES, IT, SE, AT, DK, FI, HU, CZ, PL, GR, CH, PT, SI, MT, CY, SK, LU, EE, LT, IE, LV, NO	869.85 MHz FSK	0554 0189			
T/C probe head for air/immersion/penetration measurement, attachable to radio handle, T/C Type K		0602 0293			
Radio handle for plug-in probe heads, incl. T/C adapter, approval for USA, CA, CL	915.00 MHz FSK	0554 0191			
T/C probe head for air/immersion/penetration measurement, attachable to radio handle, T/C Type K		0602 0293			

Radio handles with probe head for surface measurement	Meas. range	Accuracy	Resolution	99	
Radio handle for attachable probe heads with T/C probe head for surface measurement 	-50 to +350 °C Short-term to +500 °C	Radio handle: ±(0.5 °C +0.3% of mv) (-40 to +500 °C) ±(0.7 °C +0.5% of mv) (remaining range) T/C probe head: Class 2	0.1 °C (-50 to +199.9 °C) 1.0 °C (remaining range)	5 s	
Country versions	Radio freq.	Part no.			
Radio handle for plug-in probe heads, incl. T/C adapter, approval for the countries: DE, FR, UK, BE, NL, ES, IT, SE, AT, DK, FI, HU, CZ, PL, GR, CH, PT, SI, MT, CY, SK, LU, EE, LT, IE, LV, NO	869.85 MHz FSK	0554 0189			
T/C probe head for surface measurement, attachable to radio handle, T/C Type K		0602 0394			
Radio handle for plug-in probe heads, incl. T/C adapter, approval for USA, CA, CL	915.00 MHz FSK	0554 0191			
T/C probe head for surface measurement, attachable to radio handle, T/C Type K		0602 0394			

D Radio handles, separate					
Radio handles for attachable T/C probes	Meas. range	Accuracy	Resolution		
Radio handle for attachable probe heads incl. adapter for attaching T/C probes (Type K) 	-50 to +1000 °C	±(0.7 °C +0.3% of mv) (-40 to +900 °C) ±(0.9 °C +0.5% of mv) (remaining range)	0.1 °C (-50 to +199.9 °C) 1.0 °C (remaining range)		
Country versions	Radio freq.	Part no.			
Radio handle for plug-in probe heads, incl. T/C adapter, approval for the countries: DE, FR, UK, BE, NL, ES, IT, SE, AT, DK, FI, HU, CZ, PL, GR, CH, PT, SI, MT, CY, SK, LU, EE, LT, IE, LV, NO	869.85 MHz FSK	0554 0189			
Radio handle for plug-in probe heads, incl. T/C adapter, approval for USA, CA, CL	915.00 MHz FSK	0554 0191			

Radio probes: General technical data

	Radio immersion/penetration probe, NTC	Radio handle	Measuring rate	0.5 s or 10 s, adjustable on handle	Radio transmission	Unidirectional
Battery type	2 x 3V button cell (CR 2032)	2 AAA micro batteries			Oper. temp.	-20 to +50 °C
Battery life	150 h (meas. rate 0.5 s) 2 months (meas. rate 10 s)	215 h (meas. rate 0.5 s) 6 months (meas. rate 10 s)	Radio coverage	Up to 20 m (without obstructions)	Storage temp.	-40 to +70 °C

Custom temperature probes

Do none of the standard temperature probes shown on page 84 and 85 meet your requirements? Or do you already have a clear idea of what your solution should look like? Testo offers temperature probes customized just the way you need them and suited to your application. A few examples are shown on this page. You will find more details on customized temperature probes in the brochure "Stationary Measurement Technology for Air Conditioning and Process".

Example from mechanical engineering

To create a press fitting between a gear wheel (hub) and shaft, the gear wheel is heated in a furnace until it reaches a certain temperature. The gear wheel is then fitted onto the shaft to which it remains securely joined after cooling down (known as shrink-fit process). To achieve optimum results, the temperature of the gear wheel is checked during this process using a temperature probe attached, for example, to a robotic arm. The spring-loaded tip of the surface temperature probe ensures optimum contact.

Stationary surface probe with spring-loaded tip

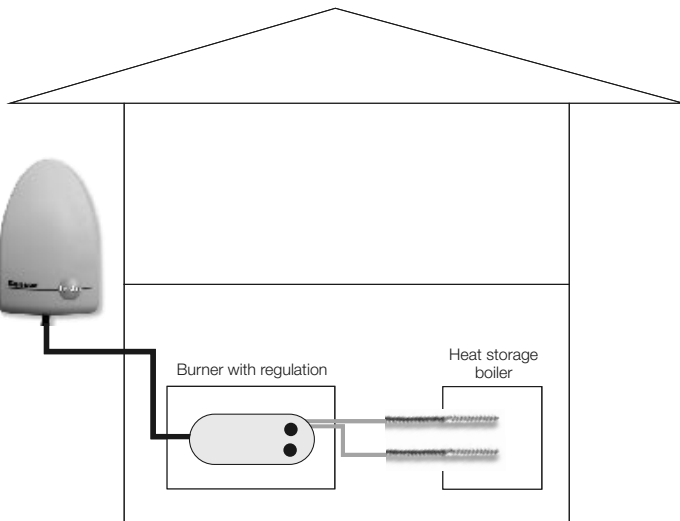
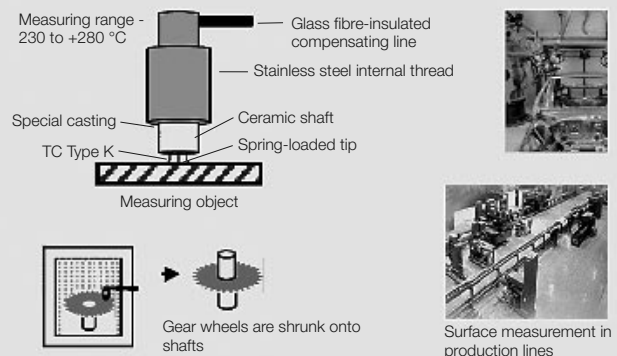

Example from heating system construction

The regulation and control of a heating system takes place via a temperature comparison. Put simply, the outside temperature and the boiler temperature are compared to one another. Depending on the value recorded, a pump, burner or mixer is switched on or off, for example. But how does the regulator know which boiler temperature needs to be reached at which outside temperature? The regulator uses a defined "heating curve". This determines which boiler temperature must be reached depending on the outside temperature measured. This heating curve thus enables the regulator to judge whether the boiler temperature is too high or too low, in which case a reaction then follows, e.g. the burner fires or is switched off, a pump is switched on, etc. The testo probe Type 03 is used to measure the water temperature in the heat storage boiler.

The testo probe Type 20 measures the outside air temperature.

Measurement probes for immersion in water

0699 4153

Example from automotive engineering

Recording the temperature of brake discs during travel demands very robust materials. It is also extremely important to have excellent contact with the measuring object so that the actual temperature is recorded. This requirement is met optimally by soldering the thermocouple wire into a nickel turned part by means of a flush front solder.

Temperature probe for measuring the brake disc temperature

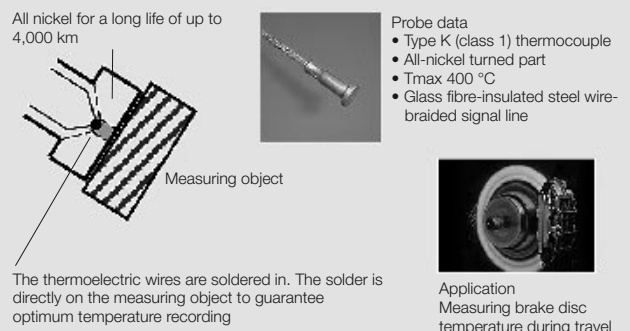

Temperature probe for measuring brake disc temperature

0699 3472



Always at your service!

Please send for more information:

Monitoring Instruments for Food Production, Transport and Storage
Measurement Engineering for Restaurants, Catering and Supermarkets

Measurement Engineering for Air Conditioning and Ventilation

Measurement Engineering for Heating and Installation

Measurement Solutions for Emissions, Service and Thermal Processes

Measurement Solutions for Refrigeration Technology

Stationary Measurement Solutions – Transmitters and Monitoring Systems

Measurement Solutions for Production, Quality Control and Maintenance

Measurement Solutions for Climate Applications in Industry

Reference Measurement Technology for Industry

Measuring Instruments For Temperature

Measuring Instruments for Humidity

Measuring Instruments For Velocity

Measuring Instruments for Pressure and Refrigeration

Multi-Function Measuring Instruments

Measuring Instruments for Flue Gas and Emissions

Measuring Instruments for RPM, Analysis, Current/Voltage

Measuring Instruments For Indoor Air Quality, Light And Sound

Stationary Measurement Technology Humidity / Differential Pressure / Temperature / Process Displays

Stationary Measurement Technology Compressed Air Humidity / Compressed Air Consumption