

EIKI

MULTIMEDIA PROJECTOR

MODEL **LC-XB27**

Network Supported

- Wireless LAN (optionally available)
IEEE802.11b/g
- Wired LAN
100-Base-TX/10-Base-T

Memory Viewer

- USB Memory Viewer (optionally available)

*Refer to the owner's manuals below for details about network and memory viewer function.

■ Owner's Manual

"Network Set-up and Operation"

■ Owner's Manual USB Memory

This manual is provided with optionally supplied USB memory. (Model : WL-10)

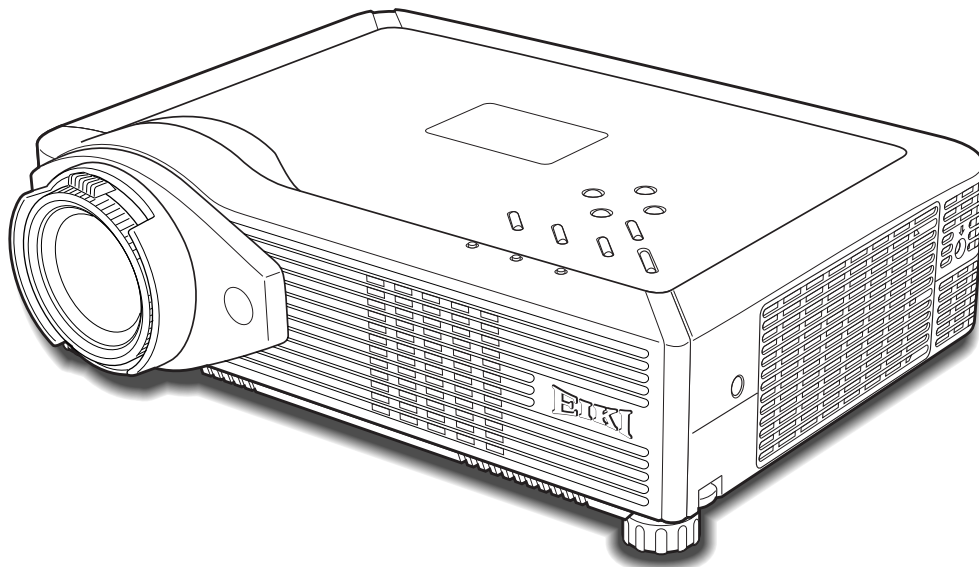

OWNER'S MANUAL

Touchboards

205 Westwood Ave, Long Branch, NJ 07740

Phone: 866-94 BOARDS (26273) / (732)-222-1511

Fax: (732)-222-7088 | E-mail: sales@touchboards.com

Features and Design

This Multimedia Projector is designed with the most advanced technology for portability, durability, and ease of use. This projector utilizes built-in multimedia features, a palette of 16.77 million colors, and matrix liquid crystal display (LCD) technology.

◆ **Compact Design**

This projector is designed compact in size and weight. It is easy to carry and work anywhere you wish to use.

◆ **Compatibility**

The projector widely accepts various video and computer input signals including; Computers, 6 Color systems (PAL, SECAM, NTSC, NTSC4.43, PAL-M, PAL-N), Component video, S-video and RGB scart.

◆ **Simple Computer System Setting**

The projector has the Multi-scan system to conform to almost all computer output signals quickly. (p31) Up to UXGA resolution can be accepted.

◆ **Quick Termination**

The AC cord can be plugged out right after turning off the projector. (p22)

◆ **Useful Functions for a Presentation**

- The digital zoom function allows you to focus on the crucial information during a presentation. (p38)
- The noise reduction function helps you to reduce the contained noise on the screen to get smoother images. (p44)
- Blackboard* can be used as a projection screen.
 - * The board color is limited to Green. (p35, 42)

◆ **Multilanguage Menu Display**

Operation menu is available in 16 languages; English, German, French, Italian, Spanish, Portuguese, Dutch, Swedish, Finnish, Polish, Hungarian, Romanian, Russian, Chinese, Korean, or Japanese. (p46)

◆ **Power Management**

The Power management function reduces power consumption and maintains the lamp life. (p50)

✓ **Note:**

- The On-Screen Menu and figures in this manual may differ slightly from the product.
- The contents of this manual are subject to change without notice.

◆ **Logo Function**

The Logo function allows you to customize the screen logo with the Logo functions. (p48, 49) You can capture an image for the screen logo, choose a logo between provided and captured.

◆ **Switchable Interface Terminal**

The projector provides a switchable interface terminal. You can use the terminal as computer input or monitor output conveniently. (p50)

◆ **Lamp Control**

Brightness of the projection lamp can be selected. (p51)

◆ **Security Function**

The Security function helps you to ensure the security with the Key lock (p52) and the PIN code lock (p21, 52, 53) functions. You can lock the operation on the projector and the remote control. Also you can prevent unauthorized persons from using the projector.

◆ **LAN Network Function**

This projector is loaded with Wired and Wireless LAN* network function. You can project an image on a computer via the network. You can also operate and manage the projector via the network. For details, refer to the owner's manual "Network Set-up and Operation" supplied with this projector.

*Dedicated USB Wireless LAN adapter for Wireless operation is optionally available (Model : WL-30)

◆ **Memory Viewer Function (Optional Function)**

Insert the dedicated USB memory (optionally supplied: Model WL-10), into the projector to project images or presentation data stored in it. You do not have to carry a computer or other equipment for a presentation. For details, refer to the owner's manual provided with optionally supplied USB memory.

Table of Contents

Features and Design	3	Computer Input	29
Table of Contents	4	Input Source Selection	
To the Owner	5	(RGB : Computer 1(Analog) / Computer 2)	29
Safety Instructions	6	Input Source Selection	
Air Circulation	7	(RGB(PC digital), RGB(AV HDCP))	30
Installing the Projector in Proper Position	7	Computer System Selection	31
Moving the Projector	7	Auto PC Adjustment	32
Compliance	8	Manual PC Adjustment	33
Part Names and Functions	9	Image Level Selection	35
Front	9	Image Level Adjustment	36
Back	9	Screen Size Adjustment	37
Bottom	9	Video Input	39
Rear Terminal / Side Terminal	10	Input Source Selection (Video, S-video)	39
Top Control	11	Input Source Selection	
Remote Control	12	(Component, RGB Scart 21-pin)	40
Laser Pointer Function	13	Video System Selection	41
Pointer Function	13	Image Level Selection	42
Wireless Mouse Operation	14	Image Level Adjustment	43
Remote Control Code	14	Screen Size Adjustment	45
Remote Control Battery Installation	15	Setting	46
Operating Range	15	Setting	46
Adjustable Feet	15	Maintenance and Cleaning	55
Installation	16	Warning Indicator	55
Positioning the Projector	16	Cleaning the Air Filters	56
Connecting the AC Power Cord	17	Attaching the Lens Cover	56
Connecting to a Computer	18	Cleaning the Projection Lens	57
Connecting to Video Equipment	19	Cleaning the Projector Cabinet	57
Connecting to Component Video Equipment	20	Lamp Replacement	58
Basic Operation	21	Lamp Replacement Counter	59
Turning On the Projector	21	Appendix	60
Turning Off the Projector	22	Troubleshooting	60
How to Operate the On-Screen Menu	23	Menu Tree	62
Menu Bar	24	Indicators and Projector Condition	64
Zoom and Focus Adjustment	25	Compatible Computer Specifications	65
Auto Setup Function	25	Technical Specifications	66
Keystone Correction	25	Optional Parts	67
Sound Adjustment	26	PJ Link Notice	68
Remote Control Operation	27	Configurations of Terminals	69
		PIN Code Number Memo	70

Trademarks

Each name of corporations or products in this book is either a registered trademark or a trademark of its respective corporation.





To the Owner

Before operating this projector, read this manual thoroughly and operate the projector properly.

This projector provides many convenient features and functions. Operating the projector properly enables you to manage those features and maintains it in better condition for a considerable time.

Improper operation may result in not only shortening the product-life, but also malfunctions, fire hazard, or other accidents.

If your projector seems to operate improperly, read this manual again, check operations and cable connections and try the solutions in the "Troubleshooting" section in the end of this booklet. If the problem still persists, contact the dealer where you purchased the projector or the service center.

	CAUTION RISK OF ELECTRIC SHOCK DO NOT OPEN	
CAUTION : TO REDUCE THE RISK OF ELECTRIC SHOCK, DO NOT REMOVE COVER (OR BACK). NO USER-SERVICEABLE PARTS INSIDE EXCEPT LAMP REPLACEMENT. REFER SERVICING TO QUALIFIED SERVICE PERSONNEL.		
	THIS SYMBOL INDICATES THAT DANGEROUS VOLTAGE CONSTITUTING A RISK OF ELECTRIC SHOCK IS PRESENT WITHIN THIS UNIT.	
	THIS SYMBOL INDICATES THAT THERE ARE IMPORTANT OPERATING AND MAINTENANCE INSTRUCTIONS IN THE OWNER'S MANUAL WITH THIS UNIT.	

NOTE: This symbol mark and recycle system are applied only to EU countries and not applied to the countries in the other area of the world.



Your EIKI product is designed and manufactured with high quality materials and components which can be recycled and reused.

This symbol means that electrical and electronic equipment, at their end-of-life, should be disposed of separately from your household waste.

Please dispose of this equipment at your local community waste collection/recycling centre.

In the European Union there are separate collection systems for used electrical and electronic products.

Please help us to conserve the environment we live in!



Safety Precaution

WARNING : TO REDUCE THE RISK OF FIRE OR ELECTRIC SHOCK, DO NOT EXPOSE THIS APPLIANCE TO RAIN OR MOISTURE.

- This projector produces intense light from the projection lens. Do not stare directly into the lens as much as possible. Eye damage could result. Be especially careful that children do not stare directly into the beam.
- Install the projector in a proper position. If not, it may result in a fire hazard.
- Provide appropriate space on the top, sides and rear of the projector cabinet for allowing air circulation and cooling the projector. Minimum clearance must be maintained. If the projector is to be built into a compartment or similarly enclosed, the minimum distances must be maintained. Do not cover the ventilation slot on the projector. Heat build-up can reduce the service life of your projector, and can also be dangerous.

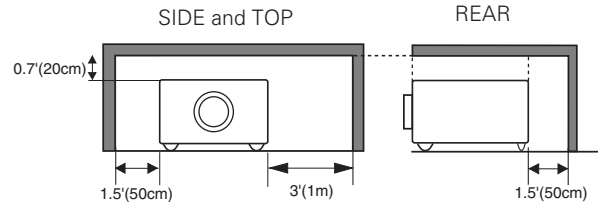

- If the projector is not to be used for an extended time, unplug the projector from the power outlet.



CAUTION ON HANGING FROM THE CEILING

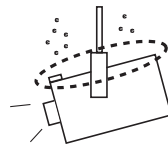

When hanging the projector from the ceiling, clean air intake vents, air filters, or top of the projector periodically with a vacuum cleaner. If you leave the projector without cleaning for a long time, the dust will block the operation of the cooling function, and it may cause a breakdown or a disaster.

DO NOT SET THE PROJECTOR IN GREASY, WET, OR SMOKY CONDITIONS SUCH AS IN A KITCHEN TO PREVENT A BREAKDOWN OR A DISASTER. IF THE PROJECTOR COMES IN CONTACT WITH OIL OR CHEMICALS, IT MAY BECOME DETERIORATED.

CAUTION

Not for use in a computer room as defined in the Standard for the Protection of Electronic Computer/Data Processing Equipment, ANSI/NFPA 75.

Ne peut être utilisé dans une salle d'ordinateurs telle que définie dans la norme ANSI/NFPA 75 Standard for Protection of Electronic Computer/Data Processing Equipment

READ AND KEEP THIS OWNER'S MANUAL FOR LATER USE.

Safety Instructions

All the safety and operating instructions should be read before the product is operated.

Read all of the instructions given here and retain them for later use. Unplug this projector from AC power supply before cleaning. Do not use liquid or aerosol cleaners. Use a damp cloth for cleaning.

Follow all warnings and instructions marked on the projector.

For added protection to the projector during a lightning storm, or when it is left unattended and unused for long periods of time, unplug it from the wall outlet. This will prevent damage due to lightning and power line surges.

Do not expose this unit to rain or use near water... for example, in a wet basement, near a swimming pool, etc...

Do not use attachments not recommended by the manufacturer as they may cause hazards.

Do not place this projector on an unstable cart, stand, or table. The projector may fall, causing serious injury to a child or adult, and serious damage to the projector. Use only with a cart or stand recommended by the manufacturer, or sold with the projector. Wall or shelf mounting should follow the manufacturer's instructions, and should use a mounting kit approved by the manufacturers.

An appliance and cart combination should be moved with care. Quick stops, excessive force, and uneven surfaces may cause the appliance and cart combination to overturn.



Slots and openings in the back and bottom of the cabinet are provided for ventilation, to ensure reliable operation of the equipment and to protect it from overheating.

The openings should never be covered with cloth or other materials, and the bottom opening should not be blocked by placing the projector on a bed, sofa, rug, or other similar surface. This projector should never be placed near or over a radiator or heat register.

This projector should not be placed in a built-in installation such as a book case unless proper ventilation is provided.

Never push objects of any kind into this projector through cabinet slots as they may touch dangerous voltage points or short out parts that could result in a fire or electric shock. Never spill liquid of any kind on the projector.

Do not install the projector near the ventilation duct of air-conditioning equipment.

This projector should be operated only from the type of power source indicated on the marking label. If you are not sure of the type of power supplied, consult your authorized dealer or local power company.

Do not overload wall outlets and extension cords as this can result in fire or electric shock. Do not allow anything to rest on the power cord. Do not locate this projector where the cord may be damaged by persons walking on it.

Do not attempt to service this projector yourself as opening or removing covers may expose you to dangerous voltage or other hazards. Refer all servicing to qualified service personnel.

Unplug this projector from wall outlet and refer servicing to qualified service personnel under the following conditions:

- a. When the power cord or plug is damaged or frayed.
- b. If liquid has been spilled into the projector.
- c. If the projector has been exposed to rain or water.
- d. If the projector does not operate normally by following the operating instructions. Adjust only those controls that are covered by the operating instructions as improper adjustment of other controls may result in damage and will often require extensive work by a qualified technician to restore the projector to normal operation.
- e. If the projector has been dropped or the cabinet has been damaged.
- f. When the projector exhibits a distinct change in performance-this indicates a need for service.

When replacement parts are required, be sure the service technician has used replacement parts specified by the manufacturer that have the same characteristics as the original part. Unauthorized substitutions may result in fire, electric shock, or injury to persons.

Upon completion of any service or repairs to this projector, ask the service technician to perform routine safety checks to determine that the projector is in safe operating condition.



Voor de klanten in Nederland

Bij dit produkt zijn batterijen geleverd.

Wanneer deze leeg zijn, moet u ze niet weggooien maar inleveren als KCA.



Air Circulation

Openings in the cabinet are provided for ventilation and to ensure reliable operation of the product and to protect it from overheating, and these openings must not be blocked or covered.

CAUTION

Hot air is exhausted from the exhaust vent. When using or installing the projector, the following precautions should be taken.

- Do not put any flammable object or spray can near the projector, hot air is exhausted from the ventilation holes.
- Keep the exhaust vent at least 3'(1m) away from any objects.
- Do not touch a peripheral part of the exhaust vent, especially screws and metallic part. This area will become hot while the projector is being used.
- Do not put anything on the cabinet. The materials put on the cabinet will not only get damaged but also cause fire hazard by heat.

Cooling fans are provided to cool down the projector. The fans' running speed is changed according to the temperature inside the projector.

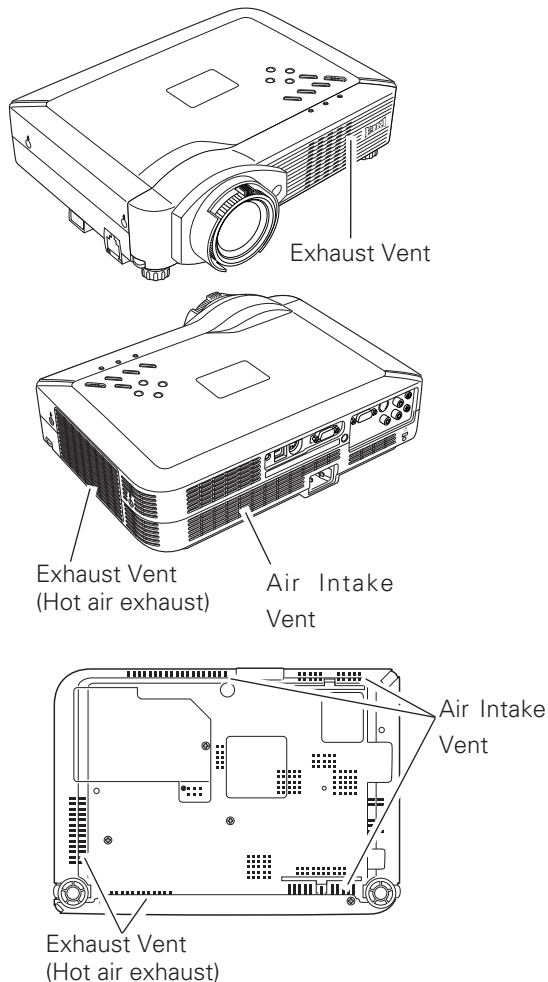

Installing the Projector in Proper Position

Install the projector properly. Improper Installation may reduce the lamp life and cause a fire hazard.

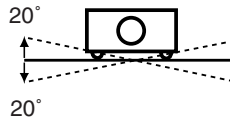

Do not tilt the projector more than 20 degrees from side to side.



Do not point the projector up to project an image.



Do not point the projector down to project an image.



Do not put the projector on either side to project an image.

Moving the Projector

When moving the projector, replace the lens cover and retract the adjustable feet to prevent damage to the lens and cabinet. When the projector is not in use for an extended period, put it into a suitable case to protect the projector.

When handling the projector, do not drop, bump, subject it to strong forces or put other things on the cabinet.

USE CAUTION IN CARRYING OR TRANSPORTING THE PROJECTOR

- Do not drop or bump the projector, otherwise damages or malfunctions may result.
- When carrying the projector, use a suitable carrying case.
- Do not transport the projector by using a courier or transport service in an unsuitable transport case. This may cause damage to the projector. To transport the projector through a courier or transport service, consult your dealer for their information.
- Do not put the projector in a case before the projector is cooled enough.

Compliance

Federal Communication Commission Notice

Note : This equipment has been tested and found to comply with the limits for a Class B digital device, pursuant to part 15 of the FCC Rules. These limits are designed to provide reasonable protection against harmful interference in a residential installation. This equipment generates, uses and can radiate radio frequency energy and, if not installed and used in accordance with the instructions, may cause harmful interference to radio communications. However, there is no guarantee that interference will not occur in a particular installation. If this equipment does cause harmful interference to radio or television reception, which can be determined by turning the equipment off and on, the user is encouraged to try to correct the interference by one or more of the following measures :

- Reorient or relocate the receiving antenna.
- Increase the separation between the equipment and receiver.
- Connect the equipment into an outlet on a circuit different from that to which the receiver is connected.
- Consult the dealer or an experienced radio/TV technician for help.

Use of shielded cable is required to comply with class B limits in Subpart B of Part 15 of FCC Rules.

Do not make any changes or modifications to the equipment unless otherwise specified in the instructions. If such changes or modifications should be made, you could be required to stop operation of the equipment.

Model Number : LC-XB27
Trade Name : EIKI
Responsible party : EIKI International, Inc.
Address : 30251 Esperanza Rancho Santa Margarita CA 92688-2132
Telephone No. : 800-242-3454 (949-457-0200)

AC Power Cord Requirement

The AC Power Cord supplied with this projector meets the requirement for use in the country you purchased it.

AC Power Cord for the United States and Canada :

AC Power Cord used in the United States and Canada is listed by the Underwriters Laboratories (UL) and certified by the Canadian Standard Association (CSA).

AC Power Cord has a grounding-type AC line plug. This is a safety feature to be sure that the plug will fit into the power outlet. Do not try to defeat this safety feature. Should you be unable to insert the plug into the outlet, contact your electrician.

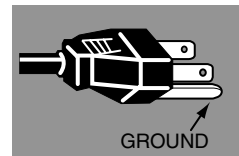

THE SOCKET-OUTLET SHOULD BE INSTALLED NEAR THE EQUIPMENT AND EASILY ACCESSIBLE.

Part Names and Functions

Front

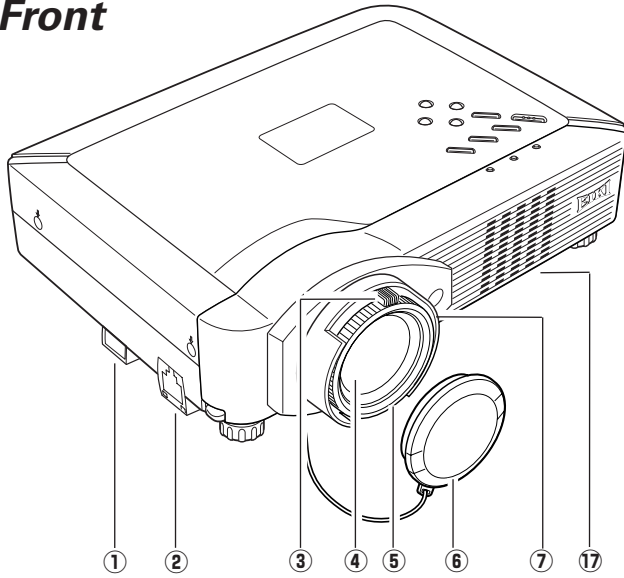

- ① USB Terminal
- ② LAN Connection Terminal
- ③ Zoom Lever
- ④ Projection Lens
- ⑤ Focus Ring
- ⑥ Lens Cover
- (See page 56 for attaching.)
- ⑦ Infrared Remote Receiver

- ⑧ Top Controls and Indicators
- ⑨ Speaker
- ⑩ Air Intake Vent
- ⑪ Power Cord Connector
- ⑫ Terminals and Connectors

Back

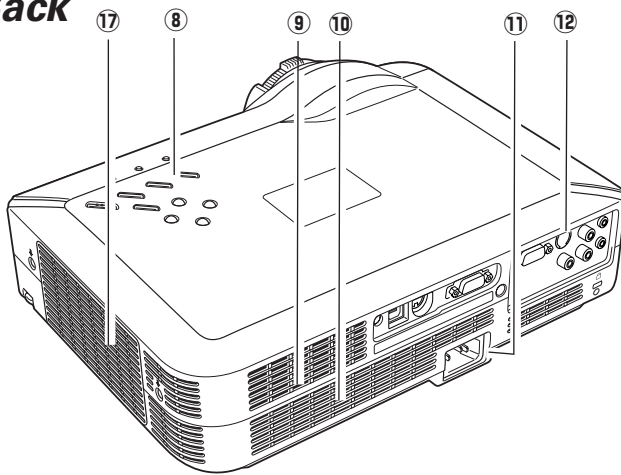

- ⑬ Lamp Cover
- ⑭ Air Intake Vents (back and bottom)
- ⑮ Air Filters
- ⑯ Adjustable Feet
- ⑰ Exhaust Vents

CAUTION

Hot air is exhausted from the exhaust vent. Do not put heat-sensitive objects near this side.

Bottom

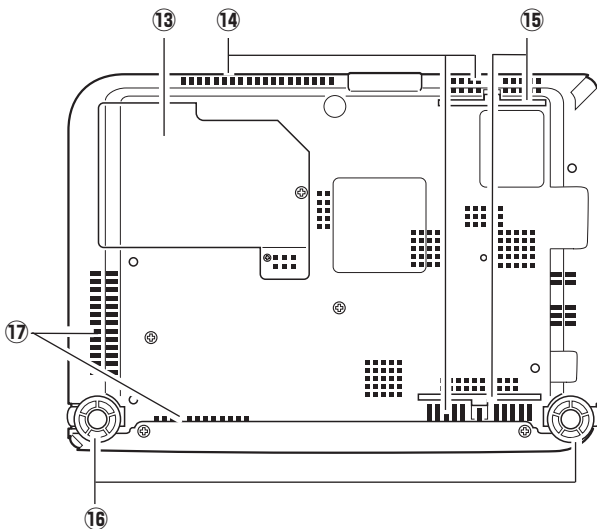

Note:

① USB Terminal and ② LAN Connection Terminal are for the Network function. Refer to the owner's manual "Network Set-up and Operation" supplied with this projector or the owner's manual of Memory viewer (optionally available).

Rear Terminal / Side Terminal

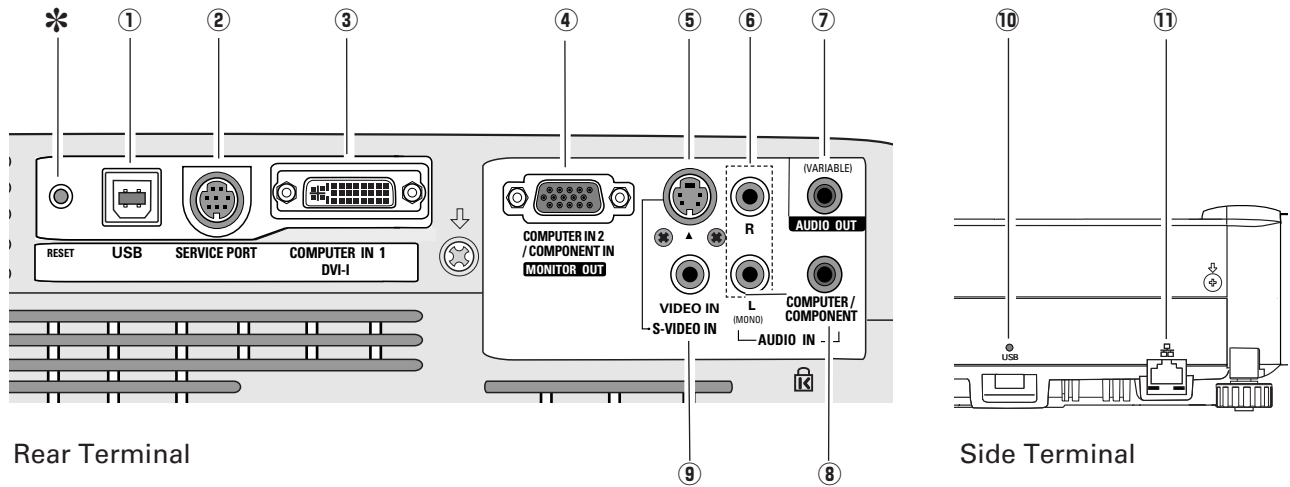

Rear Terminal

Side Terminal

① USB (Series B)

In order to operate the computer with the remote control and use the PAGE ▲▼ buttons on the remote control during a presentation, connect the USB port of the computer to the USB terminal with a USB cable. (p12, 18)

② SERVICE PORT

This jack is used to service the projector.

③ COMPUTER IN 1 / DVI-I

Connect computer output (Digital / Analog DVI-I type) to this terminal. (p18)

④ COMPUTER IN 2 / COMPONENT IN / MONITOR OUT

This terminal is switchable and can be used for input from a computer, video equipment (Component or RGB Scart) or output to the other monitor. Optional cables are required when using this terminal as component input or RGB Scart 21-Pin Video input. (p69)

Set the terminal up as either Computer input or Monitor output properly. (Used for Monitor out, this terminal outputs only incoming signal from COMPUTER IN 1 / DVI-I terminal.) (p18, 20, 50)

⑤ S-VIDEO IN

Connect the S-VIDEO output from video equipment to this jack. (p19)

⑥ AUDIO IN

Connect the audio output from video equipment connected to ⑤ or ⑨ to this jack. (When the audio output is monaural, connect it to L (MONO) jack.) (p19)

⑦ AUDIO OUT(VARIABLE)

Connect an external audio amplifier to this jack. (p18- 20)

This terminal outputs sound from AUDIO IN terminal (⑥ or ⑧).

⑧ COMPUTER/ COMPONENT AUDIO IN

Connect the audio output (stereo) from a computer or video equipment connected to ③ or ④ to this jack. (p18, 20)

⑨ VIDEO IN

Connect the composite video output from video equipment to VIDEO jack. (p19)

⑩ USB (Series A)

Connect optionally supplied USB Wireless LAN Adapter or USB memory for Memory viewer operation. (Refer to the owner's manual supplied with optionally available USB memory.)

⑪ LAN connection

Connect the LAN cable. (Refer to the owner's manual "Network Set-up and Operation" supplied with this projector.)

*** RESET button**

A built-in micro processor which controls this unit may occasionally malfunction and need to be reset. This can be done by pressing the RESET button with a pen, which will shut down and restart the unit. Do not use the RESET function excessively.

Top Control

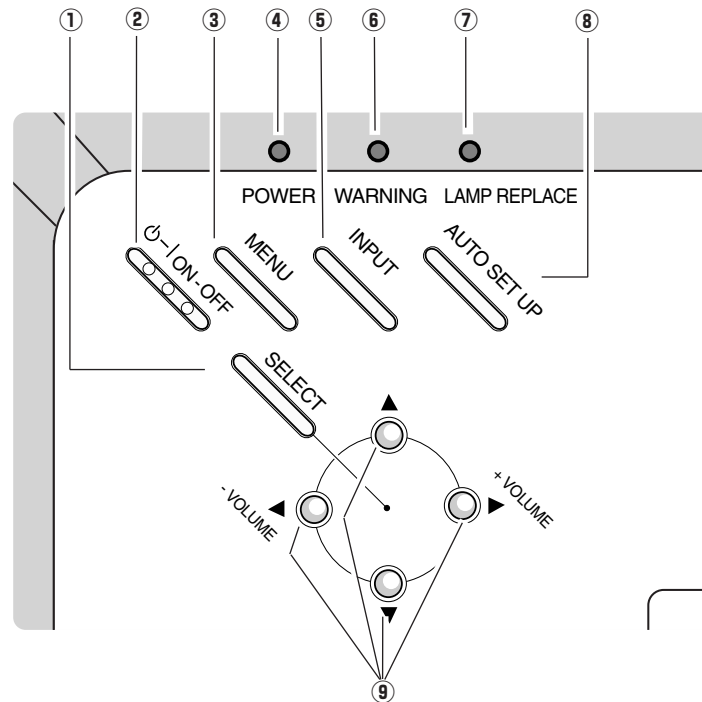

- ① **SELECT button**
- Execute the selected item. (p23)
 - Expand or compress the image in Digital zoom mode. (p38)
- ② **POWER ON-OFF button**
- Turn the projector on or off. (p21, 22)
- ③ **MENU button**
- Open or close the On-Screen Menu. (p23)
- ④ **POWER indicator**
- Emit a red light until the projector gets ready to be turned on. It turns red when the projector is in the stand-by mode. It remains green while the projector is under operation. (p21, 22, 64)
- ⑤ **INPUT button**
- Select input source. (p29, 30, 39, 40)
- ⑥ **WARNING indicator**
- Emit a red light when the projector detects abnormal condition. This also blinks red when the internal temperature of the projector exceeds the operating range. (p55, 64)
- ⑦ **LAMP REPLACE indicator**
- Turn yellow when the life of the projection lamp draws to an end. (p58, 64)
- ⑧ **AUTO SETUP button**
- Correct vertical keystone distortion and adjust computer display parameters including Fine sync., Total dots and Picture position. (p25, 46)
- ⑨ **POINT (▲▼◀▶) buttons**
- Select an item or adjust the value in the On-Screen Menu. (p23)
 - Pan the image in Digital zoom + mode. (p38)
 - Adjust the volume level. (Point ◀▶ buttons) (p26)

Remote Control

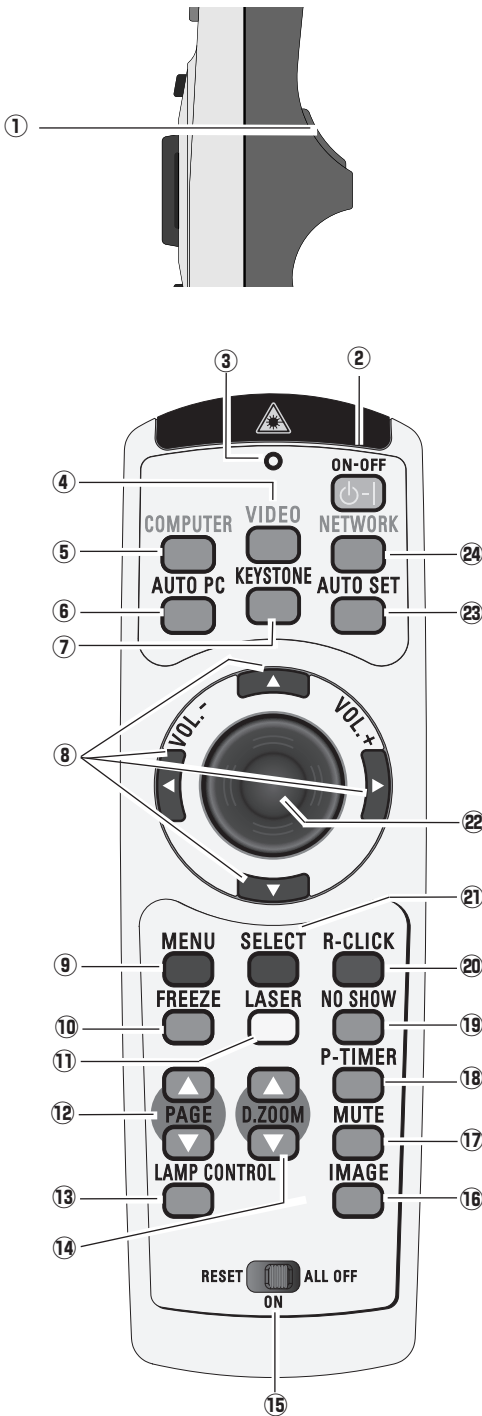

To ensure safe operation, please observe the following precautions :

- Do not bend, drop the remote control or expose the remote control to moisture or heat.
- For cleaning, use soft dry cloth. Do not apply benzene, thinner, splay or any chemical material.

- ① **L-CLICK button**
Act as left click for wireless mouse operation. (p14)
- ② **POWER ON-OFF button**
Turn the projector on or off. (p21, 22)
- ③ **SIGNAL EMISSION indicator**
This indicator lights red while the laser beam is being emitted from the laser light window or a signal is being sent from the remote control to the projector.
- ④ **VIDEO button**
Select VIDEO input source. (p39)
- ⑤ **COMPUTER button**
Select COMPUTER input source. (p29, 30, 40)
- ⑥ **AUTO PC button**
Automatically adjust the computer image to its optimum setting. (p27, 32, 46)
- ⑦ **KEystone button**
Correct the keystone distortion. (p25, 27, 47)
- ⑧ **Point ▲▼◀▶ (VOLUME + / -) buttons**
 - Select an item or adjust the value in the On-Screen Menu. (p23)
 - Pan the image in Digital zoom + mode. (p38)
 - Adjust the volume level. (Point ◀▶ buttons) (p26)
- ⑨ **MENU button**
Open or close the On-Screen Menu. (p23)
- ⑩ **FREEZE button**
Freeze the picture. (p27)
- ⑪ **LASER button**
 - Operate the Laser pointer function. Laser beam is emitted while pressing this button within 1 minute. When using this laser pointer for more than 1 minute, release the LASER button and press it again. (p13)
 - Display the Pointer on the screen. (p13)
- ⑫ **PAGE ▲▼ buttons**
Scroll back and forth pages on the screen when giving a presentation. Connect the projector and your computer with a USB cable to use these buttons. (p10, 18)
- ⑬ **LAMP CONTROL button**
Select the lamp mode. (p27, 51)
- ⑭ **D.ZOOM ▲▼ buttons**
Zoom in and out the images. (p27, 38)
- ⑮ **RESET/ON/ALL-OFF switch**
When using the remote control, set this switch to "ON." Set it to "ALL OFF" for power saving when it is not used. Slide this switch to "RESET" to initialize the remote control code or switch Spotlight and Pointer back to Laser pointer. (p13, 14)
- ⑯ **IMAGE button**
Select the image level. (p28, 35, 42)
- ⑰ **MUTE button**
Mute the sound. (p 26)
- ⑱ **P-TIMER button**
Operate the P-timer function. (p28)
- ⑲ **NO SHOW button**
Temporarily turn off the image on the screen. (p28)
- ⑳ **R-CLICK button**
Act as right click for wireless mouse operation. (p14)
- ㉑ **SELECT button**
 - Execute the selected item. (p23)
 - Expand or compress the image in Digital zoom mode. (p38)
- ㉒ **PRESENTATION POINTER button**
Move a pointer of the projector or a pointer for wireless mouse operation. (p13,14)
- ㉓ **AUTO SET button**
Correct vertical keystone distortion and adjust PC display parameters. (p25, 46)
- ㉔ **NETWORK button**
Select network input or Memory viewer input. Refer to the owner's manual "Network Set-up and Operation" supplied with this projector or the owner's manual of Memory viewer (optionally available).

Laser Pointer Function

This remote control emits a laser beam from the laser light window. With the LASER button pressed, laser light goes on. The signal emission indicator lights red and laser is emitted with red light. With the LASER button pressed for more than 1 minute or released, the light goes off.

The laser emitted is a class II laser. Do not look into the laser light window or shine the laser beam on yourself or other people. Below are the caution labels for laser beam.

CAUTION : Use of controls, adjustments or performance of procedures other than those specified herein may result in hazardous radiation exposure. Do not look into the laser light window while laser is emitted, otherwise eye damage may result.

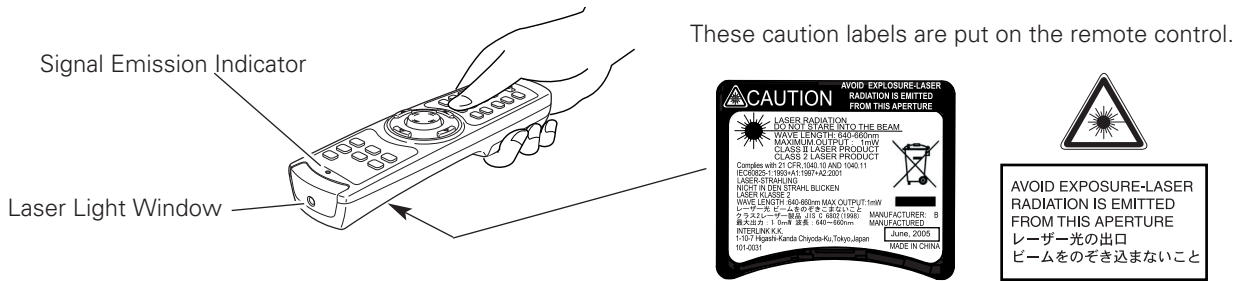

Pointer Function

You can move Spotlight or Pointer of the projector with the remote control to emphasize a part of the projected image.

- 1 With pressing the MENU button, hold down the NO SHOW button for more than 10 seconds so that the Pointer function will be available. (The Laser pointer has switched to the Pointer.)
- 2 Press the LASER button on the remote control toward the projector. Spotlight or Pointer is displayed on the screen with the LASER button lighting green. Then move the Spotlight or Pointer with the PRESENTATION POINTER button. If the LASER button does not light green and still emits laser beam, try the procedure above until the LASER button lights green.
- 3 To clear the Spotlight or Pointer out the screen, press the LASER button toward the projector and see if the LASER button lighting turns off. To switch back to the Laser pointer again, hold down the NO SHOW button with pressing the MENU button for more than 10 seconds or slide the RESET/ON/ALL-OFF switch to "RESET". (p12) When you reset the Pointer function, the remote control code will be reset, as well.

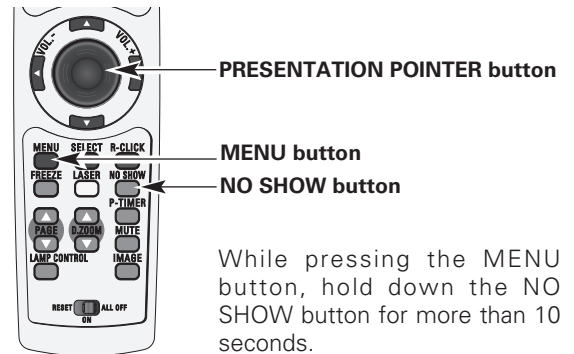

While pressing the MENU button, hold down the NO SHOW button for more than 10 seconds.

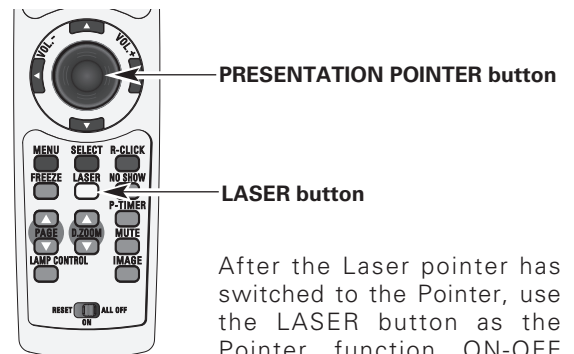

After the Laser pointer has switched to the Pointer, use the LASER button as the Pointer function ON-OFF switch. Press the LASER button toward the projector and see if it lights green.

Spotlight

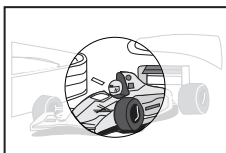

Pointer

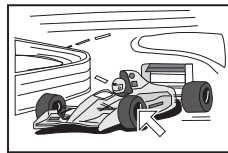

✓ **Note:**

You can choose the size of Spotlight (Large, Middle, and Small) and the pattern of Pointer (Arrow, Finger, and Dot) in the Setting Menu. See "Pointer" on page 51.

Wireless Mouse Operation

The remote control can be used as a wireless mouse for your computer. Before operating the wireless mouse, connect your computer and the projector with the supplied USB cable. (See page 18 for connection.) When the Pointer function is used, the wireless mouse is not available.

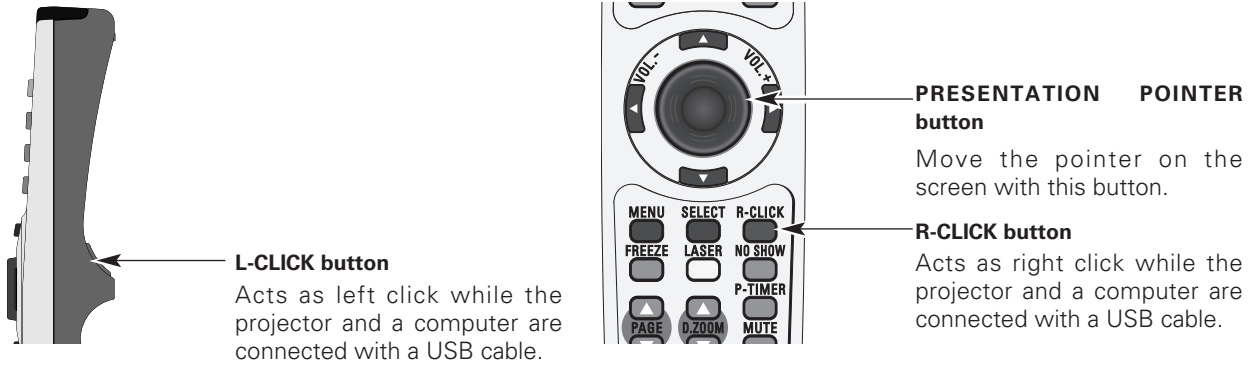

Remote Control Code

This projector has eight different remote control codes (Code 1-Code 8). Switching remote control codes prevents remote control interference when operating several projectors or video equipment at the same time. Change the remote control code for the projector first before changing that for the remote control. See "Remote control" in Setting on page 51.

- 1 With holding down the MENU button, press the IMAGE button. The code switches sequentially for one pressing the IMAGE button. (See the list below.)
- 2 To initialize the remote control code, slide the RESET/ON/ALL-OFF switch to RESET, and then to ON. The initial code is Code 1.

Remote Control Code	Number of Times of Pressing IMAGE Button
Code 1	1
Code 2	2
Code 3	3
Code 4	4
Code 5	5
Code 6	6
Code 7	7
Code 8	8

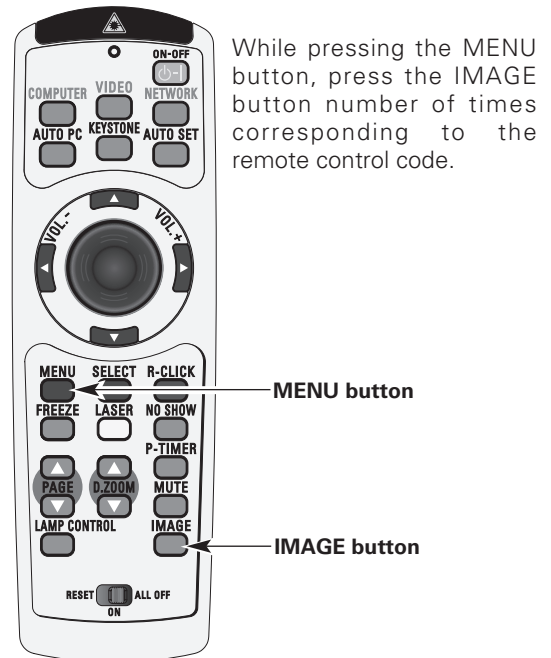

Remote Control Battery Installation

- 1** Open the battery compartment lid.

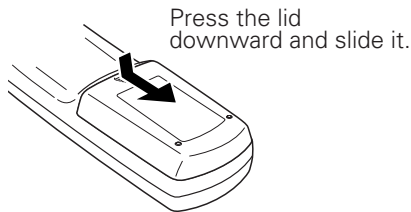

- 2** Slide the batteries into the compartment.

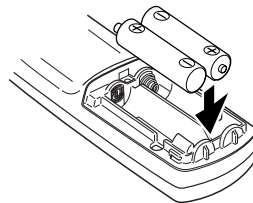

Two AAA size batteries

For correct polarity (+ and -), be sure battery terminals are in contact with pins in compartment.

- 3** Replace the compartment lid.

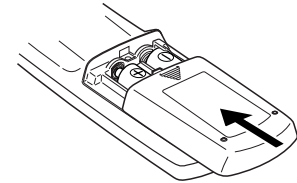

To insure safe operation, please observe the following precautions :

- Use (2) AAA, UM-04 or LR03 type alkaline batteries.
- Always replace batteries in sets.
- Do not use a new battery with a used battery.
- Avoid contact with water or liquid.
- Do not expose the remote control to moisture, or heat.
- Do not drop the remote control.
- If the battery has leaked on the remote control, carefully wipe case clean and install new batteries.
- Risk of an explosion if battery is replaced by an incorrect type.
- Dispose of used batteries according to the instructions.

Operating Range

Point the remote control toward the projector (Infrared Remote Receiver) whenever pressing any button. Maximum operating range for the remote control is about 16.4' (5m) and 60° in front of the projector.

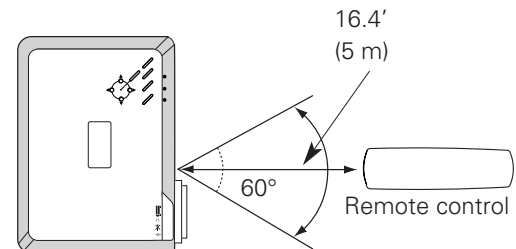

Adjustable Feet

Projection angle can be adjusted up to 10.0 degrees with the adjustable feet.

- 1** Lift the front of the projector and pull upward the feet lock latches on both sides of the projector.
- 2** Release the feet lock latches to lock the adjustable feet and rotate the adjustable feet to adjust the position and tilt.
- 3** Keystone distortion of the projected image can be adjusted automatically with Auto setup function or manually with the remote control or the menu operation. (p25, 46, 47)

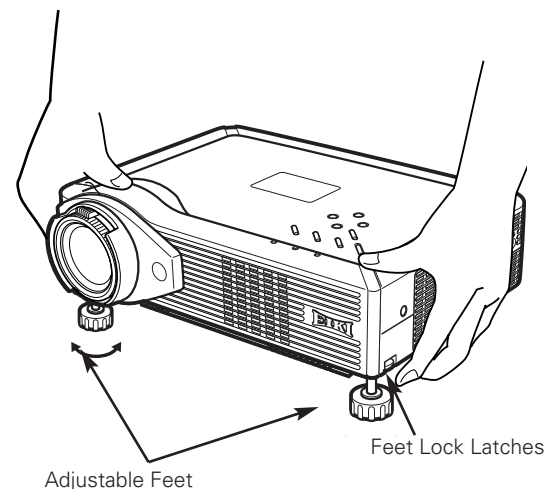

Installation

Positioning the Projector

For projector positioning, see the figures below. The projector should be set horizontally to the flat screen.

✓ Note:

- The brightness in the room has a great influence on picture quality. It is recommended to limit ambient lighting in order to obtain the best image.
- The values shown below are approximate and may vary from the actual sizes.

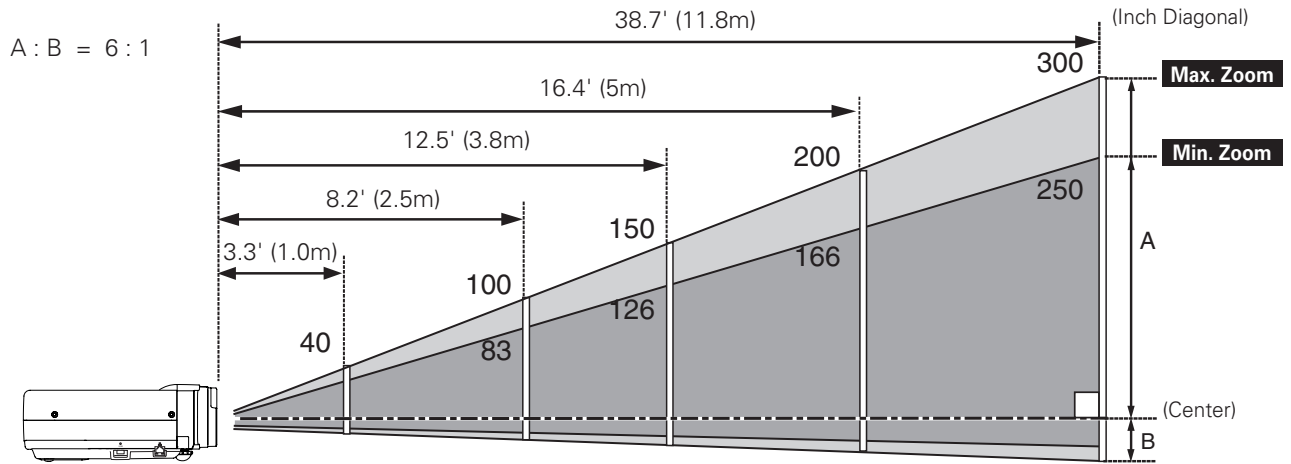

Screen Size (W x H) mm	40"	100"	150"	200"	300"
4 : 3 aspect ratio	813 x 610	2032 x 1524	3048 x 2286	4064 x 3048	6096 x 4572
Zoom (min)	5.2' (1.6m)	12.8' (3.9m)	19.4' (5.9m)	25.9' (7.9m)	38.7' (11.8m)
Zoom (max)	3.3' (1.0m)	8.2' (2.5m)	12.5' (3.8m)	16.4' (5m)	24.9' (7.6m)

Connecting the AC Power Cord

This projector uses nominal input voltages of 100-120 V or 200-240 V AC. This projector automatically selects the correct input voltage. It is designed to work with single-phase power systems having a grounded neutral conductor. To reduce the risk of electrical shock, do not plug into any other type of power system.

Consult your authorized dealer or service station if you are not sure of the type of power being supplied.

Connect the projector with all peripheral equipment before turning the projector on. (See page 18-20 for connection.)



CAUTION

For safety, unplug the AC power cord when the projector is not in use. When this projector is connected to an outlet with the AC power cord, it is in Stand-by mode and consumes a little electric power.

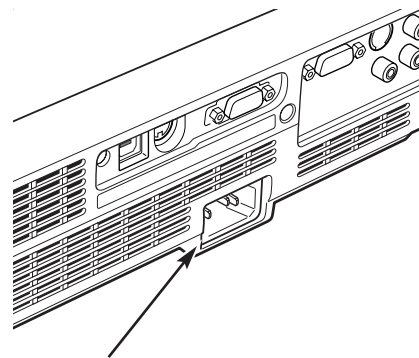

Connect the AC power cord (supplied) to the projector. The AC outlet must be near this equipment and must be easily accessible.

NOTE ON THE POWER CORD

AC power cord must meet requirement of the country where you use the projector. Confirm the AC plug type with the chart below and proper AC power cord must be used. If supplied AC power cord does not match your AC outlet, contact your sales dealer.

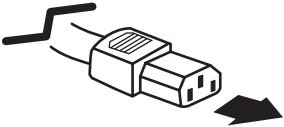
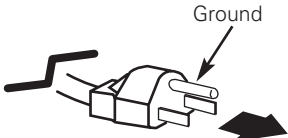
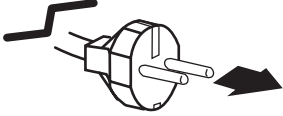
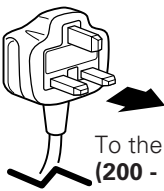
Projector side	AC outlet side		
 <p data-bbox="207 1268 407 1350">To power cord connector on your projector.</p>	<p data-bbox="508 1073 781 1100">For the U.S.A. and Canada</p>  <p data-bbox="570 1283 753 1335">To the AC outlet. (120 V AC)</p>	<p data-bbox="842 1073 1115 1100">For Continental Europe</p>  <p data-bbox="938 1297 1122 1350">To the AC outlet. (200 - 240 V AC)</p>	<p data-bbox="1235 1073 1378 1100">For the U.K.</p>  <p data-bbox="1279 1272 1463 1325">To the AC outlet. (200 - 240 V AC)</p>

Connecting to a Computer

Cables used for connection

- VGA Cable (Mini D-sub 15 pin) *
 - DVI-VGA Cable
 - USB Cable
 - Audio Cables *
- (* = Not supplied with this projector.)

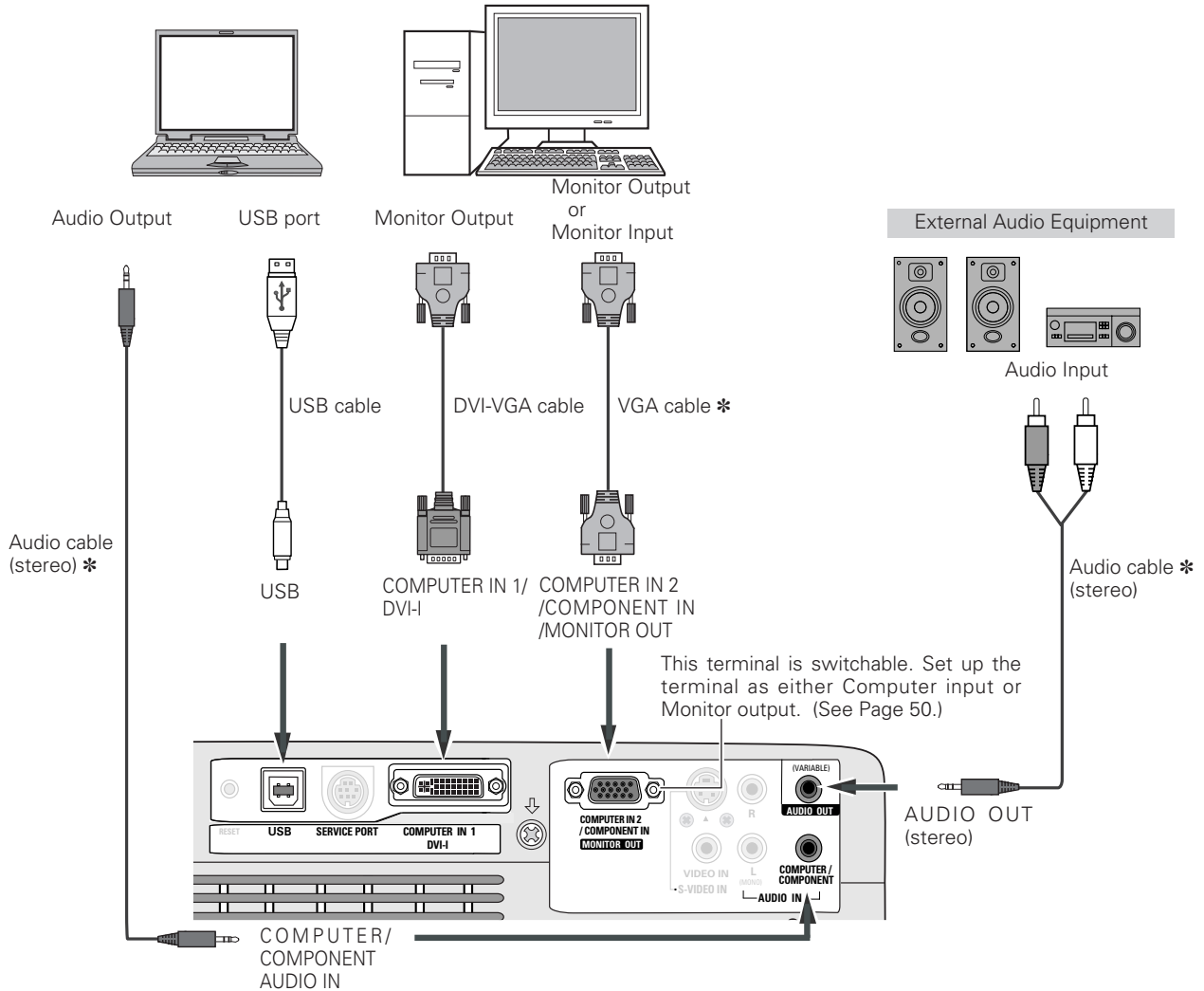

✓ **Note:**

- Input sound to the *COMPUTER / COMPONENT AUDIO IN* terminal when using the *COMPUTER IN 1 / DVI-I* and the *COMPUTER IN 2 / COMPONENT IN / MONITOR OUT* terminal as input.
- When connecting the *AUDIO OUT* to external audio equipment, the projector's built-in speaker is disconnected.
- When the cable is of the longer variety, it is advisable to use the *COMPUTER IN 1 / DVI-I* and not the *COMPUTER IN 2 / COMPONENT IN / MONITOR OUT*.
- USB cable connection is needed when operating the computer with the remote control or using the *PAGE ▲▼* buttons on the remote control.

 When connecting the cable, the power cords of both the projector and the external equipment should be disconnected from AC outlet.

Connecting to Video Equipment

Cables used for connection

- Video and Audio Cable (RCA x 3) *
- S-VIDEO Cable *
- Audio Cable *

(* = Not supplied with this projector.)

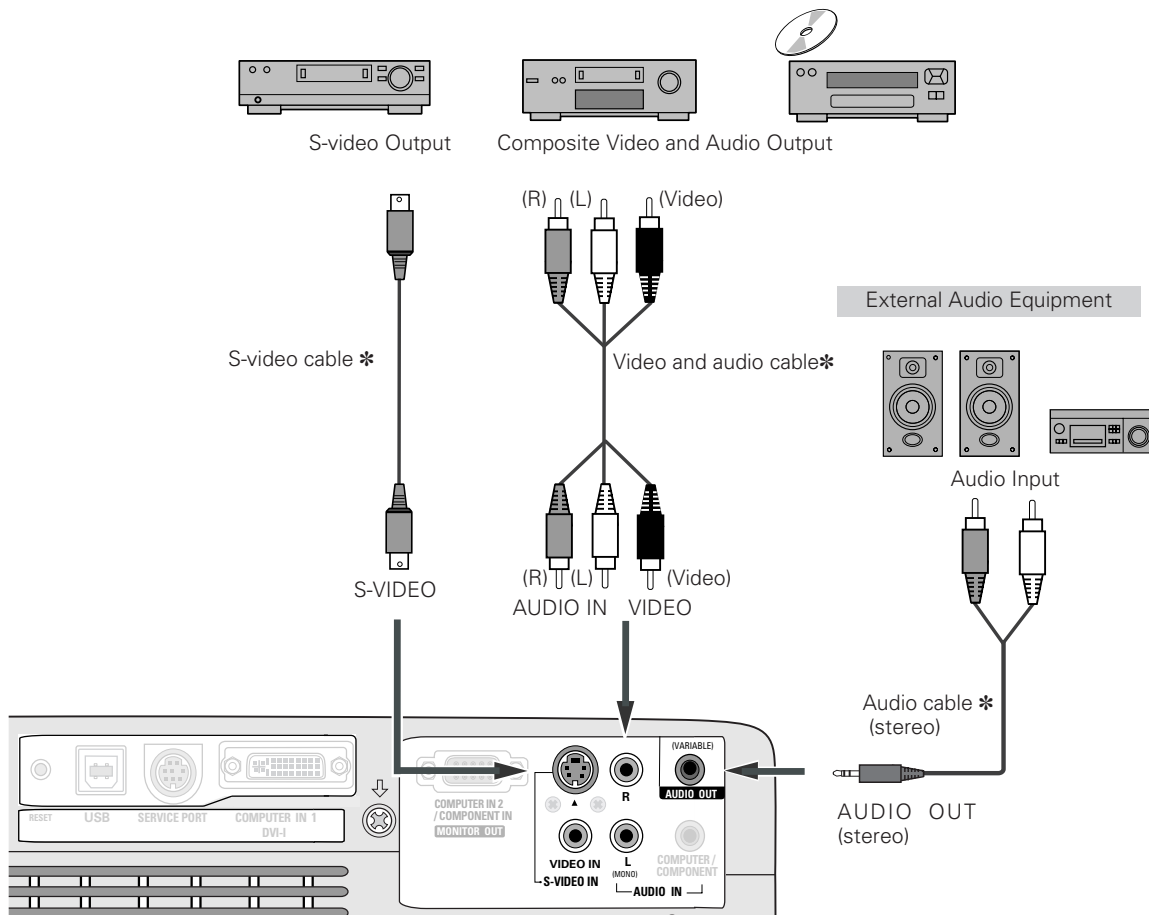

✓ Note:

When connecting AUDIO OUT to external audio equipment, the projector's built-in speaker is disconnected.



When connecting the cable, the power cords of both the projector and the external equipment should be disconnected from AC outlet.

Connecting to Component Video Equipment

Cables used for connection

- Audio Cables *
 - Scart-VGA Cable *
 - Component Cable *
 - Component-VGA Cable *
- (* = Not supplied with this projector.)

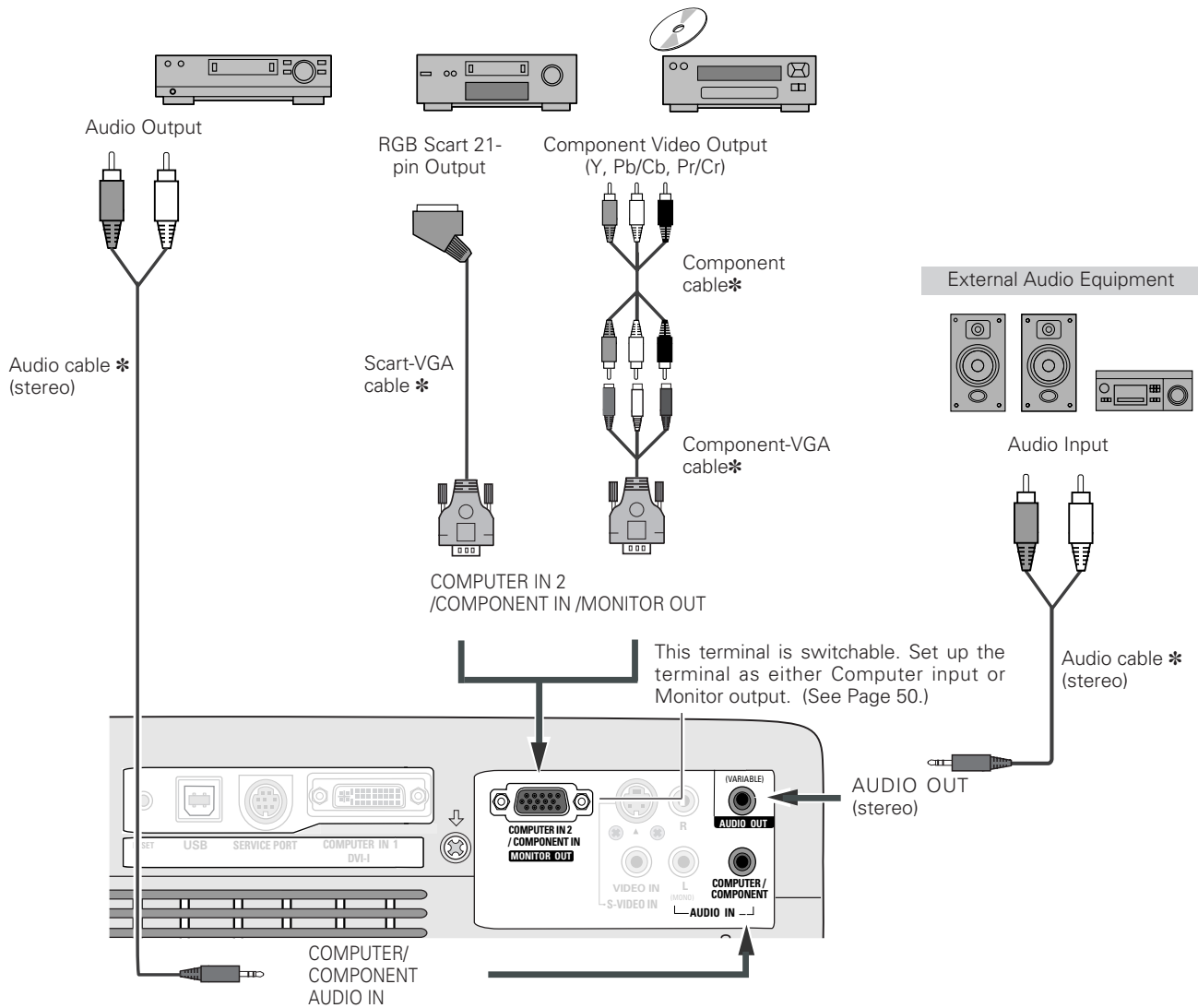

✓ Note:

- When connecting AUDIO OUT to external audio equipment, the projector's built-in speaker is disconnected.
- See p67 for ordering optional parts.



When connecting the cable, the power cords of both the projector and the external equipment should be disconnected from AC outlet.

Turning On the Projector

- 1 Complete peripheral connections (with a computer, VCR, etc.) before turning on the projector.
- 2 Connect the projector's AC power cord into an AC outlet. The POWER indicator will be red.
- 3 Press the POWER ON-OFF button on the top control or on the remote control. The POWER indicator will become green and the cooling fans will start to operate. The preparation display will appear on the screen and the count down will start.
- 4 After the countdown, the input source that was selected last and the Lamp mode status icon (see page 51) will appear on the screen.

If the projector is locked with a PIN code, PIN code Input Dialog Box will appear. Enter the PIN code as instructed below.

Enter a PIN code

Select a number by pressing the Point ◀▶ buttons and fix the number with the SELECT button. The number will change to "*". If you fixed an incorrect number, move the pointer to "Set" or "Clear" once by pressing the Point ▼ button, then return to "PIN code". Enter the correct number again.

Repeat this step to complete entering a four-digit number. "1234" is set as the initial PIN code at the factory.

When the four-digit number is fixed, the pointer will automatically move to "Set". Press the SELECT button so that you can start to operate the projector.

If you entered an incorrect PIN code, "PIN code" and the number (****) will turn red and disappear. Enter the correct PIN code all over again.

What is PIN code?

PIN code is a security code using Personal Identification Number that allows the person who knows it to operate the projector. Setting PIN code prevents others except the specific users from operating the projector.

A PIN code consists of a four-digit number. Refer to PIN code lock function in Setting on page 52, 53 for locking operation of the projector with your PIN code.



CAUTION ON HANDLING PIN CODE

If you forget your PIN code, the projector can no longer be started. Set a new PIN code with special care, write it down in column on page 70 of this manual, and keep it at hand. Should the PIN code be missing or forgotten, consult your dealer or service center.



The preparation display will disappear after 30 seconds.

Selected Input Source and Lamp Mode

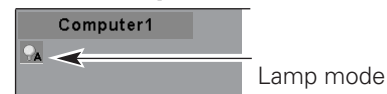

(See page 51 for Lamp mode.)

PIN Code Input Dialog Box



After the OK icon disappears, you can operate the projector.

✓ Note:

- When the Logo select function is off, the logo will not be shown on the screen. (p48)
- When the "Countdown off" or "Off" is selected in the Display function, the countdown will not be shown on the screen. (p47)
- During the countdown period, all operations are invalid.
- If the correct PIN code number is not input for 3 minutes after the PIN code dialog box appeared, the projector will be turned off automatically.

Turning Off the Projector

- 1** Press the POWER ON-OFF button on the top control or on the remote control, and a message "Power off?" will appear on the screen.
- 2** Press the POWER ON-OFF button again to turn off the projector. The POWER indicator will start to blink red, and the cooling fans will keep operating. (You can select the level of fan quietness and rotation speed. See page 54.) At this time you can disconnect the AC power cord even if the fans are still running.
- 3** When the projector has cooled down enough to be turned on again, the POWER indicator will be red.

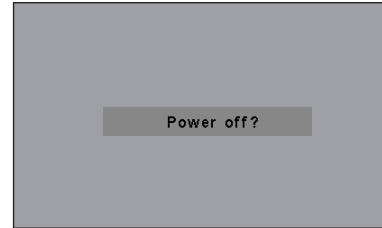

The message will disappear after 4 seconds.



TO MAINTAIN THE LIFE OF THE LAMP, ONCE YOU TURN THE PROJECTOR ON, WAIT AT LEAST 5 MINUTES BEFORE TURNING IT OFF.

✓Note:

- When the On start function is on, this projector will be turned on automatically by connecting the AC power cord to an AC outlet. (p51)
- Do not operate the projector continuously without rest. Continuous use may result in shortening the lamp life. Turn off the projector and give it a rest about an hour in every 24 hours.
- The running speed of cooling fans is changed according to the temperature inside the projector.
- Do not put the projector in a case before the projector is cooled enough.
- If the WARNING indicator blinks or emits a red light, see "Warning Indicator" on page 55.
- While the POWER indicator is blinking, lamp is being cooled down and the projector cannot be turned on. Wait until the POWER indicator becomes red to be turned on again.
- For assisting the cooling fans' operation, the projector is equipped with a large capacitor. While the projector is operating, the capacitor charges electricity. When disconnecting the AC plug from AC outlet, cooling fans start to run about 1 minutes until the capacitor is discharged.

How to Operate the On-Screen Menu

The projector can be adjusted or set via the On-Screen Menu. Refer to the following pages regarding each adjustment and setting procedures.

- 1 Press the MENU button to display the On-Screen Menu.
- 2 Press the Point ◀▶ buttons to select a Menu icon to adjust and press the Point ▲▼ buttons to select an item to adjust.
- 3 Press the SELECT button to show the item data. To adjust the data, press the Point ◀▶ buttons. Refer to the following pages for each adjustment.

To close the On-Screen Menu, press the MENU button again .

✓Note:

The selected item is not active until the SELECT button is pressed.

Top Control

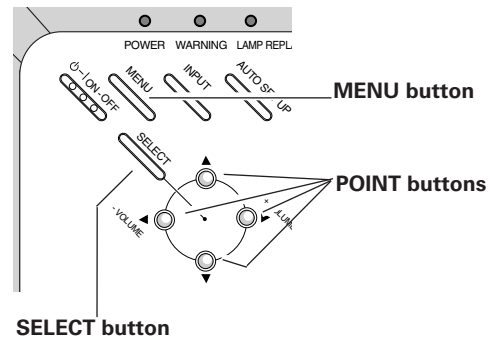

Remote Control

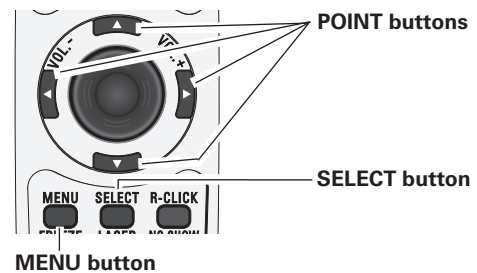

On-Screen Menu

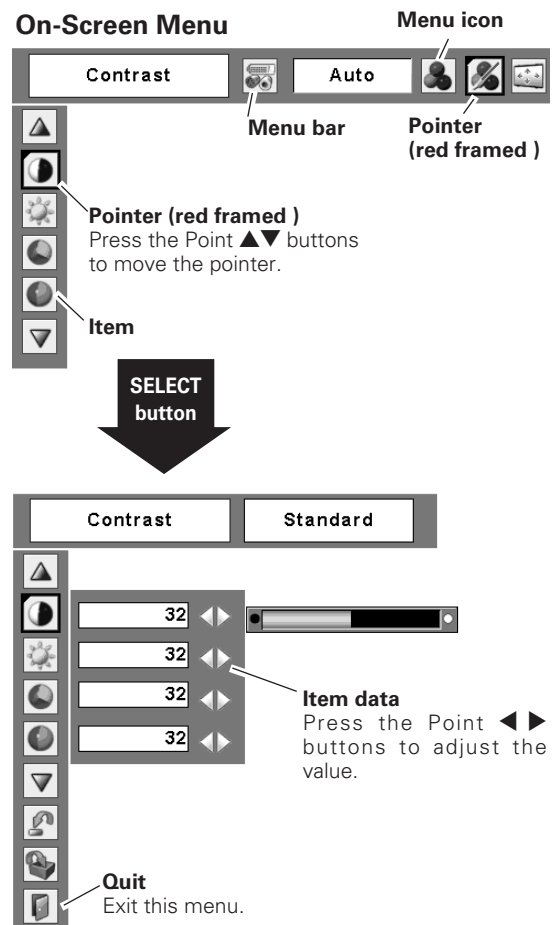

Menu Bar

For detailed functions, see Menu Tree on p62, 63.

For computer source

Guide Window

Show the selected Menu of the On-Screen Menu.

PC System Menu

Used to select computer system. (p31)

Image Select Menu

Used to select an image level among Dynamic, Standard, Real, Blackboard(Green), and Image 1 ~ 4. (p35)

Screen Menu

Used to adjust size of image. [Normal / True / Wide / Full screen / Digital zoom +/-] (p37, 38)

Setting Menu

Used to set the projector's operating configurations. (p46-54)

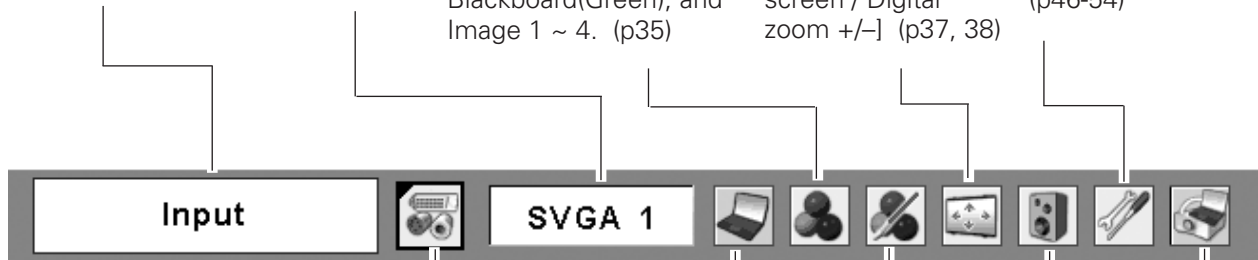

Input Menu

Used to select input source either Computer or Video. (p29, 30)

PC Adjust Menu

Used to adjust parameters to match with input signal format. (p32-34)

Image Adjust Menu

Used to adjust computer image. [Contrast / Brightness / Color temp. / White balance (R/G/B) / Sharpness / Gamma] (p36, 37)

Sound Menu

Used to adjust the volume or mute the sound. (p26)

Wired Menu

Used to set the Wired LAN operating configurations. Refer to the owner's manual "Network Set-up and Operation" supplied with this projector.

For video source

Input Menu

Used to select input source either Video or Computer. (p39, 40)

Image Select Menu

Used to select an image level among Dynamic, Standard, Cinema, Blackboard(Green) and Image 1 ~ 4. (p42)

Screen Menu

Used to set size of image to Normal or Wide. (p45)

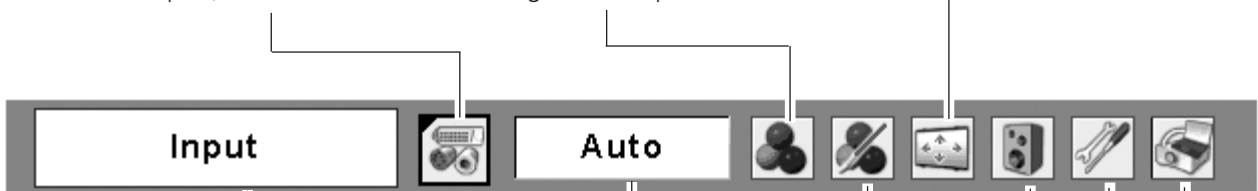

Same function as menu for computer source.

AV System Menu

Used to select system of selected video source. (p41)

Image Adjust Menu

Used to adjust picture image. [Contrast / Brightness / Color / Tint / Color temp. / White balance (R/G/B) / Sharpness / Gamma / Noise reduction / Progressive] (p43, 44)

Same function as computer menu.

Zoom and Focus Adjustment

Rotate the Zoom Lever to zoom in and out.
 Rotate the Focus Ring to adjust the projected picture focus.

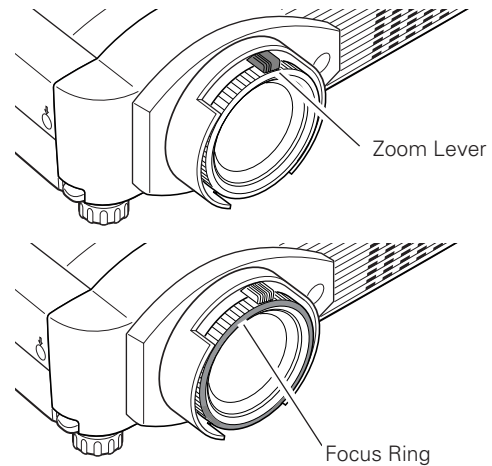

Auto Setup Function

Auto setup function is provided to automatically correct Keystone distortion according to the projector's tilt and adjust the computer display parameters (Fine sync, Total dots and Picture position) by just pressing the AUTO SETUP button on the top control or the AUTO SET button on the remote control. The operational setup for the Auto setup can be changed in the Setting menu. Refer to p46 on setting of the Auto setup function.

✓Note:

- Auto Keystone corrects vertical distortion only, not correct horizontal distortion.
- Auto Keystone cannot work when Ceiling feature is On in the Setting menu. (p50)
- Perfect correction of the image distortion cannot be ensured with the Auto setup function. If the distortion cannot be corrected properly by pressing the AUTO SETUP/ AUTO SET button, adjust manually by pressing the KEYSTONE button on the remote control or selecting Keystone in the Setting menu. (p25, 47)

Keystone Correction

If a projected picture still has keystone distortion after pressing the AUTO SETUP button on the top control or the AUTO SET button on the remote control, correct the image manually as follows:

Press the KEYSTONE button on the remote control. The keystone dialog box will appear. Correct keystone distortion by pressing the Point ▲▼ buttons. Keystone adjustment can be memorized. (p47)

Reduce the upper width with Point ▲ button.

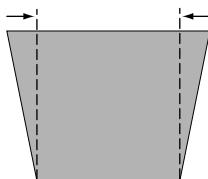

Reduce the lower width with Point ▼ button.

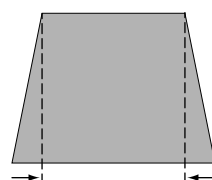

Top Control

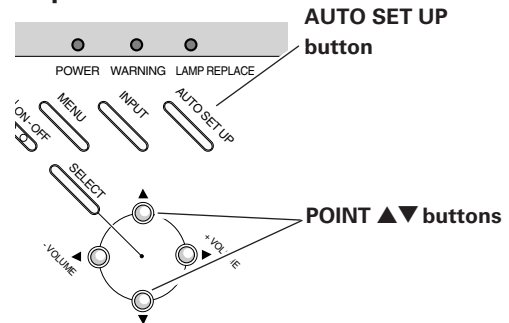

Remote Control

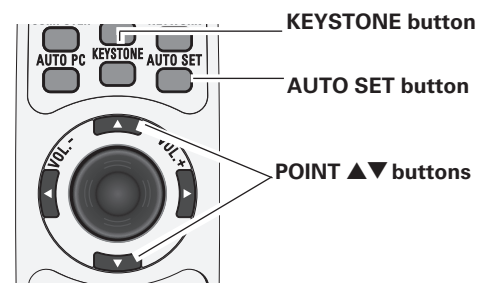

- The arrows are white when there is no correction.
- The direction of the arrow being corrected turns red.
- The arrows disappear at the maximum correction.
- If you press the KEYSTONE button on the remote control once more while the keystone dialog box is being displayed, the keystone adjustment will be canceled.

Sound Adjustment

Direct Operation

Volume

Press the VOLUME+/- buttons on the top control or on the remote control to adjust the volume. The volume dialog box will appear on the screen for a few seconds.

Mute

Press the MUTE button on the remote control to cut off the sound. To restore the sound to its previous level, press the MUTE button again or press the VOLUME+/- buttons. Mute function is also effective for AUDIO OUT jack.

Menu Operation

- 1 Press the MENU button to display the On-Screen Menu. Press the Point ◀▶ buttons to move the red framed pointer to the Sound Menu icon.
- 2 Press the Point ▲▼ buttons to move the red framed pointer to the item that you want to select, and then press the SELECT button.

Volume

Press the Point ▶ button to turn up the volume, and press the Point ◀ button to turn down the volume.

Mute

Press the Point ◀▶ buttons to cut off the sound. Dialog box display will be changed to "On" and the sound will be cut off. To restore the sound to its previous level, press the Point ◀▶ buttons again.

Top Control

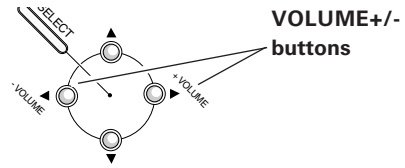

Remote Control

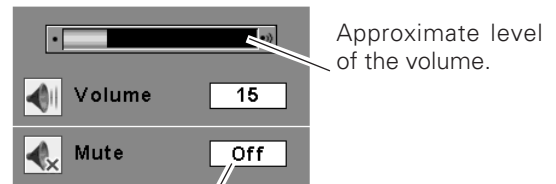
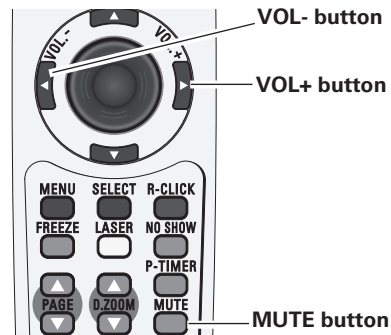

Press the MUTE button to set the Mute function On or Off. The display will disappear after 4 seconds.

Sound Menu

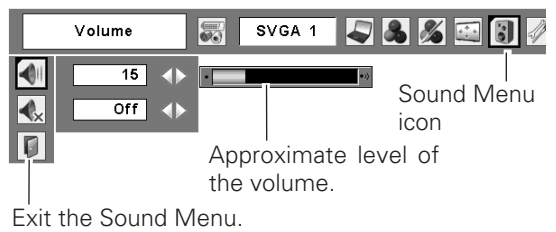

Remote Control Operation

For some frequently used operations, using the remote control is advisable. Just pressing one of the buttons enables you to make the operation, and no need for calling up the On-Screen Menu.

COMPUTER / VIDEO / NETWORK button

Press the COMPUTER, VIDEO, or NETWORK button on the remote control to select the input source.

For more detail, see p29, 30, 39, 40. For Network input, refer to the owner's manual "Network Set-up and Operation" supplied with this projector or the owner's manual of Memory viewer (optionally available).

FREEZE button

Press the FREEZE button on the remote control to freeze the picture on the screen. To cancel the Freeze function, press the FREEZE button again or press any other button.

AUTO PC button

Press the AUTO PC button on the remote control to operate the Auto PC function.

For more detail, see p32.

D.ZOOM buttons

Press the D.ZOOM buttons on the remote control to zoom in and zoom out the images.

For more detail, see p38.

LAMP CONTROL button

Press the LAMP CONTROL button on the remote control to select the lamp mode for changing the brightness of the screen.

- ⦿ Normalnormal brightness
- ⦿**A** Autobrightness according with the input signal
- ⦿ Ecolower brightness reduces the lamp power consumption and extends the lamp life.

KEYSTONE button

For detail, see p25.

AUTO SET button

For detail, see p25.

Remote Control

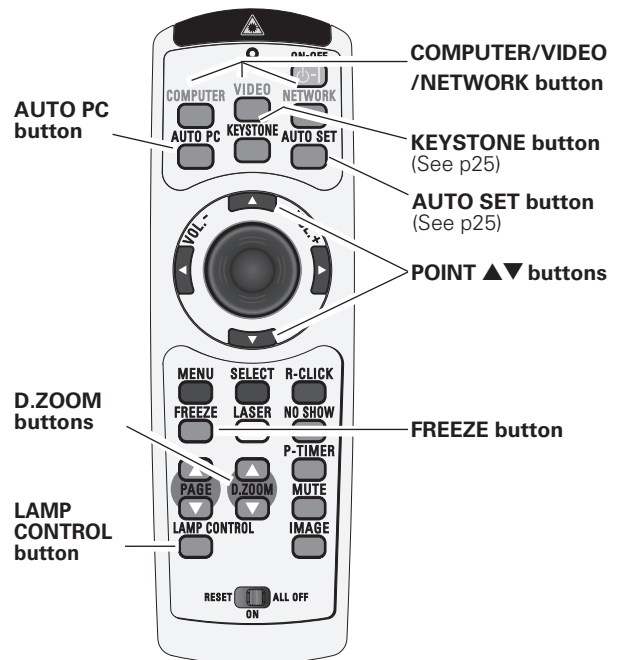

✓ **Note:**

See the next page for the other buttons.

NO SHOW button

Press the NO SHOW button on the remote control to black out the image. To restore to normal, press the NO SHOW button again or press any other button. When a projected image is captured and set as "User" in the Logo selection (p48), the screen changes each time you press the NO SHOW button as follows.

black out → the captured image → normal →

P-TIMER button

Press the P-TIMER button on the remote control. The timer display "00 : 00" will appear on the screen and the timer will start to count time (00 : 00 ~ 59 : 59).

To stop the P-Timer, press the P-TIMER button. Press the P-TIMER button again, then the P-timer display will disappear.

IMAGE button

Press the IMAGE button on the remote control to select a desired image level of the screen. For more detail, see p35, 42.

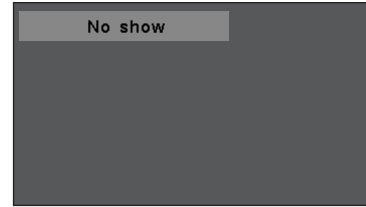

The message will disappear after 4 seconds.



P-Timer display

Remote Control

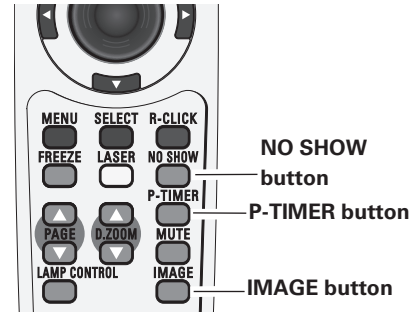

✓ **Note:**

See the previous page for the other buttons.

Computer Input

Input Source Selection (RGB : Computer 1(Analog) / Computer 2)

Direct Operation

Choose either Computer 1(Analog) or Computer 2 by pressing the INPUT button on the top control or press the COMPUTER button on the remote control.

Before using these buttons, correct input source should be selected through Menu operation as described below.

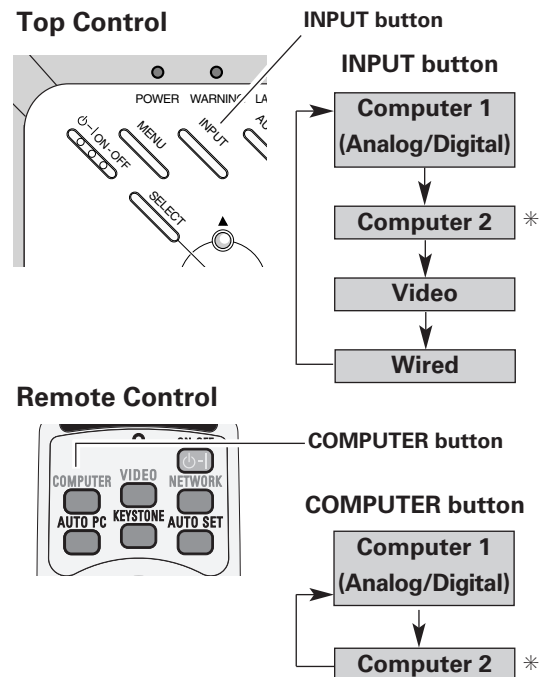

* See Note at the bottom of this page.

Menu Operation

- 1 Press the MENU button to display the On-Screen Menu. Press the Point ◀▶ buttons to move the red framed pointer to the Input Menu icon.
- 2 Press the Point ▲▼ buttons to move the red arrow pointer to either Computer 1(Analog) or Computer 2, and then press the SELECT button.
- 3 When selecting Computer 1(Analog), RGB input source will be selected directly. When selecting Computer 2, the Source Select Menu will appear. Move the pointer to RGB and then press the SELECT button.

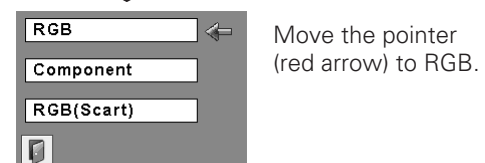
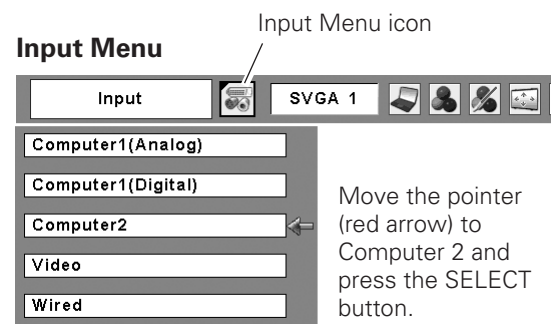
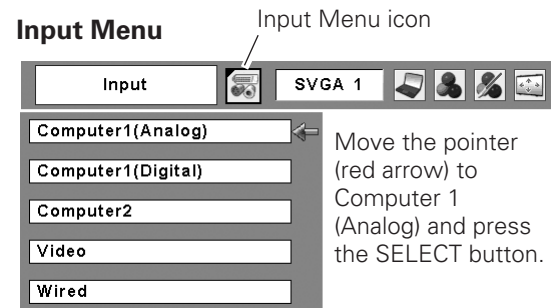

✓Note:

- Computer 2 is not displayed when the COMPUTER IN 2 / COMPONENT IN / MONITOR OUT terminal is set as Monitor out. (p50)
- Computer 2 (COMPUTER IN 2 / COMPONENT IN / MONITOR OUT) can accept only RGB signal.
- Wired, Wireless, and Memory Viewer are for the Network function. Refer to the owner's manual "Network Set-up and Operation" supplied with this projector or the owner's manual of Memory viewer (optionally available).

Input Source Selection (RGB(PC digital), RGB(AV HDCP))

Direct Operation

Choose Computer 1(Digital) by pressing the INPUT button on the top control or press the COMPUTER button on the remote control.

Before using these buttons, correct input source should be selected through Menu operation as described below.

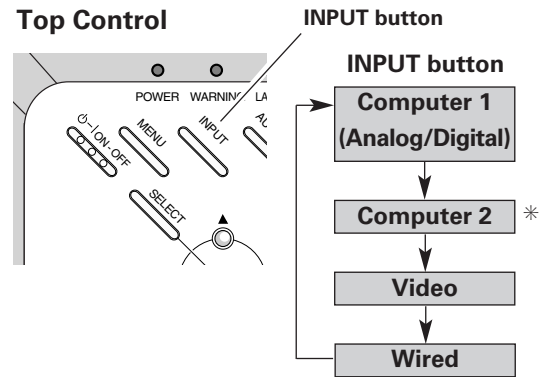

Remote Control

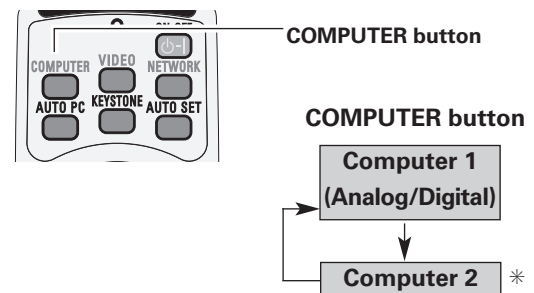

* See Note at the bottom of this page.

Menu Operation

- 1 Press the MENU button to display the On-Screen Menu. Press the Point ◀▶ buttons to move the red framed pointer to the Input Menu icon.
- 2 Press the Point ▲▼ buttons to move the red arrow pointer to Computer 1(Digital), and then press the SELECT button.
- 3 After the Source Select Menu appeared for Computer 1(Digital), move the pointer to RGB (PC digital) or RGB (AV HDCP) and then press the SELECT button.

✓Note:

- Computer 2 is not displayed when the COMPUTER IN 2 / COMPONENT IN / MONITOR OUT terminal is set as Monitor out. (p50)
- Computer 2 (COMPUTER IN 2 / COMPONENT IN / MONITOR OUT) can accept only RGB signal.
- HDCP (High-bandwidth Digital Content Protection) is a system for protecting digital entertainment content delivered by DVI (Digital Visual Interface) from being copied. The specification of HDCP is decided and controlled by Digital Content protection, LLC. Should the specification be changed, this Projector may not display the digital content protected by HDCP.
- Wired, Wireless, and Memory Viewer are for the Network function. Refer to the owner's manual "Network Set-up and Operation" supplied with this projector or the owner's manual of Memory viewer (optionally available).

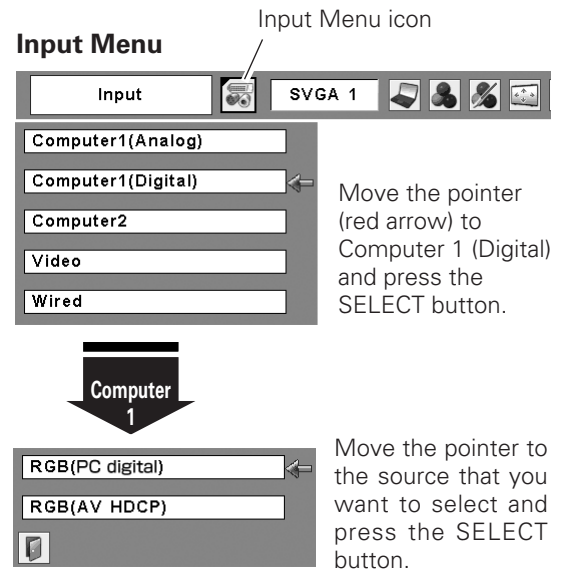

Computer System Selection

This projector automatically tunes to various types of computers based on VGA, SVGA, XGA, SXGA, WXGA or UXGA with its Multi-scan system and Auto PC Adjustment. If Computer is selected as a signal source, this projector automatically detects the signal format and tunes to project a proper image without any additional setting. (Signal formats provided in this projector is shown on page 65)

One of the following messages may appear when:

- Auto**

The projector cannot recognize the connected signal conforming to the provided PC Systems. The message "Auto" will be displayed on the PC System Menu icon and the Auto PC Adjustment function will work to display proper images. If the image is not projected properly, a manual adjustment is required. (p33, 34)
- There is no signal input from computer. Check the connection between your computer and the projector. (See "Troubleshooting" p60)
- Mode 1**

The preset system is manually adjusted in the PC Adjust Menu. The adjusted data can be stored in Mode 1~5. (p33, 34)
- SVGA 1**

PC Systems provided in this projector is chosen. The projector chooses a proper system provided in the projector and displays it.

*Mode 1 and SVGA 1 are examples.

PC System Menu

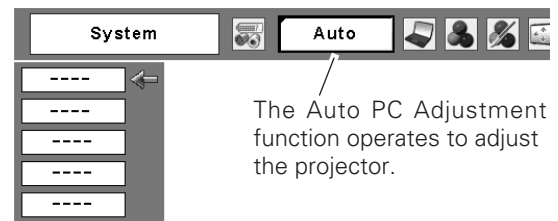

PC System Menu

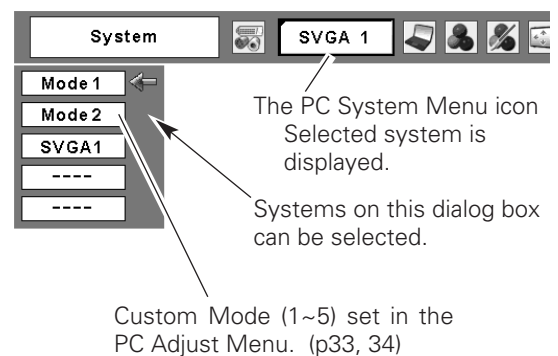

Selecting Computer System Manually

PC system can also be selected manually.

- 1 Press the MENU button to display the On-Screen Menu. Press the Point ◀▶ buttons to move the red framed pointer to the PC System Menu icon.
- 2 Press the Point ▲▼ buttons to move the red arrow pointer to the system that you want to set, and then press the SELECT button.

Auto PC Adjustment

Auto PC Adjustment function is provided to automatically adjust Fine sync, Total dots, Horizontal, and Vertical to conform to your computer. Auto PC Adjustment function can be operated as follows.

Direct Operation

The Auto PC adjustment function can be operated directly by pressing the AUTO PC button on the remote control.

Remote Control

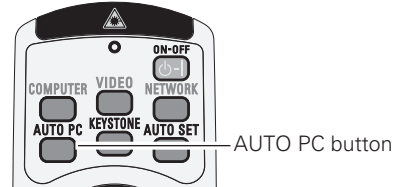

Menu Operation

Auto PC Adj.

- 1 Press the MENU button to display the On-Screen Menu. Press the Point ◀▶ buttons to move the red framed pointer to PC Adjust Menu item.
- 2 Press the Point ▲▼ buttons to move the red framed pointer to Auto PC Adj. item and then press the SELECT button twice.

To store adjustment parameters

Adjustment parameters from Auto PC Adjustment can be memorized in this projector. Once parameters are memorized, the setting can be done just by selecting Mode in the PC System Menu (p31). See "Store" on page 34.

✓ Note:

- Fine sync, Total dots, Horizontal, and Vertical of some computers cannot be fully adjusted with this Auto PC Adjustment function. When the image is not provided properly with this operation, manual adjustments are required. (p33, 34)
- The Auto PC Adjustment cannot be operated when 480i, 575i, 480p, 575p, 720p, 1035i, or 1080i is selected in the PC System Menu (p31), or when the signal is coming from DVI-terminal.

PC Adjust Menu

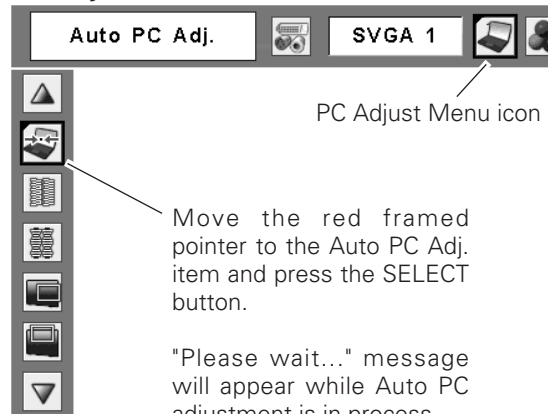

Manual PC Adjustment

Some computers employ special signal formats which may not be tuned by Multi-scan system of this projector. Manual PC Adjustment enables you to precisely adjust several parameters to match those signal formats. The projector has 5 independent memory areas to memorize those parameters manually adjusted. It allows you to recall the setting for a specific computer.

- 1 Press the MENU button to display the On-Screen Menu. Press the Point ◀▶ buttons to move the red framed pointer to the PC Adjust Menu icon.
- 2 Press the Point ▲▼ buttons to move the red framed pointer to the item that you want to adjust and then press the SELECT button to display the adjustment dialog box. Press the Point ◀▶ buttons to adjust the value.

Fine sync

Eliminate flicker from the image displayed. Press the Point ◀▶ buttons to adjust the value. (From 0 to 31)

Total dots

Adjust the number of total dots in one horizontal period. Press the Point ◀▶ buttons to adjust number to match your PC image.

Horizontal

Press the Point ◀▶ buttons to adjust the horizontal picture position.

Vertical

Press the Point ◀▶ buttons to adjust the vertical picture position.

Current mode

Press the SELECT button to show H-sync freq. and V-sync freq. of the connected computer.

Clamp

Adjust clamp level. When the image has dark bars, try this adjustment.

PC Adjust Menu PC Adjust Menu icon

Auto PC Adj. SVGA 1

Move the red framed pointer to an item and press the SELECT button.

Status (Stored / Free) of the selected Mode.

Selected Mode

Auto PC Adj. Mode1 Stored

Press the Point ◀▶ buttons to adjust the value.

15 ◀▶

1346 ◀▶

301 ◀▶

39 ◀▶

Press the SELECT button at this item to adjust other items.

Current mode Mode1 Stored

H-sync freq. 48.5

V-sync freq. 60.0

Press the SELECT button at the Current mode item to show the information of the connected computer.

Display area H

Adjust the horizontal area displayed by this projector. Press the Point ◀▶ buttons to decrease/increase the value.

Display area V

Adjust the vertical area displayed by this projector. Press the Point ◀▶ buttons to decrease/increase the value.

Reset

To reset the adjusted data, select Reset and press the SELECT button. The confirmation box will appear and then select [Yes]. All adjustments will return to their previous figures.

Mode free

To clear the stored data, move the red framed pointer to the Mode free item and then press the SELECT button. Move the red arrow pointer to the Mode that you want to clear and then press the SELECT button.

Store

To store adjusted data, move the red framed pointer to the Store item and then press the SELECT button. Move the red arrow pointer to any of Mode 1 to 5 in which you want to store and then press the SELECT button.

Quit

Exit the PC Adjust Menu.

✓Note:

- Display area (H/V) cannot be selected when 480i, 575i, 480p, 575p, 720p, 1035i, or 1080i is selected in the PC System Menu (p31).
- PC Adjust Menu cannot be selected when Computer I(Digital) is selected in the Input Menu. (p30)

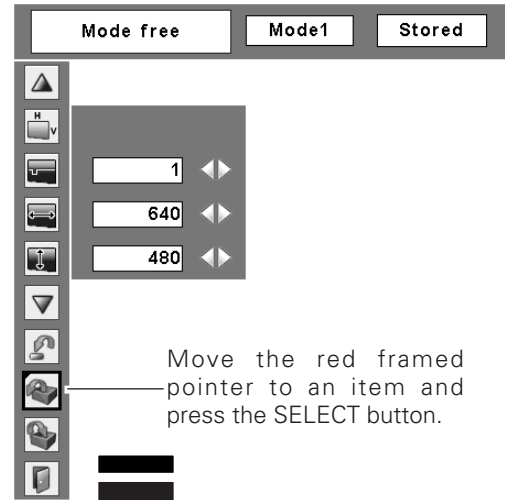

Move the red framed pointer to an item and press the SELECT button.

To clear adjusted data

This Mode has stored parameters.

Where to free?

Mode	Status	800	142	34	1024	768
Mode1	Stored	800	142	34	1024	768
Mode2	Free	800	142	34	1024	768
Mode3	Free	800	142	34	1024	768
Mode4	Free	800	142	34	1024	768
Mode5	Free	800	142	34	1024	768

Vacant Mode

Values of "Total dots," "Horizontal," "Vertical," "Display area H," and "Display area V."

To store adjusted data

Where to store?

Mode	Status	800	142	34	1024	768
Mode1	Stored	800	142	34	1024	768
Mode2	Free	800	142	34	1024	768
Mode3	Free	800	142	34	1024	768
Mode4	Free	800	142	34	1024	768
Mode5	Free	800	142	34	1024	768

Close this dialog box.

Image Level Selection

Direct Operation

Select an image level among Dynamic, Standard, Real, Blackboard(Green), Image 1, Image 2, Image 3, and Image 4 by pressing the IMAGE button on the remote control.

Dynamic

Picture level suitable for viewing picture in a bright room.

Standard

Normal picture level preset on this projector.

Real

Picture level with improved halftone for graphics.

Blackboard(Green)

Picture level suitable for the image projected on a blackboard.
This mode assists to enhance the image projected on a blackboard. This is mainly effective on a green colored board, not truly effective on a black colored board.

Image 1~4

User preset image in the Image Adjust Menu (p37).

Remote Control

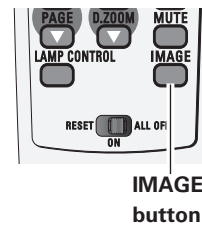
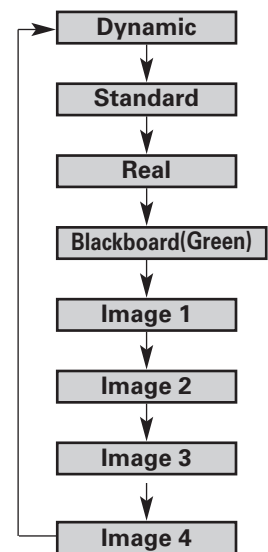

IMAGE button



Menu Operation

- 1 Press the MENU button to display the On-Screen Menu. Press the Point ◀▶ buttons to move the red framed pointer to the Image Select Menu icon.
- 2 Press the Point ▲▼ buttons to move the red framed pointer to the level that you want to set and then press the SELECT button.

Dynamic

Picture level suitable for viewing picture in a bright room.

Standard

Normal picture level preset on this projector.

Real

Picture level with improved halftone for graphics.

Blackboard(Green)

Picture level suitable for the image projected on a blackboard. See above for further description.

Image 1~4

User preset image in the Image Adjust Menu (p37).

Image Select Menu

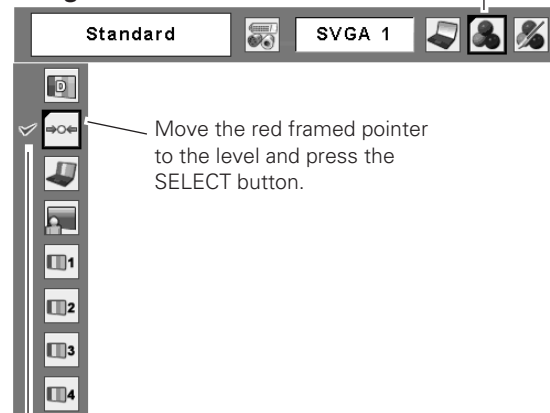

Move the red framed pointer to the level and press the SELECT button.

The level being selected.

Image Level Adjustment

- 1 Press the MENU button to display the On-Screen Menu. Press the Point ◀▶ buttons to move the red framed pointer to the Image Adjust Menu icon.
- 2 Press the Point ▲▼ buttons to move the red framed pointer to the item that you want to adjust, and then press the SELECT button. The level of each item is displayed. Adjust each level by pressing the Point ◀▶ buttons.

Contrast

Press the Point ◀ button to decrease the contrast and the Point ▶ button to increase contrast. (From 0 to 63.)

Brightness

Press the Point ◀ button to adjust the image darker and the Point ▶ button to adjust the image brighter. (From 0 to 63.)

Color temp.

Press the Point ◀ button or the Point ▶ button for Color temp. level that you want to select. (XLow, Low, Mid, or High)

White balance (Red)

Press the Point ◀ button to lighten the red tone and the Point ▶ button to deepen the red tone. (From 0 to 63.)

White balance (Green)

Press the Point ◀ button to lighten the green tone and the Point ▶ button to deepen the green tone. (From 0 to 63.)

White balance (Blue)

Press the Point ◀ button to lighten the blue tone and the Point ▶ button to deepen the blue tone. (From 0 to 63.)

Sharpness

Press the Point ◀ button to soften the image and the Point ▶ button to sharpen the image. (From 0 to 15.)

Gamma

Press the Point ◀▶ buttons to obtain better balance of contrast. (From 0 to 15.)

Reset

To reset the adjusted data, select Reset and press the SELECT button. The confirmation box will appear and then select [Yes]. All adjustments will return to their previous figures.

Image Adjust Menu

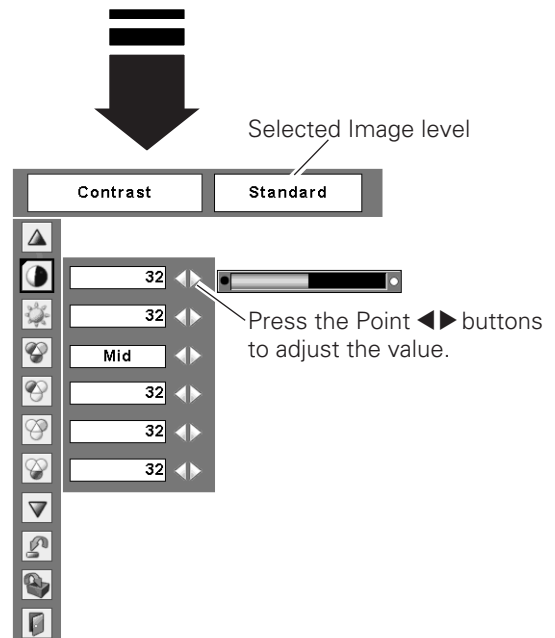
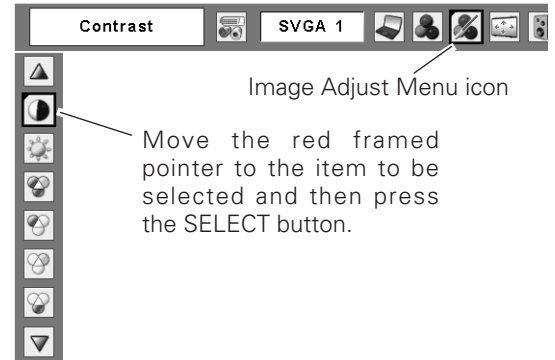

✓ Note:

After adjusting any of the White balance Red, Green or Blue, the Color temp will change to "Adj."

 **Store**

To store the adjusted data, select Store and press the SELECT button. Select a level from Image 1 to 4 with the Point ▲▼ buttons and press the SELECT button. A confirmation box will appear and then select [Yes]. Stored data can be called up by selecting "Image" in the Image Level Selection on page 35.

 **Quit**

Exit the Image Adjust Menu.

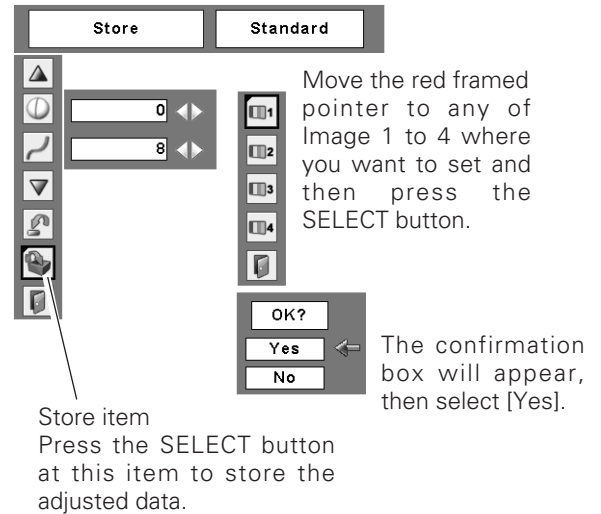

Screen Size Adjustment

This projector has the picture screen resize function, which enables you to customize the image size.

- 1 Press the MENU button to display the On-Screen Menu. Press the Point ◀▶ buttons to move the red framed pointer to the Screen Menu icon.
- 2 Press the Point ▲▼ buttons and move the red framed pointer to the function that you want to select and then press the SELECT button.

 **Normal**

Provide the image to fit the screen size.

 **True**

Provide the image in its original size. When the original image size is larger than the screen size (1024 x 768), this projector enters panning mode automatically. Pan the image with Point ▲▼◀▶ buttons. When adjusted, the arrows will turn red. When reached to the correction limit, the arrows will disappear.

 **Wide**

Provide the image to fit wide video aspect ratio (16 : 9) by expanding the image width uniformly. This function can be used for providing a squeezed video signal at 16 : 9.

 **Full screen**

Provide the full screen image.

Screen Menu

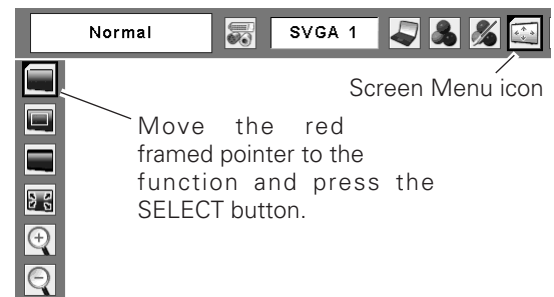

✓ **Note:**

- This Screen Menu cannot be operated when 720p(HDTV), 1035i (HDTV), or 1080i (HDTV) is selected in the PC System Menu (p31).
- This projector cannot display any resolution higher than 1600 X 1200. If your computer's screen resolution is higher than it, reset the resolution to the lower before connecting to the projector.
- The image data in other than 1024 x 768 is modified to fit the screen size in initial mode.
- True, Full screen, and Digital zoom +/- cannot be selected when 480i, 575i, 480p, or 575p is selected in the PC System Menu (p31).

For zooming in and out the images

Digital zoom +

When the Digital zoom + is selected, the On-Screen Menu will disappear and the message "D. zoom +" will be displayed. Press the SELECT button to expand the image size. And press the Point ▲▼◀▶ buttons to pan the image. The Panning function can work only when the image is larger than the screen size.

A projected image can be also expanded by pressing the D.ZOOM ▲ button on the remote control.

Digital zoom -

When Digital zoom - is selected, the On-Screen Menu will disappear and the message "D. zoom -" will be displayed. Press the SELECT button to compress image size.

A projected image can be also compressed by pressing the D.ZOOM ▼ button on the remote control.

To exit the Digital zoom +/- mode, press any button except the D.ZOOM ▲▼ buttons, SELECT, and Point button.

To return to the previous screen size, select a screen size from the Screen Size Adjustment or select an input source from the Input Source Selection (p29, 30) again, or adjust the screen size with the D.ZOOM ▲▼ buttons.

Remote Control

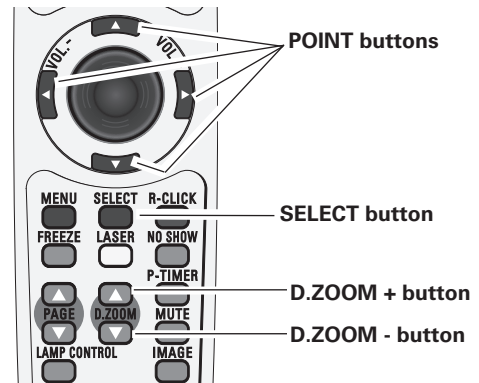

✓ Note:

- The panning function may not operate properly if the stored Mode in the PC Adjust Menu is used. (p34)
- The minimum compression ratio can be limited depending on the input signal or when the Keystone function is working.
- True, Full screen, and Digital zoom +/- cannot be selected when 480i, 575i, 480p, or 575p is selected in the PC System Menu (p31).
- Digital zoom +/- cannot be selected when Full screen or True is selected.

Input Source Selection (Video, S-video)

Direct Operation

Choose Video by pressing the INPUT button on the top control or the VIDEO button on the remote control. Before using these buttons, correct input source should be selected through menu operation as described below.

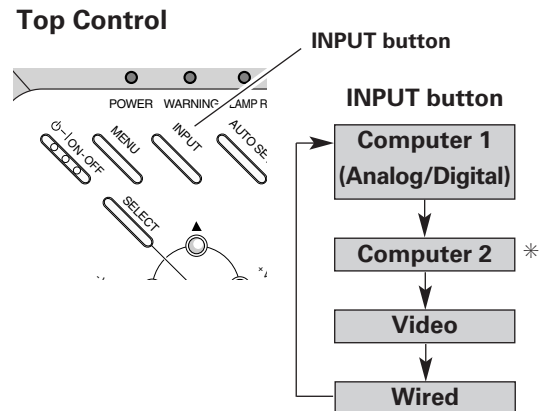

* See Note at the bottom of this page.

Menu Operation

- 1 Press the MENU button to display the On-Screen Menu. Press the Point ◀▶ buttons to move the red framed pointer to the Input Menu icon.
- 2 Press the Point ▲▼ buttons to move the red arrow pointer to Video and then press the SELECT button to display the Source Select Menu .
- 3 Move the pointer to the source that you want to select and then press the SELECT button.

Remote Control

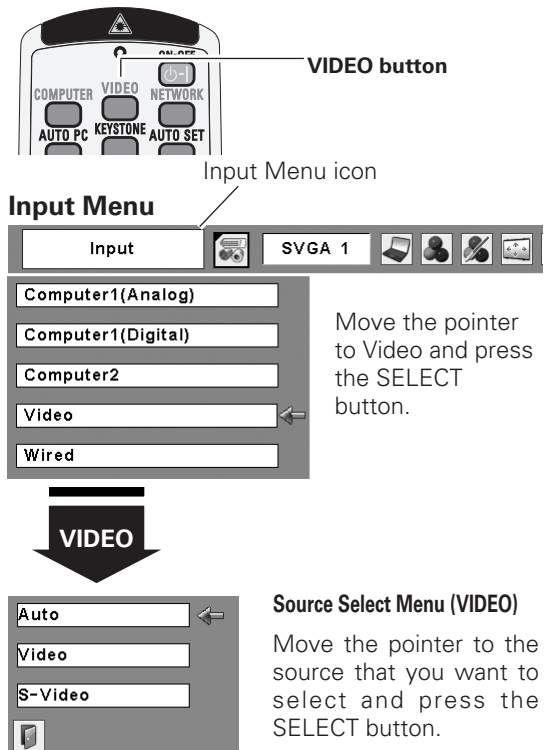

Auto When selecting Auto, the projector automatically detects incoming video signal, and adjusts itself to optimize its performance. The projector selects connection in the following order:

1. S-video
2. Video

Video When video input signal is connected to the VIDEO jack, select Video.

S-video When video input signal is connected to the S-VIDEO jack, select S-video.

✓Note:

- When Monitor out is selected in the Terminal function (p50), Computer 2 is not displayed.
- Wired, Wireless, and Memory Viewer are for the Network function. Refer to the owner's manual "Network Set-up and Operation" supplied with this projector or the owner's manual of Memory viewer (optionally available).

Input Source Selection (Component, RGB Scart 21-pin)

Direct Operation

Choose Computer 2 by pressing the INPUT button on the top control or press the COMPUTER button on the remote control.

Before using these buttons, correct input source should be selected through Menu operation as described below.

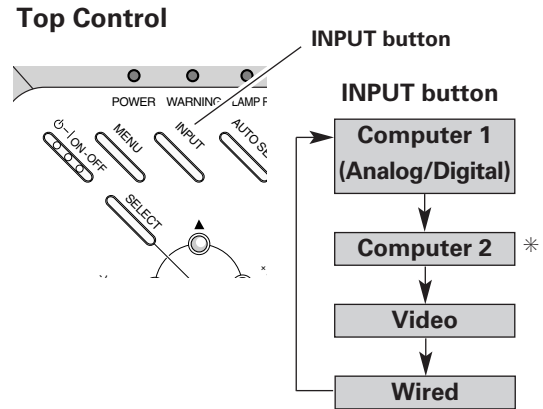

Menu Operation

- 1 Press the MENU button to display the On-Screen Menu. Press the Point ◀▶ buttons to move the red framed pointer to the Input Menu icon.
- 2 Press the Point ▲▼ buttons to move the red arrow pointer to Computer 2 and then press the SELECT button.
- 3 After the Source Select Menu appeared for Computer 2, move the pointer to Component or RGB(Scart) and then press the SELECT button.

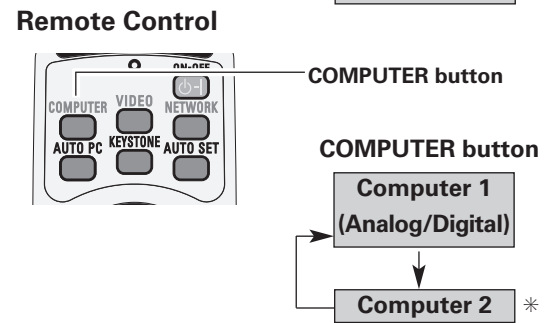

* See Note at the bottom of this page.

Component When the input source is coming from video equipment connected to the COMPUTER IN 2 / COMPONENT IN / MONITOR OUT terminal with a Component-VGA Cable, select Component.

RGB (Scart) When the input source is coming from video equipment connected to the COMPUTER IN 2 / COMPONENT IN / MONITOR OUT terminal with a Scart-VGA Cable, select RGB (Scart).

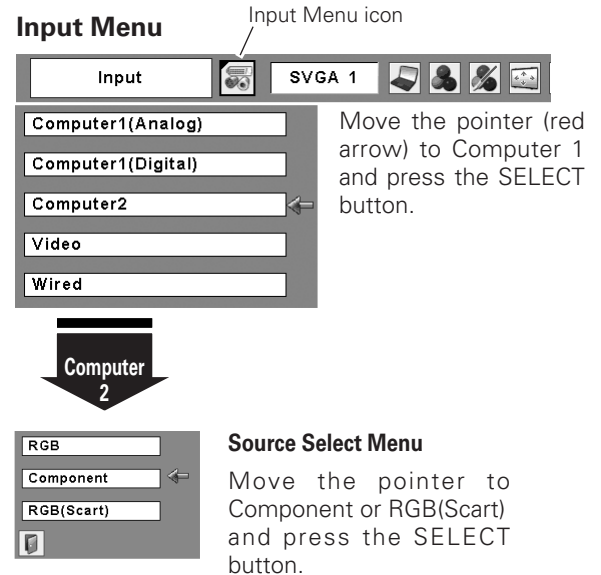

✓ **Note:**

- When Monitor out is selected in the Terminal function (p50), Computer 2 is not displayed.
- Wired, Wireless, and Memory Viewer are for the Network function. Refer to the owner's manual "Network Set-up and Operation" supplied with this projector or the owner's manual of Memory viewer (optionally available).

Video System Selection

- 1 Press the MENU button to display the On-Screen Menu. Press the Point ◀▶ buttons to move the red framed pointer to the AV System Menu icon.
- 2 Press the Point ▲▼ buttons to move the red arrow pointer to the system that you want to select and then press the SELECT button.

Video or S-video

Auto

The projector automatically detects incoming video system, and adjusts itself to optimize its performance. When Video System is PAL-M or PAL-N, select system manually.

PAL / SECAM / NTSC / NTSC4.43 / PAL-M / PAL-N

If the projector cannot reproduce proper video image, it is necessary to select a specific broadcast signal format among PAL, SECAM, NTSC, NTSC 4.43, PAL-M, and PAL-N.

AV System Menu (Video or S-video)

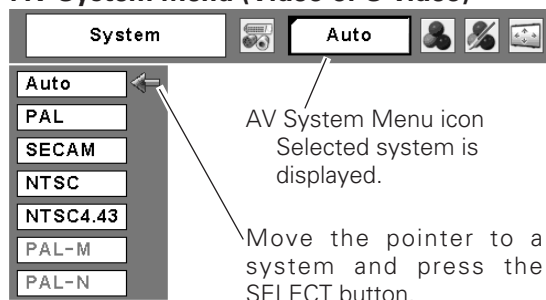

AV System Menu (Component)

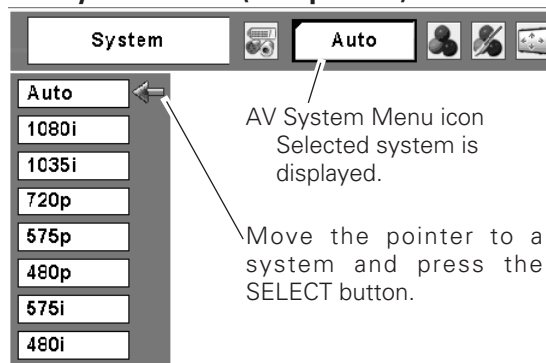

Component

Auto

The projector automatically detects incoming video signal, and adjusts itself to optimize its performance.

COMPONENT VIDEO SIGNAL FORMAT

If the projector cannot reproduce proper video image, it is necessary to select a specific component video signal format among 480i, 575i, 480p, 575p, 720p, 1035i, and 1080i.

✓ Note:

The AV System Menu cannot be selected when selecting RGB(Scart).

Image Level Selection

Direct Operation

Select a desired image level among Dynamic, Standard, Cinema, Blackboard (Green), Image 1, Image 2, Image 3, and Image 4 by pressing the IMAGE button on the remote control.

Dynamic

Picture level suitable for viewing picture in a bright room.

Standard

Normal picture level preset on this projector.

Cinema

Picture level adjusted for the picture with fine tone.

Blackboard(Green)

Picture level suitable for the image projected on a blackboard.

This mode assists to enhance the image projected on a blackboard. This is mainly effective on a green colored board, not truly effective on a black colored board.

Image 1~4

User preset image in the Image Adjust Menu (p43, 44).

Remote Control

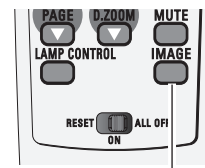
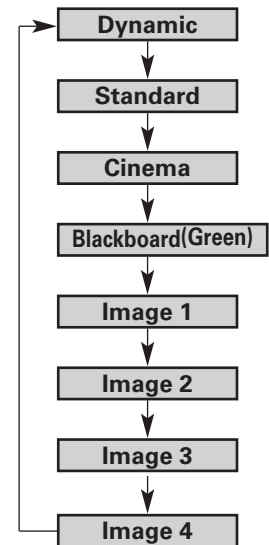

IMAGE button



Menu Operation

- 1 Press the MENU button to display the On-Screen Menu. Press the Point ◀▶ buttons to move the red framed pointer to the Image Select Menu icon.
- 2 Press the Point ▲▼ buttons to move the red framed pointer to the level that you want to set and then press the SELECT button.

Dynamic

Picture level suitable for viewing picture in a bright room.

Standard

Normal picture level preset on this projector.

Cinema

Picture level adjusted for the picture with fine tone.

Blackboard(Green)

Picture level suitable for the image projected on a Blackboard. See above for further description.

Image1~4

User preset image in the Image Adjust Menu (p43, 44).

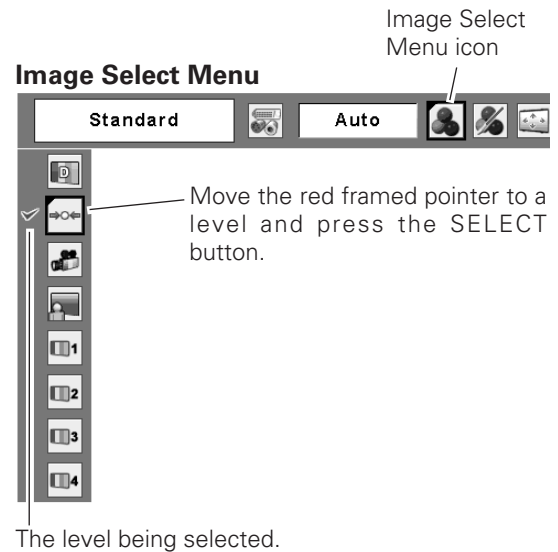

Image Level Adjustment

- 1 Press the MENU button to display the On-Screen Menu. Press the Point ◀▶ buttons to move the red framed pointer to the Image Adjust Menu icon.
- 2 Press the Point ▲▼ buttons to move the red framed pointer to the item that you want to adjust and then press the SELECT button. The level of each item is displayed. Adjust each level by pressing the Point ◀▶ buttons.

Contrast

Press the Point ◀ button to decrease the contrast and the Point ▶ button to increase contrast. (From 0 to 63.)

Brightness

Press the Point ◀ button to adjust the image darker and the Point ▶ button to adjust the image brighter. (From 0 to 63.)

Color

Press the Point ◀ button to lighten the color and the Point ▶ button to deepen the color. (From 0 to 63.)

Tint

Press the Point ◀▶ buttons to obtain a proper color. (From 0 to 63.)

Color temp.

Press the Point ◀▶ buttons for Color temp. level that you want to select. (XLow, Low, Mid, or High)

White balance (Red)

Press the Point ◀ button to lighten the red tone and the Point ▶ button to deepen the red tone. (From 0 to 63.)

White balance (Green)

Press the Point ◀ button to lighten the green tone and the Point ▶ button to deepen the green tone. (From 0 to 63.)

White balance (Blue)

Press the Point ◀ button to lighten the blue tone and the Point ▶ button to deepen the blue tone. (From 0 to 63.)

✓ Note:

- The Tint cannot be selected when the video system is PAL, SECAM, PAL-M, or PAL-N. (p41)
- After adjusting any of the White balance Red, Green or Blue, the Color temp. will change to "Adj."

Image Adjust Menu

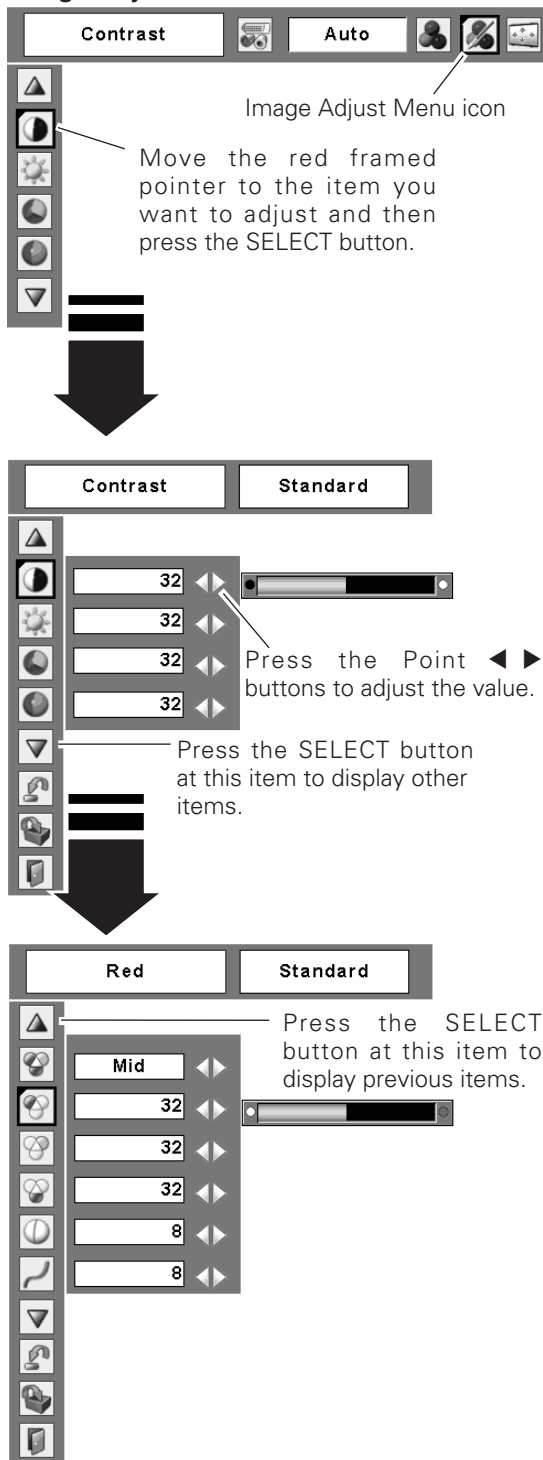

Sharpness

Press the Point ◀ button to soften the image and the Point ▶ button to sharpen the image. (From 0 to 15.)

Gamma

Press the Point ◀▶ buttons to obtain better balance of contrast. (From 0 to 15.)

Noise reduction

Noise interference on the screen can be reduced. Select one of the following to get smoother images.

- Off.....disabled.
- L1.....lower reduction
- L2.....higher reduction

Progressive

Interlaced video signal can be displayed in a progressive picture. Select one of the following.

- Off.....disabled.
- L1.....Select "L1" for an active picture.
- L2.....Select "L2" for a still picture.
- Film.....Select "Film" for watching a film. With this function, the projector reproduces pictures faithful to the original film quality.

Reset

To reset the adjusted data, select Reset and press the SELECT button. The confirmation box will appear and then select [Yes]. All adjustments will return to their previous figures.

Store

To store the adjusted data, select Store and press the SELECT button. Select a level from Image 1 to 4 with the Point ▲▼ buttons and press the SELECT button. A confirmation box will appear and then select [Yes]. Stored data can be called up by selecting "Image" in the Image Level Selection on page 42.

Quit

Exit the Image Adjust Menu.

✓ Note:

Noise reduction and Progressive cannot be selected when 480p, 575p, 720p, 1035i, or 1080i is selected. (p41)

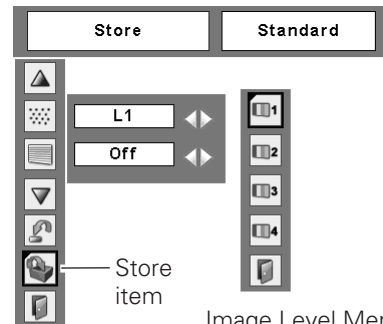
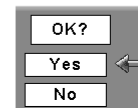

Image Level Menu
Move the red framed pointer to an image item to be set and then press the SELECT button.



The confirmation box will appear and then select [Yes].

Screen Size Adjustment

This projector has the picture screen resize function, which enables you to customize the image size.

- 1 Press the MENU button to display the On-Screen Menu. Press the Point ◀▶ buttons to move the red framed pointer to the Screen Menu icon.
- 2 Press the Point ▲▼ buttons and move the red framed pointer to the function that you want to select and then press the SELECT button.

Screen Menu



Move the red framed pointer to a function and press the SELECT button.

Normal

Provide the image at a normal video aspect ratio of 4 : 3.

Wide

Provide the image at a wide screen ratio of 16 : 9.

✓ **Note:**

Screen Menu cannot be operated when 720p, 1035i, or 1080i is selected in the AV System Menu (p41).

Setting

This projector has Setting menu that allows you to set up the other various functions described as follows;

- 1 Press the MENU button to display the On-Screen Menu. Press the Point ◀▶ buttons to move the red framed pointer to the Setting Menu icon.
- 2 Press the Point ▲▼ buttons to move the red framed pointer to the item that you want to set and then press the SELECT button. The Setting dialog box appears.

Language

The language used in the On-Screen Menu is available in English, German, French, Italian, Spanish, Portuguese, Dutch, Swedish, Finnish, Polish, Hungarian, Romanian, Russian, Chinese, Korean, or Japanese.

Auto setup

This function enables Auto Keystone correction and Auto PC adjustment by pressing the AUTO SETUP button on the top control or the AUTO SET button on the remote control. Settings for those functions can be altered as follows:

Auto PC Adj.

- Onenables Auto PC Adjustment when pressing the AUTO SET button on the remote control or the AUTO SETUP button on the top control.
- Offdisables Auto PC Adjustment.

Auto Keystone

- Auto always works and corrects keystone distortion according to the projector's tilt.
- Manual . . .works only when pressing the AUTO SET button on the remote control or the AUTO SETUP button on the top control.
- Offdisables Auto Keystone.

✓Note:

- Auto PC Adj. and Auto Keystone cannot be set "Off" at the same time.
- Auto Keystone corrects vertical distortion only, not correct horizontal distortion.
- The Auto Keystone cannot work when Ceiling feature is On in the Setting menu. (p50)
- Perfect correction of the image distortion cannot be ensured with the Auto setup function. If the distortion is not corrected properly by pressing the AUTO SETUP/ AUTO SET button, adjust manually by pressing the KEYSTONE button on the remote control or selecting Keystone in the Setting menu. (See p25, 47)

Setting Menu (Language)

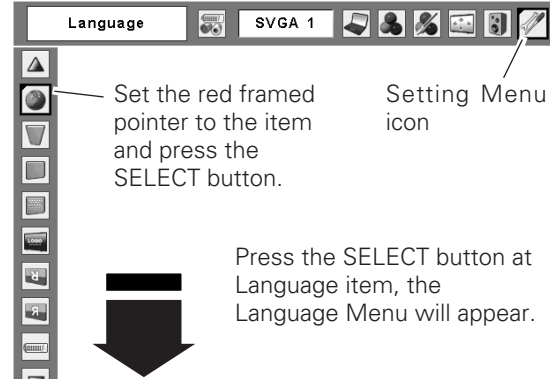

Press the SELECT button at Language item, the Language Menu will appear.

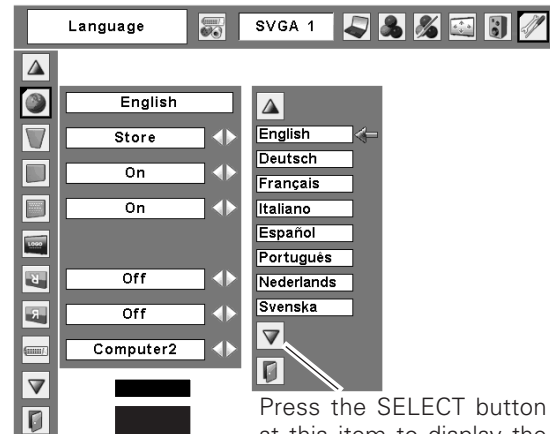

Press the SELECT button at this item to display the other languages.

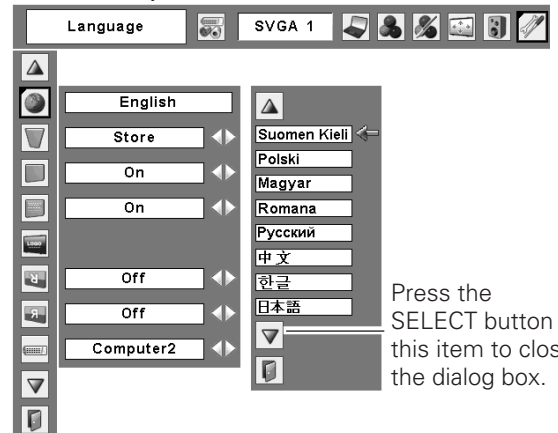

Press the SELECT button at this item to close the dialog box.

Auto setup

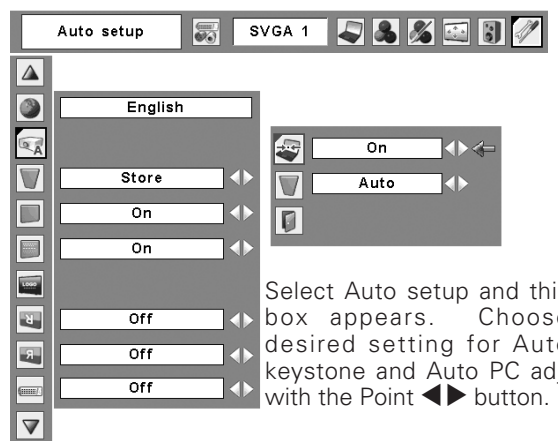

Select Auto setup and this box appears. Choose desired setting for Auto keystone and Auto PC adj. with the Point ◀▶ button.

 **Keystone**

This function corrects distortion of a projected image. Select either Store or Reset with the Point ◀▶ buttons, and then press the SELECT button. The keystone dialog box will appear. Correct keystone with the Point ▲▼ buttons. (p25)

Storestore the keystone correction even when the AC power cord is unplugged.

Resetreset the keystone correction when the AC power cord is unplugged.

 **Blue back**

Press the Point ◀▶ buttons to switch On/Off. When this function is "On," a blue image is displayed while the input signal is not detected.

 **Display**

Press the Point ◀▶ buttons to switch On/Off. This function decides to display On-Screen Displays.

OnShow all the On-Screen Displays. Use this function when you want to project images after the lamp becomes bright enough. Factory default setting is this mode.

Countdown offShow the input image instead of the countdown when turning on the projector. Use this function when you want to project the image as early as possible even when the lamp is not bright enough.

OffDo not show On-Screen Displays. except;

- On-Screen Menu
- "Power off?" message
- P-Timer
- "No signal" message for Power management item (p50)
- "Please wait..." message
- White arrows for True item in the Screen Menu (p37)

Keystone

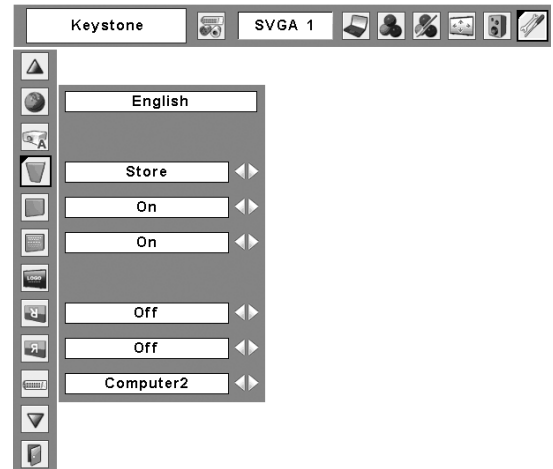

Logo (Logo and Logo PIN code lock settings)

This function allows you to customize the screen logo with Logo select, Capture, and Logo PIN code lock functions.

✓ Note:

When On is selected in Logo PIN code lock function, Logo select and Capture functions cannot be selected.

Logo select

This function decides the start-up display as follows:

- Userthe image you captured
- Defaultthe factory-set logo
- Off.....countdown only

Capture

This function enables you to capture the image being projected and use it for a start-up display or interval of presentations.

After capturing the projected image, go to the Logo select function and set it to "User". Then the captured image will be displayed when turning on the projector next time or pressing the NO SHOW button. (p28)

To capture the image, select [Yes]. To cancel the Capture function, select [No].

✓ Note:

- Before capturing an image, select Standard in the Image Select Menu to capture a proper image. (p35, 42)
- A signal from a computer can be captured up to XGA(1024 x 768). A signal from video equipment can be captured except for 720p, 1035i, and 1080i.
- When capturing the image that has been adjusted by the Keystone function, the adjustment data is automatically reset and the projector captures an image without keystone adjustment.
- When the Logo PIN code lock function is On, Capture menu cannot be selected.
- When starting to capture a new image, the previously stored image is cleared even if you cancel the capturing.

Logo select

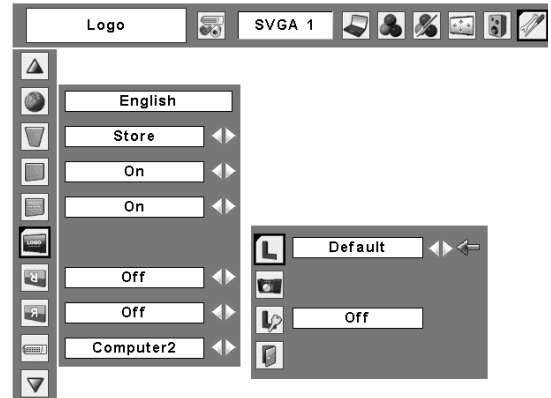

Capture

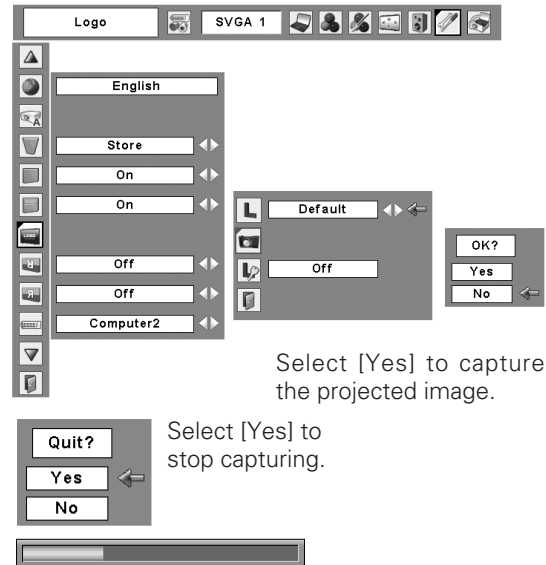

Select [Yes] to capture the projected image.

Select [Yes] to stop capturing.

Logo PIN code lock

This function prevents an unauthorized person from changing the screen logo.

- Off.....the screen logo can be changed freely from the Logo select menu. (p48)
- On.....the screen logo cannot be changed without the Logo PIN code.

If you want to change the Logo PIN code lock setting, enter a Logo PIN code along the following steps. The initial Logo PIN code is set "4321" at the factory.

Enter a Logo PIN code

Select a number by pressing the Point ◀▶ buttons and fix the number with the SELECT button. The number will change to "*". If you fixed an incorrect number, move the pointer to "Set" or "Clear" once by pressing the Point ▼ button, then return to "Logo PIN code". Enter the correct number again.

Repeat this step to complete entering a four-digit number.

When the four-digit number is fixed, the pointer will automatically move to "Set". Press the SELECT button so that you can change the Logo PIN code lock setting.

If you entered an incorrect Logo PIN code, "Logo PIN code" and the number (****) will turn red and disappear. Enter a correct Logo PIN code all over again.

Change the Logo PIN code

Logo PIN code can be changed to your desired four-digit number. Select "Logo PIN code change" with the Point ▼ button and press the SELECT button. Set a new Logo PIN code.

Be sure to note the new Logo PIN code and keep it at hand. If you lost the number, you could no longer change the Logo PIN code setting. For details on PIN code setting, refer to relevant instructions of the PIN code lock function on page 52, 53.

CAUTION:
WHEN YOU HAVE CHANGED THE LOGO PIN CODE, WRITE DOWN THE NEW PIN CODE IN COLUMN OF THE LOGO PIN CODE NO. MEMO ON PAGE 70, AND KEEP IT SECURELY. SHOULD THE LOGO PIN CODE BE LOST OR FORGOTTEN, THE PROJECTOR CAN NO LONGER BE OPERATED.

Logo PIN code lock

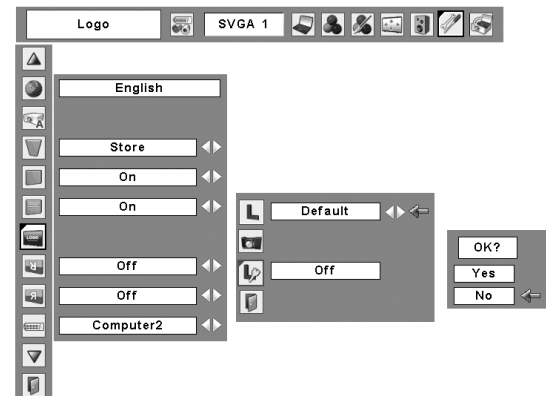

Logo PIN code lock Dialog Box



After a correct Logo PIN code is entered, the following dialog box will appear.

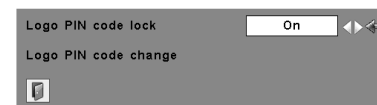

Select On/Off by pressing the Point ◀▶ buttons or change the Logo PIN code.

Ceiling

When this function is "On," the picture will be top/bottom and left/right reversed. This function is used to project the image from a ceiling mounting the projector.

Rear

When this function is "On," the picture will be left/right reversed. This function is used to project the image to a rear projection screen.

Terminal

The COMPUTER IN 2 / COMPONENT IN / MONITOR OUT terminal on the back of the projector is switchable for computer input or monitor output. (See page 10) Select Computer 2 or Monitor Out with the Point  buttons.

Computer 2computer input

Monitor Outmonitor out

Terminal function is not available when selecting Computer 2 to the input source. Change the input source to the others (Computer1 or Video) so that the Terminal function will be available. (p29, 30, 39, 40)

Standby mode

This function is available when operating the projector via the network.

Normal.... Supply the power to the network function even after turning off the projector. You can turn on/off the projector via the network, modify network environment and receive an e-mail about projector status while the projector is powered off.

Eco.....Select Eco when you do not use the projector via the network. The projector's network function will stop when turning off the projector.

Refer to the owner's manual "Network Set-up and Operation" supplied with this projector.

Power management

For reducing power consumption as well as maintaining the lamp life, the Power management function turns off the projection lamp when the input signal is interrupted and no button is pressed for a certain period.

When the input signal is interrupted and no button is pressed for 30 seconds or more, the timer display with "No signal" message will appear. The countdown will start to turn off the lamp.

Select one of the operations.

ReadyWhen the lamp has been fully cooled down, the POWER indicator changes to green blinking. In this condition, the projection lamp will be turned on if the input signal is reconnected or any button on the top control or remote control unit is pressed.

Shut downWhen the lamp has been fully cooled down, the power will be turned off.

OffPower management function is off.

Then set the countdown timer with the Point  buttons.

Ceiling

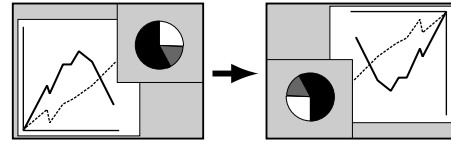

Rear

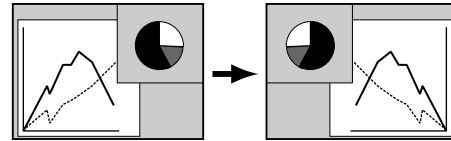

✓ Note:



When selecting Normal, the cooling fans will be operating even if the projector is turned off.

Power management

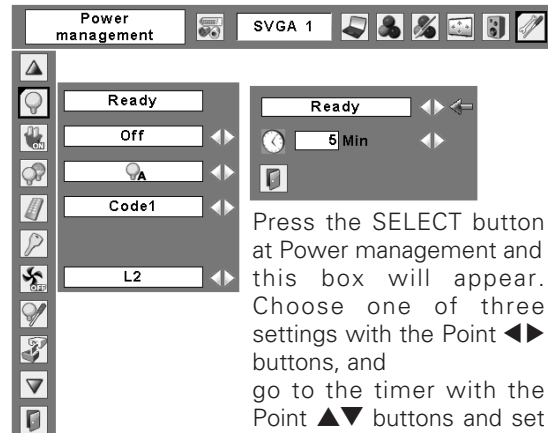

Time left before Lamp is off.



Press the SELECT button at Power management and this box will appear. Choose one of three settings with the Point  buttons, and go to the timer with the Point  buttons and set time with the Point  buttons.

 **On start**



When this function is “On”, the projector will be automatically turned on just by connecting the AC power cord to a wall outlet.

✓ Note:

Be sure to turn the projector off properly (see “Turning Off the Projector” on page 22). If the projector is turned off in the incorrect sequence, the On start function does not operate properly.

 **Lamp control**

This function allows you to change brightness of the screen.

-  Normalnormal brightness
-  Autobrightness according with the input signal
-  Ecolower brightness reduces the lamp power consumption and extends the lamp life.

 **Pointer**

You can emphasize a part of the projected image with this function. Choose either Spotlight or Pointer with the Point ▲▼ button and press the SELECT button. Then select one of three different sizes (Large, Middle, and Small) of Spotlight or a pointer of three different patterns (Arrow, Finger, and Dot) of Pointer. (See page 13 for operation.)

 **Remote control**

This projector provides eight different remote control codes (Code 1-Code 8); the factory-set, initial code (Code 1) and the other seven codes (Code 2 to Code 8). This switching function prevents remote control interference when operating several equipment at the same time. The same code should set on both the projector and the remote control. For example, operating the projector in “Code 7”,the remote control unit also must be switched to “Code 7”.

To change the code for the projector:

Select a remote control code in this Setting Menu.

To change the code for the remote control:

While holding down the MENU button, press the IMAGE button number of times corresponding to the remote control code for the projector. (See page 14 for details.)

On start

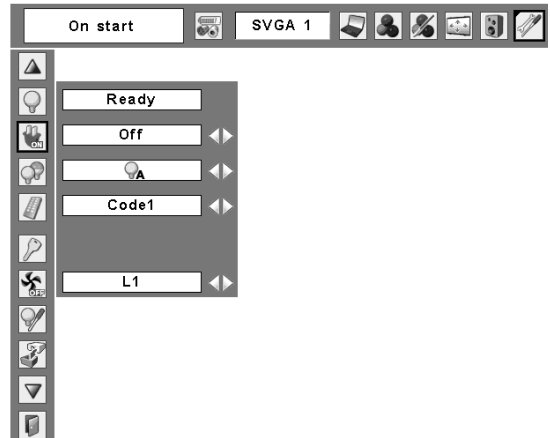

Remote control

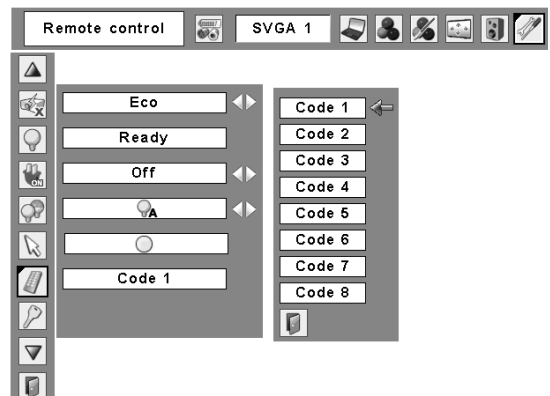



 **Security (Key lock and PIN code lock settings)**

This function allows you to use Key lock and PIN code lock function to set the security for the projector operation.

 **Key lock**

This function locks operation of the top control or the remote control. It is useful to prevent operation by an unauthorized person.

-  not locked.
-  lock the operation of the top control.
To unlock, use the remote control.
-  lock the operation of the remote control.
To unlock, use the top control.

If the top control accidentally becomes locked and you do not have the remote control nearby, disconnect the AC power cord from the AC outlet, and then with pressing the SELECT button, reinsert the AC power cord. This will cancel the top control lock.

 **PIN code lock**

This function prevents the projector from being operated by an unauthorized person and provides the following settings for security options.

- Off.....the projector is not locked with the PIN code.
- On1require to enter the PIN code every time turning on the projector.
- On2require to enter the PIN code to operate the projector once the power cord is disconnected; as long as the AC power cord is connected, the projector can be operated without the PIN code.

Whenever to change the PIN code lock setting or the PIN code (the four-digit number), you are required to enter the PIN code. "1234" is set as the initial PIN code at the factory.

Key lock

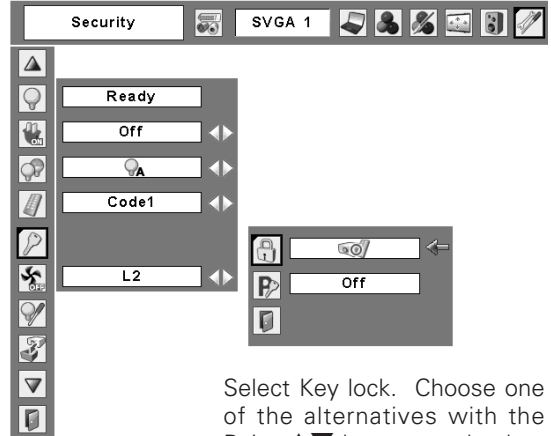

Select Key lock. Choose one of the alternatives with the Point ▲▼ buttons and select [Yes] to activate it.

PIN code lock

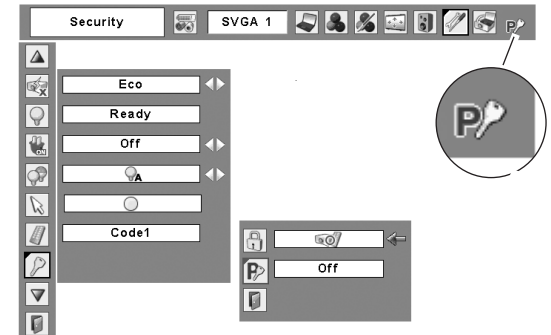

When the projector is locked with the PIN code, the PIN code lock mark appears on the menu bar.

Enter a PIN code

Select a number by pressing the Point ◀▶ buttons and fix the number with the SELECT button. The number will change to "*". If you fixed an incorrect number, move the pointer to "Set" or "Clear" once by pressing the Point ▼ button, then return to "PIN code". Enter the correct number again. Repeat this step to complete entering a four-digit number.

When the four-digit number is fixed, the pointer will automatically move to "Set". Press the SELECT button so that you can change the following PIN code lock settings.

If you entered an incorrect PIN code, "PIN code" and the number (****) will turn red and disappear. Enter a correct PIN code all over again.

To Change the PIN code lock setting

Select Off, On1, or On2 with the Point ◀▶ buttons and then move the red framed pointer to "Quit" with the Point ▼ button. Press the SELECT button to close the dialog box.

To Change the PIN code

The PIN code can be changed to your desired four-digit number. Select "PIN code change" with the Point ▼ button, and press the SELECT button to display the New PIN code input dialog box.

Select a number with the Point ◀▶ buttons and fix the number with the SELECT button. Repeat it to complete entering a four-digit number. When the four-digit number is fixed, the pointer will automatically move to "Set". Then press the SELECT button.

CAUTION:
WHEN YOU HAVE CHANGED THE PIN CODE, WRITE DOWN THE NEW PIN CODE IN COLUMN OF THE PIN CODE NO. MEMO ON PAGE 70, AND KEEP IT SECURELY. IF YOU FORGET YOUR PIN CODE, THE PROJECTOR CAN NO LONGER BE STARTED.

Enter a PIN code

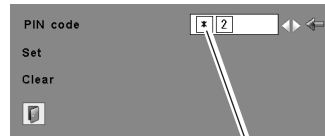

The input numbers change to "*" for security.



When the pointer automatically moves to "Set", press the SELECT button.

Change the PIN code lock setting



Select a desired setting with the Point ◀▶ buttons.

Change the PIN code



Select PIN code change and press the SELECT button. The New PIN code input dialog box will appear.



The input numbers are being displayed for confirmation.

Fan

This function provides the following alternatives in the cooling fans' operation after turning off the projector. (p22)

- L1normal operation
- L2slower and lower-sound than the normal operation (L1), but it takes longer to cool the projector down.

Lamp counter

This function is used to reset the lamp replacement counter. When replacing the projection lamp, reset the lamp replacement counter by using this function. See page 59 for operation.

Factory default

This function returns all setting values except for the user logo, PIN code lock, Logo PIN code lock and the lamp counter to the factory default settings.

Quit

Exit the Setting Menu.

Factory default

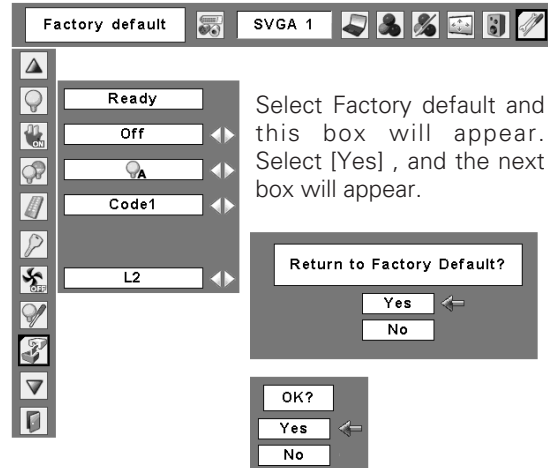

Select Factory default and this box will appear. Select [Yes] , and the next box will appear.

Return to Factory Default?

Yes ←
No

OK?

Yes ←
No

Select [Yes] to activate it.

Maintenance and Cleaning

Warning Indicator

The WARNING indicator shows the state of the function which protects the projector. Check the state of the WARNING indicator and the POWER indicator to take proper maintenance.

The projector is shut down and the WARNING indicator is blinking red.

When the temperature inside the projector reaches a certain level, the projector will be automatically shut down to protect the inside of the projector. The POWER indicator is blinking while the projector is being cooled down. When the projector has cooled down sufficiently (to its normal operating temperature), it can be turned on again by pressing the POWER ON-OFF button.

✓ Note:

After the temperature inside the projector returns to normal, the WARNING indicator still continues to blink. When the projector is turned on again, the WARNING indicator stops blinking.

Then check the matters below:

- Did you provide appropriate space for the projector to be ventilated? Check the installing condition to see if ventilation slots are not blocked.
- Is the projector not installed near the ventilation duct of air-conditioning equipment which may be hot? Install the projector away from the ventilation duct of air-conditioning equipment.
- Are the air filters clean? Clean the air filters periodically. (p56)

The projector is shut down and the WARNING indicator emits a red light.

When the projector detects an abnormal condition, it is automatically shut down to protect the inside and the WARNING indicator will be red. In this case, disconnect the AC power cord and reconnect it, and then turn the projector on once again for check. If the projector cannot be turned on and the WARNING indicator emits a red light, disconnect the AC power cord and contact the service station for check and repair.



CAUTION

DO NOT LEAVE THE PROJECTOR WITH THE AC POWER CORD CONNECTED UNDER THE ABNORMAL CONDITION. IT MAY RESULT IN FIRE OR ELECTRIC SHOCK.

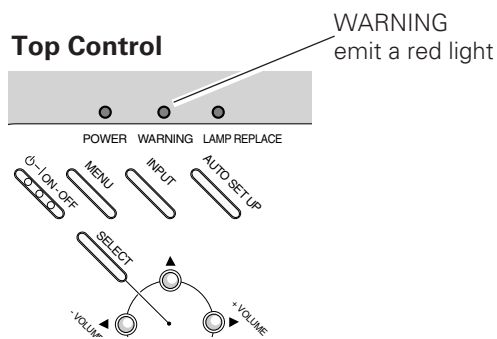
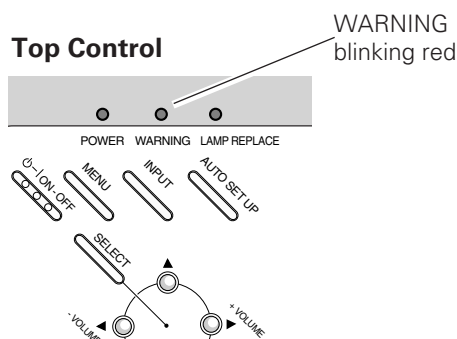

Cleaning the Air Filters

Air filters prevent dust from accumulating on the optical elements inside the projector. Should the air filters become clogged with dust particles, it will reduce cooling fans' effectiveness and may result in internal heat build up and adversely affect the life of the projector. Clean the air filters following the steps below.

- 1 Turn off the projector, and disconnect the AC power cord from the AC outlet.
- 2 Turn over the projector and remove the air filters by pulling the latches upward.
- 3 Clean the air filters with a brush or rinse them softly.
- 4 When cleaning the air filters by rinsing, dry them well. Replace the air filters properly. Make sure that the air filters are fully inserted.



CAUTION

Do not operate the projector with the air filters removed. Dust may accumulate on the optical elements degrading picture quality. Do not put small parts into the air intake vents. It may result in malfunction of the projector.

RECOMMENDATION

We recommend avoiding dusty/smoky environments when operating the projector. Usage in these environments may cause poor image quality.

When using the projector under dusty or smoky conditions, dust may accumulate on a lens, LCD panels, or optical elements inside the projector. This condition may degrade the quality of a projected image.

When the symptoms above are noticed, contact your authorized dealer or service station for proper cleaning.

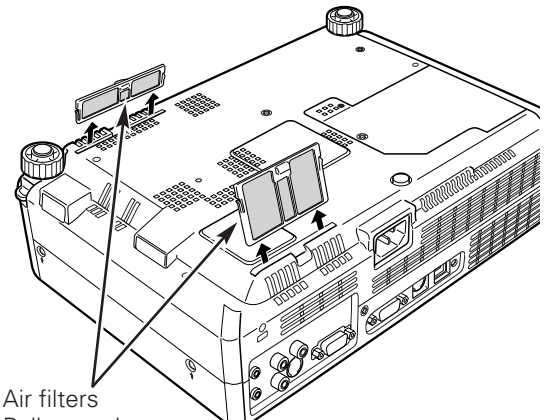

Air filters
Pull up and remove.

✓ Note:

When reinserting this air filter, be sure that the slit part is facing the outer side.

Attaching the Lens Cover

When moving this projector or while not using it over an extended period of time, replace the lens cover.

Attach the lens cover according to the following procedures.

- 1 Pass the string through a hole of the lens cover.
- 2 Turn over the projector and remove the screw with a screwdriver.
- 3 Attach the string with lens cover to a hole at the bottom of the projector and secure it with a screw.

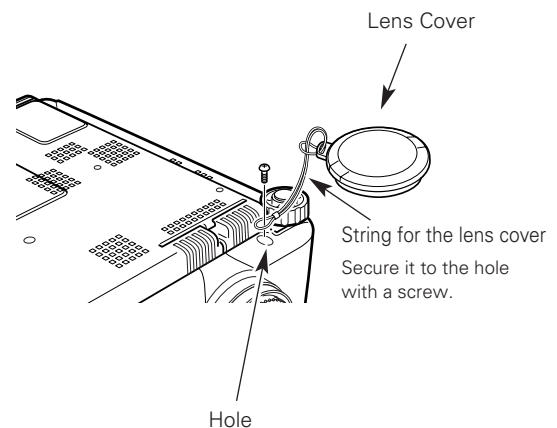

Cleaning the Projection Lens

Follow these steps to clean the projection lens.

- 1** Disconnect the AC power cord before cleaning.
- 2** Softly wipe the projection lens with a cleaning cloth that contains a small amount of non-abrasive camera lens cleaner, or use lens cleaning paper or a commercially available air blower to clean the lens. Avoid using an excessive amount of cleaner. Abrasive cleaners, solvents, or other harsh chemicals might scratch the surface.
- 3** When the projector is not in use, replace the lens cover.

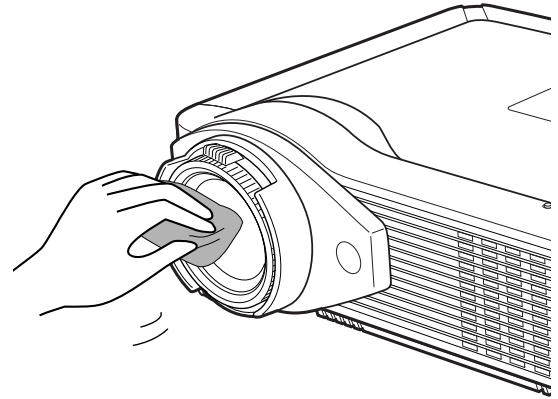

Cleaning the Projector Cabinet

Follow these steps to clean the projector cabinet.

- 1** Disconnect the AC power cord before cleaning.
- 2** Softly wipe the projector body with a soft, dry cleaning cloth. When it is heavily soiled, use a small amount of mild detergent and finish with a soft, dry cleaning cloth. Avoid using an excessive amount of cleaner. Abrasive cleaners, solvents, or other harsh chemicals might scratch the surface.
- 3** When the projector is not in use, put the projector in an appropriate carrying case to protect it from dust and scratches.

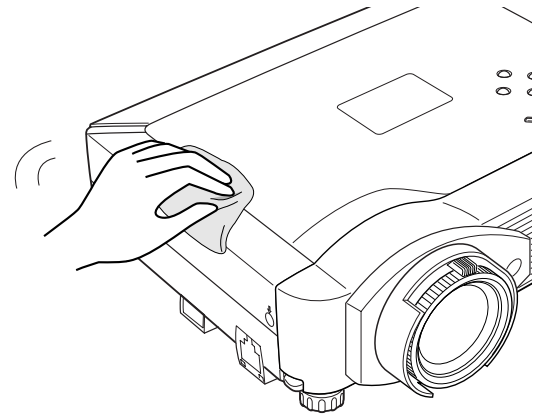

Lamp Replacement

When the life of the projection lamp of this projector draws to an end, the LAMP REPLACE indicator emits a yellow light. If this indicator lights yellow, replace the lamp with a new one promptly.



WARNING:
TURN OFF THE UV LAMP BEFORE
OPENING THE LAMP COVER

This indicator is yellow when
the life of the projection lamp
draws to an end.

Top Control

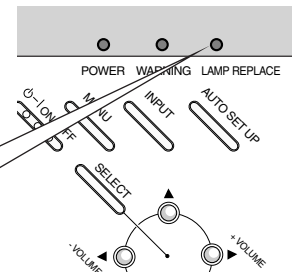

CAUTION

Allow a projector to cool, for at least 45 minutes before you open the Lamp cover. The inside of the projector can become very hot.



CAUTION

For continued safety, replace with a lamp of the same type. Do not drop a lamp or touch a glass bulb! The glass can shatter and may cause injury.

Follow these steps to replace the lamp.

- 1** Turn off the projector and disconnect the AC power cord. Allow the projector to cool for at least 45 minutes.
- 2** Remove the screw with a screwdriver, and remove the lamp cover.
- 3** Remove 2 screws of the lamp with a screwdriver and pull out the lamp by grasping the handle.
- 4** Replace the lamp with a new one and tighten the 2 screws back into position. Make sure that the lamp is set properly. Replace the lamp cover and tighten the screw.
- 5** Connect the AC power cord to the projector and turn on the projector.
- 6** **Reset the lamp replacement counter.**
See "Lamp Replacement Counter" on the next page .

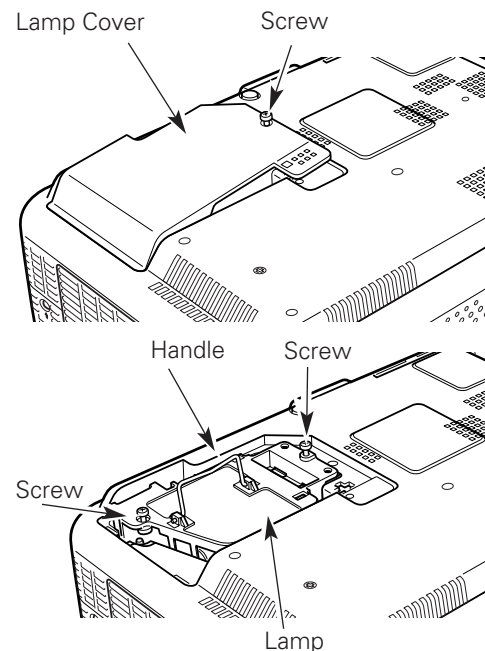

ORDER REPLACEMENT LAMP

Replacement lamp can be ordered through your dealer. When ordering a projection lamp, give the following information to the dealer.

- **Model No. of your projector** : **LC-XB27**
- **Replacement Lamp Type No.** : **POA-LMP90**
(Service Parts No. 610 323 0726)

Lamp Replacement Counter

Be sure to reset the Lamp replacement counter after the lamp is replaced. When the Lamp replacement counter is reset, the LAMP REPLACE indicator stops lighting.

- 1 Turn the projector on, press the MENU button to display the On-Screen Menu. Press the Point ◀▶ buttons to move the red framed pointer to the Setting Menu icon.
- 2 Press the Point ▲▼ buttons to move the red framed pointer to the Lamp counter function and then press the SELECT button. The first dialog box appears and shows the total accumulated time of the lamp usage and the reset option. If you select "Reset", a "Lamp replacement counter Reset?" message will appear. Select [Yes] to continue.
- 3 Another confirmation dialog box will appear, select [Yes] to reset the Lamp replacement counter.

✓ **Note:**

Do not reset the Lamp replacement counter without implementation of lamp replacement. Be sure to reset the Lamp replacement counter only after replacing the lamp.

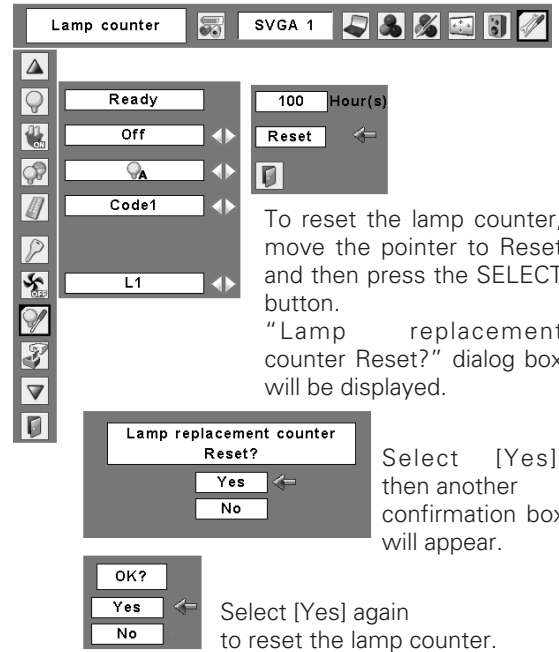

To reset the lamp counter, move the pointer to Reset and then press the SELECT button. "Lamp replacement counter Reset?" dialog box will be displayed.

Select [Yes], then another confirmation box will appear.

Select [Yes] again to reset the lamp counter.



LAMP HANDLING PRECAUTIONS

This projector uses a high-pressure lamp which must be handled carefully and properly. Improper handling may result in accidents, injury, or create a fire hazard.

- Lamp life may differ from lamp to lamp and according to the environment of use. There is no guarantee of the same life for each lamp. Some lamps may fail or terminate their life in a shorter period of time than other similar lamps.
- If the projector indicates that the lamp should be replaced, i.e., if the LAMP REPLACE indicator lights up, replace the lamp with a new one IMMEDIATELY after the projector has cooled down. (Follow carefully the instructions in the Lamp Replacement section of this manual.) Continuous use of the lamp with the LAMP REPLACE indicator lighted may increase the risk of lamp explosion.
- A Lamp may explode as a result of vibration, shock or degradation as a result of hours of use as its lifetime draws to an end. Risk of explosion may differ according to the environment or conditions in which the projector and lamp are being used.

IF A LAMP EXPLODES, THE FOLLOWING SAFETY PRECAUTIONS SHOULD BE TAKEN.

If a lamp explodes, disconnect the projector's AC plug from the AC outlet immediately. Contact an authorized service station for a checkup of the unit and replacement of the lamp. Additionally, check carefully to ensure that there are no broken shards or pieces of glass around the projector or coming out from the cooling air circulation holes. Any broken shards found should be cleaned up carefully. No one should check the inside of the projector except those who are authorized trained technicians and who are familiar with projector service. Inappropriate attempts to service the unit by anyone, especially those who are not appropriately trained to do so, may result in an accident or injury caused by pieces of broken glass.

Troubleshooting

Before calling your dealer or service center for assistance, check the items below once again.

- Make sure you have properly connected the projector to peripheral equipment as described on page 18-20.
- Make sure all equipment is connected to AC outlet and the power is turned on.
- When you operate the projector with a computer and it does not project an image, restart the computer.

Problem:	Solutions
No power	<ul style="list-style-type: none">- Plug the power cord of the projector into the AC outlet.- See if the POWER indicator lights red.- Wait 90-120 seconds after the projector is turned off when turning the projector back on. The projector can be turned on after the POWER indicator turns red. (See on page 21.)- Check the WARNING indicator. If the WARNING indicator lights red, the projector cannot be turned on. (See on page 55.)- Check the projection lamp. (See page 58.)- Unlock Key lock for the projector Key lock function. (See page 52.)
Image is out of focus.	<ul style="list-style-type: none">- Adjust focus of the projector. (See page 25.)- Provide proper distance between the projector and the projection screen. (See page 16.)- Check the projection lens to see if it needs cleaning. (See page 57.)- Moving the projector from a cool to a warm place may result in moisture condensation on the projection lens. In such cases, leave the projector off and wait until condensation evaporates.
No image	<ul style="list-style-type: none">- Check the connection between your computer or video equipment and the projector. (See page 18-20)- See if the input signal is correctly output from your computer. Some laptop computers may need to change the setting for monitor output when connecting to a projector. See your computer's instruction manual for the setting.- It takes about 30 seconds to display an image after turning on the projector. See if the selected system is corresponding with your computer or video equipment. (See page 31 and 41)- Select correct input source once again through menu operation. (See page 29,30 ,39 and 40)- Make sure the temperature is not out of the specified Operating Temperature (41 °F ~ 95 °F (5 °C ~ 35 °C)) .
Image is Left/Right reversed. Image is Top/Bottom reversed.	<ul style="list-style-type: none">- Check the Ceiling / Rear function. (See page 50.)- Check the Ceiling function. (See page 50.)
No sound	<ul style="list-style-type: none">- Check audio cable connection from audio input source.- Adjust the audio source.- Press the Volume+ button. (See page 26.)- Press the Mute button. (See page 26.)

<i>Some displays are not seen during the operation.</i>	-Check the Display function. (See page 47.)
<i>PIN code dialog box appears at start-up.</i>	-PIN code lock is being set. Input a PIN code (1234 or numbers you have set). (See page 21, 52, 53.)
<i>Computer 2 cannot be selected.</i>	-Select Computer 2 at the Terminal function. (See page 50.)
<i>The Terminal function cannot be selected.</i>	-The Terminal function cannot be selected after Computer 2 is selected. Select other input source such as Computer 1 or Video with the INPUT button on the top control, the COMPUTER button or the VIDEO button on the remote control so that the Terminal function can be selected.
<i>The Remote Control does not work.</i>	-Check the batteries. -Make sure no obstruction is between the projector and remote control. -Make sure you are not too far from the projector when using the remote control. Maximum operating range is 16.4' (5m). -Make sure the code of the remote control is conformed to the projector. (See page 51.) -Unlock Key lock for the remote control in the Key lock function. (See page 52.)
<i>Cooling fans are still running after the AC plug is disconnected.</i>	-This is normal condition. Fans are running about 1 minute even after disconnecting the AC plug.

WARNING :

High voltages are used to operate this projector. Do not attempt to open the cabinet.

If problems still persist after following all operating instructions, contact the dealer where you purchased the projector or the service center. Give the model number and explain about the problem. We will advise you how to obtain service.



The CE Mark is a Directive conformity mark of the European Community (EC).



This symbol on the nameplate means the product is Listed by Underwriters Laboratories Inc. It is designed and manufactured to meet rigid U.L. safety standards against risk of fire, casualty and electrical hazards.

Menu Tree

Computer Input / Video Input

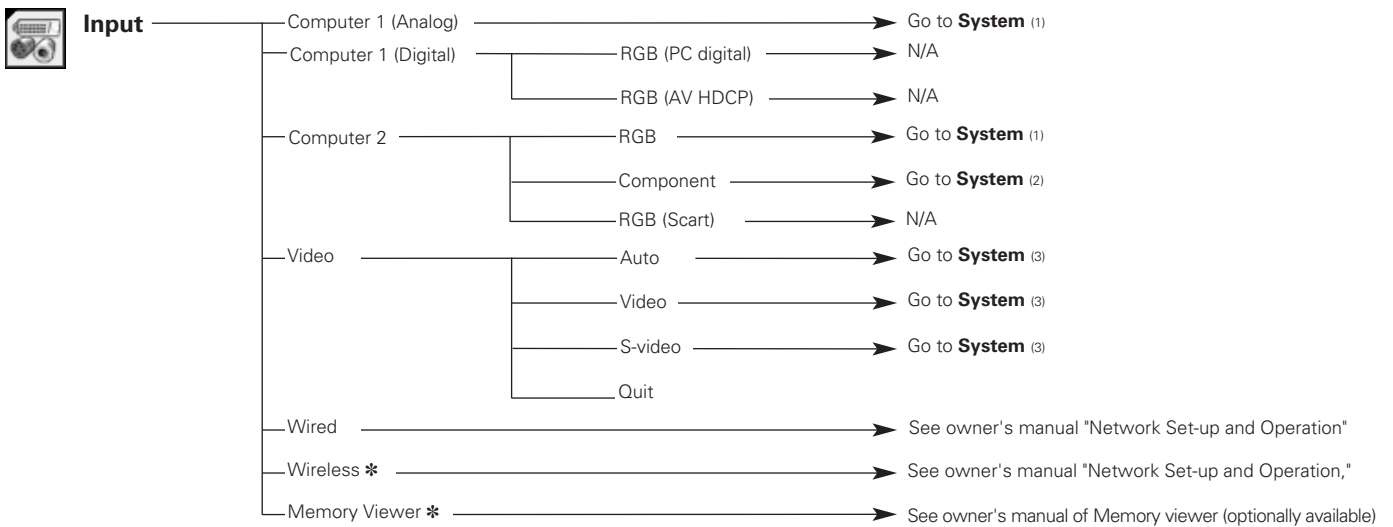

● N/A --- not applicable

*.....The menu will be displayed when connecting device for the input source.

Sound

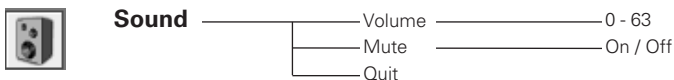

Computer Input

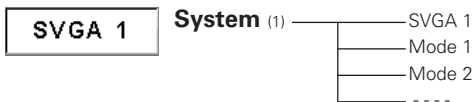

*Systems displayed in the System Menu vary depending on an input signal.

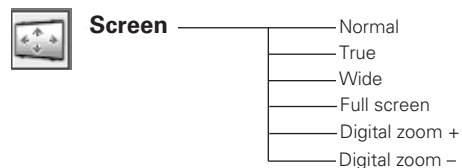
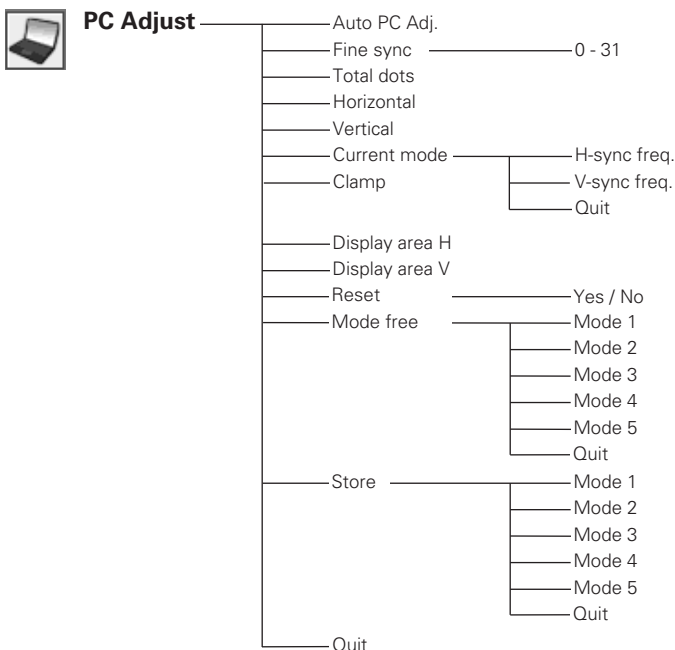
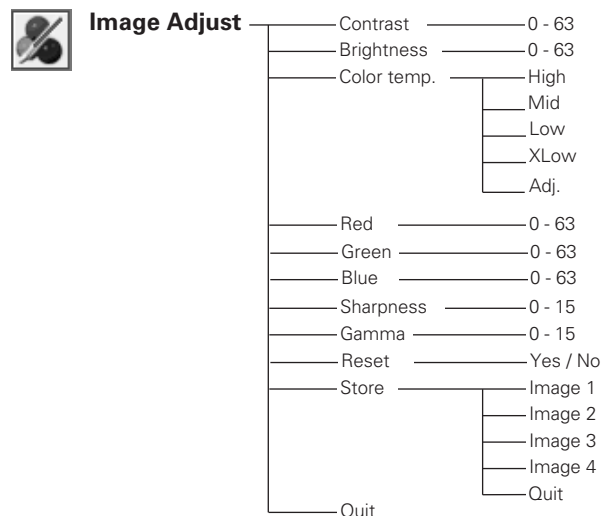
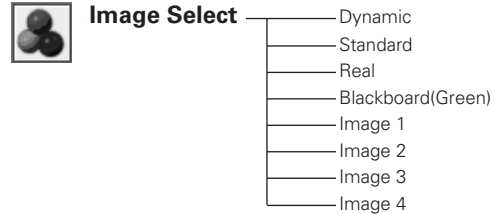

Video Input

Auto

- System (2)**
- Auto
 - 1080i
 - 1035i
 - 720p
 - 575p
 - 480p
 - 575i
 - 480i

Auto

- System (3)**
- Auto
 - PAL
 - SECAM
 - NTSC
 - NTSC 4.43
 - PAL-M
 - PAL-N



Image Select

- Dynamic
- Standard
- Cinema
- Blackboard(Green)
- Image 1
- Image 2
- Image 3
- Image 4



Image Adjust

- Contrast 0 - 63
- Brightness 0 - 63
- Color 0 - 63
- Tint 0 - 63
- Color temp.
 - High
 - Mid
 - Low
 - XLow
 - Adj.
- Red 0 - 63
- Green 0 - 63
- Blue 0 - 63
- Sharpness 0 - 15
- Gamma 0 - 15
- Noise reduction
 - Off
 - L1
 - L2
- Progressive
 - Off
 - L1
 - L2
 - Film
- Reset Yes / No
- Store
 - Image 1
 - Image 2
 - Image 3
 - Image 4
- Quit



Screen

- Normal
- Wide

Setting





























Setting

- Language
 - English
 - German
 - French
 - Italian
 - Spanish
 - Portuguese
 - Dutch
 - Swedish
 - Finnish
 - Polish
 - Hungarian
 - Romanian
 - Russian
 - Chinese
 - Korean
 - Japanese
 - Quit
- Auto setup
 - Auto PC adj. / Auto keystone
 - Quit
- Keystone Store / Reset
- Blue back On / Off
- Display On / Countdown off / Off
- Logo
 - Logo select
 - Off
 - Default
 - User
 - Capture
 - Yes / No
 - Logo PIN code lock
 - Logo PIN code entry
 - Off
 - On
 - Logo PIN code change
 - Quit
- Ceiling On / Off
- Rear On / Off
- Terminal Computer 2 / Monitor out
- Standby mode Eco / Normal
- Power management
 - Off
 - Ready
 - Shut down
 - Timer(1-30 Min)
 - Quit
- On start On / Off
- Lamp control Normal / Auto / Eco
- Pointer
 - Spotlight / Pointer
 - Quit
- Remote control Code 1 - Code 8
- Security
 - Key lock
 - Off
 - Projector
 - Remote control
 - Quit
 - PIN code lock
 - PIN code lock entry
 - Off
 - On1 / On2
 - PIN code change
 - Quit
- Fan L1 / L2
- Lamp counter
 - Hour(s) / Reset
 - Quit
- Factory default Yes / No
- Quit

Indicators and Projector Condition

Check the indicators for projector condition.

Indicators			Projector Condition
POWER red/green	WARNING red	LAMP REPLACE yellow	
			The projector is off. (The AC power cord is unplugged.)
			The projector is ready to be turned on with the POWER ON-OFF button.
			The projector is operating normally.
			The temperature inside the projector is abnormally high. The projector cannot be turned on. When the projector is cooled down enough and the temperature returns to normal, the POWER indicator emits a red light and the projector can be turned on. (The WARNING indicator keeps blinking.) Check and clean the air filters.
			The projector has been cooled down enough and the temperature returns to normal. When turning on the projector, the WARNING indicator stops blinking. Check and clean the air filters.
			The projector is preparing for stand-by or the projection lamp is being cooled down. The projector cannot be turned on until cooling is completed.
			The projector detects an abnormal condition and cannot be turned on. Unplug the AC power cord and plug it again to turn on the projector. If the projector is turned off again, disconnect the AC power cord and contact the dealer or the service center for service and checkup. Do not leave the projector on. It may cause an electric shock or a fire hazard.
			The projector is in the Power management mode.
			Either of the projector network, or memory viewer function is in abnormal condition.

 ●●● green.

 ●●● red

 ●●● off

 ●●● blinks green.

 ●●● blinks red.

* When the life of the projection lamp draws to an end, the LAMP REPLACE indicator lights yellow. When this indicator lights yellow, replace the projection lamp with a new one promptly. Reset the lamp replacement counter after replacement of the lamp. See page 58 and 59.

Compatible Computer Specifications

Basically this projector can accept the signal from all computers with the V, H-Frequency below mentioned and less than 140 MHz of Dot Clock.

When selecting these modes, PC adjustment can be limited.

ON-SCREEN DISPLAY	RESOLUTION	H-Freq. (kHz)	V-Freq. (Hz)	ON-SCREEN DISPLAY	RESOLUTION	H-Freq. (kHz)	V-Freq. (Hz)
VGA 1	640 x 480	31.47	59.88	SXGA 1	1152 x 864	64.20	70.40
VGA 2	720 x 400	31.47	70.09	SXGA 2	1280 x 1024	62.50	58.60
VGA 3	640 x 400	31.47	70.09	SXGA 3	1280 x 1024	63.90	60.00
VGA 4	640 x 480	37.86	74.38	SXGA 4	1280 x 1024	63.34	59.98
VGA 5	640 x 480	37.86	72.81	SXGA 5	1280 x 1024	63.74	60.01
VGA 6	640 x 480	37.50	75.00	SXGA 6	1280 x 1024	71.69	67.19
VGA 7	640 x 480	43.269	85.00	SXGA 7	1280 x 1024	81.13	76.107
MAC LC13	640 x 480	34.97	66.60	SXGA 8	1280 x 1024	63.98	60.02
MAC 13	640 x 480	35.00	66.67	SXGA 9	1280 x 1024	79.976	75.025
480i	————	15.734	^{60.00} (Interlace)	SXGA 10	1280 x 960	60.00	60.00
575i	————	15.625	^{50.00} (Interlace)	SXGA 11	1152 x 900	61.20	65.20
SVGA 1	800 x 600	35.156	56.25	SXGA 12	1152 x 900	71.40	75.60
SVGA 2	800 x 600	37.88	60.32	SXGA 13	1280 x 1024	50.00	^{86.00} (Interlace)
SVGA 3	800 x 600	46.875	75.00	SXGA 14	1280 x 1024	50.00	^{94.00} (Interlace)
SVGA 4	800 x 600	53.674	85.06	SXGA 15	1280 x 1024	63.37	60.01
SVGA 5	800 x 600	48.08	72.19	SXGA 16	1280 x 1024	76.97	72.00
SVGA 6	800 x 600	37.90	61.03	SXGA 17	1152 x 900	61.85	66.00
SVGA 7	800 x 600	34.50	55.38	SXGA 18	1280 x 1024	46.43	^{86.70} (Interlace)
SVGA 8	800 x 600	38.00	60.51	SXGA 19	1280 x 1024	63.79	60.18
SVGA 9	800 x 600	38.60	60.31	SXGA 20	1280 x 1024	91.146	85.024
SVGA 10	800 x 600	32.70	51.09	SXGA 21	1400 x 1050	63.979	60.190
SVGA 11	800 x 600	38.00	60.51	SXGA 22	1400 x 1050	65.346	60.116
MAC 16	832 x 624	49.72	74.55	SXGA 23	1400 x 1050	65.121	59.902
XGA 1	1024 x 768	48.36	60.00	MAC21	1152 x 870	68.68	75.06
XGA 2	1024 x 768	68.677	84.997	MAC	1280 x 960	75.00	75.08
XGA 3	1024 x 768	60.023	75.03	MAC	1280 x 1024	80.00	75.08
XGA 4	1024 x 768	56.476	70.07	480p	————	31.47	59.88
XGA 5	1024 x 768	60.31	74.92	575p	————	31.25	50.00
XGA 6	1024 x 768	48.50	60.02	720p	————	45.00	60.00
XGA 7	1024 x 768	44.00	54.58	1035i	————	33.75	^{60.00} (Interlace)
XGA 8	1024 x 768	63.48	79.35	1080i	————	33.75	^{60.00} (Interlace)
XGA 9	1024 x 768	36.00	^{87.17} (Interlace)	1080i	————	28.125	^{50.00} (Interlace)
XGA 10	1024 x 768	62.04	77.07	WXGA 1	1366 x 768	48.36	60.00
XGA 11	1024 x 768	61.00	75.70	WXGA 2	1366 x 768	47.70	60.00
XGA 12	1024 x 768	35.522	^{86.96} (Interlace)	WXGA 3	1376 x 768	48.36	60.00
XGA 13	1024 x 768	46.90	58.20	WXGA 4	1366 x 768	56.16	72.00
XGA 14	1024 x 768	47.00	58.30	UXGA 1	1600 x 1200	75.00	60.00
XGA 15	1024 x 768	58.03	72.00	UXGA 2	1600 x 1200	81.25	65.00
MAC 19	1024 x 768	60.24	75.08	UXGA 3	1600 x 1200	87.5	70.00
				UXGA 4	1600 x 1200	93.75	75.00

When an input signal is digital from DVI terminal, refer to the chart below.

ON-SCREEN DISPLAY	RESOLUTION	H-Freq. (kHz)	V-Freq. (Hz)	ON-SCREEN DISPLAY	RESOLUTION	H-Freq. (kHz)	V-Freq. (Hz)
D-VGA	640 x 480	31.47	59.94	D-SXGA 1	1280 x 1024	63.98	60.02
D-480p	640 x 480	31.47	59.88	D-SXGA 2	1280 x 1024	60.276	58.069
D-575p	768 x 575	31.25	50.00	D-SXGA 3	1280 x 1024	31.65	29.8
D-575i	768 x 576	15.625	^{50.00} (Interlace)	D-720p	1280 x 720	45.00	60.00
D-480i	640 x 480	15.734	^{60.00} (Interlace)	D-1035i	1920 x 1035	33.75	^{60.00} (Interlace)
D-SVGA	800 x 600	37.879	60.32	D-1080i	1920 x 1080	33.75	^{60.00} (Interlace)
D-XGA	1024 x 768	43.363	60.00	D-1080i	1920 x 1080	28.125	^{60.00} (Interlace)

✓ **Note:**

When the input signal is D-SXGA 1, D-SXGA 2, or D-SXGA 3, images may not be displayed properly depending on computers.

Technical Specifications

Mechanical Information

Projector Type	Multi-media Projector
Dimensions (W x H x D)	9.66" x 2.28" x 6.82" (294.5mm x 69.5mm x 208 mm) (Not including adjustable feet)
Net Weight	5.7 lbs (2.6gs)
Feet Adjustment	0° to 10.0°

Panel Resolution

LCD Panel System	0.7" TFT Active Matrix type, 3 panels
Panel Resolution	1,024 x 768 dots
Number of Pixels	2,359,296 (1,024 x 768 x 3 panels)

Signal Compatibility

Color System	PAL, SECAM, NTSC, NTSC4.43, PAL-M, PAL-N
High Definition TV Signal	480i, 480p, 575i, 575p, 720p, 1035i, and 1080i
Scanning Frequency	H-sync. 15 ~ 100 KHz, V-sync. 50 ~ 100 Hz

Optical Information

Projection Image Size (Diagonal)	Adjustable from 40" to 300"
Throw Distance	3.3' - 38.7' (1.0m - 11.8m)
Projection Lens	F 1.65 ~ 1.81 lens with f 22.5 mm ~ 27 mm with manual zoom and focus
Projection Lamp	200W

Interface

Video Input Jack	RCA Type x 1
S-video Input Jack	Mini DIN 4 pin x 1
Audio Input Jacks	RCA Type x 2
Computer Input 1 / DVH Input Terminal	DVH Terminal X 1
Computer Input 2 / Monitor Output Terminal	Analog RGB (Mini D-sub 15 pin) Terminal X 1 (In / Out switchable)
Computer/ Component Audio Input Jack	Mini Jack (stereo) x 1
Service Port Connector	Mini DIN 8 pin x 1
USB Connector	USB Series A connector x 1 / USB Series B connector x 1
Audio Output Jack	Mini Jack (stereo) x 1 (variable)
LAN Connection Terminal	100 Base-TX (100Mbps) / 10 Base-T (10Mbps)

Audio

Internal Audio Amp	1.0W RMS
Built-in Speaker	1 speaker, ø1.1" (28mm)

Power

Voltage and Power Consumption	AC 100 ~ 120 V (3.2A Max. Ampere), 50 / 60 Hz (The U.S.A and Canada) AC 200 ~ 240 V (1.6A Max. Ampere), 50 / 60 Hz (Continental Europe and The U.K.)
-------------------------------	---

Operating Environment

Operating Temperature	41 °F ~ 95 °F (5 °C ~ 35 °C)
Storage Temperature	14 °F ~ 140 °F (-10°C ~ 60 °C)

Remote Control

Battery	AAA, UM-04 or LR03 Type x 2
Operating Range	16.4' (5m) / ±30°
Dimensions	1.8"(W) x 1.0"(H) x 5.7"(D) (45mm x 25mm x 145mm)
Net Weight	3.5oz (99g) (including batteries)
Laser Pointer	Class II Laser (Max. Output : 1m W / Wave length : 640-660nm)

Accessories

Owner's Manual and Owner's Manual "Network Set-up and Operation"
 AC Power Cord
 Remote Control and Batteries
 USB Cable
 DVI-VGA Cable
 Lens Cover with String
 PIN Code Label
 CD-ROM
 Soft Carrying Case

- The specifications are subject to change without notice.
- LCD panels are manufactured to the highest possible standards. Even though 99.99% of the pixels are effective, a tiny fraction of the pixels (0.01% or less) may be ineffective by the characteristics of the LCD panels.

Optional Parts

The parts listed below are optionally available. When ordering those parts, give the item name and Model No. to the sales dealer.

	<i>Model No.</i>
COMPONENT-VGA Cable	: AH-98771 (POA-CA-COMPVGA)
SCART-VGA Cable	: AH-98881 (POA-CA-SCART)
Ceiling Hanger	: POA-CHS-US01 (for low ceiling) POA-CHL-UL01 (for high ceiling) POA-CHS-US02 (for low ceiling) POA-CHL-UL02 (for high ceiling) POA-CHB-XU70
USB Memory	: WL-30 (This is used for Memory Viewer operation.)
USB Wireless LAN adapter	: WL-10 (This is used for Wireless LAN operation.)

PJ Link Notice

This projector is compliant with PJLink Standard Class 1 of JBMIA (Japan Business Machine and Information System Industries Association). This projector supports all commands defined by PJLink Class 1 and is verified conformance with PJLink Standard Class 1.

For PJ Link password, see p49 on owner's manual "Network Set-up and Operation".

Projector Input		PJLink Input	Parameter
Computer1 (Analog)		RGB 1	11
Computer1 (Digital)	RGB (PC digital)	DIGITAL 1	31
	RGB (AV HDCP)	DIGITAL 2	32
Computer2	RGB	RGB 2	12
	Component	RGB 3	13
	RGB (Scart)	RGB 4	14
Video	Auto	VIDEO 1	21
	Video	VIDEO 2	22
	S-video	VIDEO 3	23
Wired		NETWORK 1	51
Wireless		NETWORK 2	52
Memory Viewer		STORAGE 1	41

PJLink is a registered trademark of JBMIA and pending trademark in some countries.



Configurations of Terminals

COMPUTER IN 2 /COMPONENT IN /MONITOR OUT (ANALOG)

Terminal : Analog RGB (Mini D-sub 15 pin)

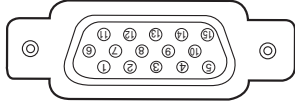

1	Red (R/Cr) Input / Output	9	----
2	Green (G/Y) Input / Output	10	Ground (Vert.sync.)
3	Blue (B/Cb) Input / Output	11	Ground / ----
4	----	12	----
5	Ground (Horiz.sync.)	13	Horiz. sync. Input/Output (Composite H/V sync.)
6	Ground (Red)	14	Vert. sync.
7	Ground (Green)	15	----
8	Ground (Blue)		

DVI-I TERMINAL (DIGITAL/ANALOG)

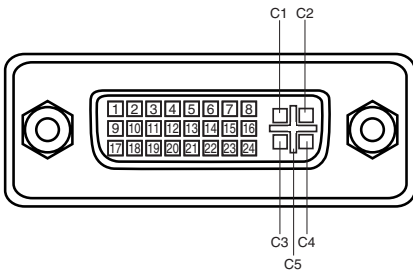

C1	Analog Red Input
C2	Analog Green Input
C3	Analog Blue Input
C4	Analog Horiz. sync
C5	Analog Ground (R/G/B)

1	T.M.D.S. Data2-	9	T.M.D.S. Data1-	17	T.M.D.S. Data0-
2	T.M.D.S. Data2+	10	T.M.D.S. Data1+	18	T.M.D.S. Data0+
3	T.M.D.S. Data2 Shield	11	T.M.D.S. Data1 Shield	19	T.M.D.S. Data0 Shield
4	No Connect	12	No Connect	20	No Connect
5	No Connect	13	No Connect	21	No Connect
6	DDC Clock	14	+5V Power	22	T.M.D.S. Clock Shield
7	DDC Data	15	Ground (for +5V)	23	T.M.D.S. Clock+
8	Analog Vert. sync	16	Hot Plug Detect	24	T.M.D.S. Clock-

USB CONNECTOR (Series A)

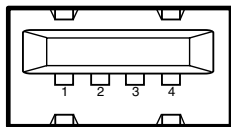

1	VCC(5V)
2	- DATA
3	+ DATA
4	Ground

USB CONNECTOR (Series B)

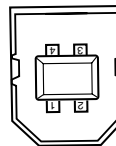

1	Vcc
2	- Data
3	+ Data
4	Ground

LAN TERMINAL

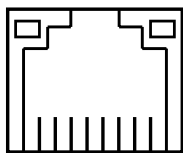

87654321

1	TX +	5	----
2	TX -	6	RX -
3	RX +	7	----
4	----	8	----

SERVICE PORT CONNECTOR

Terminal : Mini DIN 8-PIN

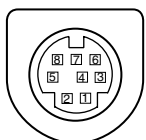

1	R X D	5	RTS / CTS
2	----	6	T X D
3	----	7	GND
4	GND	8	GND

PIN Code Number Memo

Write down the PIN code number in the column below and keep it with this manual securely. If you forgot or lost the number and unable to operate the projector, contact the service station.

PIN Code Lock No.

--	--	--	--

Factory default set No: 1 2 3 4*

Logo PIN Code Lock No.

--	--	--	--

Factory default set No: 4 3 2 1*

*Should the four-digit number be changed, the factory set number will be invalid.

While the projector is locked with the PIN code...

Put the label below (supplied) on in a prominent place of the projector's body while it is locked with a PIN code.

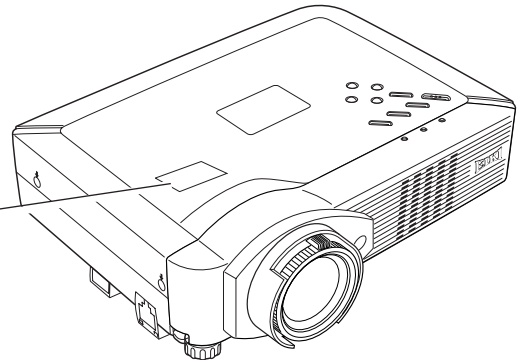

EIKI

A-key to better communications

U.S.A.

EIKI International, Inc.
30251 Esperanza
Rancho Santa Margarita
CA 92688-2132
U.S.A.
Tel : 800-242-3454 (949)-457-0200
Fax : 800-457-3454 (949)-457-7878
E-Mail : usa@eiki.com

Deutschland & Österreich

EIKI Deutschland GmbH
Am Frauwald 12
65510 Idstein
Deutschland
Tel : 06126-9371-0
Fax : 06126-9371-14
E-Mail : info@eiki.de

Canada

EIKI CANADA - Eiki International, Inc.
P.O. Box 156, 310 First St. - Unit 2,
Midland, ON, L4R 4K8, Canada
Tel : 800-563-3454 (705)-527-4084
Fax : 800-567-4069 (705)-527-4087
E-Mail : canada@eiki.com

Eastern Europe

EIKI CZECH spol. s.r.o.
Umelecká 15
170 00 Praha 7
Czech Republic
Tel : +42 02 20570024
+42 02 20571413
Fax : +42 02 20571411
E-Mail : easterneurope@eiki.de

Japan & Worldwide

EIKI Industrial Company Limited.
4-12 Banzai-Cho, Kita-Ku, Osaka,
530-0028 Japan
Tel : +81-6-6311-9479
Fax : +81-6-6311-8486

WorldWide Website <http://www.eiki.com>