

Owner's Manual

Network Set-up and Operation For Windows

Wired and Wireless Setting

Projector Set-up and Operation

Network Capture

Network Viewer

Moderator Function

USB Display

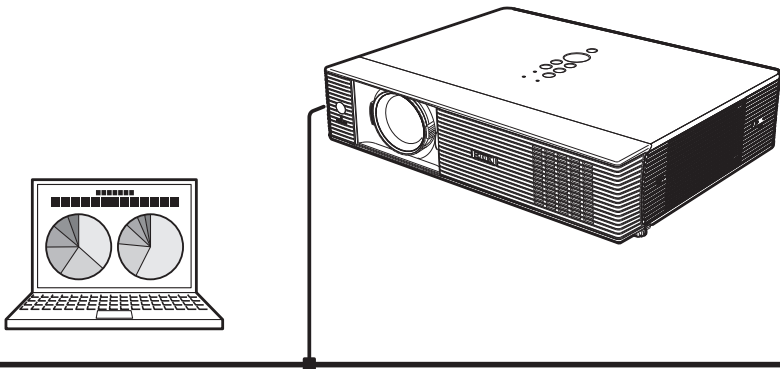

This is the manual for the Network function.

Read this manual thoroughly to operate the Network function.

First, read the owner's manual of the projector to understand the basic operation of the projector and the safety instructions.

The safety instructions in the owner's manuals should be followed strictly.

Compliance

This projector provides the wireless LAN module which complies with the module certification.

Federal Communications Commission Notice

This equipment has been tested and found to comply with the limits for a Class B digital device, pursuant to part 15 of the FCC Rules. These limits are designed to provide reasonable protection against harmful interference in a residential installation. This equipment generates, uses and can radiate radio frequency energy and, if not installed and used in accordance with the instructions, may cause harmful interference to radio communications. However, there is no guarantee that interference will not occur in a particular installation. If this equipment does cause harmful interference to radio or television reception, which can be determined by turning the equipment off and on, the user is encouraged to try to correct the interference by one or more of the following measures:

- Reorient or relocate the receiving antenna.
- Increase the separation between the equipment and receiver.
- Connect the equipment into an outlet on a circuit different from that to which the receiver is connected.
- Consult the dealer or an experienced radio/TV technician for help.

Model Number	: 1AV4U19B25500
Trade Name	: EIKI
Responsible party	: EIKI International, Inc.
Address	: 30251 Esperanza Rancho Santa Margarita CA 92688-2132
Telephone No.	: 800-242-3454 (949-457-0200)

This device complies with Part 15 of FCC Rules and RSS-Gen of IC Rules. Operation is subject to the following two conditions: (1) the device may not cause interference, and (2) the device must accept any interference, including interference that may cause undesired operation of this device.

CAUTION: Properly shielded a grounded cables and connectors must be used for connection to host computer and /or peripherals in order to meet FCC emission limits.

VGA cable with ferrite core must be used for RF interference suppression.

For Canadian Users

This Class B digital apparatus complies with Canadian ICES-003.

Cet appareil numérique de la classe B est conforme à la norme NMB-003 du Canada.

FCC Warning

Changes or modifications not expressly approved by the party responsible for compliance could void the user's authority to operate the equipment.

FCC RF Exposure Warning

- This transmitter must not be co-located or operated in conjunction with any other antenna or transmitter.
- This equipment complies with FCC/IC radiation exposure limits set forth for uncontrolled equipment and meets the FCC radio frequency (RF) Exposure Guidelines in Supplement C to OET65 and RSS-102 of IC radio frequency (RF) Exposure rules. This equipment should be installed and operated with at least 20cm and more between the radiator and person's body (excluding extremities: hands, wrists, feet and ankles).



The CE Mark is a Directive conformity mark of the European Community (EC).



The Alert Mark is a Directive conformity mark of the European Community.

English	Hereby, EIKI Deutschland GmbH declares that this WLAN Module (1AV4U19B25500) is in compliance with the essential requirements and other relevant provisions of Directive 1999/5/EC.
Česky [Czech]	EIKI Deutschland GmbH tímto prohlašuje, že tento WLAN Module (1AV4U19B25500) je ve shodě se základními požadavky a dalšími příslušnými ustanoveními směrnice 1999/5/ES.
Dansk [Danish]	Undertegnede EIKI Deutschland GmbH erklærer herved, at følgende udstyr WLAN Module (1AV4U19B25500) overholder de væsentlige krav og øvrige relevante krav i direktiv 1999/5/EF.
Deutsch [German]	Hiermit erkläre EIKI Deutschland GmbH dass sich das Gerät WLAN Module (1AV4U19B25500) in Übereinstimmung mit den grundlegenden Anforderungen und den übrigen einschlägigen Bestimmungen der Richtlinie 1999/5/EG befindet.
Eesti [Estonian]	Käesolevaga kinnitab EIKI Deutschland GmbH seadme WLAN Module (1AV4U19B25500) vastavust direktiivi 1999/5/EÜ põhinõuetele ja nimetatud direktiivist tulenevatele teistele asjakohastele sätetele.
Español [Spanish]	Por medio de la presente EIKI Deutschland GmbH declara que el WLAN Module (1AV4U19B25500) cumple con los requisitos esenciales y cualesquiera otras disposiciones aplicables o exigibles de la Directiva 1999/5/CE.
Ελληνική [Greek]	ΜΕ ΤΗΝ ΠΑΡΟΥΣΑ ΕΙΚΙ Deutschland GmbH ΔΗΛΩΝΕΙ ΟΤΙ WLAN Module (1AV4U19B25500) ΣΥΜΜΟΡΦΩΝΕΤΑΙ ΠΡΟΣ ΤΙΣ ΟΥΣΙΩΔΕΙΣ ΑΠΑΙΤΗΣΕΙΣ ΚΑΙ ΤΙΣ ΛΟΙΠΕΣ ΣΧΕΤΙΚΕΣ ΔΙΑΤΑΞΕΙΣ ΤΗΣ ΟΔΗΓΙΑΣ 1999/5/ΕΚ.
Français [French]	Par la présente EIKI Deutschland GmbH déclare que l'appareil WLAN Module (1AV4U19B25500) est conforme aux exigences essentielles et aux autres dispositions pertinentes de la directive 1999/5/CE.
Italiano [Italian]	Con la presente EIKI Deutschland GmbH dichiara che questo WLAN Module (1AV4U19B25500) è conforme ai requisiti essenziali ed alle altre disposizioni pertinenti stabilite dalla direttiva 1999/5/CE.
Latviski [Latvian]	Ar šo EIKI Deutschland GmbH deklarē, ka WLAN Module (1AV4U19B25500) atbilst Direktīvas 1999/5/EK būtiskajām prasībām un citiem ar to saistītajiem noteikumiem.
Lietuvių [Lithuanian]	Šiuo EIKI Deutschland GmbH deklaruoją, kad šis WLAN Module (1AV4U19B25500) atitinka esminius reikalavimus ir kitas 1999/5/EB Direktyvos nuostatas.
Nederlands [Dutch]	Hierbij verklaart EIKI Deutschland GmbH dat het toestel WLAN Module (1AV4U19B25500) in overeenstemming is met de essentiële eisen en de andere relevante bepalingen van richtlijn 1999/5/EG.
Malti [Maltese]	Hawnhekk, EIKI Deutschland GmbH jiddikjara li dan WLAN Module (1AV4U19B25500) jikkonforma mal-htigijiet essenzjali u ma provvedimenti oħrajn rilevanti li hemm fid-Dirrettiva 1999/5/EC.
Magyar [Hungarian]	Alulírott, EIKI Deutschland GmbH nyilatkozom, hogy a WLAN Module (1AV4U19B25500) megfelel a vonatkozó alapvető követelményeknek és az 1999/5/EC irányelv egyéb előírásainak.
Polski [Polish]	Niniejszym EIKI Deutschland GmbH oświadcza, że WLAN Module (1AV4U19B25500) jest zgodny z zasadniczymi wymogami oraz pozostałymi stosownymi postanowieniami Dyrektywy 1999/5/EC.
Português [Portuguese]	EIKI Deutschland GmbH declara que este (1AV4U19B25500) está conforme com os requisitos essenciais e outras disposições da Directiva 1999/5/CE.
Slovensko [Slovenian]	EIKI Deutschland GmbH izjavlja, da je ta (1AV4U19B25500) v skladu z bistvenimi zahtevami in ostalimi relevantnimi določili direktive 1999/5/ES.
Slovensky [Slovak]	EIKI Deutschland GmbH týmto vyhlasuje, že (1AV4U19B25500) spĺňa základné požiadavky a všetky príslušné ustanovenia Smernice 1999/5/ES.
Suomi [Finnish]	EIKI Deutschland GmbH vakuuttaa täten että (1AV4U19B25500) tyyppinen laite on direktiivin 1999/5/EY oleellisten vaatimusten ja sitä koskevien direktiivin muiden ehtojen mukainen.
Svenska [Swedish]	Härmed intygar EIKI Deutschland GmbH att denna (1AV4U19B25500) står i överensstämmelse med de väsentliga egenskapskrav och övriga relevanta bestämmelser som framgår av direktiv 1999/5/EG.
Íslenska [Icelandic]	Hér með lýsir EIKI Deutschland GmbH yfir því að (1AV4U19B25500) er í samræmi við grunnkröfur og aðrar kröfur, sem gerðar eru í tilskipun 1999/5/EC.
Norsk [Norwegian]	EIKI Deutschland GmbH erklærer herved at utstyret (1AV4U19B25500) er i samsvar med de grunnleggende krav og øvrige relevante krav i direktiv 1999/5/EF.

Safety instructions



CAUTION IN USING THE PROJECTOR VIA NETWORKS

- When you find a problem with the projector, remove the power cable immediately and inspect the unit. Using the projector with failure may cause fire or other accidents.
- If you remotely use the projector via networks, carry out a safety check regularly and take particular care to its environment. Incorrect installation may cause fire or other accidents.



CAUTION IN USING NETWORK FUNCTION

- EIKI Industrial Co., Ltd. assumes no responsibility for the loss or damage of data, or damage of the computer caused by using this projector. Making back-up copies of valuable data in your computer is recommended.

Caution about Radio Wave

This unit operates in 2.4 GHz band, the same frequency band used for industrial, scientific, and medical equipment (such as pacemaker), as well as amateur radio stations.

Please read "Safety Instructions" section and make sure the following cautions.

1. Be sure that there are no other devices in the area that may use the same frequency band as Projector.
2. If any other devices are causing radio interferences, change the communication frequency channel or move to other location.

Trademarks and Copyright

Microsoft, Windows, and Internet Explorer are either registered trademarks or trademarks of Microsoft Corporation in the United States and/or other countries.

Netscape Navigator and Netscape Communicator are registered trademarks or trademarks of Netscape Communications Corporation in the United States and other countries.

Pentium is a registered trademark of Intel Corp. in the United States.

Each name of corporation or product in this Owner's Manual is either a registered trademark or a trademark of its respective corporation.

Notes

- The contents of this manual are subject to change without notice.
- You may not copy the printed materials accompanying with the software.
- We shall not be responsible for any damages caused by reliance on this manual.

Expression/Abbreviation

The OS of the computer and the Web browser described in this manual is Windows XP Professional and Internet Explorer 6.0. In case of another OS or Web browser, some instruction procedures may differ from the actual operation depending on your computer environment.

Use of this manual

This manual does not provide the description of basic operation and functions for computer, web browser, projector and network. For instructions about each piece of equipment or application software, please refer to the respective booklet.

Table of contents

Compliance	2
Safety instructions	4
Table of contents.....	5
Operating environment and configuration.....	8
Required operating environment for computers	8
Network specifications of the projector.....	9
Useful guide to the network function	10
1. About LAN functions	11
LAN functions and the features.....	12
Image projecting system via LAN.....	12
An example of the connection.....	13
LAN connection modes.....	14
2. Setup procedures	17
Installing the software	19
3. Names and functions of the operation screen	23
Network connection standby display	24
Network Capture 5 window.....	25
4. Wired LAN configurations	27
Connecting to the LAN line.....	28
Network environment settings.....	28
Confirming the operation.....	30
Network PIN code.....	32
Network information.....	32
Wired factory default.....	33
Wired LAN factory default settings.....	33
USB Display.....	34
5. Wireless LAN configurations	35
Setting the network environment.....	36
Setting procedures.....	36
Configuring security with the projector.....	38
Easy wireless setting.....	43
Network PIN code.....	44
Network information.....	44
Wireless factory default.....	44

WIRELESS indicator display	45
Wireless LAN factory default settings	46

6. Basic setting and operation47

Starting up the Browser	48
How to use the setting page	50
Initial setting.....	52
Network configuration	55
Configuring wireless LAN setting and security setting.....	57
E-mail setting	60
SNMP setting.....	64

7. Controlling the projector67

Power control and status check	68
Controls	70
PC adjustment	74
Setting up the projector.....	75
Timer setting	78
Projector information.....	81
Multi-control	83

8. Network capture functions89

About Network Capture function.....	90
Using the Real Time Capture	93
Using the Network Communication.....	98
How to use the Network communication	102
Network Communication operation and change of state.....	105
Executing the forcing mode.....	106
Moderator function	107
Preparation for using the moderator function	108
Using the moderator function.....	109
Moderator's password setting up.....	110
Unregister moderator status	110
Error information	111

9. Network Viewer functions..... 113

Creating the available data [Network Viewer 5]	114
Creating a program file [Program Editor].....	119

Using the Network Viewer function.....	124
Use of the projector as FTP server	130

10. Appendix..... 133

Use of telnet	134
Web browser setting	136
Firewall setting	141
Troubleshooting.....	142
Terminology.....	148

Operating environment and configuration

Required operating environment for computers

When operating the projector via the networks, computers should meet the operating environment below.

OS		Microsoft Windows 2000 or Microsoft Windows XP or Microsoft Windows Vista (32bit version)
CPU		Pentium 3 ; 1GHz or higher (more than 2GHz is recommended) for Windows 2000 or Windows XP Pentium 4 ; 3GHz or higher for Windows Vista
Memory		256MB or more for Windows 2000 or Windows XP 1GB or more for Windows Vista
Free HDD Space		100MB
Screen Resolution		Required to support any of VGA (640 x 480), SVGA (800 x 600), XGA (1024 x 768), The color number should be either 16 bit (65536 colors) or 24/32 bit (16.77 million colors).
Communication Protocol		TCP/IP
Network Correspond	Wireless LAN	Correspond to IEEE802.11b/g/n
	Wired LAN	Correspond to 100BASE-TX (100Mbps) /10BASE-T (10Mbps)
Browser Application		Microsoft Internet Explorer Ver.4.0 or later Netscape Communications Netscape Communicator Ver.6.0 or later

Network specifications of the projector

LAN Terminal

Data communication speed	100Base-TX (100Mbps)/10Base-T (10Mbps)
Protocol	TCP/IP

Wireless LAN

Interface	IEEE802.11b/g/n
Communication Mode	AdHoc, Infrastructure
Data Transfer Speed	1/2/5.5/11Mbps (IEEE802.11b) 6/9/12/18/24/36/48/54Mbps (IEEE802.11g) Max speed 150Mbps (IEEE802.11n)
Wireless Frequency (Channel)	2412MHz–2462MHz (CH1–CH11)
Modulation Form	IEEE802.11g OFDM 54/48Mbps 64QAM, 36/24Mbps 16QAM, 18/12Mbps QPSK, 9/6Mbps BPSK IEEE802.11b DSSS 11/5Mbps CCK, 2Mbps DQPSK, 1Mbps DBPSK IEEE802.11n OFDM
Protocol	TCP/IP
Security	WPS Push Button, WPS PIN code, WEP 64Bit (Open/ Shared) /WEP 128Bit (Open/Shared), WPA-PSK(TKIP), WPA2-PSK(AES), SSID, ESSID
Service area	about 30 m (without disturbance) Differs according to the operating environment.

Compliance

Countries and Standards	JAPAN: VCCI ClassB, TELEC (Wireless)
	USA: FCC Part15 Subpart C (Wireless) FCC Part15 Subpart C, Class B
	Canada: IC RSS-210 (Wireless), IC ICES-003 ClassB
	Europe: R&TTE, EMC, LVD

The wireless LAN can be used in the following countries and regions. There are restrictions on channels and frequencies in the countries and regions at which you can use the wireless communication.

CE Austria / Belgium / Bulgaria / Cyprus / Czech / Denmark / Estonia / Finland / France* / Germany / Greece / Hungary / Iceland / Ireland / Italy / Lithuania / Latvia / Liechtenstein / Luxembourg / Malta / Poland / Portugal / Norway / Netherlands / Romania / Slovakia / Slovenia / Spain / Sweden / Switzerland / Turkey / U.K.

* Outdoor use limited to 10mW eirp within the band 2454 - 2483.5MHz.

Useful guide to the network function

This manual describes the operation procedure of the projector's network menu and the provided application software for Windows users. Please refer to this manual depending on the situation.

● How to project the computer screen's image via the network

To project the computer screen's image via the network, you need to make a network setting in the projector and connect the projector to the network, or if you use the supplied USB memory, you can project the computer screen's image via the network without making a network setting.

Check 1 Did you make a network setting in the projector?

Yes

No



Project the image by using the Auto Capture program on the supplied USB memory. (p.97)



Check 2 Did you install the supplied application?

Yes

No



- Control by the projector (p.93, 96)
- Control by the web browser (p.93, 95)



Project the image by using the Real Time Capture function in the supplied 'Network Capture 5' application. (p.93, 94)

● How to setup or control the projector by using a PC via the network

To setup or control the projector via the network, you need to make a network setting in the projector and connect the projector to the network.

Check Did you make a network setting in the projector?

Yes

No



You cannot setup or control the projector via the network without making a network setting in the projector. Please make a network setting. [Wired LAN configurations (p.27-33)/Wireless LAN configurations (p.35-46)]



Setup or control the projector by controlling the web browser of the PC. [Setup (p.47-66)/ Control p.67-88)].

● How to use all functions concerning the network

To use all functions concerning the network of this projector, you need to make a network setting in the projector and install the supplied application. Please follow the procedure on page 18.

1. About LAN functions

This chapter describes the features, the mechanism, and connection procedures of the LAN.

LAN functions and the features

This product is loaded with a LAN network function which enables you to project an image on the computer through a projector via Network with dedicated software.

With the software, you can also manipulate the projecting image and the projector.

This software has functions below and you can use the projector under various network environments to meet the wide-ranging needs of the operation.

- Accept both Wired and Wireless LAN environment. When the projector is operated via Wireless LAN, there is no need for wire connection.
- Remove the burden of LAN settings. Easy LAN setting function is provided.
- USB display function to reproduce the computer image and the sound with connecting USB cable.
- One computer image can be projected up to 5 projectors simultaneously.
- Network capture function to project the computer's screen image through the projector.
- Remote function which allows you to operate the projector from a distance.
- Monitoring function for the projector operation.
- E-mail function which reports the operating status to your maintenance management.
- Network viewer function which remotely operates the image data on the server to project through the projector.
- Moderator function with which the moderator can project the image on the participants' computer screen at the meetings or the classes.
- Multi control function which can operate multiple projectors (up to 100) simultaneously.

Image projecting system via LAN

The images are projected through an image capturing system which helps to project the faithful computer images. With this system, you can use the product under various application environments despite the differences of application software.

Flow of Image Transfer

1. Download the computer image with the dedicated software faithfully to the real image.
2. The downloaded data will be compressed to the digital signal and transferred to the projector via the LAN (Wired or Wireless). (One computer can operate up to 5 projectors simultaneously.)
3. Digital signal will be reproduced into RGB image signal and will be projected by the projector.

* The image will be transferred to each projector. The time lag can occur between each projection.

CAUTION: This product does not correspond to the application with DirectX, MS-Office assistant, and video replay such as DVD.

An example of the connection

The illustration below shows an example of the projection via the LAN.

You can project the image on Computer (1) (Wired LAN connection), or Computer (2) (Wireless LAN connection) through the selected projector .

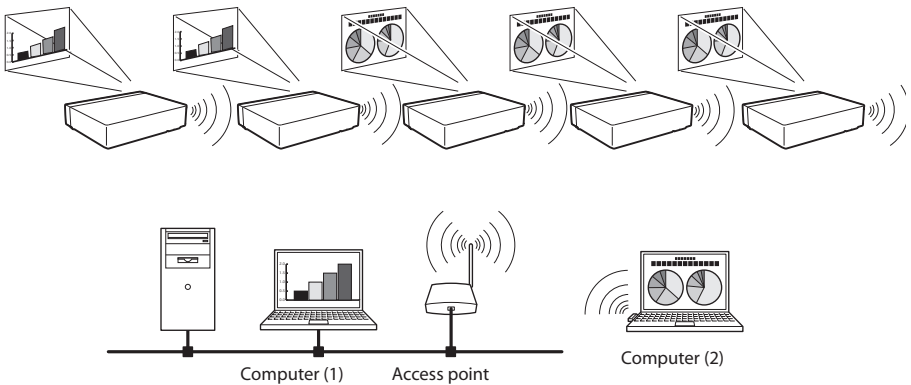

LAN connection modes

Connection modes differ depending on the LAN and computer environments.

Connect appropriately for each environment.

■ Wireless LAN, Infrastructure Communication Mode

Communicate over an access point between Wired LAN equipment and Wireless LAN equipment. Or, communicate over an access point among multiple Wireless LAN equipment. Wireless LAN equipment will select an access point to communicate SSID/ESSID modes. These communication modes are used when both Wireless LAN and Wired LAN are used in the same network environment.

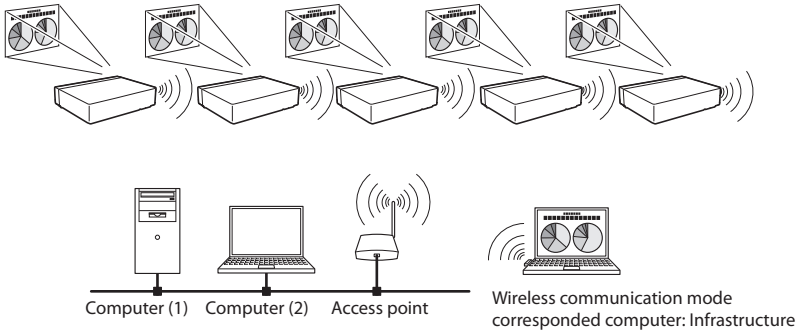

■ Wireless LAN, AdHoc Communication Mode

Communication mode between Wireless LAN equipment.
(Communication mode via SSID/ESSID)

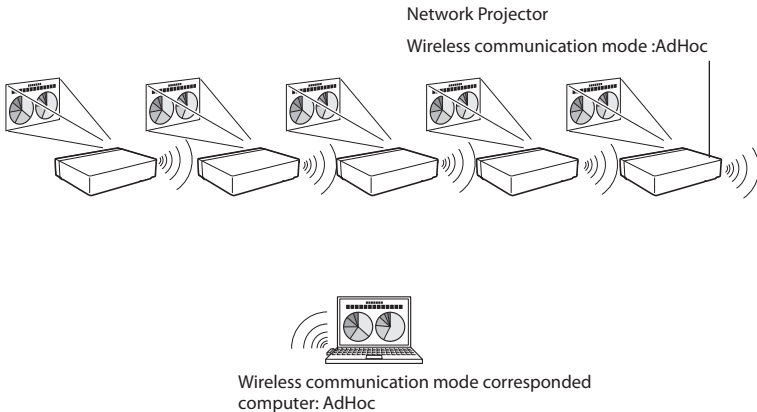

■ Wired LAN Communication Mode

Communicate via the LAN line.

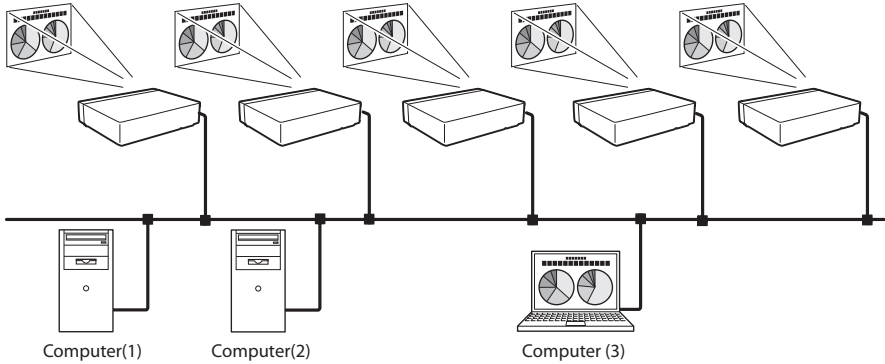

*** Operate the computer mouse with the remote control.**

When the projector's remote control employs mouse operating function, you can operate the computer by the remote control. To use the remote control, point to the projector. You do not need to connect the USB cable to operate the computer mouse.

2. Setup procedures

This chapter describes how to install the Network Capture 5 software and how to set up the networks.

To use the projector via the networks, follow the setup procedures below.

STEP 1 Install the software on computers.



Install the software recorded in CD-ROM on each computer which will be operated. Read following pages of this chapter to install.

STEP 2 Select Wired LAN or Wireless LAN then connect the LAN and set the configuration.



Decide depending on the LAN environment.

Wired LAN..... Refer to "4. Wired LAN Configurations" (pp.27–34).

Wireless LAN..... Refer to "5. Wireless LAN Configurations" (pp.35–46).

Detailed LAN configurations need to be done with a browser later.

First, complete the Wired or Wireless LAN connection between computers and projectors, then start browser configurations.

→ "6. Basic setting and operation" (pp.47–66).

STEP 3 Network Configuration has completed.

Follow each chapter to project an image and operate the projector.

■ Operate and manage the projector → "7. Controlling the projector" (pp.67-88)

→ "Power Control and status check" (p.68)

→ "Controls" (p.70)

→ "PC adjustment" (p.74)

→ "Setting up the projector" (p.75)

→ "Timer setting" (p.78)

→ "Projector information" (p.81)

→ "Multi-control" (p.83)

■ Project an image on the computer → "8. Network capture functions" (pp.89-110)

→ "Use of real time capture" (p.93)

→ "Use of network communication" (p.98)

→ "Moderator function" (p.107)

■ Project an image on a network server → "9. Network Viewer functions" (pp.113-131)

→ "Create the available data" (p.114).

→ "Create the program files" (p.119).

→ "Project the image with network viewer function" (p.124)

* Even if Network Capture 5 is not installed into the computer, the wireless LAN can be set up with USB memory. (p.97)

Installing the software

It is required to install the software into your computer to use the Network Capture function . Please install the software as follows.

Note: To install the software into the computer with Windows 2000, Windows XP or Windows Vista, you should logon as administrator. Before installation, make sure that the other applications are closed, otherwise proper installation cannot be made.

Network Viewer & Capture 5 installation

1 Set the supplied Network Viewer & Capture 5 CD-ROM into the CD-ROM drive of your computer. Double click **SetupTool.exe** icon in the "Tool" folder in the CD-ROM.

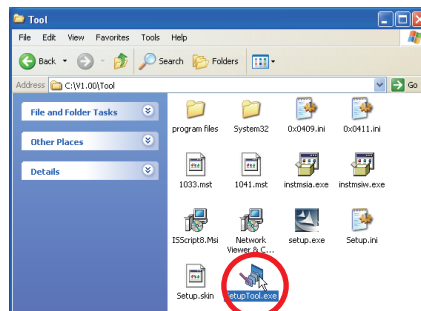
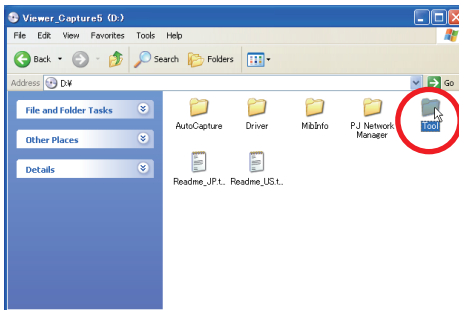

2 Select "English [United States]" from the pull-down menu on the "Choose Setup Language" window and click **OK** button to start installing and then follow the installation wizards.

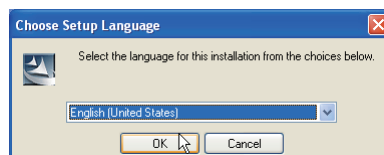

As the "License Agreement" will appear, read contents carefully and click **Yes** button if you agree to the license agreement to proceed with installing.

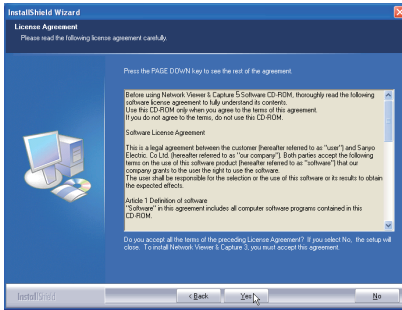

During the installation, following window may appear, click **Continue Anyway** button.

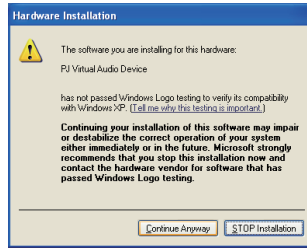

3 Click **Finish** to complete the installation.

Installed software

The following 3 softwares are installed on your computer.

- **Network Capture 5:**

Captures the displayed image and the sound of the computer and serves them to the projector via the network.

- **Network Viewer 5 (File Converter 1):**

Converts to the JPEG*1 data format which can be projected with the projector from the JPEG, bitmap and Power Point files.

- **Network Viewer 5 (Program Editor) :**

This is a tool to make the program which has a function to specify and order the projecting JPEG image data stored in the file servers.

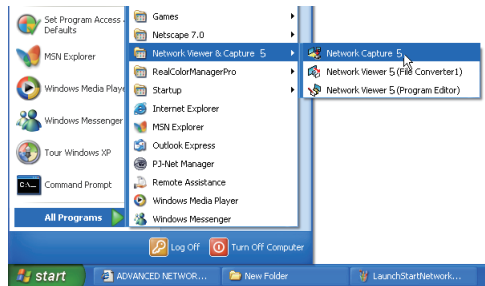
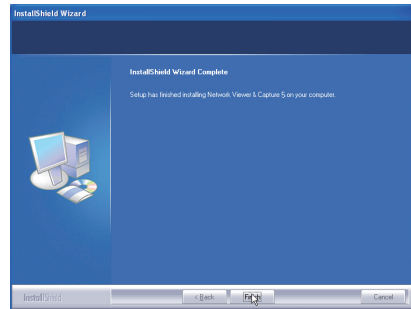

* To uninstall these software, use "Add/Remove Program" from the control panel.

*1 This product supports the JPEG image format. This file is needed to convert to the optimized JPEG file by using the File Converter 1 software previously. Refer to the item "Creating the available data [Network Viewer 5]"(ear.p.114) about data converting for the projection.

File Converter 2 installation

- 1 Set the supplied Network Viewer & Capture 5 CD-ROM into the CD-ROM drive of your computer. Double click **SetupDrv.exe** icon in the "Driver" folder in the CD-ROM.
- 2 Select "English [United States]" from the pull-down menu on the language selection window and then click **Install** button to start installing.

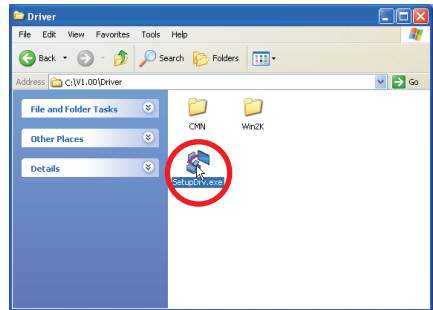
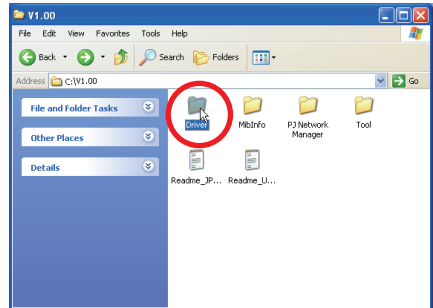
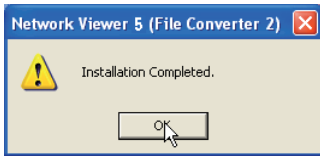
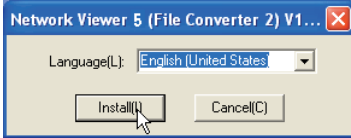

Installed software and places

Network Viewer 5 (File Converter 2) is installed in the "Printers and Faxes" folder in the "Control Panel".

● Network Viewer 5 (File Converter 2):

This is a kind of the printer driver to convert to the JPEG data optimized to project by the projector from any of the documents created by the application software.

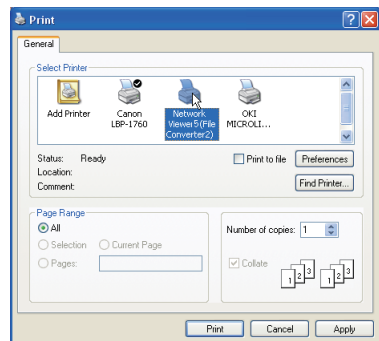

* To uninstall Network Viewer 5 (File Converter 2), just delete the "Network Viewer 5 (File Converter 2)" icon from the "Printers and faxes" folder.

Installation of Driver for USB display

It is required to install the software into your computer to use the USB display function . Please install the software as follows.

1. Select "Display" in the "USB terminal" from the setting menu of the projector.
2. Select "USB Display" with the Point ▲▼ buttons and press SELECT button. Then the Menu will disappear, the "Please wait..." message will appear, and switching operation will start. Switching will take a while and after completing the operation, the "Ready for use" message will appear.
3. Connect the computer to the projector with a USB cable.
4. New Hardware is detected and then "Found New Hardware Wizard" window will be displayed. Select "No, not this time" and click Next button.



5. Set the supplied Network Viewer & Capture 5 CD-ROM into the CD-ROM drive of your computer. (If your computer does not provide the CD-ROM drive, insert the supplied USB memory into your computer.) Select "Install from a list or specific location" and click Next button.

6. Select "Search for the best driver in these locations", check 2 boxes, and then click **Browse** button, and select "USB Driver" folder in the CD-ROM or USB memory, and click **OK** button to proceed with installing.

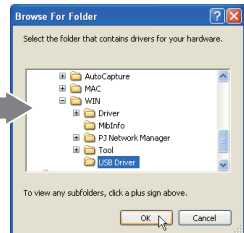
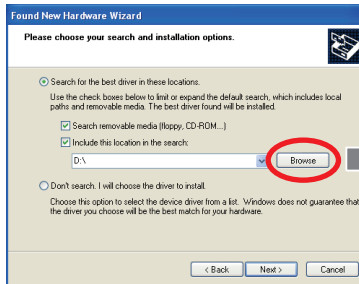

7. During the installation, following window may appear, click **Continue Anyway** button.

8. Click **Finish** to complete the installation.

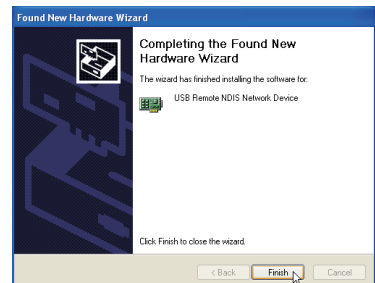
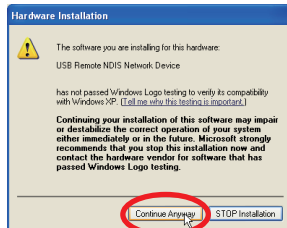

☞ You can find out "USB Driver" folder is in "WIN" folder in the CD-ROM or the root directory of the supplied USB memory.

3. Names and functions of the operation screen

This chapter describes the functions of each part of the operation screen.

Network connection standby display

Turn on the projector and select either “Wired” or “Wireless” from the input menu of the projector. The “Please wait...” message will be displayed on the screen. After short time, the network connection standby display screen will appear as below. While the “Please wait...” message is shown, some operations are invalid.

Network Connection Standby Display



Network Capture 5 window

This software is to project the computer screen via the networks.

Select "All Programs" from the start menu --> Network Viewer & Capture 5" --> "Network Capture 5", then following screen will appear. Then the program will start.

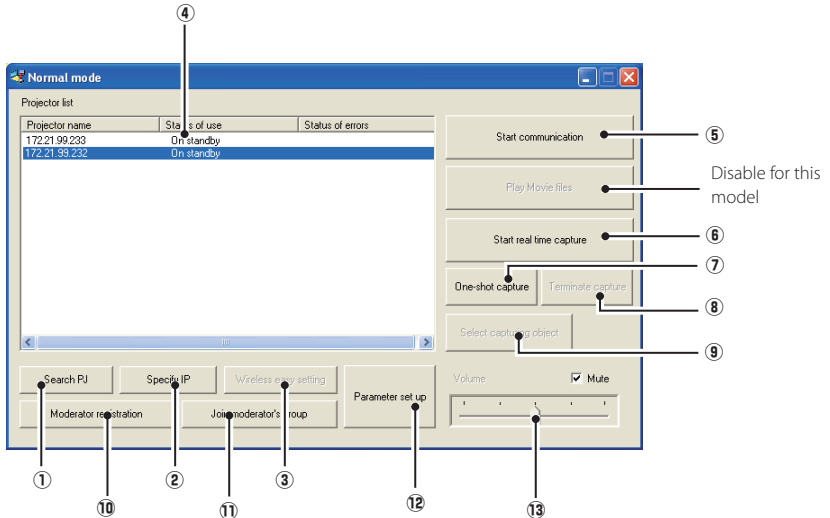

Parts Names and Functions of the Screen

① Search PJ button

Search the projector connected to the networks.

② Specify IP button

When connected to a different segment network, the projector can not be retrieved automatically. In that case, press this button, the "Search specified IP address list" window appears, and then click Add button and enter the IP address directly to specify the projector in another window. The registered multiple IP addresses can be searched at a time.

③ Wireless easy setting button / Wireless easy release button

Configure the Wireless LAN setting just by clicking this button. (The setting will be stored as AdHoc system) For details, refer to "5. Wireless LAN configurations"-->"Easy wireless setting" (p.43). To restore the easy setting, press the Wireless easy release button.

④ Network Projector List

Display all the projectors connected to the networks.

Show unoccupied projector as "On standby" and occupied projector as "Real time capturing" or "In One-shot mode". When registered in a moderator's group, "On Moderator mode" will be shown. The indication of the status of use with "#" indicates that your computer is now using the network capture function. After double-clicking on a projector name, the web browser gets activated and the projector setup screen will be displayed.

⑤ **Start communication button**

Enter the Communication mode, and then , the capture edit window starts. The selected projector shows the capture edit window.

⑥ **Start real time capture button**

Capture (Project) the computer screen in real time. After the execution of "Start real time capture", the application window disappears. ... ❖

⑦ **One-shot capture button**

Copy and capture (project) the computer screen without modification. After the execution of One-shot capture, the application window disappears. ... ❖

⑧ **Terminate capture button**

Terminate the real time capture and the One-shot capture.

⑨ **Select capturing object button**

It is possible to designate the window to capture individually. This button is disabled by default, so the full screen is captured. It is possible to change the capturing object function setting at parameter settings. For detail, refer to "Parameter set up" (p.92).

⑩ **Moderator registration button**

Register a computer user as a moderator.

⑪ **Join moderator's group button**

Join the moderator's group which is selected in the Network Projector list. It is not available if there is no moderator registered.

⑫ **Parameter setup button**

Activate the parameter setup window, and execute the connections setting, the image setting, and the moderator's function setting. For detail, refer to "Parameter set up" (p.92).

⑬ **Volume adjust slider and Mute check box**

Adjust the audio output from the real time capturing computer. The mute check box is checked by default.

❖ To show the application window again, refer to the item "Commands on the task bar" (p.91).

Note on Windows Vista

When you use the Network Capture 5 software with Windows Vista, the warning dialog "User account control" will appear. In that case, click **Allow** button to use it.

Using the multiple network adaptors

When your computer provides multiple network adaptors, the network adaptor selecting window will appear each time the Network Capture 5 software starts. Select a network adaptor and check the "Set network adaptor as default" and then click OK. To change the setting, refer to the item "Parameter set up" (p.92).

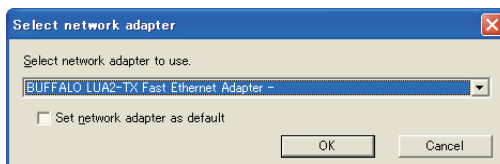

4. Wired LAN configurations

This chapter describes the preparation for Wired LAN setting with projectors and how to set the LAN environment.

Setting procedures and contents differ depending on the LAN installation location. When installing, consult your system administrator to set up the LAN appropriately.

Connecting to the LAN line

Connect the shielded LAN cable to the LAN connection terminal of the projector.

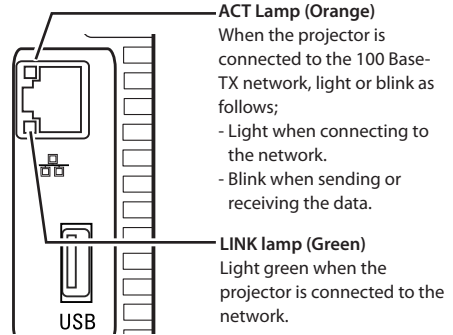
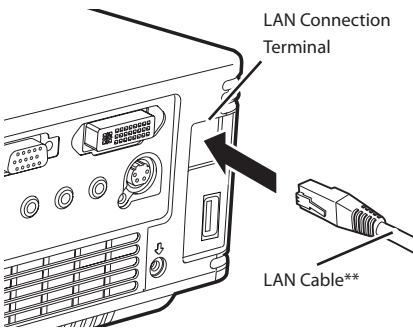

ACT Lamp (Orange)
When the projector is connected to the 100 Base-TX network, light or blink as follows;
- Light when connecting to the network.
- Blink when sending or receiving the data.

LINK lamp (Green)
Light green when the projector is connected to the network.

** Please use a shielded LAN cable .

Network environment settings

Set the Wired LAN network through the projector menu. Detailed network settings will be made with browser. Refer to "6. Basic setting and operation" (p47-66). First, complete the settings described in this chapter before performing steps in "6. Basic setting and operation."

Setting Procedure

1. Turn on the projector and select "Network" from the input menu of the projector.
2. Select "LAN mode select" in the Network menu, and press Point ► or SELECT button.
3. Select similar LAN environment among Wired1, 2 and 3 with the Point ▲▼ buttons. Then the Menu will disappear, the "Please wait..." message will appear, and switching operation will start. Switching will take a while and after completing the operation, the "Ready for use" message will appear, and the projector's LINK/ACT Lamp will be on or blink.

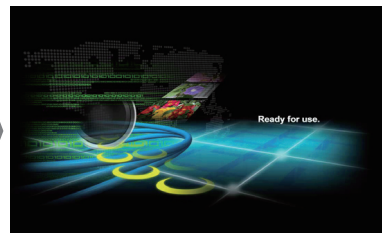
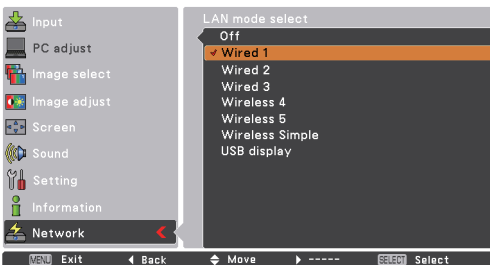

- Select "Network setting" in the Network menu and press **SELECT** button, and then the LAN setting screen will appear and selected LAN settings will be displayed. Adjust each item to the setting environment. Consult your system administrator about the detailed settings.
Move among the items with the Point ▲▼ buttons and press **SELECT** button, move among the columns with Point ◀▶ buttons, adjust the figures with Point ▲▼ buttons, and then press **SELECT** button to set.
- After completing all the settings, select "Set" and press **SELECT** button. Now, all procedures have been done. To cancel the adjusted settings, select "Cancel" and press **SELECT** button.
To confirm whether the settings are correct, follow the procedures described from the next page.
You can confirm the LAN settings you have made from "Network Information" (p.32). In such cases that the LAN cannot be connected, see this screen.

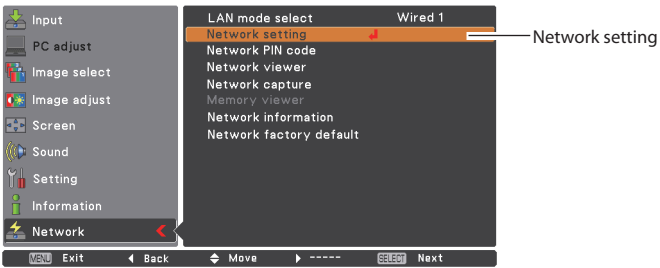

DHCP: On

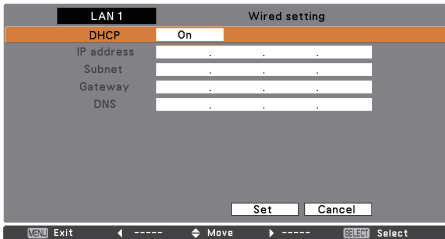

DHCP: Off

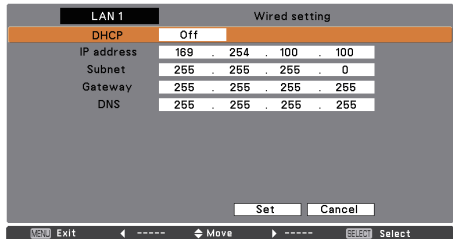

Item	Description
DHCP	Sets DHCP function On or Off. When you setup the network setting manually, select "Off". When it is set On, IP address, Subnet, Gateway and DNS are automatically set according to your network environment *1.
IP address	Sets IP address of the projector
Subnet	Sets Subnet mask. Normally sets 255.255.255.0
Gateway*2	Sets IP address of the default gateway (Router)
DNS*3	Sets IP address of the DNS server.

*1 Set "On" only when the DHCP server is available on your network environment.

*2 Set [255.255.255.255] if the network does not provide the gateway (router).

*3 Set [255.255.255.255] if you do not use the function E-mail alert.

* While the network communication function (p.98) or moderator function (p.107) is to be executing, the menus "Network capture", "Network viewer" and "Memory viewer" are displayed in gray.

Confirming the operation

Confirm that the projector has connected to the LAN properly.

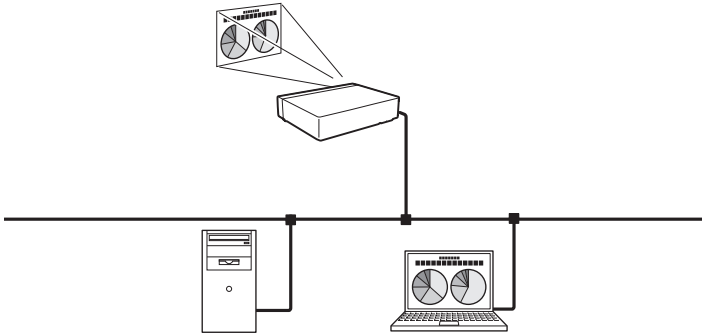

1. Activate "Network Capture 5" which is installed into the computer connected to the LAN .
2. After "Searching projector" message appears, the name of the projector* appears on the Network Projector List, then the network setting has completed properly.

When the name of the projector does not appear and error screen appears, the network has not connected yet. Try searching again with the **Search PJ** button. If error screen appears again, reconfirm the LAN setting. When the projector is set in the location separated by the router, see next page.

When Firewall function (Anti-virus software) is effective, network projector may not be found. In that case, disable the Firewall function and try searching again.

* If the projector is named, the name will be displayed. The name can be set with the following procedures in "6. Basic setting and operation" → "Initial setting" (p52) . If the projector is not named, IP address of the projector will be displayed.

Network Capture screen

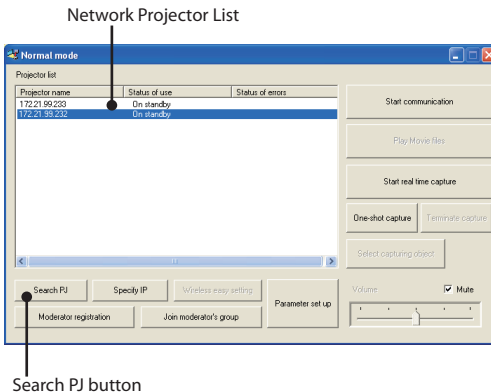

When set up the projector in the location separated by the router and the segment is different; Projector will not be found nor displayed. In that case, the projector needs to be searched directly by the IP address.

1. Press **Specify IP** button. "Search specified IP address" window appears.
2. Click **Add** button, "IP address set up" window appears. Enter the IP address of the projector and Click **OK** button. Then, the projector will be added on the "Search specified IP address" window. Multiple projectors are registered and they are stored even when the application is closed.
3. Click **OK** button on the "Search specified IP address" window, the registered multiple projectors will be searched. Then, the projector will be added on the Network Projector List of the application window.

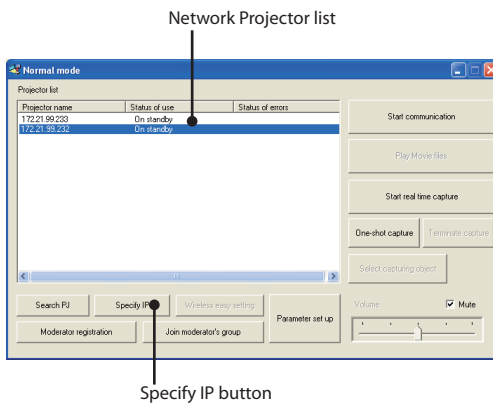

"Search specified IP address" window

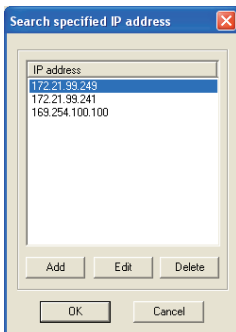

"IP address set up" window

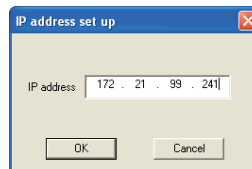

Network PIN code

The Network PIN code is to restrict the access from the networks to the projector.
After setting the Network PIN code, you need to enter it to operate the projector via the networks.

1. Select "Network PIN code" in the Network menu, and press **SELECT** button.
The Network PIN code screen will appear.
2. Set the Network PIN code.

Set the figures with the Point ▲▼ buttons and move to the next items with the Point ◀▶ buttons. Select "Set" and press **SELECT** button to set. To cancel the preset Network PIN code, select "Cancel". When you do not want to set the Network PIN code, set 0000.

It is recommended to set the Network PIN code if you use the projector via the networks. The Network PIN code can be set also through the networks. See "6. Basic setting and operation" → "Initial setting" → "Network PIN code setting" (p53).

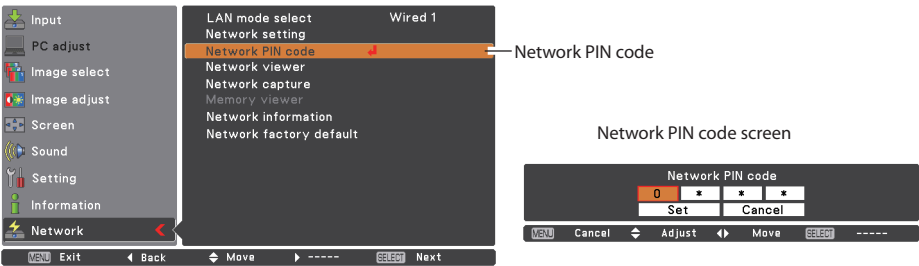

Network information

Select "Network information" in the Network menu and press Point ▶ or **SELECT** button to show LAN setting environment of the currently selected projector. (The description below is an example and different from what will be shown.)

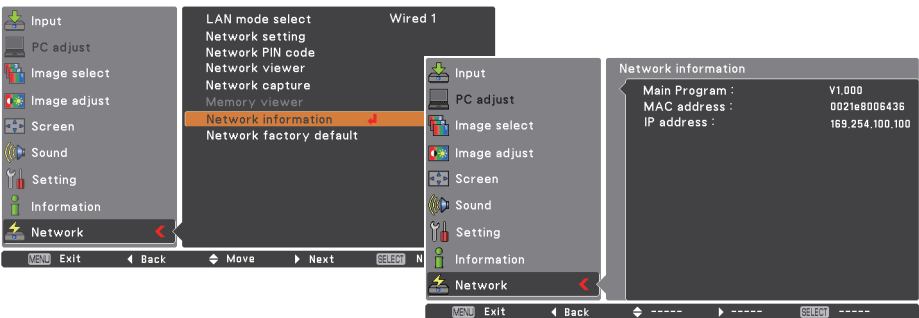

Wired factory default

Select "Wired factory default" in the Network menu and press **SELECT** button. All the wired LAN settings will go back to the factory default settings as shown below table.

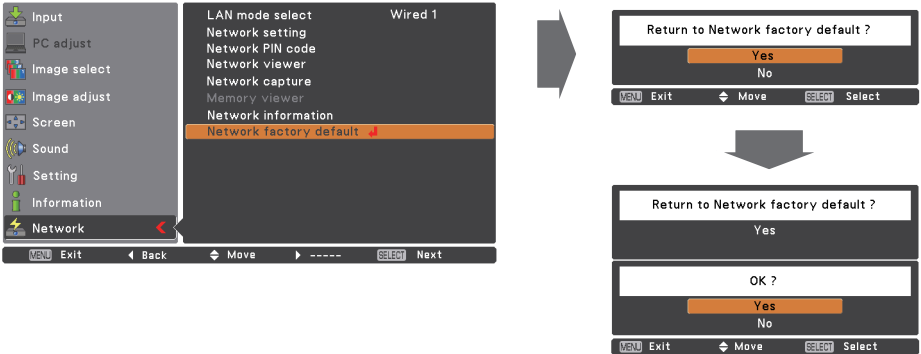

Wired LAN factory default settings

Parameter	SELECTED LAN		
	Wired 1	Wired 2	Wired 3
DHCP	OFF	ON	OFF
IP ADDRESS	169.254.100.100	192.168.100.100	192.168.100.100
SUBNET MASK	255.255.0.0	255.255.255.0	255.255.255.0
GATEWAY ADDRESS	255.255.255.255	255.255.255.255	255.255.255.255
DNS ADDRESS	255.255.255.255	255.255.255.255	255.255.255.255

USB Display

The image and sound are sent to the projector by connecting the computer to the projector with a USB cable.

1. Select "Display" in the "USB terminal" from the setting menu of the projector.
2. Select "USB Display" with the Point ▲▼ buttons and press SELECT button. Then the Menu will disappear, the "Please wait..." message will appear, and switching operation will start. Switching will take a while and after completing the operation, the "Ready for use" message will appear.

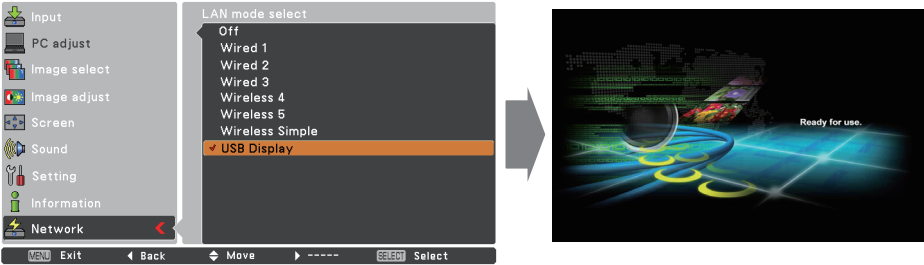

3. Connect the computer to the projector with a USB cable.
4. Start up "Network Capture 5" in the computer, then the screen image of the computer will appear on the projected screen in real time. (At this time, the input mode is switched to "USB display" automatically.) To terminate the real time capturing, press **Terminate capture** button in the **Network Capture 5** window or in the task bar.

-
- ☞ When "Mouse control" is selected in "USB terminal" of "Setting" menu, "USB display" cannot be selected.
 - ☞ "Mouse control" is selected in "USB terminal" at using "USB display" function, LAN mode will be switched from "USB display" to "Wireless simple" automatically.
 - ☞ When "USB display" is selected and USB cable is connected between the computer and the projector, and then starting up "Network Capture 5" in the computer, the input mode will be switched from any input to "Network" and the screen image of the computer will be projected automatically.
 - ☞ A USB cable should be connected directly between the projector and the computer. "USB display" function may not operate with connecting via a USB hub or a USB switching unit.

5. Wireless LAN configurations

This chapter describes the preparation for Wireless LAN setting with projectors and how to set the LAN environment.

This projector contains the Wireless LAN module.

The setting procedures and configurations differ depending on the LAN installation location. Consult your system administrator for installation and set the LAN appropriately.

To operate via Wireless LAN, your computer has to be equipped with a Wireless LAN card adapter which supports IEEE 802.11b/g/n.

If connecting in Infrastructure mode with an access point, the access point is required to support IEEE 802.11b/g/n.

Caution: Do not use a mobile phone or PHS near (within 20cm/8inch) the projector. It may cause malfunction.

Setting the network environment

The projector contains the Wireless LAN adapter.

Set the Wireless LAN network through the projector menu.

Detailed network settings will be made with browser. Refer to "6. Basic setting and operation". → "Network configuration" (p.55). Complete the settings described in this chapter before performing the steps in "6. Basic setting and operation."

Setting procedures

1. Turn on the projector and select "Network" in the Input menu of the projector.
2. Select "LAN mode select" in the Network menu, and press Point ► or **SELECT** button.
3. Select similar LAN environment among Wireless 4, Wireless 5 and Wireless Simple* with the Point ▲▼ buttons. Then the Menu will disappear, the "Please wait..." message will appear, and switching operation will start. Switching will take a while and after completing the operation, the "Ready for use" message will appear.
For each settings, refer to "Wireless LAN factory default settings" on page 46.

*"SIMPLE" mode is used for simple setting without complicated LAN setting procedures to connect to the Wireless LAN. See "Easy wireless setting" (p.43) for details.

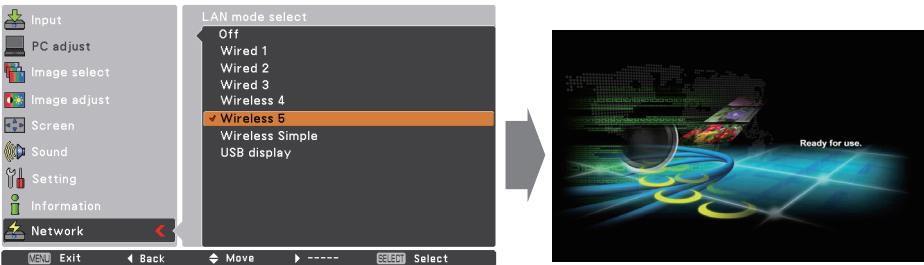

4. Select "Network setting" in the Network menu and press **SELECT** button, and then the LAN setting screen will appear and the selected LAN settings will be displayed. Adjust each item to the setting environment. Consult your system administrator for the detailed settings.
Move among the items with the Point ▲▼ buttons and press **SELECT** button, move among the columns with Point ◀▶ buttons, adjust the figures with Point ▲▼ buttons, and then press **SELECT** button to set.
When the network type is "AdHoc", you do not have to change "Sub net" and "Gateway" and leave them as default settings.
SSID/ESSID for the network type "Infrastructure" and "AdHoc" are required to be entered the same characters into the projector, the access point, and the Wireless LAN compatible computer (up to 32 characters). Characters can be selected from A~Z, a~z, blank (space), 0~9, or - (hyphen) with the Point ▲▼ buttons. Move to the next character with the Point ◀▶ buttons.

5. After completing all the settings, select "Set" and press **SELECT** button. Now, all procedures have been done. To cancel the adjusted settings, select the "Cancel" and press **SELECT** button. If you want to set the security, select "Next" and press **SELECT** button to proceed to the security setting window and refer to the following pages in detail.

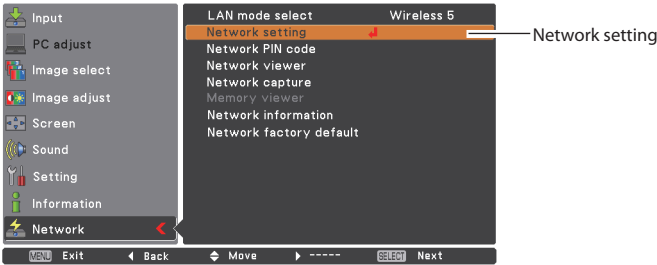

DHCP: On

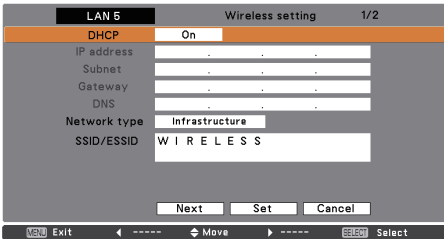

DHCP: Off

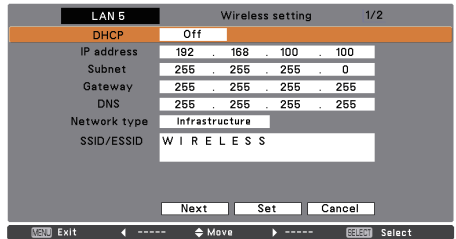

For configuring of WEP, WPA-PSK, WPA2-PSK security, select "Next". Refer to "Configuring security with the projector" on next page for details.

Item	Description
DHCP.....	Sets DHCP function On or Off. When you setup the network setting manually, select "Off". When its set On, IP address, Subnet, Gateway and DNS are automatically set according to your network environment *1.
IP address	Sets IP address of the projector
Subnet.....	Sets Subnet mask. Normally sets 255.255.255.0
Gateway*2.....	Sets IP address of the default gateway (Router)
DNS*3.....	Sets IP address of the DNS server. Must be set when the E-mail function is used.
Network type	Sets Infrastructure or AdHoc mode. When the "AdHoc" is selected, the security "WPA-PSK" and "WPA2-PSK" are not available.
SSID/ESSID.....	Identifier of the wireless access point.

You can confirm that the projector settings from "Network Information" in the projector menu (p.44) To confirm whether the settings are correct, follow the procedures in "4. Wired LAN configurations" → "Confirming the Operation" (p.30).

*1 Set "On" only when the DHCP server is available on your network environment.
 *2 Set [255.255.255.255] if the network does not provide the gateway (router).
 *3 Set [255.255.255.255] if you do not use the function E-mail alert.
 * While the network communication function (p.98) or moderator function (p.107) is to be executing, the menus "Network capture", "Network viewer" and "Memory viewer" are displayed in gray.

Configuring security with the projector

Configure security with the projector by following the steps below.

After configuring the network in "5. Wireless LAN Configurations" (p.35-46), select "Next" in the LAN setting screen and press **SELECT** button. The security configuration screen appears. Refer to "6. Basic setting and operation" → "Configuring wireless LAN setting and security setting" (p.57) as well.

WEP configuration screen



Use the Point ▲▼ buttons to select the security type. To disable the security, select "Disable."

Use the Point ▲▼ buttons to move among the items and adjust setting; use the Point ◀▶ buttons to move among the character positions of the key entry fields.

This projector provides the following security options. Use optimum security option on your network environment.

- WPS Push Button
- WPS PIN code
- WEP64(40)bit Open
- WEP64(40)bit Share
- WEP128(104)bit Open
- WEP128(104)bit Share
- WPA-PSK(TKIP)
- WPA2-PSK(AES)

Notes when entering characters:

The "¥" symbol is displayed as "\" when the ASCII key is used. The "*" symbol is treated as a character by the ASCII key, but it is not interpreted as a character by the HEX key. In HEX, the "*" symbol is displayed in red and setting is denied.

You can not set all the characters with the "*" symbol. This will be considered as no operation.

ASCII key characters : Space - 0 to 9 A to Z a to z ! " # \$ % & ' () * + , . / : ; < = > ? @ [¥] ^ _ ` { } ~

HEX key characters : 0 to 9 a to f

Use of security type "WPS"(Wi-Fi Protected Setup)

By using WPS (Wi-Fi Protected Setup), the communication via ESSID and WPA2 security type between the Wireless LAN access point and the projector can be configured without complicated setting procedures.

There are 2 ways; "WPS Push Button" which is pressed each button of the wireless LAN access point and the projector to setup and "WPS PIN code" which is input eight-digit number, which is set to the projector, to the wireless LAN access point to setup.

WPS Push Button
configuration screen

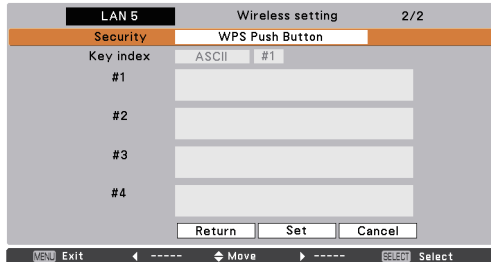

WPS Push button

1. Select "WPS Push Button" in "Security" Menu, and press SELECT button. Use the Point ▲▼ buttons to select "Set" and "WPS Push Button" will be active by pressing the SELECT button.
2. Press "WPS" button of access point after starting the operation of "WPS Push Button" within 2 minutes. For the operating instructions of access point, refer to the manual of access point. When the setting of "WPS" of the access point is completed, the communication will start between the access point and the projector and WPS auto-setting process of the projector will be performed. During the auto-setting process, "Please wait ..." message will appear.
3. When the auto-setting process is completed, "WPS Push Button OK" message will appear. After the auto-setting process is completed, security items except "WPS Push Button" are displayed in grayout and cannot be changed. Confirm the auto-setup IP address and ESSID in "Network information". If the auto-setup process is not succeeded, "Failed in WPS setting. Please reset" message will appear and "Security" items will return to "Disable".

WPS PIN code

1. Select "WPS PIN code" in "Security" Menu, and press SELECT button. Use the Point ▲▼ buttons to select "Set" and "WPS PIN code" will appear by pressing SELECT button.

WPS PIN code configuration screen

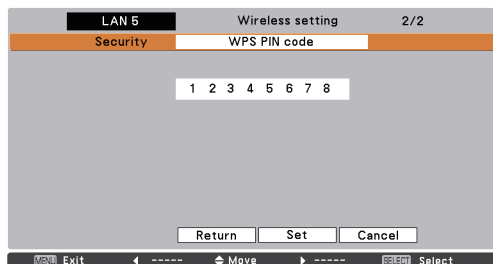

2. Configure the eight-digit number of "WPS PIN code" which is displayed to the access point according to the instructions manual of the access point. And then select "Set" and press SELECT button within 2 minutes after configuration of the access point.

The communication will start between the access point and the projector and the WPS auto-setting process of the projector will be performed. During the auto-setting process, "Please wait ..." message will appear.

3. When the auto-setting process is completed, "WPS PIN code OK" message will appear.

After the auto-setting process is completed, the security items except "WPS PIN code" are displayed in grayout and cannot be changed. Confirm the auto-setting IP address and SSID in "Network information". If the auto-setting process is not succeeded, "Failed in WPS setting. Please reset." message will appear and the "Security" item returns to "Disable".

☞ When there is plural access points, WPS PIN code sets the connection vis-a-vis the access point whose the radio wave strength is strongest. So, when setting WPS PIN code, please set the projector in the vicinity of the access point which you want to connect. If the setting with WPS PIN code is not succeeded, please try the setting with WPS Push button.

Use of security type "WEP"

1. Use the Point ▲▼ buttons to select "WEP" security type.
2. Select "Key index". Use the Point ▲▼ buttons to choose the HEX or ASCII key. The four (#1–#4) kinds of WEP keys can be configured. Use the Point ◀▶ buttons to move to the right frame; use the Point ▲▼ buttons to select a WEP key number (#1–#4).

WEP configuration screen

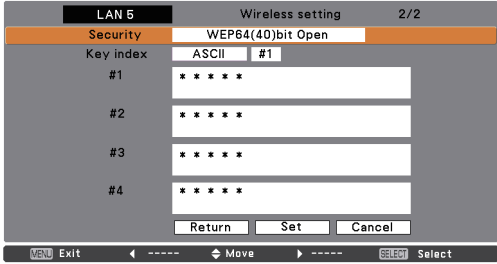

Refer the table below for the usable number of characters at the WEP security option.

WEP option	Characters
WEP64(40)bit ASCII	5 characters
WEP64(40)bit HEX	10 characters
WEP128(104)bit ASCII	13 characters
WEP128(104)bit HEX	26 characters

3. Use the Point ▲▼ buttons to select the Type field of the WEP key number that corresponds to the one you selected above and press **SELECT** button. The WEP key entry screen appears. In the WEP key entry field, all characters are displayed in "*". Use the Point ▲▼ buttons to select a character; use the Point ◀▶ buttons to select a character position. Enter all the characters displayed with "*".
When you select HEX at WEP key index and the entry key contains "*", the "*" symbol is displayed in red and setting is denied.
4. Use the Point ▲▼ buttons to select "Set" and press **SELECT** button to return to the Wireless setting screen. Select "Set" in the Wireless setting screen to complete the network setting.

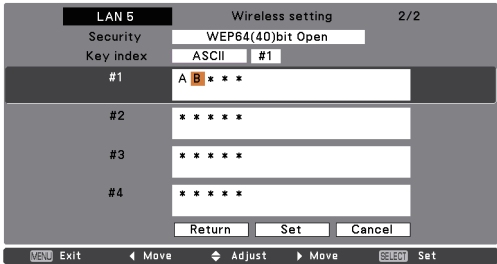

Use of security type "WPA-PSK", "WPA2-PSK"

1. Use the Point ▲▼ buttons to select "WPA-PSK" security type.

WPA-PSK(TKIP)
configuration screen

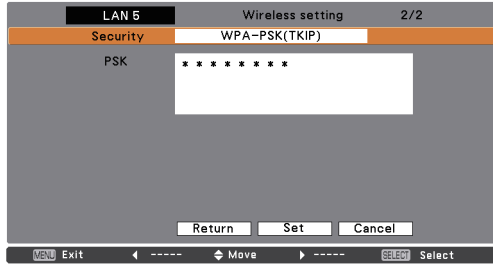

2. Use the Point ▲▼ buttons to select the key field and press **SELECT** button. The PSK key entry screen appears. Enter the PSK key by using the Point buttons. If the input PSK key has an error, the PSK key is indicated in red.

3. Use the Point ▲▼ buttons to select "Set" and press **SELECT** button to complete the network configuration, and return to the "Network setting" in the Network menu.

Available PSK key characters

ASCII code.....8 to 63 digits
Hex code.....64 digits

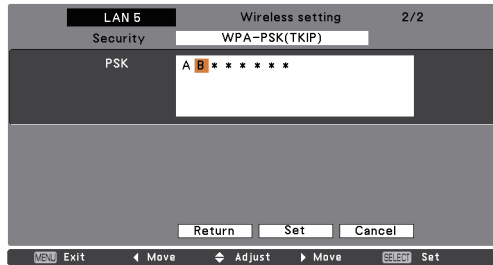

* Security "WPA-PSK" and "WPA2-PSK" modes are not available when the "AdHoc" network type is selected.

* When you set the PSK keys with 64 digits, the projector checks whether all of the entered PSK keys are in Hex code or not. If any of the ASCII code is included in the entered PSK keys, the entered PSK keys are indicated in red as error.

Easy wireless setting

With this setting, you do not need any complicated LAN setting procedures.
The network type will be AdHoc mode.

CAUTION: This function can be used only when logged in by Administrative right with Windows XP and Windows Vista, and cannot be used with Windows 2000.
Windows XP should be Service Pack 1 or later version.

Setting Procedures

1. Turn on the projector and select "Network" in the Input menu of the projector.
2. Select "LAN mode select" in the Network menu, and press **SELECT** button.
3. Select "Wireless Simple" with the Point ▲▼ buttons. Press **SELECT** button then the "Please wait..." message will appear and switching operation will start. Switching will take a while and after completing the operation the message "Ready for use" will appear. During the switching period, the projector cannot be operated. ("SIMPLE" LAN settings will be shown by pressing **SELECT** button. The settings cannot be changed.)
4. Activate "Network Capture 5" which is installed in the computer.
5. Click **Wireless easy setting** button on the operation screen. The Wireless LAN setting screen will appear and the computer will start to set up the Wireless LAN setting. (Adjust the computer's Wireless LAN environment to the "SIMPLE" setting LAN environment.)

After completing the settings, the computer will start searching the projector which was set as "SIMPLE" and will display the name of the projector or the IP address on the projector list.

Confirm whether the LAN has been set correctly and works properly. Refer to "4. Wired LAN configurations" → "Confirming the operation" (p.30) for the confirmation procedures.

If the network setup is not succeeded, the error screen will appear.

Setting screen

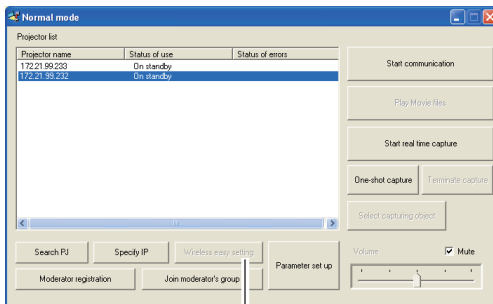

Wireless easy setting button

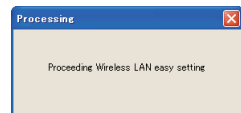

Error Screen

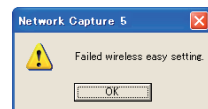

Computer environment and Wireless LAN connection;

Wireless LAN with Wireless Easy setting connection will be made via AdHoc mode. For setting contents, refer to "Wireless LAN factory default settings" (p.46).

With the Easy setting, computer's LAN environment setting will be switched to the setup environment. Because of that, the LAN cannot work for the other operation while using "Network Capture 5".

After terminating the application or pressing the Wireless Easy Setting button, the LAN environment will automatically go back to the previous state.

Network PIN code

The Network PIN code is to restrict the access from the networks to the projector.

After setting the Network PIN code, you need to enter it to operate the projector via the networks.

Select "Network PIN code" from the projector menu and press **SELECT** button. Set with the same procedures as setting Wired LAN Network PIN code. Refer to "4. Wired LAN Configurations" → "Network PIN code" (p.32).

Network information

Display the current LAN connecting environment. Select "Network Information" from the projector menu and press **SELECT** button.

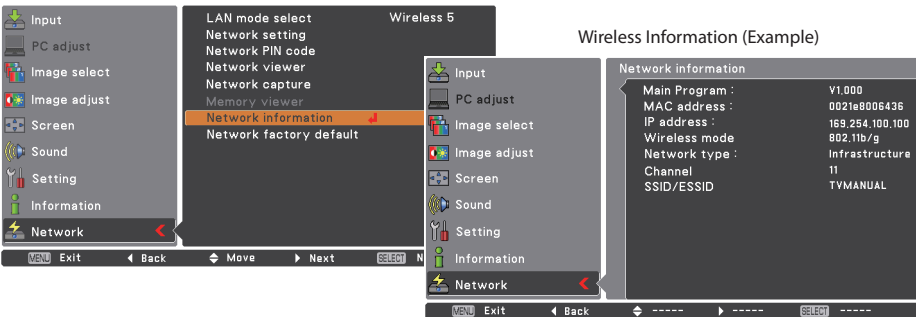

Wireless factory default

Select "Network factory default" in the Network menu (p.33) and press **SELECT** button. All the wireless LAN settings will go back to the factory default settings. For details, refer to "Wireless LAN factory default settings" (p.46).

WIRELESS indicator display

When the wireless LAN configuration is set up correctly and the wireless communication is established with the access-point or computer in the network, the WIRELESS indicator on the front panel lights up. When sending or receiving of data, it blinks.

Even though the wireless LAN in the network menu is selected, the WIRELESS indicator does not light, in this case, the wireless LAN configuration is not set up correctly, and please check the setting of the projector.

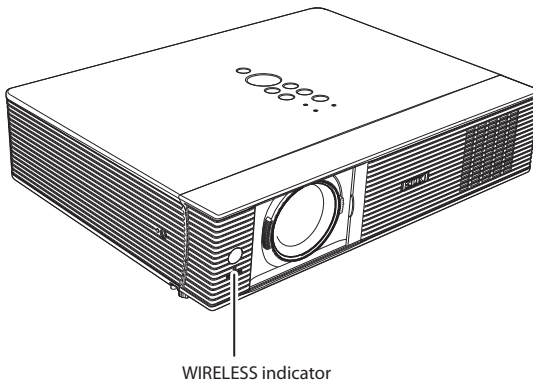

Wireless LAN factory default settings

Factory default settings for Wireless 4, Wireless 5, and Wireless Simple as follows.

Setting Items	Selected LAN		
	Wireless 4	Wireless 5	Wireless Simple
DHCP	OFF	ON	OFF
IP ADDRESS	169.254.100.100	192.168.100.100	169.254.*.*
SUBNETMASK	255.255.0.0	255.255.255.0	255.255.0.0
GATEWAY ADDRESS	255.255.255.255	255.255.255.255	255.255.255.255
DNS ADDRESS	255.255.255.255	255.255.255.255	255.255.255.255
WIRELESS CHANNEL	11	11	11
WIRELESS MODE	802.11b/g/n	802.11b/g/n	802.11b/g/n
NETWORK TYPE	AdHoc	INFRASTRUCTURE	AdHoc
WIRELESS SSID/ESSID (SSID/ESSID)	PJ-WIRELESS5	ANY	PJ-WIRELESS5
SECURITY (Encryption)	DISABLE	DISABLE	DISABLE

6. Basic setting and operation

Describes basic operation and settings below by using the web browser.

- Initial setting
Setup the basic setting such as Projector name, Network PIN code, Time setting, etc.
- Network setting
Configure Wired/Wireless LAN environment.
- E-mail Setting
Configure E-mail function to manage the projector.
- SNMP Setting
Configure SNMP function to manage the projector.

Caution: When operating the projector with the browser, connect the projector to the computer with Wired or Wireless LAN. Complete the connection in advance.

Starting up the Browser

1. Turn on the projector.
2. Start up the Network Capture 5. The Network Capture 5 searches projectors in the network and lists up the IP address or projector name of the projector on the Network Projector List.
3. Double click the projector to set from the Network Projector List.
4. The web browser will start up and display the setting page of the projector.

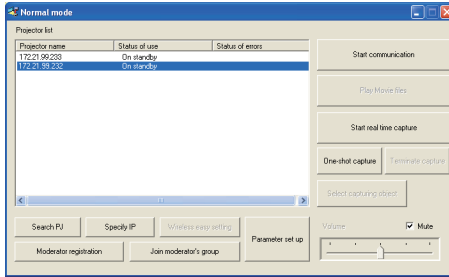

Select a display mode and login

This product provides 2 types of control mode, Standard Mode and Light Mode as below. Select a proper mode to match your PC and network environment by clicking on the text link. Once you select your desired display mode, the setting page you selected display mode will be displayed automatically from the next login. To change the display mode, click "Top" on lower-right corner of the setting page (p.49).



STANDARD MODE

For computer display, displays graphical menus and settings. This mode is recommended for standard use.

LIGHT MODE

Displays with 200 x 300 dots. This mode is optimized for use of the handheld computer, PDA, etc. It is also convenient if the network traffic is heavy. (This mode has some limitations on the network viewer and multi-control functions.)

If the password has been set on the setting page, the authentication window will appear. In that case, type "user" onto the **User Name** text area and the login Network PIN code onto the **Password** text area and then click **OK** button.

* The entered User Name must be "user" and it can not be changed.



[Note]

When the projector is accessed for the first time or the Network PIN code "0000" is set, the auto-login is performed and the next main setting page is displayed.

Display of main setting page

The following main setting page will be displayed depending on your display mode selection. Perform various kinds of settings through this page. Click on the menus to display the control and setting pages.

1 Main setting page in the Standard Mode display

Initial setting
Power & Status
PC Adj.
Control
Setting
E-mail setting
Network
Multi control
Timer
Information
SNMP setting

Control
 Input System
 Sound Image adj.
 1 2
 Contrast 32
 Brightness 32
 Color ---
 Tint ---

Clock display
 Display on or off by clicking text ON or OFF

Sub menu tab
 Switches the sub menu tab.

Page numbers
 Switches the pages by clicking the number's tab.

Main menu
 For selection of control and setting items of the projector.

Setting page
 Displays the control and setting items according to the selected menu.

Returns to Display Mode selection page (p.48)

TOP

*To change the screen language, use the initial setting menu (p.52)

This Standard mode display is mainly used through this manual for the setting and control description.

If your computer does not have the Adobe Flash Player version 6 or later, follow the message on the control page to install the Adobe Flash Player. For further product information or installing, see the Adobe homepage.
<http://www.adobe.com>

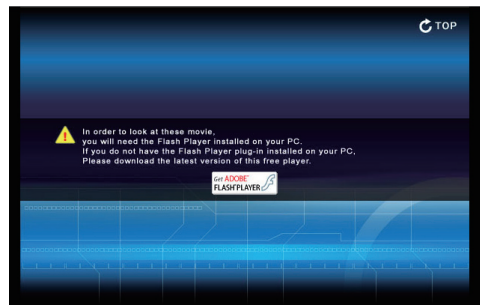

2 Main setting page in the Light Mode display

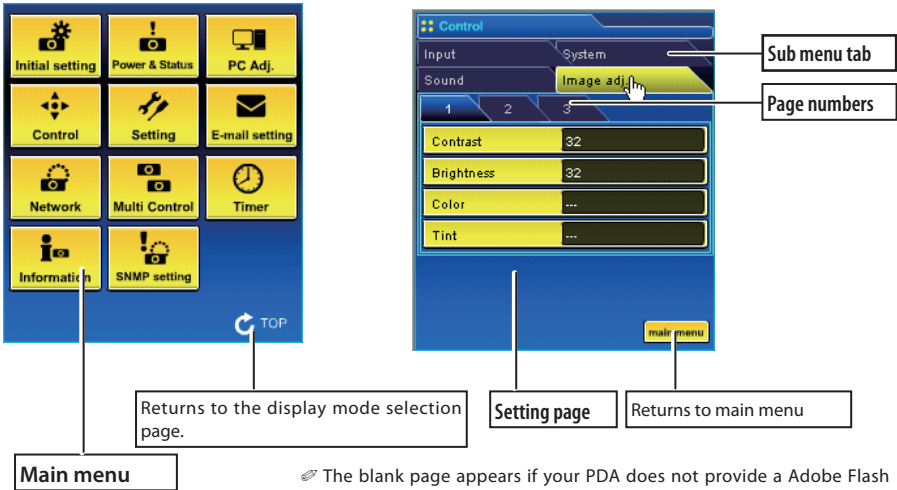

The blank page appears if your PDA does not provide a Adobe Flash Player. You need to install the Adobe Flash Player. (p.49)

The network viewer function in the Light mode has following limitations;

- Cannot select the program or folder for the display.
- Cannot check up the images in the folder or program.

How to use the setting page

To control and set up the projector, use the setting menus on the web browser. The basic operation and procedures commonly used on this manual are described below.

Example of the Setting Page



The setting pallet appears after clicking the item. Change the value by clicking ▲ or ▼ button, or type the number onto the text box directly and then click Set button.
* Each item has a valid setting range respectively.

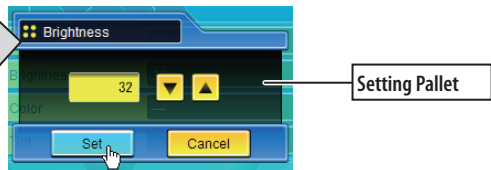

The value in the text box indicates current value.

Each item has a valid setting range. The setting value exceeding its range becomes invalid. Some control items can not be used depending on the selected input mode or functions of the projector you use. In that case, the values of those items are indicated with "----".

Type of the setting pallet

Text box setting

Enter the number or text and then click **Set** button.

or

Change a value with ▲ or ▼ button and then click **Set** button.

The value changes quickly when ▲ or ▼ button is kept pressing.

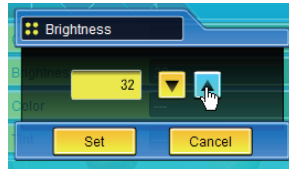
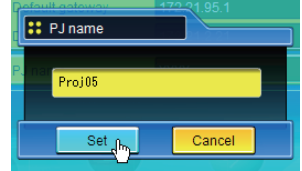

Pull-down menu setting

Select an item with pull-down menu button and then click **Set** button.

or

Select an item by clicking ▲ or ▼ button.

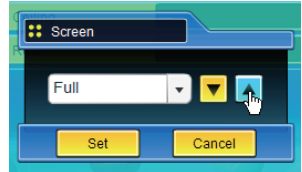
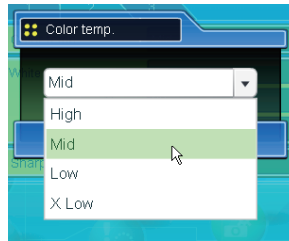

Radio button setting

Select an item by selecting a radio button

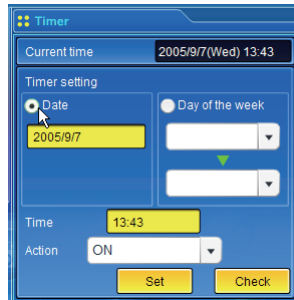

Check box setting

Select items by ticking on check boxes.

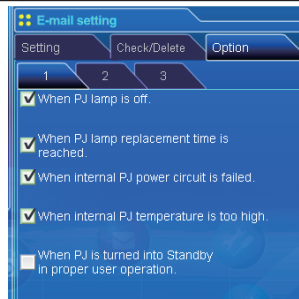



Initial setting

After installing the projector, perform the following basic initial setting.

Click **Initial Setting** on the main menu to display the initial setting page.



Item	Description
Language	Switches display language on the setting page. English or Japanese.
Model name	Indicates the model name of the projector.
Projector name.....	Sets the name of projector. This projector name is listed on the application window of the Network Capture software.
Network PIN code	Sets the Network PIN code to login the setting page (see p.32, p.44)
PJLink	Switches PJLink password authentication on or off.
Password.....	Password for PJLink function

Network PIN code setting

This is to set the Network PIN code to restrict the access from an unauthorized person through the network.

Enter a 4-digit number as the Network PIN code onto the text box and click **Set** button.

The projector's network part begins restarting and it takes about 20 seconds. Close (Quit) the web browser and access to the login page again in 20 seconds. This is to perform the login authentication firmly.

The default Network PIN code as [0000], which means no Network PIN code is set.

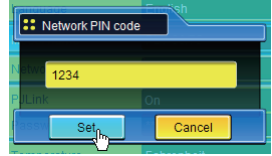

- ☞ When you connect the projector to the network, it is recommended to set a new Network PIN code. Only a four-digit number is valid for the Network PIN code.
- ☞ If you forget the Network PIN code to the projector, you can check it by selecting "Network PIN code" sub menu from "Network" menu on the projector. For further information, please see item "Network PIN code setting" (p.32, p.44).

PJLink and password setting

This is to set the PJLink password authentication on or off. If "On" is set with the PJLink pull-down menu, the password must be required. Enter a **password*** onto the text box and click **Set** button.

Refer to the projector owner's manual for further details of the PJLink function.

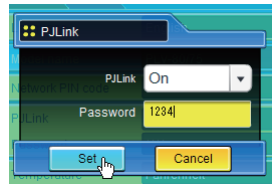

- ☞ 1 to 32 alphanumeric characters can be used for the password.

What's PJLink?

The projectors equipped with PJLink function can be used together on the same network, regardless of model or brand, for centralized control and monitoring. This standard was established by the Japan Business Machine and Information System Industries Association (JBMIA). <http://pjlink.jbmia.or.jp/>

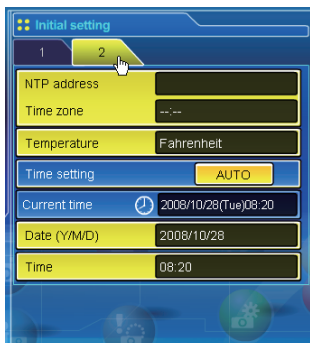

Item	Description
NTP address.....	Enter the address of NTP server. Please consult your network administrator for setting up of the NTP server.
Time zone.....	Sets your country or region's time zone
Temperature.....	Switches display temperature unit Centigrade or Fahrenheit
Time setting.....	When clicking AUTO button, the date and time set on your computer are set to the projector. The timer icon appears when time is set up correctly.
Current time.....	Indicates current date and time set on the projector
Date.....	Sets date in manual
Time.....	Sets time in manual

Date and time setting

NTP is abbreviated expressions of Network Time Protocol. It is a protocol to acquire the exact current time via the network. This projector acquires the current time from the NTP server and update the time in the network module. After setting the NTP address, the projector acquires the time per 24 hours. If the projector fails acquiring the time from the NTP server, the projector tries to acquire the time every 1 hour until it succeeds.

- ☞ "Time zone" is the local time as an offset from Greenwich Mean Time (GMT). "Time zone" is in ± hour:minute format and is available from -23:59 to +23:59.
ex. Time zone: +09:00 in Tokyo, Japan
- ☞ Both of "NTP address" and "Time zone" should be set, otherwise the setting will be failed.

When the NTP address is not set, perform the time setting with "Auto-setting" or "manual setting" described below.

Auto setting

Click **AUTO** button on the page, the date and time set on your computer are set to the projector.

Note: Confirm that your computer has a correct clock time before performing the auto time setting.

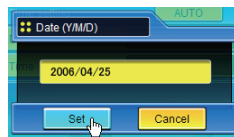

Manual setting

Click the item **Date** or **Time** and enter the date or time on the input box with adequate format.

Date is in year/month/day format.

ex. 2007/10/05

Time is in 24-hour:minute format.

ex. 18:30

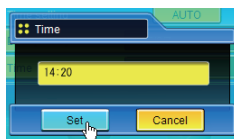

This projector does not provide the built-in battery. The date and time information are lost when the projector turns off (when "Eco" is set for the stand-by mode (Refer to p.76)), or the network configuration is reset. The timer function is disable until time is set up correctly. When using the NTP address for time setting, the current time is acquired at the projector starting up and the timer function is activated after finishing the time setting correctly.



Network configuration

Click **Network** on the main menu. The following setting page is displayed. Set up the projector's network environment on this **Setting** sub menu.



Setting of LAN

1. Select a type of LAN from **Change setting** pull down menu.

- LAN1 (Wired)
- LAN2 (Wired)
- LAN3 (Wired)
- LAN4 (Wireless)
- LAN5 (Wireless)
- Simple (Wireless)
- USB display^{*1}

For the default setting of the above LAN, see the items "Wired Factory Default Setting" or "Wireless Factory Default Setting".

Item	Description
Change setting.....	Selects LAN1 to LAN5 and Simple
DHCP.....	Sets DHCP configuration (ON/OFF)
IP address.....	Sets IP address of the projector
Subnet mask.....	Sets Subnet mask.
Default gateway ^{*2}	Sets IP address of the default gateway (Router)
DNS ^{*3}	Sets IP address of the DNS server.

*1 When selecting "Mouse control" in "USB terminal" from the setting menu, "USB display" cannot be selected.

*2 Set [255.255.255.255] if the network does not provide the gateway (router).

*3 Set [255.255.255.255] if you do not use the function E-mail alert.

2. Select either "Manual" or "DHCP" from **IP configuration** pull down menu. When "DHCP" is selected, IP address, Subnet mask, Default Gateway, DNS are automatically configured by DHCP function. Only the DNS address allows you to set up manually if the DNS address information is not provided on your DHCP server. When selecting "Manual", configure all the items manually. For further information, contact your network administrator. The address must be entered as 4 number groups separated by a dot like [192.168.001.101].

3. After completing the network configuration, press **Set** button to register the network information. The Simple(Wireless) setting is fixed, which cannot be changed from factory default value.

4. To apply the setting, press Set button. The network of the projector starts re-booting and applies the setting. It takes about 20 seconds to complete. Close the web browser and access to the login page again in 20 seconds.

On the screen of the projector, the "Please wait..." message will appear and switching operation will start. Switching will take a while and after completing the operation, the "Ready for use" message will appear. During the switching period, the projector cannot be operated.

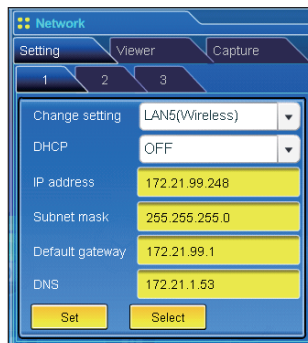

When you use LAN4(Wireless) or LAN5(Wireless), the setting items of page [2] and [3] are activated and you can setup Wireless LAN setting and Security setting. See the item "Configuring Wireless LAN Setting and Security Setting" for further setting.

☞ When the IP address collides with the address of other equipment, the computer cannot communicate with the projector. When the IP address collides with the address of other equipment, the computer cannot communicate with the projector. Set an IP address again after selecting another LAN mode from "Change setting" or turning off and then on the projector.

Configuring wireless LAN setting and security setting

Configure the wireless LAN setting and security setting for Wireless 4 and Wireless 5.

Configuring wireless LAN setting

1. Click page [2] of setting pages. Following wireless LAN setting can be done. After completing the configuration, press **Set** button.



Item	Description
Wireless Mode	Select the Communication standard 802.11b, 802.11b/g or 802.11b/g/n.
Network Type.....	Select either "Infrastructure" or "AdHoc". When selecting the "AdHoc", the security "WPA-PSK" and "WPA2-PSK" mode are not available.
SSID/ESSID	Set the SSID/ESSID. (up to ASCII 32 characters) SSID/ESSID is case-sensitive. Even though all characters on the Wireless information is uppercase, it is necessary to distinguish between upper case and lower case characters.
Channel.....	If you use the projector in 802.11AdHoc mode, select the channel, from 1 to 11.

Notes for entering characters:

The "¥" symbol is displayed as "\" when the ASCII key is used. The "*" symbol is treated as a character by the ASCII key, but it is not interpreted as a character by the HEX key. In HEX, the "*" symbol is displayed in red and setting is denied.

You can not set all the characters with the "*" symbol. It will be considered as no operation.

ASCII key characters : Space - 0 to 9 A to Z a to z ! " # \$ % & ' () * + , . / : ; < = > ? @ [¥] ^ _ ` { | } ~

HEX key characters : 0 to 9 a to f

Configuring wireless LAN security setting

Click page [3] of setting pages. Following wireless LAN security setting can be done. After completing the configuration, press Set button.

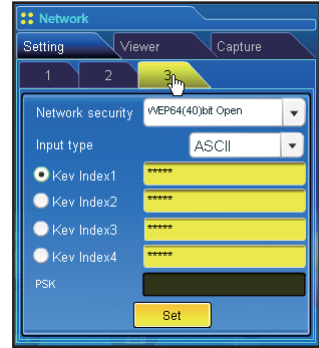

Item	Description
------	-------------

Network security ...Sets the type of encryption. Following types are available.

- Disable
- WPS Push Button
- WPS PIN code
- WEP64(40)bit Open
- WEP64(40)bit Share
- WEP128(104)bit Open
- WEP128(104)bit Share
- WPA-PSK(TKIP)
- WPA2-PSK(AES)

Input type.....ASCII or HEX. See item "Notes for entering characters"

Key index1 - 4.....Enter keys of encryption.

The used number of character changes as the table below according to the type of WEP encryption and input type.

WEP option	Characters
WEP64(40)bit ASCII	5 characters
WEP64(40)bit HEX	10 characters
WEP128(104)bit ASCII	13 characters
WEP128(104)bit HEX	26 characters

Four key indexes can be set, however, the only one with check on its radio button is effective. Both of the number and value of the key index in effect must be same as those of your computer and the access point.

Depending on computers and access points, you may be allowed to select only one WEP key. In that case, use key index1.

PSK.....Available when the "WPA-PSK(TKIP)" or "WPA2-PSK(AES)" is selected.

The PSK key must be no fewer than 8, nor more than 63 digits with ASCII code, and 64 digits with Hex code.

Setting of WPS Push button

1. Select "WPS Push Button" in the "Network security" and press **Set** button to start WPS configuration.
2. Configure WPS of the access point within 2 minutes. After configuration of the access point, the network between the access point and the projector will be performed automatically.
3. The network setting will be updated after finishing configuration. Re-connect to the projector by entering the new IP address on the browser.

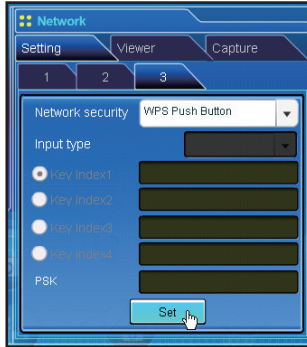

Setting of WPS PIN code

1. Select "WPS PIN code" in the "Network security" and press **Set** button.
2. The eight-digit number in "WPS PIN code" window will appear, and set up this WPS PIN code of your wireless access point according to the instructions manual of the access point.
3. After setting up the access point, press **Set** button on this "WPS PIN code" window within 2 minutes. After configuration of the projector, the network between the access point and the projector will be performed automatically.
4. The network setting will be updated after finishing configuration. Re-connect to the projector by entering the new IP address on the browser.

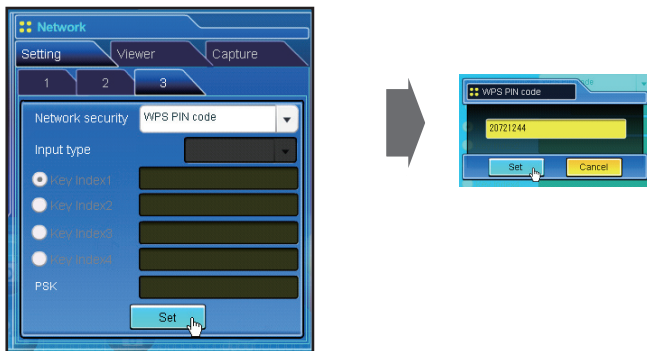

⚠ When there is plural access points, WPS PIN code sets the connection vis-a-vis the access point whose the radio wave strength is strongest. So, when setting WPS PIN code, please set the projector in the vicinity of the access point which you want to connect. If the setting with WPS PIN code is not succeeded, please try the setting with WPS Push button.



E-mail setting

This product has an E-mail function which can send an alert message to users or an administrator if it detects an abnormality on the projector or run out of the life span of the lamp. Click **E-mail Setting** on the main menu and follow the below steps.

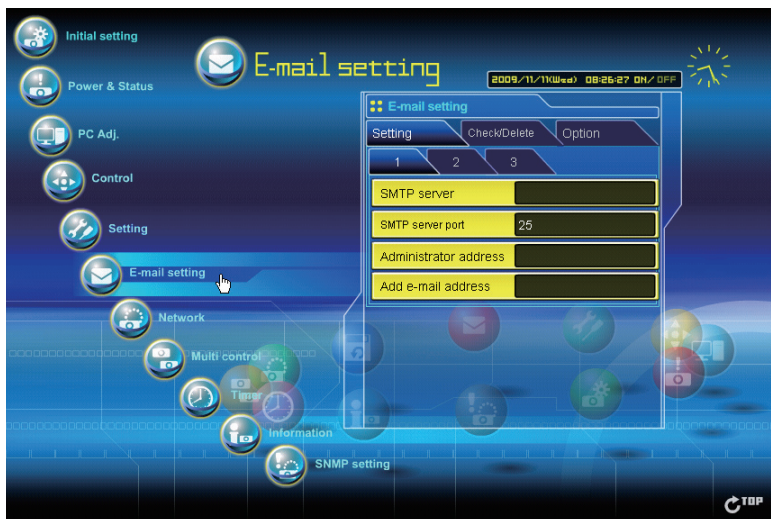

1 Setting SMTP server and administrator address

Set the server name or IP address of the SMTP server*¹ and administrator address. The administrator address is set to "Reply-To" address of the message sent from the projector.

*¹ The SMTP server is a server for sending E-mail. Please contact your network administrator to have this SMTP server address. When the server name for SMTP server is used, DNS must be set up to activate the E-mail function.

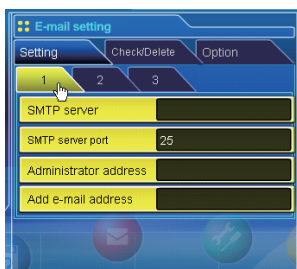

Item	Description
SMTP server* ¹	Sets server name or IP address of the SMTP server. (up to 60 characters)
SMTP server port ...	Sets the SMTP server port. (from 1 to 65535)
Administrator address	Sets E-mail address of administrator. (up to 95 characters)
Add e-mail address	Sets E-mail address of the user to send a mail when the projector has an abnormality. (up to 95 characters)

☞ If the projector sends an alert message due to the abnormality on the projector but the SMTP server is down in some other reason, the message will not be sent. In that case, the message "Unable to connect to server." will be displayed on the setting page. To clear this message, set up SMTP server address again.

☞ To use the E-mail function, it must be set the DNS address on the Network setting page correctly.

☞ You cannot use this E-mail function if the DNS server and SMTP server cannot be used in your network environment.

☞ The projector does not send message to the address set in "Administrator address" text box. If you want to send e-mails to the administrator address, enter the administrator address into "Add e-mail address" text box.

2 Setting SMTP authentication

Set the SMTP authentication concerned. Please contact your network administrator in details.

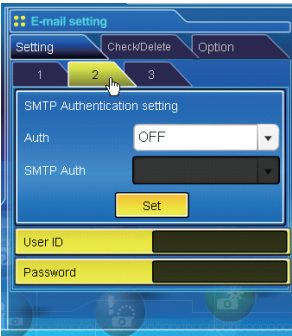

Item	Description
SMTP authentication setting	
Auth.....	Sets authentication setting option. (OFF, SMTP Auth, POP before SMTP)
SMTP Auth	Sets user authentication setting option when selecting "SMTP Auth" in above column. (CRAM-MD5, LOGIN, PLAIN)
	After completing the settings, press Set button.
User ID	Enter SMTP user ID. (up to 63 characters)
Password.....	Enter SMTP password. (up to 63 characters)

3 Registering POP server

When using POP server to receive E-mail, set the POP server concerned. Please contact your network administrator in details.

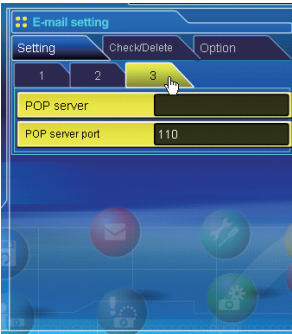

Item	Description
POP server.....	Enter POP server name or IP address. (up to 60 characters)
POP server port.....	Enter Port number of POP server. (from 1 to 65535)

4 Registering and deleting E-mail addresses

Click "Add E-mail address" and type the E-mail address onto the text box and click **Set** button. To check the registered addresses, click **Check/Delete** sub menu tab. The addresses are listed as the figure on the right.

✍ Up to 10 E-mail addresses can be registered.

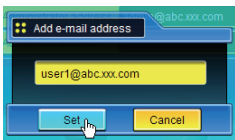

To delete the registered addresses, check the address you want to delete and click **Delete** button.

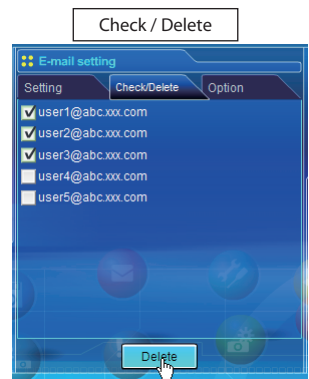

5 Option selection for sending alert mail

Click **Option** sub menu tab. Check the condition items under which alert mail will be sent and click **Set** button.

Please refer to the item "Examples :Type and contents of alert mail" described as below.

Option

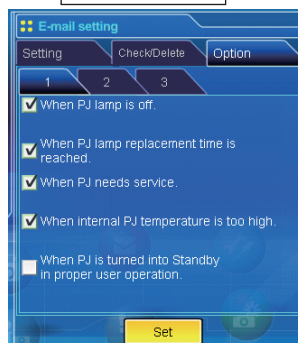

[1]-----

When PJ lamp is off.

When PJ lamp replacement time is reached.

When PJ needs service.

When internal PJ temperature is too high.

When PJ is turned into Standby in proper user operation.

[2]-----

When accumulated filter use time reaches [] hours.

When Power management function turns PJ lamp off.

When the signal is interrupted.

When Auto Play is failed.

[3]-----

When lamp Corres. Value reaches [] hours.

Attached message

- ☞ "When PJ lamp is off" signifies the lamp goes out without user operation. "When PJ is turned into Standby in proper user operation" signifies that the projector is turned on by using the web browser and then it is turned into standby with ON/STANDBY button on the top control or the remote control.
- ☞ If condition "When Auto Play is failed" is checked, the trap is sent when the error occurs during the auto display operation using with the network viewer function (☞p.113). For further information of the error, refer to item "Auto Display setting and control page [3]"(☞p.128).
- ☞ The length of message should be less than 255 characters.
- ☞ Up to 99,999 hours can be set for use time.
- ☞ The optional settings return to the factory default when you unplug the AC power cord of the projector.

Examples: Type and contents of alert mail

When the projector has an abnormality, the following alert messages are sent to the registered E-mail address depending on your selected condition. Administrator or user can take an efficient action quickly by receiving this message. This is very useful to maintain and service the projector.

The following are examples of received messages.

● When PJ lamp replacement time is reached:

TITLE: Message from projector
 10-03-2007 00:59
 Projector Model Name: *model name*
 TCP/IP: 192.168.1.201 Projector Name: Proj05

It sends you following message.

*The PJ lamp replace time is reached.

- ☞ Replace it with a new lamp immediately and reset the lamp counter. If the projector is used without resetting the lamp counter, the alert mail is sent to users in every power-on of the projector. This alert mail will not be sent when the mail sending condition "When the life span of lamp is reached" is unchecked.

● When PJ needs service::

TITLE: Message from projector
 10-03-2007 00:59
 Projector Model Name: *model name*
 TCP/IP: 192.168.1.201 Projector Name: Proj05

It sends you following message.

* Maintenance requirement from Projector is detected.
 Check up LED status of projector and consult with the dealer.

MAIN,	P-FAIL	OK	} Error information
MAIN,	1.8V	OK	
MCI,	P-FAIL	NG	

- ☞ Maintenance requirement from Projector is detected. Unplug the AC power cord and plug it again, and then turn on the projector to verify the operation. If the problem still persists, unplug the AC power cord and ask servicing to a qualified service personnel.

● When internal PJ temperature is too high:

TITLE: Message from projector
 10-03-2007 00:59
 Projector Model Name: *model name*
 TCP/IP: 192.168.1.201 Projector Name: Proj05

It sends you following message.

*The Projector lamp is turned off, because internal Projector temperature is too high.
 Wait for the completion of the cooling process and make sure the projector has been turned into Standby. Then turn the projector on again.
 If the Indicator continues flashing, check the air filter for dust accumulation.

[A] 81.5 degrees fahrenheit [B] 134 degrees fahrenheit [C] 95.6 degrees fahrenheit
 Temperature of Sensor B is too high.

- ☞ The projector let users know the information which thermal sensors inside the projector detected the abnormal temperature risen and so the projector was turned off. Please refer to item "Power control and status check" (☞ p.68) for the location of the sensors and each temperature . Also see the owner's manual of the projector for further details.

● When lamp corres. value reaches preselect use time:

TITLE: Message from projector
 10-03-2007 00:59
 Projector Model Name: *model name*
 TCP/IP: 192.168.1.201 Projector Name: Proj05

It sends you following message.

*The accumulated lamp use time reaches 1800 hours.
 Prepare for the lamp replacement.

Discretionary messages

- ☞ The projector sends a free message when the lamp use time (Corresponding value) reaches the preselected lamp use time. It can be used for preparation of the lamp replacement and the maintenance required.



SNMP setting

This product provides a SNMP (Simple Network Management Protocol) agent function. The SNMP consists of a manager and agents. The group which exchanges information with SNMP is called "Community". There are two access modes in a community, Refer (read only) and Set (read- write). This product allows to use Refer (read only) only. The SNMP message informs the projector status called "Trap" to an administrator. Click **SNMP Setting** on the main menu and set up each item.

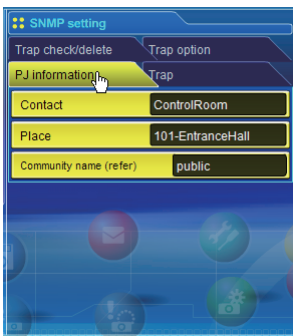

PJ information

Item	Description
Contact	Enter user name of the projector etc. (optional)
Place	Enter place of the projector (optional)
Community name(refer)	Enter community name (read only). Default name is "public".

ⓘ The SNMP agent provided with this product is based upon MIB-2 defined by RFC1213. For private MIB information, refer to file "Mibinfo/XUPjNet.mib" in the CD-ROM.

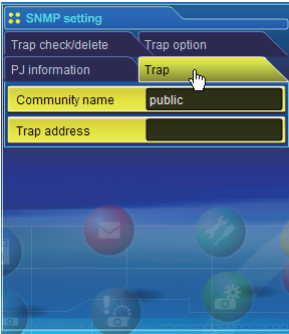

Trap

Item	Description
Community name	Enter community name to send "Trap". Default name is "public".
Trap address	Enter IP address of the SNMP manager computer to receive "Trap". Up to 10 address can be registered. <input type="checkbox"/> Up to 10 trap addresses can be registered.

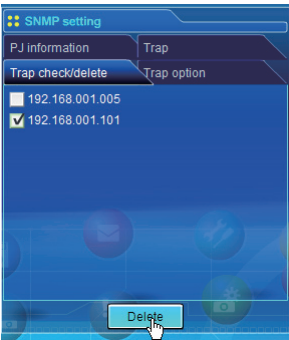

Trap check/delete

Check and delete the trap address

Checking the registered trap address and deleting the address.

To delete the address, tick the check box in front of the IP address and click **Delete** button.

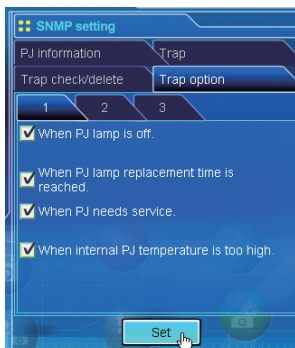

Trap option

Trap option setting

Tick the check boxes in front of the condition item to send the trap.
 ☞ Click **Set** button if you tick or un-tick the check box on a page.

[1]-----

- When PJ lamp is off.
- When PJ lamp replacement time is reached.
- When PJ needs service.
- When internal PJ temperature is too high.

[2]-----

- When PJ is turned into Standby in proper user operation.
- When accumulated filter use time reaches [] hours.
- When Power management function turns PJ lamp off.

[3]-----

- When the signal is interrupted.
- When Auto Play is failed.
- When lamp Corres. Value reaches [] hours.

☞ "When PJ lamp is off" signifies the lamp goes out without user operation. "When PJ is turned into Standby in proper user operation" signifies that the projector is turned on by using the web browser and then it is turned into standby with ON/STANDBY button on the top control or the remote control.

☞ Up to 99,999 hours can be set for the time setting.

☞ If condition "When Auto Play is failed" is checked, the trap is sent when the error occurs during the auto display operation using with the network viewer function (☞p.113). For further information of the error, refer to item "Auto Display setting and control page [3]"(☞p.127).

7. Controlling the projector

Describes controlling and setting of the projector by using the web browser.



Power control and status check

Click **Power & Status** on the main menu. The control page will be displayed.

By clicking **ON** or **Standby** button on the page, the power of the projector can be controlled.

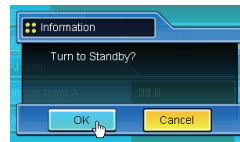

Pop up confirmation window

Item	Description
------	-------------

PJ status

- PowerDisplays the status of the lamp. (ON, OFF, On starting up, On cooling down)
- StatusDisplays the status of the projector's power. (Refer to next page.)
- Power control.....Controls the projector power by clicking the "ON" or "Standby" button.

PJ temp.

- Inside temp.ADisplays the surrounding temperature of lamp in the projector.
- Inside temp.BDisplays the surrounding temperature of panel in the projector.
- External temp.Displays the surrounding temperature of the intake vent.



The warning icon will appear if the temperature exceeds a specified value. Check if there is no object to obstruct the airflow around the intake or exhaust vent. It might be airfilter clogged. Clean up the airfilter.

* The temperature unit can be set either Centigrade or Fahrenheit in the item "Initial Setting". (p.54)

☞ The projector cannot be turned on while the projector is cooling down.

☞ The web browser checks and updates the projector's condition every 30 seconds automatically.

About projector condition

Status	Description
Normal.....	Projector is operating normally.
Power management in operation.....	Power management is operating
Lamp failure.....	Lamp failure is occurring
Abnormal Temperature.....	The temperature of the projector became too high
Cooling down after abnormal Temp.	Projector detects abnormal temp. and is cooling down itself.
Standby after Abnormal Temp.	Projector detects abnormal temp. and is set into standby mode.
Power failure	Power failure has occurred inside the projector. Projector is turned off. Unplug the AC cord and contact a qualified service personnel for service. If the power failure occurs on the projector, "Power failure" is indicated on the status column and the information icon appears on the power column as shown below. Click this icon to display further information of the power failure.

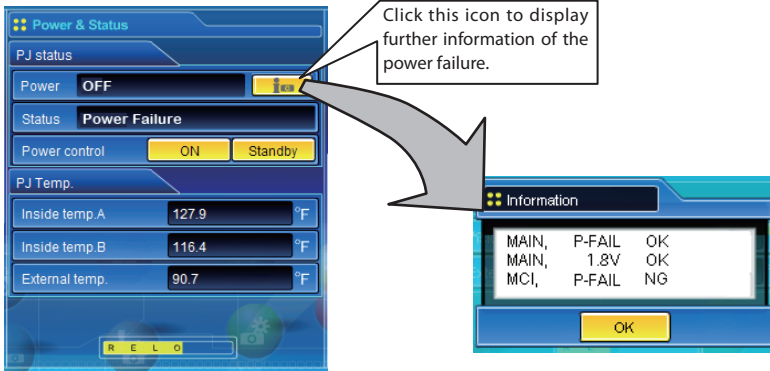

When a security (PIN code lock) has been set on the projector, you also cannot control it through the network. To control the projector through the network, unlock the security on the projector using with the projector's menu control.

Caution about turning on/off the projector via the networks

When turning on/off the projector via the networks, preset the projector as follows:

1. Select "Setting" from the Projector menu.
2. Select "Standby mode" from the Setting menu and set it as "Network".

If you set this function as "Network", the network part of the projector is constantly provided with power even if the projector is turned off. If you set this as Eco, then the network part will be turned off when you turn off the projector. Consequently, you cannot turn on/off the projector via the networks.



Controls

Click **Control** on the main menu. The setting method differs depending on the contents of the page. Click on the page number to change pages and select desired setting items.

☞ Please see the owner's manual of the projector to have the further information of each control item.



Input

This function is to select the input mode and source mode of the projector. Click **Set** button after selecting the input and source mode.



Item	Description
Input.....	Selects input mode of the projector.
Source.....	Selects signal source of the input.
Computer1 :	RGB Component RGB(Scart)
Computer2 :	RGB(PC analog) RGB(PC digital) RGB(AV HDCP)
Video :	Video
S-video :	S-video
Network :	Network

☞ The control page displays valid control items depending on the selected input mode, signal or functions of the projector you use, therefore, there may be different controls between the described items and actual control items on the page display. For further information, refer to the projector's owner's manual.

☞ When the projector is standby, only the timer on the setting menu is available; others are not available.

System

This function is to select the system of signal input to the projector. The available system mode are listed on the pull-down menu button according to the input signal. Select a system and then click **Set** button.

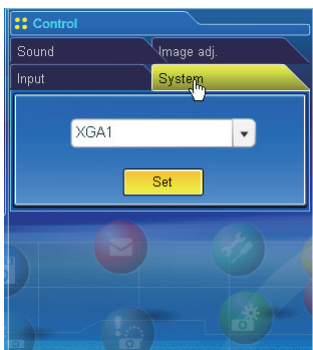

Available selection at the RGB(PC analog) input

Item	Description
XGA1	It automatically switches to the proper computer system of the input signal. * The computer system modes (VGA, SVGA, XGA, SXGA, UXGA, WXGA...) which meet the input signal listed.

Available selection at the RGB(PC digital) input

Item	Description
D-XGA	It automatically switches to the proper computer system of the input signal. * The computer system modes (D-VGA, D-SVGA, D-XGA, D-SXGA1...) which meet the input signal listed.

Available selection at the Video/S-video/Scart input

Item	Description
AUTO	It automatically switches to the proper color system of the input signal. * The selectable color systems are PAL, SECAM, NTSC, NTSC4.43, PAL-M and PAL-N. * AUTO is fixed at the Scart input.

Available selection at the RGB(AV HDCP) input

Item	Description
D-480p.....	It automatically switches to the proper scanning system of the input signal. * The selectable scanning systems are D-480p, D-575p, D-720p, D-1035i and D-1080i.

Available selection at the Component input

Item	Description
AUTO	It automatically switches to the proper scanning system of the input signal. * The selectable scanning systems are 480i, 575i, 480p, 575p, 720p, 1035i and 1080i.

☞ If the modes (Mode1 to Mode5) stored in the item "PC Adjustment" (☞ p.74) are available, they are also listed together with the above mode.

Image adjustment

This function is to adjust the projected picture image and save the image mode. To store the adjusted value, click **Store** button, and to load the adjusted value, click **Load** button.



Item	Description
Contrast.....	Adjusts picture contrast
Brightness.....	Adjusts picture brightness
Color.....	Adjusts picture color saturation
Tint.....	Adjusts picture hue

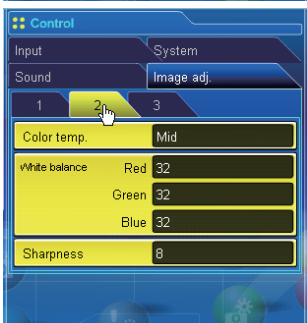

Item	Description
Color temp.	Sets a color temperature mode.
White balance Red, Green, Blue	Adjusts each white balance respectively.
Sharpness.....	Adjusts picture sharpness.

* When the value of the white balance is changed, the color temp. indicates "User".



Item	Description
Gamma.....	Adjusts brightness of darker part of the picture.
Noise reduction	Switches noise reduction mode
Progressive.....	Switches progressive mode
Reset.....	Resets the Image adjustment to previous levels.
Store.....	Stores the Image adjustment values. Select an item [Image 1 - Image 4] from the pull-down menu and click Store button.

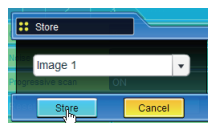

Load.....	Loads the Image mode. Select an image mode from the pull-down menu and click Load button. There may not be available mode depending on the input mode as shown in the table left.
-----------	--

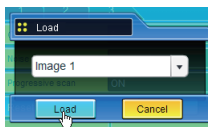

Input source		
Image mode	Video	Computer
Dynamic	✓	✓
Standard	✓	✓
Real	*	✓
Cinema	✓	*
Blackboard(Green)	✓	✓
Colorboard	✓	✓
Image 1 - 4	✓	✓

☞ The mark "✓" indicates the available image mode in the selected input source. The error message appears when the disabled image mode indicated with "*" is selected.

Sound

This function is to adjust the sound of the projector. The values in the text box represent the current control value or status.

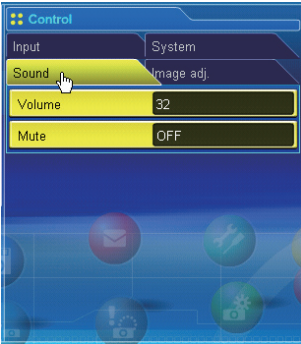

Item	Description
Volume	Adjusts the sound volume from the speakers.
Mute	Suppresses the sound.



PC adjustment

Click PC Adj. on the main menu. This function is to adjust the signal from the computer connected to the projector to obtain the proper picture image on the screen.

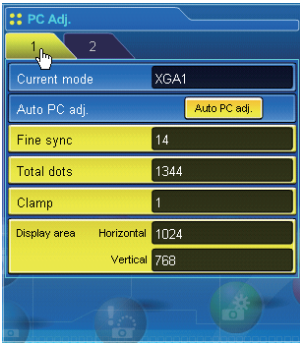

Item	Description
Current mode.....	Displays a current mode like VGA, SVGA, XGA, SXGA, UXGA, WXGA, etc. or MODE1 - MODE5 are the customized mode created by using the "Mode Store" function described below.
Auto PC adj.	Performs automatic adjustment.
Fine sync.....	Performs Fine Sync adjustment.
Total dots.....	Adjust the number of total dots in the horizontal period.
Clamp.....	Adjusts the phase of the clamp.
Display area	
Horizontal.....	Adjusts the image area horizontally.
Vertical.....	Adjusts the image area vertically.

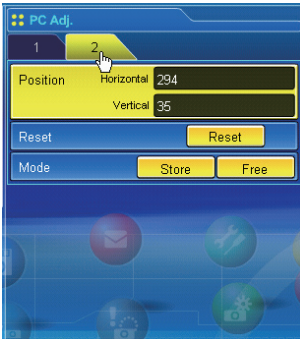

Item	Description
Position	
Horizontal.....	Adjusts the horizontal position of the screen.
Vertical.....	Adjusts the vertical position of the screen.
Reset.....	Resets the PC adjustments to the previous levels.
Mode Store.....	Stores the PC adjustment values. Select a mode no. [Mode1 - Mode5] from the pull-down menu.
Mode Free.....	Clear the PC adjustment values. Select a mode no. [Mode1 - Mode5] from the pull-down menu.



Setting up the projector

Click **Setting** on the main menu. This function is to set up the projector. Select the sub menu [Screen setting], [Setting 1] or , [Setting 2] and then set up each setting.

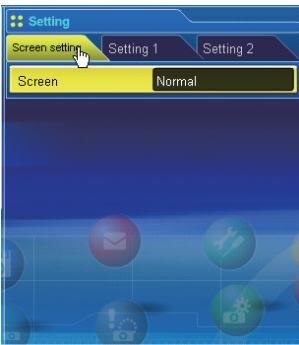

Item

Description

Screen.....Switches the screen mode. There may not be available mode depending on the input mode as shown in the table below.

Screen mode	Input source	
	Video	Computer
Normal	✓	✓
True	*	✓
Wide	✓	*
Full	✓	✓
Custom	✓	✓

☞ The mark "✓" indicates the available screen mode in the selected input source system. The error message appears when the disabled screen mode indicated with "*" is selected.



Item	Description
Language	Sets the language display of projector's on-screen display menu.
Auto setup	Executes the Auto PC Adj, and Input Search function below according to the each setting after clicking Start button. Auto PC adj.....Sets Auto PC Adjustment mode. Input searchSets the auto-input signal detection mode. Auto keystone ...Sets Auto Keystone mode.
Background	Sets the screen background when no signal input.

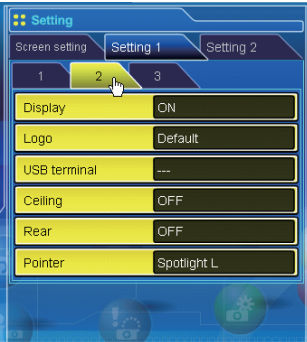

Item	Description
Display	Switches on or off the on-screen menu display on the screen. Countdown off Displays image during the starting up.
Logo	Sets the logo display on the screen during the startup.
USB terminal.....	Selects the usage of the USB terminal from "Display/ Mouse control".
Ceiling.....	Sets the image top/bottom and left/right reversed.
Rear.....	Sets the image left/right reversed.
Pointer	Sets the pointer form.



Item	Description
Power management	Sets into the selected power management mode if the input signal is interrupted and no control key is pressed for the specified period of time. *The specified time can be set 1 to 30 min.
On start	Sets the power-on mode when the AC cord is connected to the outlet.
Standby mode	Sets the network function enable or disable in the standby mode. Network ..Enable EcoDisable
Lamp control.....	Selects the lamp control mode.
Remote control	Sets the remote control code.
Key lock	Sets the prohibition of controls either Projector or Remote control.



Item	Description
Fan	Sets the cooling options after turning off. L1 Normal cooling L2 Silent cooling
Fan control.....	Sets the fan control speed. Off Normal mode On1 Highland mode 1 On2 Highland mode 2 On3 Highland mode 3
Lamp Corres. value ...	Displays the use time (Corresponding value) of the lamp and reset the counter.

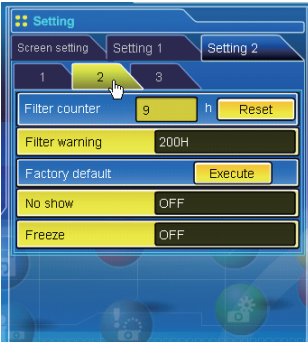

Item	Description
Filter counter.....	Displays the filter use time. Reset the time after filter clean-up.
Filter warning.....	Sets the time to indicate the filter warning message on the screen.
Factory default.....	Sets all of the projector control items to the factory default setting except the following items. Lamp Corres. Value, PJ time, Filter time, PIN code lock and Logo PIN code lock.
No show.....	Sets the black out image temporarily.
Freeze.....	Sets the image to freeze mode.

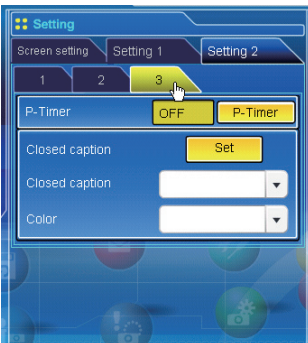

Item	Description
factory default.....	Sets all of the projector control items to the factory default setting except the following items. Lamp Corres. Value, PJ time, Filter time, PIN code lock and Logo PIN code lock.
P-Timer	Switches the P-Timer display. ON..... Starts P-Timer indication STOP..... Stops P-Timer counting OFF Stops P-Timer indication
Closed caption.....	Sets the closed caption function. Closed caption..Sets the closed caption mode. (OFF/CC1/CC2/CC3/CC4)
Color	Sets the color of the contents. (Color/White)



Timer setting

This page is to set the timer to turn the projector off or on at a programmed day/date and time. Follow the steps below for setting.

Click **Timer** on the main menu.

"---" will appear on the current time when the time is not set up correctly.

Present time set on the projector



How to set the timer

1 Set a day or date

To set the timer event at the same time everyday or every week,

Select **day** entry with radio button and then select desired day from the pull-down menu button.

The selectable days are as follows:

- Same time everyday
- Every week (days from Monday to Sunday)

To set the timer event on specified date,

select **date** entry with radio button and then type the date with (Year/Month/Date) format.

Ex.: Type [2007/12/20] if you specify [December 20, 2007].

This projector does not provide the built-in battery. The date and time information are lost when the projector turns off (when "Eco" is set for the stand-by mode (Refer to p.76)), or the network configuration is reset. The timer function is disabled until time is set up correctly. When using the NTP address for time setting, the current time is acquired at the projector starting up and the timer function is activated after finishing the time setting correctly.

2 Set an execute time

Type the time with (Hour:Minute) and 24 hours format.

Ex.: Type [18:25] if you specify [PM 6 o'clock and 25 minutes].

3 Select an event action

Select an event action from the pull-down menu.

Event	Action
ON	Turns on the projector
OFF	Turns off the projector
Lamp High	Changes lamp mode to "High"
Lamp Normal	Changes lamp mode to "Normal"
Lamp Eco	Changes lamp mode to "Eco"

4 Register an event

Click **Set** button to register the set timer event. Repeat steps 1 to 4 for another timer event setting.

Check the timer events

To check the set timer events, click **Check** button. The timer events are listed. The event with blue background color represents the timer-OFF event.

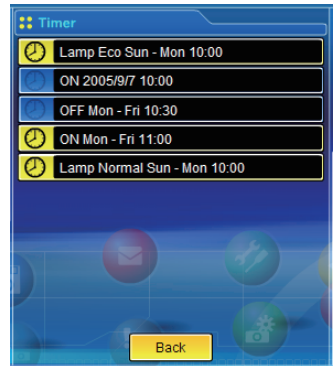

Change the event mode

On the event list appearing by clicking **Check** button, click on the event you want to delete, disable or enable. Click **Cancel**, **Delete**, **Timer ON** or **Timer OFF** button on the popup pallet.

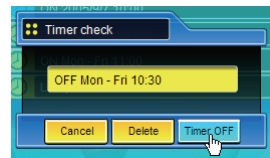

Button	Operation
Cancel	Cancels the setting
Delete	Deletes the timer event
Timer OFF	Disable the timer event temporarily
Timer ON	Enable the timer event

Notes on timer setting

Up to 10 timer events can be registered. Timer events always operate according to the next valid event depending on the projector's power status. In the example below, event 3 turns on the projector so next event 4 (also turning on projector) will not be effective because the projector is already turned on. Similarly, when the projector is turned off by event 5, event 6 OFF will not be effective in turning it off again. But these secondary events (event 4 and event 6) will become effective if a person turns off the projector (after event 3 and before event 4) or turns on the projector (after event 5 and before event 6).

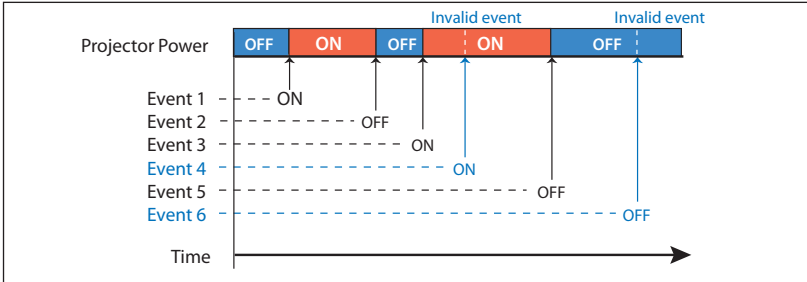

- When the timer events are set at the same time, the last event set will override the previous events. For example, if there is an event like "ON at 8:00 everyday" and then new event is set like "OFF at 8:00 everyday", only the last setting event is effective.
- When the timer event **ON** occurs during cooling down period, this is invalid event because the projector cannot be turned on during that cooling down period.



Projector information



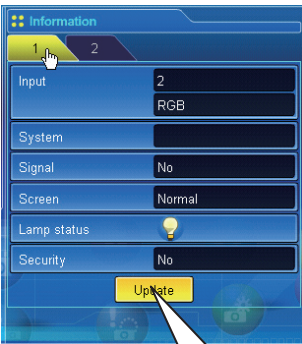



This page is to display the basic information of the projector status. Click **Information** on the main menu.



Click this button to update the information

Items	Description
Input.....	Displays selected input and source.
System.....	Displays selected signal system.
Signal.....	Input signal status
Screen.....	Displays screen mode.
Lamp status.....	Displays lamp status with an animation. Refer to the table on the next page.
Security.....	Displays the security (PIN code lock) status

Indication of the lamp status

Icon display/background	Status
 White-Yellow/Blue	Lamp on (Normal)
 White-Yellow/Red	Lamp on (Lamp is being used over a specified use time, replace lamp immediately)
 Gray/Blue	Lamp off (Normal)
 Gray/Red	Lamp off (Lamp is being used over a specified use time, replace lamp immediately)
 Red/Blue with X	Lamp failure (Lamp failure, check the lamp condition)
 Red/Red with X	Lamp failure (Lamp failure and lamp is being used over a specified use time, replace the lamp immediately)

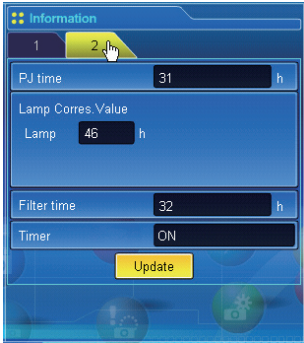

Items	Description
PJ time	Displays the accumulated use time of the projector.
Lamp Corres. Value	Displays the use time (Corresponding value) of the lamp.
Filter time	Displays the use time of the filter.
Timer	Displays the timer setting status.
	ON Timer has been set.
	OFF No timer setting.



Multi-control

Controlling and setting the multi-projectors

When you install multiple projectors in the network, you can control and set up them together. Click **Multi Control** on the main menu to display the control page.

Note:

To control the multiple projectors, each projector must be set the same Network PIN code.



Example of multi control

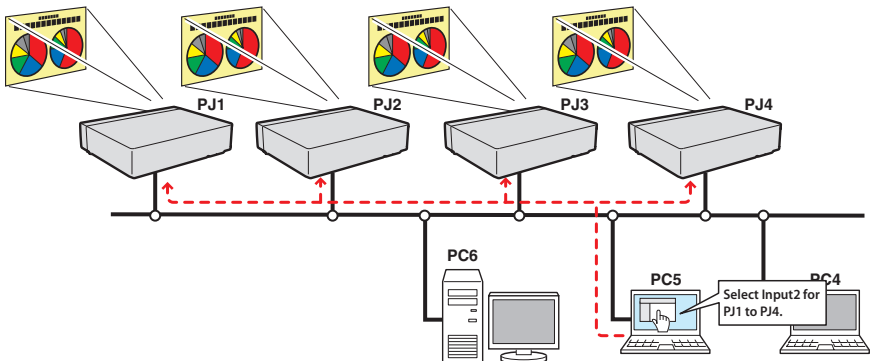

Start/stop the multi control

To start or stop controlling the multi-projectors, click Multi control setting menu and select ON or OFF.

Multi control setting

- OFFStops multi control function
- ONStarts multi control function. The multi control menu will appear when ON is set. These items of menu are linked to the main menu.

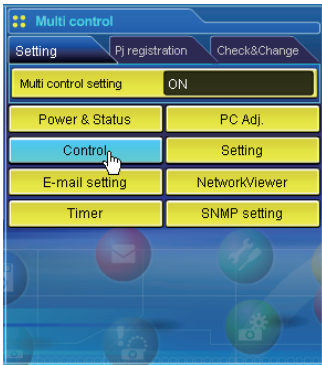
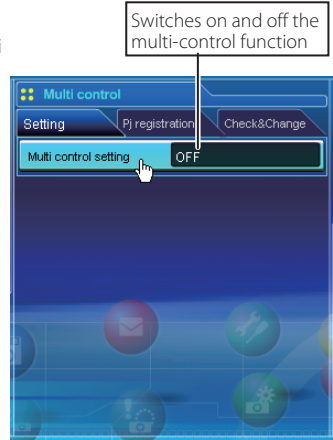
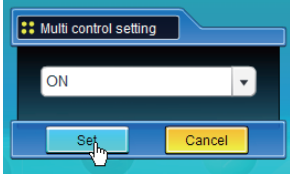

The multi controllable menus are "Power & Status", "PC adjustment", "Control", "Setting", "E-mail setting", "Timer", "SNMP setting" and "Network Viewer". Click each menu and perform setting and adjustment.

☞ The word "MULTI CONTROL" appears on the each control page while the multi control is operating.

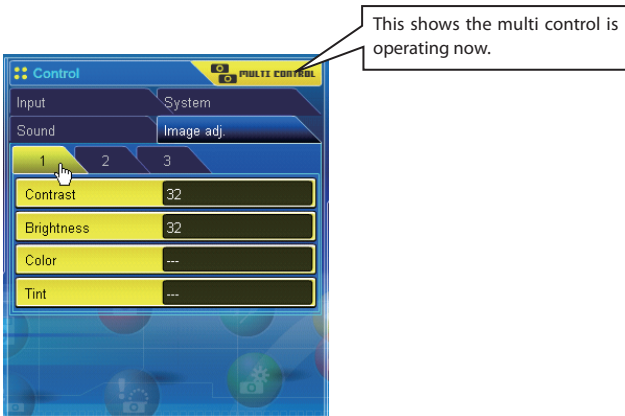

Register the projector

To use the multi control function, register the IP address of the projector you intend to control. Click Pj registration sub menu tab and set the IP address, Memo and Multi control item, then click **Set** button.

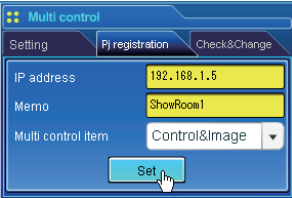

Items	Description
IP address	Enter IP address of the projector to control
Memo.....	Enter projector name or installed location etc.
Multi control item	
Control	Controlling the projector
Control & Image	Controlling and displaying images
Image.....	Displaying the images

Confirmation of registered projector

To check the registered information, click **Check & Change** sub menu tab. The registered information of the projector is listed as the below.

* The word "none" is displayed if the "Memo" function is used.

Name	Status	IP address	Multi control item
ShowRoom1	No connect	192.168.1.10	Control
Proj20	No connect	192.168.1.20	Control
Proj25	PINcode error	172.21.95.25	Control
Proj32	PINcode error	172.21.95.32	Control
Proj45	Control	192.168.1.45	Control
Proj10	Control	192.168.1.10	Control
Proj15	Control	192.168.1.15	Control
Proj27	Control	172.21.95.27	Control
Proj37	PINcode error	172.21.95.37	Control
Proj50	Control	192.168.1.50	Control

* When you click on a listed IP address, the login page for the selected projector will be displayed with a new window.

Click here to close the sub menu Check & Change.

Change the mode of the registered projector

To change the mode of the registered projector, select a mode with the pull-down menu button under the IP address of the target projector and then click Set button.

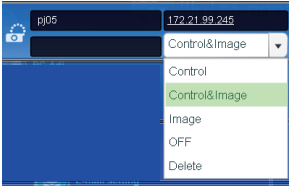

Mode	Operation
Control.....	Controlling the projector
Control & Image.....	Controlling and displaying images
Image.....	Displaying the images
OFF.....	Excluding from the multi-control
Delete	Deleting from the multi-control

* The multi control item is not changed during using the network viewer function. It is not available with the light mode.

Status

If some of the registered projectors are disabled by some reasons (such as disconnecting the power source, disconnecting the LAN cable, disconnecting from the network), control changes will continue to be effective for the projectors that are still active. At the same time, the deactivated projectors are excluded from the multi-control. The status of the registered projectors are indicated under the projector name. See the table below for status indications.

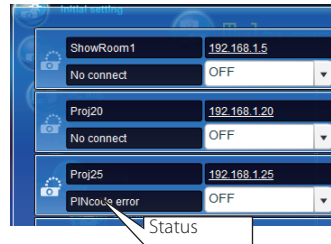

Status	Description
(blank).....	The projector is connected to the network correctly
No connect	The projector may not be connected to the network. Please check the connection and network configuration of this projector.
PIN code error.....	The PIN code is incorrect. The PIN code for the multi-controlled projectors must be the same. Change the PIN code of this projector to the common PIN code. (p.32, p.44)
File Error.....	Not displaying the images. Check if this projector is using the Network Capture function or Network Viewer function individually, or in the standby mode.

* The projector updates the status at the time when the multi-control function is executed.

- ☞ If the multi-controlled projector is in the standby mode, items of "PC adj.", "Control" and "Setting" cannot be operated.
- ☞ Cannot register, delete or change the multi-control setting during using the network viewer function.
- ☞ It is recommended that a specified projector should be chosen for setting as a master when you use this multi-control function. The control for the multi-controlled projectors will become too complicated operation if this function is used for each projector.
- ☞ If the registered projector is not connected to the network, it will take a while to complete the multi-control operation because of waiting for the response from each registered projector.
- ☞ There are some disabled items in the multi-control function for the light mode.

Check & Change page in the light mode

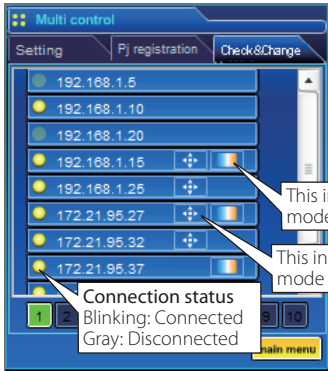

Following functions in the "Check & Change" page are not available in the light mode.

- Changing the control mode.
- Deleting the registered IP address
- Indicating the each status
- Indicating the each memo

This indicates that the mode is "Image".

This indicates that the mode is "Control".

(Check & Change page in the light mode)

Controlling all together

"Power & Status", "PC adjustment", "Control" and "Setting" can be controlled all together. Set "ON" the multi control setting and adjust controls of each menu. The setting value is applied to the registered projectors sequentially.

☞ This is effective only if the multi control item of the registered projector is set to either "Control & Image" or "Control".



Setting all together

"E-mail setting", "SNMP setting" and "Timer" can be set all together. Set "ON" the multi control setting and items of each menu. The setting value is applied to the registered projectors sequentially.

☞ This is effective only if the multi control item of the registered projector is set to either "Control & Image" or "Control".



Viewer auto setting all together

"Viewer auto display" can be set all together. Set "ON" the multi control setting and select [3] **Auto display** from **Viewer** sub menu (selected by 'Multi-control' - "Network Viewer" menu). Set the display time periods and repeat times for the auto image display. After clicking **Start** button, the registered projectors start playing back the auto image display in sequential.

- ☞ For further information of the Auto display, see "Using the network viewer function." (☞ p.124)
- ☞ This is effective only if the multi control item of the registered projector is set to either "Control & Image" or "Image".

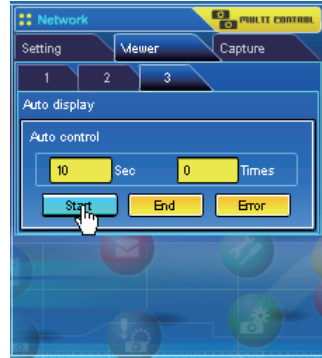

8. Network capture functions

Network Capture is a function to display the screen image and reproduce the sound of the computer via the network.

- Real Time Capture
- Network Communication
- Moderator Function

About Network Capture function

The Network Capture is a function to display the screen image and reproduce the sound of the computer which has a Network Capture 5 software by the projector through the network. This function has 3 kinds of mode as below.

- Real Time Capture (☞ p.93)

A function to display the screen image and reproduce the sound of the computer by the projector through the network in real time.

- Network Communication (☞ p.98)

This mode is to communicate by sharing the capture image of a computer with multiple computers and a projector. User can draw the text and figure on the captured image by using a drawing tool.

- Moderator Function (☞ p.107)

The moderator can project the participants' computer screen through the projector in meetings or in classes.

☞ Up to 30 computers can be registered.

☞ The Network Capture function cannot be used when the Network Viewer function is used. The Real Time Capture, Network Communication, Moderator function and Memory Viewer function cannot be used at the same time.

Start up the Network Capture 5

To start up the Network Capture 5, click "Network Capture 5" from "Start" - "All Programs" - "Network Viewer & Capture 5" menu. The application window will appear and search the projectors in the network and list them on the projector list.

If any projector is not listed, check followings and then search again by pressing **PJ Search** button.

- Is the projector turning on and connected to the network?
- Is the network setting of projector and computer configuring correct?
- Is the same capture port no. used among computer and projectors?

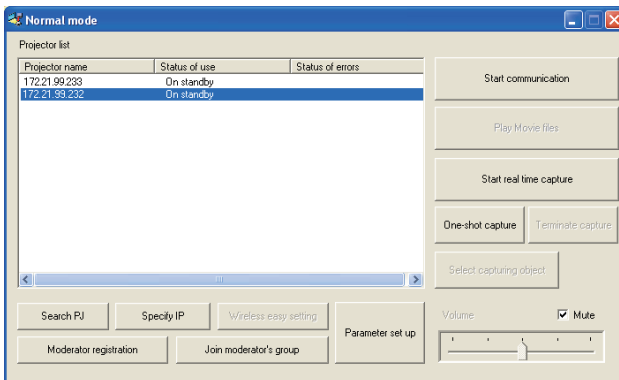

Commands on the task bar

When the **Network Viewer & Capture 5** icon on the task bar is clicked, the popup menu will appear. It provides according to the operating modes as shown in the table below.



Menu during Real time capturing

One-shot executing

Start real time capture	
One-shot capture	
Terminate capture	
<hr/>	
Window show..	
Version information..	
Shut down	

Real time capture executing

One-shot capture	
Terminate capture	
<hr/>	
Window show..	
Version information..	
Shut down	

Network Capture activating

Parameter set up...	
<hr/>	
Window show..	
Version information..	
Shut down	

Menu during Network Communication

Communication executing (Main PC)

Capture transfer	
Terminate Communication	
<hr/>	
Version information..	
Shut down	

Communication executing (Sub PC)

Start editing	
Terminate Communication	
<hr/>	
Version information..	
Shut down	

Communication executing (Sub PC)

Capture transfer	
End editing	
<hr/>	
Version information..	
Shut down	

Menu during Moderator function

One-shot executing

Start real time capture	
One-shot capture	
Terminate capture	
<hr/>	
Window show..	
Version information..	
Shut down	

Real time capture executing

One-shot capture	
Terminate capture	
<hr/>	
Window show..	
Version information..	
Shut down	

Joining in Moderator's group (client PC)

Leave moderator's group	
<hr/>	
Version information..	
Shut down	

Items	Description
Start real time / Terminate capture.....	Starts / Terminates the real time capturing. (☞p.93) The screen image of the computer is projected on the screen in real time.
One-shot capture.....	Transfers the one-shot screen image of the computer.
Capture transfer.....	Transfers the screen image of the computer to the projector. The captured image edit window appears on the computer screen.
Select capture object*.....	Sets to display the capture window selection dialog. * This menu will appear when "Select capturing object" is checked on the parameter setting. (p.92)
Terminate communication.....	Terminates the network communication.
Start editing.....	Acquires the screen image in the network communication and displays it on the editing window on the computer.
Terminate editing.....	Terminates the editing window of the network communication.
Terminate Play movie files.....	Terminate the Play movie files.
Parameter set up.....	Sets the communication parameter between the computer and projector. For further information, see item "Parameter set up" on the next page.
Window show.....	Displays the application window on the screen.
Version information.....	Displays the version of this software.
Shut down.....	Quits the Network Capture 5 application.

Parameter set up

Click **Parameter set up** button and setup the parameters on the Parameter setup window.

Items	Description
Connection setting	
Capture port	Sets the capture port no. on the projector. Default is 9000.
Pincode	Sets the Network PIN code on the projector.
PJ search time	Sets the time to search the projector between 1 to 60 seconds. Default is 5 seconds.
<input type="checkbox"/> Search PJ when starting up Network capture	Check if Search PJ automatically starts when launching the network capture function.
<input type="checkbox"/> Select normal network adapter	Uses default setting. Default is un-checked.
<input type="checkbox"/> Auto-power on	The projector turns on and projects the computer's captured image on the screen automatically when the network capture is executed while the projector is in the standby.

Image setting

Display adapter.....	Provided for the use of a computer with multiple network adaptors installed. Select a network adaptor which has the computer's screen to project with the projector and execute the network capture function. This is useful function when you make the presentation.
Select capturing object	Check if you want to select an individual window on the computer screen. This is useful function when you open the multiple windows on the computer's screen. When you execute the capturing, the window selection dialog appears. Select a window name from the dialog window. The projected window size is automatically adjusted to fit the projector's screen size.
Sharpness.....	Select a capturing picture quality among "High", "Medium", "Low"
<input type="checkbox"/> Reduce image	Check if the capturing image resolution is more than projector's panel resolution (XGA),
<input type="checkbox"/> Layer window capture.	Check if layer window image capturing.
Capture start up time	Sets the delayed time from the capture start in second.

Moderator function setting

Nickname	Sets moderator's nick name
Moderator login password ..	Sets Moderator's password

Play Movie files setting

Repeat times..... Sets repeat times of the playing movie files. If set to "0", loop play the movie file lists endlessly.

- ☞ To check the Capture Port number, see item "Control by the web browser" (☞ p.95). To check the PIN code, see item "Network PIN code setting" (☞ p.32, p.44).
- ☞ Specify the port number of TCP/IP. The default port setting is 9000. There are some reserved port numbers and also some applications may use their own port numbers. If one of those port numbers is used, the alert dialog window will appear and let you know that it is an invalid port number. In that case, use another port number.
- ☞ The reserved port numbers are http (80), ftp (21), telnet (23), (25), (110), etc. The port no. 4352, 10000, 10001 are reserved to control the projector through the LAN port.

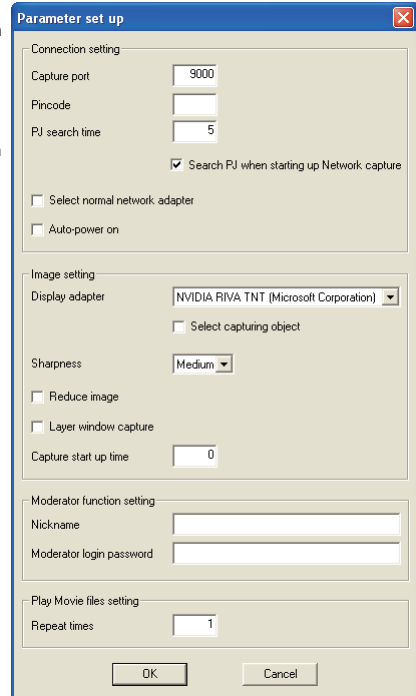

Using the Real Time Capture

This is a function to project the screen image and reproduce the sound of the computer by the projector in real time. The captured image projected by the projector can be selected from the computer, web browser and the projector respectively.

Registering the computers

Up to 30 computers can be registered.

- 1 Access to the control page of the projector by using the web browser. From the **Network** menu, click **Capture** tab to display the setting page.
- 2 Switch to **Connection Setting** page by clicking the page number tab [3]. Enter the IP address of the computer to the PC number, and then click **Set** button. Click **Set** button to register the IP address for each page.



When you capture the screen image of the movie player software with the real time capture function, the projector may not be able to reproduce the sound. To reproduce the sound in the projector correctly, follow the procedures below;

- Start up the Network Capture 5 software first, start up the real time capture and then start up the movie player software.
- Terminate the movie player software first and then terminate the real time capture.

The registered computer enables to start capturing if only the Network Capture 5 is activated.

The transfer speed of the captured image using the Real Time Capture function is depending on the network environment and data volume of the image. It cannot be supported for movie pictures.

If you start capturing with the Select capturing object on the parameter set up window checked, the Select capturing object window below (right side) appears. Select the desired window title from the window list and click OK button.

If no window is opened, no window title is displayed on the window list as shown on the left figure. Even the new window is opened, the display of the Select capturing object window would not change. If you would like to capture the new window opened, click Update button to show the window title on the window list, select it and click OK button.

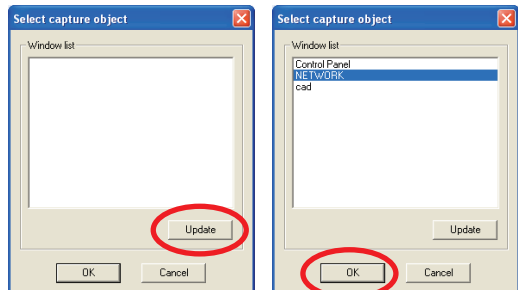

[1] Control by the computer

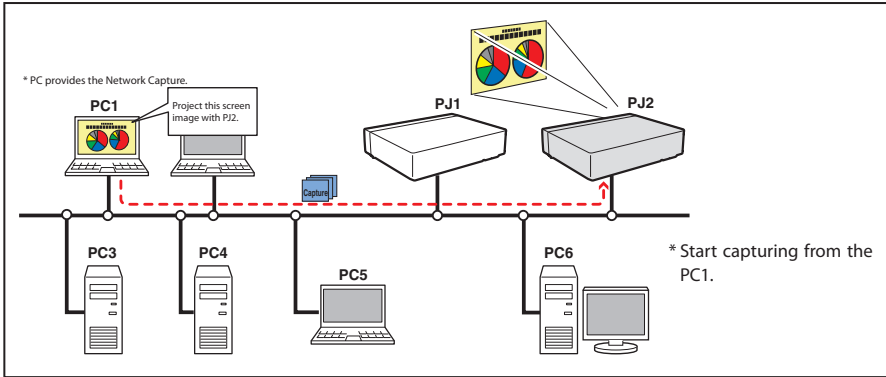

Select input mode to "Network" previously.

1 Start up Network Capture 5.

2 Select the projector(s) listed on the projector list on the application window and click **Start real time capture**. The application window will disappear and then the screen image of the computer will appear on the projected screen in real time.

* You can select multiple projectors (up to 5) on the projector list.

- To stop capturing, click **One-shot capture** on the popup menu appearing by clicking on the Network Capture 5 icon on the task bar. The captured image of the computer on the screen is frozen.
- To restart capturing, click **Start real time capture** on the popup menu.

3 To end capturing, click **Terminate capture** on the popup menu appeared by clicking on the Network Capture 5 icon on the task bar.

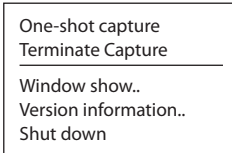

☞ If the error message appears, check the item "Parameter set up" (☞ p.92).

☞ The sound output from the projector can be controlled with the volume slider and mute item on the application window of the Network Capture 5 software (☞ p.25-26, p.92).

[2] Control by the web browser

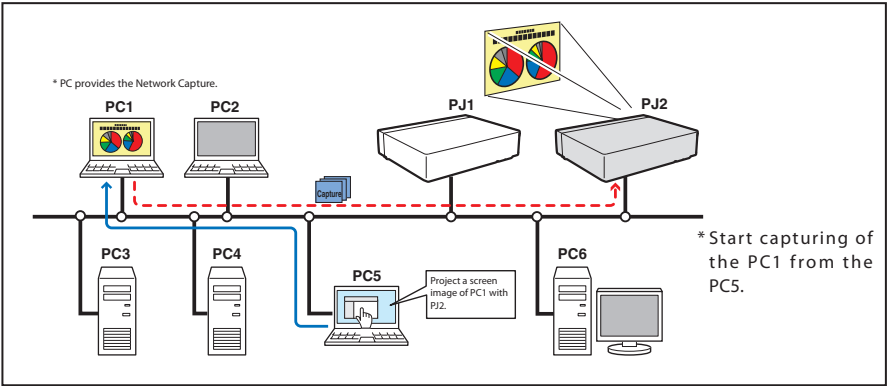

Select "Network" as input mode previously.

- 1 Access to the control page of the projector by using the web browser. From the **Network** menu, click **Capture** tab to display the setting page.
- 2 Select the computer number from the pull-down menu button of "Connecting PC" and click **Start** button. The screen image of the selected computer will appear on the projected screen in real time.
 - To stop capturing, click **One-shot** button. The captured image of the computer on the screen is frozen.
 - To restart capturing, click **Start** button.
- 3 To end capturing, click **End** button.

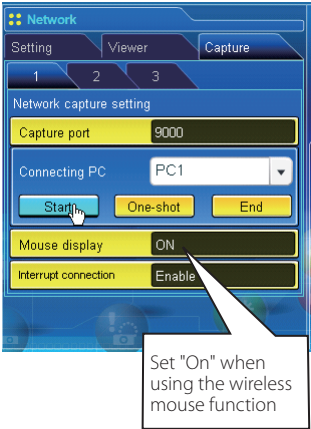

Item	Description
Interrupt connection.....	Set enable or disable the real time capturing connection from other computers during executing the real time capturing operation.

☞ The IP address of the connecting PC should be registered previously (☞ p.93).
 ☞ If the error message appears, check item "Parameter set up" (☞ p.92).
 ☞ To use the capture function from the web browser or projector, the Network Capture 5 on the captured computer must be activated.

[3] Control by the projector

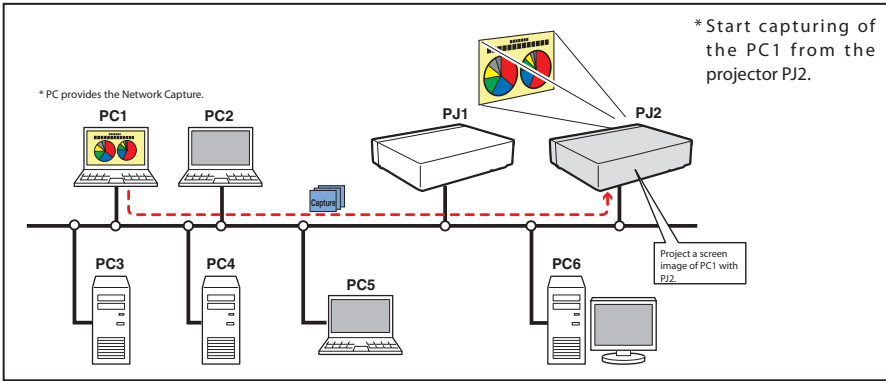

Select "Network" in the Input menu previously.

- 1 Select "Network capture" in the Network menu. Press Point **▶** or **SELECT** button.
- 2 Select "PC number" and press **SELECT** button and using Point **▲▼** buttons to select the PC number to connect, and then press **SELECT** button.
- 3 Select "Connected" and then press **SELECT** button to start capturing. The screen image of the selected computer will appear on the projected screen in real time.
- 4 To end capturing, select "Disconnect" and then press **SELECT** button.

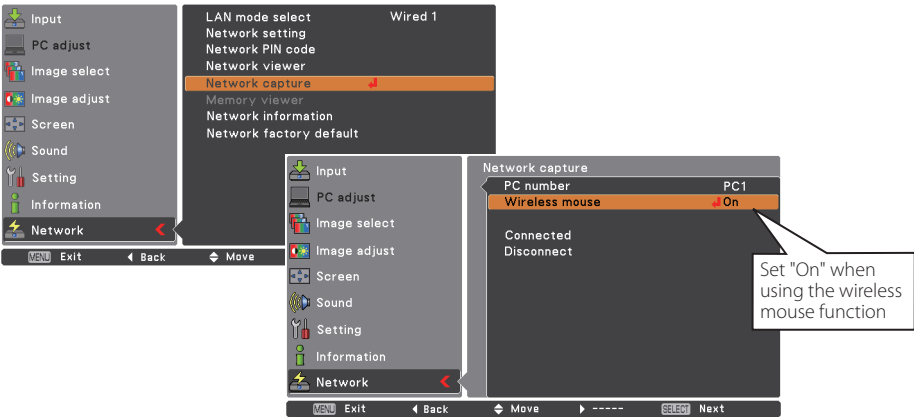

- ☞ The IP address of the connecting PC should be registered previously (☞ p.93).
- ☞ If the error message appears, check item "Parameter set up" (☞ p.92).
- ☞ The projector does not provide the function to register the IP address of the computer and to set the parameter of the capturing. They should be registered by using the web browser previously (☞ p.93).
- ☞ The remote control which is provided with the projector does not have the mouse operating function.

[4] Control by the computer with USB memory

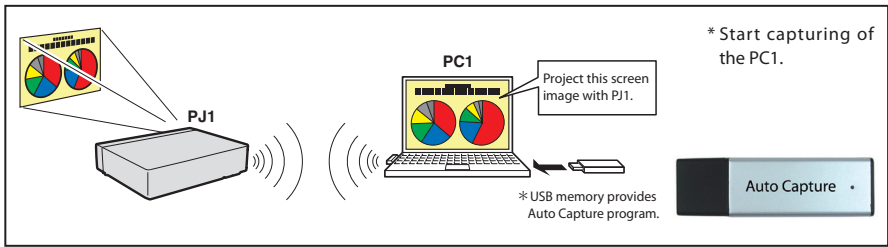

The real time capture function can run automatically on the computer without the Network Viewer & Capture 5 software installed by executing the Auto Capture program in the USB thumb drive connected to the computer. The USB thumb drive for Auto Capture is supplied with this projector.

1. Turn on the projector and select "Network" from the Input menu of the projector.
2. Select "LAN mode select" from the "Network" menu of the projector and press **SELECT** button. Select "Wired 1/2/3" or "Wireless Simple" with the Point ▲▼ buttons. (☞ p.43)
3. By connecting the above USB thumb drive, the removable disk window appears. Select "[Network Capture 5] Open Program using the program provided on the device." and then click **OK**.
4. Automatically, the activated executable file configures the Easy wireless setting. (If the network adaptor selecting window appears, select an option according to your network environment.) Then, it searches the projector, and starts the real time capture of the computer screen.
5. If the auto-run program does not start automatically, double-click "WinAutoCap5" in the USB thumb drive. (The auto-run program works only with Windows XP and Windows Vista.)

*The connection process of AutoCapture is different according to the equipped LAN adapter..

In case of only the wired LAN adapter is provided in the computer:
Connect to the network with the wired LAN adapter and search a projector.

In case of only the wireless LAN adapter is provided in the computer:
Change the LAN setting of the computer to SIMPLE and search a projector with the wireless LAN adapter.

In case of both the wired and wireless LAN adapters are provided in the computer:
When "Usually set it to a network adapter to use" is not checked; the network selection window is displayed.

6. For the following operations, refer to Page 94.

Setting condition for automatically starting the real time capture function	
Projector:	Power: On, Input mode: Network, LAN mode select: Wired 1/2/3 or Wireless Simple The searching result becomes only one projector.
Computer PC1:	- Log in by Administrative, - Activate WinAutoCap5 in USB thumb drive - The wireless LAN card or the wired LAN card: Provided, Network Capture 5 software: NIL - Before using wired LAN, the network settings should be completed.

- ☞ If the error message appears, check item "Parameter set up" (☞ p.92).
- ☞ When your computer provides multiple network adaptors, and "Select normal network adaptor" on the parameter setup window is un-checked, the network adaptor selecting window (☞ p.26) will appear.
- ☞ When plural projectors are found, the real-time capture will not start, but will become standby status. Release the wireless LAN SIMPLE setting of the projector which is not for the real-time capture.
- ☞ When the software of Network Capture 5 is not installed in the computer, the sound data is not transferred. If you want to transfer the sound data, install the software beforehand.
- ☞ If the specified files are copied in the root of commercial USB memory, you can also perform the AutoCapture (☞ p.147)..

Example of advanced use

Displays the presentation data stored in the computer by using the wireless mouse function from the projector.

1 Start capturing of the computer PC1 by using the projector.

Select "Network Capture" icon from the menu and select "PC1" and then select "Connect" (☞ p.96).

=> The Network Capture software installed in the selected computer will start capturing.

2 On the image of the PC1 projected on the screen, search a presentation file data stored in the PC1 by using the wireless mouse function of the remote control supplied with the projector.

3 Select a desired file and double click with the remote control .

=> The application by which the document was created starts and the projector projects the presentation picture on the screen.

4 Start the presentation.

=> By using wireless mouse function, control the page browsing and some other operations for the PC1.

☞ For further instructions of the wireless mouse, please refer to the projector's owners manual.

☞ On the projected screen using with the network capture, the shape of the mouse pointer differs from the one on the computer's screen.

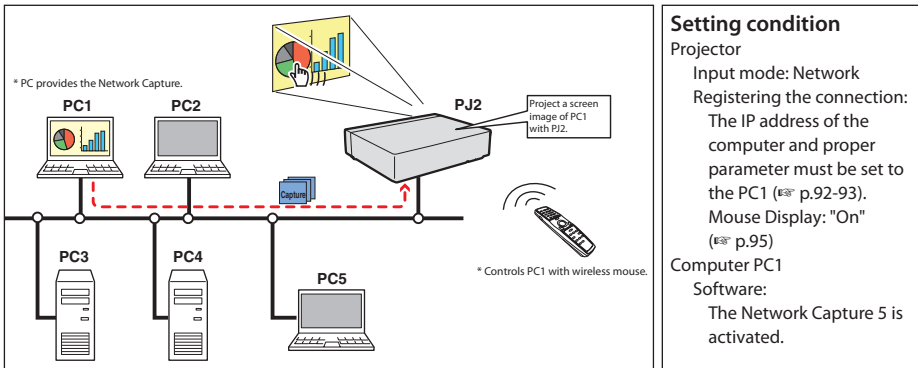

Using the Network Communication

This Network Communication is to communicate by sharing the captured image of a computer with multiple computers and a projector. Users can draw the text and figure on the captured image by using a drawing tool.

The data that has the captured image of a Main PC and communication information is sent to the projector. The projector projects this data onto the screen and serves this data to other computers (Sub PC) at the same time. The Sub PC receives served captured data and displays it on the screen. The Main PC and Sub PC also can edit the captured image by using the drawing tool. This edited image is applied to all the computers automatically.

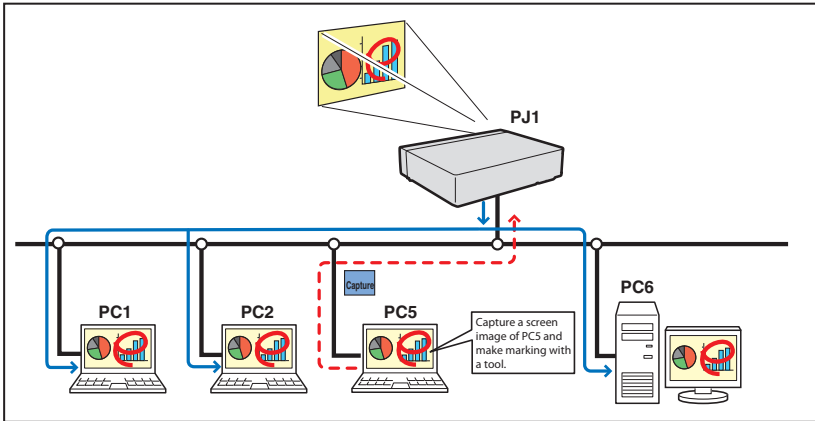

*The Main PC is a computer which started using communication function, and serves own computer screen captured image to the Sub PC. The Main PC has an authority to quit using whole communication. To become the Main PC, execute the command "Start Communication" or "Capture transfer". For further information, see item "How to use the Network Communication". (p.102)

*The Sub PC is a computer which receives a captured image from the Main PC. On the communication mode, the Sub PC can become the Main PC.

Settings before using the Network Communication

To use the Network Communication, the capture setting of the projector must be set either [1] or [2] as described below.

[1] Projector searches all the available subject computers in the network automatically.

[2] Subject computers are registered to the projector.

Perform capture setting following to the description below.



[1] When serving the capture data to all the subject computers in the network.

By using the web browser, display "Communication Setting" from menu "Network"->"Capture"->"Page 2". Confirm that the item Auto search subject PC is "ON". If "OFF", change mode to "ON".

* Projector can find up to 30 computers in the network.

[2] When serving the capture data to the specific subject computers in the network.

Set the item Auto search subject PC "OFF" described in the above and then display "Connection Setting" from menu "Network"->"Capture"->"Page 3" with the web browser. Enter the IP address of subject computer and click **Set** button to register.

* Up to 30 computers can be registered to the projector.



☞ To display the served capture data, the software Network Capture 5 must be installed on the computer.

Description of capture editing window

Start Network Capture 5 and select the projector(s) on the projector list on the application window and click **Communication Start** button. The application window will disappear and the capture editing window will appear on the computer screen as below. For basic operation of each menu, refer to the item "Menu tree" below.

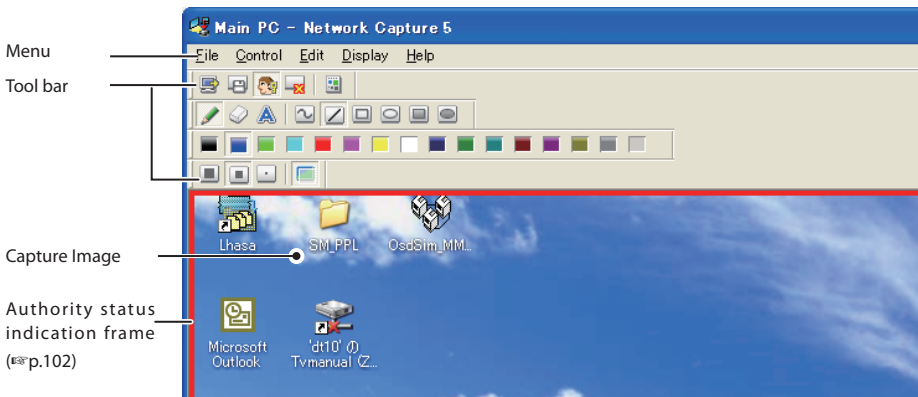

Menu tree

Menu	Submenu	Operation	
File	Save Communication	Saves a captured editing image as the data(JPEG) Saves dialog window appears	
	Terminate Communication * main pc only	Quits the communication mode	
	End Editing * sub pc only	Closes the Editing window	
Control	Capture transfer	Captures a screen image and sends it to the projector	
	Authority	Acquires/releases the authority to edit the capture image	
Edit	Tool	Pencil	Selects a pencil tool
		Eraser	Selects an eraser tool
		Letter frame	Selects a letter frame tool
		Form (Shape)	
	Form (Shape)	Free	Draws line with freehand
		Straight line	Draws straight line
		Square	Draws square
		Oval	Draws oval
		Square(Painting out)	Draws filled square
		Oval(Painting out)	Draws filled oval
Attribute	Appears a attribute window		
Delete all	Deletes all the drawings on the image		
Undo	Cancel the last executed operation		
Display	Full screen	Switches capture editing window, normal or full screen	
	Tool bar	Standard	Switches standard tool buttons on or off
		Form(shape)	Switches form(Shape) tool buttons on or off
		Color	Switches color tool buttons on r off
		Attribute	Switches attribute tool buttons on or off
Display on foreground	Keeps capture editing window on foreground always		
Help	Version information	Displays software version number	

Tool bar button names

The following commands are assigned to the tool bar buttons. For each operation, refer to the description of the item "Menu tree".

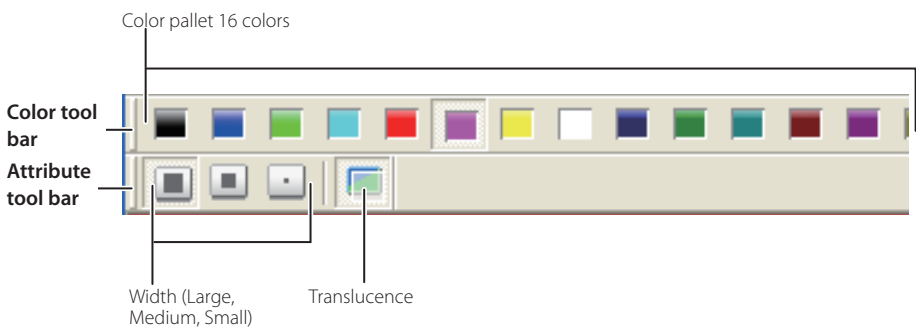
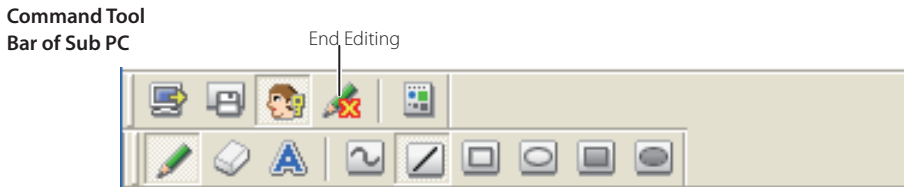
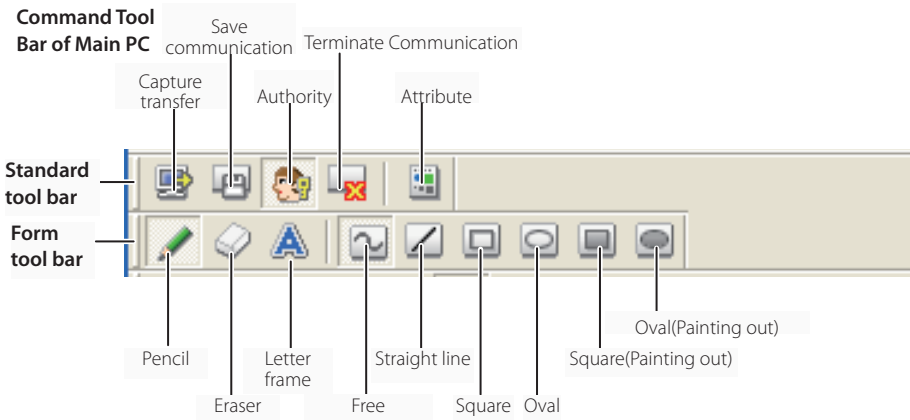

- ☞ To switch the tool bars displaying on or off, select each command from menu "Display"->"Tool bar".
- ☞ User can realign and join the tool bars (Standard, Shape, Color, Attribute), and change it to the floating pallet by a drag and drop of the tool bars.
- ☞ There are some disable buttons depending on the tools and authority mode. In that case the button appears in gray.

How to use the Network communication

Start the communication

- 1 Display an image on the computer screen.
- 2 Start Network Capture 5. The application window appears and the projectors in the network are listed.
- 3 Select the projector(s) and click **Start Communication** button. The application window disappears and the capture editing window with a captured image appears on the computer screen. The projector displays captured image on the screen.
 - ☞ If an error message appears, check the item "Parameter set up". (※p.92)

Join the communication (only for Sub PC)

- 1 Start Network Capture 5. The application window appears and lists the projector in the network.
- 2 Select a projector whose status on the projector list indicates "Communication starting", and click **Start communication** button. The application window disappears.
- 3 Click **Start editing** menu on the popup menu appeared by clicking the Network Capture 5 icon on the task bar. The capture editing window with a captured image appears on the computer screen.

Exit from the communication (only for Sub PC)

- Click ":End editing" button on the standard tool bar. The capture editing window will be closed.
- ☞ This command is available with the Sub PC only.
 - ☞ When "End editing" with the authority provided is executed, the authority will be released.

End the communication

- Click ":Terminate Communication" button on the standard tool bar. The capture editing window will be closed.
- ☞ This command is available with the Main PC only.
 - ☞ The communication cannot be ended while other PC has the authority. To end communication forcibly, click the Capture 5 icon on the task bar and select "Shut down" on the popup menu.

How to acquire and release the editing authority

To edit the capture image, each computer needs to acquire the authority respectively. To acquire the authority, click ": Authority" button on the standard tool bar and then edit the capture image. The capture editing window indicates the authority status by changing the frame color depending on the current authority mode as follows.

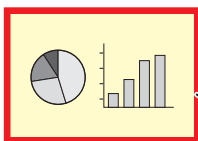

having an authority

Red

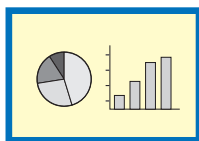

other computer having an authority

Blue

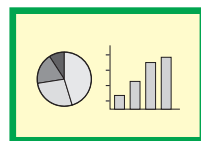

ready to acquire an authority

Green

Edit capture image

Drawing figures

- 1 Click "  :Pencil" button on the form tool bar.
- 2 Select its attribute (shape, width, color and translucence) from the form and attribute tool bar.
- 3 Drag a mouse pointer on the screen image to draw the figure.

Erase drawn objects

- 1 Click "  :Eraser" button on the form tool bar.
- 2 Select its attribute (shape, width) from the form and attribute tool bar.
- 3 Drag a mouse pointer on the screen image to erase the figure.

Hints of the drawing

- ☞ Straight line tool.....To draw the vertical line or horizontal line, drag a mouse pointer with shift key pressed.
- ☞ Square tool.....To draw the quadrature, drag a mouse pointer with shift key pressed.
- ☞ Oval tool.....To draw the perfect circle, drag a mouse pointer with shift key pressed.
- ☞ To cancel the drawing, select command "Edit"->"Undo" from the menu.
- ☞ To erase all the drawing at once, select command "Edit"->"Delete all" from the menu.
- ☞ The popup menu appeared by right clicking of the mouse is also available to select the tool and change the attribute.

Setting of the drawing tool attribute

When clicking "  :Attribute" button on the standard tool bar, the following window will appear. This window appears only if the pencil or eraser tool is selected.

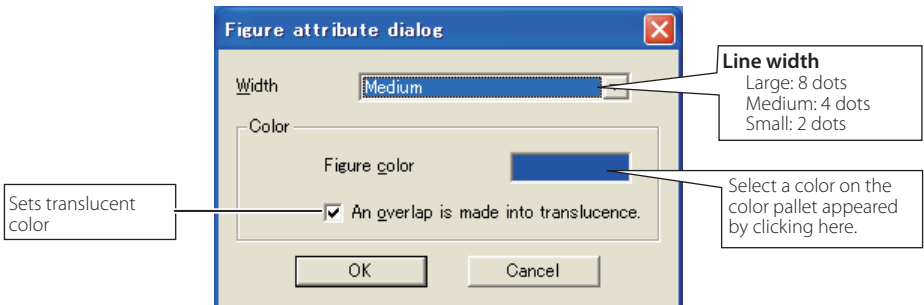

Drawing letter

- 1 Click "Letter frame" button on the form tool bar.
- 2 Select a color of text with color tool bar.
- 3 Drag a mouse pointer on the screen image to specify the area of the letter frame. The letter input dialog window will appear.
- 4 Enter the letter onto the window.
To change the letter attribute, click **Letter attribute** button. See the item "letter attribute setting" below.
- 5 Click **OK** button to fix the content. The entered letter appears on the captured image.

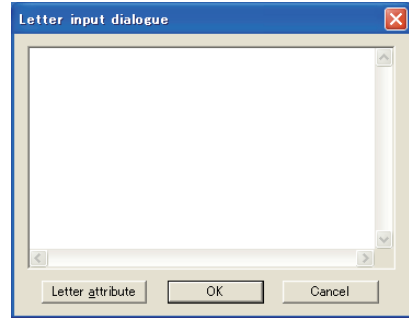

- ☞ If the entered letter overflows the area of letter frame, the letter frame is automatically extended downward.
- ☞ Up to 1000 characters can be used for a letter frame.

Letter attribute setting

The font attribute setting window appears when clicking "Attribute" button on the standard tool bar with the letter frame tool selected, or clicking **Letter attribute** button on the letter input dialog window described the above.

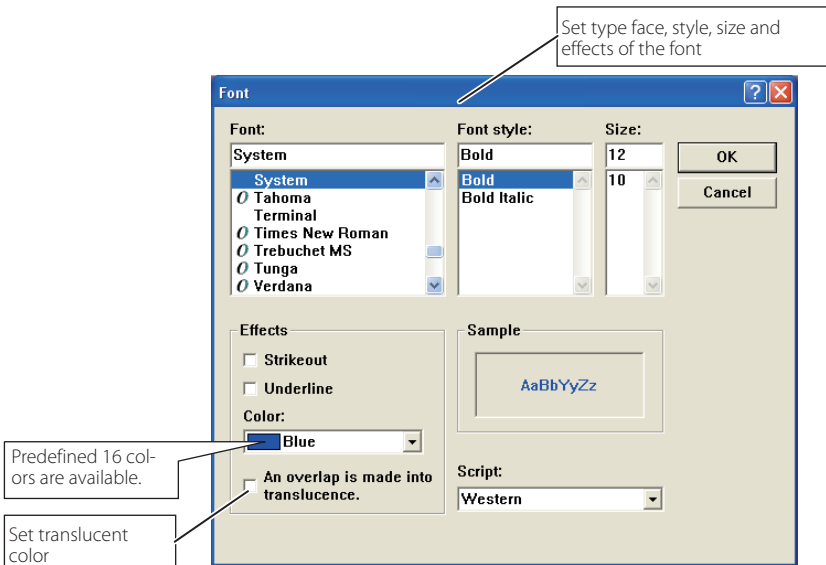

Network Communication operation and change of state

Network Communication can be used under the environment which one or more computers are connected to the projector via the network.

Preparation

Start up the Network Capture 5 software on the subject computer. Set standby the projector or turn it on. Check IP address of the subject computer is registered in the connection list (☞p.99).

		Operation on the Main PC		Operation on the Sub PC	
On the Communication	① Executing the command "Start Communication". → The capture editing window appears on the screen.	R	① Executing the command "Start Communication". Execute the command "Start Editing" on the task bar. → The capture image on the Main PC appears on the screen.	B	
	② Editing the capture image. → The editing information is automatically transferred to the Sub PC.	R	→ The editing information on the Main PC is reflected on the Sub PC.	B	
	③ Releasing the editing authority. → The color of authority status frame changes green.	G	→ The color of authority status frame changes green.	G	
	→ The color of authority status frame changes blue.	B	② Acquiring the authority. → The color of authority status frame changes red.	R	
	→ The editing information on the Sub PC is reflected on the Main PC.	B	③ Editing the captured image using with the tools. → The editing information is automatically transferred to the subject PC.	R	
	→ The color of authority status frame changes green.	G	④ Releasing the editing authority. → The color of authority status frame changes green.	G	
	④ Acquiring the authority. → The color of authority status frame changes red.	R	→ The color of authority status frame changes blue.	B	
	⑤ Repeat steps ②, ③ if required.		⑤ Repeat steps ② to ④ if required.		
	⑥ Executing the command "Capture transfer" on the task bar. → Updating the editing window with a new captured screen image.	R	→ A new captured screen image appears on the editing window.	B	
	⑦ Repeat steps ② to ⑤.				
	⑧ Ending the communication. → The capture editing window disappears.	R	→ The capture editing window disappears.		

- ☞ The projector projects the edited captured image on the screen when the input mode of the projector is set "Network".
- ☞ The command "Save Communication" can be executed in any of the mode even if the PC does not have the authority.
- ☞ The arrow (→) shows a response to the command executed.
- ☞ The execution of the command "Terminate Communication" or "End Editing" on the Sub PC has no effect on the other subject computers.

Executing the forcing mode

The network capture setting of the web page provides a forcing executing command. This command executes the release of authority or ending the communication forcibly. This is useful when the other subject PC keeps an authority all the time, or when the condition of the communication is not stable. Click page 2 **Communication Setting** from the menu "Network"->"Capture". Execute command by clicking the button **Free**, **Quit** or **Update**.



Displays IP address of the Main PC

Displays IP address of the computer has a editing authority

Item	Description
Free.....	Releases the editing authority forcibly → Sets condition which all the users can acquire an authority
Quit.....	Quits the communication forcibly → The capture editing window on all the computers closes forcibly.
Update.....	Acquires the latest communication status → Updates the IP address of the Main PC and Update authorized PC.

Moderator function

This function is useful for a moderator or a teacher to conduct a meeting or a class, where all the participants including the moderator (teacher) are assigned a computer, to project images from each participant's computer. A moderator (teacher) has the right to decide which computer image should be projected. One moderator (teacher) can conduct up to 50 computers.

This function enables you to project the participants' data directly in a short time and in real time without taking time to transfer the data to the computer connected to the projector.

The image data will not be limited by the computer's application because the data transfer of each computer adopts the screen capturing system.

Names and terms used in this chapter have following meanings.

Moderator	Moderator or teacher
Client	Participant of meetings or the classes
Network Capture 5	The application which the moderator and client use

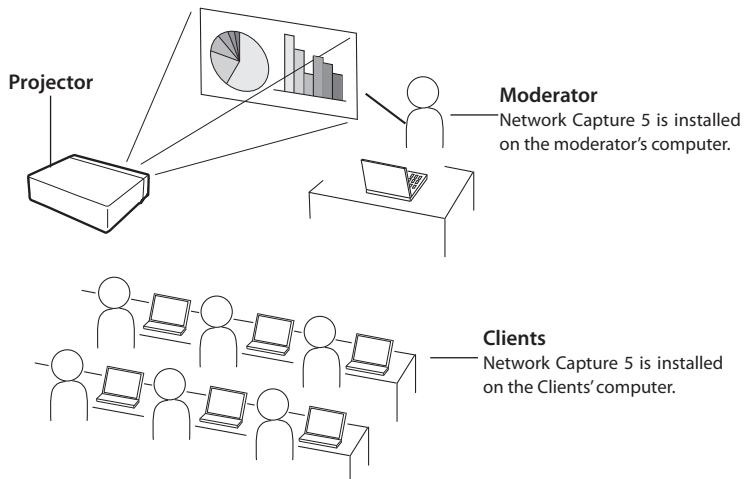

Preparation for using the moderator function

First, follow the procedure in "2. Setup Procedure" → "Step 1-3" (p.18) and confirm that the setting status is set as written below.

- Network Capture 5 is installed on the moderator's computer and each client's computer and each computer image can be projected.

Following application window appears when the Network Capture starts. After clicking **Moderator registration** button, the application window changes to "Moderator mode" window as shown in the lower picture below.

Normal mode application window

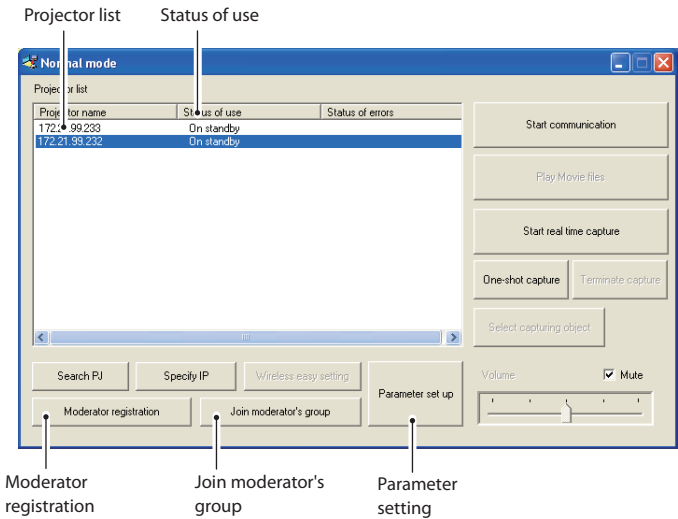

Moderator mode application window

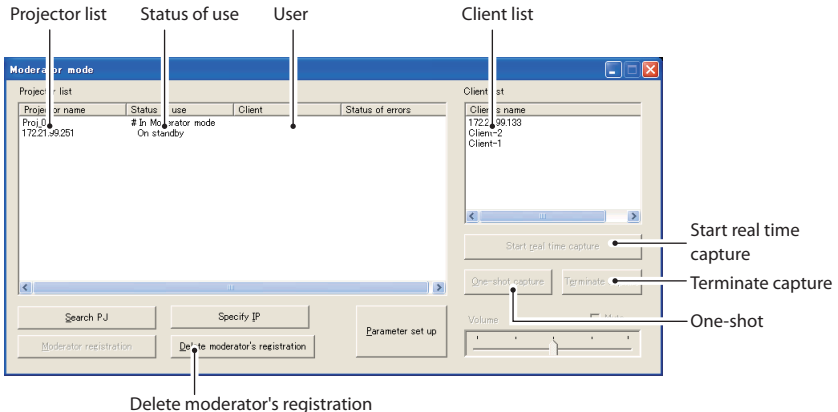

Description of application window

Column	Description
Status	Indicates the projector's condition. On real time, On One-shot capture, On Standby, In Moderator mode, etc.
User.....	Indicates the client name (nickname or IP address) used by the projector.
Error.....	Indicates the error status during executing the real time capture or one-shot capture.
Parameter set up ...	Sets the parameter of capturing. Moderator's nickname (less than 63 characters) and moderator's password (less than 15 characters) can be setup with this item. Also see the item "Parameter set up" (p.92) for other parameter setup.
Moderator registration ...	Register a moderator's group
Delete moderator group ...	Quit a moderator's group
Join moderator's group ...	Join a moderator's group. Press this button after selecting the projector which is indicated with "In Moderator mode" on the status column.
Start real time capture..	Capture (Project) the computer screen in real time. After the execution of "Start real time capture", and the application window disappears.
Terminate capture.....	Terminate the real time capture.
One-shot capture.....	Copy and capture (project) the computer screen without modification. After the execution of One-shot, the application window disappears.

* See item " 3. Names and function of the operating screen " (p.25) for other description of application window.

Using the moderator function

Moderator operation

1. A moderator starts up the Network Capture 5. On the application window, select a projector on the projector list to use and then click **Moderator registration** button. The mode of the application window changes from "Normal mode" to "Moderator mode".

Client operation

2. Each client starts up the Network Capture 5. On the application window, select a projector which is indicated with "In Moderator mode" on the status column and then click **Join moderator's group** button. The application window disappears.

When exiting from the moderator's group, click **Exit moderator group** on the popup menu appearing by clicking the Network Capture 5 icon on the task bar.

Exit moderator's group
Version information..
Shut down

Moderator operation

3. The client's and moderator's nicknames or IP addresses of the computer appear on the client list of the application window of the moderator when the client joins into the moderator's group.
4. The moderator selects a projector on the projector list and selects a client computer on the client list to display the client computer's screen.

When you register the multiple projectors in the moderator's group, select a projector on the projector in the moderator mode and click **Moderator registration** button to register it in the moderator's group one by one.
5. Click **Start real time capture** or **One-shot capture** button. The selected projector projects the selected client computer's screen on the screen.

When you project the capture image with the multiple projectors, select projectors on the projector list by holding the [Ctrl] key or [Shift] key.

The moderator and the clients can start the meeting with Moderator function.

Moderator's password setting up

This enables you to set up the password to join in the moderator's group.

Start up the network Capture 5 and click **Parameter set up** button on the application window. On the moderator function setting item on the parameter set up window, set up the password of **Moderator 's password**. Up to 15 characters can be used for the password. Default password is blank.

Following password input window appears on the screen when the client clicks **Join moderator's group** button on the application window to join in the moderator's group.



Enter a password and click **OK** button. When the password is authenticated correctly, the client can join in the moderator's group. The input password is registered in the moderator's password of the client.

Unregister moderator status

1. Select the projector(s) which is registered as a moderator from the moderator mode application window.
2. Click the **Delete moderator's group** button. Selected projector will be unregistered on a moderator, and the application window changes "Normal mode". The column of status changes from "#On Moderating" to "On Standby". When there are multiple projectors to unregister, the application window maintains "Moderator mode" until all the registered moderator's groups are unregistered.

* Even after the moderator is unregistered, the application window of the Network Capture 5 appears on the screen to indicate that the moderator function is unregistered.

* After terminating the Network Capture 5, all the clients joined in the session will be unregistered.

Error information

Error messages	Cause and corresponding
Set up the parameter.	Error when the communication is executed. The parameter setting (host name, capture port) has not been set. → Check parameter setting (☞p.92)
It has not been registered to PJ as a group.	Error when Start Communication or Start real time capture is executed. The IP address of the computer has not been registered. → Register the IP address by using the web browser (☞p.99)
Cannot be displayed as PJ is under display.	Error when Start Communication or Start real time capture is executed. The other capture, viewer or memory viewer function is now operating. → Wait until the communication function is available.
Cannot connect to PJ.	Cannot establish the connection with the projector when the Start communication is executed, Terminate Communication, Capture transfer, Start real time capture or Terminate capture. → Check connection of the network cable.
Cannot transfer data to PJ.	Cannot transfer the data to the projector when the Start Communication, Terminate Communication, Capture transfer, Start real time capture or Terminate capture is executed. The time-out period is 10 seconds. → Check the connection of the network cable.
Cannot receive data from PJ.	Cannot receive the data from the projector when the Start Communication, Terminate Communication, Capture transfer, Start real time capture or Terminate capture is executed. The time-out period is 10 seconds. → Check the connection of the network cable.
Other PC has authority. Cannot complete "Network Communication".	When executing the Terminate Communication, you cannot quit the communication because other computer has an authority
Other PC has authority. Cannot obtain authority.	Other computer has an authority.
Invalid port number	When the parameter is set, the reserved port number is specified. → Check the parameter setting (☞p.92)
PJ has not started Network Communication. Close the window and open it again.	The projector might have turned off during the communication. → Check the projector power and re-execute "Start communication".

9. Network Viewer functions

Network Viewer is a function to display the image data stored in the file servers by the projector through the network.

Describes the file converter software File Converter 1, File Converter 2, the program creator software Program Editor, and how to use Network Viewer.

Creating the available data [Network Viewer 5]

The image available with this projector is the JPEG format (.jpg). There are several types of JPEG data. Some data may not be projected. Before using the images with the Network Viewer function, it should be converted to the optimized JPEG data for this projector.

[1] How to use the Network Viewer 5 (File Converter 1)

The File Converter 1 is a software to convert the images from the JPEG, bitmap or Power Point data to the optimized JPEG data for the projector.

Start up and quit the File Converter 1

To start up the File Converter 1, click "Network Viewer 5 (File Converter 1)" menu from "Start" - "All Programs" - "Network Viewer & Capture 5" menu.

To quit the File Converter 1, click on the close box on the upper right-hand of the window.

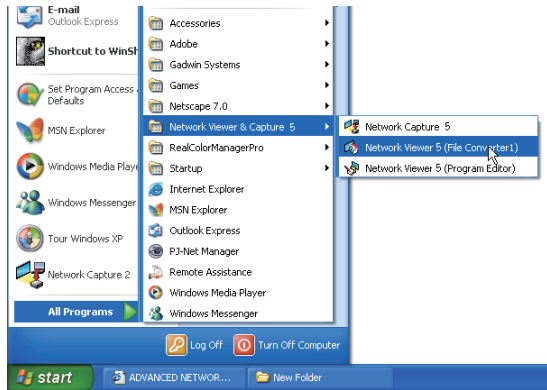

File Converter 1 window

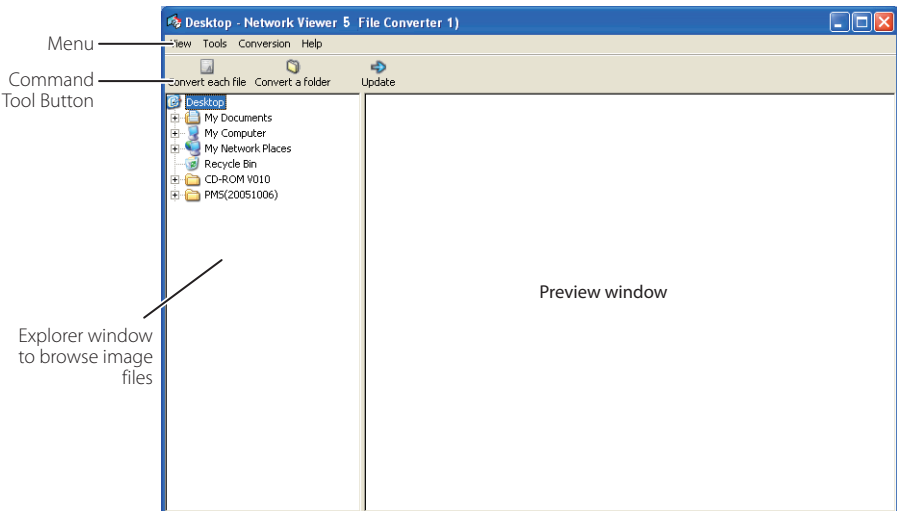

Menu Tree

Menu	Sub Menu	Description
View	Update	Updates contents of the preview window
	Preview size	Sets size of the preview image, Large, Middle, Small
Tools	Option	Sets default of the output destination and conversion mode
	Convert each file	Converts a file into a JPEG file individually
Conversion	Convert a folder	Converts files in a folder into JPEG files at once
	Version information	Displays the version information

Command Tool Button

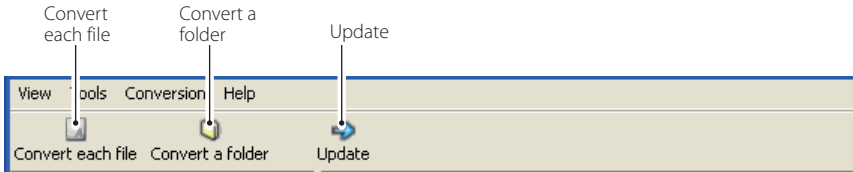

Creating the available data

I Select a folder in which the image files are stored by the explorer window.

The preview images of the available image data (JPEG file, Bitmap file, power point file) in the selected folder are displayed on the preview window.

On the preview window, the preview displayed with the red frame represents the unoptimized JPEG file nor Bitmap file for the projection. The preview without the red frame represents the optimized JPEG file for the projection. So you do not need to convert them again, but if you change the size or image quality, reconvert them.

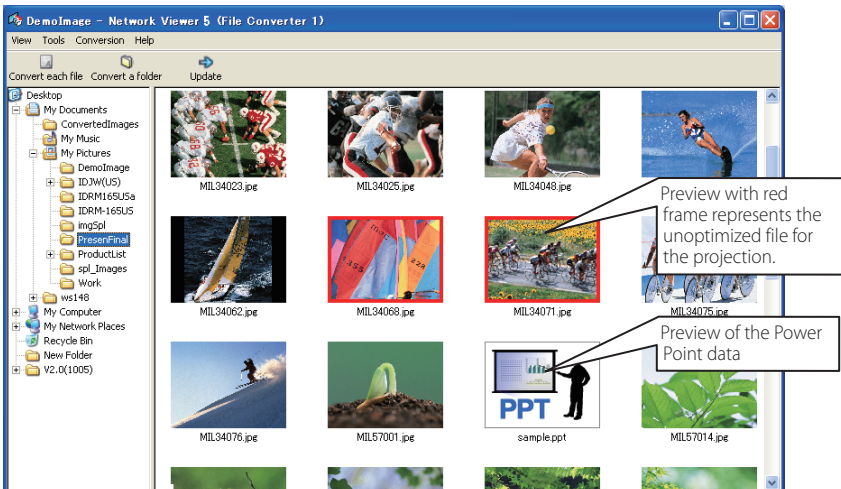

2 When converting each file, select a preview image first and then click **Convert each file**.

☞ To select two or more files at once, press and hold "Shift" key or "Ctrl" key and then click the preview images.

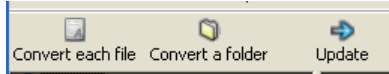

When converting all the files in a folder, select a folder and click **Convert a folder**.

3 As the confirmation window appears, check the conversion object and conversion type and then click **OK** button. The File converter 1 starts converting and stores the optimized files into the output folder. It enables you to select a local hard disk of your computer, shared computer in the network, and a directory of the FTP server. To change the conversion type or output destination, click **Change** button.

☞ If the power point file is included in the conversion object, the Microsoft Power Point software will start running and converting automatically.

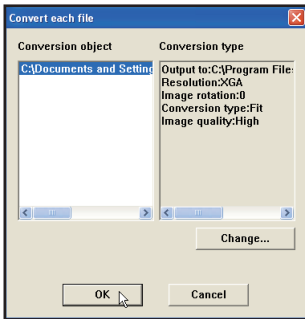

Dialog window shown during using "Convert each file" and "Convert a folder"

☞ To convert images from the power point file, Microsoft Power Point software is should be installed in your computer.

☞ In the power point file conversion, all the pages are converted into JPEG files separately.

Setting of output destination and conversion mode

When clicking **Change** button on the confirmation window in the step 3 on the previous page, following option setting window appears.

Output destination

Select either **Folder** or **FTP server** as the output destination of the converted files.

Folder

Output folderSpecify a folder in the local hard disk or shared computer in the network

FTP server

Host nameEnter host name or IP address of the FTP server

Root FolderSpecify the root directory of the FTP server. Normally use "/".

User IDEnter your login account of the FTP sever.

PasswordEnter your password of the FTP server.

Output folderSpecify a directory of the FTP server.

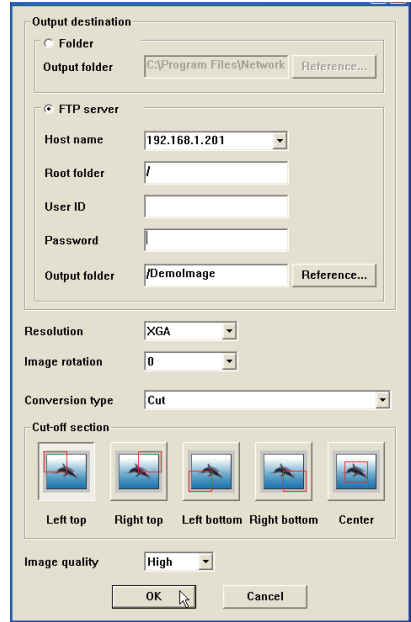

Conversion mode

ResolutionSelects output image resolution (VGA to XGA)

☞ The image resolution higher than the projector's panel resolution cannot be displayed.

Image rotationSelects image rotation (0, 90, 180, 270).

Conversion Type

Fit Converts either width or height of the image to fix the maximum screen width or height.

Justify

[both ends] Converts width of the image to fix the maximum screen width.

Justify

[top and bottom] Converts height of the image to fix the maximum screen height.

Cut Cuts image with the screen size not depending on the image size for the cutting modes. See the right figure.

☞ Select this mode when you want to have the images with the original size. Select each mode by clicking on the button.

Image QualitySelects an image conversion quality with "High", "Mid" or "Low".

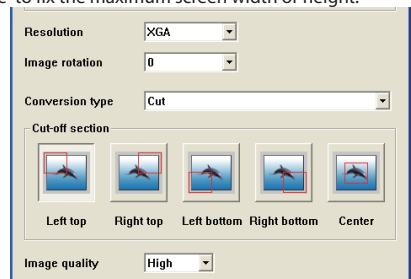

[2] How to use the Network Viewer 5 (File Converter 2)

The File Converter 2 is a kind of the printer driver software to convert to the optimized JPEG data for the projection from the any documents created by the other software such as text editor, spreadsheet or presentation software. It is possible to convert to the JPEG file from the any kinds of documents created by the software which has a "print" menu.

Creating the available data

- 1 Open a document with the individual software.
- 2 Select a "Print" sub menu and open the printing dialog. On the window, select "Network Viewer 5 (File Converter 2)" icon on "Select Printer" item and click **Print** button.

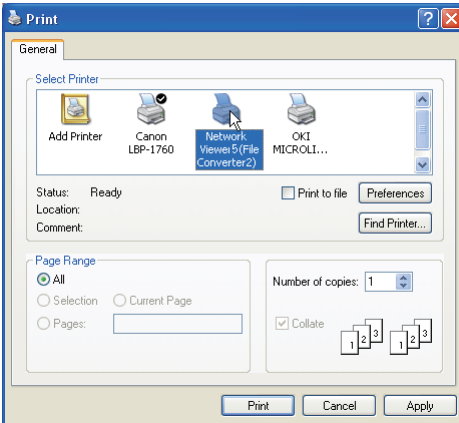

☞ Set the option setting for the page layout or paper setting by clicking **Preferences** button if required.

- 3 Select a folder and click **Save** button.

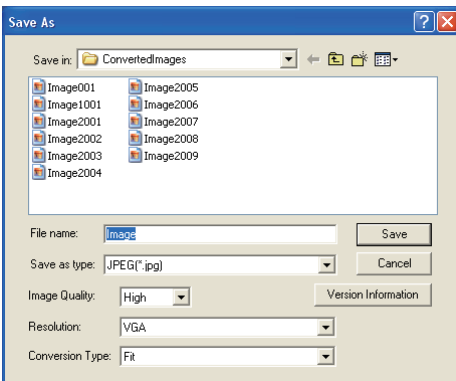

☞ The file name is named with "Image001" as default. If the converted image has 2 or more pages, the file names are numbered from "001" to "999" in serial order.

☞ Image quality and Conversion type can be set up on this window. For further information, please see "Setting of output destination and conversion mode" (☞ p.117).

☞ The white space may appear around the edges on the converted image depending on the type of the image data.

-
- ☞ The above procedure may differ in each computer environment and applications.
 - ☞ The image data over 2 M bytes cannot be projected with Network viewer 5.

Creating a program file [Program Editor]

Network Viewer 5 (Program Editor) is a tool to make a program file which specifies the display order of the images and its file path in the file server (FTP server). The Program Editor creates a folder "DispParam" at the login root directory in the FTP server, and files with each program name into this folder. These files are called "Program". By specifying the program file with the Network Viewer function, you can display the images in programmed order with the projector .

Procedure of making program

- 1 To start up the Program Editor, click "Network Viewer 5 (Program Editor)" menu from "Start" - "All Programs" - "Network Viewer & Capture 5" menu.
- 2 Click **Connect** button.
- 3 If the connection setting window appears, enter the each item and then click **OK** button.
The setting window disappears and then the programs are listed on the window if there are program files at the login directory in the connected FTP server.

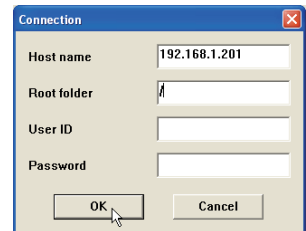
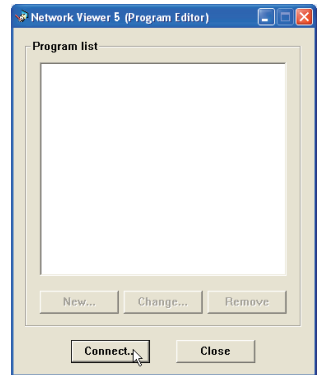

Item	Description
Host name.....	Enter the FTP server name or IP address
Root Folder.....	Specify the root directory of the FTP server. Normally use "/".
User ID.....	Enter your login account of the FTP sever or use blank when you login as anonymous account for the FTP server
Password.....	Enter your password (PIN code) or use blank when you login as anonymous account.

IMPORTANT

It is required to set the write permission mode for the login directory of the FTP server. In the read only mode, you will have an error when you register a new program.

4 Click **New** button.

5 Enter a program name and click **Add** button.

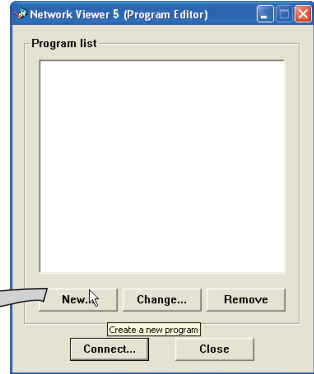
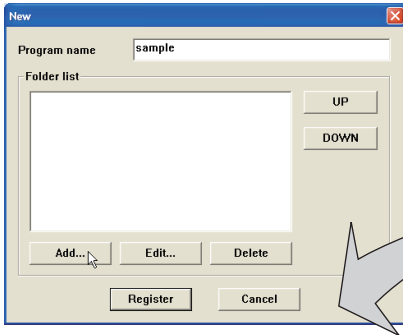

Change : Changes the contents of the program file.

Remove : Removes the program from the list.

6 The folder selection window appears and select a folder in which the JPEG data are stored and then click **Add** button to register into the folder lists.

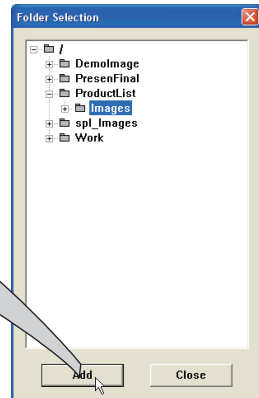
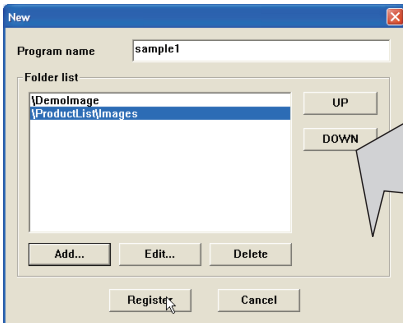

Add.....Displays the folder selection window.

Delete.....Deletes the folder path from the folder list.

UPMoves up the selected folder path.

DOWNMoves down the selected folder path.

EditUsed to set up the display order or display time of the image individually. For further information, see the item "Setting up the display order and time of the images" on the next page.

☞ The order of the display is listed in the folder list window. To change the order of the display, change the list order of the folder list by using **UP** or **DOWN** button.

☞ The programs are stored into the "DispParam" folder at the login root directory and this "DispParam" folder is made by software automatically.

7 Click **Register** button to register the folder list into the program.

8 Click **Close** button to quit the Program Editor.

Setting up the display order and time of the images

In the default setting, the display order of the images is the same as ASCII code order of the file name. To change the display order or to set up the display time, take the following procedures.

Display the folder list window in step 6 of the previous page.

1 Select a folder list contains images to change.

2 Click **Edit** button. The images in the selected folder are displayed with the file name on the index window.

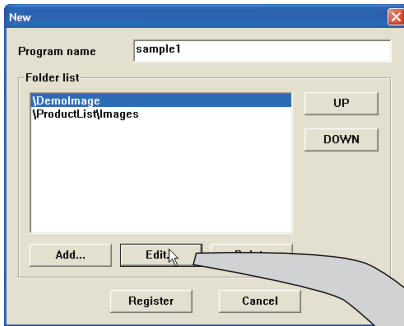

When "Image" from "View" menu is selected, the thumbnail of the image will be displayed (default setting). When "Icon" is selected, the icon image will be displayed.

☞ It takes a while to display thumbnails.

☞ The number in front of the file name indicates the display order of the image.

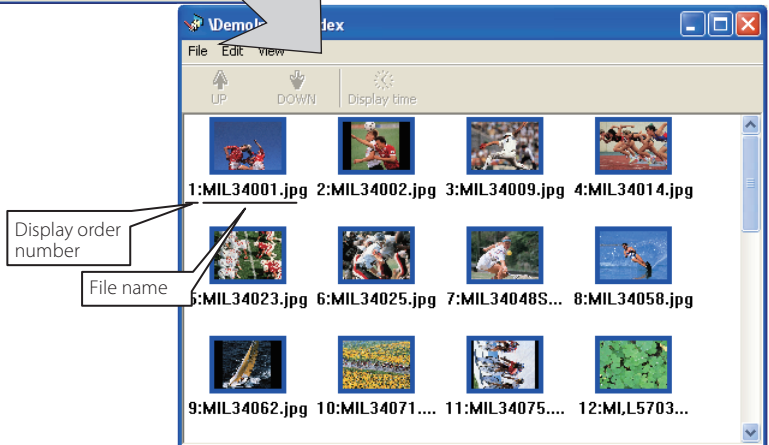

Menu	Sub menu	Description
File	Exit	Closes index window
Edit	UP	Steps up the display order of the selected images
	DOWN	Steps down the display order of the selected images
	Display time.....	Sets up the display time of the selected images
View	Image.....	Displays thumbnail of the images
	Icon.....	Displays images as the fixed icons
	Update.....	Updates images information on the index window

3 To change the display order, select*1 files and then click **UP** or **DOWN** button on the menu bar to move them onto your desired place, or select files and then drag and drop them onto your desired place with mouse.

4 To change the display time*2, select*1 files and then click **Display time** button on the menu bar to display the Display time setting window. Check "Display time" in the check box and set the display time. To cancel the display time, un-check the "Display time" in the check box.

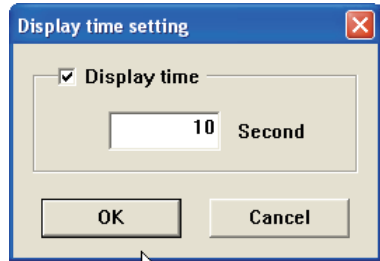
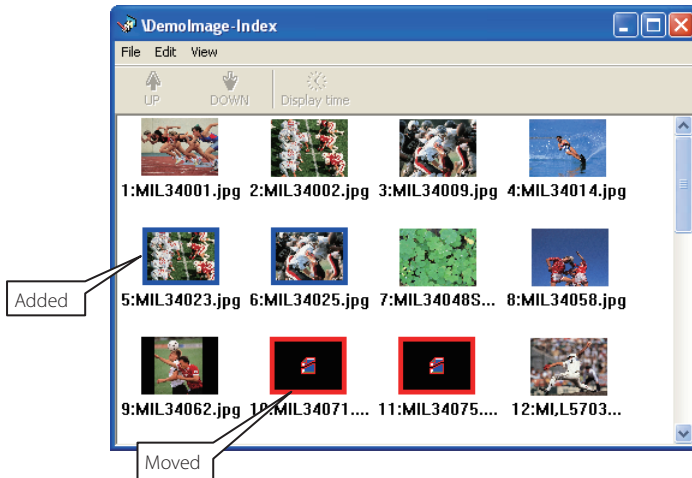

Image frame on the index window

Image frame on the index window has 3 kinds of display modes as follows.

- No frame : Shows that the image in the folder is unchanged
- Blue frame : Shows that image is added into the folder newly
- Red frame : Shows that image is deleted from the folder



*1 Multiple files can be selected at once by "Shift" or "Control" key, or with mouse cursor.

*2 3 to 240 seconds can be set up for display time.

Example of the created program selection

Use the web browser to access to the control page of the projector. Click "Viewer" of the Network menu on the web page, then connect to the FTP server and select the program name which was made at previous section. The projector starts displaying the images along the program. For further information, please see "Using the Network Viewer function" (p.124).

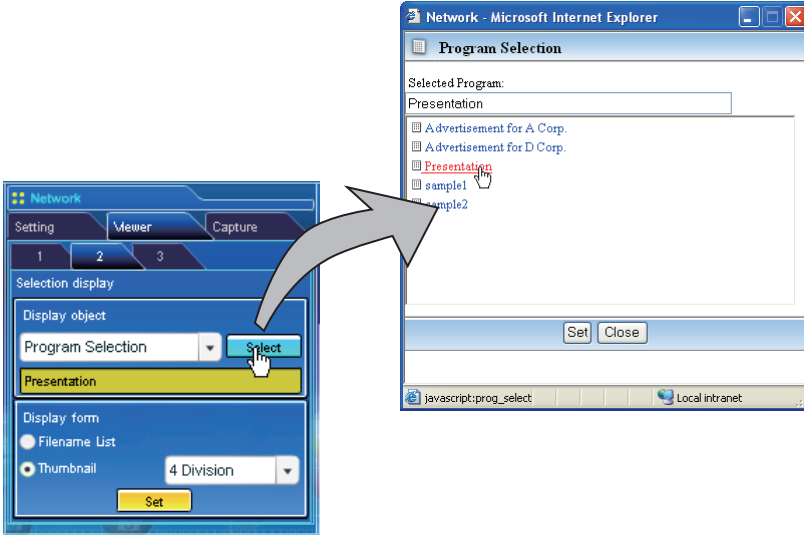

 This function is not available in the light mode.

The limitation of the Program file

There are several limitations for the program file as follows;

- * The number of programs in a root folder is less than 1000.
- * The number of folders in a program is less than 100.
- * Total characters of folder name is less than 255.
- * Total characters of program file name is less than 63.
- * Do not make a program name started with ".".
- * Do not make a program name contained with following characters:
 $\backslash / : ; * ? " < > |$
- * The program name started with "(space) is registered without the space.

Using the Network Viewer function

The Network Viewer is a function to acquire the JPEG image data from the file servers placed in the network and project them on the screen. The projected image data are specified by the folder unit. You can set the display time and the number of repeat, and also you can register those folders as the program. ***The network viewer function cannot be used when the network capture function is used.**

Condition to use the Network Viewer function:

- * Should be possible to use the FTP service with Windows 2000 Professional or XP Professional.
- * User has a full-access account to the FTP server, or the FTP server allows anyone to use with "Anonymous" account which also has a full-access mode.
- * The allowed number of simultaneous access from the same IP address is no fewer than 20.

To use this function, it is necessary to disable "pop-up block" function of the web browser.

[1] Control by the web browser

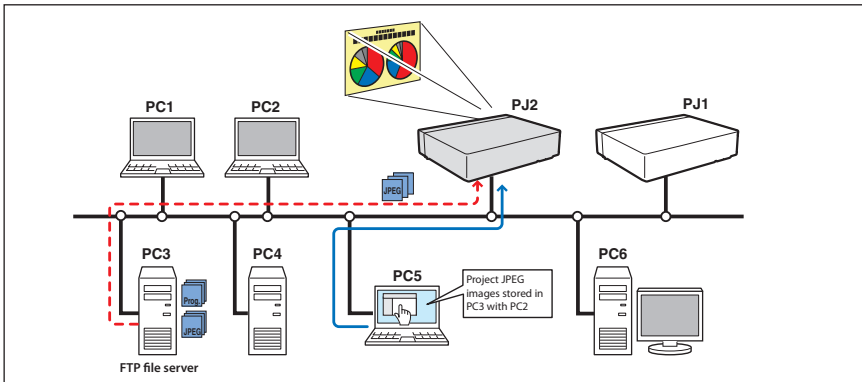

Select "Network" for input mode previously.

1 Access to the control page on the projector by using the web browser.

From the main menu, click **Network - Viewer** to display the setting page.

2 Setup the setting page [1] of the Visual display.

Item	Description
Host name.....	Enter the host name or IP address of FTP server, yourftp.server etc.
Folder Path.....	Use "/"(root directory) normally, or enter the directory name follow the "/" as shown in the below example if you have a specified directory in the server. /data/
User ID*1.....	Enter your login account of the FTP server
Password*1.....	Enter your password of the FTP server
Option*1.....	Set "Display ON" when you display the acquired preview images on the web browser.



3 Setup the setting page [2] of the Selection Display.

Click **Select** after selecting the display object from the pull-down menu "Folder Selection" or "Program Selection". After the list window appears, select a program or folder and then click **Set** on the window.

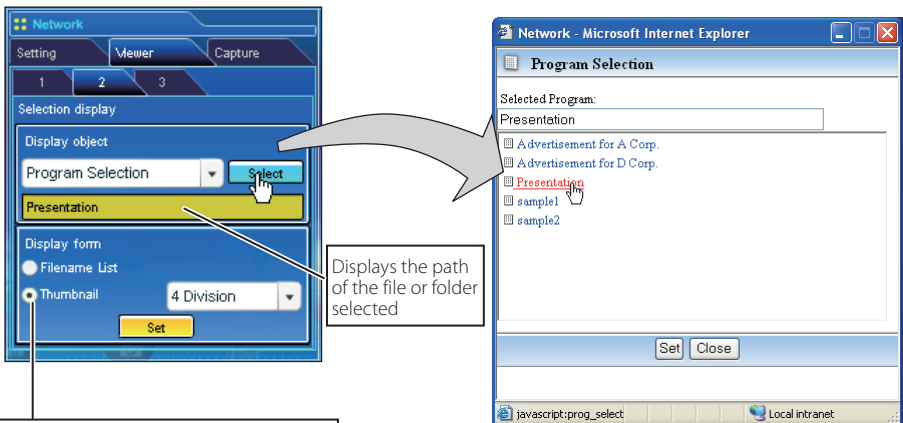

Selects the display type either the listed with file name or listed with thumbnail. The thumbnail can be selected "4 division", "6 division" or "9 division".

☞ This function is not available in the light mode.

☞ See the item "Creating a Program file [Program Editor]" (p.119) about program.

*1 IMPORTANT NOTICE

Please note that if you use the FTP server with personal account except anonymous account, the user ID and password may be displayed on the browser depending on the version of the browser. We recommend that this function should be used with the anonymous account normally.

After clicking **Set**, the file list or preview list of the selected folder or program is displayed on the window.

Button	Operation
<<.....	Go to the preceding start up image in the auto display function
>>.....	Go to the following start up image in the auto display function
List.....	Switches to the List mode
Thumbnail.....	Switches to the thumbnail mode
Close.....	Close the window

- ☞ This function is not available in the light mode.
- ☞ The preview image will not appear when the option is set "Display OFF".(☞p.125)

- ☞ Up to 1000 images can be displayed.
- ☞ When "folder selection" is selected, images placed at the first directory in the selected folder are displayed.
- ☞ The display order of the images is the same as the ASCII character order when "folder selection" is selected, or is specified by the Program Editor when "program selection" is selected. (☞p.119)

4 Auto Display setting and control page [3]

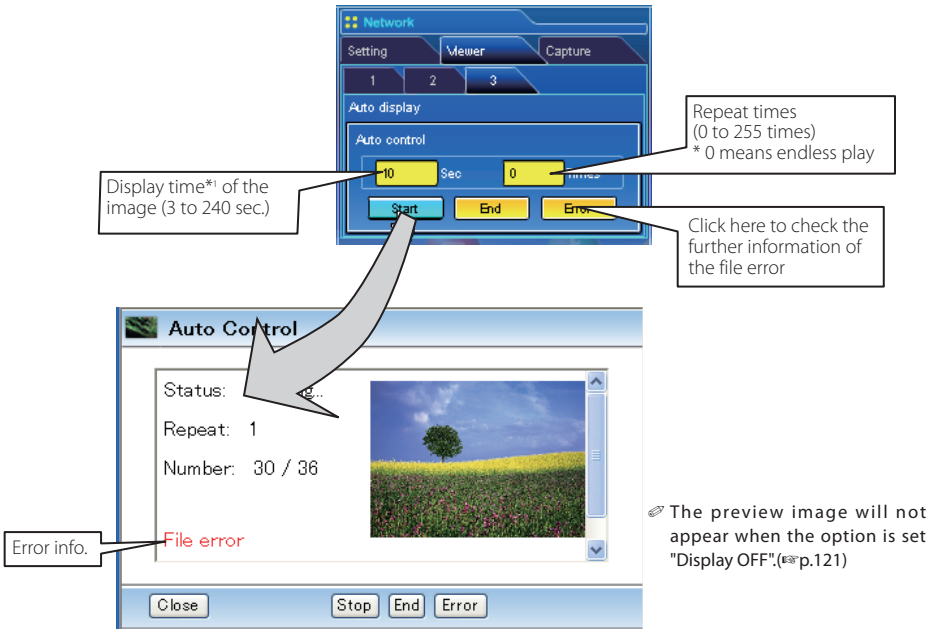

1. Click **Start** button to start the auto-display. The image in the selected folder or program is displayed on the projector's screen. The web browser opens another window and displays the preview images on the Auto Control window sequentially.
2. Click **Stop** button to stop the auto-display.
 - Restart the auto-display, click **Restart** button.
 - * When the auto-display stops, it enables you to display the images manually by using [<<] or [>>] button.
3. Click **End** button to end the auto-display.
 - When the **Error** button is pressed, the further information of the file error is displayed.

For further error information, refer to the next page.

*1 When the program file for auto-display is selected, the display time of each image gives preference to the setting specified by the program file over the setting specified by the auto-display function above. The images for which the display time is not set shows the display time specified by the auto-display function above.

☞ The display time is greatly affected by the network environment or the operation of multi control, so the image may not be displayed as the specified display time.

☞ The timing to switch images is not the same on the screen and on the web browser.

Error information

Error type	Description
File Error	It is displayed when the projector cannot acquire the correct file images from the FTP server, or when the master projector is turned off during the multi-control. Click Error button to check the details.
Connection Error	It may be displayed when the slave projector is using the Network Viewer or Capture function during the multi-control. Check which projector has an error , see item "Multi Control/Check & Change" (☞ pp.85-86).

☞ When the file error occurs during the auto-display, you may have the alert E-mail message. For further information, please see the item "3 Option selection for sending alert mail" (☞ pp.60-63).

[2] Control by the projector

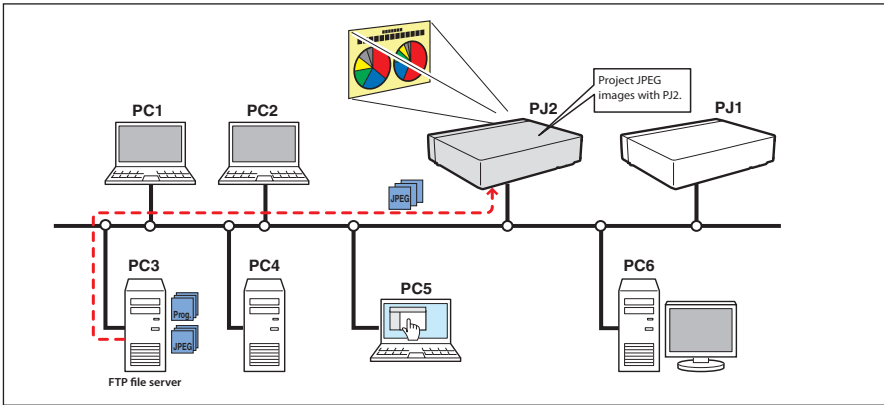

Select "Network" input mode previously.

I Select "Network Viewer" in the "Network" menu. Press Point ► or SELECT button.

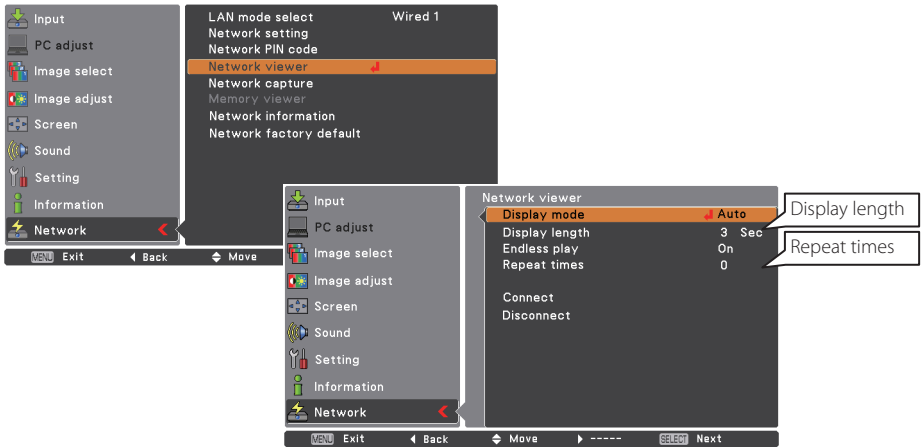

2 Select "Display mode" and press **SELECT** button, and then select "Auto" or "Manual" and then press **SELECT** button.

When selecting "Auto", set "Display length", "Endless play" and "Repeat times"

3 Select "Connect" and then press **SELECT** button to start displaying. The images in the FTP server are displayed on the screen.

☞ It enables you to browse the images by using the control buttons (▲,▼) on the remote control or on the projector.

▲ : Previous image display, ▼ : Next image display

4 To stop the display, select "Disconnect" and then press **SELECT** button.

Item	Description
Display mode.....	Sets display periods and repeating times
Auto	Displays image automatically by setting "Display length" and "Repeat times"
Manual.....	Controls image display (browsing image backward or forward) manually.
Display length.....	Display time of image (3 to 240 sec.)
Endless play.....	Sets "On" to play continuously
Repeat times.....	Repeat times (255 times maximum)
☞ "0" is displayed when "Endless play" is set to "On".	

☞ In the automatic displaying mode [Auto], when the left-click on the remote control is pressed, automatic displaying stops and the manual displaying mode is set. When the right-click is pressed, automatic displaying restarts.

☞ The image data used for this function is the program or folder that the Network Viewer function used last time. The projector cannot specify particular images or file servers itself.

☞ The display time is greatly affected by the network environment or the operation of multi control, so the image display may not be displayed as it is set for the specified display time.

Use of the projector as FTP server

You can use the projector in which a USB memory is inserted into the USB terminal as an FTP server. By using it as an FTP server, you can save the projection data that is converted by Network Viewer 5 [File Converter1, File Converter2] on the USB memory, and project the data with the Network viewer function in this projector or the other projectors.

Copy the data for projections to the projector which is put USB memory in.

1 Start the Explorer of the computer, and then enter the IP address of the projector in which a USB memory is inserted (for example, ftp://192.168.1.201) to the address column. Contents of the USB memory are displayed as follows.

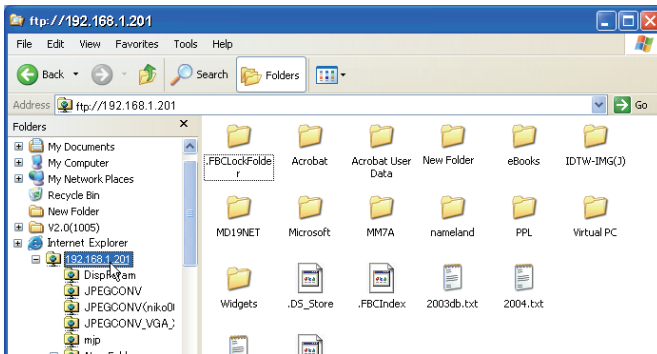

2 Copy the data for projections in USB memory.

Note:

If the network PIN code is set for the projector, the authentication window appears as below. In this case, enter "user" in the user name and enter the network PIN code of the projector in the password.

*Be sure to enter "user" in the User Name

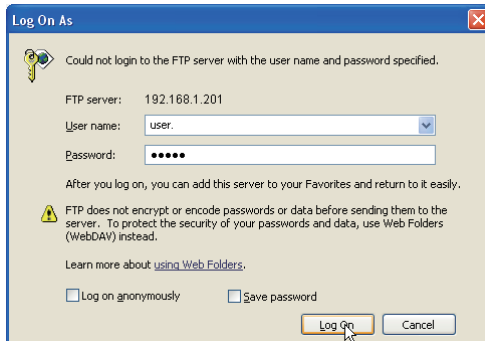

Output the converted file directly to the projector with the USB memory.

The file converted by Network Viewer 5 [File Converter 1] can be output directly to the projector with the USB memory. Refer to the "Creating the available data" for details of Network Viewer 5 [File Converter 1]. (p.114)

Specify "FTP server" as an output destination of the converted file in the "Option" dialog of Network Viewer 5 [File Converter 1].

FTP server

- Host name.....Enter host name or IP address of the FTP server
- Root FolderSpecify the root directory of the FTP server. Normally use "/".
- User IDIf the network PIN code is set for the projector, enter "user".
- Password.....If the network PIN code is set for the projector, enter the network PIN code.
- Output folderClick **Reference** button and select the destination directory on the USB memory.

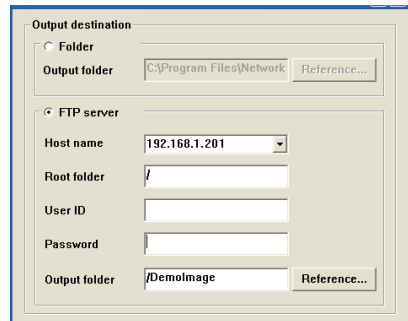

Output the program file directly to the projector with the USB memory.

The program file created by Network Viewer 5 (Program Editor) can be output directly to the projector with the USB memory.

For details of Network Viewer 5 (Program Editor), refer to "Creating a program file" (p.119).

- Host name.....Enter host name or IP address of the Projector
- Root FolderSpecify the root directory of the FTP server. Normally use "/".
- User IDIf the network PIN code is set for the projector, enter "user".
- Password.....If the network PIN code is set for the projector, enter the network PIN code.

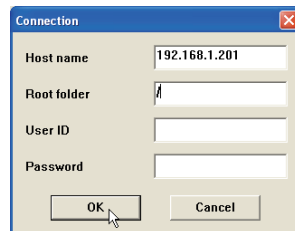

10. Appendix

Use of telnet

Web browser setting

Firewall setting

Troubleshooting

Terminology

Use of telnet

You can control the projector by using the telnet application¹⁾ installed on your computer. Normally, the telnet application is available on your computer.

*The telnet 10000 port is used to control the projector.

Control

(For example, in case of using the telnet application of the Windows XP Professional.)

1. Select **Run...** submenu from **Start** menu on the computer. Type "telnet" onto the **Open** text area on the displayed window and press **OK** button.

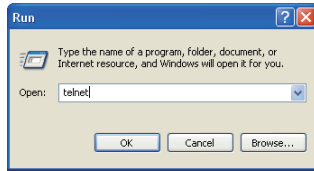

2. The telnet application will start and the following window will be displayed. Type as below to connect the projector.

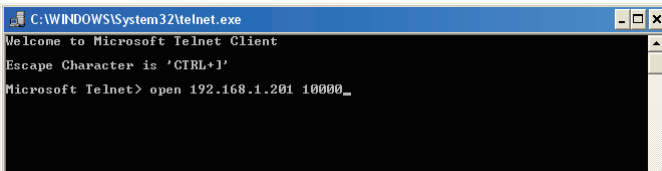

> open_192.168.1.201_10000 [return]

* Use the IP address assigned to the projector

3. When communication is established correctly, the word "PASSWORD:" appears on the window. Type the login password (Network PIN code²⁾) for the projector and then press "Enter" key on the

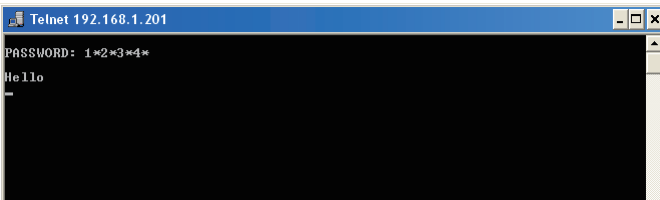

keyboard. If you do not set up the Network PIN code, just press "Enter" key.

When the word "Hello" is replied, login has been succeeded.

* The password "1234" is used for the example.

4. Type the commands, refer to below table, to control the projector and then press "Enter" key for termination. For example, type "C00" which is a command to turn on the projector, and press "Enter" key. Confirm the projector is turning on.

* Enter with ASCII 64-byte capital characters and one-byte characters.

To disconnect the communication, press "Ctrl" key and "]" key at the same time, type "close" and then press "Enter" key on the Keyboard.

> close [return]

The table below shows the typical command lists for controlling this projector and please consult your local dealer for further information of another commands.

Command list table

Command	Function
C00	Power on
C02	Power off
C09	Volume up
C0A	Volume down
C0B	Audio Mute on
C0C	Audio Mute off
C1C	Menu display on
C1D	menu display off

*1 Further instructions about the telnet application, please see the on-line guide on your computer.

*2 The password is a Network PIN code decided item "Network PIN code setting" (p.32, 44). If the authentication of the entered password is failed 4 times continuously, the communication will be disconnected automatically. Please try again for the connection.

*3 If the password or any command is not entered for more than 30 seconds, the communication will be disconnected automatically. Please try again for the connection.

Web browser setting

This product is designed to enable the projector to be set up and controlled from an Internet web browser. Depending on the preference settings of the web browser, some control functions may not be available. Please make sure that the following functions are set up properly in the web browser.

Active Script/JavaScript enable

There are some control items used with the JavaScript function in the setting pages. If the web browser is set not to use this JavaScript function, it may not control the projector properly. In that case, the following warning message will be displayed on the top of the page. To enable the JavaScript, please see further instructions on the next page.

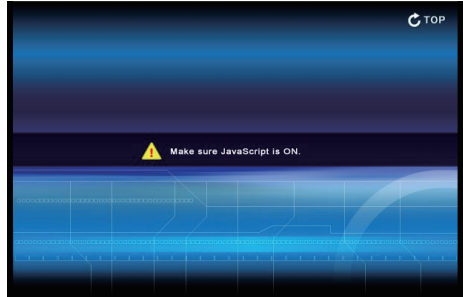

Flash Player enable

The setting page of this product contains the Flash contents. To display the setting page, the Adobe Flash Player version 6 or later is required to be installed on your computer. For further product information, see the Adobe homepage. (<http://www.adobe.com>). Even if your computer provides the Adobe Flash Player, the setting page does not appear on the web browser, in which case, check that Flash Player Plug-In(Shockwave Flash) is installed and set up correctly. Please see further instructions on the next page and it is depending on the web browser.

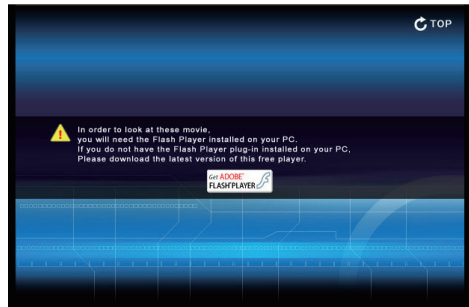

Proxy setting

In some cases, your web browser is set up to use the proxy server for the internet or intranet connection. In that case, when you install this product into the local network, you should set up the proxy setting of web browser preference correctly. Especially when connecting the projector and computer with a UTP cross cable directly, or when the network does not provide the proxy server, make sure that "not use proxy server" is set up in your web browser preference. Please see item "Examples: OS/Browsers" in the next page for further setting up procedure.

☞ There are various ways to change your browser preferences depending on the version or applications. Please see the setting instructions on next page showing examples and also refer to on-line help of your web browser.

Examples: OS/Browsers

Windows XP Professional

Internet Explorer v.6.0

ActiveScript setting

Select **Internet Options** from **Tools** menu on the web browser and then select **Security** tab and click **Customize Level...** button. On the security setting window, scroll down and find the **Scripting** item, make sure that "Enable" is selected in item **Active Scripting**.

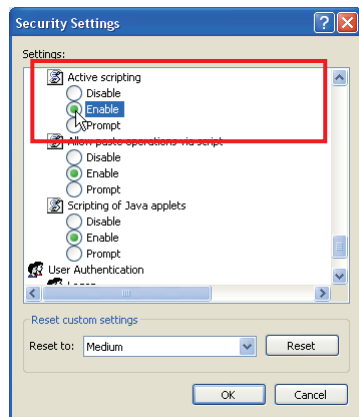
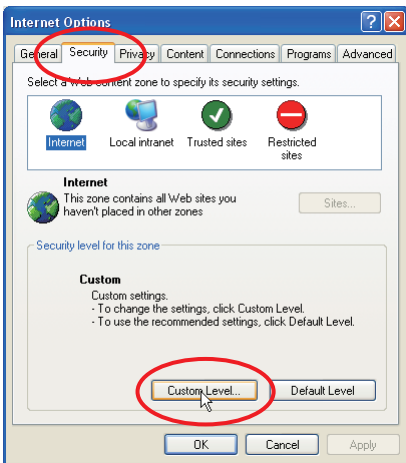

Flash Player enable

ActiveX controls and plug-ins setting

Select **Internet Options** from **Tools** menu on the web browser and then select **Security** tab and click **Customize Level...** button. On the security setting window, scroll down and find the **ActiveX controls and Plug-ins** item, make sure that "Enable" is selected in item **Run ActiveX controls and plug-ins**.

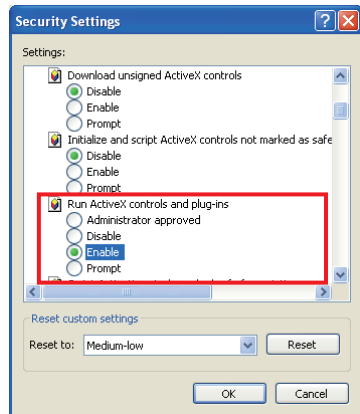

Flash Player Add-on setting

Select **Manage Add-ons...** from **Tools** menu on the web browser. Select "Add-ons currently loaded in Internet Explorer" from **Show** pull-down menu. Make sure that the "Shockwave Flash Object" is listed under the item "Enabled".

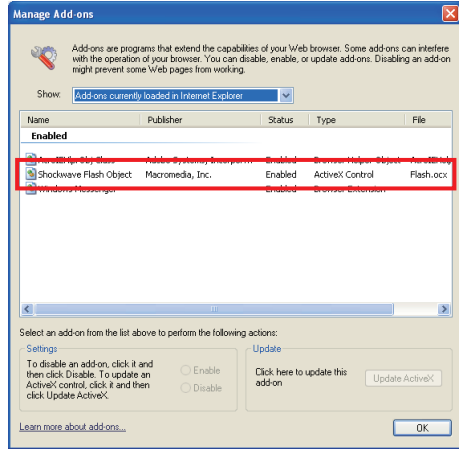

Proxy setting

Select **Internet Options** from **Tools** menu on the web browser and then select **Connection** tab and click **LAN Settings** button. Properly set up your web browser's the proxy server settings according to the local area network environment to which the projector is connected.

- Using proxy server

To use an external internet connection from the local area network, check the item **Use a proxy server** and enter the proxy server address and port correctly in the proxy settings window. For further instruction please consult your network administrator.

- Not using proxy server

Uncheck the item **Use a proxy server**.

If you connect the projector to the computer directly with UTP cross cable, it must be unchecked.

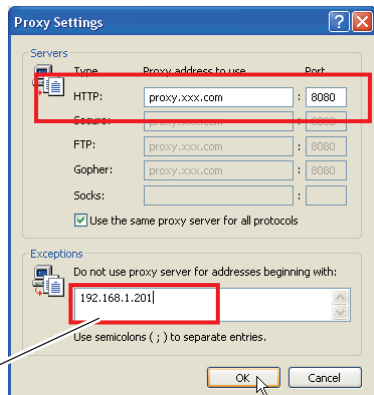
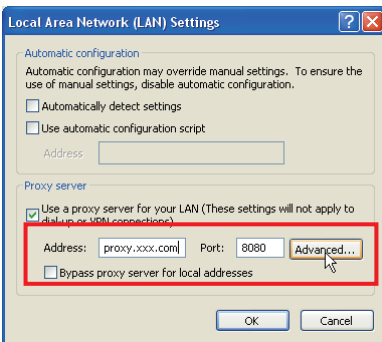

To designate proxy settings that will not use the proxy server when accessing the projector installed in the local area network, enter the IP address or domain name here.

Netscape Navigator v.7.0

JavaScript Setting

Select Preference from Edit menu on the web browser and then select the item **Advanced/Scripts & Plugins** in the **Category** column. Make sure that the **Enable JavaScript for Navigator** is checked.

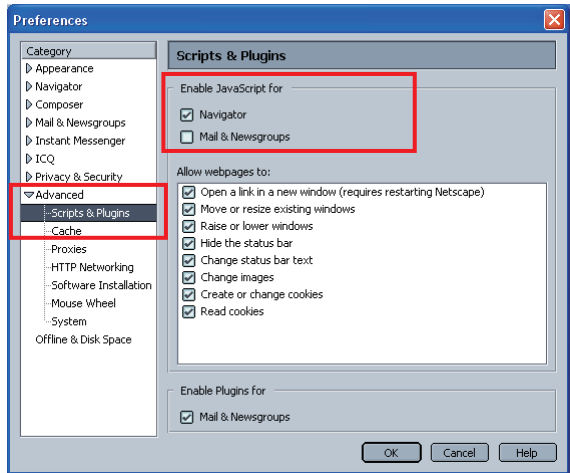

Flash Player enable

Flash Player Plug-in setting

Select **About:Plug-ins** from **Help** menu on the web browser. The plug-ins software provided on the browser are listed on the page. Check that the **Flash Player Plug-in (Shockwave Flash)** is installed and set up correctly as below.

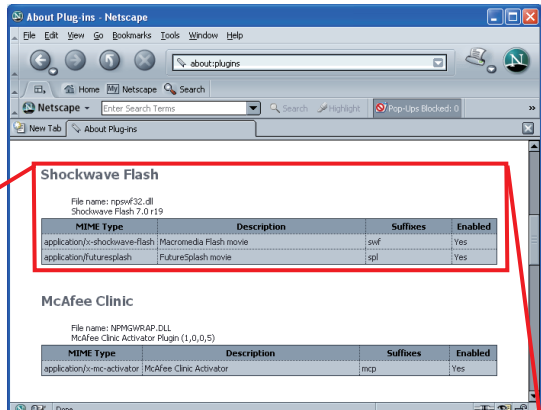

Shockwave Flash

File name: npswf32.dll
Shockwave Flash 7.0 r19

MIME Type	Description	Suffixes	Enabled
application/x-shockwave-flash	Macromedia Flash movie	swf	Yes
application/futuresplash	FutureSplash movie	spl	Yes

Proxy setting

Select **Preference** from **Edit** menu on the web browser and then select the item **Advanced/Proxies** in the **Category** column. Properly set up your web browser's the proxy server settings according to the local area network environment to which the projector is connected.

- Using proxy server

When you use an external internet connection from the local area network, select the item **Manual proxy configuration**. Enter the proxy server address and port number correctly on **HTTP Proxy** item. For further instruction please consult your network administrator.

- Not using proxy server

Select the item **Direct connection to the Internet** in the proxy setting window. If you connect the projector to the computer directly with UTP cross cable, this must be selected.

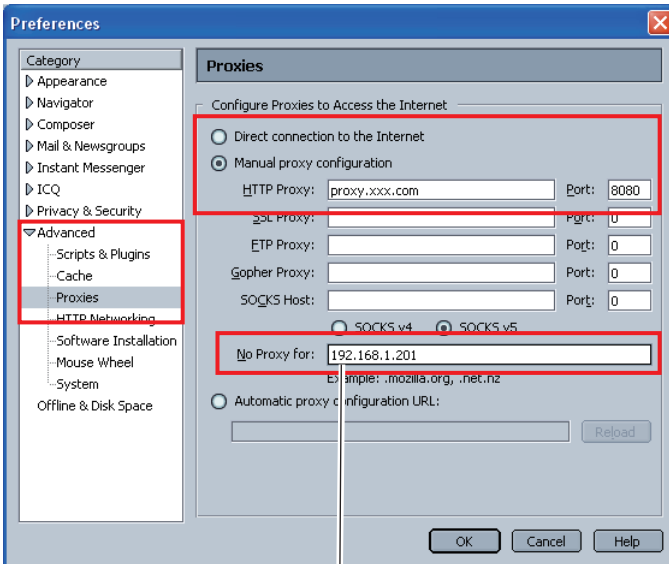

To designate proxy settings that will not use the proxy server when accessing the projector installed in the local area network, enter the IP address or domain name here.

Firewall setting

If you use Windows XP SP2 or Windows Vista and using Network Capture 5, you may see the Windows security warning dialog as below. In that case, click "Cancel the block" button on the dialog to enable the function of Network Capture 5. (This page is described with Windows XP screen the example.) Even if you select "Block", you can cancel the blocking following to the steps below;



- 1 Open **Control Panel** from **Start** menu and double-click **Windows Firewall** icon. The firewall setting window will appear.
- 2 Select **General** tab and check that the setting on the firewall setting window as follows;

On (recommended)	checked
Don't allow exceptions	unchecked
- 3 Select **Exceptions** tab and check the name of Network Capture 5 listed on the **Programs and Services**. If there is no program name, add the program by clicking **Add Program** button.
- 4 Click **OK** to close setting.

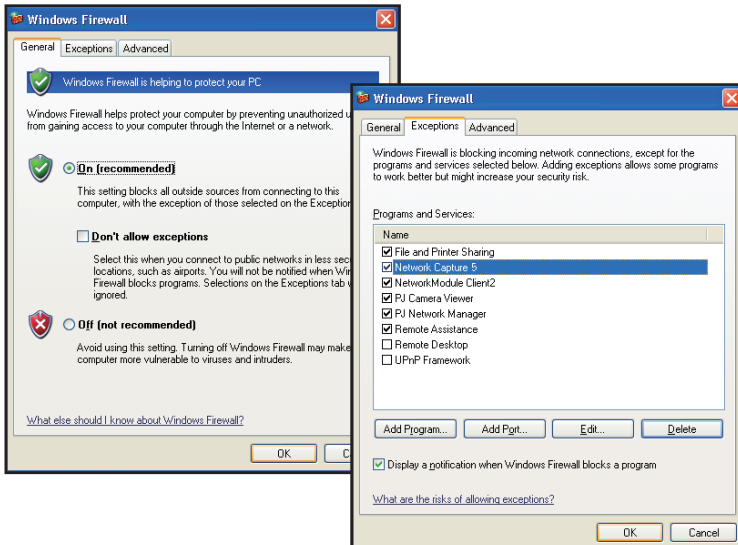

Troubleshooting

If you have any trouble in setup or operation of the projector, refer to the troubleshooting items and check the relevant matters described.

■ The computer cannot connect projectors.

Wired LAN

Is the LAN cable connected to the projector properly?

Is the LAN setting of the projector set "On"? See "Wired LAN setting" in the projector menu.

The LAN cable is connected to the network HUB properly?

Wireless LAN

Is the WIRELESS indicator on the side panel of the projector lighting?

If there are not any problems, confirm the LAN setting again.

If the computer supports Wireless LAN, activate the Network Capture 5 and try to connect with the Easy setting button. Refer to "5. Wireless LAN configuration" → "Easy wireless settings" (p.43).

If the wireless LAN card provides the firewall function itself, set up to disable its function.

■ Cannot connect with easy wireless setting function

Depending on the wireless LAN card or computer, this easy wireless setting function may not be available.

When your computer is using multiple network adaptors which are available in the setting, and their IP address groups are the same as shown below, this easy wireless setting function may not be succeeded.

[For example] IP address setting of Wired LAN adaptor in your computer : 169.254.*.*
IP address setting of Wireless LAN adaptor in your computer : 169.254.*.*

■ Wireless LAN Connection cannot be established.

AdHoc Mode:

When selecting Wireless 4 (factory default setting)

Check each item in the Wireless Setting menu of the projector as follows:

*IP Address Is the address appropriate? Should not be the same as the other IP address.

*Sub net Should be the factory default value, 255.255.0.0.

*Gateway Should be the factory default value, 255.255.255.255

*Network Type Should be AdHoc mode

*ESSID/SSID Should be the same as the setting of computer
->Check the setting for the computer

*Is the Wireless channel set as 11 both for the computer and the projector?

-> The factory default channel of the projector is 11.

*WEP (Wired Equivalent Privacy) Should be disabled.

Infrastructure Mode:

When selecting Wireless 5 (factory default setting)

Check each item below in the Wireless Setting menu of the projector as follows:

- *IP Address.....No setting is required.
- *Sub netShould be the same as the setting of the access point
- *GatewayShould be the same as the setting of the access point
- *Network TypeShould be the Infrastructure mode
- *ESSID/SSID.....Should be same as the setting of the access point

Check the settings for projector Client computer

- *IP Address.....No setting is required. Automatically set as DHCP.
- *Wireless Channel.....Should be 11
- *ESSID/SSID.....Should be the same as the setting of the access point
- *WEPShould be disabled.

*When Wireless 5 is used, it is necessary DHCP server is under the environment enabling those servers communicate through networks. Some access points may have the DHCP function. For detail of the settings, refer to the owner's manual for the devices or consult a system administrator of the network.

 Is the segment where the projector is installed different from the computer?
 Specify IP Address directly on the optional setting. Refer to "4. Wired LAN Configurations" →
 "Confirming the Operation" (☞p.30-31).

■ **Connection between computer and the projector via Wired LAN cannot be established.**

When selecting LAN1 (factory default setting)

Check IP address, Sub net and Gateway of the projector and computer. For further details of the configuration, contact your system administrator.

 Is the segment where the projector is installed different from the projector?
 Specify IP Address directly on the optional setting. Refer to "4. Wired LAN Configurations" →
 "Confirming the Operation" (☞p.30-31).

■ **Cannot start up the browser**

Is the connection between PC and the projector with Network Capture 5 established?

No..... Check settings for Wireless/Wired LAN.

Yes..... Check settings of the proxy setting at browser. Refer to "Web browser setting"
 (p.134).

■ **Although the connection between PC and the projector is established, images are not projected on the screen.**

Make sure Wireless/Wired is selected from the Input source menu of the projector.

■ **Cannot be turned on/off with the web browser.**

Make sure the settings of the projector are correct to use the projector with it.

Set the item Standby mode to "Network" from Main menu → Setting menu.

Refer to "7. Controlling the projector" → "Power control and status check" (p.68).

■ **Wired / Wireless input cannot be changed. Network Capture 5 cannot be operated.**

Restart the projector or Network Capture 5.

Execute "Wired factory default" or "Wireless factory default" menu on the projector.

Caution: After executing "Wired factory default" or "Wireless factory default" in the projector menu, all the network settings you have made will return to the factory default settings. See the items "Wired factory default" (p.33) and "Wireless factory default" (p.46) for the each factory default value.

Network capture

■ **Why doesn't the computer screen appear on the projected screen?**

1. Make sure that the input mode of the projector is "Network".
2. Check the parameter set up (p.92).
Make sure that the numbers of the capture port is the same as the projector's port number. The default port number is 9000. If the alert message "Invalid Port No." appears, your computer may be using this port number already. In that case, use another port number.
3. Check the IP address of the computer is registered to the projector correctly (p.93).
4. Make sure that your computer is not using the firewall function. The projector may not be able to use the port due to this firewall function. In that case, please turn off this function temporarily. There are also some port limitations on the network equipment such as router. Please consult your network administrator.

■ **Speed of playing back images are very slow.**

When connecting on AdHoc mode, check which Wireless channel you are using.

If the computer using the same channel as yours is existing closely, the networking speed may be reduced or the communication unstable. Change the channel to resolve the problem. The channels of the projector and projector Client computer must be the same. Or adjust the Quality selection in the parameter setting.

Refer to "Parameter set up" (p.92).

■ **Projector does not reproduce the computer's sound during the real time capturing.**

To reproduce the sound in the projector correctly, follow the procedures below;

- Start up the real time capture and then start up the movie player software.
- Terminate the movie player software first and then terminate the real time capture.

Check that the "PJ Virtual Audio Device" is selected on the audio device panel of the computer.

Double click **Sound and Audio Device** icon on the **Control Panel** of the computer. The property window appears. Click **Audio** tab on the property window and check that "PJ Virtual Audio Device" is selected on the **Default device** of **Sound playback** item.



Network Viewer

■ **Images from the file server don't appear on the screen?**

1. Make sure that the input mode of the projector is "Network".
2. Check the account setting of the FTP server.
3. The files in the FTP server must be optimized JPEG and converted by the File Converter 1 or 2. Please check data format. (p.114)
4. There are several limitations for image file name and program name. Please check file names and program names (p.123).
5. Make sure that your computer is not using the firewall function. The projector may not be able to use the port due to this firewall function. In that case, please turn off this function temporarily. There are also some port limitations on the network equipment such as router. Please consult your network administrator.

■ **I cannot make a new program file.**

Check your account of the FTP server. "Write enable" made should be set for its account.(p.117)

File Converter 1

■ What kind of image formats can I convert?

The File Converter 1 makes it available to convert into the JPEG format from the following image formats.

- Bitmap format (.bmp)
- JPEG format (.jpeg .jpg)
- Microsoft power point format (.ppt)

File Converter 2

■ Sometime I have the white frame images converted by the File Converter 2?

It may have images with white frame due to the paper margin of the print driver depending on the image data.

■ Sometime I have the incorrect images converted by the File Converter 2?

Try to change the mode to "Disable" on "Document options" - "Print optimization" item on the "Network Viewer 5 (Driver) Advance Options" in the Network Viewer 5 (File Converter 2) Printer driver setting.

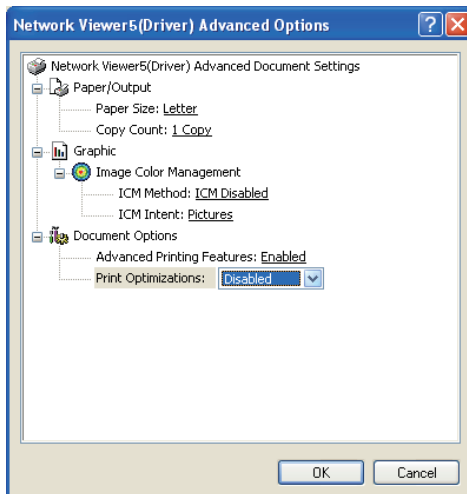

Auto Capture

- I have deleted the AutoCapture program file on the supplied USB memory.
I want to perform the AutoCapture with a commercially available USB memory.

To perform AutoCapture, you should have all files and folders of "Auto Capture" folder on 'Network Viewer & Capture 5 (CD-ROM)' on the root of USB memory. By copying or drag and dropping those files and folders on the root of a commercially available USB memory, you can perform the AutoCapture as well as a supplied USB memory.

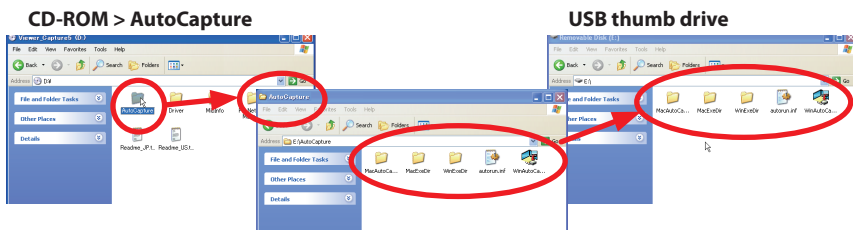

- Auto Capture does not start automatically.

Depending on a computer or the security setting of the network, AutoCapture may not start automatically. Please make sure the examples as follows. Please consult your network administrator in detail.

- When setup as follows in a computer with Windows Vista
Click **start** button, and click [Control Panel] - [AutoPlay], and **Take no action** is selected in "Software and games".
- Please select the other options.
- When "Autorun.inf" is denied in a computer as an anti-security measure in your local area network environment.
- Please consult your network administrator.

USB display

- Projector does not reproduce the computer's image by USB display function.

Check the settings of the projector as follows:

- Select "Display" in "USB terminal" of Setting menu (☞p.34).
- Select "USB display" in "LAN mode select" of Network menu (☞p.34).

Check the connection with the computer as follows:

- A USB cable should be connected directly between the projector and the computer. "USB display" function may not operate with connecting via a USB hub or a USB switching unit (☞p.34).
- Depending on a USB devise (USB controller in computer), this USB display function may not be available.

Terminology

.....

DHCP server (Dynamic Host Configuration Protocol)

It is necessary to set an IP address for each computer or equivalent equipment when a network is established by TCP/IP. If there exists DHCP server on the network, it will assign IP addresses to client computers every time they request it. If there exists equipment with DHCP server functions (such as a Windows 2000 server and a dial-up router) on the network, the DHCP server function may be automatically operating. Ask your system administrator whether the DHCP server is operating.

ESSID (Extended Service Set Identifier)

ESSID is the ID that is set to computers on Wireless LAN or access point in order to prevent each computer from being crossed. The computers or access point to which the same ESSID is set can communicate with each other. If an ESSID is different, it is impossible to communicate. ESSID distinguishes between lowercase and uppercase characters, and allows you to use English one byte characters and half-size symbols up to 32 characters.

WEP (Wired Equivalent Privacy)

WEP is a security protocol for Wireless LAN. It protects computers on Wireless LAN and access point from unauthorized access by setting a description code onto them. It is necessary to set the same decryption code for equipment.

Wireless Channel

It is necessary to divide frequency spectrums into some Wireless channels for Wireless communication, and to tune to the same channel between Wireless equipment. If you use the same channel on the same floor, and there are some Wireless LANs that have a different ESSID for each, the communication speed may become slow. In that case, using different channels for each Wireless LAN is effective, which lowers a possibility of mutual interference between Wireless LANs.

MAC address (Media Access Control Address)

MAC address is a physical address for every network interface. The MAC address consists of 6-byte hex number. The first 3 bytes are a Vendor ID controlled and assigned by IEEE. The last 3 bytes are controlled and assigned by the manufacturers of network interface (no duplication of MAC address). Therefore, MAC address is a unique physical address in the world. Ethernet sends and receives frames on the basis of MAC address.

Wi-Fi (Wireless Fidelity)

It is a brand name, showing that the interconnectivity between wireless LANs is certified by the Wi-Fi Alliance (formerly WECA). The products that passed the Wi-Fi Alliance interoperability test are given the certification of 'Wi-Fi certified' and permitted to use the Wi-Fi Logo. The products that have Wi-Fi logo are guaranteed to interoperate with other Wi-Fi products.

Wi-Fi Alliance (Formerly Name: WECA (Wireless Ethernet Compatibility Alliance))

It is an organization that aims to promote the spread of Wireless LAN, and it guarantees the interoperability of products that meet the Wireless LAN standard.

WPS (Wi-Fi Protected Setup)

It is a standard to easily perform security of the wireless LAN which Wi-Fi Alliance devised. There are two kinds of WPS configuring which is push button type and PIN code type.

Push button type: ESSID and WPA2 key to access point are sent to a client by pressing the exclusive button put on an access point (host) and a client each.

PIN code type: A number (four-digit or eight-digit) called PIN code assigned to an access point beforehand is input into a client-side.

IEEE802.11b

It is one of the wireless LAN standards set by 802 committee that formulates a standard of the LAN technology in IEEE (the Institute of Electrical and Electronics Engineers). By using the 2.4GHz license-free frequency band, you can perform communication at a speed of 11Mbps at the maximum.

IEEE802.11g

By using the 2.4GHz license-free frequency band as well as IEEE802.11b, you can perform communication at a speed of 54Mbps at the maximum, which is about 5 times the speed of IEEE802.11g. Moreover, there is an upward compatibility with IEEE802.11b.

IEEE802.11n

It is a next-generation Wireless LAN standard that is being developed with the aim of producing the maximum transmission speed of 600Mbps by using the technology called MIMO, combines multiple channels and performs transmission. It is being designed to have a compatibility with IEEE802.11b and IEEE802.11g.

EIKI

Touchboards

205 Westwood Ave, Long Branch, NJ 07740
Phone: 866-94 BOARDS (26273) / (732)-222-1511
Fax: (732)-222-7088 | E-mail: sales@touchboards.com