

PLUS

Captureboard **C-11**

**Thank you for your purchase of the PLUS Captureboard.
Please read this User's Manual carefully before use to take full advantage of the functions of this product. After you have finished reading the manual, please keep it for future reference.**

Trademarks

- Microsoft and Windows are registered trademarks or trademarks in the United States and other countries of the Microsoft Corporation.
- Adobe and Adobe Acrobat Reader are trademarks of Adobe Systems Incorporated.

The trademarks of the various companies and the product trademarks, even when not written down, will be given due respect. Product names and company names appearing in this manual are registered trademarks or trademarks of the respective companies.

- (1) The contents of this manual may not be reprinted in part or whole without permission.
- (2) The contents of this manual are subject to change without notice.
- (3) Great care has been taken in the creation of this manual; however, should any questionable points, errors, or omissions be apparent, please contact us.
- (4) Notwithstanding Section (3), this company will not be responsible for any claims of loss or profit or other matters deemed to be the result of using this unit.
- (5) The use of a printer as the peripheral device of the PLUS Captureboard is taken to be a prerequisite; therefore, operation will not be guaranteed when the printer is used with a direct connection to a personal computer.
- (6) Manuals with incorrect collating or missing pages will be replaced.

Table of Contents

Important Safety Information	E-4
Package Contents	E-7
Main Functions	E-8
Names of the Parts	E-9
Front	E-9
Rear.....	E-10
Changing the Height of the Unit	E-11
Control Panel.....	E-12
Connections Between Captureboard and AC Power Adapter	E-13
Setting the Time	E-14
Operation Steps	E-16
When used as a Captureboard	E-16
When used as a copyboard.....	E-17
Printing (When a printer has been purchased as an optional item)	E-18
Preparing the Printer	E-18
Basic Printing Operation	E-19
Selecting the printing density	E-21
Making additional copies	E-21
Cancellation of the print operation in progress	E-21
Printing in the same ratio as the sheet surface (Model C-11W).....	E-22
Using USB Memory	E-23
USB Memory Storage Procedure.....	E-23
Saving Image Files to a Personal Computer, and Deleting Image Files	E-25
Accompanying Software	E-27
Software Contents and Overview	E-27
Operating Environment	E-27
Meaning of Error Messages	E-28
Troubleshooting	E-29
Specifications	E-30
Appendix (When a printer has been purchased as an optional item)	E-31
Connections Between the Captureboard and Printer	E-31
When there is a Problem with Printing	E-32

Meaning of the Terms Used in this Manual

- USB memory: refers to USB flash memory.
- USB memory storage: means the saving of sheet surface data using MEMORY (i.e., the USB port) of the operation panel. (The Captureboard has 3 USB ports.)
- Internal memory: indicates a temporary saving location of the image that has been read.
- “copy”: Both “print” and “USB memory saving” mean to “copy.”
- “Sheet surface”: refer to the drawing portion.
- “Scroll” or “move”: indicates feeding of the sheet.

Important Safety Information

WARNING

The unit's rear panel should never be opened by anyone other than a qualified serviceperson. Contact your store of purchase to request internal inspection, adjustment, repair, and cleaning.



CAUTION

Continued use of the unit under abnormal conditions (when the unit is emitting smoke, unusual odors or sounds) could lead to fire or electric shocks.

Turn off the unit's power immediately, then unplug the AC power adapter from the power outlet.

Check that no more smoke, etc., is being emitted, then contact a sales outlet for repairs.

Repairing the unit yourself is dangerous. Never attempt to do so.

WARNING

This is a class A product. In a domestic environment this product may cause radio interference in which case the user may be required to take adequate measures.

WARNING

The Federal Communications Commission does not allow any modifications or changes to the unit EXCEPT those specified by PLUS Vision Corp. in this manual. Failure to comply with this government regulation could void your right to operate this equipment.

This equipment has been tested and found to comply with the limits for a Class A digital device, pursuant to

Part 15 of the FCC Rules. These limits are designed to provide reasonable protection against harmful interference when the equipment is operated in a commercial environment. This equipment generates, uses, and can radiate radio frequency energy and, if not installed and used in accordance with the instruction manual, may cause harmful interference to radio communications. Operation of this equipment in a residential area is likely to cause harmful interference in which case the user will be required to correct the interference at his own expense.

You are cautioned that changes or modifications not expressly approved by the party responsible for compliance could void your authority to operate the equipment.

WARNING

This product is not for use in Computer Rooms. The description "Computer Rooms" refers to areas where an abundance of computer control equipment (such as high output servers) is being used.

It does NOT refer to environments such as offices or classrooms where there are simply PC's being used.



This symbol warns the user that uninsulated voltage within the unit may have sufficient magnitude to cause electric shock. Therefore, it is dangerous to make any kind of contact with any part inside of this unit.



This symbol alerts the user that important literature concerning the operation and maintenance of this unit has been included. Therefore, it should be read carefully in order to avoid any problems.



SAFETY PRECAUTIONS

Heeding the safety precautions below will lengthen the product's service life and prevent fires, electric shocks and injury. Read these safety precautions carefully and be sure to heed them.

Handling the AC power adapter

- Do not connect any AC adapter other than the dedicated one to the unit. Doing so could result in fire or other accidents.
- Do not use with voltages other than the voltage indicated. Doing so could result in fire or electric shock.
- Do not let the AC power adapter get wet. Doing so could result in fire or electric shock.
- Do not subject the AC power adapter to shocks. Doing so could result in fire or electric shock.

DOC Compliance Notice

This Class A digital apparatus meets all requirements of the Canadian Interference-Causing Equipment Regulations.

Important Safety Information

Handling the AC power adapter's cord and plug

- Damaging the power cord could lead to fire or electric shock.
 - When installing, do not squeeze the power cord between the product and a wall, rack, etc.
 - Do not modify or damage the power cord.
 - Do not place heavy objects on the power cord or pull strongly on it.
 - Do not place the power cord near heating appliances or otherwise heat it.
 - When unplugging the power cord, always do so by pulling on the plug, not the cord.

If the power cord should be damaged, ask your store of purchase to replace it.

- If there is dust or metal objects on or near the power plug's blades, unplug the power cord then wipe the blade area clean using a dry cloth. Continued use without cleaning the plug could lead to fire or electric shock.
- Do not plug in or unplug the power cord with wet hands. Doing so could lead to electric shock.
- When moving the unit, turn off the power and be sure to unplug the power cord from the AC outlet first. Moving the unit with the power cord plugged in could damage the cord, leading to fire or electric shock.
- Connect the power plug securely to the AC outlet, pressing the blades in to the hilt. Incomplete plugging could cause heating or attract dust, leading to fire. In addition, touching the plug's blades could cause electric shock.
- Do not connect a device to the accessory outlets of the AC power cord that will exceed the rating of the power cord.
- Dust or other matter that collects on the accessory outlet portion could be the cause of fire.
- Do not use a power cord that is in an excessively bent condition.

Do not use the included CD-ROM in a player designed for audio CDs.

- Never use the included CD-ROM in a player designed for audio CDs. Doing so could produce loud noises that could impair your hearing. These noises can also damage your speakers.

Installation

- When mounting on a wall, be sure to check first that the wall surface is strong enough to support the total weight of the main unit, mount fittings and printer for a long period of time (including during earthquakes). If the wall is not strong enough, reinforce it before mounting the unit.
- Getting water on or inside the unit etc., could lead to fire or electric shock. Be particularly careful when using the unit near a window when it is raining or snowing and when using it near the shore of the ocean and lakes.
- Do not set the unit in hot places exposed to direct sunlight or in places exposed to an air conditioner or heating duct. Do not set the unit in places exposed to soot or humidity (near humidifiers, etc.).
- When the power plug will be unplugged from the power outlet, please place the Captureboard near the power outlet so that it may be reached easily.

Projector

- When using the projector to project an image, and when making a presentation or the like, light from the projector may enter the eye.
Direct viewing of the projector light will be a cause of injury to the eye; therefore, due caution should be taken.

Preventing Tipping (for stand type units)

To prevent tipping, heed the instructions below. Tipping could lead to personal injury or damage the unit.

- Use the unit on a flat floor.
- Be sure to attach the supplied stabilizers to the stand, and lock the stoppers of the casters. Failing to do so could result in the unit tipping and could lead to personal injury.
- Do not lean against the unit or apply excess force to the top of the unit.

Cautions on Usage

- Take care that the unit does not get wet and that water does not get inside. Do not place objects containing chemicals, water or other liquids (vases, potted plants, glasses, cosmetics, etc.) on top of the unit. The liquid could spill and get inside the unit, leading to fire or electric shock.
- When lifting the unit to adjust the height, etc., the unit should be lifted by at least two persons to prevent it from tipping and causing personal injury.
- Do not move the sheet with paper or other objects attached to it. Doing so could cause damage.
- Do not wipe the unit or sheet with thinner, benzene, alcohol or other such products. Doing so could cause discoloration or damage the sheet.
- Please be sure to use the dedicated markers and erasers. Use of other types of markers or erasers, or rubbing directly with the hand may scratch the sheet, or may soil the sheet and the ink may not come off.
The markers must be stored in a horizontal orientation. The ink may be difficult to remove if they are not.
- When moving the (stand type) unit, remove the stabilizers and release the caster locks. Hold the sides of the main unit and move it gently. Avoid shocks.
- When not using for long periods of time, for safety be sure to unplug the AC power adapter from the power outlet.
- Make entries within the effective reading size. (See page E-9) Portions that are drawn outside of this range might not be printed or copied when saving to USB memory or personal computer.
- Just as with the copyboards up until now, please do not move the sheet manually (by hand) with the current model. Doing so may result in improper storage or printing of the information drawn on the sheet surface.

Important Safety Information

Cleaning

- When the sheet has become soiled, wipe it with a moist cloth that has been wrung well. When heavily soiled, add a small amount of clean water to the sponge of a new dedicated eraser and wipe, and before the sheet surface has dried finish wiping with a soft clean, dry cloth. After cleaning, allow the sheet to dry completely before use. Do not use heavily soiled erasers, wet tissue, office cleaners, neutral detergent, or other cleaners.
- Do not wipe the Captureboard or sheet with thinner, benzene, alcohol, etc. Doing so could cause discoloration or damage the sheet.
- Wipe off any marks from markers on the pen tray or the frame cover using a damp, thoroughly wrung out cloth.
- When the erasing surface of an eraser has become soiled, exchange the sponge with a spare one, and then use. Using a soiled eraser will soil the sheet surface, and it will be difficult to remove the soiled matter from the sheet.

- Note that copying illegal material (tantamount to possession of illegal material) is subject to prosecution.
- This product includes parts considered as “strategic material” as per the Foreign Exchange and Foreign Trade Control Act of Japan. Authorization as per said Act is required to export this product from Japan.

Handling the CD-ROM

- Do not touch the surface which has no printing (the surface on which the data is recorded). If this surface is dirty the data will not be read properly. Also, do not stick paper, stickers, etc., on the CD-ROM.
- Do not leave for long periods of time in places exposed to direct sunlight or near heating appliances, and do not drop or bend the CD-ROM. The disc may get warped, making it impossible to read the data.

USB Memory

- The USB memory formats supported by the Captureboard are FAT, and FAT 32. There are also types of USB memory that cannot be used by this unit. Check the PLUS Vision web site for types of USB memory that have been verified to work with the Captureboard.
- As a provision against the unlikely event of a problem with or disappearance of the data saved in the USB memory, we recommend that the data be regularly saved to other media.
- PLUS Vision will not be responsible for the loss of content stored in the internal memory of this unit (i.e., images that have been read), or in USB memory.

USB Cables

When using a USB cable other than the one supplied with the Captureboard, use a USB shielded cable bearing the USB-IF logo certification. Do not use the Captureboard connected to a USB hub. Improper operation may result.

Package Contents

The package contents are as described below. Please check before use.

Captureboard, main unit [1]

See "Assembly and Setup Manual" for information about the assembly parts of the Captureboard.

Stand [1]

* The printer is available separately.

* Depending on the product you have purchased, the stand may be sold separately.

Captureboard Accessories

Dedicated markers

(One each of black, red, blue, and green)

Use these markers to draw on the sheet surface.

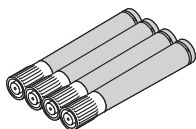

Dedicated eraser (with 2 spare sponges) [1]

Use this to erase the drawing.

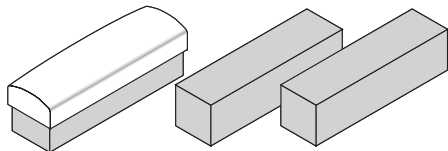

AC power adapter (with power cord) [1]

This is the power adapter for supplying power to the Captureboard (See Page E-13). (HEC-AP065-24V)

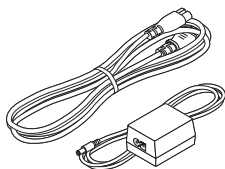

USB cable (type B ↔ type A) [1]

[PLUS code 715255400]

This is a cable for connecting the PC dedicated USB port of the Captureboard with a personal computer. See the separate volume Captureboard Software Operation Manual for information about connections.

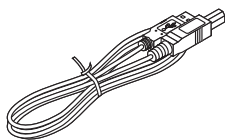

Cable clips [5]



Cushions [2 pcs.]

These cushions are used to absorb the shake of printer table in case wall mounting. (See the Assembly and Setup Manual.)

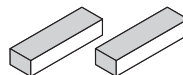

Wall mount brackets [1 set]

These fittings are used to mount the Captureboard on a wall (See the Assembly and Setup Manual.).

(The set includes four Captureboard brackets and 16 M4 mounting screws.)

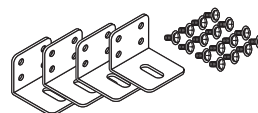

Printer table [1 set]

The printer is placed on this printer table.

(The set includes one printer table, brackets for left and right sides, 12 M3 assembly screws, 4 M4 screws, 3 printer guides, 5 cable clips and 2 20 cm cable ties and 2 10 cm cable ties)

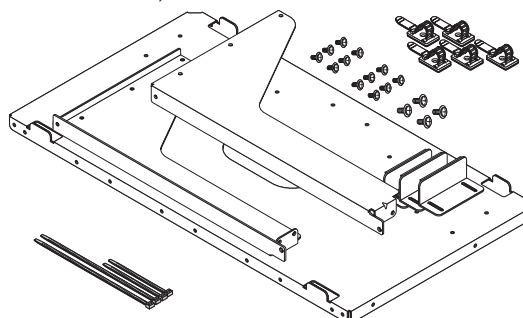

Documents

User's manual [1]

Includes information about safety precautions and the use of the Captureboard.

Captureboard Software Operation Manual [1]

The contents include information about how to use the Captureboard Software and the setting method.

CD-ROM [1]

The CD-ROM contains the instruction manual (PDF edition) and the utility software for use with the Captureboard.

Quick Guide [1 set]

The Quick Guide can be hung from a hook in a convenient location close to the Captureboard.

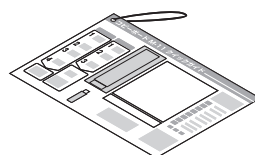

Assembly and Setup Manual

The contents include the setup method for the Captureboard, and connections with the printer (which is sold separately).

Main Functions



Allows the projection of an image that is easy on the eyes, and the use of the dedicated markers and eraser permits direct writing and erasure on the screen sheet surface.

Use of a special screen sheet allows for the projection of an image with the glare of the sheet surface due to the light of the projector being suppressed to the utmost. The use of the dedicated markers and eraser permits direct writing and erasure on the screen sheet surface. Being able to use one piece of equipment as both a copyboard and a projector screen permits effective use of the setup space, and saves the trouble of separate preparation.



The projection image of the projector and the handwritten information on the Captureboard are captured on the personal computer, and stored as a superimposed image file.

Use a USB cable to connect the Captureboard to the projector and the connected personal computer. The installation of dedicated software combined with performing simple operations permits the projected image of the projector and the handwritten information that has been written on top of it to be captured on the personal computer, superimposed, and saved. Meeting updates, and important information can be conveyed to associates realistically just as it is written and just as it appears.



Text and drawings that have been written on the Captureboard and images can be saved in USB memory as an image file.

By plugging in the USB memory at the bottom surface of the control panel and pressing the "Save" button on the control panel, the content that has been handwritten on the sheet surface can be saved to the USB memory as it appears in the form of an image file, the same as with the existing Copyboard.



Maintenance-free, Low Power Consumption

RGB, 3-primary-color LEDs are used as the reading light source which means that there is no need to replace a fluorescent tube as with previous copyboard models. In addition, unlike fluorescent tubes, LEDs need only be lit when reading the sheet surface which is reflected in low power consumption.

Names of the Parts

Front

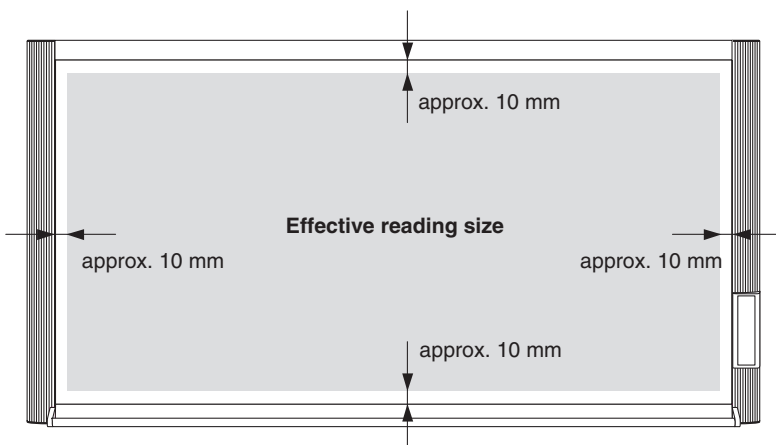
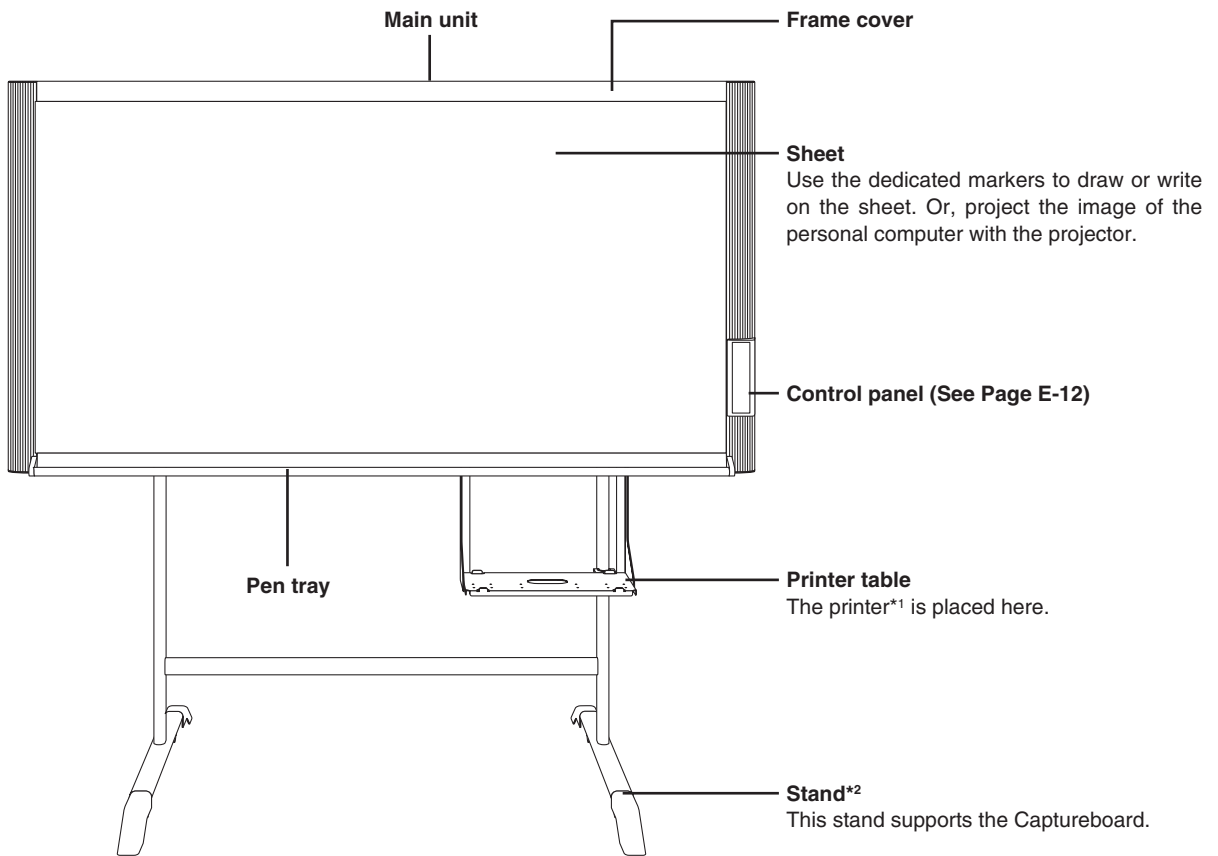

Effective Reading Size

The area that can be copied is the gray area of the diagram.

Note

- It might not be possible to print or copy when storing to USB memory or personal computer any portions that are drawn outside of this range.

*¹ The printer is available separately.

*² Depending on the product you have purchased, the stand may be sold separately.

Names of the Parts

Rear

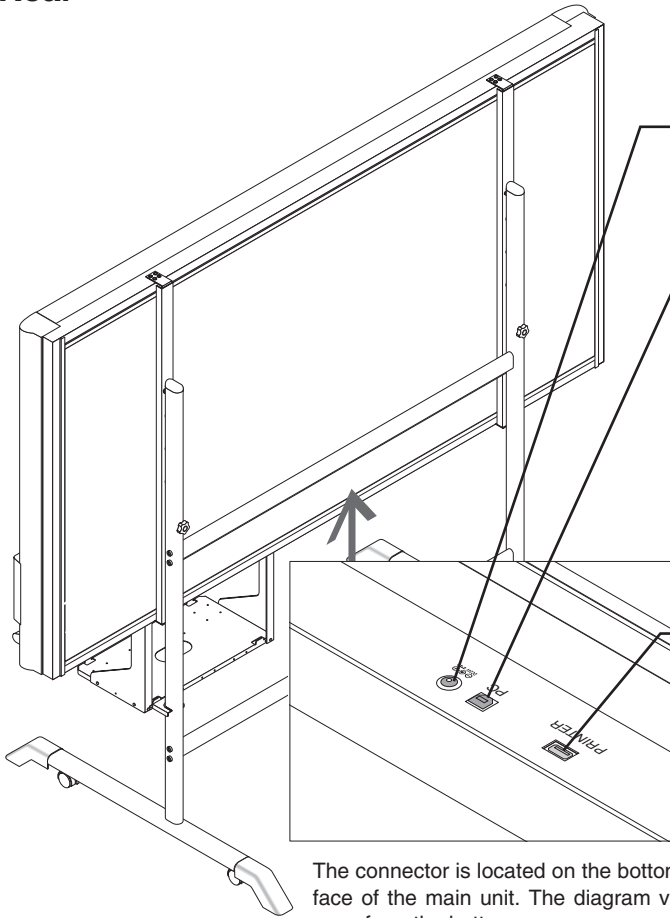

DC input connector

Connect this with the DC plug end of the AC power adapter. (See Page E-13.) (Only connect the supplied AC power adapter; nothing else.)

Personal computer (PC) dedicated USB port (Type B)

Connect this with the USB port (type A) of the PC.

Use this when reading is started from the PC side and image data is transferred directly to the PC, or when setting the operating environment of the Captureboard from the PC side. First, install the drivers and software contained on the supplied CD-ROM. See the separate volume Captureboard Software Operation Manual.

Printer connector (USB port Type A)

Connect this with the USB connector of the printer (See Page E-31).

(The printer connector is dedicated for use with a printer; use it only with a printer.)

* Used only when a printer has been purchased as an optional item

The connector is located on the bottom surface of the main unit. The diagram view is seen from the bottom.

Locking and unlocking the casters of the stand

Lock the casters with the stopper after setup. To move the unit, remove the stabilizers and release the caster stopper. Press the bottom of the stopper to lock it. Press the top to release it.

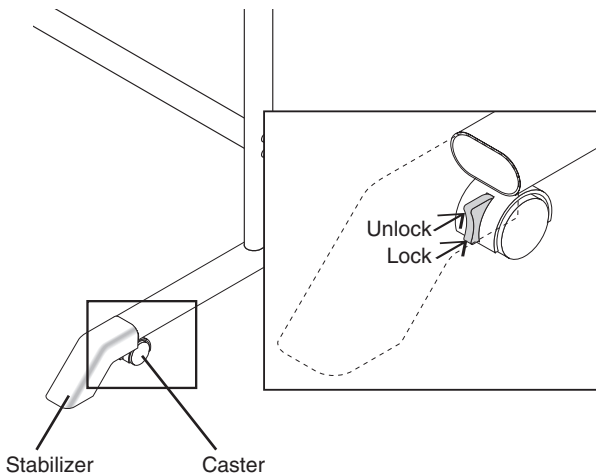

Changing the Height of the Unit

This is the height adjustment when setting up the Captureboard on the optional stand. The stand height can be adjusted to 3 levels by 100 mm.

CAUTION

Please have 2 or more people hold the unit. If the unit is dropped or falls over, this could cause unexpected injury.

Please lock the casters by pushing the lower portion of the lock button.

- (1) **Disconnect the power cable and all other connection lines.**
- (2) **When a printer is installed, take out the printer and remove the printer table.**
Please loosen the printer guide fastening screws before removing the printer.
Remove the two M4 screws from bottom side of the Captureboard and the other two from the rear surface.
- (3) **Remove the two lock knobs (located at the left and right sides).**
- (4) **Change the hole position of the rear frames.**
The Captureboard will disengage from the hooks when it is lifted up about 1 cm.
Fully hook the (left and right) installation holes of the rear frames onto the hooks of the stand.
If a stay (for preventing shaking) is mounted on the printer stand, insert the stay in its original position.
- (5) **Attach the lock knobs to the 2 locations (left and right) and tighten to the rear frames.**
- (6) **Return to original by following the steps in reverse.**

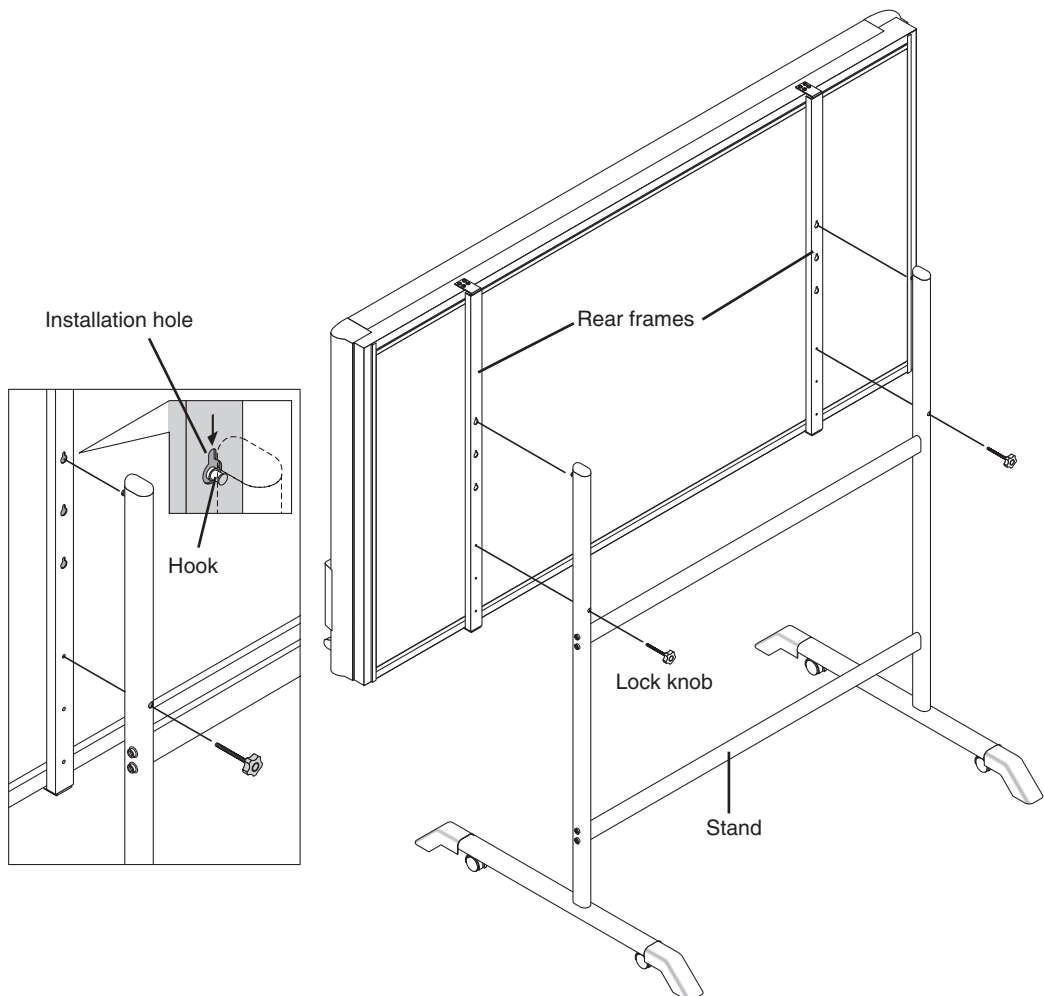

Names of the Parts

Control Panel

When pressing a button, please press the center area (i.e., the round and protruding portion). The button may not work if it is pressed on a corner.

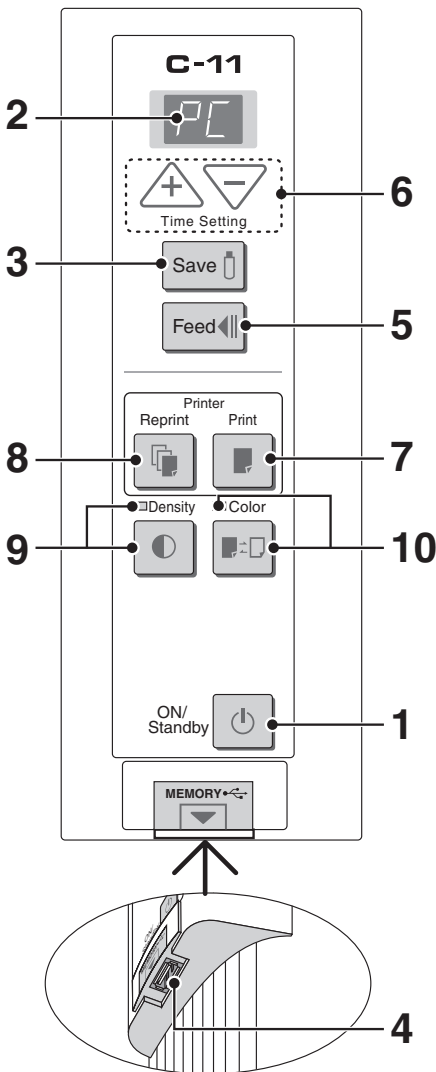

1 ON/Standby button

Turns the Captureboard's power on and off (standby mode).

It is used to cancel saving, sheet feeding, and printing. Pressing the ON/Standby  button in combination with another button permits the print compression. See pages E-21 for details.

2 Display window

Displays the connection status between the Captureboard and the computer, the operational status of USB memory storage, and error information on a 7-segment LED.

"PC" is displayed when the Captureboard is connected with a personal computer. Note that "OP" is displayed when the Captureboard is not connected with a personal computer. Please see Page E-28 for details about error information.

3 Save button (USB memory storage)

Moves a one-screen portion of sheet and reads it, then stores the data on a USB memory.

4 Memory port (USB port Type A)

Saves in commercially-available USB memory images that have been read by the Captureboard.

5 Feed button

Scrolls the sheet one screen portion left, then stops automatically.

6 + / - buttons (Time Setting)

Press the + button or the - button and perform the setting of the date/time. See Page E-14 for details.

7 Print button

Moves the sheet one screen portion and reads it, and prints the image.

* Used only when there is a printer connection.

8 Reprint button

Prints the previously printed sheet surface one more time. (The sheet does not move.)

The density and the color/monochrome selection cannot be changed.

* Used only when there is a printer connection.

9 Density button

Selects the copying density, either "standard" or "dark". This function will be effective at time of printing, USB memory storage, and personal computer storage.

Density mode lamp

When "dark" is selected, the density mode display indicator will flash green. This is enabled during USB memory storage, personal computer storage, or printing.

10 Color button

Selects whether to store in memory (or print) in "color" or "black & white".

Color mode lamp

The indicator lights green when "color" is selected.

* In accordance with the printer function when a printer is connected.

Connections Between Captureboard and AC Power Adapter

To use the Captureboard, connect the supplied AC power adapter.

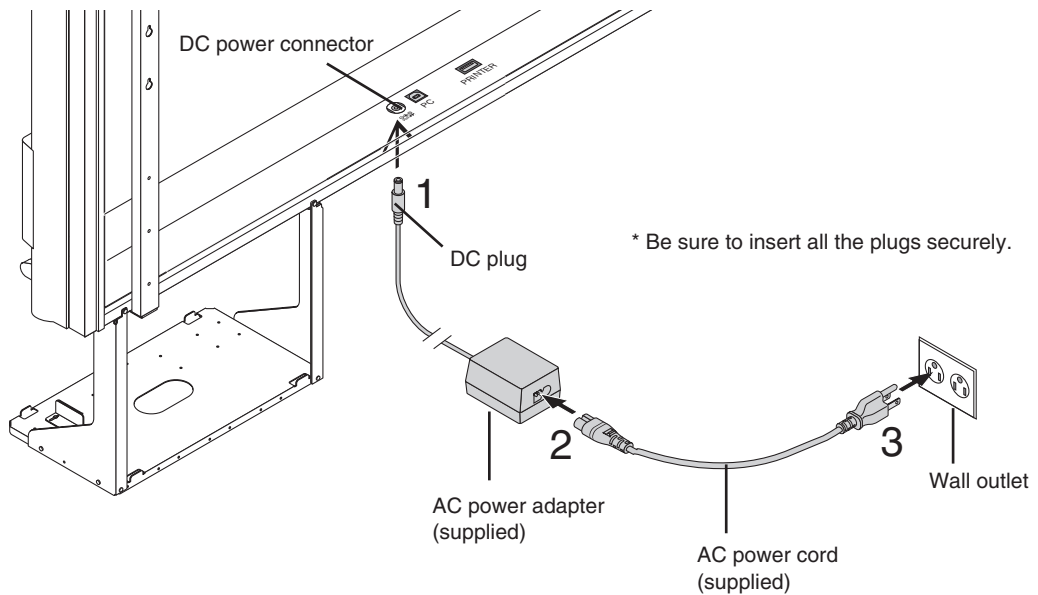

1 Connect the DC plug of the AC power adapter to the DC power connector of the Captureboard.

2 Connect the AC power cord to the AC power adapter.

Once the Captureboard's power supply are connected, fasten them in place using the included cable clips and cable ties.

3 Plug the AC power cord into a AC power outlet in a wall.

The main power turns on. In this manual, this is referred to as the "standby mode".

The descriptions in this manual assume that the AC power adapter is connected (that the unit is in the standby mode).

When not using the Captureboard for long periods of time

Disconnect the AC power adapter's power plug from the AC power outlet in the wall.

Notice

- When the AC power adapter's power plug is unplugged from the power outlet, place the Captureboard near the power outlet so that it can be reached easily.
- The supplied AC power adapter and AC power cord are intended for exclusive use with this product. Never use them with another product.

Setting the Time

The clock of the Captureboard should be set correctly because the date and time (timestamp) is printed on the printer paper, and it is also recorded in the file information when saving.

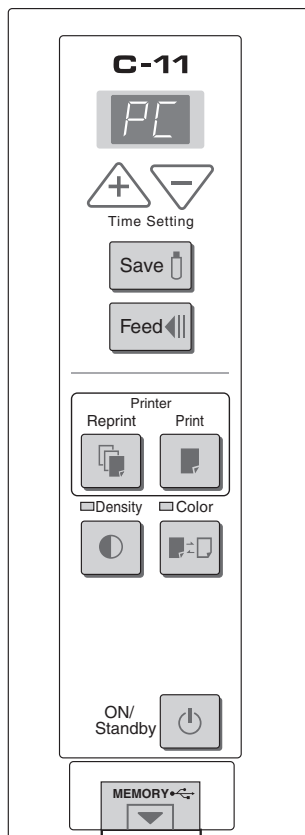

Overview of the Operation

1 Switch to "Time setting"

Press the + or – button.

2 Display the day and hour setting mode

Setting mode information indicated in the display window

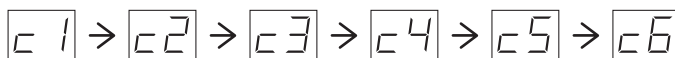

(First 2 digits) (Last 2 digits)
Year Month Day Hour Minute

3 Set the date and time of the setting mode

One press of the + or the – button will enable the settings to be made. Press the + or – button and make the adjustment.

4 Press the Print button to confirm

There is a change to the next setting mode. Repeat steps 3 and 4 to set the current time.

5 Completion

To quit the time setting mode, press the Print button.

- Pressing the ON/Standby button during operations 2 to 4 will cancel the incomplete settings and return to the time prior to starting the settings.

Preparation:

Connect the AC power adapter to the Captureboard. See Page E-13.

Example: Set the time to 2:16 pm, November 8, 2006 (2006.11.08 14:16).

1

Press the ON/Standby button to switch on the power.

The LED of the display window will light and the power will be switched on.

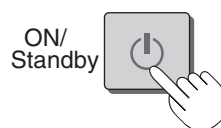

2

Press the + or – button and change to "Time Setting"

The LED of the display window will light and display "c 1".

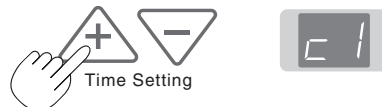

Setting the Time

3

Press the + button or the - button, select 20 (the first 2 digits of the year), and press the Print button to finalize.

There will be a change to the “last 2 digits of the year” setting mode (c2 display).

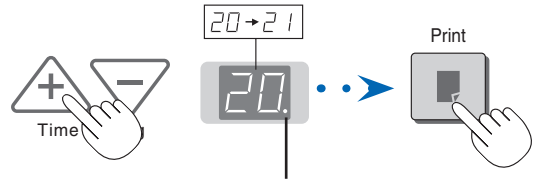

The dot will flash while making settings.

Note

- The factory default setting is 20. Pressing the Print button in this condition will result in a change to the “last 2 digits of the year” setting mode.

4

Press the + button or the - button, select 06 (the last 2 digits of the year), and press the Print button to finalize.

There will be a change to the “month” setting mode (c3 display).

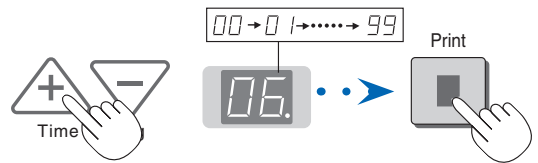

5

Press the + button or the - button, select 11 (the month), and press the Print button to finalize.

There will be a change to the “day” setting mode (c4 display).

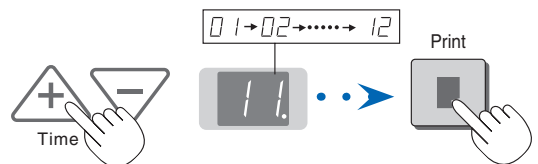

6

Press the + button or the - button, select 08 (the day), and press the Print button to finalize.

There will be a change to the “hour” setting mode (c5 display).

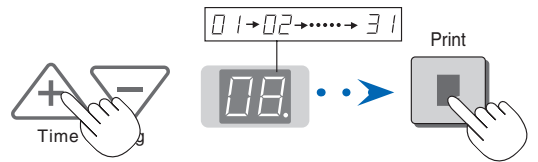

7

Press the + button or the - button, select 14 (the hour of the 24-hour display), and press the Print button to finalize.

There will be a change to the “minute” setting mode (c6 display).

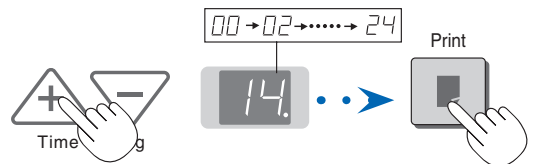

8

Press the + button or the - button, select 16 (the minutes), and press the Print button to finalize.

The display will change to being lit steadily. This completes the time setting.

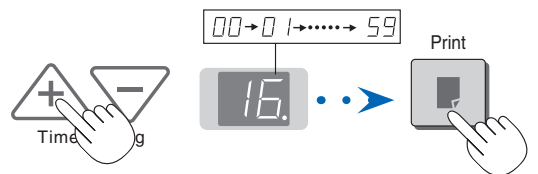

Note

- The factory default print timestamp is set to “enable (print).” If you do not wish to print the timestamp, use the setup utility in the supplied CD-ROM and set to “disable (do not print).” See the separate volume Captureboard Software Operation Manual for information about the installation method.

Operation Steps

When used as a Captureboard

The Captureboard uses a CCD image sensor to read the text and drawings that have been written down with dedicated (4-color) markers, and accumulates the image data in internal memory. Use of the accompanying Captureboard Soft permits the text or drawing that was added to the sheet surface to be combined with the projector image that was projected onto the sheet surface.

Preparation

- **Set up the newly purchased Captureboard and connect a printer.**
See a separate manual titled "Assembly and Setup Manual."
- **Connect the supplied AC power adapter.** See Page E-13.
- **Set the time of the newly purchased Captureboard.** See Page E-14.

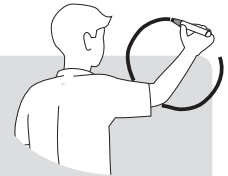

Write and Draw on the Sheet Surface

Please use the supplied dedicated markers for drawing. To erase something, erase it with the supplied dedicated eraser.

Please be sure to use the dedicated markers and erasers. Using other markers or erasers may result in the markings not coming off, or may stain the sheet.

When combining the sheet surface drawing with a projector image

- (1) Start the Captureboard Soft.
- (2) Project the image of the personal computer with the projector.
- (3) Adjust the projected image for a suitable size.
- (4) Use the supplied dedicated marker to draw a circle "o" at the four corners of the projection image.
- (5) The image of the sheet screen will be read. Check that there is a combined image on the computer screen.
- (6) Save the combined image on the personal computer.

Note

- **Please see the separate manual entitled "Captureboard Software Operation Manual" for detailed information about the Captureboard Soft operation method and device connections.**





When Not Using the Captureboard

- (1) By all means, cleanly erase the drawing from the sheet surface with the dedicated eraser. (Leaving the drawing for a long period will make it harder to erase.)
- (2) When disconnecting the USB cable of the Captureboard and personal computer, first disconnect the USB at the personal computer side.
- (3) Press the ON/Standby ⏻ button of the Captureboard and switch off the power (standby mode).

Operation Steps



When used as a copyboard

Pressing the Print  button outputs the content drawn on the sheet surface from the printer, and pressing the Save  button stores the information in the USB memory as image data.

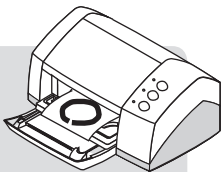
Printing







* When printing is planned, please connect a printer. (Printers are sold separately.) See Page E-31.

- (1) Set A4 or letter size paper.
Do not set anything other than A4 or letter size paper.
- (2) Press the ON/Standby  button of the Captureboard and switch on the power.
- (3) Switch on the printer power.
For instructions on operating the printer, see the printer's operating instructions.
- (4) Press the Print  button. The Captureboard will move a one-screen portion of sheet, read the image, and start the copy operation*.
See "Printing" on Page E-18.

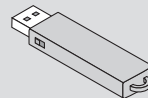
* Images projected with a projector cannot be printed.

Saving to USB Memory







- (1) Press the ON/Standby  button of the Captureboard to switch on the power.
- (2) Insert USB memory into the Memory  port (USB port) of the Captureboard.
- (3) Press the Save  button.
See "Using USB Memory" on Page E-23.



* Images projected with a projector cannot be saved in USB memory.

When Not Using the Captureboard

- (1) By all means, cleanly erase the drawing from the sheet surface with the dedicated eraser. (Leaving the drawing for a long period will make it harder to erase.)
- (2) Press the ON/Standby  button of the Captureboard and switch off the power (standby mode).
The power cannot be switched off while the USB memory remains installed. (This is a prevention function against forgetting to unplug the USB memory.)
- (3) Switch off the printer power.

* Press the Print  button to perform the read operation. Pressing the Save  button during printing will store the information in the USB memory after printing is completed. Press the Save  button to perform the read operation. Pressing the Print  button while storing the information in the USB memory will start the printing operation after storage is completed. This allows both printing and USB memory storage to be performed in a single reading operation.

Note

- Press the ON/Standby  button more than 5 seconds when connecting the AC power adapter to the Captureboard unit or after turning off the power.
- The color of the images when printed in color or when saved in USB memory will differ somewhat from the marker colors.
- Blurred characters, thin lines, overlapping of markers and other factors can cause colors to differ in places and can also result in portions that cannot be scanned successfully. When "Density" is set to "Deep", the overall print may be dark. In the case of the combination of Deep and Color Mode, the black ink may be mixed into other color.
- The built-in memory accumulates the read data that was previously printed or stored in USB memory. This data is erased when the power is switched off with the ON/Standby  button.

Printing (When a printer has been purchased as an optional item)

Use a printer to print out the text and drawings that has been drawn on the sheet surface. Operations and names of parts differ from printer to printer. For details of operations, see your printer's operating instructions.

Notice

Images projected with a projector cannot be printed.

Preparing the Printer

Please check that the Captureboard and the printer have been connected. See Page E-31.

1

Set the paper.

- Please use A4 or letter size printer paper. See your printer instruction manual for details.
- 1) Arrange the paper edges so that they are even.
 - 2) Insert paper at the specified position of the paper tray.
 - 3) Press the paper guide gently until it touches the paper.

Note

See your printer's operating instructions for a description of the paper that can be used.

2

Switch on the power.

Press the power switch. The power indicator lights.

This completes the preparation of the printer.

Press the Print  button on the Captureboard's control panel. One page worth of data is read and the printing operation starts.

Notice

- Depending on the printer, indicators, etc., may flash after the power is turned until the printer is prepared to print. In this case, see the printer's operating instructions and check that the printer is ready before starting the printing operation on the Captureboard.
-

3

When finished printing...

Switch off the printer power and remove the paper. Close the paper tray.

Notice

Do not turn off the power or disconnect the USB cable during printing.

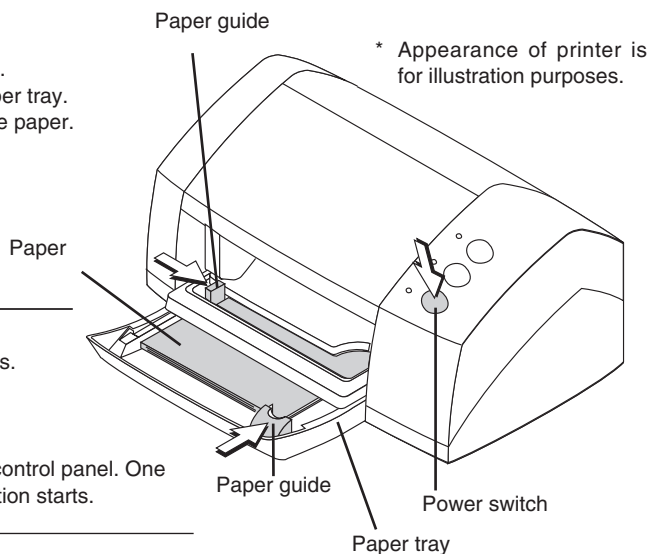

This function prints the sheet screen of the Captureboard on the printer connected to the Captureboard.

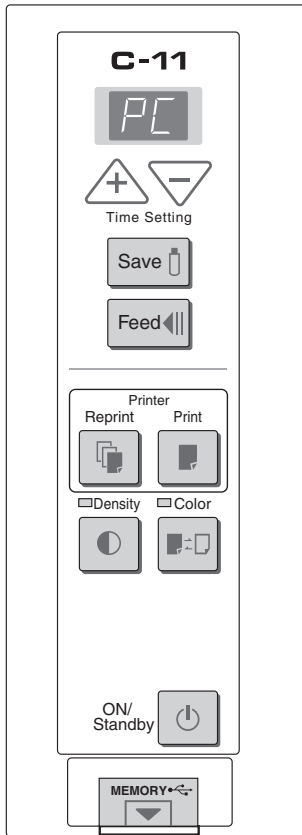

Basic Printing Operation

Preparation:

Connect the AC power adapter to the Captureboard. See Page E-13.

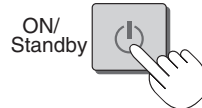

1

Press the ON/Standby  button and switch on the power.



Prepare the printer.

Note

- Press the ON/Standby  button more than 5 seconds when connecting the AC power adapter to the Captureboard unit or after turning off the Captureboard power.
- Press the ON/Standby  button to switch on the power. The LED of the display window will light.
- Turn on the Captureboard power before turning on the printer power.

2

Press the Feed  button and display the sheet surface you want to print.

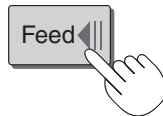

A press of the Feed  button scrolls the sheet surface one screen portion left and automatically stops it.

Note

- The one-screen that is visible is printable position.
- The image that is projected onto the sheet surface will not be printed.
- Printing of the portion located around the sheet surface might not be possible. Please see "Effective reading size" on Page E-9.
- When the stop position of the sheet is shifted, after the visible screen has been scrolled, the screen is further scrolled to the correct stop position and stops automatically.

Notice

- Do not move the sheet manually.
When the stop position of the sheet is offset, the drawing may not print properly.
- When the stop position of the sheet is shifted, press the Feed button and set the proper stop position.

Continued on next page

3

Press the Color  button and select Color or Black & White.

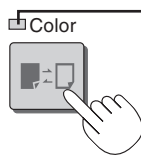

Color mode lamp
Lit Printing will be in color.
Unlit Printing will be in black & white.

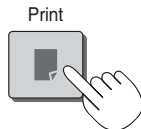

4

Press the Print  button to print.



- The reading operation is performed for a one-sheet portion (while the sheet is scrolled) and the printing operation is performed.

Note

- If the ON/Standby  button is pressed while the sheet surface is being read, printing is interrupted and only part of the image will be printed.
To move the sheet surface, wait until scrolling stops, then press the Feed  button.
- When a USB memory has been inserted, a press of the Save  button during printing will start the USB memory storage operation after printing is completed. (See Page E-24.)
- The one-screen portion is reduced to A4 paper size and printed.
For wide type Captureboards (model C-11W), the image is compressed about 75% in the horizontal direction. To print with the same proportions as the image on the sheet surface, see "Printing in the same ratio as the sheet surface" (page E-22).
- A flashing "E 1" in the display window indicates a print error. See "Meaning of Error Messages" on Page E-28.
- While scrolling, a moving hole will be visible at the bottom of the sheet; however, this is a required hole according to the specifications and is not damage.
- When the sheet is moving, buckling of the sheet may be observed; however, this is not a fault.



5

When the Captureboard is not going to be used, press the ON/Standby  button and switch off the power (standby mode).



- Switch off the printer power.

Note

- If no button is operated for 30 minutes or greater, the unit is set to the sleep mode and the LEDs on the control panel turn off. If the ON/Standby  button is pressed, the LEDs on the display window turn on. If the print button  is pressed at this time, the printing operation starts.

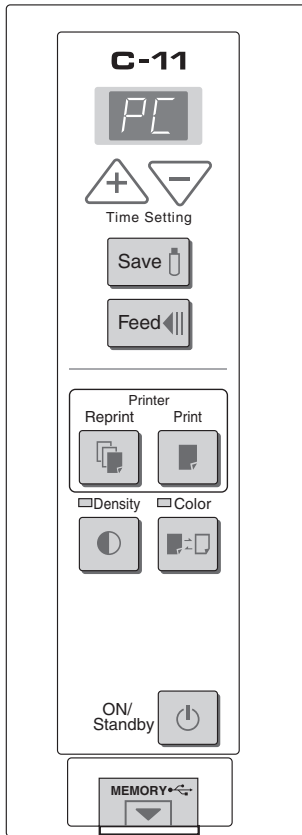

Selecting the printing density

Select this when the density of the print is light.

Press the Density  button and select darker or standard.

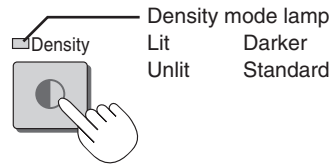

Making additional copies

This will print the copy of the sheet that was scrolled previously one more time.

Press the Reprint  button.

This starts the printing of the image data that has accumulated in internal memory.

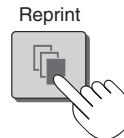

Note

- The sheet is not scrolled when additional copies are made.
- In repeat printing, the color/black & white and density settings will be the same as those of the prior printing.
- When printing or USB memory storage has not been performed since switching on the power, image data will not have accumulated in the internal memory and this operation will not be possible.

Cancellation of the print operation in progress

During the read operation (when the Print button was pressed)

When the ON/Standby  button is pressed, the reading of the sheet stops, and the partially read image data is printed. Wait until the sheet is expelled from the printer.

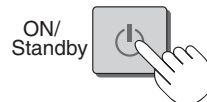

Stopping the printing after the Print  button was pressed and the reading completed

Stopping during reprinting (When the Reprint  button has been pressed)

Press the Captureboard's ON/Standby  button. After several seconds, printing is interrupted and the sheet is expelled.

Printing

Printing in the same ratio as the sheet surface (Model C-11W)

Model C-11W is the wide type Captureboard which will compress printing in the horizontal direction resulting in crowded printing of the A4 or LETTER size sheet; for example, a circle will become an ellipse. To print in the same aspect ratio as a drawn diagram, the compression mode will be changed (to suit the paper size according to the sheet surface image). The factory default setting is the horizontal compression mode.

When the power is on, press the ON/Standby  button while holding down the Color  button.



There will be a change to the “equivalent compression mode.” When the mode changes, the Color mode indicator will flash for 5 seconds.

To return to the “horizontal compression mode,” perform the same operation.

Using USB Memory

The content of what has been drawn on the sheet surface of the Captureboard can be saved in USB memory. Later, the saved image can be read into a personal computer and made into a document of the proceedings of the meeting, or affixed to a document.

Notice

- Images projected with a projector cannot be saved in USB memory.

What is needed to use the USB memory function

USB memory: Commercially-available product
Personal computer: The connector is a USB port (type A), and the interface supports USB 1.1

Note

- The Captureboard supports the USB memory formats of FAT and FAT 32.

Notice

- For the specification of the USB memory devices compatible with this Captureboard, please go to our website at: <http://www.plus-vision.com>

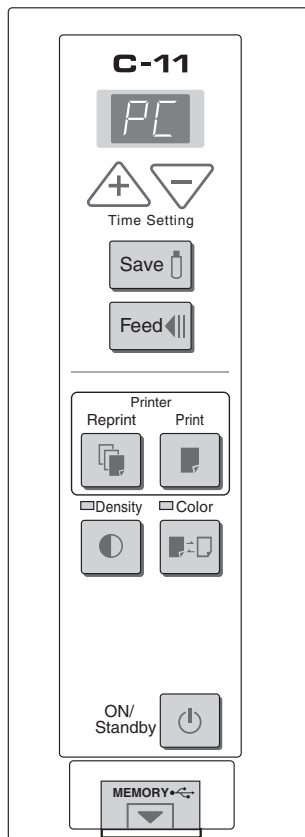

USB Memory Storage Procedure

Preparation:



Connect the AC power adapter to the Captureboard. See Page E-13.

1

Press the ON/Standby  button and switch on the power.



Note

- Press the ON/Standby  button more than 5 seconds when connecting the AC power adapter to the Captureboard unit or after turning off the power.
- Press the ON/Standby  button to switch on the power. The LED of the display window will light.

2

Insert the USB memory device into the Memory  port (USB port) of the Captureboard

Notice

- Check the side (polarity) of the USB memory device before inserting it. Forcing it in the reverse orientation will damage the USB port or USB memory device.
- Be careful not to bump into the USB memory device with hand or body while it is mounted. Doing so could damage the USB memory device or USB port.

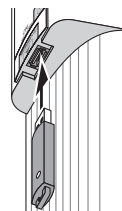

3

Press the Feed  button and display the sheet surface you want to store.



Pressing the Feed button scrolls the sheet one screen portion to the left and it stops automatically.

Note

- The one screen portion that is viewable will be saved in USB memory.
- Saving of the portion located around the sheet surface might not be possible. Please see "Effective reading size" on Page E-9.
- When the stop position of the sheet is shifted, after the visible screen has been scrolled, the screen is further scrolled to the correct stop position and stops automatically.

Notice

- Do not move the sheet manually.
When the stop position of the sheet is offset, the drawing may not save properly.
- When the stop position of the sheet is shifted, press the Feed button and set the proper stop position.

Using USB Memory

4

Press the Color  button and select Color or Black & White.

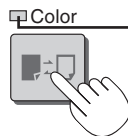

Color mode lamp

Lit Printing will be in color.

Unlit Printing will be in black & white.

5

Press the Save  button to store



Display window

Flashing indicator “rotates” sequentially during USB memory storage operation.

- The reading operation is performed for a one-sheet portion (while the sheet is scrolled) and USB memory storage starts after the scrolling completes.







The (5 second) flashing “US” display indicates that the USB memory has not been inserted. Please insert the USB memory and then press the Save  button.



A (5 second) flashing “FL” display indicates that there is insufficient free capacity to permit storage in USB memory. The flashing display will stop when the USB memory device is removed. Replace with a USB memory device having sufficient capacity.

See “Meaning of Error Messages” on Page E-28 for other error displays.

Note

- Depending on the USB memory, it may take time for recognition or it may take time for saving.
- When the ON/Standby  button is pressed during the reading operation, the reading operation will be discontinued and the partially read image data will be stored in the USB memory.
To move the sheet surface, press the Feed  button after the scrolling has stopped.
- The image that is projected onto the sheet surface will not be saved to USB memory.
- A press of the Print  button during USB memory storage starts the printing after storage is completed.
- When the wide type (C-11W) Captureboard has been adjusted to the paper size in the horizontal direction, the image will be compressed to about 75%.
- The date and time of the saved file will reflect the Captureboard time setting. See “Setting the Time” on Page E-14.
- When a certain amount of free capacity is not available in the USB memory, “FL” will be displayed when the Save  button is pressed. Also, when insufficient free capacity arises during saving, “FL” will be displayed at that time. Delete the data and return the sheet surface to the original condition, then press the Save  button again.

Removing the USB memory

Check that the flashing rotation of the display window has changed to steady lighting and that the USB memory access indicator is not flashing, then pull the USB memory straight out. (Please see your USB memory manual for details.)

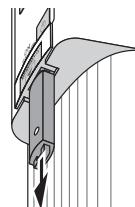

Notice

- Do not unplug the USB memory device during the USB memory storage operation (i.e., during the rotating, flashing display in the display window), or while the access indicator of the USB memory device is flashing because data will be destroyed.

6

When the Captureboard is not going to be used, press the ON/Standby  button and switch off the power (standby mode).



Note

- “USB” letters appearing at one-second intervals in a moving display in the display window indicate that a USB memory device is mounted. Unplugging the USB memory device will switch off the power. (A function that serves as a reminder to unplug the USB memory device)
- If no button is operated for 30 minutes or greater, the unit is set to the sleep mode and the LEDs on the control panel turn off. If the ON/Standby  button is pressed, the LEDs on the display window turn on. If the save button is pressed at this time, storing of the data in the USB memory device starts.

Using USB Memory

Saving Image Files to a Personal Computer, and Deleting Image Files

This is an operation example of storing the image file that has been stored in USB memory on the hard disk of the personal computer, or deleting the folder when the USB memory capacity has become full. (There are various methods that can be used for saving and deleting including the use of Explorer.) See the instruction manual of your personal computer or the software that you are using for information about using a personal computer.

The folder name of the Captureboard inside USB memory is C-11. Image files are stored in this folder. Image file names are stored as PV-xxxxxx.png (a PNG file) and PV-xxxxxx.htm (an HTML file). “xxxxxx” stands for the date and number (e.g., PV-06110801.png, PV-06110801.htm).

Notice

To obtain a display and printing that matches the screen size, open the HTML file in a browser and use the browser.

Note

The HTML file and PNG file are associated; therefore, use them as a pair when moving or copying to a separate folder.

1

Plug the USB memory device into a USB port of the personal computer

When connecting to the personal computer for the first time, the installation of a USB driver is required. Follow the instructions manual of the USB memory device that you are using.

- Usually, with Windows 2000/XP/Vista the standard driver is installed automatically and is identified as “Removable disk” in “My Computer.”

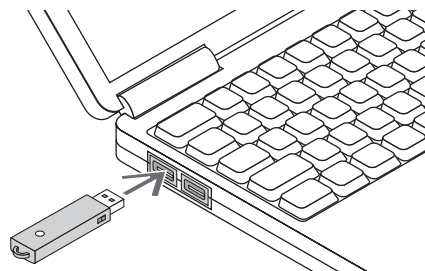

2

Saving the image files of a USB memory device to a personal computer

1. Open “My Computer” and from within, open the drive of the connected USB memory device.

The folder named “C-11” is the saved data of the Captureboard.

2. Store the “C-11” folder in “My Documents” or another location.

All of the data contained in “C-11” will be stored.

Notice

Depending on the computer’s usage environment, these operations may not work properly. This could be the case for example:

- when several USB devices are connected simultaneously to the computer.
 - when the USB device is connected to a USB hub or when it is connected using an extension cable.
-

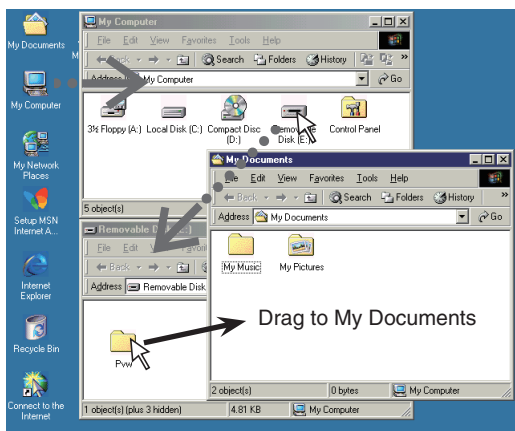

Deleting USB memory image files with the computer

Before deleting important image files, be sure to save them on the computer (as a data backup).

1. Open “My Computer” and then open the drive icon which shows USB memory.

The folder named “C-11” contains the memory storage data of the Captureboard.

2. Place the “C-11” folder in the “Recycle Bin”, right click on the icon and select “Empty Recycle Bin” from the pull-down menu.

All of the data contained in “C-11” will be deleted.

Even when the entire folder is deleted, a new C-11 folder will be created automatically when USB memory is used again with the Captureboard.

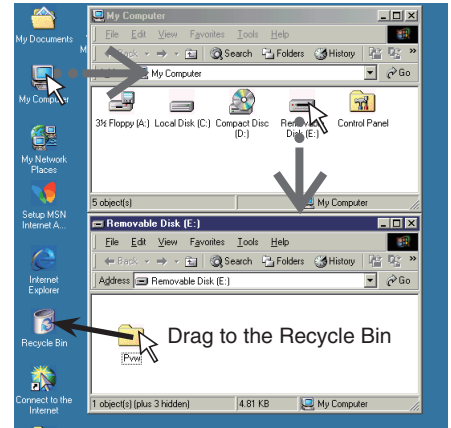

3

Disconnect the USB memory

The disconnecting procedure depends on the computer’s operating system. For details, refer to the computer’s operating instructions or help files.

1. Click the [Hardware Removal] icon that is displayed in the task tray.

Click “Stop USB Mass storage Device - drive (E)”. (The E drive character will differ depending on the personal computer system.)

2. Click [OK] when “The ‘USB Mass storage Device’ device can now be safely removed from the System” is displayed.

(When using Windows XP/Vista, [OK] does not appear on the message screen. Simply disconnect.)

3. This allows the USB memory device to be unplugged from the computer.

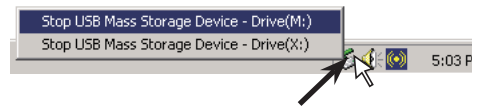

“Remove hardware” icon (example)



Note

- Do not disconnect the USB memory device while the USB memory device’s access indicator is flashing. Doing so will damage the data.
- The USB drive may not be disconnected properly, for example if the computer is in the process of checking the status of peripherals.

Accompanying Software

See the Captureboard Software Operation Manual and the Help screens of the various software for information about the method of using the software contained on the accompanying CD-ROM.

Software Contents and Overview

• USB Driver

This driver allows the computer to recognize the Captureboard as an external device when there is a USB connection. Be sure to install this USB driver when connecting the PC dedicated USB port with the computer.

• TWAIN Driver

This driver is used to acquire the scanned data into a computer as an image.

* This driver may not work on some applications.

* This driver conforms to TWAIN standard (ver. 1.9).

• Setup Utility

This is a utility for customizing the C-11's environmental settings.

• Captureboard Soft

This software combines the read image data of the main unit and the projection image of the projector. It also displays and stores the data on a personal computer.

• User's Manual

The User's Manual is stored on the CD-ROM in PDF format.

If Acrobat Reader is not installed on the PC, click "Acrobat Reader" on the menu and install it according to the instructions on the screen.

• Acrobat Reader

This software is used to view PDF files.

• Browsing the CD-ROM

Explorer running on the personal computer is used to display the contents of the CD-ROM.

• Copyrights and usage conditions

This opens the copyrights, usage conditions, etc.

Note

- When installing on Windows 2000, please install the software with "Administrator" authority (i.e., a user having administrator authority).
- When installing on Windows XP/Vista, please install the software with "Computer Administrator" authority (account).

Notice

Help function

- The Help functions of the Captureboard Soft application and the Setup utility use the online Microsoft HTML help format.

User Account Control in Windows Vista

- When the User Account Control setting is disabled, the software may not function properly.
-

Operating Environment

Supported OS:	Microsoft Windows 2000 Professional (Service Pack 4 or later)/ XP (HomeEdition / Professional Edition Service Pack 2 or later)/ Vista (32 bit version)
Supported PC:	IBM PC/AT or completely compatible machines that operate the aforementioned OS
CPU:	Pentium II or later
Memory:	Windows 2000 (128 MB or bigger), Windows XP (256 MB or bigger)
Free hard disk space:	40 MB or bigger
Display resolution:	800 × 600 pixels or higher
Peripheral devices:	a CD-ROM /DVD-ROM drive, a standard USB port (USB 1.1 or 2.0)
Web browser:	Internet Explorer 6.0 or later

Notice

- All operations are not guaranteed under the aforementioned operating environment.
 - Windows 95, 98SE/Me, NT, 2000 Server, Server 2003, and Vista (64 bit version) are not supported.
-

Meaning of Error Messages

If any of the following flashing indications appear in the display window of the control panel, please check the matters described below. The flashing will continue for 5 seconds. Error messages will flash for 5 seconds; however, error displays of “E4”, “E5” and “E6” will be lit steadily after the flashing stops.

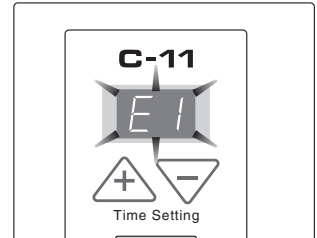

Error Display Number	Problem and Solution	
Printer not connected No printing paper Printer problem	<ul style="list-style-type: none"> Is the printer cable connected? Is power being supplied to the printer? When the printer uses an AC power adapter, is the cable disconnected somewhere? 	<ul style="list-style-type: none"> Connect the printer properly and switch on the printer power.
USB Memory not recognized	<ul style="list-style-type: none"> Has paper been set in the printer? 	<ul style="list-style-type: none"> Turn the power of the printer off and then on again, and load the printer with A4 paper.
	<ul style="list-style-type: none"> Is the printer error indicator flashing (or lit)? 	<ul style="list-style-type: none"> Read the printer instruction manual.
	<ul style="list-style-type: none"> Is the USB memory unformatted. Is a USB memory that is not supported by the Captureboard being used? Is the USB memory device plugged in fully? Is the USB memory damaged? 	<ul style="list-style-type: none"> This unit supports the FAT and FAT 32 formats. Perform the formatting with the personal computer. Please see our home page for information about USB memories that can be used with the Captureboard. (http://www.plus-vision.com) Please check the operation with a personal computer.
USB Memory storage problem	<ul style="list-style-type: none"> An error occurred during USB memory storage. 	<ul style="list-style-type: none"> Please perform USB memory storage again. Do not insert or remove the USB memory during processing.
Reading problem	<ul style="list-style-type: none"> There is a lighting fault of the reading light source, or a read signal error. 	<ul style="list-style-type: none"> Unplug the power plug from the power outlet and then plug it in again.
System error	<ul style="list-style-type: none"> There is a memory or internal fault. 	<ul style="list-style-type: none"> Unplug the power plug from the power outlet and then plug it in again.
Page detection error	<ul style="list-style-type: none"> The pages are not being properly detected. 	<ul style="list-style-type: none"> Unplug the power plug from the power outlet and then plug it in again.
USB memory not connected	<ul style="list-style-type: none"> USB memory device is not plugged into the main unit. 	<ul style="list-style-type: none"> Plug the USB memory device into the USB port.
When the “USB” letter display is flowing...Warning that disconnection of USB memory has been forgotten	<ul style="list-style-type: none"> Did you press the ON/Standby (⏻) button while the USB memory device was plugged into the main unit? 	<ul style="list-style-type: none"> A USB memory device is plugged into the main unit. When the USB memory device is disconnected, the power will be switched off and the unit will enter the standby mode.
USB Memory is full	<ul style="list-style-type: none"> There is no available space. 	<ul style="list-style-type: none"> Please delete unnecessary data using a personal computer (See Page E-24, E-26).
An unsupported printer is connected	<ul style="list-style-type: none"> A printer that is not supported by the Captureboard has been connected. 	<ul style="list-style-type: none"> Press the ON/Standby (⏻) button and switch off the power. When a record is required, switch on the power and save to USB memory.

If the problem persists, please contact your nearby PLUS Vision sales office, dealer, or store.

Troubleshooting

Please check the following matters before making a request for servicing.

Condition	Please Check
Pressing the ON/Standby ⏻ button does not switch on the power.	<ul style="list-style-type: none"> • Check whether the cable of the AC power adapter is disconnected from the DC connector of the Captureboard or the wall outlet. (Unplug the AC power cable from the outlet, wait several seconds and then plug it back into the outlet again.)
Writing on the sheet is not erased with the eraser.	<ul style="list-style-type: none"> • Is a marker other than a dedicated marker being used? • Is an eraser other than a dedicated eraser being used? • Has a soiled eraser been used on the erased surface? (Wring the water out of a moistened cloth and wipe carefully. Also, replace the sponge with a new one and use the eraser.)
Portions of writing or lines are not printed or stored in memory.	<ul style="list-style-type: none"> • Portions of blurred characters or thin lines may not be printed or stored in USB memory. • Change Density setting to "Dark".
The copy is soiled. (The image data is dirty at the time of printing, USB memory storage, or personal computer saving.)	<ul style="list-style-type: none"> • Is there a lot of marker refuse adhering to the sheet? (When soiled, moisten a soft cloth with water, wring well, and wipe the sheet in a stroking manner.)
The black ink mixes into other color in the case of Color Mode.	<ul style="list-style-type: none"> • Check the density indicator, and select standard density if the setting is darker.
When the Captureboard and PC are connected, the supplied utility program does not operate after installation of the USB driver	<ul style="list-style-type: none"> • Has the USB driver in the CD-ROM been properly registered in the device manager? (An exclamation mark (!) will be affixed if it has not been registered.) (If not registered, delete the USB driver and reinstall it.) (Uninstall the Captureboard software and then install it again.)
When the Captureboard and PC are connected, the PC does not recognize the Captureboard	<ul style="list-style-type: none"> • Check whether the Captureboard is in an operable condition, and whether the USB cable is connected properly. • Is the Captureboard connected to the PC via a USB hub? (Connect the Captureboard directly to the USB port of the PC.)

* If the problem persists, please contact your nearby PLUS Vision sales office, dealer, or store.

Specifications

BOARD TYPE (Model name)		Wide (C-11W)
Form	Installation method	Self-standing (T-shaped legs), or wall mounting
	External dimensions (T-shaped legs*1)	W1970 × D700 × H1970*2 mm
	Main unit weight	33.0 kg*3
	T-shaped legs weight	9.6 kg
BOARD	Panel Size	H920 × W1800 mm
	Effective reading size	H900 × W1780 mm
	Number of Pages	2
	Paging	Endless in one direction (Horizontal scrolling)
	Drive method	Sheet movement
	Reading method	CCD sensor reduction optical system
	Reading illumination light source	RGB LED
	Reading resolution	Main scanning direction (vertical sheet surface) 2.4 dots/mm (60 dpi or equivalent) Sub scanning direction (horizontal sheet surface) 2.4 dots/mm (60 dpi or equivalent)
	Reading time	Black & white: approx. 20 s Color: approx. 31 s
Memory	Type	USB Flash memory*4
	Compatible FAT types	FAT 12, 16, 32
	File format	PNG format*5 and associated HTML format
	Interface	USB1.1 or USB2.0 full-speed mode*6
Control panel	Control buttons	ON/Standby, +, -, Print, Save, Reprint, Color, Density, Feed
	LED Indicators	Density, Color
	Display	7-Segment (Status of PC connection, Error#),
Added functions	Clock	Used for the timestamp and for file dating properties (Includes backup battery for when there is a loss of power)
	PC connection	Transfer of sheet surface image data via USB (TWAIN supported)
Power supply	AC power adapter	Input : AC100–240V/50–60 Hz, Max 1.5 A Output : DC 24 V, 2.71 A
Operating conditions	Temperature:	10–35°C
	Humidity:	30–85% (No condensation)
Recording Section	Printer interface	USB1.1 or USB2.0 full-speed mode compliant printers are supported
Miscellaneous	Ruled lines	None
	Miscellaneous	Dedicated markers (black, red, blue, and green)

Remarks

*1: Height adjustable in three stages of 1770, 1870, and 1970 mm.

*2: H (height) reflects the maximum value of the dimension.

*3: Weight of printer is not included.

*4: USB flash memory is not supplied.

*5: Open with Internet Explorer 6.0 or higher, or a Web browser that supports PNG file viewing.

*6: High-speed is not supported.

- Please note that the appearance of the main unit, the supplied printer, specifications, and other items are subject to change without notice for the purpose of quality improvement.
- Depending on the product that you have purchased, the printer and (T-shaped) stand may be sold separately.
- This machine contains eParts of the eSOL, Co., Ltd.

Appendix (When a printer has been purchased as an optional item)

Connections Between the Captureboard and Printer

To use a printer, please connect the Captureboard and printer.

The connections on the printer side will differ depending on the printer that you have purchased. Please see your printer manual for details.

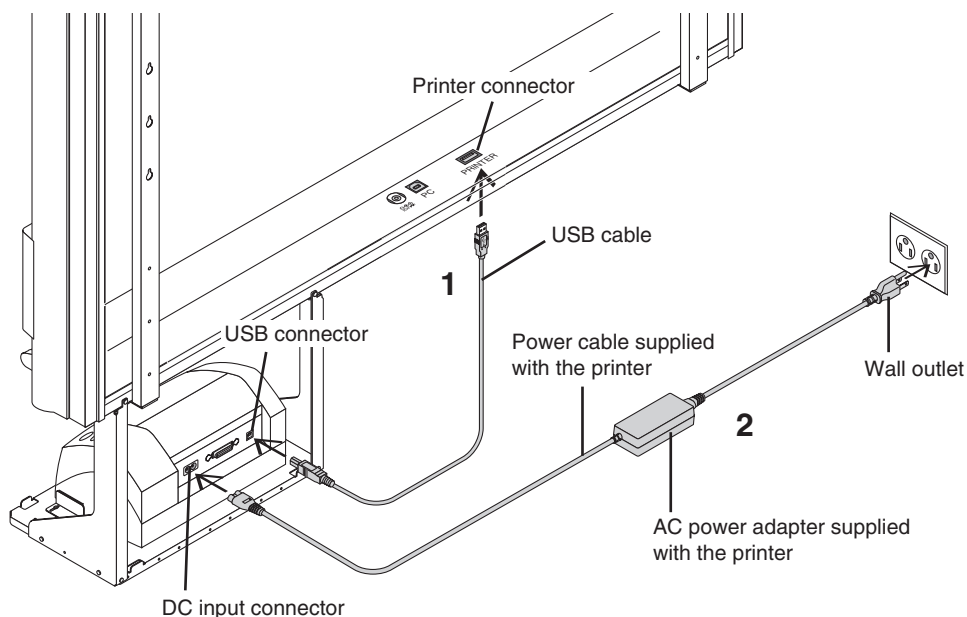

* Be sure to insert all the plugs securely.

1 Connect the Captureboard's printer connector with the printer's USB connector using the USB cable.

Notice

For page printers

When installing the printer for the first time, remove the protective sheet for use during transportation from the image drum cartridge before connecting the power cord. (For directions on removing the sheet, see the printer's operating instructions.)

2 Use the power cable supplied with the printer to connect the DC input connector of the printer with the wall outlet.

Note

When an AC power adapter is used with a printer that has been verified to be operational, although the printer type may differ from that of the connection diagrams (e.g., a built-in type, or assembled type), the connections should be performed based on the same main points. (In accordance with the printer specifications)

3 This completes the connection of the printer.



Connect the Captureboard's power supply. See "Connecting the Captureboard's AC Power Adapter" on Page E-13.

* The printer shown in the diagram is for explanatory purposes only. Please refer to the printer user manual for proper connections.

When there is a Problem with Printing

When the Captureboard and an optional printer have been connected and you think there might be a breakdown, please check the following matters before requesting repair.

Condition	Please Check
A press of the Print  button does not result in printing.	<ul style="list-style-type: none"> • Check that the power cable of the printer and the printer cable are securely connected. • Check that the printer power indicator is lit. • Check that the error indicators of the Captureboard and the printer are not lit. • If the error indicator of the Captureboard is flashing, please see Page E-28. (Please see the printer instruction manual for information about printer errors.)
The paper feed is abnormal.	<ul style="list-style-type: none"> • Possible causes include damp paper, overly thin or thick paper, only one sheet of paper is set, and a curved setting of the paper. (Please see the instruction manual for your printer.)
An altered color is printed, not the specified color.	<ul style="list-style-type: none"> • Please replace the print cartridges with new ones.
There is no printing.	<ul style="list-style-type: none"> • Check that the print cartridge is properly set. • Check that the print cartridge is not plugged.
<ul style="list-style-type: none"> ◦ Print is very pale, there are white lines on it, or page is dirty. ◦ Printed colors are very different from those of the markers that were used. 	<ul style="list-style-type: none"> Is the print cartridge's nozzle partially choked? ◆ Make a test print and check the conditions of the nozzle.

Test printing procedure	Check the print	Remedy
<ul style="list-style-type: none"> ◦ Turn on the power of the Captureboard and the printer. ◦ Press the "print"  button while pressing the "color"  button on the Captureboard's control panel. • Test printing starts. 	<ul style="list-style-type: none"> ◦ Is the each color line printed uniformly? ◦ Are there missing dots, pale lines, lines with thinner ink than others, etc.? 	<ul style="list-style-type: none"> ◆ If the nozzle is partially choked, clean it. ◆ If the quality of the print does not improve even though the nozzle has been cleaned, wipe off the ink on the surface of the nozzle. <p>For details, see the "User's Guide" included with the printer.</p>

* Please see your printer manual for information about printing problems, printer maintenance, and details related to printing.