

Visual Worktools Specification Guide



205 Westwood Ave, Long Branch, NJ 07740
 Phone: 866-94 BOARDS (26273) / (732)-222-1511
 Fax: (732)-222-7088 | E-mail: sales@touchboards.com

What's New?

Spec News is available on in2.steelcase.com. Go to *Specification Guides-AdStock*, under *Sales Resources/Sales Marketing Materials*, and download the current release's Spec News.

Availability

Electronic price list updated with release 172.A (U.S.) and 142.A (Canada), dated November 15, 2010.

Transitional products in this specification guide are **maintained for existing customers only** and are likely to be phased out over time. These products are indicated with a . Products that are scheduled to be culled are indicated with an , followed by the last order entry date.

Statement of Line	2
--------------------------	----------

e³ environmental ceramicsteel by PolyVision	5
---	----------

Material Description	6
-----------------------------	----------

e³ Cleaning/Daily Care and Maintenance	8
--	----------

e³ Application Information	9
--	----------

PPPW (Privacy Wall) and on/off Module Bracket Application Guide	10
--	-----------

Screenprint Options	11
----------------------------	-----------

Premium and Contractor Series Whiteboards and Tackboards	14
---	-----------

Interactive Worktools	73
------------------------------	-----------

Surface Materials	87
--------------------------	-----------

Resources	93
------------------	-----------

► For a list of all trademarks, refer to the last page of this specification guide.



For Canadian Pricing

Calculate in the following order to avoid rounding errors:

- Multiply the base price and each option by 1.10.
- Round each to the nearest dollar.
- Add base and options for total list price.

Statement of Line

Visual Worktools

Premium Whiteboards and Tackboards

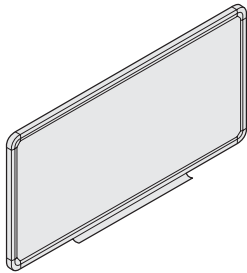

Senti Series
▶ Page 14

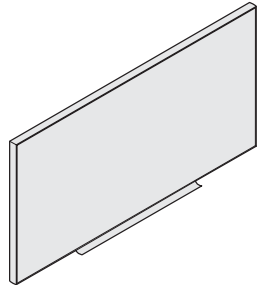

Edge Series
▶ Page 18

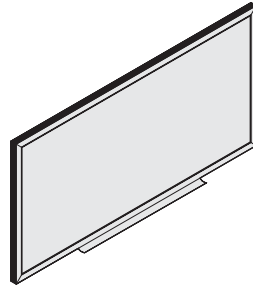

Access Series
▶ Page 24

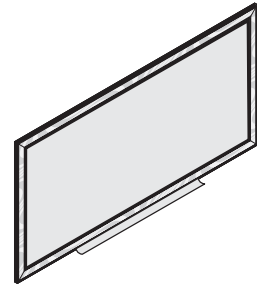

Denska Series
▶ Page 28

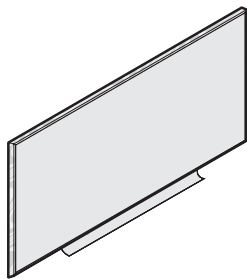

Session Series
▶ Page 32

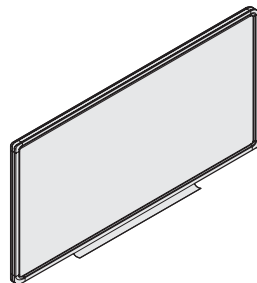

FreeFlow Series
▶ Page 36

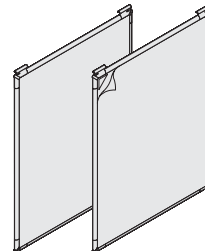

Huddleboard
▶ Page 42

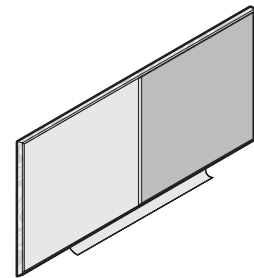

Combo Boards
▶ Page 46

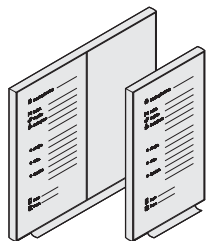

Patient Room Boards
▶ Page 54

Contractor Series Whiteboards and Tackboards

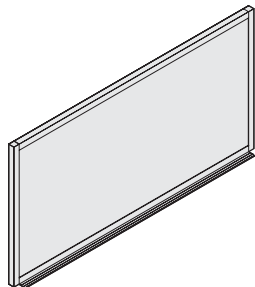

110 Series
▶ Page 58

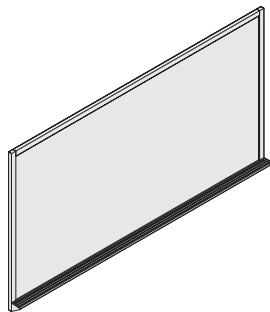

555 Series
▶ Page 62

Premium Whiteboard In-Fill

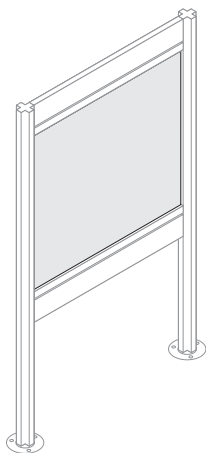

▶ Page 68

Interactive Worktools

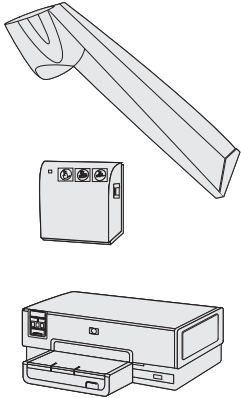

Copycam Pro
▶ Page 74

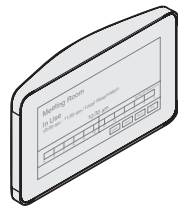

RoomWizard II Room Scheduling System
▶ Page 78

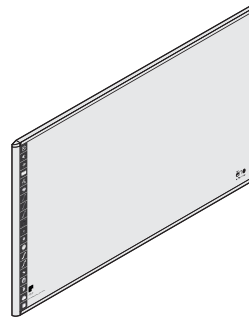

ēno Interactive Whiteboard
▶ Page 82

The e³ environmental ceramicsteel Difference

Steelcase Premium White Boards incorporate the e³ environmental ceramicsteel surface, which is the first and only ecologically intelligent whiteboard surface to receive a MBDC Cradle to Cradle Gold certification. Cradle to Cradle certification evaluates products for environmentally safe and healthy materials; energy and water use during production, the ability to recycle and reuse materials, and social responsibility. PolyVision, a Steelcase company, has created its fourth generation of ceramicsteel writing surfaces, e³, which delivers the properties of its best selling writing surface, P³ ceramicsteel, and complies with the Cradle to Cradle certification criteria. Steelcase will continue to follow standards set forth by MBDC Cradle to Cradle certification to reaffirm our commitment to sustainability. For over five decades, millions of boards have been produced around the world using PolyVision P³ ceramicsteel. PolyVision used this cross section of consumers to gather the information that helped determine what the next generation of writing surfaces should provide. Our internationally renowned R&D team worked with experts in the field of ceramics and technology to create e³ environmental ceramicsteel surface - the new industry standard for superior quality.

The e³ environmental ceramicsteel Advantage

The ceramic finish consists of a specially formulated glass substance applied by machine. The e³ environmental ceramicsteel surface is fused to steel at a temperature of approximately 1500 degrees Fahrenheit for markerboards. It registers at a minimum of five (5) on the revised Mohs hardness scale.

Benefits of e³

- Ultra-smooth writing surface
- Improved erasability
- Greater color contrast
- Significantly less surface/light distortion
- Optimum eye comfort
- Enhanced visibility
- Reduced chalk pressure, greater adherence
- Increased chalk/surface contrast
- Accepts magnets

Environmental Features

- Enamel fused to cold-rolled enameling-grade steel
- In all coatings, the total amount of heavy metals cadmium, mercury, hexavalent chromium, and lead is less than 0.1%
- All coatings are free of arsenic and antimony
- No Volatile Organic Compounds (VOCs)
- Steel core is made from minimum 30% post-consumer and post-industrial waste
- e³ environmental ceramicsteel surface is 99% recyclable

Material Description

e³ environmental ceramicsteel is produced by a controlled, continuous coil-coating process. The surface consists of a steel core of .013" and .019" thickness covered on both sides with thin enamel coatings. The ceramic finish is fused to the steel at a temperature of approximately 1500°F for markerboard and 1250°F for chalkboard.

Characteristic	e ³ environmental ceramicsteel Markerboard	e ³ environmental ceramicsteel Chalkboard
Writeability	Can be written on with any dry-erase, semi-permanent, water-soluble, permanent marker, pen, or crayon without damaging the surface.	Superior, low-gloss, matte finish readily accepts chalk providing a sharp, unbroken line with less pressure and maximum surface adherence.
Visibility	Contrast/waviness for markerboards (light and dark effects) shall be no greater than 15 when tested with BYK - Gardner Wave Scan 5+ measurement device showing visual acuity (contrast sensitivity) to the human eye at distances greater than 3 meters (10'- 0"). Resolution (visual acuity) shall be based on 3 lines per degree and be visibly maintained beyond the current standard of 3 meters.	Contrast/waviness for chalkboards (light and dark effects) shall be no less than 20 when tested with the contrast measurement test with 773-gram load on chalk. Resolution (visual acuity) shall be based on 3 lines per degree and be visibly maintained beyond the current standard of 3 meters.
Erasability	Dry-erase marker ink can be wiped off easily with a dry cloth or standard eraser. Crayon, semi-permanent, and permanent marker pen inks can be removed with a solvent based cleaner.	Erases easily with a dry cloth or standard chalk eraser, retains minimal residual chalk dust, and will not leave "ghost writing." Color change (dark/light) after chalk erasing is reduced 60% from traditional surfaces.
Cleanability (Washability)	All residues that remain after normal erasing can be removed by following the care and cleaning instructions on the www.polyvision.com/e3cleaning website.	WET Ghost measurements on chalkboard surfaces before and after wet cleaning shall not exceed a factor of 0.49. For further care and cleaning instructions, refer to the www.polyvision.com/e3cleaning website.
Wearability	Vitrified glass-hard ceramic surface fused to light-gauge enameling grade steel at approximately +1500°F. High resistance to impact damage, abrasion, scratching, and color fading. The e ³ environmental ceramicsteel surface registers a 6.5 on the revised Mohs hardness scale.	Vitrified glass-hard ceramic surface fused to light-gauge enameling grade steel at approximately +1250°F. High resistance to impact damage, abrasion, scratching, and color fading. The e ³ environmental ceramicsteel surface registers at a minimum of 5 on the revised Mohs hardness scale.
Magnet Capability	The e ³ environmental ceramicsteel surfaces are ideal for all magnets and magnetic impregnated materials and will not be scratched or damaged from the contact.	The e ³ environmental ceramicsteel surfaces are ideal for all magnets and magnetic impregnated materials and will not be scratched or damaged from the contact.
Flame Resistance	The e ³ surface is 100% non-combustible.	The e ³ surface is 100% non-combustible.

**e³ environmental ceramicsteel
Low-Gloss Markerboard**

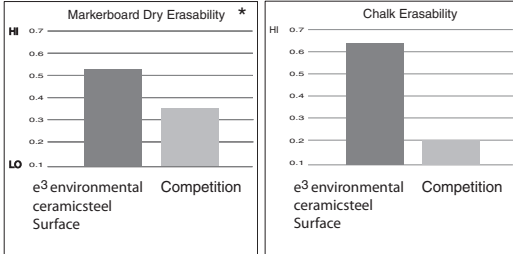

The ultra-smooth finish enables dry markers and chalk to glide easily across the e³ environmental ceramicsteel surface with minimal friction. The surface smoothness allows more dry-erase ink and chalk to be removed, improving erasability and eliminating “ghost writing”.

*All markerboard erasability tests were conducted using High-Gloss e³ environmental ceramicsteel surfaces.

For more information on e³ environmental ceramicsteel, visit www.polyvision.com

Writeability

Provides the same writing characteristics as High-Gloss.

Erasability

Low-Gloss surfaces will not erase as thoroughly as High-Gloss surfaces. When this occurs, a water-dampened cloth will be required to erase the surface.

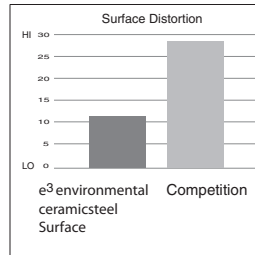

Surface distortion (Orange Peel) has been reduced significantly in direct comparison with the competition’s surface.

Cleanability

After normal erasing of Low-Gloss surfaces, solvents may be used to remove harder-to-erase dry marker inks and residue from other pens. Always clear water rinse after using any cleaning agent on the surface. Refer to: www.polyvision.com/e3 cleaning for further details.

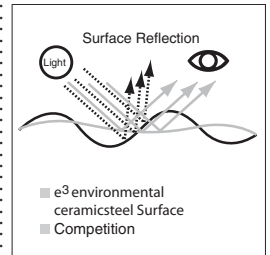

The e³ environmental ceramicsteel surface maximizes the performance of reflected light and reduces surface glare, resulting in improved visibility under a wide range of lighting conditions.

e³ Cleaning/Daily Care and Maintenance

Maintenance

- Wipe board with a clean cloth moistened by a liquid markerboard cleaner or a solution of 50% water and 50% isopropyl alcohol.
 - Rinse with clear water.
 - Wipe dry with a clean cloth
- If your board is used daily, the cleaning should be performed at least 2-3 times a week.

More thorough cleaning may be required if writing is left on the board for more than two days.

Markers

Use any high-quality dry erase marker.

CAUTION! The use of Low Odor markers may cause ghosting to occur. If Low Odor markers have been used, the surface can be completely cleaned by following the cleaning instructions above. Remember to discard eraser if used with Low Odor markers.

Removing Permanent Marker

Option 1:

- Write over the top of the permanent marker ink with a dry-erase marker
- Simply erase

Option 2:

- Moisten a clean, dry cloth with isopropyl alcohol
- Wipe the board in a circular motion to loosen marker residue
- Rinse with clear water
- Dry the board with a clean cloth
- Repeat these steps as necessary

Installer's Instructions for Initial Cleaning at Time of Installation

NOTE: These initial cleaning instructions are shipped with every board.

- For initial cleaning, wipe your board with a clean cloth moistened by a mild, alcohol-based cleaner.
- Rinse with clear water. This step is simple, but very important.
- Wipe dry with a clean cloth.

For online access to these instructions, visit www.polyvision.com

e³ Application Information

Sizes

Sizes of tackboards and markerboards are nominal; refer to actual dimensions for exact specifications.

Tackboards

- Standard tackboard construction is 3/8" fiberboard over 1/8" hardboard.
- COM fabrics may be specified. COMs must be approved.

Spline Joints

- Spline joints allow larger format boards to be delivered in 2 equal pieces. Assembly required.
- Whiteboards weigh approximately 5lbs/ft.
- Assembly required on-site.
- Spline joints are an option, with upcharge on: Edge, Access, Denska, 110 Series, and 555 Series markerboards 10' and larger in length.
- Spline board joints are visible. Every effort is made to ensure a tight seam.
- Please be sure your client is aware that the spline joint will show.

CopyCam

Using CopyCam with Premium Whiteboards

- CopyCam works with all Premium Whiteboards.
- IMPORTANT: Cables cannot be routed behind Senti, 110, or 555 Series boards.
- CopyCam works with boards 8' (2.4m) or less in width.
 - CopyCam is only available in champagne finish.

Magnetic Mount Option (MGMT)

- Enables Senti boards, up to 48" x 48", to be mounted on flat, painted steel surfaces only.

NOTE: This mount is not intended for fabric or other coverings over steel.

Option

Description

PLMT01	2" over panel bracket/hook
PLMT03	3" over panel bracket/hook

PPPW (Privacy Wall) and on/off Module Bracket Application Guide

PPPW (Privacy Wall) Bracket Application Guide

- On- and off-module bracket for installation of markerboards and tackboards on Privacy Wall, Answer, and Kick.
- Allows Premium Whiteboards to be mounted on Privacy Wall, Answer, Avenir, or Kick using a standard metal cleat mounting system.
- Ideal application on a Privacy Wall or when spanning multiple Answer/Kick panels with a single markerboard.
- Compatible with boards 48"H only.
- Not for use with Senti, FreeFlow, or Contractor Series.
- Cannot install two boards at right angles.
- Ships with six non-handed brackets for maximum application flexibility; field-modify for application by removing tabs per instructions.
- The required minimum number of PPPW (Privacy Wall) Brackets must be installed to ensure secure application of board.
- Brackets must be installed in the correct orientation; i.e. left or right hand, as indicated in the key and diagrams below.

NOTE: Space between panel face and rear of board is $\pm 1/4"$.

Standard Mounting Height and Centerline Application

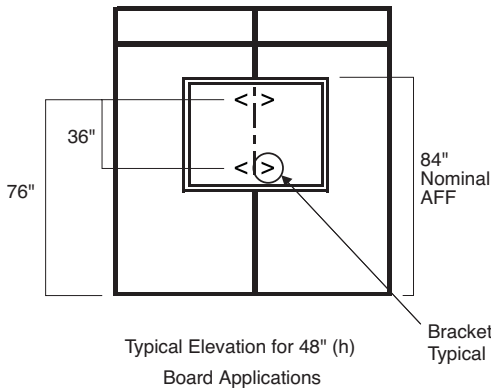

- 48"H x 48"W only

On-Module — Minimum Bracket Application

Board Width	48"	60"	72"	84"	96"	120"	144"	168"	192"
Minimum Number of Brackets	4	4	4	4	4	4	6	6	6

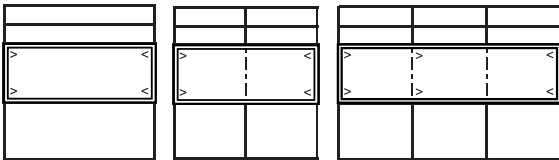

KEY:

- > Right Hand Application of PPPW Bracket
- < Left Hand Application of PPPW Bracket

Asymmetrical Off-Module Overhang Allowances and Minimum Bracket Application

Board Width	60"	72"	84"	96"	120"	144"	168"	192"
Minimum Number of Brackets	4	4	4	4	4	6	6	6
Dimension A - Maximum Overhang	18"	22"	25"	29"	36"	38"	38"	38"

NOTE: Bracket direction must be the same as the overhang direction. This example shows right hand bracket installation with right hand overhang.

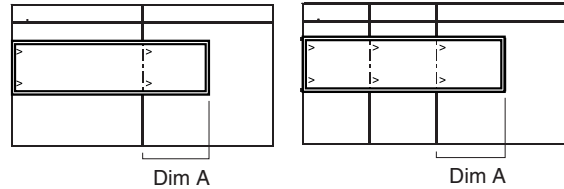

Symmetrical Off-Module Overhang Allowances and Minimum Bracket Application

Board Width	60"	72"	84"	96"	120"	144"	168"	192"
Minimum Number of Brackets	4	4	4	4	4	6	6	6
Dimension B - Maximum Overhang	18"	22"	25"	29"	36"	38"	38"	38"

NOTE: Dimension B must be equal on both the left and the right. For example, a 60" board may have a maximum 18" overhang both left and right side.

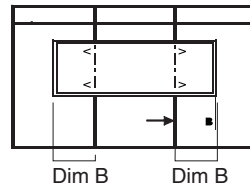

Screenprint Options

A selection of standard screenprint options are offered. Custom screenprint is also available. Screenprint graphics are permanently fused to the e³ environmental ceramicsteel surface. Screenprint is not available on boards with spline joints.

Standard Screenprint Options

Premium Whiteboards
Up to 10' Wide:

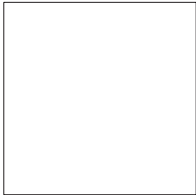

7655
e³ White

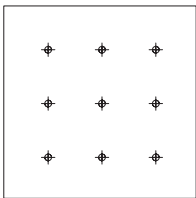

7656
Circular Dots
at 2" Intervals

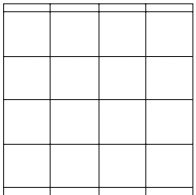

7657
2" x 2"
Grid Pattern

Contractor Series
Whiteboards
Up to 8' Wide:

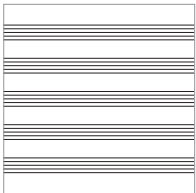

7658
Music Staff Lines
5 Lines per Staff

Standard Screenprint Options for Markerboards

Markerboards are available in 7655 High Gloss White e³ environmental ceramicsteel. Optional screenprint patterns are available to provide a guide for writing or drawing. Screenprint is not visible at a distance greater than 3' (0.9 meters), with the exception of Music Staff Lines which are printed in black.

Custom Screenprint Options for Markerboards

Custom screen printing is available in single or multiple colors on e³ environmental ceramicsteel. This service is available for both customer-provided artwork and Steelcase Visual Worktools standard artwork. Extended lead times apply. Artwork options include, but are not limited to:

- Planning boards
- Hospital boards
- Educational boards
- Corporate graphics and logos
- Maps

Please refer to screenprint guidelines.



Premium and Contractor Series Whiteboards and Tackboards

Senti Series	14
Edge Series	18
Access Series	24
Denska Series	28
Session Series	32
FreeFlow Series	36
Huddleboard Markerboards and Photo Boards	42
Combo Boards	46
Patient Room Boards	54
110 Contractor Series	58
555 Contractor Series	62
Premium Whiteboard In-Fill	66
Accessories	69

Senti Series

► Specifying, page 16

Screen print patterns

are available to assist in writing on the boards. Custom screen printing is also available.

► Page 11

Panel-mount brackets

are optional and allow certain size boards to mount directly to Answer, Kick, Series 9000, and Privacy Wall. A magnetic mount option is available for use on painted steel surfaces only. Magnetic mount option will not work on fabric or vinyl-covered surfaces.

► Page 10

Senti is lighter in scale than other Premium whiteboards, tackboards, or Contractor series products.

Writing surface is high-performance e³ ceramicsteel.

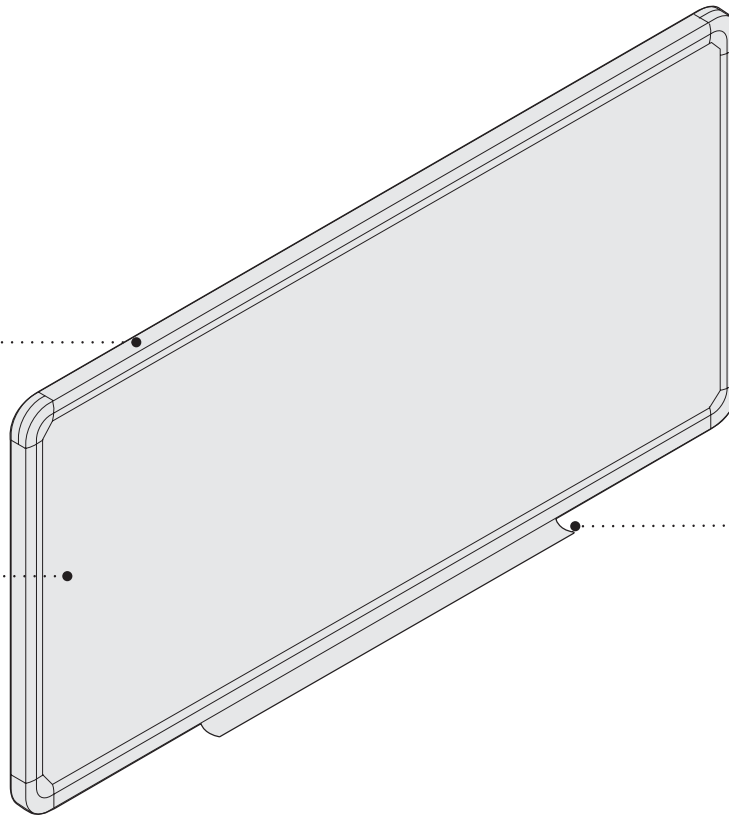

Marker tray is clear anodized aluminum and matches the aluminum frame.

Actual Dimensions

	CSTM0218	CSTM032	CSTM043	CSTM044
Overall Width	24" or 610 mm	36" or 914 mm	48" or 1219 mm	48" or 1219 mm
Surface Width	22 ¹ / ₈ " or 563 mm	34 ¹ / ₈ " or 868 mm	46 ¹ / ₈ " or 1172 mm	46 ¹ / ₈ " or 1172 mm
Marker Tray Width	21 ⁵ / ₈ " or 551 mm	33 ⁵ / ₈ " or 856 mm	45 ⁵ / ₈ " or 1160 mm	45 ⁵ / ₈ " or 1160 mm
Overall Height	18" or 457 mm	24" or 610 mm	36" or 914 mm	48" or 1219 mm
Surface Height	16 ¹ / ₈ " or 410 mm	22 ¹ / ₈ " or 563 mm	34 ¹ / ₈ " or 868 mm	46 ¹ / ₈ " or 1172 mm
Frame Depth	1/2" or 13 mm	1/2" or 13 mm	1/2" or 13 mm	1/2" or 13 mm
Depth from Wall to Frame Face	9/16" or 14 mm	9/16" or 14 mm	9/16" or 14 mm	9/16" or 14 mm
Marker Tray Depth	1 ³ / ₈ " or 35 mm	1 ³ / ₈ " or 35 mm	1 ³ / ₈ " or 35 mm	1 ³ / ₈ " or 35 mm
Weight (lbs)	6 ³ / ₈ lb	12 ³ / ₄ lb	25 ¹ / ₂ lb	34 lb
Weight (kgs)	2.9 kg	5.8 kg	11.6 kg	15.4 kg

Trim is clear anodized aluminum.

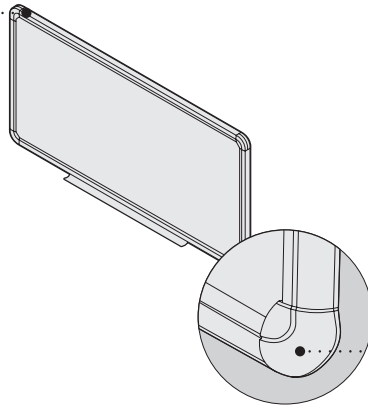

Four-corner mounting system includes integral covers.

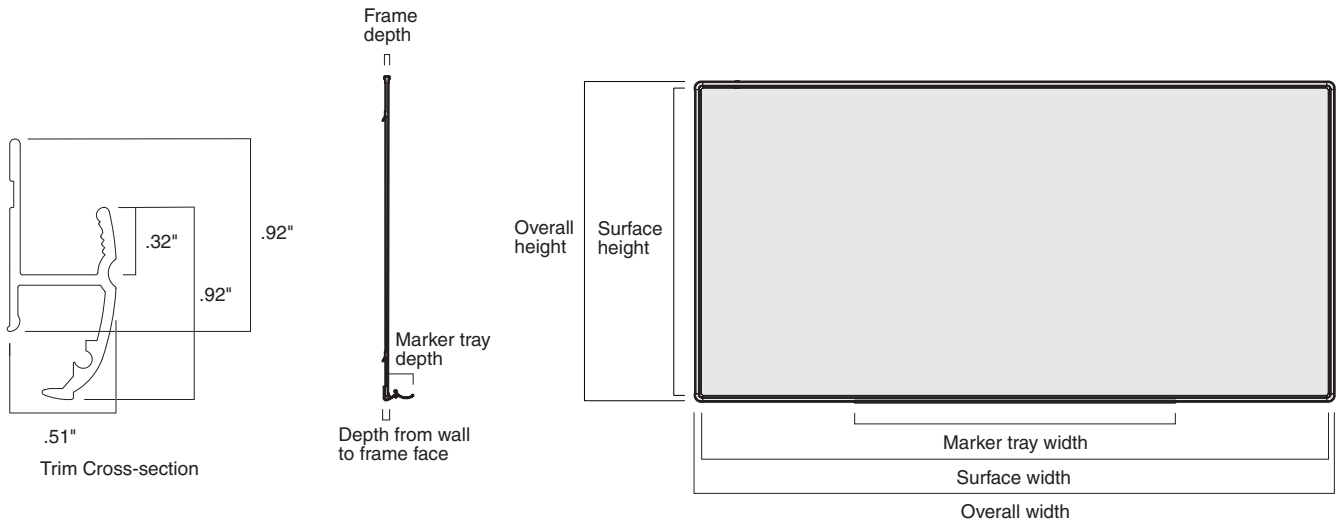

CSTM054

CSTM064

60" or 1524 mm

72" or 1829 mm

56 1/8" or 1427 mm

70 1/8" or 1781 mm

57 5/8" or 1465 mm

57 5/8" or 1465 mm

48" or 1219 mm

48" or 1219 mm

46 1/8" or 1172 mm

46 1/8" or 1172 mm

1/2" or 13 mm

1/2" or 13 mm

9/16" or 14 mm

9/16" or 14 mm

1 3/8" or 35 mm

1 3/8" or 35 mm

42 1/2 lb

51 lb

19.3 kg

23.1 kg

Senti Series

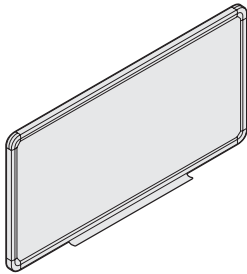

Tip: Screen print option is not available on 24"W x 18"H screens. Specify 7656 Circular Dot or 7657 2" Grid for pattern.

Tip: Magnetic-mount brackets are not available on 60"W x 48"H or 72"W x 48"H screens.

Standard Includes	Required to Specify
<ul style="list-style-type: none"> ▶ Need help? Product details, page 14 e³ environmental ceramicsteel writing surface: 7655 High Gloss White Frame: 8043 Clear Anodized Aluminum Matching aluminum marker tray Four-corner mounting system with integral covers Package of four dry-erase markers (black, blue, red, and green) and one eraser Shipped ready to assemble 	<ul style="list-style-type: none"> 1 Style number 2 Options, if selected (see below)

Options	U.S. Price	Required to Specify
Surface Materials Screen print in 7656 Circular Dot or 7657 Grid pattern <ul style="list-style-type: none"> • 36"W x 24"H • 48"W x 36"H • 48"W x 48"H • 60"W x 48"H • 72"W x 48"H 	<ul style="list-style-type: none"> +\$ 73 +\$170 +\$222 +\$279 +\$337 	<ul style="list-style-type: none"> Specify <i>with screen print</i> and select pattern number. Specify <i>with screen print</i> and select pattern number. Specify <i>with screen print</i> and select pattern number. Specify <i>with screen print</i> and select pattern number. Specify <i>with screen print</i> and select pattern number.
On- and Off-Module Brackets <ul style="list-style-type: none"> • Available on 24"W x 18"H to 60"W x 48"H markerboards 	<ul style="list-style-type: none"> +\$ 73 	<ul style="list-style-type: none"> Specify <i>with panel-mount brackets</i>.
Magnetic-Mount Brackets <ul style="list-style-type: none"> • Available on 24"W x 18"H to 48"W x 48"H markerboards 	<ul style="list-style-type: none"> +\$ 73 	<ul style="list-style-type: none"> Specify <i>with magnetic-mount brackets</i>.

Related Products • Accessories ▶ Page 69

Specification Information				
• Dimensions			• Style	• U.S.
D	W	H	Number	Base Price
1/2"	24"	18"	CSTM0218	\$247
1/2"	36"	24"	CSTM032	\$271
1/2"	48"	36"	CSTM043	\$348
1/2"	48"	48"	CSTM044	\$411
1/2"	60"	48"	CSTM054	\$439
1/2"	72"	48"	CSTM064	\$498
:	:	:	:	:



For Canadian Pricing
 Multiply U.S. Price by the Canadian price factor.
 ▶ See page 1 for details.

Edge Series

► Specifying, page 20

Tackable surface is optional and available in a selection of standard or graded-in fabrics. COM is also available.

► Page 88

Panel-mount brackets are optional and allow certain size boards to mount directly to Answer, Kick, Series 9000, and Privacy Wall.

► Page 10

Edge is available with an easy mount metal cleat-mounting system.

Screen print patterns are available to assist in writing on the boards. Custom screen printing is also available.

► Page 11

Larger boards can be ordered with a spline joint that allows markerboards to ship in two equal pieces.

► Page 9

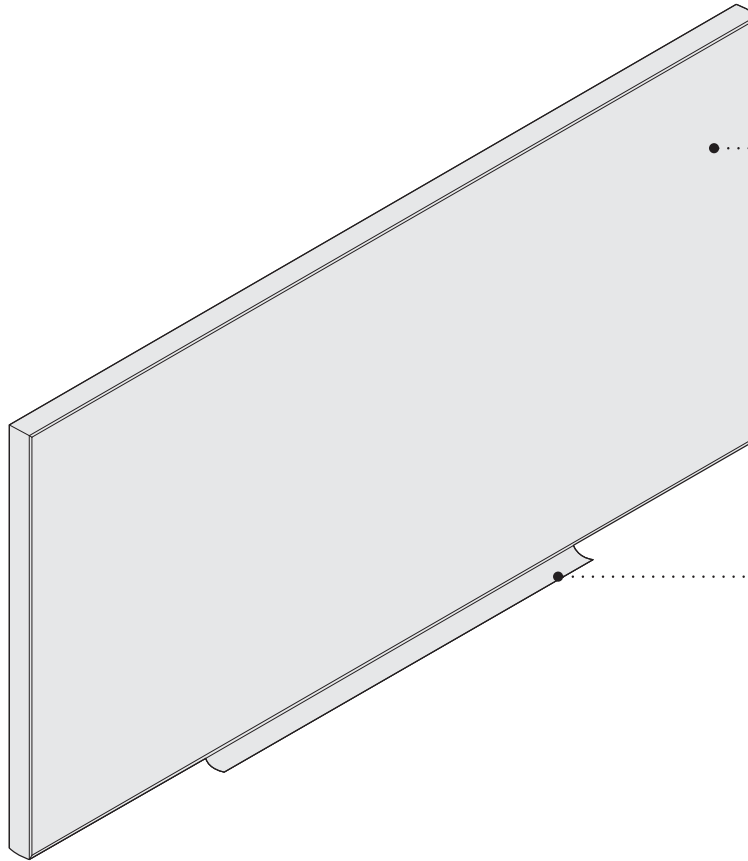

Writing surface is high-performance e³ ceramicsteel.

Marker tray is clear anodized aluminum and matches the aluminum frame.

Actual Dimensions

	CEDM0218	CEDM032	CEDM043 CEDT043	CEDM044 CEDT044	CEDM054 CEDT053
Overall Width	24 ¹ / ₄ " or 616 mm	36 ¹ / ₄ " or 921 mm	48 ¹ / ₄ " or 1226 mm	48 ¹ / ₄ " or 1226 mm	60 ¹ / ₄ " or 1530 mm
Surface Width	23 ³ / ₄ " or 603 mm	35 ³ / ₄ " or 908 mm	47 ³ / ₄ " or 1213 mm	47 ³ / ₄ " or 1213 mm	59 ³ / ₄ " or 1518 mm
Marker Tray Width	18" or 457 mm	24" or 610 mm	36" or 914 mm	36" or 914 mm	48" or 1219 mm
Overall Height	18 ¹ / ₄ " or 464 mm	24 ¹ / ₄ " or 616 mm	36 ¹ / ₄ " or 921 mm	48 ¹ / ₄ " or 1226 mm	48 ¹ / ₄ " or 1226 mm
Surface Height	17 ⁷ / ₈ " or 454 mm	23 ⁷ / ₈ " or 606 mm	35 ⁷ / ₈ " or 911 mm	47 ⁷ / ₈ " or 1216 mm	47 ⁷ / ₈ " or 1216 mm
Frame Depth	3/4" or 19 mm	3/4" or 19 mm	3/4" or 19 mm	3/4" or 19 mm	3/4" or 19 mm
Depth from Wall to Frame Face	1 ¹ / ₈ " or 29 mm	1 ¹ / ₈ " or 29 mm	1 ¹ / ₈ " or 29 mm	1 ¹ / ₈ " or 29 mm	1 ¹ / ₈ " or 29 mm
Marker Tray Depth	3 ¹ / ₂ " or 89 mm	3 ¹ / ₂ " or 89 mm	3 ¹ / ₂ " or 89 mm	3 ¹ / ₂ " or 89 mm	3 ¹ / ₂ " or 89 mm
Weight (MB/TB) lbs	9 lb	18 lb	35 ⁷ / ₈ - 26 ³ / ₈ lb	47 ¹ / ₂ - 35 lb	59 ¹ / ₂ - 43 ⁷ / ₈ lb
Weight (kgs)	4.1 kg	8.2 kg	16.2 - 12 kg	27 - 19.9 kg	32.4 - 23.8 kg

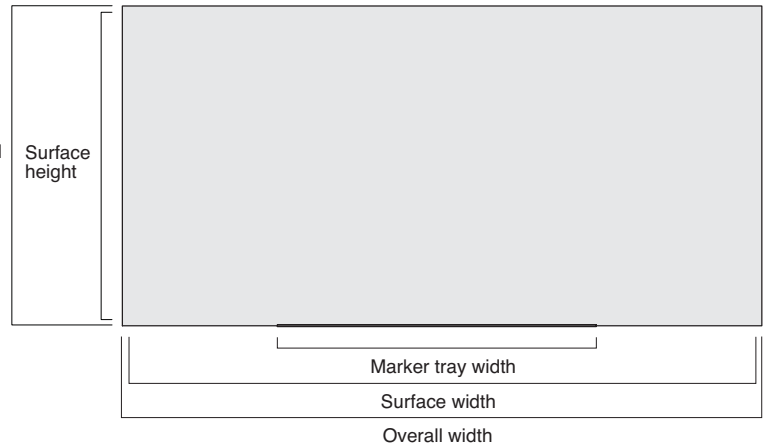
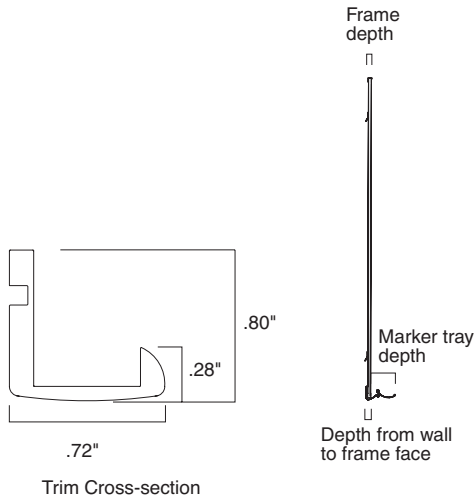
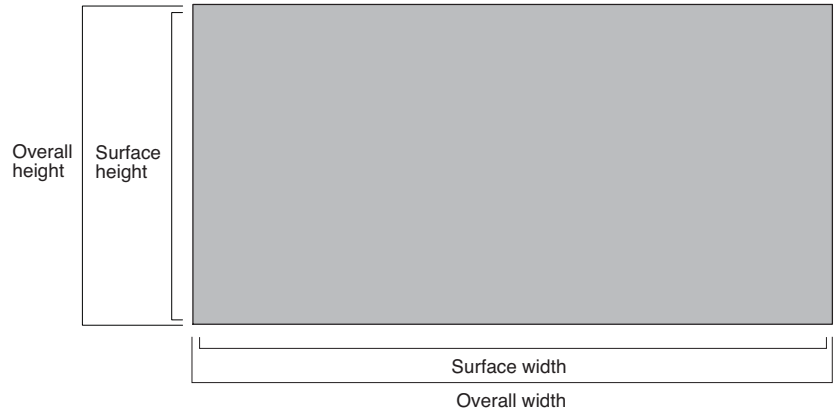
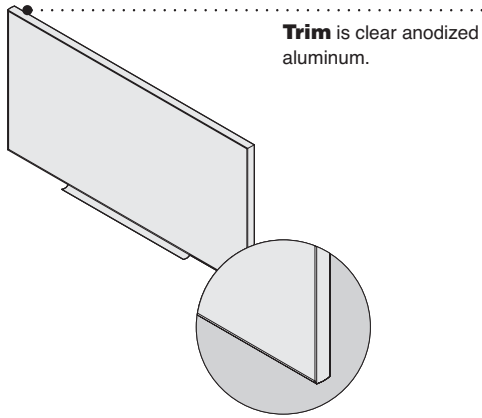

CEDM064 CEDT064	CEDM084 CEDT084	CEDM104 CEDT104	CEDM124	CEDM164
72 ¹ / ₄ " or 1835 mm	96 ¹ / ₄ " or 2445 mm	120 ¹ / ₄ " or 3054 mm	144 ¹ / ₄ " or 3664 mm	192 ¹ / ₄ " or 4883 mm
71 ³ / ₄ " or 1822 mm	95 ³ / ₄ " or 2432 mm	119 ³ / ₄ " or 3042 mm	143 ³ / ₄ " or 3651 mm	191 ³ / ₄ " or 4870 mm
48" or 1219 mm	48" or 1219 mm	60" or 1524 mm	72" or 1829 mm	96" or 2438 mm
48 ³ / ₄ " or 1238 mm	48 ³ / ₄ " or 1238 mm	48 ³ / ₄ " or 1238 mm	48 ³ / ₄ " or 1238 mm	48 ³ / ₄ " or 1238 mm
47 ⁷ / ₈ " or 1216 mm	47 ⁷ / ₈ " or 1216 mm	47 ⁷ / ₈ " or 1216 mm	47 ⁷ / ₈ " or 1216 mm	47 ⁷ / ₈ " or 1216 mm
3/4" or 19 mm	3/4" or 19 mm	3/4" or 19 mm	3/4" or 19 mm	3/4" or 19 mm
1 ¹ / ₈ " or 29 mm	1 ¹ / ₈ " or 29 mm	1 ¹ / ₈ " or 29 mm	1 ¹ / ₈ " or 29 mm	1 ¹ / ₈ " or 29 mm
3 ¹ / ₂ " or 89 mm	3 ¹ / ₂ " or 89 mm	3 ¹ / ₂ " or 89 mm	3 ¹ / ₂ " or 89 mm	3 ¹ / ₂ " or 89 mm
71 ¹ / ₃ - 52 ¹ / ₂ lb	95 - 70 lb	118 ³ / ₄ - 87 ³ / ₈ lb	142 ³ / ₈ lb	189 ⁷ / ₈ lb
32.4 - 23.8 kg	43.1 - 31.7 kg	53.8 - 39.6 kg	64.6 kg	86.1 kg

Edge Series

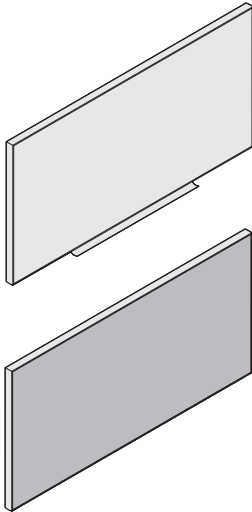

▶ Need help? Product details, page 18

Standard Includes

- e³ environmental ceramicsteel writing surface: 7655 High Gloss White
- Fabric over 3/8" fiberboard on tackboards, if selected
- Frame: 8043 Clear Anodized Aluminum
- Matching aluminum marker tray on markerboard
- Metal cleat mounting system
- Package of four dry-erase markers (black, blue, red, and green) and one eraser (markerboard only)
- Shipped ready to assemble

Required to Specify

- 1 Style number
 - 2 Fabric color number for tackboard, if selected
 - 3 Options, if selected (see below)
- ▶ See *Surface Materials*, page 87

Tip: Screen print option is not available on 24"W x 18"H or 144"W x 48"H to 192"W x 48"H screens. Specify 7656 Circular Dot or 7657 2" Grid for pattern.

Options	U.S. Price	Required to Specify
Surface Materials		
Screen print in 7656 Circular Dot or 7657 Grid pattern		
• 36"W x 24"H	+\$ 75	Specify <i>with screen print</i> and select pattern number.
• 48"W x 36"H	+\$170	Specify <i>with screen print</i> and select pattern number.
• 48"W x 48"H	+\$222	Specify <i>with screen print</i> and select pattern number.
• 60"W x 48"H	+\$279	Specify <i>with screen print</i> and select pattern number.
• 72"W x 48"H	+\$337	Specify <i>with screen print</i> and select pattern number.
• 96"W x 48"H	+\$449	Specify <i>with screen print</i> and select pattern number.
• 120"W x 48"H	+\$557	Specify <i>with screen print</i> and select pattern number.

Fabric surface on tackboards

- Fabric price group 1 No cost
- Fabric price group 2
 - 48"W x 36"H to 48"W x 48"H +\$ 38
 - 60"W x 48"H +\$ 45
 - 72"W x 48"H +\$ 50
 - 96"W x 48"H +\$ 52
 - 120"W x 48"H +\$ 57
- Fabric price group 3
 - 48"W x 36"H to 48"W x 48"H +\$ 47
 - 60"W x 48"H +\$ 57
 - 72"W x 48"H +\$ 67
 - 96"W x 48"H +\$ 69
 - 120"W x 48"H +\$ 80
- Fabric price group 4
 - 48"W x 36"H to 48"W x 48"H +\$ 68
 - 60"W x 48"H +\$ 86
 - 72"W x 48"H +\$104
 - 96"W x 48"H +\$113
 - 120"W x 48"H +\$136
- Fabric price group COM +\$ 16

Specify fabric color number.

Specify fabric color number.
Specify fabric color number.
Specify fabric color number.
Specify fabric color number.
Specify fabric color number.

Specify fabric color number.
Specify fabric color number.
Specify fabric color number.
Specify fabric color number.
Specify fabric color number.

Specify fabric color number.
Specify fabric color number.
Specify fabric color number.
Specify fabric color number.
Specify fabric color number.

▶ See *Understanding Customer's Own Material (COM)*, page 88.

▶ Options, continued on next page



For Canadian Pricing

Multiply U.S. Price by the Canadian price factor.

▶ See page 1 for details.

► Options, continued from previous page

	Options	U.S. Price	Required to Specify	
Surface Materials	Frame			
	• 24"W x 18"H	+\$ 48	Specify with 4750 Champagne metallic trim.	
	• 36"W x 24"H	+\$ 68	Specify with 4750 Champagne metallic trim.	
	• 48"W x 36"H	+\$ 96	Specify with 4750 Champagne metallic trim.	
	• 48"W x 48"H	+\$109	Specify with 4750 Champagne metallic trim.	
	• 60"W x 48"H	+\$120	Specify with 4750 Champagne metallic trim.	
	• 72"W x 48"H	+\$135	Specify with 4750 Champagne metallic trim.	
	• 96"W x 48"H	+\$164	Specify with 4750 Champagne metallic trim.	
	• 120"W x 48"H	+\$189	Specify with 4750 Champagne metallic trim.	
	• 144"W x 48"H	+\$219	Specify with 4750 Champagne metallic trim.	
	• 192"W x 48"H	+\$269	Specify with 4750 Champagne metallic trim.	
Panel-Mount Brackets	• Available on 24"W x 18"H to 60"W x 48"H markerboards	+\$ 73	Specify with panel-mount brackets.	
	On- and Off-Module Brackets	• Available on 24"W x 18"H to 192"W x 48"H markerboards	+\$108	Specify with on- and off-module brackets.
		Spline Joint	• Available on 120"W x 48"H to 192"W x 48"H markerboards	+\$216
Related Products	• Accessories		► Page 69	

Tip: Panel-mount brackets are not available on 74"x48" to 192"W x 48"H screens.

► Specification Information, on next page

 **For Canadian Pricing**
 Multiply U.S. Price by the Canadian price factor.
 ► See page 1 for details.

Edge Series, continued

► Options, on previous page

Specification Information

• Dimensions			• Style Number	• U.S. Base Price
D	W	H		

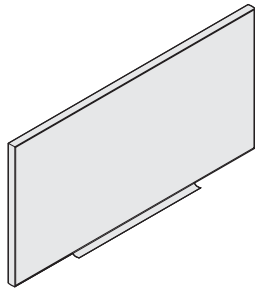

Markerboards

3/4"	24"	18"	CEDM0218	\$ 336
3/4"	36"	24"	CEDM032	\$ 364
3/4"	48"	36"	CEDM043	\$ 471
3/4"	48"	48"	CEDM044	\$ 496
3/4"	60"	48"	CEDM054	\$ 576
3/4"	72"	48"	CEDM064	\$ 640
3/4"	96"	48"	CEDM084	\$ 776
3/4"	120"	48"	CEDM104	\$ 925
3/4"	144"	48"	CEDM124	\$1079
3/4"	192"	48"	CEDM164	\$1290

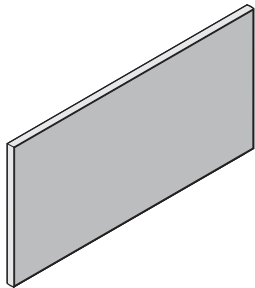

Tackboards

3/4"	48"	36"	CEDT043	\$ 471
3/4"	48"	48"	CEDT044	\$ 496
3/4"	60"	48"	CEDT054	\$ 576
3/4"	72"	48"	CEDT064	\$ 640
3/4"	96"	48"	CEDT084	\$ 776
3/4"	120"	48"	CEDT104	\$ 925



For Canadian Pricing

Multiply U.S. Price by the Canadian price factor.

► See page 1 for details.

Access Series

► Specifying, page 20

Tackable surface is optional and available in a selection of standard or graded-in fabrics. COM is also available.

► Page 88

Screen print patterns are available to assist in writing on the boards. Custom screen printing is also available.

► Page 11

On- and/or off-module mounting brackets are optional and are available to mount directly to Answer, Kick, Series 9000, Avenir, and Privacy Wall.

► Page 9

Larger boards can be ordered with a spline joint that allows markerboards to ship in two equal pieces.

► Page 9

Access is available with an easy-mount metal cleat-mounting system.

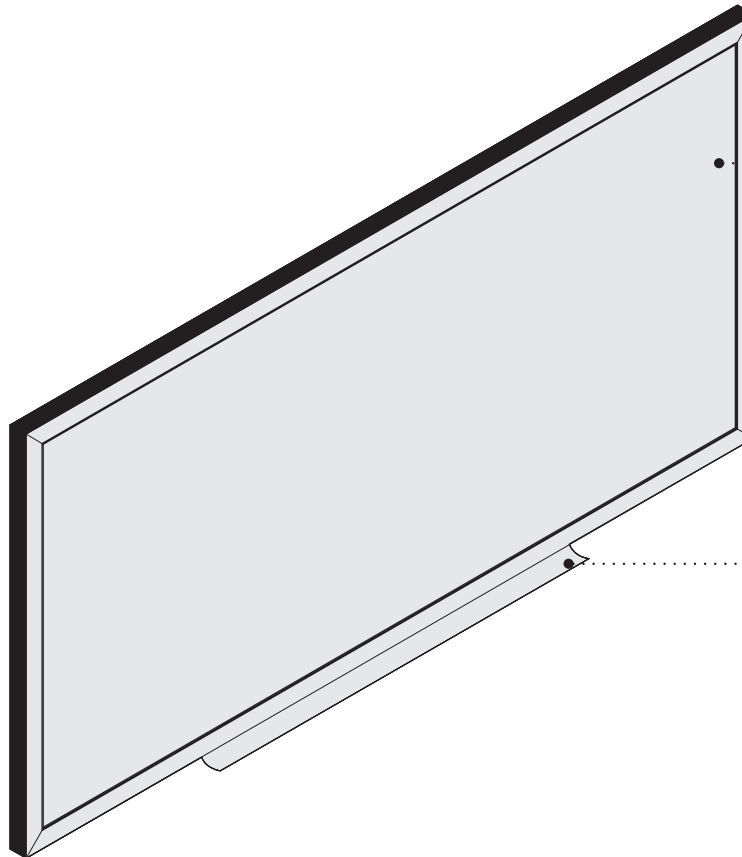

Writing surface is high-performance e³ ceramicsteel.

Clear anodized aluminum marker tray matches insert.

Actual Dimensions

	CACM032	CACM043	CACM044 CACT043	CACM054 CACT044	CACM064 CACT053
Overall Width	36" or 914 mm	48" or 1219 mm	48" or 1219 mm	60" or 1524 mm	72" or 1829 mm
Surface Width	34" or 864 mm	46" or 1168 mm	46" or 1168 mm	58" or 1473 mm	70" or 1778 mm
Marker Tray Width	24" or 610 mm	36" or 914 mm	36" or 914 mm	48" or 1219 mm	48" or 1219 mm
Overall Height	24" or 610 mm	36" or 914 mm	48" or 1219 mm	48" or 1219 mm	48" or 1219 mm
Surface Height	22" or 559 mm	34" or 864 mm	46" or 1168 mm	46" or 1168 mm	46" or 1168 mm
Frame Depth	1" or 25 mm	1" or 25 mm	1" or 25 mm	1" or 25 mm	1" or 25 mm
Depth from Wall to Frame Face	2 1/8" or 54 mm	2 1/8" or 54 mm	2 1/8" or 54 mm	2 1/8" or 54 mm	2 1/8" or 54 mm
Marker Tray Depth	3 1/8" or 85 mm	3 1/8" or 85 mm	3 1/8" or 85 mm	3 1/8" or 85 mm	3 1/8" or 85 mm
Weight (MB/TB) lbs	17 3/4 lb	35 3/8 - 27 3/8 lb	47 - 36 5/8 lb	59 - 45 3/8 lb	70 3/4 - 54 3/8 lb
Weight (MB/TB) kgs	8.0 kg	16.0 - 12.4 kg	21.4 - 16.5 kg	26.7 - 20.6 kg	32.1 - 24.7 kg

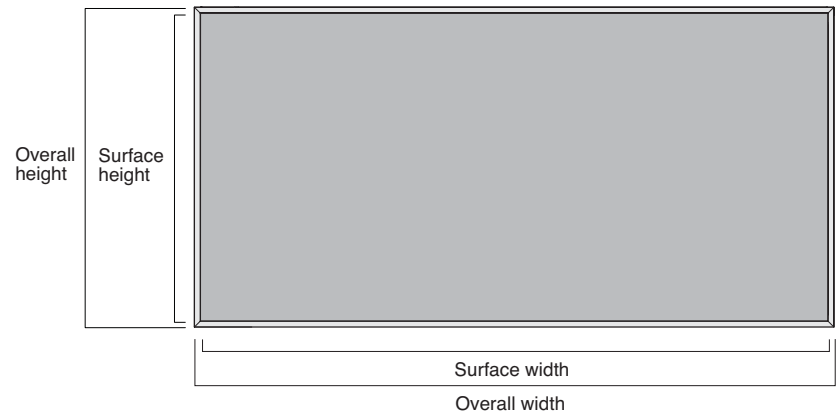
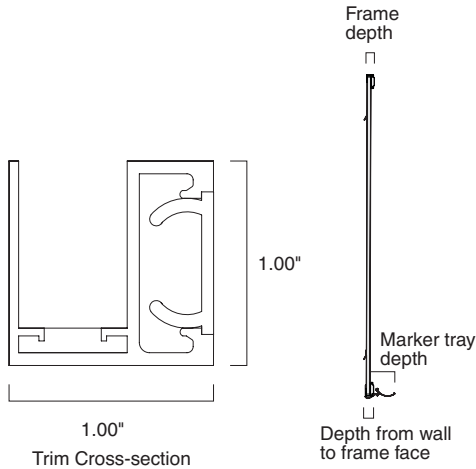
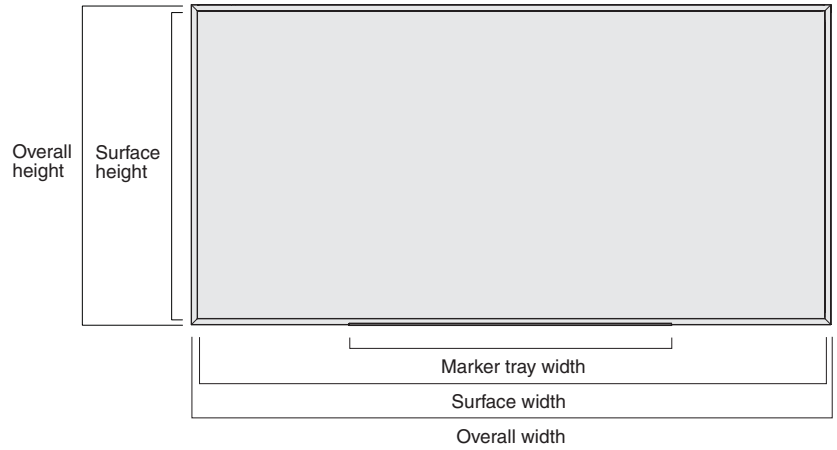
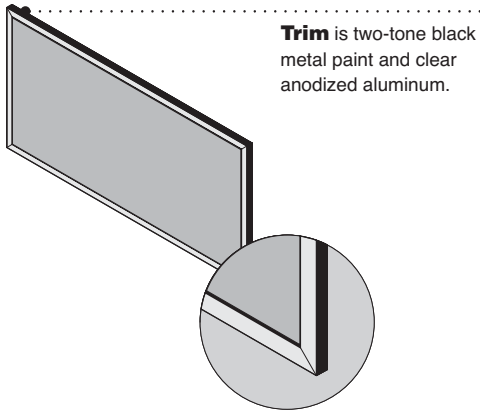

CACM084 CACT064	CACM104 CACT084	CACM124 CACT104	CACM164
96" or 2438 mm	120" or 3048 mm	144" or 3658 mm	192" or 4877 mm
94" or 2388 mm	118" or 2997 mm	142" or 3607 mm	190" or 4826 mm
48" or 1219 mm	60" or 1524 mm	72" or 1829 mm	96" or 2438 mm
48" or 1219 mm	48" or 1219 mm	48" or 1219 mm	48" or 1219 mm
46" or 1168 mm	46" or 1168 mm	46" or 1168 mm	46" or 1168 mm
1" or 25 mm	1" or 25 mm	1" or 25 mm	1" or 25 mm
2 1/8" or 54 mm	2 1/8" or 54 mm	2 1/8" or 54 mm	2 1/8" or 54 mm
3 1/3" or 85 mm	3 1/3" or 85 mm	3 1/3" or 85 mm	3 1/3" or 85 mm
94 3/8 - 72 5/8 lb	117 3/4 - 90 3/4 lb	141 3/8 lb	188 1/2 lb
42.8 - 33.0 kg	53.5 - 41.2 kg	64.1 kg	85.5 kg

Access Series

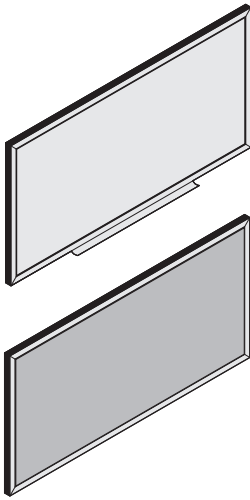

Tip: Screen print option is not available on 24"W x 18"H or 144"W x 48"H to 192"W x 48"H screens. Specify 7656 Circular Dot or 7657 2" Grid for pattern.

Standard Includes	Required to Specify
-------------------	---------------------

<p>► Need help? Product details, page 24</p> <ul style="list-style-type: none"> • e³ environmental ceramicsteel writing surface: 7655 High Gloss White • Fabric over 3/8" fiberboard on tackboards, if selected • Black powder-coated aluminum frame, with contrasting aluminum insert • Clear anodized aluminum marker tray on markerboard • Metal cleat mounting system • Package of four dry-erase markers (black, blue, red, and green) and one eraser for markerboard, if selected 	<ol style="list-style-type: none"> 1 Style number 2 Fabric color number for tackboard, if selected 3 Options, if selected (see below) <p>► See <i>Surface Materials</i>, page 87</p>
--	---

Surface Materials	Options	U.S. Price	Required to Specify
-------------------	---------	------------	---------------------

Surface Materials	Screen print in 7656 Circular Dot or 7657 Grid pattern		
	• 36"W x 24"H	+\$ 75	Specify <i>with screen print</i> and select pattern number.
	• 48"W x 36"H	+\$170	Specify <i>with screen print</i> and select pattern number.
	• 48"W x 48"H	+\$222	Specify <i>with screen print</i> and select pattern number.
	• 60"W x 48"H	+\$279	Specify <i>with screen print</i> and select pattern number.
	• 72"W x 48"H	+\$337	Specify <i>with screen print</i> and select pattern number.
	• 96"W x 48"H	+\$449	Specify <i>with screen print</i> and select pattern number.
	• 120"W x 48"H	+\$557	Specify <i>with screen print</i> and select pattern number.

Fabric surface on tackboards

• Fabric price group 1	No cost	Specify fabric color number.
• Fabric price group 2		
- 48"W x 36"H to 48"W x 48"H	+\$ 38	Specify fabric color number.
- 60"W x 48"H	+\$ 45	Specify fabric color number.
- 72"W x 48"H	+\$ 50	Specify fabric color number.
- 96"W x 48"H	+\$ 52	Specify fabric color number.
- 120"W x 48"H	+\$ 58	Specify fabric color number.
• Fabric price group 3		
- 48"W x 36"H to 48"W x 48"H	+\$ 47	Specify fabric color number.
- 60"W x 48"H	+\$ 57	Specify fabric color number.
- 72"W x 48"H	+\$ 67	Specify fabric color number.
- 96"W x 48"H	+\$ 69	Specify fabric color number.
- 120"W x 48"H	+\$ 80	Specify fabric color number.
• Fabric price group 4		
- 48"W x 36"H to 48"W x 48"H	+\$ 68	Specify fabric color number.
- 60"W x 48"H	+\$ 86	Specify fabric color number.
- 72"W x 48"H	+\$104	Specify fabric color number.
- 96"W x 48"H	+\$113	Specify fabric color number.
- 120"W x 48"H	+\$136	Specify fabric color number.
• Fabric price group COM	+\$ 16	► See <i>Understanding Customer's Own Material (COM)</i> , page 88.

► Options, continued on next page



For Canadian Pricing

Multiply U.S. Price by the Canadian price factor.

► See page 1 for details.

► Options, continued from previous page

Options		U.S. Price	Required to Specify
Surface Materials	Frame		
	• 36"W x 24"H	+\$ 68	Specify with 4750 Champagne metallic trim.
	• 48"W x 36"H	+\$ 96	Specify with 4750 Champagne metallic trim.
	• 48"W x 48"H	+\$107	Specify with 4750 Champagne metallic trim.
	• 60"W x 48"H	+\$120	Specify with 4750 Champagne metallic trim.
	• 72"W x 48"H	+\$135	Specify with 4750 Champagne metallic trim.
	• 96"W x 48"H	+\$164	Specify with 4750 Champagne metallic trim.
	• 120"W x 48"H	+\$189	Specify with 4750 Champagne metallic trim.
	• 144"W x 48"H	+\$219	Specify with 4750 Champagne metallic trim.
• 192"W x 48"H	+\$269	Specify with 4750 Champagne metallic trim.	
On- and Off-Module Brackets	• Available on 36"W x 24"H to 192"W x 48"H markerboards	+\$108	Specify with on- and off-module brackets.
Spline Joint	• Available on 120"W x 48"H to 192"W x 48"H markerboards	+\$216	Specify with XSPL spline joint.
Related Products	• Accessories		► Page 69

Whiteboards and Tackboards

Specification Information

Dimensions			Style	U.S.
D	W	H	Number	Base Price

Markerboards

1"	36"	24"	CACM032	\$ 460
1"	48"	36"	CACM043	\$ 530
1"	48"	48"	CACM044	\$ 596
1"	60"	48"	CACM054	\$ 706
1"	72"	48"	CACM064	\$ 789
1"	96"	48"	CACM084	\$ 936
1"	120"	48"	CACM104	\$1144
1"	144"	48"	CACM124	\$1256
1"	192"	48"	CACM164	\$1556

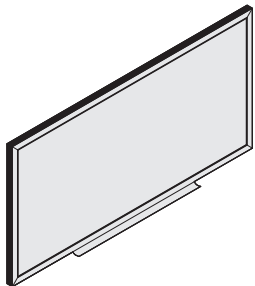

Tackboards

1"	48"	36"	CACT043	\$ 530
1"	48"	48"	CACT044	\$ 596
1"	60"	48"	CACT054	\$ 706
1"	72"	48"	CACT064	\$ 789
1"	96"	48"	CACT084	\$ 936
1"	120"	48"	CACT104	\$1144

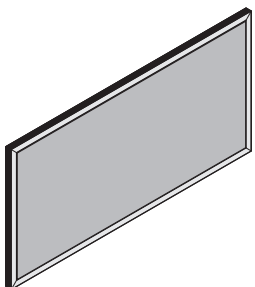

Denska Series

► Specifying, page 30

Screen print patterns

are available to assist in writing on the boards. Custom screen printing is also available.

► Page 11

On- and/or off-module mounting brackets

are optional and are available to mount directly to Answer, Kick, Series 9000, Avenir, and Privacy Wall.

► Page 9

Larger boards can be ordered with a spline joint that allows markerboards to ship in two equal pieces.

► Page 9

Access is available with an easy-mount metal cleat-mounting system.

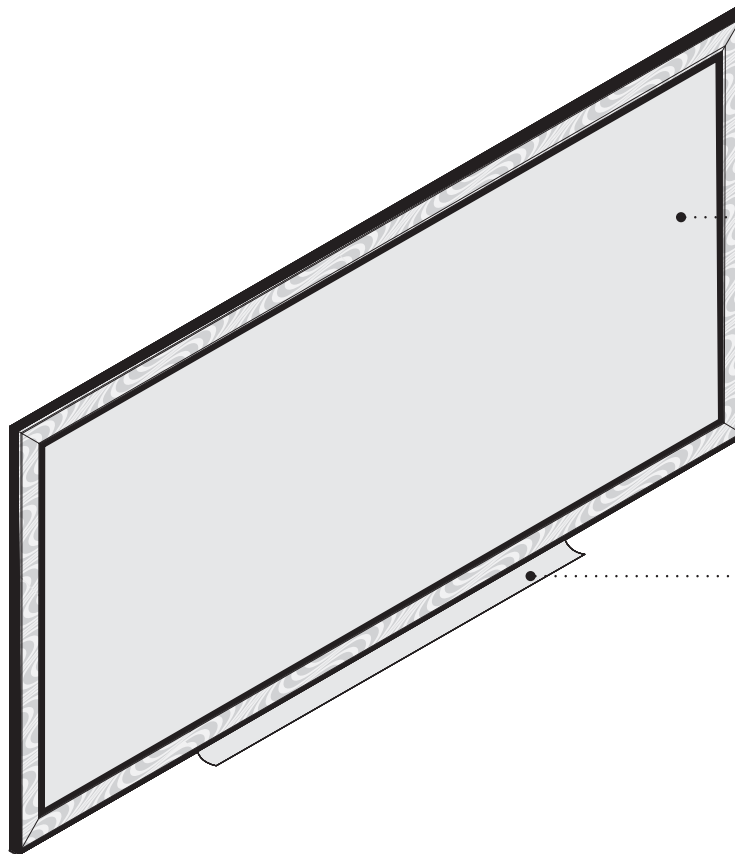

Solid wood trim inserts are offered in Cherry, Maple, or Walnut in a selection of stains. Custom stain program is available.

► Page 88

Writing surface is high-performance e³ ceramicsteel.

Black metal paint marker tray matches frame.

Actual Dimensions

	CDEM032	CDEM043	CDEM044	CDEM054	CDEM064
Overall Width	36 ¹ / ₄ " or 921 mm	48 ¹ / ₄ " or 1226 mm	48 ¹ / ₄ " or 1226 mm	60 ¹ / ₄ " or 1530 mm	72 ¹ / ₄ " or 1835 mm
Surface Width	32 ¹ / ₃ " or 821 mm	44 ¹ / ₃ " or 1126 mm	44 ¹ / ₃ " or 1126 mm	53 ¹ / ₃ " or 1355 mm	68 ¹ / ₃ " or 1736 mm
Marker Tray Width	24" or 610 mm	36" or 914 mm	36" or 914 mm	48" or 1220 mm	48" or 1220 mm
Overall Height	24 ¹ / ₄ " or 616 mm	36 ¹ / ₄ " or 921 mm	48 ¹ / ₄ " or 1226 mm	48 ¹ / ₄ " or 1226 mm	48 ¹ / ₄ " or 1226 mm
Surface Height	20 ¹ / ₄ " or 514 mm	32 ¹ / ₄ " or 818 mm	44 ¹ / ₄ " or 1123 mm	44 ¹ / ₄ " or 1123 mm	44 ¹ / ₄ " or 1123 mm
Frame Depth	1 ¹ / ₂ " or 38 mm	1 ¹ / ₂ " or 38 mm	1 ¹ / ₂ " or 38 mm	1 ¹ / ₂ " or 38 mm	1 ¹ / ₂ " or 38 mm
Depth from Wall to Frame Face	1 ¹ / ₂ " or 38 mm	1 ¹ / ₂ " or 38 mm	1 ¹ / ₂ " or 38 mm	1 ¹ / ₂ " or 38 mm	1 ¹ / ₂ " or 38 mm
Marker Tray Depth	3" or 76 mm	3" or 76 mm	3" or 76 mm	3" or 76 mm	3" or 76 mm
Weight (lbs)	19.5 lb	39 lb	52 lb	65 lb	78 lb
Weight (kgs)	8.9 kg	17.7 kg	23.6 kg	29.5 kg	35.4 kg

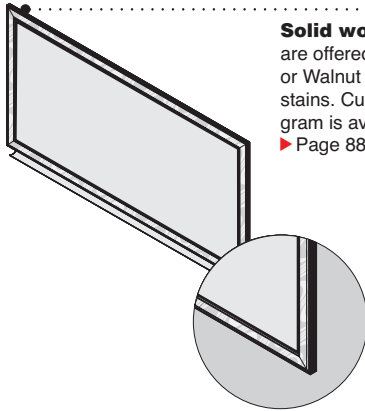

Solid wood trim inserts are offered in Cherry, Maple, or Walnut in a selection of stains. Customiz stain program is available.
 ▶ Page 88

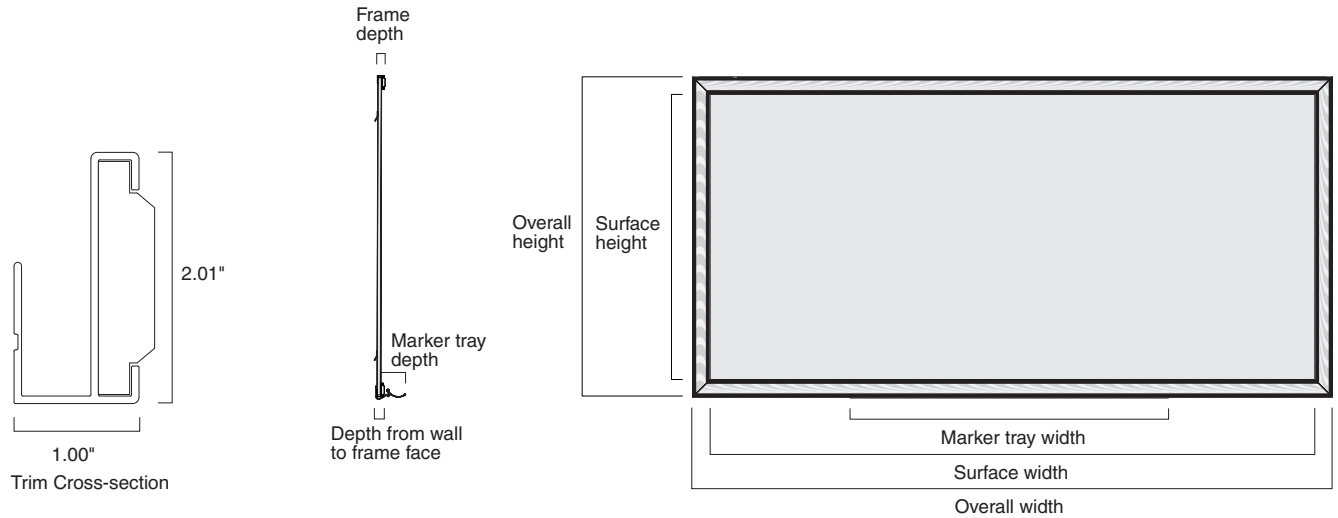

CDEM084	CDEM104	CDEM124	CDEM164
96 ¹ / ₄ " or 2445 mm	120 ¹ / ₄ " or 3054 mm	144 ¹ / ₄ " or 3664 mm	192 ¹ / ₄ " or 4883 mm
92 ¹ / ₃ " or 2345 mm	116 ¹ / ₃ " or 2955 mm	140 ¹ / ₃ " or 3564 mm	188 ¹ / ₃ " or 4784 mm
48" or 1219 mm	60" or 1524 mm	72" or 1829 mm	96" or 2438 mm
48 ³ / ₄ " or 1238 mm	48 ³ / ₄ " or 1238 mm	48 ³ / ₄ " or 1238 mm	48 ³ / ₄ " or 1238 mm
44 ¹ / ₄ " or 1124 mm	44 ¹ / ₄ " or 1124 mm	44 ¹ / ₄ " or 1124 mm	44 ¹ / ₄ " or 1124 mm
1 ¹ / ₂ " or 38 mm	1 ¹ / ₂ " or 38 mm	1 ¹ / ₂ " or 38 mm	1 ¹ / ₂ " or 38 mm
1 ¹ / ₂ " or 38 mm	1 ¹ / ₂ " or 38 mm	1 ¹ / ₂ " or 38 mm	1 ¹ / ₂ " or 38 mm
3" or 76 mm	3" or 76 mm	3" or 76 mm	3" or 76 mm
104 lb	130 lb	156 lb	208 lb
47.2 kg	59.0 kg	70.8 kg	94.4 kg

Denska Series

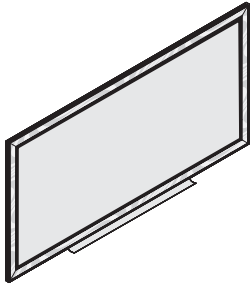

Tip: Screen print option is not available on 24"W x 18"H screens. Specify 7656 Circular Dot or 7657 2" Grid for pattern.

Standard Includes	Required to Specify
<ul style="list-style-type: none"> Need help? Product details, page 28 e³ environmental ceramicsteel writing surface: 7655 High Gloss White Black powder-coated aluminum frame with wood insert Black powder-coated marker tray Metal cleat mounting system Package of four dry-erase markers (black, blue, red, and green) and one eraser Shipped ready to assemble 	<ol style="list-style-type: none"> Style number Wood color number for wood insert Options, if selected (see below)

Options	U.S. Price	Required to Specify
Surface Materials Screen print in 7656 Circular Dot or 7657 Grid pattern <ul style="list-style-type: none"> 36"W x 24"H +\$ 75 48"W x 36"H +\$170 48"W x 48"H +\$222 60"W x 48"H +\$279 72"W x 48"H +\$337 96"W x 48"H +\$449 120"W x 48"H +\$557 		Specify <i>with screen print</i> and select pattern number. Specify <i>with screen print</i> and select pattern number. Specify <i>with screen print</i> and select pattern number. Specify <i>with screen print</i> and select pattern number. Specify <i>with screen print</i> and select pattern number. Specify <i>with screen print</i> and select pattern number. Specify <i>with screen print</i> and select pattern number.
Frame <ul style="list-style-type: none"> Customiz stain +\$ 50 		Specify <i>with Customiz stain</i> .
On- and Off-Module Brackets <ul style="list-style-type: none"> Available on 36"W x 24"H to 192"W x 48"H markerboards +\$108 		Specify <i>with on- and off-module brackets</i> .
Spline Joint <ul style="list-style-type: none"> Available on 120"W x 48"H to 192"W x 48"H markerboards +\$216 		Specify <i>with XSPL spline joint</i> .
Related Products <ul style="list-style-type: none"> Accessories 		▶ Page 69

Specification Information				
Dimensions			Style Number	U.S. Base Price
D	W	H		
1½"	36"	24"	CDEM032	\$ 569
1½"	48"	36"	CDEM043	\$ 721
1½"	48"	48"	CDEM044	\$ 796
1½"	60"	48"	CDEM054	\$ 877
1½"	72"	48"	CDEM064	\$1008
1½"	96"	48"	CDEM084	\$1160
1½"	120"	48"	CDEM104	\$1405
1½"	144"	48"	CDEM124	\$1567
1½"	192"	48"	CDEM164	\$1995



For Canadian Pricing
 Multiply U.S. Price by the Canadian price factor.
 ▶ See page 1 for details.

Session Series

► Specifying, page 34

Tackable surface is optional and available in a selection of standard or graded-in fabrics. COM is also available.

► Page 88

Screen print patterns are available to assist in writing on the boards. Custom screen printing is also available.

► Page 11

On- and/or off-module mounting brackets are optional and are available to mount directly to Answer, Kick, Series 9000, Avenir, and Privacy Wall.

► Page 9

Larger boards can be ordered with a spline joint that allows markerboards to ship in two equal pieces.

► Page 9

Session is available with an easy-mount metal cleat-mounting system.

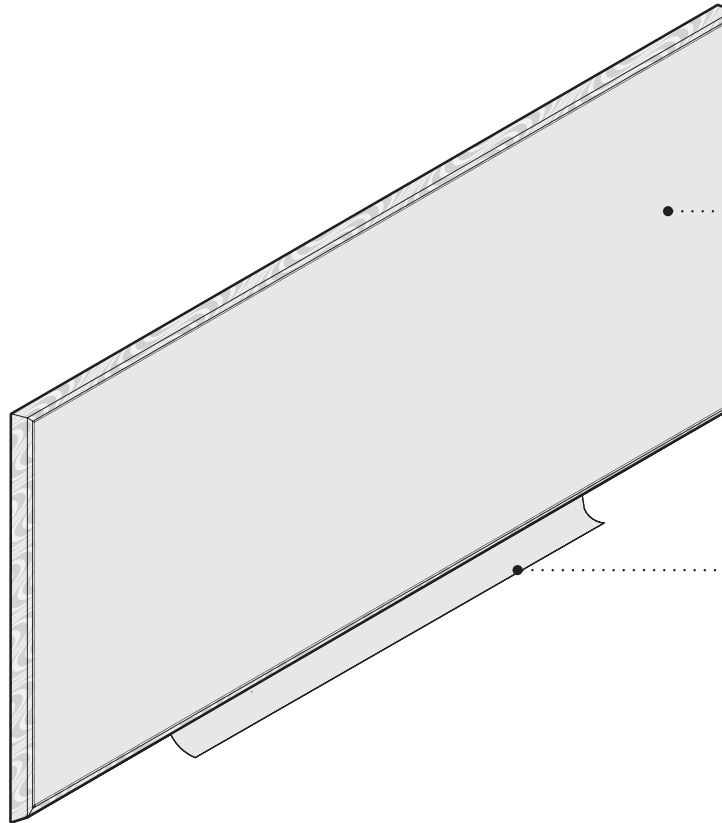

Writing surface is high-performance e³ ceramicsteel.

Marker tray is champagne metal paint aluminum and available on markerboards only.

Actual Dimensions

	CSEM043 CSET043	CSEM044 CSET044	CSEM054 CSET054	CSEM064 CSET064
Overall Width	48" or 1219 mm	48" or 1219 mm	60" or 1524 mm	72" or 1829 mm
Surface Width	45" or 1143 mm	45" or 1143 mm	57" or 1448 mm	69" or 1753 mm
Marker Tray Width	36" or 914 mm	36" or 914 mm	48" or 1219 mm	48" or 1219 mm
Overall Height	36" or 914 mm	48" or 1219 mm	48" or 1219 mm	48" or 1219 mm
Surface Height	33½" or 851 mm	45½" or 1156 mm	45½" or 1156 mm	45½" or 1156 mm
Frame Depth	1¾" or 30 mm	1¾" or 30 mm	1¾" or 30 mm	1¾" or 30 mm
Depth from Wall to Frame Face	1½" or 38 mm	1½" or 38 mm	1½" or 38 mm	1½" or 38 mm
Marker Tray Depth	3¼" or 83 mm	3¼" or 83 mm	3¼" or 83 mm	3¼" or 83 mm
Weight (lbs) MB/TB	34¾ - 25¾ lb	45¾ - 33¾ lb	57 - 42 lb	68¾ - 50¾ lb
Weight (kgs)	15½ - 11.4 kg	20.7 - 15.2 kg	25.9 - 19.1 kg	31.0 - 22.9 kg

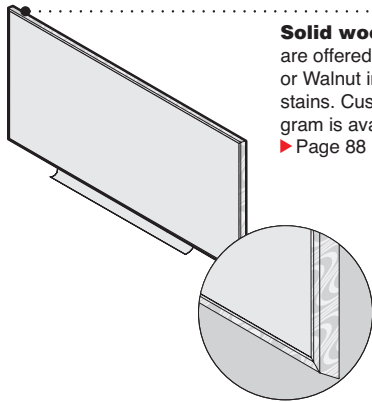

Solid wood trim inserts are offered in Cherry, Maple, or Walnut in a selection of stains. Customiz stain program is available.
 ▶ Page 88

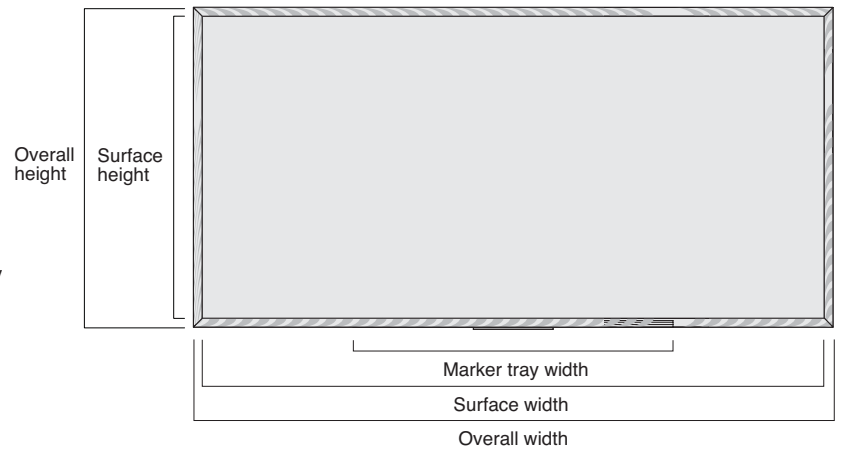
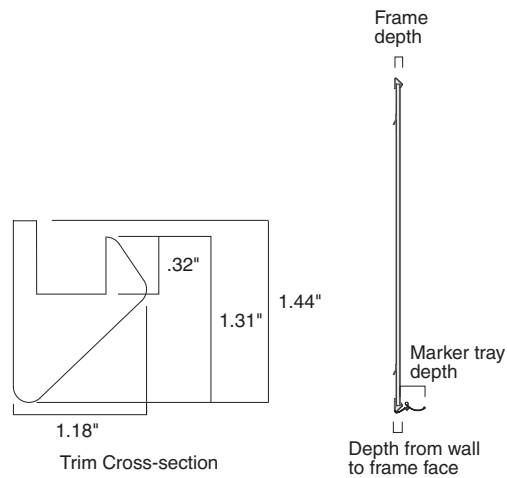
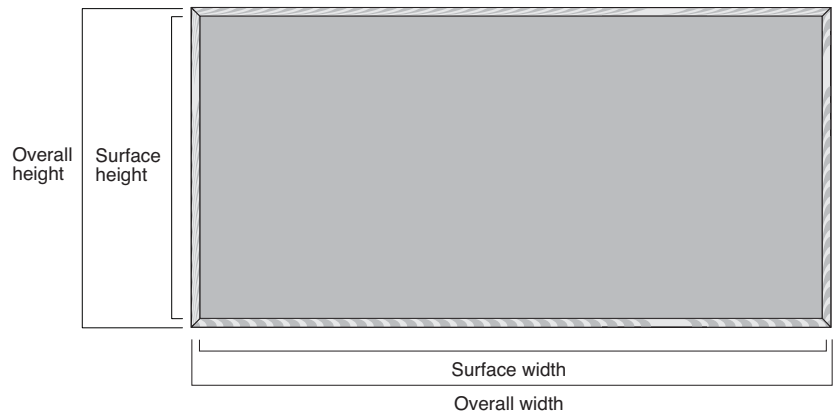

**CSEM084
CSET084**

**CSEM104
CSET104**

96" or 2438 mm

120" or 3048 mm

93" or 2362 mm

117" or 2972 mm

48" or 1219 mm

60" or 1524 mm

48" or 1219 mm

48" or 1219 mm

45½" or 1156 mm

45½" or 1156 mm

1⅜" or 30 mm

1⅜" or 30 mm

1½" or 38 mm

1½" or 38 mm

¾" or 83 mm

¾" or 83 mm

91⅜ - 67⅜ lb

114 - 84 lb

41.4 - 30½ kg

51.7 - 38.1 kg

Session Series

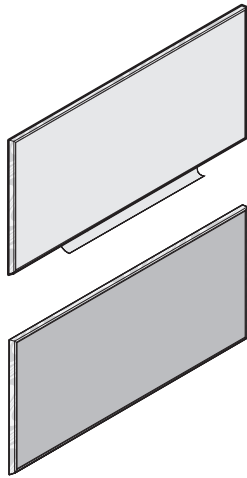

Tip: Screen print option is not available on 24"W x 18"H screens. Specify 7656 Circular Dot or 7657 2" Grid for pattern.

Standard Includes	Required to Specify
<ul style="list-style-type: none"> ▶ Need help? Product details, page 32 • e³ environmental ceramicsteel writing surface: 7655 High Gloss White • Fabric over 3/8" fiberboard on tackboards, if selected • Solid wood frame • Champagne powder-coated marker tray on markerboard • Metal cleat mounting system • Package of four dry-erase markers (black, blue, red, and green) and one eraser for markerboard, if selected • Shipped ready to assemble 	<ul style="list-style-type: none"> 1 Style number 2 Wood color number for frame 3 Options, if selected (see below) ▶ See <i>Surface Materials</i>, page 87

Surface Materials	Options	U.S. Price	Required to Specify
	Screen print in 7656 Circular Dot or 7657 Grid pattern		
	• 48"W x 36"H	+\$170	Specify <i>with screen print</i> and select pattern number.
	• 48"W x 48"H	+\$222	Specify <i>with screen print</i> and select pattern number.
	• 60"W x 48"H	+\$279	Specify <i>with screen print</i> and select pattern number.
	• 72"W x 48"H	+\$337	Specify <i>with screen print</i> and select pattern number.
	• 96"W x 48"H	+\$449	Specify <i>with screen print</i> and select pattern number.
	• 120"W x 48"H	+\$557	Specify <i>with screen print</i> and select pattern number.
	Frame		
	• Customiz stain	+\$ 50	Specify <i>with Customiz stain</i> .
	Fabric surface on tackboards		
	• Fabric price group 1	No cost	Specify fabric color number.
	• Fabric price group 2		
	- 48"W x 36"H to 48"W x 48"H	+\$ 38	Specify fabric color number.
	- 60"W x 48"H	+\$ 45	Specify fabric color number.
	- 72"W x 48"H	+\$ 50	Specify fabric color number.
	- 96"W x 48"H	+\$ 52	Specify fabric color number.
	- 120"W x 48"H	+\$ 58	Specify fabric color number.
	• Fabric price group 3		
	- 48"W x 36"H to 48"W x 48"H	+\$ 47	Specify fabric color number.
	- 60"W x 48"H	+\$ 57	Specify fabric color number.
	- 72"W x 48"H	+\$ 67	Specify fabric color number.
	- 96"W x 48"H	+\$ 69	Specify fabric color number.
	- 120"W x 48"H	+\$ 80	Specify fabric color number.
	• Fabric price group 4		
	- 48"W x 36"H to 48"W x 48"H	+\$ 68	Specify fabric color number.
	- 60"W x 48"H	+\$ 86	Specify fabric color number.
	- 72"W x 48"H	+\$104	Specify fabric color number.
	- 96"W x 48"H	+\$113	Specify fabric color number.
	- 120"W x 48"H	+\$136	Specify fabric color number.
	• Fabric price group COM	+\$ 16	▶ See <i>Understanding Customer's Own Material (COM)</i> , page 88.
On- and Off-Module Brackets	• Available on 48"W x 48"H to 192"W x 48"H markerboards	+\$108	Specify <i>with on- and off-module brackets</i> .
Related Products	• Accessories		▶ Page 69

For Canadian Pricing
 Multiply U.S. Price by the Canadian price factor.
 ▶ See page 1 for details.

Specification Information

Dimensions			Style Number	U.S. Base Price
D	W	H		

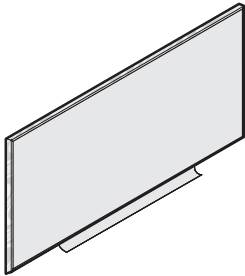

Markerboards

13/16"	48"	36"	CSEM043	\$ 767
13/16"	48"	48"	CSEM044	\$ 865
13/16"	60"	48"	CSEM054	\$ 962
13/16"	72"	48"	CSEM064	\$1079
13/16"	96"	48"	CSEM084	\$1220
13/16"	120"	48"	CSEM104	\$1408

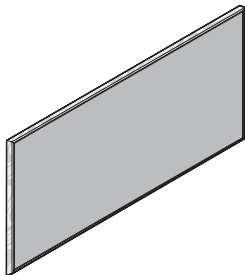

Tackboards

13/16"	48"	36"	CSET043	\$ 767
13/16"	48"	48"	CSET044	\$ 865
13/16"	60"	48"	CSET054	\$ 962
13/16"	72"	48"	CSET064	\$1079
13/16"	96"	48"	CSET084	\$1220
13/16"	120"	48"	CSET104	\$1408

Whiteboards and Tackboards



For Canadian Pricing

Multiply U.S. Price by the Canadian price factor.

▶ See page 1 for details.

FreeFlow Series

► Specifying, page 38

Screen print patterns

are available to assist in writing on the boards. Custom screen printing is also available.

► Page 11

Freeflow is available with an easy-mount metal cleat-mounting system.

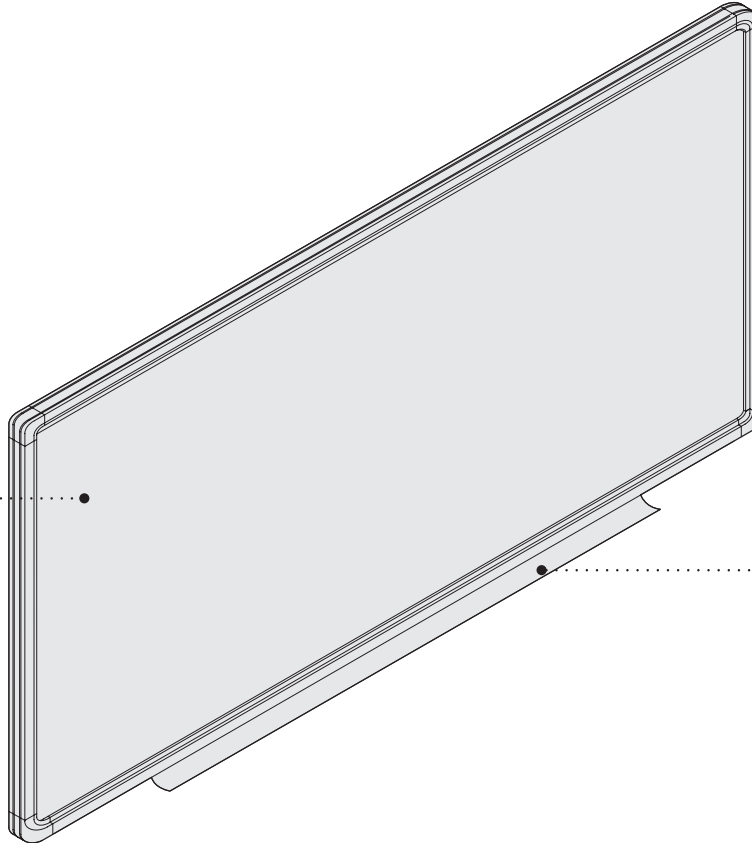

Writing surface is high-performance e³ ceramicsteel.

Marker tray is clear anodized aluminum and matches the aluminum frame.

Actual Dimensions

	CFFM064	CFFM084	CFFM104	CFFM124
Overall Width	72" or 1829 mm	96" or 2438 mm	120" or 3048 mm	144" or 3658 mm
Surface Width	71 1/4" or 1810 mm	95 1/4" or 2419 mm	119 1/4" or 3029 mm	143 1/4" or 3639 mm
Marker Tray Width	48" or 1219 mm	48" or 1219 mm	60" or 1524 mm	72" or 1829 mm
Overall Height	48" or 1219 mm	48" or 1219 mm	48" or 1219 mm	48" or 1219 mm
Surface Height	47 1/2" or 1207 mm	47 1/2" or 1207 mm	47 1/2" or 1207 mm	47 1/2" or 1207 mm
Frame Depth	7/8" or 20 mm	7/8" or 20 mm	7/8" or 20 mm	7/8" or 20 mm
Depth from Wall to Frame Face	1" or 25 mm	1" or 25 mm	1" or 25 mm	1" or 25 mm
Marker Tray Depth	3 1/2" or 89 mm	3 1/2" or 89 mm	3 1/2" or 89 mm	3 1/2" or 89 mm
Weight (lbs)	54 lb	78 lb	96 lb	117 lb
Weight (kgs)	24.5 kg	35.4 kg	43.6 kg	53.1 kg

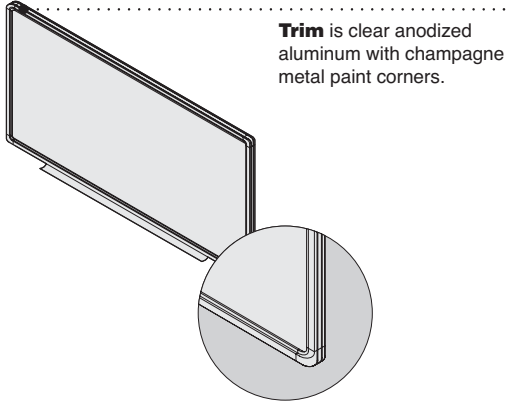

Trim is clear anodized aluminum with champagne metal paint corners.

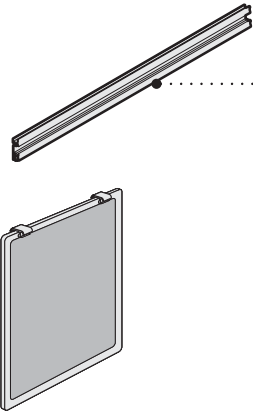

Top trim extrusion has integrated rail functionality to accommodate Freeflow series components.

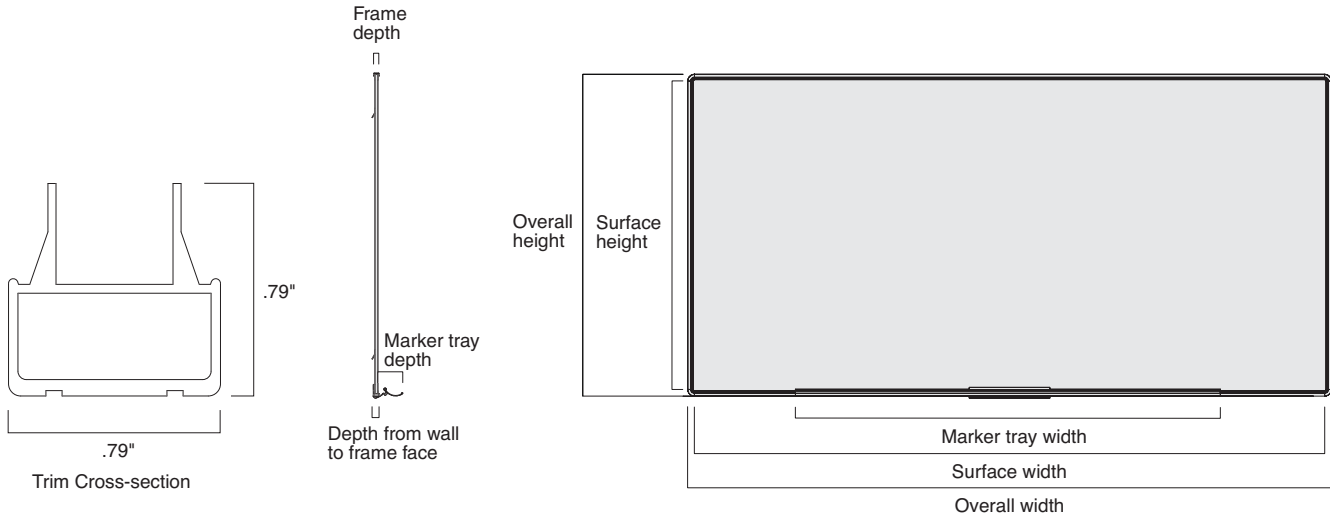

CFFM164

192" or 4877 mm
191 1/4" or 4858 mm
96" or 2438 mm
48 1/4" or 1226 mm
47 1/2" or 1207 mm
7/8" or 20 mm
1" or 25 mm
3 1/2" or 89 mm
156 lb
70.8 kg

FreeFlow Series

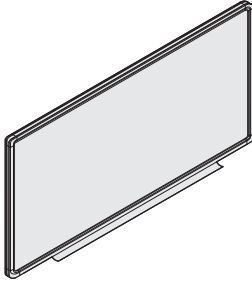

Tip: Screen print option is not available on 144"W x 48"H to 192"W x 48"H screens. Specify 7656 Circular Dot or 7657 2" Grid for pattern.

Standard Includes	Required to Specify
<ul style="list-style-type: none"> ▶ Need help? Product details, page 36 • e³ environmental ceramicsteel writing surface: 7655 High Gloss White • Frame: 8043 Clear Anodized Aluminum • Matching aluminum marker tray • Integral hanging rail to support FreeFlow components • Metal cleat mounting system • Package of four dry-erase markers (black, blue, red, and green) and one eraser • Shipped ready to assemble 	<ul style="list-style-type: none"> 1 Style number 2 Options, if selected (see below)

Options	U.S. Price	Required to Specify
Surface Materials Screen print in 7656 Circular Dot or 7657 Grid pattern		
• 72"W x 48"H	+\$337	Specify <i>with screen print</i> and select pattern number.
• 96"W x 48"H	+\$449	Specify <i>with screen print</i> and select pattern number.
• 120"W x 48"H	+\$557	Specify <i>with screen print</i> and select pattern number.

Related Products	• Accessories	▶ Page 69
-------------------------	---------------	-----------

Specification Information

• Dimensions			• Style Number	• U.S. Base Price
D	W	H		
3/4"	72"	48"	CFFM064	\$ 748
3/4"	96"	48"	CFFM084	\$ 904
3/4"	120"	48"	CFFM104	\$1061
3/4"	144"	48"	CFFM124	\$1227
3/4"	192"	48"	CFFM164	\$1519
:	:	:	:	:



For Canadian Pricing
 Multiply U.S. Price by the Canadian price factor.
 ▶ See page 1 for details.

FreeFlow Series Components

Sliding Markerboard

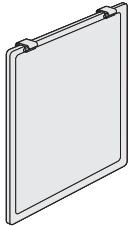

Standard Includes	Required to Specify
<ul style="list-style-type: none"> ▶ Need help? Product details, page 36 e³ environmental ceramicsteel writing surface: 7655 High Gloss White Frame: 8043 Clear Anodized Aluminum Matching aluminum marker tray Shipped ready to assemble 	Style number

Specification Information				
• Dimensions			• Style	• U.S.
D	W	H	Number	Price
3/4"	35 ³ / ₄ "	45 ³ / ₄ "	CFFSMB034	\$605

Whiteboards and Tackboards

Sliding Tackboard

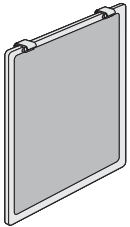

Standard Includes	Required to Specify
<ul style="list-style-type: none"> ▶ Need help? Product details, page 36 Fabric over 3/8" fiberboard on tackboards Frame: 8043 Clear Anodized Aluminum Shipped ready to assemble 	1 Style number 2 Fabric color number for tackboard 3 Options, if selected (see below) ▶ See <i>Surface Materials</i> , page 87

Options	U.S. Price	Required to Specify
Surface Materials Fabric surface on tackboards <ul style="list-style-type: none"> Fabric price group 1 Fabric price group 2 Fabric price group 3 Fabric price group 4 Fabric price group COM 	No cost +\$45 +\$57 +\$86 +\$16	Specify fabric color number. Specify fabric color number. Specify fabric color number. Specify fabric color number. ▶ See <i>Understanding Customer's Own Material (COM)</i> , page 88.

Specification Information				
• Dimensions			• Style	• U.S.
D	W	H	Number	Base Price
3/4"	35 ³ / ₄ "	45 ³ / ₄ "	CFFSTB034	\$605

For Canadian Pricing
 Multiply U.S. Price by the Canadian price factor.
 ▶ See page 1 for details.

FreeFlow Series Components, continued

Flipchart Holder

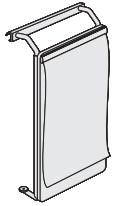

Standard Includes	Required to Specify
-------------------	---------------------

- | | | |
|---|---|--|
| <ul style="list-style-type: none"> ▶ Need help? Product details, page 36 | <ul style="list-style-type: none"> • e³ environmental ceramicsteel writing surface: 7655 High Gloss White • Frame: 8043 Clear Anodized Aluminum • Shipped ready to assemble | <ul style="list-style-type: none"> Style number |
|---|---|--|

Specification Information				
• Dimensions			• Style	• U.S.
D	W	H	Number	Price

3/4"	30"	43"	CFFF	\$1188
:	:	:	:	:

Magnetic Flipchart Holder

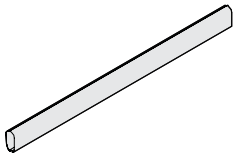

Standard Includes	Required to Specify
-------------------	---------------------

- | | | |
|---|--|--|
| <ul style="list-style-type: none"> ▶ Need help? Product details, page 36 | <ul style="list-style-type: none"> • Holder: 8043 Clear Anodized Aluminum | <ul style="list-style-type: none"> Style number |
|---|--|--|

Specification Information		
• Dimensions	• Style	• U.S.
W	Number	Price

30"	CFFMFH30	\$176
:	:	:



For Canadian Pricing

Multiply U.S. Price by the Canadian price factor.

▶ See page 1 for details.

Rails

Standard Includes	Required to Specify
<ul style="list-style-type: none"> Need help? Product details, page 36 Frame: 8043 Clear Anodized Aluminum 	Style number

Specification Information

Dimensions			Style	U.S.
D	W	H	Number	Price

Double Rail				
1/2"	96"	2"	CFFT	\$293

Bottom Rail				
1/2"	96"	2"	CFFBT	\$163

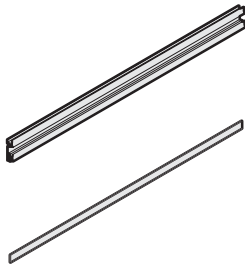

Tip: Bottom rail is used to protect the wall surface.

Whiteboards and Tackboards

 **For Canadian Pricing**
 Multiply U.S. Price by the Canadian price factor.
 ▶ See page 1 for details.

Huddleboard Markerboards and Photo Boards

► Specifying, page 43

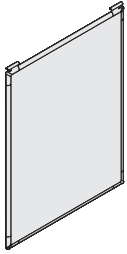

Markerboard

- Lightweight; weighs less than 5 pounds
- 6672 Platinum White frame
- Double-sided marker surface
- One year warranty

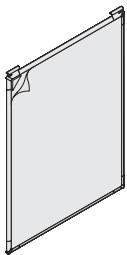
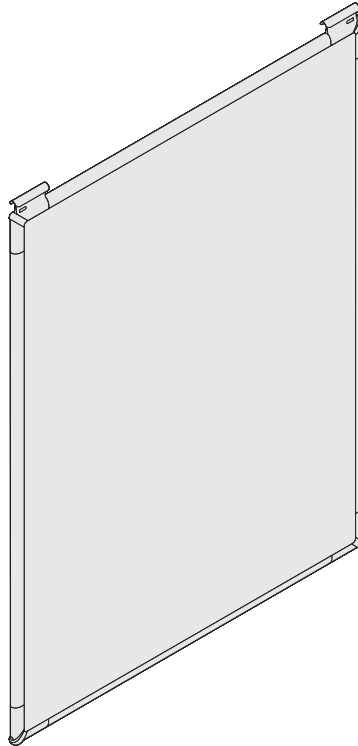
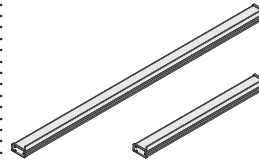

Photo Boards

- Lightweight; weighs less than 5 pounds
- 6672 Platinum White frame
- Front side features 3M repositionable, adhesive, flexible cover allowing display without tack or push pins.
- Reverse side features white markerboard surface.
- Translucent plastic hanger hooks are standard with each board.
- One year warranty



Product Details



Worktool rail is double-tracked and comes standard in either clear or black anodized aluminum. Worktool rails mount directly into structural walls (drywall).

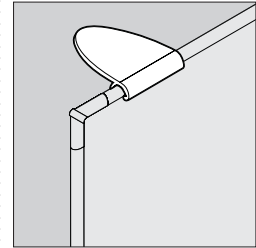

Ledge grabbers secure Huddleboards to furniture panels, storage cabinets, and other horizontal surfaces, in either landscape or horizontal orientation.

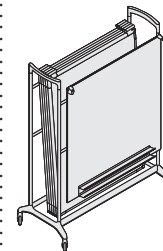

Mobile easel stores and transports up to ten Huddleboards. Display adjusts to three different heights: sitting (63"H), and standing (71"H and 73"H). Grips on the display board hold Huddleboards in either portrait or landscape orientation.

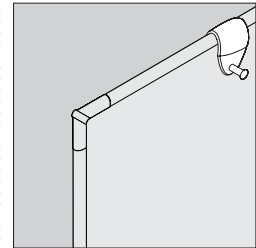

Flipchart pegs clip on to the Huddleboard frame to accept standard paper flipcharts.

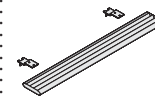

Panel-mounted trays come standard with drywall mounting brackets. Panel-mounted trays provide space for Huddleboards and storage for markers and erasers. Optional panel-mounting hardware for Avenir, Series 9000, Answer, Kick, and Privacy Wall is also available.

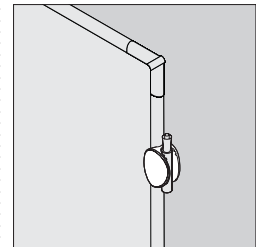

Marker grips attach to any Huddleboard frame to hold a dry erase marker.

Actual Dimensions for Huddleboards

Depth	3/4"
Width	23 1/3" or 32"
Height	32" or 42"
Weight	Less than 5 lb

Actual Dimensions for Mobile Easels

	Landscape to top of board	Portrait to top of board
Sitting Height	52" or 1321 mm	63" or 1600 mm
Standing Height 1	59" or 1500 mm	71" or 1803 mm
Standing Height 2	66" or 1676 mm	78" or 1981 mm

Huddleboard Markerboards and Photo Boards

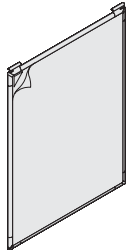
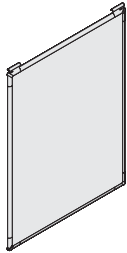

Tip: Markerboards are double-sided and available in two sizes.

Standard Includes	Required to Specify
<ul style="list-style-type: none"> ▶ Need help? Product details, page 42 • Double-sided markerboard: 7655 High Gloss White • 3M repositionable adhesive on Photo Board and Markerboard on reverse side, if selected • Trim: 6672 Platinum White • Translucent plastic hanger hooks 	<ul style="list-style-type: none"> ▶ Style number

Related Products
<ul style="list-style-type: none"> • Ledge grabbers ▶ Page 44 • Flipchart pegs ▶ Page 44 • Markerboard grips ▶ Page 44

Specification Information				
• Dimensions			• Style	• U.S.
D	W	H	Number	Price

Small Markerboard, Package of Five				
3/4"	23"	32"	K5M2332	\$614
:	:	:	:	:

Small Markerboard Package with Accessories (Two Ledge Grabbers and One Markerboard Grip)				
3/4"	23"	32"	KSM2332	\$174
:	:	:	:	:

Large Markerboard, Package of Five				
3/4"	32"	42"	K5M3242	\$665
:	:	:	:	:

Large Board Package with Accessories (Two Ledge Grabbers and One Markerboard Grip)				
3/4"	32"	42"	KSM3242	\$220
:	:	:	:	:

Whiteboards and Tackboards

 **For Canadian Pricing**
 Multiply U.S. Price by the Canadian price factor.
 ▶ See page 1 for details.

Huddleboard Markerboards and Photo Boards, continued

Ledge Grabber



Standard Includes		Required to Specify
▶ Need help? Product details, page 42	• Package of 10 ledge grabbers: translucent plastic	Style number

Specification Information				
• Dimensions			• Style	• U.S.
D	W	H	Number	Price
3"	3½"	1"	KLG	\$91
⋮	⋮	⋮	⋮	⋮

Flip Chart Peg



Standard Includes		Required to Specify
▶ Need help? Product details, page 42	• Package of 10 flip chart pegs: translucent plastic	Style number

Specification Information				
• Dimensions			• Style	• U.S.
D	W	H	Number	Price
1½"	1¼"	2"	KPEG	\$84
⋮	⋮	⋮	⋮	⋮

Markerboard Grip



Standard Includes		Required to Specify
▶ Need help? Product details, page 42	• Package of 5 markerboard grips: translucent plastic	Style number

Specification Information				
• Dimensions			• Style	• U.S.
D	W	H	Number	Price
1¼"	1⅝"	2"	KMGRIP	\$68
⋮	⋮	⋮	⋮	⋮



For Canadian Pricing
 Multiply U.S. Price by the
 Canadian price factor.
 ▶ See page 1 for details.

Mobile Easel

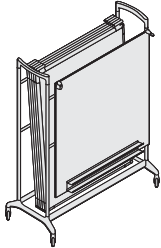

Standard Includes	Required to Specify
<ul style="list-style-type: none"> Need help? Product details, page 42 Easel frame: 4798 Sterling Storage tray: Sterling plastic only Storage capacity for 10 large boards 	Style number

Specification Information				
Dimensions			Style Number	U.S. Price
D	W	H		
29 1/4"	37"	50-60"	KME	\$1000

Panel-Mounted Trays

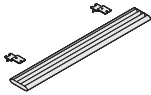

Tip: For Answer, Kick, Series 9000, and Avenir, specify PLMTFURN furniture mount. For Privacy Wall or dry wall, specify PLMT-WALL panel mount.

Standard Includes	Required to Specify
<ul style="list-style-type: none"> Need help? Product details, page 42 Tray: 4798 Sterling End caps: 6696 Sterling plastic Mounting hardware 	1 Style number 2 Options, if selected (see below)

Options	U.S. Price	Required to Specify
Tray Mounts		
• Furniture mount	No cost	Specify with PLMTFURN furniture mount.
• Wall-mount	No cost	Specify with PLMTWALL panel mount.

Specification Information				
Dimensions		Style Number	U.S. Price	
W	H			
36"	4 1/2"	KPMT36	\$194	
48"	4 1/2"	KPMT48	\$237	
72"	4 1/2"	KPMT72	\$276	

Worktool Rails

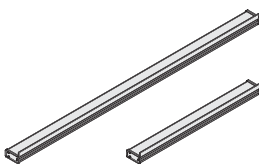

Standard Includes	Required to Specify
<ul style="list-style-type: none"> Need help? Product details, page 42 Wall-mounted rail: anodized aluminum End caps: black plastic 	1 Style number 2 Metal paint color number for rail: 8043 Clear Anodized 8044 Black Anodized

Specification Information				
Dimensions			Style Number	U.S. Price
D	W	H		
2"	48"	1 1/4"	GCJWT48	\$394
2"	96"	1 1/4"	GCJWT96	\$708

 **For Canadian Pricing**
Multiply U.S. Price by the Canadian price factor.
▶ See page 1 for details.

Combo Boards

► Specifying, page 48

Combo boards are 1/2" marker, 1/2" tackable surface divided by a 3/4" vertical aluminum extrusion.

Combo boards are available with an easy-mount metal cleat-mounting system.

Writing surface is high-performance e³ ceramicsteel.

Tackable surface is available in a selection of standard or graded-in fabrics. COM is also available.

Marker tray is clear anodized aluminum and matches the aluminum frame.

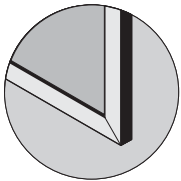
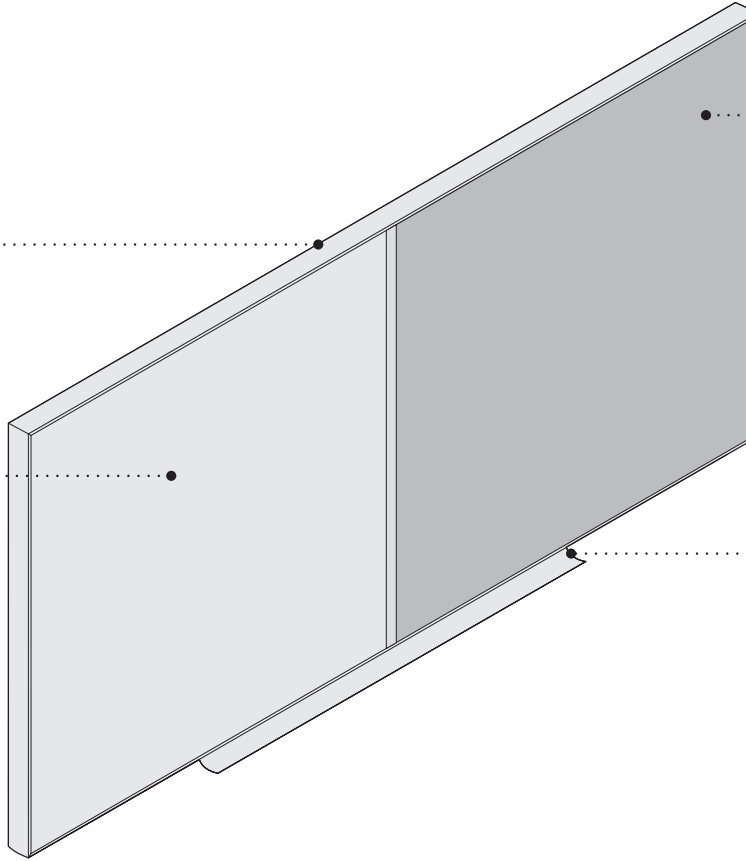

Access

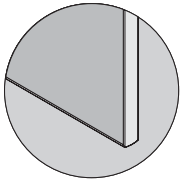

Edge

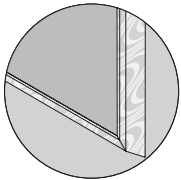

Session

Combo boards are available in Edge, Access, or Session series trim.

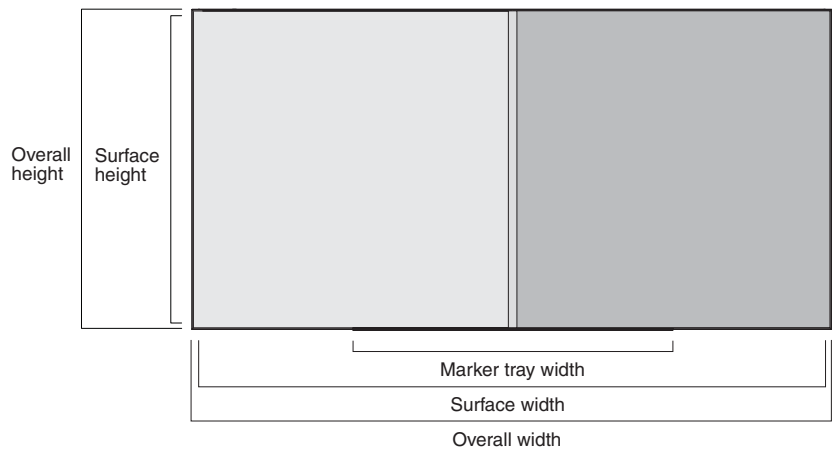
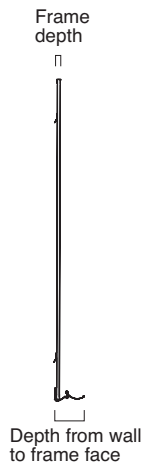

Combo Boards

Edge Series

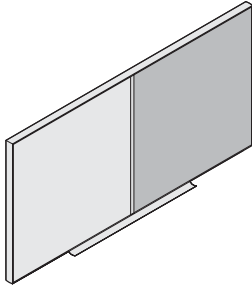

Tip: For more information on Edge Series, see page 18.

Standard Includes	Required to Specify
-------------------	---------------------

- | | |
|---|---|
| <ul style="list-style-type: none"> ▶ Need help? Product details, page 46 | <ul style="list-style-type: none"> 1 Style number 2 Options, if selected (see below) ▶ See <i>Surface Materials</i>, page 87 |
|---|---|

Options	U.S. Price	Required to Specify
---------	------------	---------------------

Surface Materials	Frame	U.S. Price	Required to Specify
	• 24"W x 18"H	+\$ 48	Specify with 4750 Champagne metallic trim.
	• 36"W x 24"H	+\$ 68	Specify with 4750 Champagne metallic trim.
	• 48"W x 48"H	+\$109	Specify with 4750 Champagne metallic trim.
	• 60"W x 48"H	+\$120	Specify with 4750 Champagne metallic trim.
	• 72"W x 48"H	+\$135	Specify with 4750 Champagne metallic trim.
	• 96"W x 48"H	+\$164	Specify with 4750 Champagne metallic trim.
	• 120"W x 48"H	+\$189	Specify with 4750 Champagne metallic trim.
	• 144"W x 48"H	+\$219	Specify with 4750 Champagne metallic trim.

Fabric surface on tackboards

• Fabric price group 1	No cost	Specify fabric color number.
• Fabric price group 2		
- 24"W x 18"H to 36"W x 24"H	+\$ 9	Specify fabric color number.
- 48"W x 48"H	+\$ 19	Specify fabric color number.
- 60"W x 48"H	+\$ 23	Specify fabric color number.
- 72"W x 48"H to 96"W x 48"H	+\$ 38	Specify fabric color number.
- 120"W x 48"H	+\$ 45	Specify fabric color number.
- 144"W x 48"H	+\$ 50	Specify fabric color number.
• Fabric price group 3		
- 24"W x 18"H to 36"W x 24"H	+\$ 13	Specify fabric color number.
- 48"W x 48"H	+\$ 24	Specify fabric color number.
- 60"W x 48"H	+\$ 27	Specify fabric color number.
- 72"W x 48"H to 96"W x 48"H	+\$ 47	Specify fabric color number.
- 120"W x 48"H	+\$ 57	Specify fabric color number.
- 144"W x 48"H	+\$ 67	Specify fabric color number.
• Fabric price group 4		
- 24"W x 18"H to 36"W x 24"H	+\$ 17	Specify fabric color number.
- 48"W x 48"H	+\$ 35	Specify fabric color number.
- 60"W x 48"H	+\$ 43	Specify fabric color number.
- 72"W x 48"H to 96"W x 48"H	+\$ 68	Specify fabric color number.
- 120"W x 48"H	+\$ 86	Specify fabric color number.
- 144"W x 48"H	+\$104	Specify fabric color number.
• Fabric price group COM	+\$ 16	▶ See <i>Understanding Customer's Own Material (COM)</i> , page 88.

On- and Off-Module Brackets	<ul style="list-style-type: none"> • Available on 48"W x 48"H to 192"W x 48"H combo boards 	+\$108	Specify with on- and off-module brackets.
------------------------------------	---	--------	---

Related Products	<ul style="list-style-type: none"> • Accessories 	▶ Page 69
-------------------------	---	-----------



For Canadian Pricing

Multiply U.S. Price by the Canadian price factor.

▶ See page 1 for details.

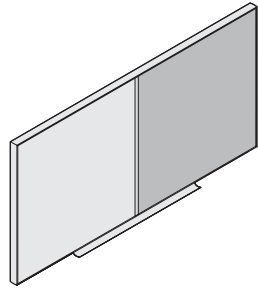

Specification Information

Dimensions			Style Number	U.S. Base Price
D	W	H		

Edge Series Combo Board with Markerboard on Right Panel

3/4"	24"	18"	CEDMR0218	\$ 411
3/4"	36"	24"	CEDMR032	\$ 446
3/4"	48"	48"	CEDMR044	\$ 564
3/4"	60"	48"	CEDMR054	\$ 641
3/4"	72"	48"	CEDMR064	\$ 704
3/4"	96"	48"	CEDMR084	\$ 854
3/4"	120"	48"	CEDMR104	\$1017
3/4"	144"	48"	CEDMR124	\$1187

Edge Series Combo Board with Markerboard on Left Panel

3/4"	24"	18"	CEDML0218	\$ 411
3/4"	36"	24"	CEDML032	\$ 446
3/4"	48"	48"	CEDML044	\$ 564
3/4"	60"	48"	CEDML054	\$ 641
3/4"	72"	48"	CEDML064	\$ 704
3/4"	96"	48"	CEDML084	\$ 854
3/4"	120"	48"	CEDML104	\$1017
3/4"	144"	48"	CEDML124	\$1187

Whiteboards and Tackboards



For Canadian Pricing

Multiply U.S. Price by the Canadian price factor.

▶ See page 1 for details.

Combo Boards

Access Series

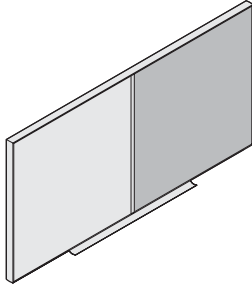

Tip: For more information on Access Series, see page 24.

Standard Includes	Required to Specify
-------------------	---------------------

<ul style="list-style-type: none"> ▶ Need help? Product details, page 46 	<ul style="list-style-type: none"> • 1/2 markerboard, 1/2 tackboard: e³ ceramicsteel and fabric • Frame: black metal paint with clear anodized insert • Marker tray: 8043 Clear Anodized Aluminum • 3/4" vertical center trim: 8043 Clear Anodized Aluminum • Metal cleat mounting package • Package of four dry-erase markers (black, blue, red, and green) and one eraser 	<ul style="list-style-type: none"> 1 Style number 2 Options, if selected (see below) ▶ See <i>Surface Materials</i>, page 87
---	--	---

Surface Materials	Frame	U.S. Price	Required to Specify
-------------------	-------	------------	---------------------

	• 36"W x 24"H	+\$ 68	Specify with 4750 Champagne metallic trim.
	• 48"W x 48"H	+\$109	Specify with 4750 Champagne metallic trim.
	• 60"W x 48"H	+\$120	Specify with 4750 Champagne metallic trim.
	• 72"W x 48"H	+\$135	Specify with 4750 Champagne metallic trim.
	• 96"W x 48"H	+\$164	Specify with 4750 Champagne metallic trim.
	• 120"W x 48"H	+\$189	Specify with 4750 Champagne metallic trim.
	• 144"W x 48"H	+\$219	Specify with 4750 Champagne metallic trim.

Fabric surface on tackboards

• Fabric price group 1	No cost	Specify fabric color number.
• Fabric price group 2		
- 36"W x 24"H	+\$ 9	Specify fabric color number.
- 48"W x 48"H	+\$ 19	Specify fabric color number.
- 60"W x 48"H	+\$ 23	Specify fabric color number.
- 72"W x 48"H to 96"W x 48"H	+\$ 38	Specify fabric color number.
- 120"W x 48"H	+\$ 45	Specify fabric color number.
- 144"W x 48"H	+\$ 50	Specify fabric color number.
• Fabric price group 3		
- 36"W x 24"H	+\$ 13	Specify fabric color number.
- 48"W x 48"H	+\$ 24	Specify fabric color number.
- 60"W x 48"H	+\$ 27	Specify fabric color number.
- 72"W x 48"H to 96"W x 48"H	+\$ 47	Specify fabric color number.
- 120"W x 48"H	+\$ 57	Specify fabric color number.
- 144"W x 48"H	+\$ 67	Specify fabric color number.
• Fabric price group 4		
- 36"W x 24"H	+\$ 17	Specify fabric color number.
- 48"W x 48"H	+\$ 35	Specify fabric color number.
- 60"W x 48"H	+\$ 43	Specify fabric color number.
- 72"W x 48"H to 96"W x 48"H	+\$ 68	Specify fabric color number.
- 120"W x 48"H	+\$ 86	Specify fabric color number.
- 144"W x 48"H	+\$104	Specify fabric color number.
• Fabric price group COM	+\$ 16	▶ See <i>Understanding Customer's Own Material (COM)</i> , page 88.

On- and Off-Module Brackets	• Available on 48"W x 48"H to 192"W x 48"H combo boards	+\$108	Specify with on- and off-module brackets.
------------------------------------	---	--------	---

Related Products	• Accessories		▶ Page 69
-------------------------	---------------	--	-----------



For Canadian Pricing

Multiply U.S. Price by the Canadian price factor.

▶ See page 1 for details.

Specification Information

Dimensions			Style Number	U.S. Base Price
D	W	H		

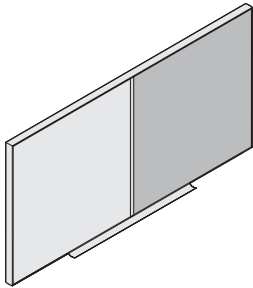

Access Series Combo Board with Markerboard on Right Panel

1"	36"	24"	CACMR032	\$ 542
1"	48"	48"	CACMR044	\$ 655
1"	60"	48"	CACMR054	\$ 776
1"	72"	48"	CACMR064	\$ 869
1"	96"	48"	CACMR084	\$1030
1"	120"	48"	CACMR104	\$1260
1"	144"	48"	CACMR124	\$1382

Access Series Combo Board with Markerboard on Left Panel

1"	36"	24"	CACML032	\$ 542
1"	48"	48"	CACML044	\$ 655
1"	60"	48"	CACML054	\$ 776
1"	72"	48"	CACML064	\$ 869
1"	96"	48"	CACML084	\$1030
1"	120"	48"	CACML104	\$1260
1"	144"	48"	CACML124	\$1382



For Canadian Pricing

Multiply U.S. Price by the Canadian price factor.

▶ See page 1 for details.

Combo Boards

Session Series

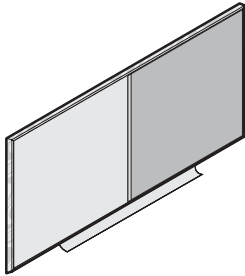

Tip: For more information on Session Series, see page 32.

Standard Includes	Required to Specify
<ul style="list-style-type: none"> ▶ Need help? Product details, page 46 • 1/2 markerboard, 1/2 tackboard: e³ ceramicsteel and fabric • Solid wood frame • Champagne powder coat marker tray • 3/4" vertical center trim: 8043 Clear Anodized Aluminum • Metal cleat mounting package • Package of four dry-erase markers (black, blue, red, and green) and one eraser 	<ul style="list-style-type: none"> 1 Style number 2 Wood color number for frame 3 Options, if selected (see below) ▶ See <i>Surface Materials</i>, page 87

Options	U.S. Price	Required to Specify
Surface Materials <ul style="list-style-type: none"> • Fabric surface on tackboards • Fabric price group 1 No cost • Fabric price group 2 <ul style="list-style-type: none"> - 48"W x 36"H to 48"W x 48"H +\$ 19 - 60"W x 48"H +\$ 23 - 72"W x 48"H +\$ 38 - 96"W x 48"H +\$ 45 - 120"W x 48"H +\$ 50 • Fabric price group 3 <ul style="list-style-type: none"> - 48"W x 36"H to 48"W x 48"H +\$ 24 - 60"W x 48"H +\$ 27 - 72"W x 48"H +\$ 47 - 96"W x 48"H +\$ 57 - 120"W x 48"H +\$ 67 • Fabric price group 4 <ul style="list-style-type: none"> - 48"W x 36"H to 48"W x 48"H +\$ 35 - 60"W x 48"H +\$ 43 - 72"W x 48"H +\$ 68 - 96"W x 48"H +\$ 86 - 120"W x 48"H +\$104 • Fabric price group COM +\$ 16 		<ul style="list-style-type: none"> Specify fabric color number. Specify fabric color number. Specify fabric color number. Specify fabric color number. Specify fabric color number. Specify fabric color number. Specify fabric color number. Specify fabric color number. Specify fabric color number. Specify fabric color number. Specify fabric color number. Specify fabric color number. Specify fabric color number. Specify fabric color number. Specify fabric color number. ▶ See <i>Understanding Customer's Own Material (COM)</i>, page 88.
Frame <ul style="list-style-type: none"> • Customiz stain +\$ 50 		<ul style="list-style-type: none"> Specify with <i>Customiz stain</i>.
On- and Off-Module Brackets <ul style="list-style-type: none"> • Available on 48"W x 48"H to 192"W x 48"H combo boards +\$108 		<ul style="list-style-type: none"> Specify with <i>on- and off-module brackets</i>.
Related Products <ul style="list-style-type: none"> • Accessories 		<ul style="list-style-type: none"> ▶ Page 69



For Canadian Pricing
 Multiply U.S. Price by the Canadian price factor.
 ▶ See page 1 for details.

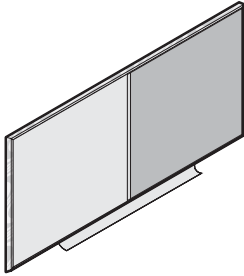

Specification Information

Dimensions			Style Number	U.S. Base Price
D	W	H		

Session Series Combo Board with Markerboard on Right Panel

1/2"	48"	36"	CSEMR043	\$ 907
1/2"	48"	48"	CSEMR044	\$ 952
1/2"	60"	48"	CSEMR054	\$1059
1/2"	72"	48"	CSEMR064	\$1187
1/2"	96"	48"	CSEMR084	\$1341
1/2"	120"	48"	CSEMR104	\$1549

Session Series Combo Board with Markerboard on Left Panel

1/2"	48"	36"	CSEML043	\$ 907
1/2"	48"	48"	CSEML044	\$ 952
1/2"	60"	48"	CSEML054	\$1059
1/2"	72"	48"	CSEML064	\$1187
1/2"	96"	48"	CSEML084	\$1341
1/2"	120"	48"	CSEML104	\$1549



For Canadian Pricing

Multiply U.S. Price by the Canadian price factor.

▶ See page 1 for details.

Patient Room Board

► Specifying, page 55

Patient room boards are available as markerboard or combo board (1/2 markerboard, 1/2 tackboard).

Custom sizes, configurations, and graphics are available.

Markerboard weighs approximately 25 lb. Combo board weighs approximately 40 lb.

Markerboard comes standard with one of two graphics (Option A or B). Graphic Option B comes standard with Nurture logo (must specify "No Logo" if not desired).

Icons make information easy to understand without multi-lingual text.

Writing surface is high-performance e³ ceramicsteel.

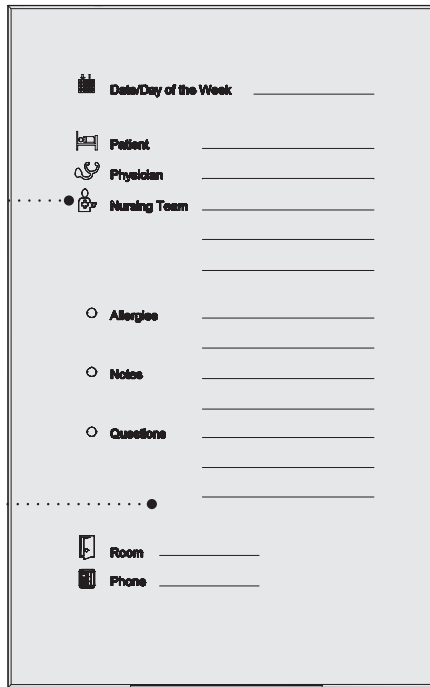

Trim is Edge Series clear anodized aluminum.

Patient room boards are available with an easy-mount metal cleat-mounting system.

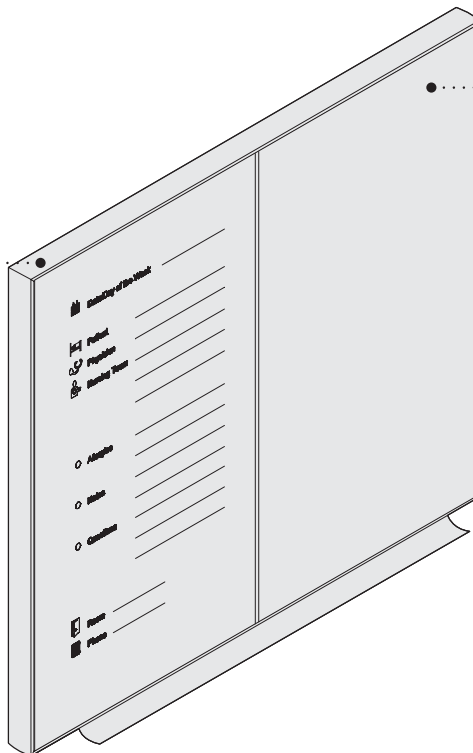

Patient room boards are 1/2 marker, 1/2 tackable surface divided by a 3/4" vertical aluminum extrusion.

Tackable surface is optional and available in a selection of standard or graded-in fabrics. COM is also available.

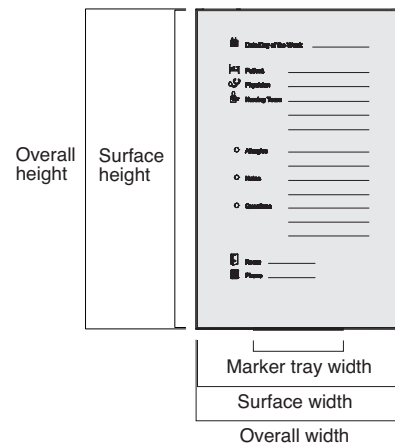

Patient Room Boards

Markerboard Only

Whiteboards and Tackboards

Standard Includes	Required to Specify
<ul style="list-style-type: none"> ▶ Need help? Product details, page 54 • Screen print graphic fused to e³ ceramicsteel writing surface: 7655 High Gloss White • Trim, Edge Series: 8043 Clear Anodized Aluminum • Marker tray: 8043 Clear Anodized Aluminum • Metal cleat mounting package • Package of four dry-erase markers (black, blue, red, and green) and one eraser • Shipped ready to assemble 	<ul style="list-style-type: none"> 1 Style number 2 Surface ink color number: Taupe, Gray 3 Options, if selected (see below) ▶ See <i>Surface Materials</i>, page 87

Options	U.S. Price	Required to Specify
Surface Materials <ul style="list-style-type: none"> • Trim • Paint 	+\$67	Specify paint color number.
Related Products <ul style="list-style-type: none"> • Accessories 		▶ Page 69

Specification Information				
Dimensions			Style	U.S.
D	W	H	Number	Base Price

Patient Room Board with Graphic A

3/4"	17 3/4"	27 3/4"	CEDH01827	\$405

Patient Room Board with Graphic B

3/4"	17 3/4"	27 3/4"	CEDH21827	\$405

 **Date/Day of the Week** _____

 **Patient** _____

 **Physician** _____

 **Nursing Team** _____

Allergies _____

Notes _____

Questions _____

 **Room** _____

 **Phone** _____

Graphic A

 **Date** _____ **S M T W T F S**

 **Room** _____

 **Phone** _____

 **Patient** _____

 **Physician** _____

 **Nursing Team** _____

Allergies _____

Patient Goals _____

Questions _____



Graphic B

 **For Canadian Pricing**
 Multiply U.S. Price by the Canadian price factor.
 ▶ See page 1 for details.

Patient Room Boards

Combo Boards

Standard Includes		Required to Specify
<ul style="list-style-type: none"> ▶ Need help? Product details, page 54 	<ul style="list-style-type: none"> • Screen print graphic fused to e³ ceramicsteel writing surface, 1/2 markerboard, 1/2 tackboard: e³ ceramicsteel and fabric • Frame, Edge Series: 8043 Clear Anodized Aluminum • 3/4" vertical center trim: 8043 Clear Anodized Aluminum • Marker tray: 8043 Clear Anodized Aluminum • Metal cleat mounting package • Package of four dry-erase markers (black, blue, red, and green) and one eraser 	<ol style="list-style-type: none"> 1 Style number 2 Fabric color number for tackboard 3 Surface ink color number: <ul style="list-style-type: none"> Ink2 Taupe Ink3 Gray 4 Options, if selected (see below) <ul style="list-style-type: none"> ▶ See <i>Surface Materials</i>, page 87

Options	U.S. Price	Required to Specify
Surface Materials <ul style="list-style-type: none"> • Fabric surface on tackboards • Fabric price group 1 • Fabric price group 2 • Fabric price group 3 • Fabric price group 4 • Fabric price group COM 	<ul style="list-style-type: none"> No cost +\$ 19 +\$ 24 +\$ 35 +\$ 16 	<ul style="list-style-type: none"> Specify fabric color number. Specify fabric color number. Specify fabric color number. Specify fabric color number. ▶ See <i>Understanding Customer's Own Material (COM)</i>, page 88.
Trim <ul style="list-style-type: none"> • Paint 	<ul style="list-style-type: none"> +\$137 	<ul style="list-style-type: none"> Specify paint color number.
Related Products <ul style="list-style-type: none"> • Accessories 		<ul style="list-style-type: none"> ▶ Page 69

Specification Information				
• Dimensions			• Style	• U.S.
D	W	H	Number	Base Price
...

Patient Room Combo Board with Markerboard and Graphic A on Right				
3/4"	35 3/8"	27 3/4"	CEDHCR03627	\$508
...

Patient Room Combo Board with Markerboard and Graphic A on Left				
3/4"	35 3/8"	27 3/4"	CEDHCL03627	\$508
...

▶ Specification Information, continued on next page



 **For Canadian Pricing**
 Multiply U.S. Price by the Canadian price factor.
 ▶ See page 1 for details.

► Specification Information, continued from previous page

Specification Information

Dimensions			Style	U.S.
D	W	H	Number	Base Price

Patient Room Combo Board with Markerboard and Graphic B on Right

3/4"	35 2/5"	27 3/4"	CEDHCR23627	\$508
------	---------	---------	--------------------	-------

Patient Room Combo Board with Markerboard and Graphic B on Left

3/4"	35 2/5"	27 3/4"	CEDHCL23627	\$508
------	---------	---------	--------------------	-------

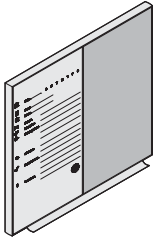
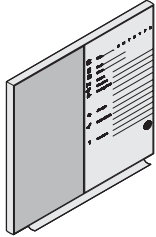

For Canadian Pricing

Multiply U.S. Price by the Canadian price factor.

► See page 1 for details.

110 Contractor Series

► Specifying, page 58

110 Contractor Series mounts securely using wall-anchored mounting system.

Custom sizes, configurations, and graphics are available.

► Page 11

Larger boards can be ordered with a spline joint that allows markerboards to ship in two equal pieces.

► Page 9

Clear anodized aluminum Maprail is available with options (map hook/clip, flag holder, and roller brackets).

Screen print Music Staff Lines is available as surface option.

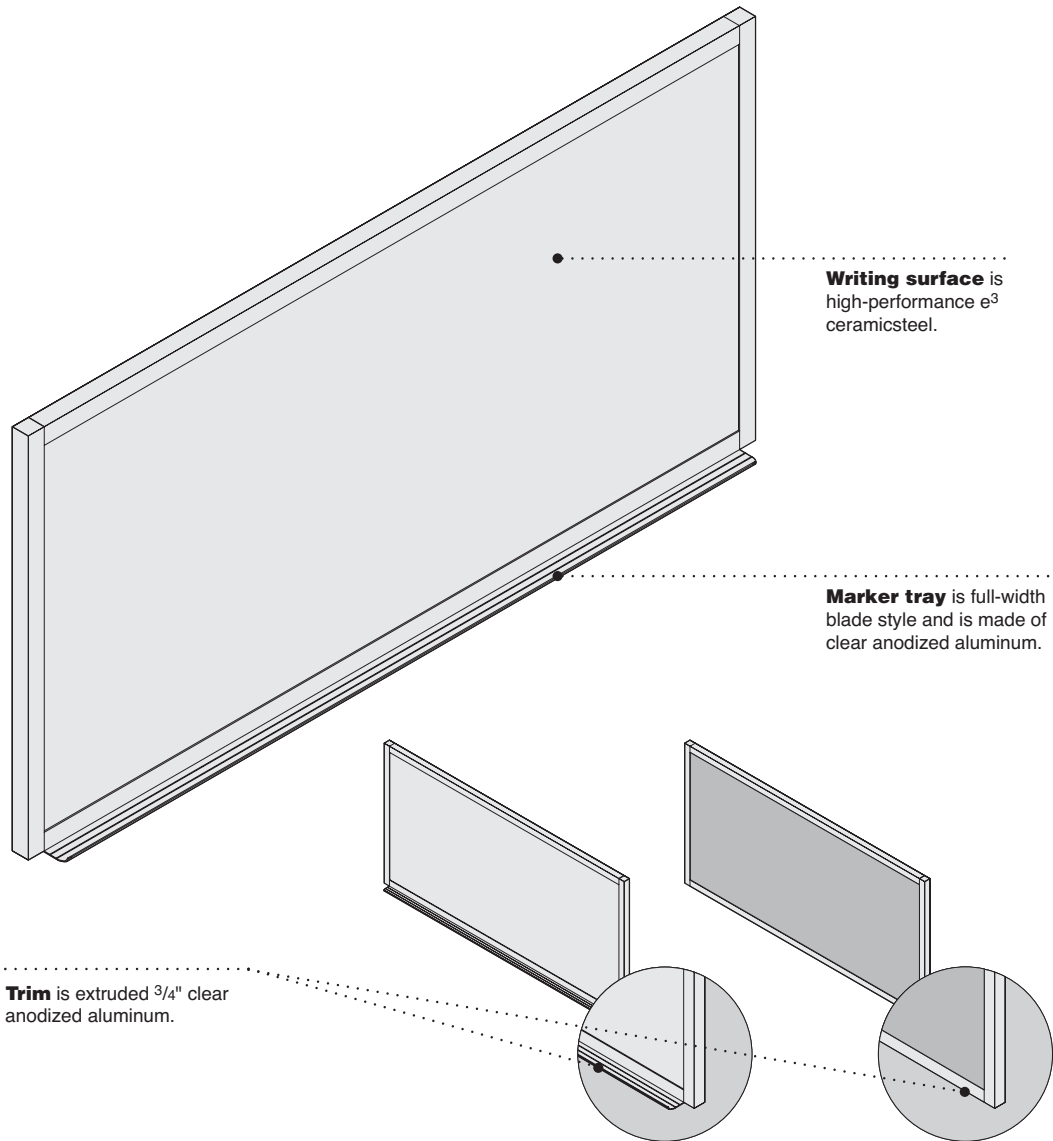

Actual Dimensions

	M1140043 T1150043	M1140044 T1150044	M1140054 T1150054	M1140064 T1150064
Overall Width	36 1/4" or 921 mm	48 1/4" or 1226 mm	60 1/4" or 1530 mm	72 1/4" or 1835 mm
Surface Width	34 3/4" or 883 mm	46 3/4" or 1187 mm	58 3/4" or 1492 mm	70 3/4" or 1797 mm
Marker Tray Width	35 1/2" or 902 mm	46 1/2" or 1181 mm	58 1/2" or 1486 mm	70 1/2" or 1791 mm
Overall Height	48 1/4" or 1226 mm	48 1/4" or 1226 mm	48 1/4" or 1226 mm	48 1/4" or 1226 mm
Surface Height	46 5/8" or 1184 mm	46 5/8" or 1184 mm	46 5/8" or 1184 mm	46 5/8" or 1184 mm
Frame Depth	5/8" or 16 mm	5/8" or 16 mm	5/8" or 16 mm	5/8" or 16 mm
Depth from Wall to Frame Face	7/8" or 22 mm	7/8" or 22 mm	7/8" or 22 mm	7/8" or 22 mm
Marker Tray Depth	2 5/8" or 67 mm	2 5/8" or 67 mm	2 5/8" or 67 mm	2 5/8" or 67 mm
Weight (MB/TB) lbs	35 1/5 - 26 1/8 lb	35 - 33 1/2 lb	58 4/5 - 41 5/8 lb	70 1/2 - 50 3/8 lb
Weight MB/TB) kgs	16.0 - 11.4 kg	21.3 - 15.2 kg	26.7 - 19.0 kg	32.0 - 22.8 kg

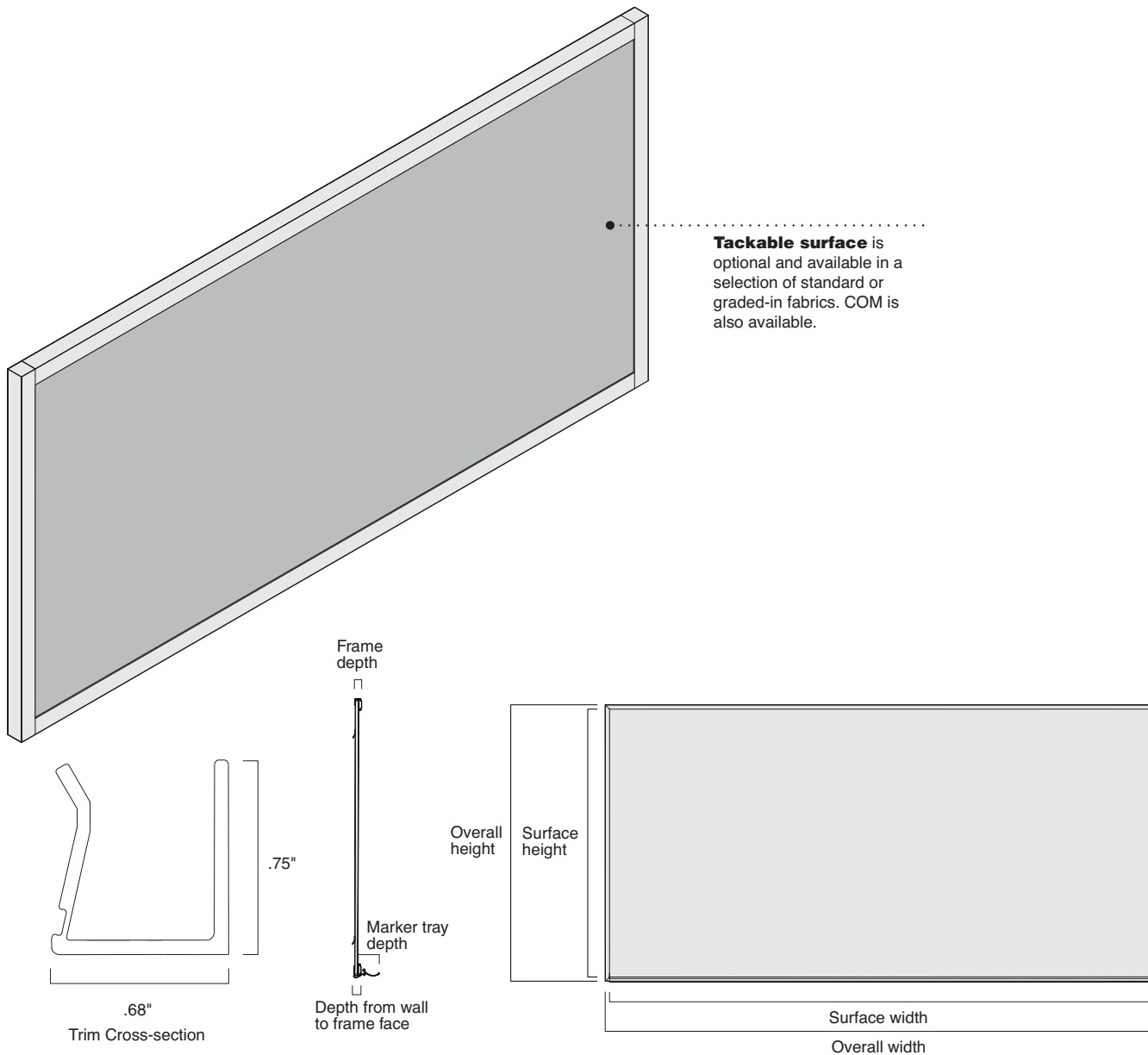

M1140084 T1150084	M1140104	M1140124	M1140164
96 ¹ / ₄ " or 2445 mm	120 ¹ / ₄ " or 3054 mm	144 ¹ / ₄ " or 3664 mm	192 ¹ / ₄ " or 4883 mm
94 ³ / ₄ " or 2407 mm	118 ³ / ₄ " or 3016 mm	142 ³ / ₄ " or 3626 mm	190 ³ / ₄ " or 4845 mm
94 ¹ / ₂ " or 2400 mm	118 ¹ / ₂ " or 3010 mm	142 ¹ / ₂ " or 3620 mm	190 ¹ / ₂ " or 4839 mm
48 ¹ / ₄ " or 1226 mm	48 ¹ / ₄ " or 1226 mm	48 ¹ / ₄ " or 1226 mm	48 ¹ / ₄ " or 1226 mm
46 ⁵ / ₈ " or 1184 mm	46 ⁵ / ₈ " or 1184 mm	46 ⁵ / ₈ " or 1184 mm	46 ⁵ / ₈ " or 1184 mm
5 ⁵ / ₈ " or 16 mm	5 ⁵ / ₈ " or 16 mm	5 ⁵ / ₈ " or 16 mm	5 ⁵ / ₈ " or 16 mm
7 ⁷ / ₈ " or 22 mm	7 ⁷ / ₈ " or 22 mm	7 ⁷ / ₈ " or 22 mm	7 ⁷ / ₈ " or 22 mm
2 ⁵ / ₈ " or 67 mm	2 ⁵ / ₈ " or 67 mm	2 ⁵ / ₈ " or 67 mm	2 ⁵ / ₈ " or 67 mm
94 - 67 lb	117 ¹ / ₂ lb	141 lb	188 lb
42.6 - 30.4 kg	53.3 kg	64.0 kg	85.0 kg

110 Contractor Series

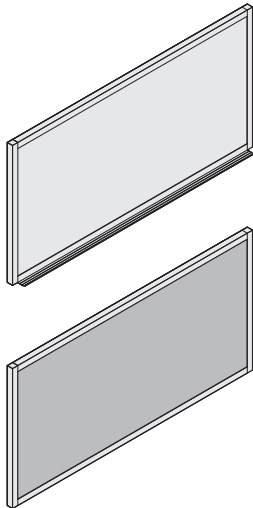

Tip: Music Staff lines screen print option is not available on 120"W x 48"H to 192"W x 48"H screens. Specify 7658 Music staff lines screen print.

Standard Includes	Required to Specify
<ul style="list-style-type: none"> ▶ Need help? Product details, page 58 e³ environmental ceramicsteel writing surface: 7655 High Gloss White Fabric over 3/8" fiberboard on tackboards, if selected 3/4" Frame: 8043 Clear Anodized Aluminum Full-width aluminum marker tray on markerboard Package of four dry-erase markers (black, blue, red, and green) and one eraser (markerboard only) Shipped ready to assemble 	<ol style="list-style-type: none"> 1 Style number 2 Fabric color number for tackboard, if selected 3 Options, if selected (see below) <ul style="list-style-type: none"> ▶ See <i>Surface Materials</i>, page 87

Surface Materials	Options	U.S. Price	Required to Specify	
	Screen print in Music Staff Lines			
	• 36"W x 48"H	+\$167	Specify with 7658 screen print.	
	• 48"W x 36"H	+\$167	Specify with 7658 screen print.	
	• 48"W x 48"H	+\$218	Specify with 7658 screen print.	
	• 60"W x 48"H	+\$274	Specify with 7658 screen print.	
	• 72"W x 48"H	+\$330	Specify with 7658 screen print.	
	• 96"W x 48"H	+\$440	Specify with 7658 screen print.	
	Fabric surface on tackboards			
	• Fabric price group 1	No cost	Specify fabric color number.	
	• Fabric price group 2			
	- 36"W x 48"H to 48"W x 48"H	+\$ 38	Specify fabric color number.	
	- 60"W x 48"H	+\$ 45	Specify fabric color number.	
	- 72"W x 48"H	+\$ 50	Specify fabric color number.	
	- 96"W x 48"H	+\$ 52	Specify fabric color number.	
	• Fabric price group 3			
	- 36"W x 48"H to 48"W x 48"H	+\$ 47	Specify fabric color number.	
	- 60"W x 48"H	+\$ 57	Specify fabric color number.	
	- 72"W x 48"H	+\$ 67	Specify fabric color number.	
	- 96"W x 48"H	+\$ 69	Specify fabric color number.	
	• Fabric price group 4			
	- 36"W x 48"H to 48"W x 48"H	+\$ 68	Specify fabric color number.	
	- 60"W x 48"H	+\$ 86	Specify fabric color number.	
	- 72"W x 48"H	+\$104	Specify fabric color number.	
	- 96"W x 48"H	+\$113	Specify fabric color number.	
	• Fabric price group COM	+\$ 16	▶ See <i>Understanding Customer's Own Material (COM)</i> , page 88.	
	1" Maprail			
	• 36"W x 48"H to 48"W x 36"H	+\$ 9	Specify with MAPR maprail.	
	• 48"W x 48"H	+\$ 13	Specify with MAPR maprail.	
	• 60"W x 48"H	+\$ 16	Specify with MAPR maprail.	
	• 72"W x 48"H	+\$ 21	Specify with MAPR maprail.	
	• 96"W x 48"H	+\$ 28	Specify with MAPR maprail.	
	• 120"W x 48"H	+\$ 38	Specify with MAPR maprail.	
	• 144"W x 48"H	+\$ 47	Specify with MAPR maprail.	
	• 192"W x 48"H	+\$ 61	Specify with MAPR maprail.	
	1" Map Hook/Clip			
	• 36"W x 48"H to 48"W x 48"H	+\$ 2	Specify with H1 map hook/clip.	
	• 60"W x 48"H to 96"W x 48"H	+\$ 4	Specify with H1 map hook/clip.	
	• 120"W x 48"H to 144"W x 48"H	+\$ 6	Specify with H1 map hook/clip.	
	• 192"W x 48"H	+\$ 8	Specify with H1 map hook/clip.	
	1" Flag Holder	+\$ 12	Specify with FH1 flag holder.	
	Roller Bracket	+\$ 9	Specify with RB1 roller bracket.	
	Spline Joint	• 120"W x 48"H to 192"W x 48"H	+\$212	Specify with XSPL spline joint.
Related Products	• Accessories		▶ Page 69	



For Canadian Pricing
 Multiply U.S. Price by the Canadian price factor.
 ▶ See page 1 for details.

Specification Information

Dimensions			Style Number	U.S. Base Price
D	W	H		

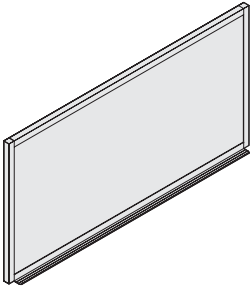

Markerboards

3/4"	36"	48"	M1140034	\$ 270
3/4"	48"	36"	M1140043	\$ 270
3/4"	48"	48"	M1140044	\$ 313
3/4"	60"	48"	M1140054	\$ 374
3/4"	72"	48"	M1140064	\$ 437
3/4"	96"	48"	M1140084	\$ 548
3/4"	120"	48"	M1140104	\$ 691
3/4"	144"	48"	M1140124	\$ 815
3/4"	192"	48"	M1140164	\$1028

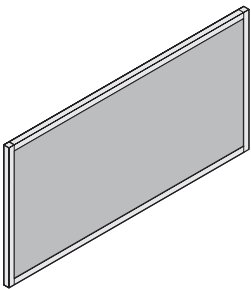

Tackboards

3/4"	36"	48"	T1150034	\$ 222
3/4"	48"	36"	T1150043	\$ 222
3/4"	48"	48"	T1150044	\$ 267
3/4"	60"	48"	T1150054	\$ 318
3/4"	72"	48"	T1150064	\$ 348
3/4"	96"	48"	T1150084	\$ 411

Whiteboards and Tackboards



For Canadian Pricing

Multiply U.S. Price by the Canadian price factor.

▶ See page 1 for details.

555 Contractor Series

► Specifying, page 64

555 Contractor Series mounts securely using wall-anchored mounting system.

Custom sizes, configurations, and graphics are available.

► Page 11

Larger boards can be ordered with a spline joint that allows markerboards to ship in two equal pieces.

► Page 9

Clear anodized aluminum Maprail is available with options (map hook/clip, flag holder, and roller brackets).

Screen print Music Staff Lines is available as surface option.

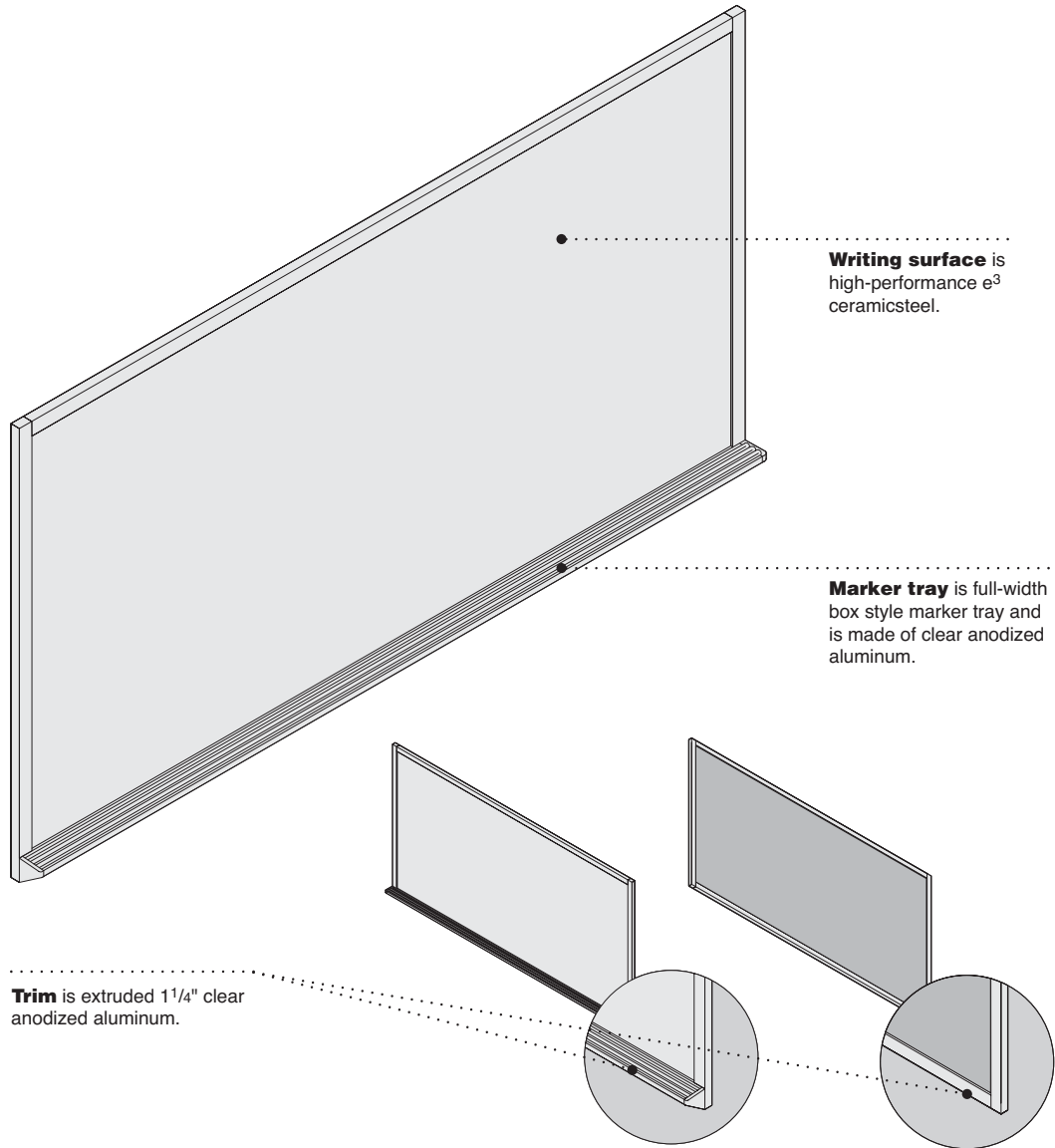

Actual Dimensions

	M5540034 T5550034	M5540043 T5550043	M5540044 T5550044	M5540054 T5550054
Overall Width	36 1/4" or 921 mm	48 1/4" or 1226 mm	48 1/4" or 1226 mm	60 1/4" or 1530 mm
Surface Width	33 3/4" or 857 mm	33 3/4" or 857 mm	45 3/4" or 1162 mm	57 3/4" or 1467 mm
Marker Tray Width	33 1/2" or 851 mm	33 1/2" or 851 mm	45 1/2" or 1156 mm	57 1/2" or 1461 mm
Overall Height	48 1/4" or 1226 mm	36 1/4" or 921 mm	48 1/4" or 1226 mm	48 1/4" or 1226 mm
Surface Height	44 1/2" or 1130 mm	44 1/2" or 1130 mm	44 1/2" or 1130 mm	44 1/2" or 1130 mm
Frame Depth	1" or 25 mm	1" or 25 mm	1" or 25 mm	1" or 25 mm
Depth from Wall to Frame Face	1" or 25 mm	1" or 25 mm	1" or 25 mm	1" or 25 mm
Marker Tray Depth	2 3/4" or 70 mm	2 3/4" or 70 mm	2 3/4" or 70 mm	2 3/4" or 70 mm
Weight (MB/TB) lbs	36 7/8 - 25 7/8 lb	36 7/8 - 25 7/8 lb	49 - 34 1/2 lb	61 3/8 - 43 1/8 lb
Weight MB/TB) kgs	16.7 - 11.7 kg	16.7 - 11.7 kg	22.2 - 15.7 kg	27.8 - 19.6 kg

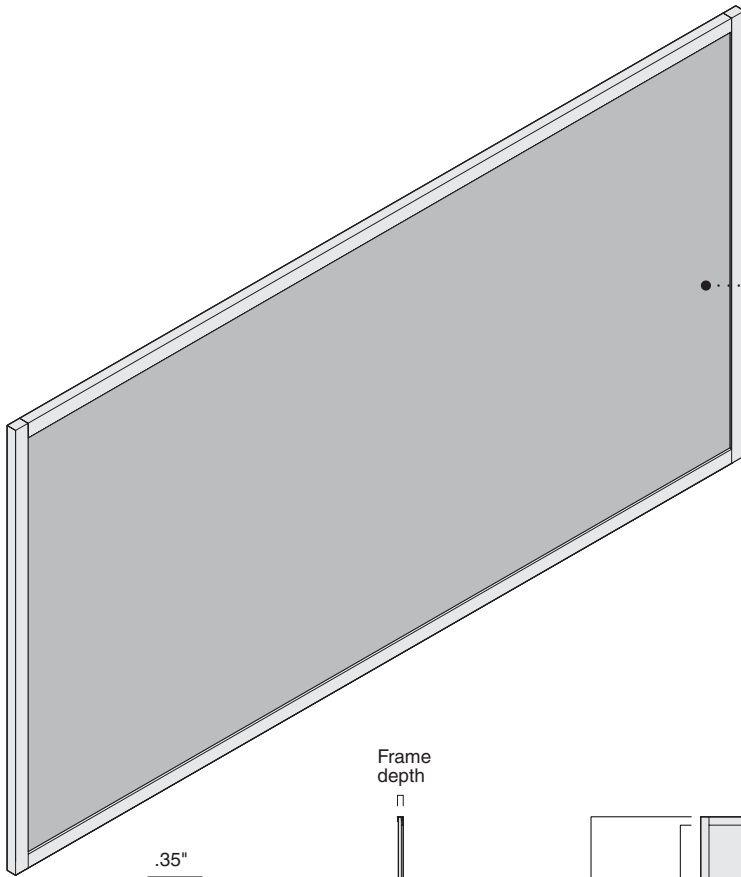

Tappable surface is optional and available in a selection of standard or graded-in fabrics. COM is also available.

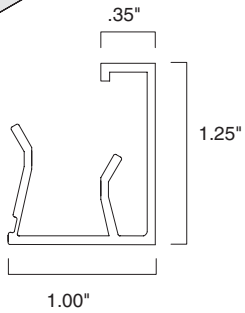

Trim Cross-section

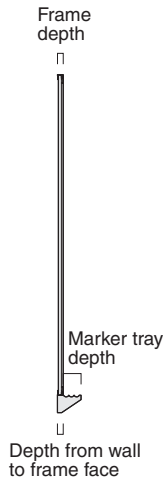

Depth from wall to frame face

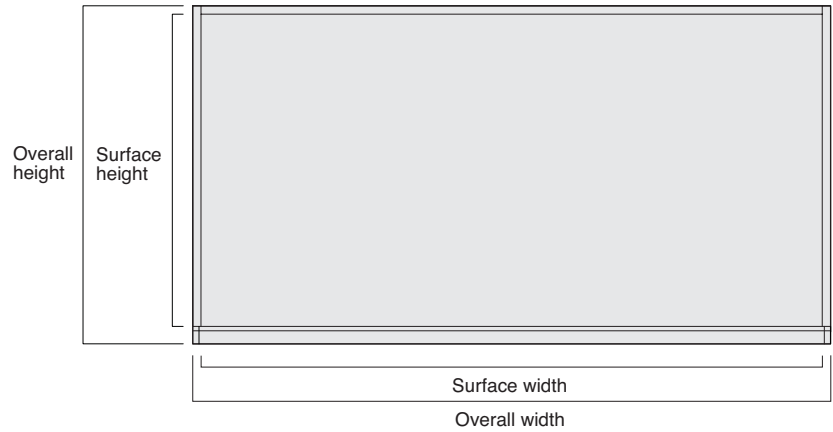

**M5540064
T5550064**

**M5540084
T5550084**

M5540104

M5540124

M5540164

72 ¹ / ₄ " or 1835 mm	96 ¹ / ₄ " or 2445 mm	120 ¹ / ₄ " or 3054 mm	144 ¹ / ₄ " or 3664 mm	192 ¹ / ₄ " or 4883 mm
69 ³ / ₄ " or 1772 mm	93 ³ / ₄ " or 2381 mm	117 ³ / ₄ " or 2991 mm	141 ³ / ₄ " or 3600 mm	189 ³ / ₄ " or 4820 mm
69 ¹ / ₂ " or 1765 mm	93 ¹ / ₂ " or 2375 mm	117 ¹ / ₂ " or 2985 mm	141 ¹ / ₂ " or 3594 mm	189 ¹ / ₂ " or 4813 mm
48 ¹ / ₄ " or 1226 mm	48 ¹ / ₄ " or 1226 mm	48 ¹ / ₄ " or 1226 mm	48 ¹ / ₄ " or 1226 mm	48 ¹ / ₄ " or 1226 mm
44 ¹ / ₂ " or 1130 mm	44 ¹ / ₂ " or 1130 mm	44 ¹ / ₂ " or 1130 mm	44 ¹ / ₂ " or 1130 mm	44 ¹ / ₂ " or 1130 mm
1" or 25 mm	1" or 25 mm	1" or 25 mm	1" or 25 mm	1" or 25 mm
1" or 25 mm	1" or 25 mm	1" or 25 mm	1" or 25 mm	1" or 25 mm
2 ³ / ₄ " or 70 mm	2 ³ / ₄ " or 70 mm	2 ³ / ₄ " or 70 mm	2 ³ / ₄ " or 70 mm	2 ³ / ₄ " or 70 mm
73 ¹ / ₂ - 51 ⁷ / ₈ lb	98 - 69 lb	122 ¹ / ₂ lb	147 lb	196 lb
33.3 - 23.5 kg	44.5 - 31.3 kg	55.6 kg	66.7 kg	88.9 kg

Specification Information

• Dimensions			• Style • Number	• U.S. • Base • Price
D	W	H		

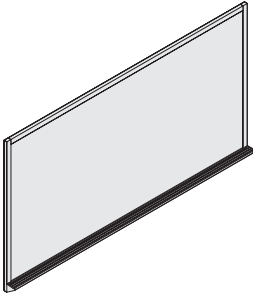

Markerboards

3/4"	36"	48"	M5540034	\$ 304
1/2"	48"	36"	M5540043	\$ 304
1/2"	48"	48"	M5540044	\$ 344
1/2"	60"	48"	M5540054	\$ 409
1/2"	72"	48"	M5540064	\$ 491
1/2"	96"	48"	M5540084	\$ 610
1/2"	120"	48"	M5540104	\$ 770
1/2"	144"	48"	M5540124	\$ 905
1/2"	192"	48"	M5540164	\$1175

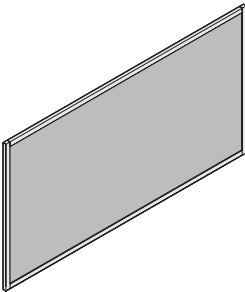

Tackboards

1/2"	36"	48"	T5550034	\$ 254
1/2"	48"	36"	T5550043	\$ 254
1/2"	48"	48"	T5550044	\$ 298
1/2"	60"	48"	T5550054	\$ 353
1/2"	72"	48"	T5550064	\$ 397
1/2"	96"	48"	T5550084	\$ 509

Whiteboards and
Tackboards



For Canadian Pricing

Multiply U.S. Price by the Canadian price factor.

▶ See page 1 for details.

Premium Whiteboard In-Fill

Stability Guidelines

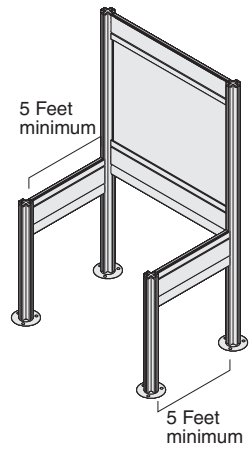

Minimum of two 5 foot returns are required, when using premium whiteboard in-fill, for Post and Beam applications.

Premium Whiteboard In-Fill

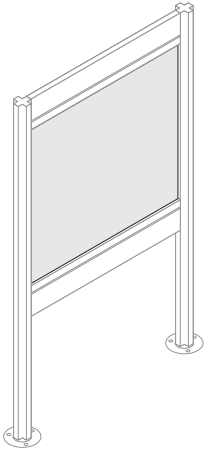

Tip: Premium Whiteboard in-fill is determined by the length of the fence beam.

Tip: In-fill board sizes are nominal based on Post and Beam center line planning.

Standard Includes	Required to Specify
-------------------	---------------------

- | | | |
|--|---|--------------|
| ▶ Need help?
See <i>Post and Beam Specification Guide</i> . | • Two-sided in-fill: 7655 High Gloss White e ³ ceramicsteel
• Pair of Premium Whiteboard in-fill J-hooks to replace one pair of top beam T-bolts. | Style number |
|--|---|--------------|

Specification Information			
• Dimensions		• Style	• U.S.
D	W	Number	Price

4'	4'	CPBFLM044	\$ 963
4'	5'	CPBFLM045	\$1204
4'	6'	CPBFLM046	\$1444
5'	4'	CPBFLM054	\$1204
6'	4'	CPBFLM064	\$1444
7'	4'	CPBFLM074	\$1685
8'	4'	CPBFLM084	\$1926
9'	4'	CPBFLM094	\$2166
10'	4'	CPBFLM104	\$2407



For Canadian Pricing

Multiply U.S. Price by the Canadian price factor.

▶ See page 1 for details.

Accessories

Dry Erase Markers

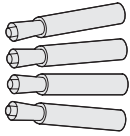

Standard Includes	Required to Specify
• Dry erase markers	Style number

Specification Information

• Style Number	• U.S. Price
Twelve Black Markers	
1MP12	\$24
Twelve Blue Markers	
2MP12	\$24
Twelve Red Markers	
3MP12	\$24
Twelve Green Markers	
4MP12	\$24
Three Black Markers, Three Blue Markers, Three Red Markers, and Three Green Markers	
MP12	\$24
One Black Marker, One Blue Marker, One Red Marker, and One Green Marker	
MP4	\$ 9

Whiteboards and Tackboards



For Canadian Pricing
 Multiply U.S. Price by the Canadian price factor.
 ▶ See page 1 for details.

Magnetic Eraser with Marker Holder

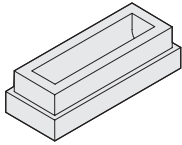

Tip: Eraser will hold one dry erase marker.

Standard Includes	Required to Specify
• Magnetic eraser with marker holder	Style number

Specification Information

Style Number	U.S. Price
MEP1	\$24

Magnetic Eraser Felt Replacements

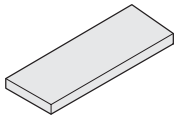

Standard Includes	Required to Specify
• Replacement felt	Style number

Specification Information

Style Number	U.S. Price
ERF5	\$5

Eraser

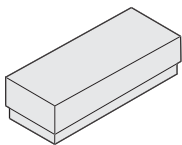

Standard Includes	Required to Specify
• Eraser	Style number

Specification Information

Style Number	U.S. Price
RE1	\$6



For Canadian Pricing
 Multiply U.S. Price by the Canadian price factor.
 ▶ See page 1 for details.

Magnetic Marker Trays

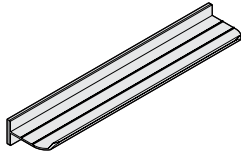

Standard Includes	Required to Specify
<ul style="list-style-type: none"> Marker tray: 8043 Clear Anodized Aluminum 	Style number

Specification Information

Style Number	U.S. Price
<hr/>	

12" Magnetic Marker Tray

MCR12	\$50

24" Magnetic Marker Tray

MCR24	\$67

Magnetic Flipchart Holder

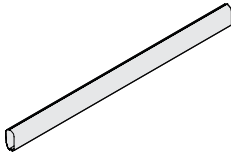

Standard Includes	Required to Specify
<ul style="list-style-type: none"> Magnetic flipchart holder: 8043 Clear anodized aluminum 	Style number

Specification Information

Dimensions		Style Number	U.S. Price
W	H		
<hr/>			

28"	2 1/2"	CFFMFH30	\$176



For Canadian Pricing

Multiply U.S. Price by the Canadian price factor.

▶ See page 1 for details.



Interactive Worktools

CopyCam Pro	74
RoomWizard II Scheduling System	78
ēno Interactive Whiteboard by PolyVision	82

CopyCam Pro

3.5 mega pixel camera arm captures handwriting and line drawings in 4 colors.

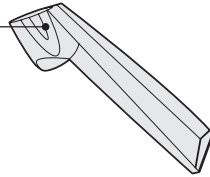

CopyCam captures a 48"H x 96"W area from any markerboard. When used with Premium Whiteboards, cables can be easily routed and concealed.

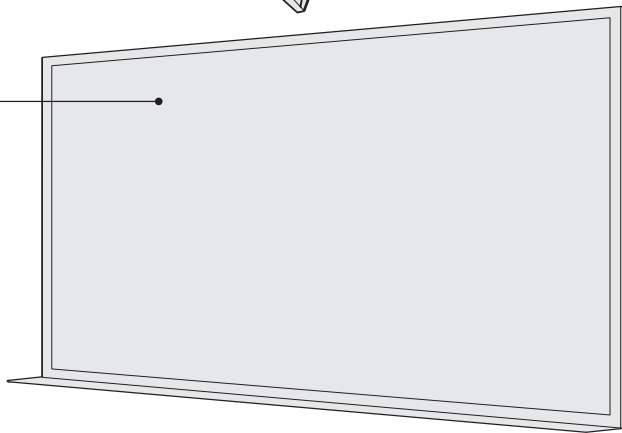

CopyCam Pro three-button control pad allows user to print, save to USB drive, or save to Local Area Network.

Optional cable management bridge conceals cables between whiteboard and CopyCam Pro control pad.

Network-enabled color printer is included.

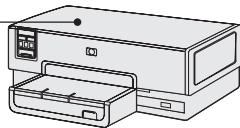

Product Details

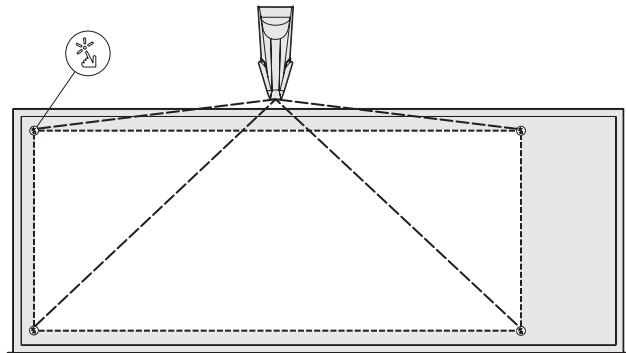

Four border buttons are provided to indicate the area that will be captured by CopyCam on boards that are wider than 8' or taller than 4'.
Tip: CopyCam will not produce a clean image from large blocks of solid color, photos, or 3D objects.
Tip: CopyCam must be installed in a location where the markerboard will have uniform illumination.

Actual Dimensions

	Width	Height	Depth
Control Pad	8 ³ / ₈ " (212.6 mm)	6 ¹ / ₈ " (155.4 mm)	1 ³ / ₄ " (44.5 mm)
Camera Arm		13 ¹ / ₂ " (342.9 mm)	38" (965.2 mm)
Mounting Bracket	7 ¹ / ₂ " (190.5 mm)	6" (152.4 mm)	
Control Pad Bridge	11 ⁷ / ₈ " (301.5 mm)		

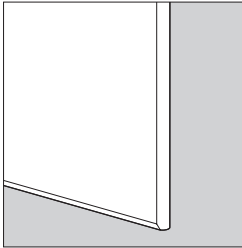

CopyCam is compatible with any markerboard or chalkboard and captures a 48"H x 96"W area. To add cable management capability, combine CopyCam with an Edge Series or other Premium Whiteboard.

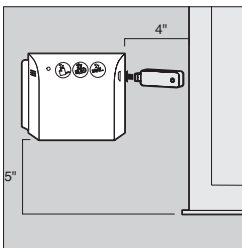

CopyCam Pro control pad may be mounted on either the left or the right side of the markerboard. When mounted on the left, the preferred distance from the edge of the markerboard to the control pad is 4", to allow access to the USB port.

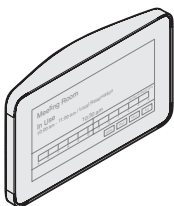

When used with RoomWizard II, One-Click Publishing sends captured whiteboard notes to all attendees via email.

▶ Page 78

Connections

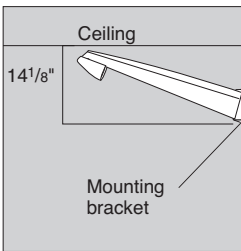

The position of the camera arm is critical to the proper function of the CopyCam lens and camera. A minimum of 14 1/8" above the board is required for installation of the camera arm. The whiteboard cannot be recessed or stand away from the wall more than four inches from the camera arm mounting bracket. The camera arm mounting bracket must be placed on the wall within four inches of the top of the whiteboard in order to focus properly.

Wiring & Cabling

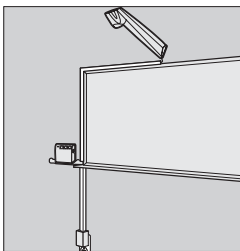

CopyCam wiring should be run within the wall for a clean installation, if possible. Wiring can also be managed against the wall if necessary with a cable raceway provided.

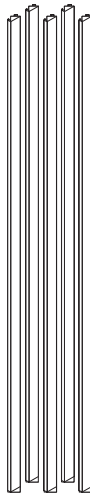

Five 4' sections of cable raceway are provided to conceal cables along one edge of the board and can be cut to length.

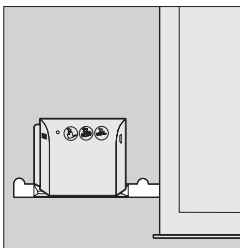

Cable management may be added between the CopyCam Pro control pad and whiteboard by specifying a cable management bridge for either the right or left side of the whiteboard.

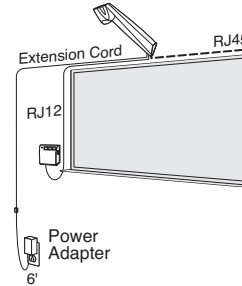

Three cable connections converge in the camera arm:

- Power adapter and its cable connect to the camera arm via a 17' extension cord.
- RJ45 ethernet cable connecting CopyCam to the Local Area Network (LAN) is not included.
- The RJ12 cable which connects the control pad to the camera arm.

Tip: The RJ12 cable is 12' long. This should be considered when using markerboards wider than 96".

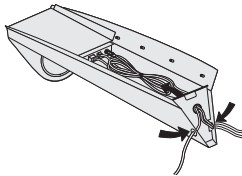

Excess cable can be stored in the camera arm cavity through by pushing the cable through the exit hole at the end of the camera arm.

Application Topics

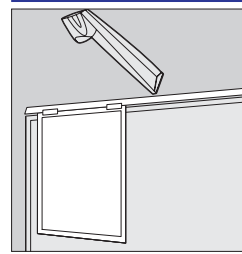

Huddleboard is a portable whiteboard solution that can be placed below the camera arm for image capture, then moved away for use elsewhere. A Huddleboard rail can be installed below the CopyCam arm and above the markerboard.

Tip: Flipcharts or other handwritten material can be attached to the markerboard and captured along with the notes written on the board.

Tip: CopyCam provides an option to exclude the printer, which meets the needs of customers who do not want image-to-print facility to accompany their CopyCam. It is not recommended that customers exclude the printer in order to use their current printers as CopyCam will not reliably process print commands to other printers.

Technical Specifications

USB Drive

- Writes images to a standard USB drive with Fat12, Fat16, or Fat32 partitions.
- Each 10MB of drive space holds approximately 70 images.

Built-in Web Server

- Holds approximately 40 images.
- Can be accessed from anywhere on a LAN using a standard web browser.
- Images are retained if there is power loss.
- Supports fixed IP addressing or DHCP protocol.

Power Requirements

100-240VAC, 50-60HZ, 18W
Energy Star Level IV compliant

Certification

FCC Class A, UL60950, CSA6095

CopyCam Pro

CopyCam Pro

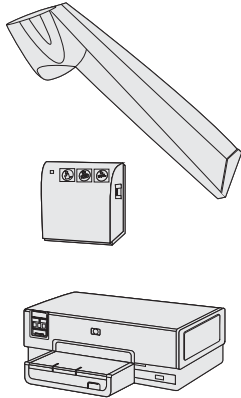

Standard Includes		Required to Specify	
<ul style="list-style-type: none"> ▶ Need help? Product details, page 74 	<ul style="list-style-type: none"> • Camera arm: champagne gold • CopyCam Pro control pad: champagne gold • Network-enabled color printer with power cable and ethernet cable • Power adapter with 6' cord • 17' power extension cord • 12' RJ12 control pad cable • Five 4' sections of cable raceway: white • Mounting plates for camera arm and control pad • Installation hardware • Installation and operation guide • Configuration CD-ROM • Calibration sheets and border buttons 	<ul style="list-style-type: none"> 1 Style number 2 Options, if selected (see below) 	
Options		U.S. Price	Required to Specify
Cable Management Bridge	• Right-side cable management bridge	+\$98	Specify <i>with right-side bridge</i> .
	• Left-side cable management bridge	+\$98	Specify <i>with left-side bridge</i> .
Printer	• Exclude printer	No cost	Specify <i>without printer</i> .
Related Products	<ul style="list-style-type: none"> • Edge Series Premium Whiteboards • RoomWizard II Room Scheduling System • Huddleboard and Photo Boards 		<ul style="list-style-type: none"> ▶ Page 20 ▶ Page 78 ▶ Page 43

Specification Information

• Style Number	• U.S. Base Price
CCPRO81	\$4208

CopyCam Pro Upgrade Kit



Tip: This kit upgrades original CopyCam, with 3½ inch floppy disk drive, to Pro Series with USB drive.

Standard Includes		Required to Specify	
<ul style="list-style-type: none"> ▶ Need help? Product details, page 74 	<ul style="list-style-type: none"> • CopyCam Pro control pad with USB: champagne gold • Firmware upgrade floppy disk • RJ12 control pad cable 	<ul style="list-style-type: none"> Style number 	

Specification Information

• Style Number	• U.S. Price
CCPRO81KIT	\$840



For Canadian Pricing

Multiply U.S. Price by the Canadian price factor.

▶ See page 1 for details.



RoomWizard II Room Scheduling System

RoomWizard II is a web-based room scheduling system with touchscreen display.

Reserve a room from any networked computer, smart phone, or RoomWizard II device.

RoomWizard II can stand alone or synchronize with systems like Microsoft Exchange, Lotus Domino servers, and several other third party software systems.

Display of the room's schedule, hostname, meeting purpose, meeting times, room details, and timeline are shown.

Touchscreen allows user to claim a room for an impromptu meeting, adjust meeting time, or end a meeting early.

Status lights are bright red and green which signal a room's availability from a distance.

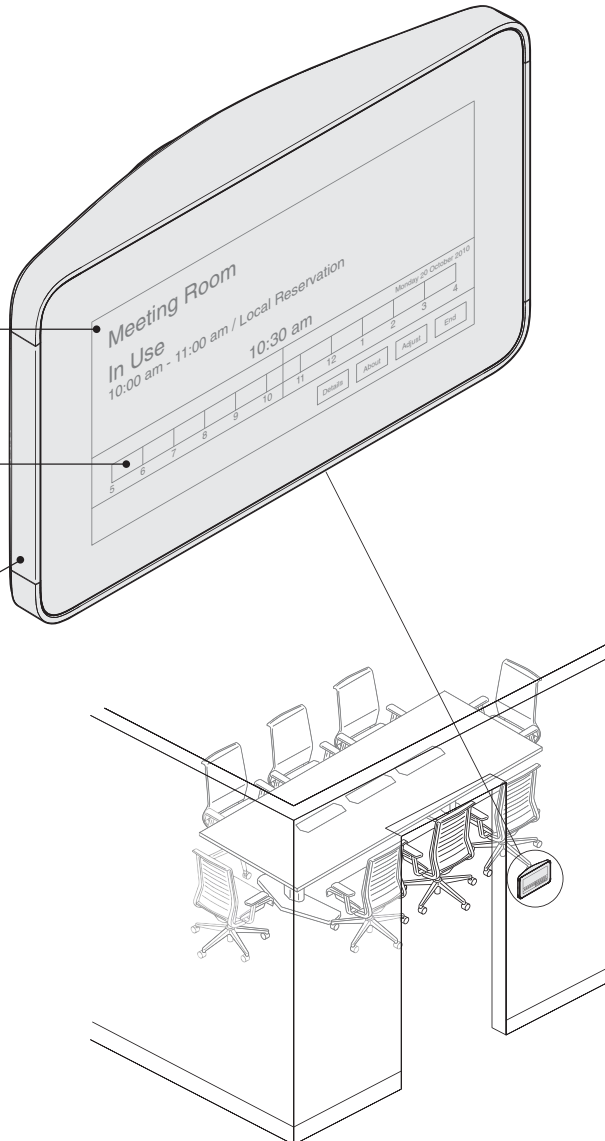

Product Details

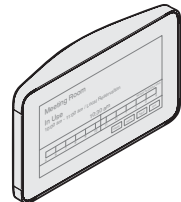

RoomWizard II comes with everything needed to operate in classic mode, as a stand-alone system with standard firmware which is included. To operate in synchronized mode, the synchronization drivers must be purchased separately.
Tip: Firmware may be automatically updated via the internet or micro USB drive.

RoomWizard II screen can be wiped clean by using a microfiber cloth.

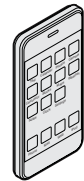

SnapTag, a downloadable iPhone app can connect with RoomWizard II to capture whiteboard notes and send to all attendees via email.

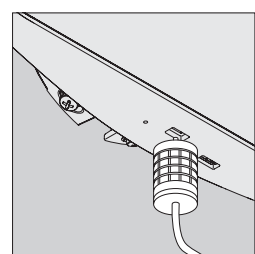

Built-in security holes allow RoomWizard II to be secured using a Kensington lock.

Actual Dimensions

Width	8 1/8"
Height	5 1/8"
Depth	2 1/4"
Installation depth with mounting bracket	2 1/4"
Diagonal screen size	7"
Weight	1 1/4 lb

Wiring & Cabling

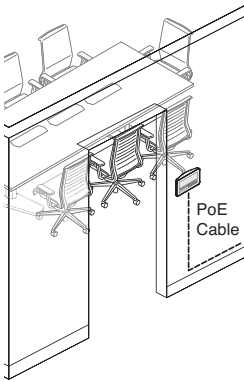

RoomWizard II connects to a network and is powered using Power over Ethernet (PoE). PoE cables run from the PoE switch typically located in the data closet. Industry standards set cable lengths at 100m. Contact your IT department to determine the PoE switch locations.

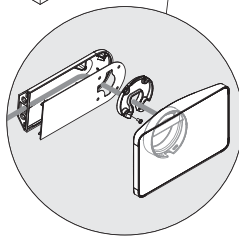
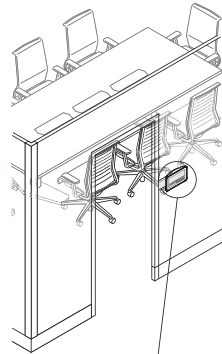

The universal mount is an option and is used to mount to architectural mullions. It can also work for glass wall applications.

Mounting Options

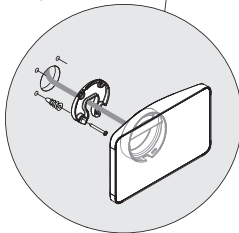
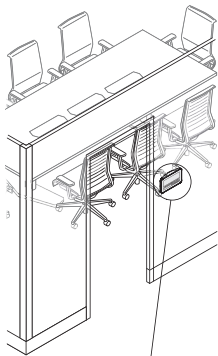

The standard mount comes with each RoomWizard II and allows it to mount directly to hard surfaces.

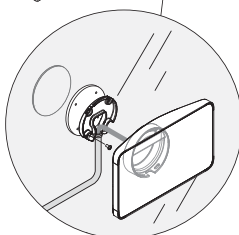
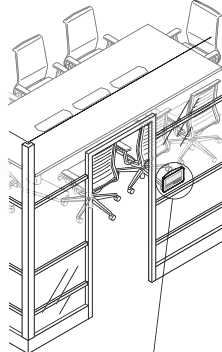

The direct-to-glass mount is an option and includes a vanity plate to visually conceal the hardware. It allows the RoomWizard II to adhere to glass surfaces.

Recommended mounting height is 54" from floor to top of unit.

Technical Specifications

Specifications

- Touchscreen: capacitive touchscreen
- Size: 7" diagonal
- Aspect ratio: 16:9
- Resolution: 800 x 430 WVGA
- Color depth: 16M colors
- Memory: 4Gb

Ethernet

- 10BaseT/100BaseTX, DHCP, IEEE 802.3U & 802.3af compliant

Power Requirements

- Power over Ethernet: 802.3af & 802.3at compliant

Environmental

- Temperature: +5° to +40°C
- Humidity: 5% to 90% RH, Non condensing

Weight

- 1 1/4 lb

Certifications

- FCC Class A, UL, CE, EMC / EMI, RoHS

Resources

- Downloadable materials** available at in2.steelcase.com/products
- RW Installation and Operation Guide
 - System Manager Guide
 - Instructions for Lotus Domino Connector Installation
 - Instructions for Microsoft Exchange Connector Installation
 - User Guide for Classic Mode
 - User Guide for Synchronized Mode

RoomWizard II Room Scheduling System

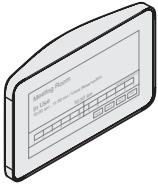

Tip: Plan for cable routing prior to installation.

Tip: Both universal mounting bracket and direct-to-glass mounting bracket work for glass wall applications.

▶ See understanding section for more information.

Standard Includes		Required to Specify
▶ Need help? Product details, page 78	<ul style="list-style-type: none"> RoomWizard II appliance RoomWizard II operating system Standard mount Installation and operation guide Standard 3 year warranty 	1 Style number 2 Options, if selected (see below)

Options	U.S. Price	Required to Specify
Extended Warranty	• Extends warranty to 5 years +\$885	Specify with extended warranty.
Mounting Options	• Universal mounting bracket • Direct-to-glass mounting bracket +\$160 +\$160	Specify with universal mounting bracket. Specify with direct-to-glass mounting bracket.

Specification Information	
Style Number	U.S. Base Price
RW20	\$2995
RW20Z	\$3200
·	·



For Canadian Pricing

Multiply U.S. Price by the Canadian price factor.

▶ See page 1 for details.

Lotus Domino Synchronization Package

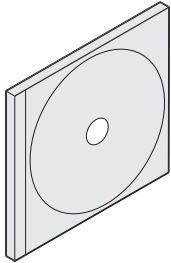

	Standard Includes	Required to Specify
▶ Need help? Product details, page 78	<ul style="list-style-type: none"> RoomWizard II driver software for synchronizing with Lotus Domino Technical support by means of a WebEx session to assist client IT personnel in installation of the synchronization driver 	Style number

Specification Information	
Style Number	U.S. Price
DTPRWS01	\$1768

Microsoft Exchange Synchronization Packages

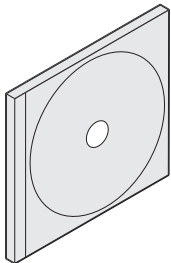

	Standard Includes	Required to Specify
▶ Need help? Product details, page 78	<ul style="list-style-type: none"> RoomWizard II driver software connector and license for synchronizing with Microsoft Exchange Technical support by means of a WebEx session to assist client IT personnel in installation of the synchronization connector 	Style number

Specification Information	
Style Number	U.S. Price
Microsoft Exchange Synchronization Package	
DTPRWS02	\$1768

Tip: The upgrade package is for customers who wish to upgrade from the 2.X Connector to the 3.X Connector. A previous license must be owned prior to the purchase of an upgrade.

Microsoft Exchange Synchronization Package Software Upgrade	
DTPRWS02U	\$ 528

Interactive Worktools

 **For Canadian Pricing**
 Multiply U.S. Price by the Canadian price factor.
 ▶ See page 1 for details.

ēno Interactive Whiteboard by PolyVision

The ēno interactive whiteboard and ēno click interactive whiteboard can be used as a conventional whiteboard with any traditional dry erase marker, or as an interactive whiteboard with the use of a projector and an ēno stylus. The ēno board installs like any conventional whiteboard. No power or cables are required.

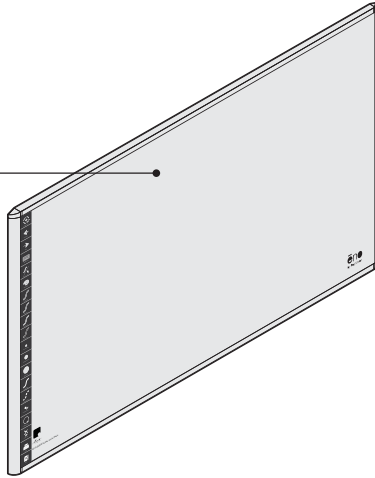

The ēno click interactive whiteboard uses magnetic mounting hardware and mounts instantly over an existing ceramic-steel chalkboard, whiteboard, or any other steel surface.

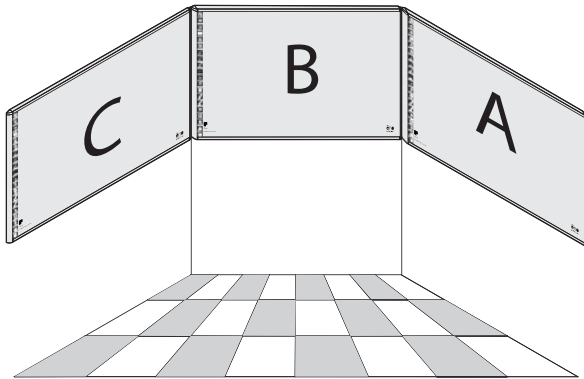
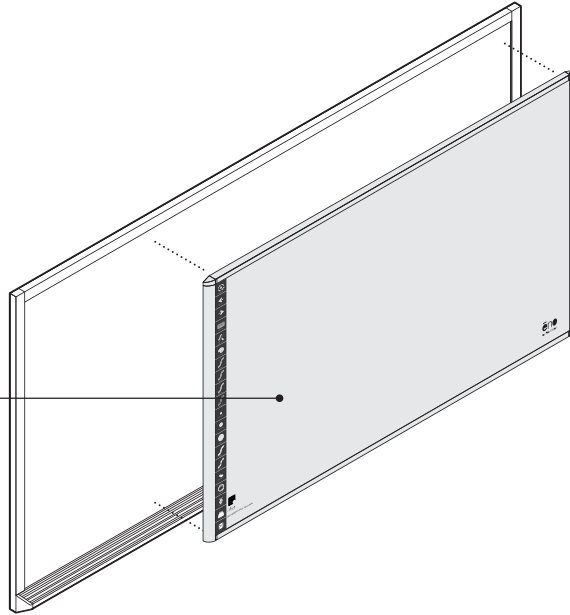

ēno interactive whiteboards are available in three different grid patterns, A, B, and C. This enables up to three boards to properly operate in the same room. ēno click interactive whiteboard is available in grid pattern A only.

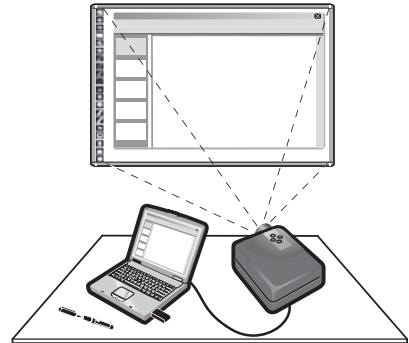

Interactive application: ēno can be used as an interactive whiteboard when used with the ēno stylus in conjunction with any Windows or Apple PC (not included with ēno) and any projector (not included with ēno). For best results short throw projectors are recommended.

Actual Dimensions

Dimensions include whiteboard frame	Depth	Width	Height
ēno 2610 interactive whiteboard	1"	64½"	48¼"
ēno 2810 interactive whiteboard	1"	85½"	48¼"
ēno 2650 click interactive whiteboard	1¼"	64½"	43¾"
ēno 2850 click interactive whiteboard	1¼"	85½"	43¾"

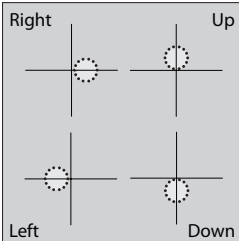
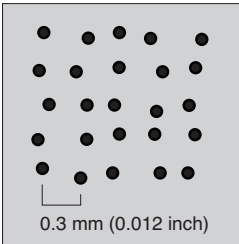
Product Details

ēno and ēno click interactive whiteboards features a pattern invisible to the naked eye. The pattern consists of numerous intelligent small black dots that can be read by the ēno stylus. The pattern indicates the exact positions of the ēno stylus.

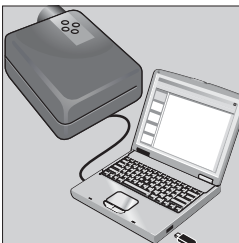

Any blue-tooth enabled computer (Apple or Windows-based) with a PolyVision driver installed can be used to in conjunction with ēno to enable interactive whiteboard capability. Any projector can be used to project images from the computer to the ēno whiteboard.

The **ēno stylus** works with the ēno whiteboard to enable interactive capability with a blue-tooth enabled computer. For example, when a computer based presentation is projected onto the ēno whiteboard, the stylus can be used to guide the presentation or interact with a computer program similar to keyboard or mouse commands.

Each ēno and ēno click interactive whiteboard

- one ēno whiteboard with one of three dot patterns. Every ēno whiteboard features the PolyVision e³ ceramicsteel writing surface
- a blue-tooth enabled stylus with one AAA battery
- two replacement stylus tips
- one blue-tooth receiver for Windows or Macintosh (USB interface)
- a PolyVision driver

Computer projector is not included.

Installation

The **ēno whiteboard** installs like any conventional whiteboard. There are no power requirements and therefore no wires. Because it transmits to the computer via blue-tooth there are no communication cable requirements.

The **ēno click interactive whiteboard** comes with magnetic mounting hardware and mounts instantly over any ceramic-steel or steel surface.

ēno and ēno click interactive performance requires the installation of a PolyVision driver on the computer and the blue-tooth receiver included with ēno. For more information on recommended computer requirements go to: <http://www.polyvision.com/ēno>

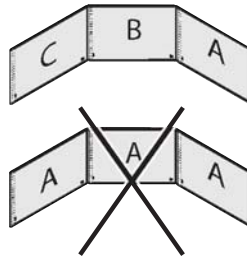
Application Topics

ēno interactive whiteboards are available with A, B, and C grid patterns which allow up to three boards to operate properly in the same room. In a multiple interactive whiteboard application, no two whiteboard grid patterns can be the same.

ēno click interactive whiteboards are available in A grid pattern only.

Environmental Certifications

- MBDC Cradle to Cradle Silver
- SCS Indoor Advantage
- RoHS

Warranty

For warranty details, go to www.polyvision.com. Warranty on system is two years. Whiteboard construction is ten years, and the writing surface is lifetime. Product registration is required for warranty to apply.

ēno Interactive Whiteboard by PolyVision

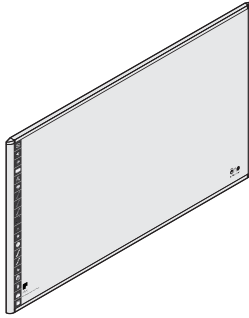

Tip: For additional information go to: PolyVision.com/ēno

Tip: ēno Interactive Whiteboards are available in three different grid patterns, A, B, and C. This enables up to three boards to properly operate in the same room. In a multiple interactive whiteboard application, no two whiteboard grid patterns can be the same.

Standard Includes	Required to Specify
<ul style="list-style-type: none"> ▶ Need help? Product details, page 82 • e³ ceramicsteel whiteboard: 8043 e³ ceramicsteel • Trim: black plastic • Blue-tooth enabled stylus • Moveable magnetic icon strip • Blue-tooth receiver for Windows or Macintosh (sub-interface) • Mounting brackets package • One AAA battery • PolyVision driver • Two replacement stylus tips • RM Easyteach Software 	<ul style="list-style-type: none"> Style number

Specification Information				
• Dimensions			• Style	• U.S.
W	D	H	Number	Price
64 ¹ / ₂ "	1 ¹ / ₈ "	48 ¹ / ₄ "	ENO2610A	\$2802
64 ¹ / ₂ "	1 ¹ / ₈ "	48 ¹ / ₄ "	ENO2610B	\$2802
64 ¹ / ₂ "	1 ¹ / ₈ "	48 ¹ / ₄ "	ENO2610C	\$2802
88 ¹ / ₂ "	1 ¹ / ₈ "	48 ¹ / ₄ "	ENO2810A	\$3493
88 ¹ / ₂ "	1 ¹ / ₈ "	48 ¹ / ₄ "	ENO2810B	\$3493
88 ¹ / ₂ "	1 ¹ / ₈ "	48 ¹ / ₄ "	ENO2810C	\$3493

Mobile Stand

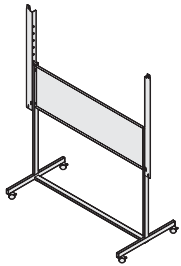

Standard Includes	Required to Specify
<ul style="list-style-type: none"> • Mobile stand: black 	<ul style="list-style-type: none"> Style number

Specification Information	
• Style Number	• U.S. Price
MS610	\$893



For Canadian Pricing

Multiply U.S. Price by the Canadian price factor.

▶ See page 1 for details.

Marker Trays

Standard Includes	Required to Specify
• Marker tray: anodized aluminum	Style number

Specification Information

• Dimensions • W	• Style • Number	• U.S. • Price
12"	MCR12	\$50
24"	MCR24	\$67
•	•	•

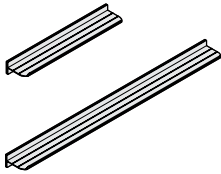

 **For Canadian Pricing**
Multiply U.S. Price by the
Canadian price factor.
▶ See page 1 for details.

ēno Click Interactive Whiteboard by PolyVision

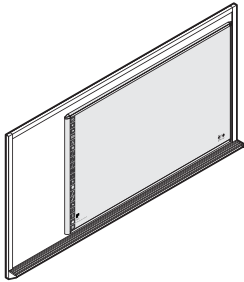

Tip: For additional information go to: PolyVision.com/ēno.

Tip: ēno click interactive whiteboards are available in A grid pattern only.

Standard Includes		Required to Specify
<ul style="list-style-type: none"> ▶ Need help? Product details, page 82 	<ul style="list-style-type: none"> • e³ ceramicsteel whiteboard: 8043 e³ ceramicsteel • Trim: black plastic • Blue-tooth enabled stylus • Moveable magnetic icon strip • Blue-tooth receiver for Windows or Macintosh (sub-interface) • Mounting brackets package • One AAA battery • PolyVision driver • Two replacement stylus tips • RM Easyteach Software 	<ul style="list-style-type: none"> Style number

Specification Information				
• Dimensions			• Style	• U.S.
W	D	H	Number	Price
64 ¹ / ₂ "	1 ¹ / ₈ "	43 ⁵ / ₈ "	ENOCCLICK2650A	\$2962
85 ¹ / ₂ "	1 ¹ / ₈ "	43 ⁵ / ₈ "	ENOCCLICK2850A	\$3673



For Canadian Pricing

Multiply U.S. Price by the Canadian price factor.

▶ See page 1 for details.

Surface Materials

Surface Materials	88
Availability Matrices	89

Surface Materials

This listing includes all surface material and/or finish choices applicable to Premium Whiteboards and Tackboards and Contractor Series. Not all surface material and/or finish choices are available on all products. Please refer to the Finish Matrices. ▶ See pages 89-92 for specific product availability.

Paint

Steelcase Surfaces

Price Group 2

- 0835 Black **E**
- 4750 Champagne Metallic
- 4798 Sterling Metallic
- 4799 Platinum Metallic

Metal Paint

Steelcase Surfaces

Price Group 2

- 8043 Clear Anodized Aluminum
- 8044 Black Anodized Aluminum

Wood

Steelcase Surfaces

Wood Trim Finishes

The wood finish is an open pore, high gloss finish on maple, cherry, or walnut. Colors match current Steelcase wood finishes in color only and do not match the Steelcase finish in sheen.

- 3412 FC/OP Natural Cherry
- 3422 FC/OP Medium Cherry
- 3572 FC/OP Amber on Maple
- 3592 FC/OP Blonde on Maple
- 3712 FC/OP Natural Walnut on Walnut
- 3772 FC/OP Medium Mahogany on Walnut

Markerboard Surface

Steelcase Surfaces

Markerboards are standard in white high-gloss 7655 e³ environmental ceramicsteel. Optional screenprint patterns are available to provide a guide for writing or drawing. See below for patterns.

Standard:

- 7655 High Gloss White

Optional Screenprint on e³ environmental ceramicsteel:

- 7656 2" Circular Dot Pattern
- 7657 2" Grid Pattern
- 7658 Music Staff Lines

Vertical Surface Fabric

Fabric Tackboard Surfaces

Tackboard surfaces are available in select Steelcase and Designtex fabrics. All fabrics are applied railroaded, i.e. salvages parallel to floor.

Steelcase Surfaces

Price Group 1

Abacus **E**

- P122 Entasis
- P123 Portico
- P124 Opus
- P125 Cusp
- P126 Artifact
- P129 Atlas

Bariolage

- G220 Etude
- G221 Andante
- G226 Cantata
- G227 Adagio
- G233 Melody
- G234 Ballata
- G235 Sonata

Select Surfaces

Designtex

For additional information and fabric samples, contact your local Designtex sales representative at 1.800.221.1540.

The following fabrics are part of the program formerly known as Designtex Graded-In. These patterns can be ordered through the Select Surfaces order full-fill model.

▶ See *Surface Materials Reference Manual* for complete Select Surfaces ordering information.

Price Group 2

- Brunswick - 6307
- Solara - 4101

Price Group 3

- Foxtrot - 6375
- Sumo - 6499

Price Group 4

- Rivergrass - 2690

Custom Surfaces

Price Group COM (Customer's Own Material)

Fabric Approval and Yardage

To confirm whether a particular COM material has already been tested for use on a specific Steelcase product or to determine actual yardage requirements:

- Visit www.steelcase.com

For additional information regarding Customer's Own Material, call 1.888.STEELCASE.

E = Established

Premium Whiteboards and Tackboards Paint and Metal Availability Matrix

		0835 Black E	4750 Champagne Metallic	4798 Sterling Metallic	4799 Platinum Metallic	8043 Clear Anodized Aluminum	8044 Black Anodized Aluminum
Senti		•	•	•	•	■	•
Edge		•	■	•	•	■	•
Access		■	■	•	•	■	•
Denska		■	•	•	•	•	•
Session (marker tray only)		•	■	•	•	•	•
FreeFlow		•	•	•	•	■	•
Huddleboard	Mobile easel	•	•	■	•	•	•
	Panel/structural tray	•	•	■	•	•	•
	Worktool rail	•	•	•	•	■	■
Combo Board		•	■	•	•	■	•
Patient Room Boards		•	■	•	•	■	•
110 Series		•	•	•	•	■	•
555 Series		•	•	•	•	■	•

Legend

- = Not available
- = Available
- = Available with exceptions
- E** = Established

Premium Whiteboards and Tackboards Wood Availability Matrix

	3412 FC/OP Natural Cherry	3422 FC/OP Medium Cherry	3572 FC/OP Amber on Maple	3592 FC/OP Blonde on Maple	3712 FC/OP Natural Walnut on Walnut	3772 FC/OP Medium Mahogany on Walnut
Senti	•	•	•	•	•	•
Edge	•	•	•	•	•	•
Access	•	•	•	•	•	•
Denska	■	■	■	■	■	■
Session	■	■	■	■	■	■
FreeFlow	•	•	•	•	•	•
Huddleboard	•	•	•	•	•	•
Combo Boards	•	•	•	•	•	•
Patient Room Boards	•	•	•	•	•	•
110 Series	•	•	•	•	•	•
555 Series	•	•	•	•	•	•

Legend

- = Not available
- = Available
- = Available with exceptions

e³ environmental ceramicsteel Whiteboard Surface

	7655 High Gloss White	7656 2" Circular Dot Pattern	7657 2" Grid Pattern	7658 Music Staff Lines
Senti	■	■	■	•
Edge	■	■	■	•
Access	■	■	■	•
Denska	■	■	■	•
Session	■	■	■	•
FreeFlow	■	■	■	•
Huddleboard	•	•	•	•
Combo Boards	■	•	•	•
Patient Room Boards	•	•	•	•
110 Series	■	•	•	■
555 Series	■	•	•	■

Legend

- = Not available
- = Available
- = Available with exceptions



Resources

Style Number Index

94

Style Number Index

Style Number	Page	Description
1MP12	69	Markers-Dry Erase
2MP12	69	Markers-Dry Erase
3MP12	69	Markers-Dry Erase
4MP12	69	Markers-Dry Erase
CACM032	27	Markerboard-Access
CACM043	27	Markerboard-Access
CACM044	27	Markerboard-Access
CACM054	27	Markerboard-Access
CACM064	27	Markerboard-Access
CACM084	27	Markerboard-Access
CACM104	27	Markerboard-Access
CACM124	27	Markerboard-Access
CACM164	27	Markerboard-Access
CACML032	51	Combo Board-Access
CACML044	51	Combo Board-Access
CACML054	51	Combo Board-Access
CACML064	51	Combo Board-Access
CACML084	51	Combo Board-Access
CACML104	51	Combo Board-Access
CACML124	51	Combo Board-Access
CACMR032	51	Combo Board-Access
CACMR044	51	Combo Board-Access
CACMR054	51	Combo Board-Access
CACMR064	51	Combo Board-Access
CACMR084	51	Combo Board-Access
CACMR104	51	Combo Board-Access
CACMR124	51	Combo Board-Access
CACT043	27	Tackboard-Access
CACT044	27	Tackboard-Access
CACT054	27	Tackboard-Access
CACT064	27	Tackboard-Access
CACT084	27	Tackboard-Access
CACT104	27	Tackboard-Access
CCPRO81	76	CopyCam Pro
CCPRO81KIT	76	CopyCam Pro
CDEM032	30	Markerboard-Denska
CDEM043	30	Markerboard-Denska
CDEM044	30	Markerboard-Denska
CDEM054	30	Markerboard-Denska
CDEM064	30	Markerboard-Denska
CDEM084	30	Markerboard-Denska
CDEM104	30	Markerboard-Denska
CDEM124	30	Markerboard-Denska
CDEM164	30	Markerboard-Denska
CEDH01827	55	Markerboard-Patient Room
CEDH21827	55	Markerboard-Patient Room
CEDHCL03627	56	Combo Board-Patient Room
CEDHCL23627	57	Combo Board-Patient Room
CEDHCR03627	56	Combo Board-Patient Room
CEDHCR23627	57	Combo Board-Patient Room
CEDM0218	22	Markerboard-Edge
CEDM032	22	Markerboard-Edge
CEDM043	22	Markerboard-Edge
CEDM044	22	Markerboard-Edge
CEDM054	22	Markerboard-Edge

Style Number	Page	Description
CEDM064	22	Markerboard-Edge
CEDM084	22	Markerboard-Edge
CEDM104	22	Markerboard-Edge
CEDM124	22	Markerboard-Edge
CEDM164	22	Markerboard-Edge
CEDML0218	49	Combo Board-Edge
CEDML032	49	Combo Board-Edge
CEDML044	49	Combo Board-Edge
CEDML054	49	Combo Board-Edge
CEDML064	49	Combo Board-Edge
CEDML084	49	Combo Board-Edge
CEDML104	49	Combo Board-Edge
CEDML124	49	Combo Board-Edge
CEDMR0218	49	Combo Board-Edge
CEDMR032	49	Combo Board-Edge
CEDMR044	49	Combo Board-Edge
CEDMR054	49	Combo Board-Edge
CEDMR064	49	Combo Board-Edge
CEDMR084	49	Combo Board-Edge
CEDMR104	49	Combo Board-Edge
CEDMR124	49	Combo Board-Edge
CEDT043	22	Tackboard-Edge
CEDT044	22	Tackboard-Edge
CEDT054	22	Tackboard-Edge
CEDT064	22	Tackboard-Edge
CEDT084	22	Tackboard-Edge
CEDT104	22	Tackboard-Edge
CFFBT	41	Bottom Rail-Freeflow Track
CFFF	40	Holder-Flipchart, Track System
CFFM064	38	Markerboard-Freeflow
CFFM084	38	Markerboard-Freeflow
CFFM104	38	Markerboard-Freeflow
CFFM124	38	Markerboard-Freeflow
CFFM164	38	Markerboard-Freeflow
CFFMFH30	40, 71	Holder-Flipchart, Magnetic
CFFSMB034	39	Markerboard-Freeflow, Double Sided
CFFSTB034	39	Tackboard-Freeflow, Double Sided
CFFT	41	Rail-Freeflow System
CPBFLM044	68	Premium Whiteboard In-Fill
CPBFLM045	68	Premium Whiteboard In-Fill
CPBFLM046	68	Premium Whiteboard In-Fill
CPBFLM054	68	Premium Whiteboard In-Fill
CPBFLM064	68	Premium Whiteboard In-Fill
CPBFLM074	68	Premium Whiteboard In-Fill
CPBFLM084	68	Premium Whiteboard In-Fill
CPBFLM094	68	Premium Whiteboard In-Fill
CPBFLM104	68	Premium Whiteboard In-Fill
CSEM043	35	Markerboard-Session
CSEM044	35	Markerboard-Session
CSEM054	35	Markerboard-Session
CSEM064	35	Markerboard-Session
CSEM084	35	Markerboard-Session
CSEM104	35	Markerboard-Session
CSEML043	53	Combo Board-Session
CSEML044	53	Combo Board-Session

Style Number	Page	Description	Style Number	Page	Description
CSEML054	53	Combo Board-Session	M1140164	61	Markerboard-110 Series
CSEML064	53	Combo Board-Session	M5540034	65	Markerboard-555 Series
CSEML084	53	Combo Board-Session	M5540043	65	Markerboard-555 Series
CSEML104	53	Combo Board-Session	M5540044	65	Markerboard-555 Series
CSEMR043	53	Combo Board-Session	M5540054	65	Markerboard-555 Series
CSEMR044	53	Combo Board-Session	M5540064	65	Markerboard-555 Series
CSEMR054	53	Combo Board-Session	M5540084	65	Markerboard-555 Series
CSEMR064	53	Combo Board-Session	M5540104	65	Markerboard-555 Series
CSEMR084	53	Combo Board-Session	M5540124	65	Markerboard-555 Series
CSEMR104	53	Combo Board-Session	M5540164	65	Markerboard-555 Series
CSET043	35	Tackboard-Session	MCR12	71, 85	Tray-Magnetic, Marker
CSET044	35	Tackboard-Session	MCR24	71, 85	Tray-Magnetic, Marker
CSET054	35	Tackboard-Session	MEP1	70	Eraser-Magnetic, with Marker Holder
CSET064	35	Tackboard-Session	MP12	69	Markers-Dry Erase
CSET084	35	Tackboard-Session	MP4	69	Markers-Dry Erase
CSET104	35	Tackboard-Session	MS610	84	ēno Mobile Stand
CSTM0218	16	Markerboard-Senti	RE1	70	Eraser-Regular
CSTM032	16	Markerboard-Senti	RW20	80	RoomWizard II Room Scheduling System
CSTM043	16	Markerboard-Senti	RW20Z	80	RoomWizard II Room Scheduling System
CSTM044	16	Markerboard-Senti	T1150034	61	Tackboard-110 Series
CSTM054	16	Markerboard-Senti	T1150043	61	Tackboard-110 Series
CSTM064	16	Markerboard-Senti	T1150044	61	Tackboard-110 Series
DTPRWS01	81	Lotus Domino Synch Package	T1150054	61	Tackboard-110 Series
DTPRWS02	81	Microsoft Exchange Synch Package	T1150064	61	Tackboard-110 Series
DTPRWS02U	81	Microsoft Exchange Synch Package Upgrade	T1150084	61	Tackboard-110 Series
ENO2610A	84	ēno Interactive Whiteboard by PolyVision	T5550034	65	Tackboard-555 Series
ENO2610B	84	ēno Interactive Whiteboard by PolyVision	T5550043	65	Tackboard-555 Series
ENO2610C	84	ēno Interactive Whiteboard by PolyVision	T5550044	65	Tackboard-555 Series
ENO2810A	84	ēno Interactive Whiteboard by PolyVision	T5550054	65	Tackboard-555 Series
ENO2810B	84	ēno Interactive Whiteboard by PolyVision	T5550064	65	Tackboard-555 Series
ENO2810C	84	ēno Interactive Whiteboard by PolyVision	T5550084	65	Tackboard-555 Series
ENOCCLICK2650A	86	ēno Click Interactive WhtBrd by PolyVision			
ENOCCLICK2850A	86	ēno Click Interactive WhtBrd by PolyVision			
ERF5	70	Felt-Replacement For Magnetic Eraser			
GCJWT48	45	Rail-Worktool			
GCJWT96	45	Rail-Worktool			
K5M2332	43	Markerboard-Small			
K5M3242	43	Markerboard-Large			
KLK	44	Grabbers-Ledge			
KME	45	Easel-Mobile			
KMGRIP	44	Grip-Marker			
KPEG	44	Pegs-Flip Chart			
KPMT36	45	Tray-Panel Mounted			
KPMT48	45	Tray-Panel Mounted			
KPMT72	45	Tray-Panel Mounted			
KSM2332	43	Markerboard-Small			
KSM3242	43	Markerboard-Large			
M1140034	61	Markerboard-110 Series			
M1140043	61	Markerboard-110 Series			
M1140044	61	Markerboard-110 Series			
M1140054	61	Markerboard-110 Series			
M1140064	61	Markerboard-110 Series			
M1140084	61	Markerboard-110 Series			
M1140104	61	Markerboard-110 Series			
M1140124	61	Markerboard-110 Series			

Trademark List

- ® The following are registered trademarks for products of Steelcase Inc. or one of its related corporate entities: 4 o'clock, 900 Series, à la carte, Airtouch, Ally, Amia, Answer, Archipelago, Avenir, Ballet, Bix, Brayton International, Cachet, Canopy, Canto, Chancellor, Coalesse, Confidante, Context, Convene, CopyCam, Criterion, Crushed Can, Currency, Designtex, Details, Detour, Drive, Elective Elements, Ellipse, Ember Chrome, Emerge, E-Table 2, FYI, Garland, Gentry, Ginkgo Biloba, Groupwork, Ideo, Jacket, Jenny, Jersey, Kart, Kick, LaCosta, Leap, Let's B, LiveBack, Max-Stacker, Metro, Migrations, Mitra, Montage, Nurture, Oriana, Parade, Pathways, PCT, Permiso, Player, PolyVision, Portal, Power Pincher, Progeny, Protégé, R2, Rally, Relevant, Reply, Rizzi Arc, Sensor, Series 9000, Siento, Sieste, Sine, Softcare, Springboard, Steelcase, Steelcase Design Partnership, Stella, Stow Davis, Swathmore, TeamWork, Technique, Texpress, Think, Thunder, Topo, Train, Turnstone, Underline, Unison, Vecta, Viridian, Walden, Werndl, and X-Stack.
- ® The following are a registered trademarks of AWI Licensing Company, Dover, DE: SoundScapes, DuraBrite, BioBlock, and Armstrong.
- ® The following registered trademarks are under license from Byrne Electrical, Rockford, MI: Interport and Mini-Port.
- ® The following is a registered trademark of DuPont, Wilmington, DE: Corian.
- ® The following is a registered trademark of Genlyte Thomas Company, Louisville, KY: Lightolier.
- ® The following is a registered trademark of Hilti Corporation, FL-9494 Schaan, Principality of Liechtenstein: Hilti.
- ® The following is a registered trademark of Leviton Manufacturing Company, Little Neck, NY: Decora.
- ® The following is a registered trademark of Mechanical Plastics Corp, Elmsford, NY: Toggle.
- ® The following is a registered trademark of Microsoft Corporation, Redmond, WA: Microsoft.
- ® The following is a registered trademark of Panduit Corporation, Lockport, IL: Panduit.
- ® The following is a registered trademark of Trav (Press), Cuneo, Italy: Assisa.
- ® The following is a registered trademark of Virtual Ink, Boston, MA: mimioActive.
- ® The following registered trademarks are under license from Wilkhahn Furniture Products: Avera, Senzo, Versal, and Wilkhahn FS.
- ® The following is a registered trademark of Wilsonart International, Temple, TX: Chemsurf.
- ® The following is a registered trademark of Wiremold, West Hartford, CT: Wiremold.

- ® The following is a registered trademark of EMU Group S.P.A., Perugia, Italy: Emu
- ™ The following are trademarks for products of Steelcase Inc. or one of its related corporate entities: Access, Active/Passive Shelf, Ainsley, Akira, Alcove, Alerion, ailight, Amaris, American Elect, American Tradition, Answer, ap40, Arbor, Arriva, Asana, Ascot, Aspekt, Astor, Await, Bira, Bottomline, Brook, Burton, c:scape, Calla, Calm, Camber, Campfire, Capa, Cappuccino, Cesar, Chester, Chord, Circa, Clarendon, Classic Rectangular, cobi, Collaboration, Community, Company, Convey, Cortex, Coupe, Crea, Crew, Cura, Cypress, Davenport, Dearborn, Deck, Déjà, Denizen, Denska, Derby, Donovan, Dune, Duo, e³, e³ ceramicsteel, e³ environmental ceramicsteel, Echo, Edge, Elсна, Empress, Enea, ēno, EnSync, Enviro, Escapade, Exchange, Exponents, Field, Flat Top, FlexFrame, Flip Top, Flute, Folio, FreeFlow, Frontier, Galilei, Ginger, Ginkgo, Go Wall, Grip, Groove, Hatchback, Hawthorne, Hitch, Host Collection, Huddleboard, i2i, Impact, Indy, InfoLink, IOS, I-Solve, Jack, Jarrah, Jetty, Juice, Kami, Kast, Kathryn, Lark, L'Attitude, LearnLab, Leela, Lincoln, Linden, LiveSeat, Loria, Lyric, Malibu, Malibu Too, Mansfield, Marathon, Martini, Mason, Masque, media:scape, Mineral, Mingle, Mystic, Mystic Metal, Mystic Wood, Montreal, Move, Nadia, Neighbor, nesso, Nickel, Nikko, Nod, node, Norfolk, Ontrak, Oom, Opus, Orchid, Outlook Collection, Ovation, Paloma, Paperflo, Parliament, Pasio, Passarelle, Patriarch, Payback, Peek, Pile File, Pisa, Pool, PUCK, Quba, Rave, Reed, Reunion, Ripple, Riser, Rocco, Rocky, RoomWizard, Runner, Satellite, Sawyer, Senti, Sentinel, Senza, Sequoia, Session, ShareLink, Shield, Sidewalk, Skylar, Slumber, Smoke, Snug, Soft Leaf, Sonata, Sorrel, SOTO, Stationkits, Stiletto, Surprise!, Switch, Symphony, Sync, Tava, Tenaro, Terrazzo, Theorem, Topaz, Touchdown, Tour, Tower Too, Trees, Trillium, Trolly, tX2, U-Free, Uno, Verge, Waldorf, Woodruff, Workspring, and X-tenz.
- ™ The following is a trademark of Microsoft Corporation, Redmond, WA: Windows.
- ™ The following is a trademark of Rodman Industries, Inc., Oconomowoc, WI: ResinCore1.
- ™ The following is a trademark of Ultrafabrics, LLC, Elmsford, NY: Ultraleather.
- ™ The following trademarks are used under license from Wilkhahn Furniture: Cana, Linus, Logon, Picto, Range, Stitz, Thema, Timetable, and Tubis.
- ™ The following is a trademark of MBDC, Charlottesville, VA: Cradle to Cradle.
- ™ The following trademarks are under license from Walter Knoll: Andoo, Bob, Lazlo, Ribbon, and Together
- ™ The following trademarks are under license from PP Mobler: Bar and Flag Halyard.

- ™ The following trademarks are under license from Viccarbe: Davos, Holy Day, Last Minute, RS, and Wrapp.
 - ™ The following trademarks are under license from Carl Hansen: Elbow, Paddle, Shell, Wing, and Wishbone.
 - ™ The following trademarks are under license from Cambridge Sound Management, LLC, Cabridge, MA: Qt PRO Soundmasking and Qt Quite Technology.
 - ™ The following is a trademark of Electri-Cable Assemblies, Shelton, CT: Interact.
- Trademarks used here in are the property of Steelcase, Inc. or of their respective owners.*