



**TDS3000 & TDS3000B
Operator Training Kit Manual**

071-1051-00

This product training document file is protected by Copyright © Tektronix, Inc. All rights reserved.

End users of this Tektronix product training document file are permitted to print any portion of this file or copy the electronic file for personal use. Print or electronic reproduction of this product training document file for resale is strictly prohibited.

Tektronix, Inc., P.O. Box 500, Beaverton, OR 97077

TEKTRONIX and TEK are registered trademarks of Tektronix, Inc.

WARRANTY

Tektronix warrants that the parts, assemblies and supplies (“products”) that it manufactures and sells will be free from defects in materials and workmanship for a period of three (3) months from the date of shipment. If a product proves defective during this warranty period, Tektronix, at its option, either will repair the defective product without charge for parts and labor, or will provide a replacement in exchange for the defective product.

In order to obtain service under this warranty, Customer must notify Tektronix of the defect before the expiration of the warranty period and make suitable arrangements for the performance of service. Customer shall be responsible for packaging and shipping the defective product to the service center designated by Tektronix, with shipping charges prepaid. Tektronix shall pay for the return of the product to Customer if the shipment is to a location within the country in which the Tektronix service center is located. Customer shall be responsible for paying all shipping charges, duties, taxes, and any other charges for products returned to any other locations.

This warranty shall not apply to any defect, failure or damage caused by improper use or improper or inadequate maintenance and care. Tektronix shall not be obligated to furnish service under this warranty a) to repair damage resulting from attempts by personnel other than Tektronix representatives to install, repair or service the product; b) to repair damage resulting from improper use or connection to incompatible equipment; c) to repair any damage or malfunction caused by the use of non-Tektronix supplies; or d) to service a product that has been modified or integrated with other products when the effect of such modification or integration increases the time or difficulty of servicing the product.

THIS WARRANTY IS GIVEN BY TEKTRONIX IN LIEU OF ANY OTHER WARRANTIES, EXPRESS OR IMPLIED. TEKTRONIX AND ITS VENDORS DISCLAIM ANY IMPLIED WARRANTIES OF MERCHANTABILITY OR FITNESS FOR A PARTICULAR PURPOSE. TEKTRONIX’ RESPONSIBILITY TO REPAIR OR REPLACE DEFECTIVE PRODUCTS IS THE SOLE AND EXCLUSIVE REMEDY PROVIDED TO THE CUSTOMER FOR BREACH OF THIS WARRANTY. TEKTRONIX AND ITS VENDORS WILL NOT BE LIABLE FOR ANY INDIRECT, SPECIAL, INCIDENTAL, OR CONSEQUENTIAL DAMAGES IRRESPECTIVE OF WHETHER TEKTRONIX OR THE VENDOR HAS ADVANCE NOTICE OF THE POSSIBILITY OF SUCH DAMAGES.

General Safety Summary

Review the following safety precautions to avoid injury and prevent damage to this product or any products connected to it. To avoid potential hazards, use this product only as specified.

While using this product, you may need to access other parts of the system. Read the *General Safety Summary* in other system manuals for warnings and cautions related to operating the system.

To Avoid Fire or Personal Injury

Connect and Disconnect Properly. Do not connect or disconnect probes or test leads while they are connected to a voltage source.

Connect the ground lead of the probe to earth ground only.

Replace Batteries Properly. Replace batteries only with the proper type and rating specified.

Use Proper AC Adapter. Use only the AC adapter specified for this product.

Use Proper Fuse. Use only the fuse type and rating specified for this product.

Avoid Exposed Circuitry. Do not touch exposed connections and components when power is present.

Do Not Operate With Suspected Failures. If you suspect there is damage to this product, have it inspected by qualified service personnel.

Do Not Operate in Wet/Damp Conditions.

Do Not Operate in an Explosive Atmosphere.

Keep Product Surfaces Clean and Dry.

Safety Terms and Symbols

Terms in This Manual. These terms may appear in this manual:



WARNING. *Warning statements identify conditions or practices that could result in injury or loss of life.*



CAUTION. *Caution statements identify conditions or practices that could result in damage to this product or other property.*

Terms on the Product. These terms may appear on the product:

DANGER indicates an injury hazard immediately accessible as you read the marking.

WARNING indicates an injury hazard not immediately accessible as you read the marking.

CAUTION indicates a hazard to property including the product.

Symbols on the Product. These symbols may appear on the product:



CAUTION
Refer to Manual



Standby



Contacting Tektronix

Phone 1-800-833-9200*

Address Tektronix, Inc.
Department or name (if known)
14200 SW Karl Braun Drive
P.O. Box 500
Beaverton, OR 97077
USA

Web site www.tektronix.com

Sales support 1-800-833-9200, select option 1*

Service support 1-800-833-9200, select option 2*

Technical support Email: techsupport@tektronix.com
1-800-833-9200, select option 3*
1-503-627-2400
6:00 a.m. - 5:00 p.m. Pacific time

* **This phone number is toll free in North America. After office hours, please leave a voice mail message. Outside North America, contact a Tektronix sales office or distributor; see the Tektronix web site for a list of offices.**

Table of Contents

Getting Started With TDS3000 Oscilloscopes	1-1
Introduction to TDS3000 Oscilloscopes.....	1-3
Features of the TDS3000 Models	1-3
Differences Between the TDS3000 Models	1-5
Primary Front Panel Control Sections	1-9
VERTICAL Section Controls.....	1-10
HORIZONTAL Section Controls	1-20
TRIGGER Section Controls.....	1-24
ACQUIRE Section Controls.....	1-33
Other Controls	1-40
Menu Function Controls.....	1-42
MEASURE Menu Function Controls	1-43
SAVE/RECALL Menu Function Controls.....	1-46
QUICKMENU Function Controls	1-50
CURSOR Menu Function Controls.....	1-50
DISPLAY Menu Function Controls	1-52
UTILITY Menu Function Controls	1-55
Setting Up a TDS3000 Oscilloscope	1-59
Grounding an Oscilloscope	1-59
Safety Precautions	1-61
Introduction to the Training 1 Signal Board	1-63
Probe Compensation.....	1-67
Summary	1-72
Using VERTICAL Controls	2-1
Setting Up VERTICAL Controls	2-2

Operating VERTICAL Controls	2-5
Using VERTICAL Controls to Modify Acquisition and Display	2-5
Working with Channel Displays	2-9
Switching the Input Coupling	2-12
Using Vertical Offset Controls	2-15
Using the MATH Menu	2-20
Summary	2-24
Using HORIZONTAL Controls	3-1
Setting Up HORIZONTAL Controls	3-2
Operating HORIZONTAL Controls	3-6
Affecting the Acquisition and Display of a Waveform.....	3-7
Changing the Zoom Mode Limits	3-12
Delaying the Acquisition of a Waveform.....	3-15
Summary	3-22
Using TRIGGER Controls	4-1
Setting Up TRIGGER Controls	4-2
Operating TRIGGER Controls	4-6
Using Edge Triggering	4-6
Using Variable Trigger Holdoff	4-10
Assigning Trigger Holdoff for an AM Signal	4-12
Summary	4-16
Using ACQUIRE Controls	5-1
Setting Up ACQUIRE Controls	5-2
Operating ACQUIRE Controls	5-7
Displaying Hidden Waveform Details	5-7
Stopping the Acquisition System	5-9
Using the Average and Envelope Acquisition Modes ...	5-12
Step Response	5-16
Summary	5-22

Using Menu Function Controls.....	6-1
Setting Up Menu Function Controls.....	6-2
Operating the Menu Function Controls.....	6-4
MEASURE Menu Function Controls	6-4
SAVE/RECALL Menu Function Controls.....	6-16
QUICKMENU Function Control	6-22
CURSOR Menu Function Controls.....	6-25
DISPLAY Menu Function Controls	6-28
UTILITY Menu Function Controls	6-41
Summary	6-44
Appendix A: Training 1 Signal Board: Signal Definitions.....	A-1
Appendix B: Glossary.....	B-1

1

Getting Started With TDS3000 Oscilloscopes

This module introduces the TDS3000 series of digital phosphor oscilloscopes (DPO). In this module, you will learn about the basic features, specifications, and controls of a TDS3000 oscilloscope.

Note: *All references to TDS3000 oscilloscopes also apply to TDS3000B oscilloscopes, except as specified.*

At the end of this module, you will be able to:

- Identify the primary front panel and the menu-based controls of a TDS3000 oscilloscope.
- Set up a TDS3000 oscilloscope for general use.
- Compensate a passive probe.

This module includes the following sections:

- Introduction to TDS3000 Oscilloscopes
- Primary Front Panel Control Sections
- Menu Function Controls
- Setting Up a TDS3000 Oscilloscope

Figure 1.1 shows a TDS3000 oscilloscope.

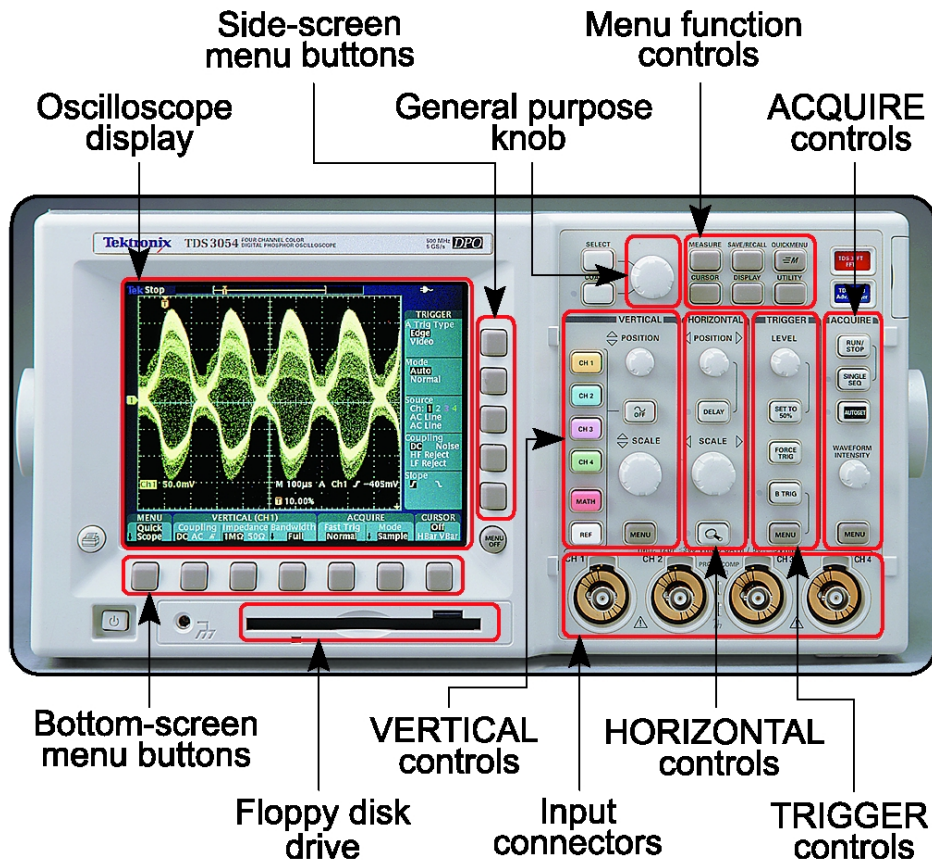

Figure 1.1: A TDS3054 digital phosphor oscilloscope

1

Getting Started With TDS3000 Oscilloscopes

Introduction to TDS3000 Oscilloscopes

A TDS3000 oscilloscope is an advanced DPO (Digital Phosphor Oscilloscope) that you can use for various applications, such as servicing, repairing, manufacturing, testing, and designing systems that include embedded, computing, and communication systems.

Features of the TDS3000 Models

The following are the basic features of the TDS3000 series of oscilloscopes:

High bandwidth

The TDS3000 series of oscilloscopes have a bandwidth, ranging from 100 MHz to 500 MHz.

Fast sample rate

The TDS3000 series of oscilloscopes have sample rates, ranging from 1.25 GS/s to 5 GS/s on all channels simultaneously.

Enhanced display

The TDS3000 series of oscilloscopes have a color LCD display that shows all 4 channels at the same time, in different colors.

1

Getting Started With TDS3000 Oscilloscopes

Waveform and instrument setup storage

The TDS3000 series of oscilloscope models have a built-in floppy drive. The floppy drive can be used to store waveforms, screen images, and instrument setups on a 1.44 MB IBM PC-compatible floppy disk.

Flexibility

You can install a variety of application and communication modules to expand the capabilities of a TDS3000 oscilloscope according to your requirements. For example, you can install application modules for FFT operations, extended video triggering, and telecommunications signal mask testing. You can also install communication modules to provide GPIB, RS-232, VGA, and Ethernet modules.

Differences Between the TDS3000 Models

The TDS3000 series of oscilloscopes consists of six base models. The following table lists the primary differences between them (these models include the TDS3000B models as well):

Models	Number of Channels	Bandwidth	Maximum Sample Rate
TDS3012	2	100 MHz	1.25 GS/s
TDS3014	4	100 MHz	1.25 GS/s
TDS3032	2	300 MHz	2.25 GS/s
TDS3034	4	300 MHz	2.25 GS/s
TDS3052	2	500 MHz	5 GS/s
TDS3054	4	500 MHz	5 GS/s

1

Getting Started With TDS3000 Oscilloscopes

Preliminary Functional Check

Perform the following functional check procedure on a TDS3000 oscilloscope to verify that it is functioning properly.

1. Connect your TDS3000 oscilloscope to an AC supply using the appropriate power cord and adapters.
2. On the lower-left corner of the front panel of the oscilloscope, push the **ON/STANDBY** button.

Wait until the display shows that the oscilloscope has passed all self tests.
3. On the top of the front panel, push the **SAVE/RECALL** menu button.
4. Push the appropriate bottom-screen menu button to select **Recall Factory Setup**.

5. Push the appropriate side-screen menu button to select **OK Confirm Factory Init**.
6. In the **VERTICAL** section, push the **MENU** button to activate the menu for Channel 1.
7. Connect a P6139A passive voltage attenuation probe to the **CH1** input connector.
8. Attach the CH1 probe tip and the ground lead to **PROBE COMP** and the ground connectors, respectively.
9. In the ACQUIRE section, push the **AUTOSET** button.

1

Getting Started With TDS3000 Oscilloscopes

You should see a waveform similar to that shown in Figure 1.2.

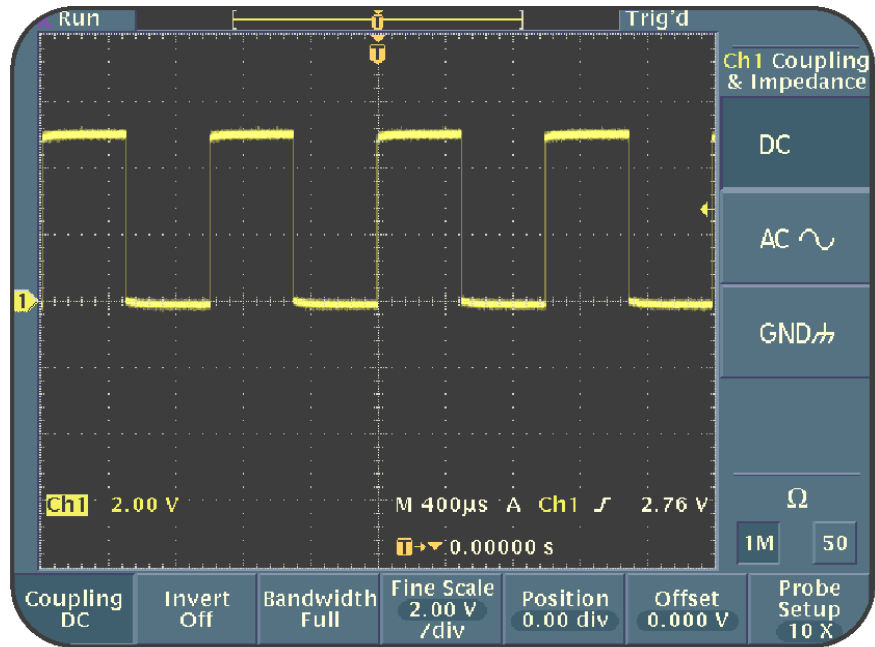

Figure 1.2: Square waveform

Your oscilloscope has passed the preliminary functional check if you observe a square wave similar to the waveform shown in Figure 1.2 for channel 1.

Primary Front Panel Control Sections

This section describes the primary front panel controls. You can use these controls to setup signal acquisition and display. In this section, you will learn about the following:

- VERTICAL Section Controls
- HORIZONTAL Section Controls
- TRIGGER Section Controls
- ACQUIRE Section Controls
- Other Controls

Each section consists of knob(s) and buttons. When you push the MENU button in each control section, the associated menu is activated at the bottom of the oscilloscope display.

1

Getting Started With TDS3000 Oscilloscopes

You control each menu option by pushing the associated bottom-screen menu button. You control the submenu for each menu option by pushing the associated side-screen button.

VERTICAL Section Controls

This topic describes the VERTICAL section controls. You can use the VERTICAL controls to set or modify the waveform vertical scale, position, input coupling, bandwidth, and other signal conditioning.

Figure 1.3 shows the VERTICAL section controls of a TDS3000 oscilloscope.

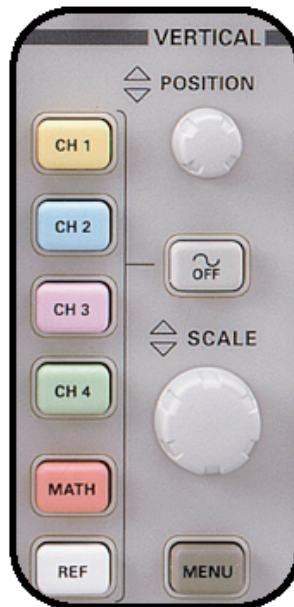

Figure 1.3: TDS3000 VERTICAL section controls

Note: The two-channel TDS3000 oscilloscopes do not have the CH3 and CH4 buttons.

1

Getting Started With TDS3000 Oscilloscopes

The VERTICAL controls are divided into the following three subsections:

- Dedicated controls
- Menu-based controls
- MATH menu controls

Dedicated Controls

The dedicated controls in the VERTICAL section include the following:

- VERTICAL **POSITION** knob
- VERTICAL **SCALE** knob
- Channel selection (**CH1**, **CH2**, **CH3**, and **CH4**) and reference waveform selection (**REF**) buttons
- Waveform **OFF** button

VERTICAL POSITION knob

The VERTICAL POSITION knob allows you to adjust the vertical position of a displayed waveform up and down on the oscilloscope display. When you change the vertical position of a waveform, the expansion reference arrow at the left of the selected waveform follows the change in position.

In addition, if that channel is selected as the trigger, then the trigger level arrow at the right of the screen also follows the change in position of the waveform.

OFF button

The OFF button removes a selected waveform from the oscilloscope display. To remove a waveform, select the waveform by pushing the appropriate channel selection button and then push the waveform OFF button.

VERTICAL SCALE knob

The VERTICAL SCALE knob adjusts the vertical scale of the selected displayed waveform. The vertical voltage scale is typically measured in volts/division. For example, if the volts/div setting is 2 volts, then each division on the vertical axis of the display graticule represents 2 volts. Therefore, an entire graticule of eight vertical divisions can display 16 volts when the volts/div setting is 2 volts.

Note: *The vertical scale can also be amperes/division for a current probe or watts/division for a MATH function.*

1

Getting Started With TDS3000 Oscilloscopes

Channel selection and reference waveform selection buttons

The channel selection (CH1, CH2, CH3, and CH4) buttons allow you to select and display a waveform. The reference waveform selection (REF) button allows you to select a waveform reference location to which you can save or recall waveform data. You can push the REF button to display the reference waveform menu. Then you can push a bottom-screen menu button to display a reference waveform. The REF menu is also used to save active waveforms to reference waveform memory. You can also save a MATH waveform as a reference waveform.

Menu-based Controls

A TDS3000 oscilloscope provides many menu-based options for VERTICAL controls. For example, you can use the bottom-screen and side-screen menu-based VERTICAL controls to select various options, such as the input coupling type, bandwidth limit of the channel, offset, and input signal inversion.

To activate the VERTICAL menu-based functions for a channel, follow these steps:

1. In the VERTICAL section, push the **CH1** button.
2. In the **VERTICAL** section, push the **MENU** button.

Figure 1.4 shows the channel 1 menu at the bottom of the display.

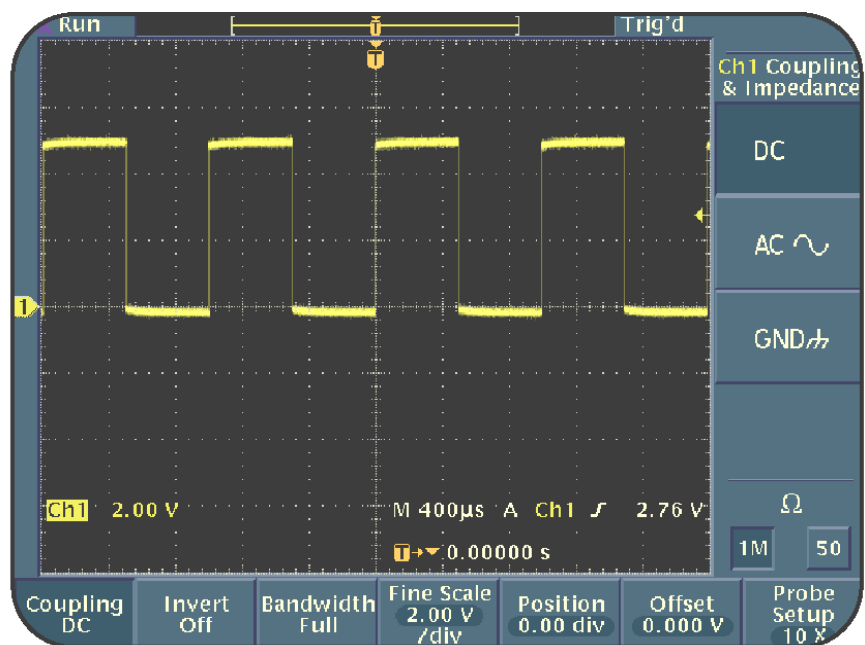

Figure 1.4: VERTICAL menu-based options for CH1

1

Getting Started With TDS3000 Oscilloscopes

Menu Option	Description
Coupling	You use this option to select DC, AC, or Ground coupling. You can also select an input resistance for DC or AC coupling.
Invert	You use this option to invert the polarity of the displayed waveform.
Bandwidth	You use this option to set the oscilloscope bandwidth to Full (maximum oscilloscope frequency), 150 MHz or 20 MHz. However, 100 MHz TDS3000 models do not provide a bandwidth of 150 MHz.
Fine Scale	You use this option to enable a fine scale adjustment of the vertical scale with the general purpose knob.

Position	You use this option to adjust the vertical position of a waveform with the general purpose knob.
Offset	You use this option to numerically adjust the waveform vertical offset with the general purpose knob.
Probe Setup	You use this option to set the probe readout conditions for probes that do not have the TekProbe II interface. You can also use this option to adjust the time skew for probes.

MATH Menu Controls

The MATH menu controls allow you to perform various math operations, such as addition and subtraction, on the displayed waveforms. You can also perform FFT operations on the displayed waveforms if the TDS3FFT application module is installed on your TDS3000 oscilloscope.

Note: *All TDS3000B oscilloscopes include the TDS3FFT application module.*

1

Getting Started With TDS3000 Oscilloscopes

To activate the MATH menu controls, perform the following step:

- In the VERTICAL section, push the **MATH** button.

The MATH menu is activated at the bottom of the display.

Figure 1.5 shows the TDS3000 oscilloscope MATH menu-based controls.

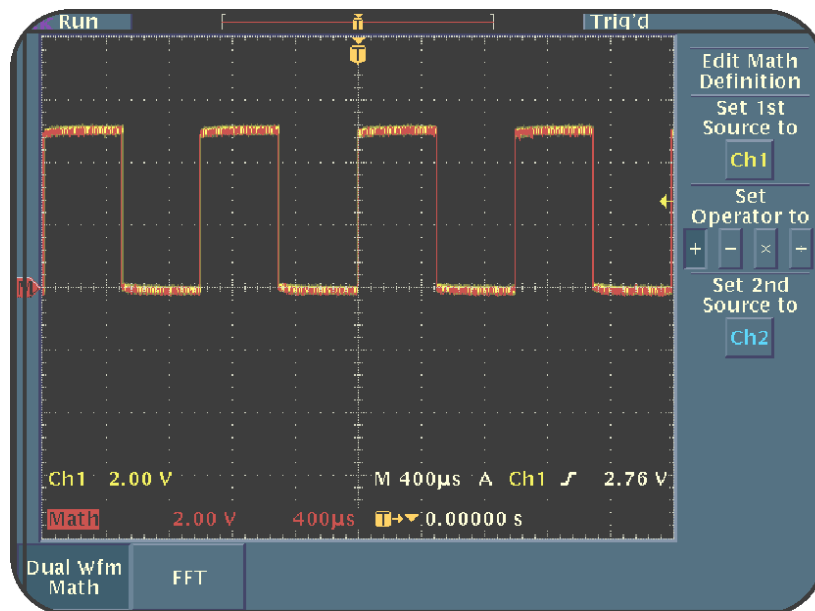

Figure 1.5: TDS3000 oscilloscope MATH menu-based controls

The MATH menu provides the following options on the bottom-screen and associated side-screen menus:

Dual Wfm Math

You use this option to select the source waveforms and the math operation to be performed.

For procedures using the VERTICAL controls, see *Using VERTICAL Controls* starting on page 2-1.

1

Getting Started With TDS3000 Oscilloscopes

HORIZONTAL Section Controls

This topic describes the HORIZONTAL section controls. You use the HORIZONTAL controls to modify the horizontal scale of the display, which represents the time base of a displayed waveform. You can also use the HORIZONTAL controls to adjust the trigger position and examine a waveform in detail.

Figure 1.6 shows the HORIZONTAL section controls of a TDS3000 oscilloscope.



Figure 1.6: TDS3000 HORIZONTAL section controls

The HORIZONTAL section on the front panel includes the following controls:

- HORIZONTAL **POSITION** knob
- **DELAY** button
- HORIZONTAL **SCALE** knob
- Zoom button

HORIZONTAL POSITION knob

The HORIZONTAL POSITION knob allows you to adjust the waveform horizontal position. You can also use the HORIZONTAL POSITION knob to move the trigger position of a displayed waveform to full pre-trigger, full post-trigger, or any point in between. The horizontal expansion point is the selected trigger position within the acquisition, and is indicated by the 'down arrow' symbol on screen.

1

Getting Started With TDS3000 Oscilloscopes

Note: *A full pre-trigger setting sets the trigger position of a waveform near 100% of a record, while a full post-trigger setting sets the trigger position near 0% of a record. This trigger position selection is possible only when the default HORIZONTAL **DELAY** function is turned off, as explained in the next paragraph. The pre-trigger percentage appears at the bottom of the display.*

DELAY button

The DELAY button allows you to delay the acquisition relative to the trigger event with the HORIZONTAL POSITION knob. An indicator light next to the DELAY button indicates whether delay is on or off. When delay is on, the horizontal expansion point stays in the center of the display while the trigger point can move off the display.

The time difference between the trigger point and the horizontal expansion point is the delay time of the acquisition. You turn the HORIZONTAL POSITION knob counter-clockwise to increase the delay time. The delay time is referenced to the center of the acquisition, and appears at the bottom of the display.

HORIZONTAL SCALE knob

The HORIZONTAL SCALE knob allows you to adjust the time base of the displayed waveform. When delay is off, you adjust the scale to expand or contract around the trigger point. When delay is on, you adjust the scale to expand or contract around the center of the screen.

ZOOM button

The zoom button magnifies a displayed waveform along the horizontal axis of the display. An indicator light next to the zoom button indicates whether zoom is on or off. You use the HORIZONTAL SCALE knob to adjust the magnification and the HORIZONTAL POSITION knob to select the portion of the waveform that you want to magnify.

For procedures using the HORIZONTAL controls, see *Using HORIZONTAL Controls* starting on page 3-1.

1

Getting Started With TDS3000 Oscilloscopes

TRIGGER Section Controls

This topic describes the TRIGGER section controls. You use the TRIGGER controls to set the trigger threshold conditions for a signal and assign a holdoff time to the trigger. Figure 1.7 shows the TRIGGER section controls of a TDS3000 oscilloscope.



Figure 1.7: TDS3000 TRIGGER section controls

Warning: If the oscilloscope is incorrectly triggered, the display may not represent the signal connected to the probe. The display may instead show a previous safe reading, when a dangerous voltage is actually connected to the input.

The TRIGGER section on the front panel includes the following controls:

- **TRIGGER LEVEL** knob
- **SET TO 50%** button
- **FORCE TRIG** button
- **B TRIG** button
- **TRIGGER MENU** button

TRIGGER LEVEL knob

The TRIGGER LEVEL knob allows you to adjust the trigger level of a displayed waveform. When you change the trigger level, a horizontal line appears temporarily on the oscilloscope display. This horizontal line indicates the trigger level.

SET TO 50% button

The SET TO 50% button sets the trigger level to 50% of the peak-to-peak amplitude of the source trigger waveform.

1

Getting Started With TDS3000 Oscilloscopes

FORCE TRIG button

The FORCE TRIG button forces a trigger event. You can use this button to force a trigger even in the absence of an input signal. This function is useful when using Normal (selectable in TRIGGER MENU, Mode & Holdoff) or SINGLE SEQ (selectable on the front panel) trigger modes.

B TRIG button

The B TRIG button activates a second B trigger in addition to the existing A trigger. An indicator light next to the B TRIG button indicates whether the B-trigger is on or off.

To activate the menu-based functions for the B-trigger, follow these steps:

1. In the VERTICAL section, push the **OFF** button to turn off the MATH waveform.
2. In the **TRIGGER** section, push the **MENU** button.
3. In the TRIGGER section, push the **B TRIG** button.

The **B TRIG** menu is activated at the bottom of the display, as shown in Figure 1.8.

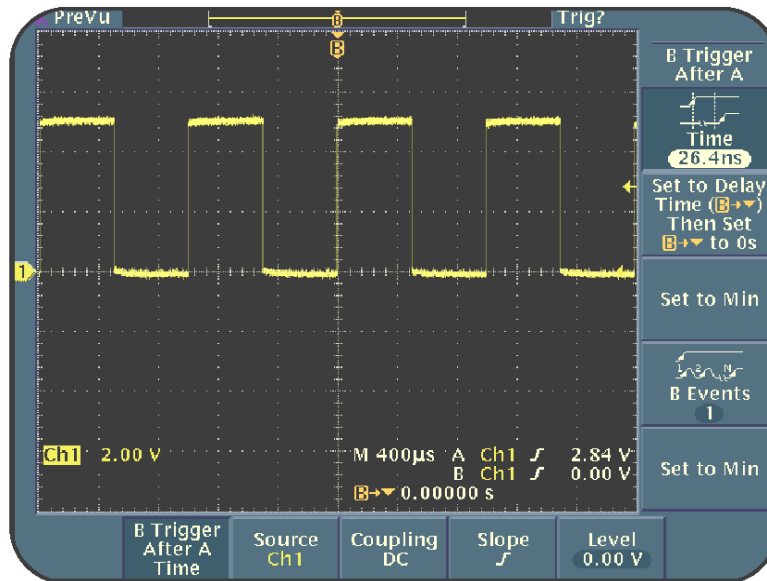

Figure 1.8: Menu-based controls for the B TRIG button

Menu Option	Description
B Trigger After A	You use this option to set the B-trigger conditions for after the A-trigger has triggered the input signal.

1

Getting Started With TDS3000 Oscilloscopes

Source, Coupling, Slope, and Level

You use these options to set the B-trigger source, coupling, slope, and level. These settings are independent of similar settings for the A-trigger.

TRIGGER MENU button

You use the TRIGGER MENU button to choose Edge or Video triggering for an input signal. Both Edge and Video triggering have a unique menu display.

To activate the menu-based functions for the TRIGGER section, follow these steps:

1. In the **TRIGGER** section, push the **MENU** button.
2. In the TRIGGER section, push the **B TRIG** button until the green indicator light is switched off.

Getting Started With TDS3000 Oscilloscopes

3. Push the appropriate bottom-screen menu button to select **Source**.

Figure 1.9 shows the menu-based controls for the TRIGGER section.

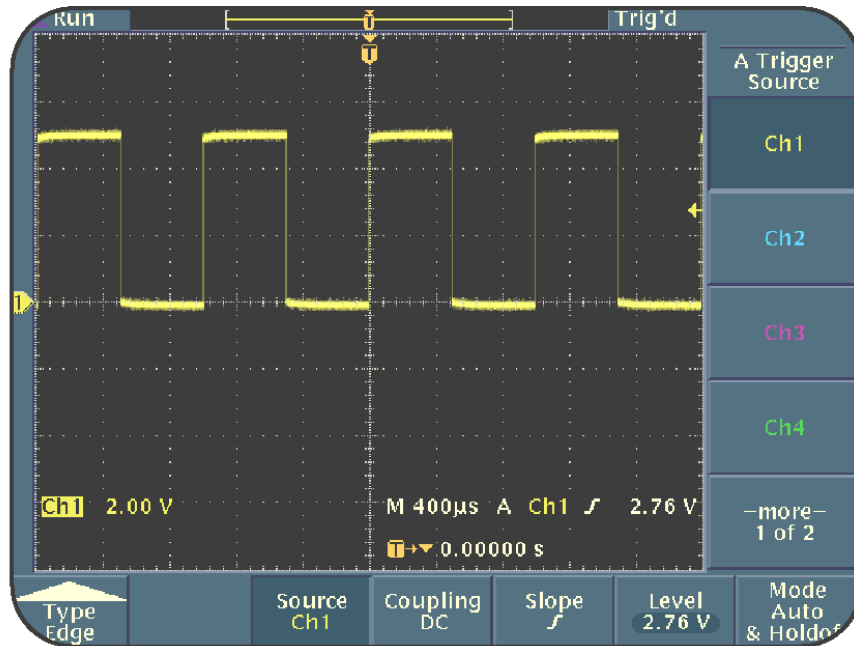

Figure 1.9: TRIGGER Section menu-based controls

1

Getting Started With TDS3000 Oscilloscopes

Depending on the options and base configuration of your TDS3000 or TDS3000B oscilloscope, you may have additional trigger selections for advanced functions, such as Logic, Pulse, Comm and/or Extended Video triggering. This Operator Training Kit does not cover the operation of these advanced triggering functions. For more information about these advanced triggering functions, contact your Tektronix representative.

Edge Triggering

Edge type triggering is used to trigger a signal on the rising or falling edge of an input signal at a specified signal level value. The Type bottom-screen menu and side-screen menu options are used to configure your edge trigger settings.

Menu Option	Description
Source	You use this option to select the edge trigger signal source. Available sources include input channels, the AC power line, an external signal (available on four channel TDS3000B oscilloscopes, and all two channel TDS3000 models), the lowest numbered active channel in the display, or alternating on all active channels (available only on TDS3000B oscilloscopes).
Coupling	You use this option to select DC, HF Reject, LF Reject, or Noise Reject coupling for a trigger.
Slope	You use this option to set a trigger on the rising or falling edge of a signal.

1

Getting Started With TDS3000 Oscilloscopes

Level	You use this option to change the trigger threshold voltage level.
Mode & Holdoff	You use this option to control the trigger mode and holdoff settings.

Video Triggering

Video type triggering is used to trigger on odd fields, even fields, or all the lines of a NTSC, PAL, or SECAM video signal. The TYPE VIDEO menu provides bottom-screen and side-screen menu options to configure your video trigger settings.

Menu Option	Description
Standard	You use this option to select the video standard of the input signal from NTSC, PAL, and SECAM.

Source	Video triggering uses the same source selection as Edge triggering.
Trigger On	You use this option to select triggering on all video lines or fields.
Mode & Holdoff	Video triggering provides the same mode and holdoff menu options as Edge triggering.

For procedures using TRIGGER controls, see *Using TRIGGER Controls* starting on page 4-1.

ACQUIRE Section Controls

The ACQUIRE section controls signal acquisition and processing. You use the ACQUIRE section controls to select different signal acquisition modes, execute the single-shot acquisition of a signal, automatically acquire and display a signal (Autoset), and control waveform intensity.

1

Getting Started With TDS3000 Oscilloscopes

Figure 1.10 shows the ACQUIRE section controls.



Figure 1.10: TDS3000 ACQUIRE section controls

The ACQUIRE section consists of the following controls:

- **RUN/STOP** button
- **SINGLE SEQ** button

- **AUTOSET** button
- **WAVEFORM INTENSITY** knob
- The ACQUIRE **MENU** button

RUN/STOP

The RUN/STOP button allows you to stop and start waveform acquisitions by the oscilloscope.

SINGLE SEQ

The SINGLE SEQ button enables a single-sequence acquisition of a signal. An indicator light next to the SINGLE SEQ button indicates whether or not single-shot acquisition is enabled. When you push the SINGLE SEQ button, the oscilloscope sets the trigger mode to accept one valid trigger and switches on the indicator light for the SINGLE SEQ button. You can force a trigger with the FORCE TRIG button in the TRIGGER section. You can also disable the SINGLE SEQ mode with the RUN/STOP button.

1

Getting Started With TDS3000 Oscilloscopes

AUTOSET

The AUTOSET button automatically adjusts the VERTICAL, HORIZONTAL, and TRIGGER controls of the oscilloscope for a usable display. You can also manually adjust these controls to optimize the display.

An indicator light next to the AUTOSET button temporarily indicates when autosest is initialized.

When you push the AUTOSET button, the settings are as follows:

- The acquisition mode is set to **Sample**.
- The bandwidth limit for each channel is set to **Full**.
- The zoom is turned off.
- The trigger is set to **Auto** mode and minimum holdoff.
- The trigger is set to **Edge** type with **DC** coupling and rising slope.
- The B-trigger is turned off.
- A vertical scale is set for each active channel and waveforms are positioned to avoid overlapping.

WAVEFORM INTENSITY

The WAVEFORM INTENSITY knob allows you to adjust the intensity of a displayed waveform. This feature allows you to get both an analog oscilloscope and a digital oscilloscope view of waveforms. You use medium waveform intensity to get an analog-oscilloscope view of time-varying signals and those containing modulation. You use maximum waveform intensity to obtain a digital oscilloscope-view of a waveform.

1

Getting Started With TDS3000 Oscilloscopes

ACQUIRE MENU

To activate the menu-based functions for the ACQUIRE section, perform the following step:

- In the **ACQUIRE** section, push the **MENU** button.

The ACQUIRE menu is activated at the bottom of the display, as shown in Figure 1.11.

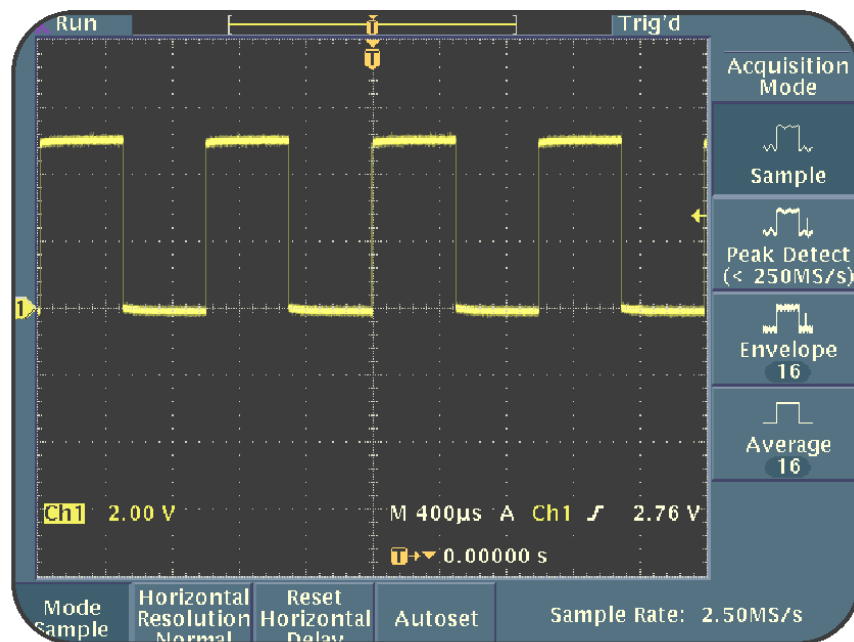

Figure 1.11: Menu-based functions for the ACQUIRE section

Menu Option	Description
Mode	You use this option to select the acquisition mode from Sample, Peak Detect, Envelope, and Average.
Horizontal Resolution	You use this option to select between Fast Trigger (500 point) and Normal (10,000 point) acquisitions for acquiring rapidly changing or stable signals, respectively.
Reset Horizontal Delay	You use this option to set horizontal delay time to zero.
Autoset	You use this option to execute and reverse the autoset function.
WaveAlert	You use this option (available only on a TDS3000B oscilloscope) to detect anomalies on a repeating waveform, and act on the capture of each anomaly. These actions include Beep, Stop, Hard Copy, and Save Wfms To Disk.

1

Getting Started With TDS3000 Oscilloscopes

For procedures using the ACQUIRE controls, see *Using ACQUIRE Controls* starting on page 5-1.

Other Controls

A TDS3000 oscilloscope has various other controls that you can use to select and modify a displayed waveform.

This topic covers the following controls on the front panel:

- **SELECT** button
- General purpose knob
- **COARSE** button
- **MENU OFF** button
- Hard copy button

SELECT

The SELECT button allows you to toggle between two cursors on the display.

General purpose knob

The general purpose knob allows you to perform different functions, such as positioning cursors on the oscilloscope display and setting numerical values for some menu items.

COARSE

The COARSE button allows you to make adjustments in large increments by using the general purpose knob.

MENU OFF

The MENU OFF button removes a menu from the oscilloscope display.

Hard copy

The hard copy button prints a hard copy of the display by using the port selected in the utility menu.

1

Getting Started With TDS3000 Oscilloscopes

Menu Function Controls

You can use the menu function controls to perform various functions. These functions may include taking automatic measurements, saving and recalling waveforms, modifying the oscilloscope display characteristics, and accessing oscilloscope setup utilities.

To access the menus for each function, push a menu function button at the top of the front panel. The oscilloscope displays the associated menu at the bottom of the screen. You control each menu option by pushing the associated bottom-screen menu button. You control the submenu for each menu option by pushing the associated side-screen menu button.

Figure 1.12 shows the front panel menu function controls of a TDS3000 oscilloscope.

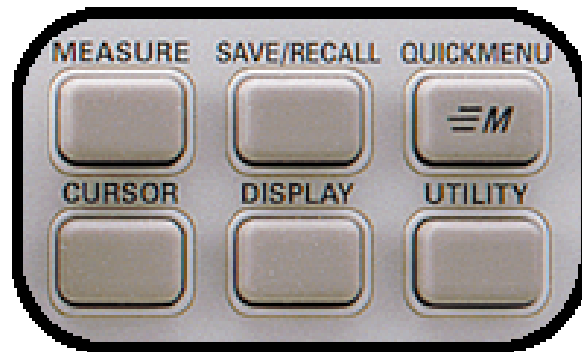

Figure 1.12: TDS3000 front panel menu function controls

MEASURE Menu Function Controls

The MEASURE menu function controls allow you to take pre-defined automated measurements of waveforms.

1

Getting Started With TDS3000 Oscilloscopes

To activate selections for the MEASURE menu function, perform the following step:

- On the top of the front panel, push the **MEASURE** menu button.

The MEASURE menu is activated at the bottom of the display, as shown in Figure 1.13.

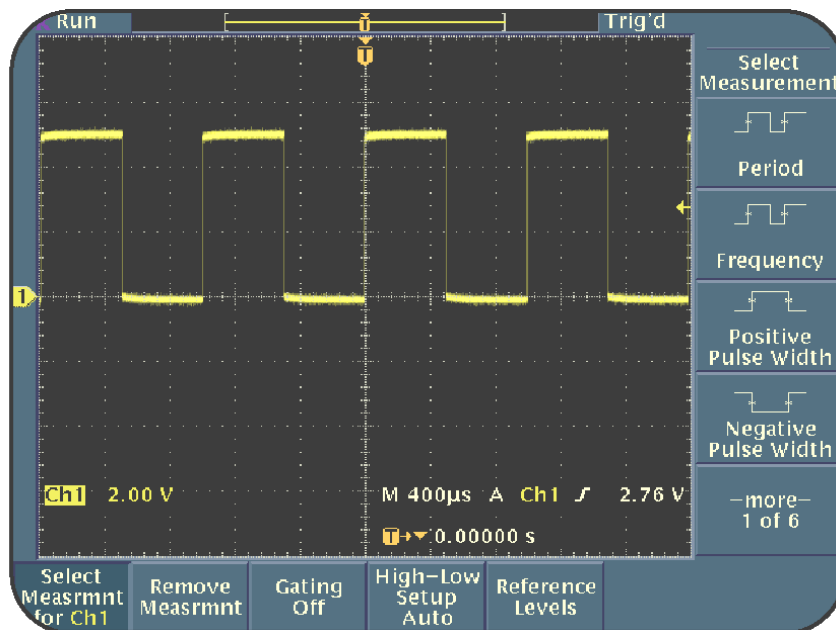

Figure 1.13: MEASURE menu

Menu Option	Description
Select Measurement	You use this option to select the automatic measurement that you want to perform, such as amplitude, frequency, negative width, or rise time measurement. You can display up to four measurements on the screen.
Remove Measurement	You use this option to remove a specific measurement or all displayed measurements.
Gating	You use this option to select the portion of a displayed waveform that is to be measured.
High-Low Setup	You use this option to select the measurement method to be used depending on the waveform type and signal characteristics.

1

Getting Started With TDS3000 Oscilloscopes

Reference Levels You use this option to specify custom or default reference levels.

For procedures using the MEASURE menu function controls, see *MEASURE Menu Function Controls* starting on page 6-4.

SAVE/RECALL Menu Function Controls

You use the SAVE/RECALL menu function to save and recall oscilloscope setups or waveforms to nonvolatile memory locations or to a floppy disk. You can also use the SAVE/RECALL menu function controls to recall the default factory settings.

To activate the menu-based functions for the SAVE/RECALL menu function controls, perform the following step:

- On the top of the front panel, push the **SAVE/RECALL** menu button.

Getting Started With TDS3000 Oscilloscopes

The SAVE/RECALL menu is activated at the bottom of the display, as shown in Figure 1.14.

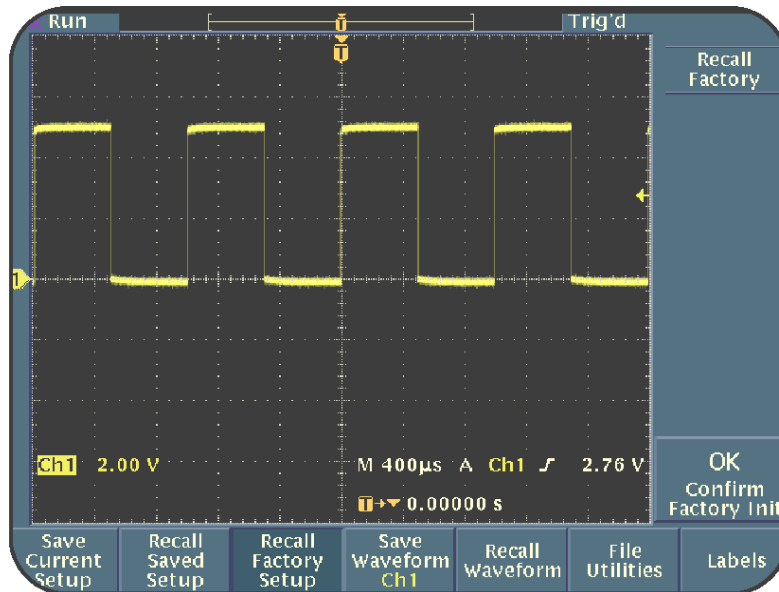

Figure 1.14: SAVE/RECALL menu

1

Getting Started With TDS3000 Oscilloscopes

Menu Option	Description
Save Current Setup	You use this option to save a setup to a floppy disk or to a nonvolatile memory location.
Recall Saved Setup	You use this option to recall a saved setup from a floppy disk or from a nonvolatile memory location.
Recall Factory Setup	You use this option to recall and initialize the oscilloscope's default factory settings.
Save Wfm	You use this option to save a waveform to a floppy disk or to a nonvolatile memory location.
Recall Wfm	You use this option to recall a saved waveform from a floppy disk or from a nonvolatile memory location.

File Utilities	You use this option to access file utilities, such as Delete, Rename, Copy, and Create Directory.
Labels	You use this option to assign unique labels to reference waveforms and instrument setups stored in nonvolatile memory locations or on a floppy disk. A TDS3000 oscilloscope automatically labels each file stored as TEK?????, where '?' is a placeholder for a number sequence from 00000 to 99999. You can rename a file with up to eight characters to replace the default TEK????? in each file name.

For procedures using the SAVE/RECALL menu function controls, see *SAVE/RECALL Menu Function Controls* starting on page 6-16.

1

Getting Started With TDS3000 Oscilloscopes

QUICKMENU Function Controls

You use the QUICKMENU control to access special menus that provide key functions in a single menu.

Scope is a standard QuickMenu that you can use to control the basic functions of a TDS3000 oscilloscope. You can perform the most frequently used functions for each section with the Scope QuickMenu. You can do this without accessing the regular menu system through the front panel for each section. You can also access a QuickMenu of some optional application modules that you might have installed, such as Telecom and Video. For a procedure using the QUICKMENU menu function control, see *QUICKMENU Function Controls* starting on page 6-22.

CURSOR Menu Function Controls

You use the CURSOR controls to make amplitude and time measurements on the displayed waveforms. You can also use the CURSOR menu to specify the units of measurement for the amplitude and time measurements of a waveform.

To activate the menu-based functions for the CURSOR menu function controls, perform the following step:

- On the top of the front panel, push the **CURSOR** menu button.

The CURSOR menu is activated at the bottom of the display, as shown in Figure 1.15.

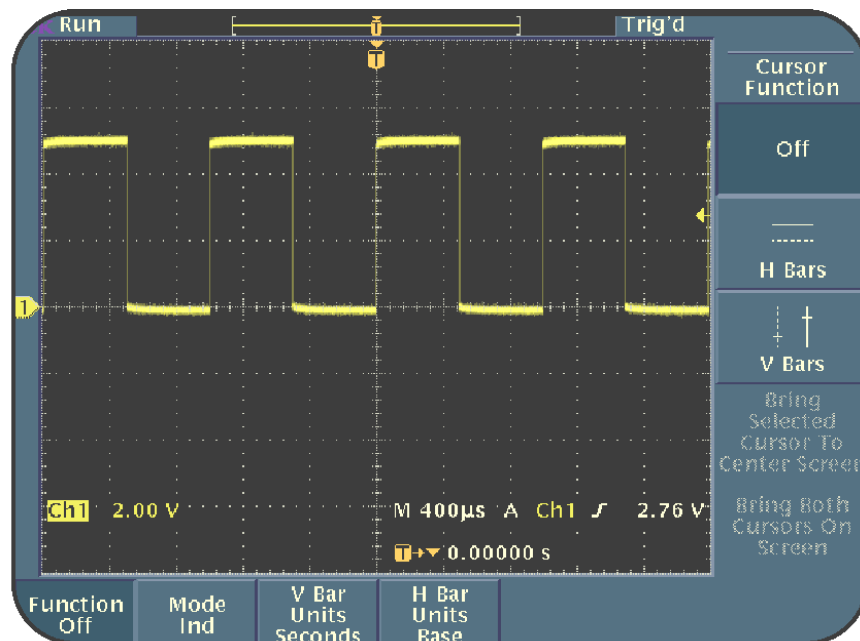

Figure 1.15: CURSOR menu

1

Getting Started With TDS3000 Oscilloscopes

Menu Option	Description
Function	You use this option to activate cursors and select between horizontal and vertical cursors.
Mode	You use this option to set cursors to move together or independently of each other.
V Bar Units	You use this option to set V Bar and horizontal measurement units.
H Bar Units	You use this option to set H Bar and vertical measurement units.

For procedures using the CURSOR menu function controls, see *CURSOR Menu Function Controls* starting on page 6-25.

DISPLAY Menu Function Controls

You use the DISPLAY menu to control the persistence, display format, and display contrast.

To activate the menu-based functions for the DISPLAY menu function controls, perform the following step:

- On the top of the front panel, push the **DISPLAY** menu button.

The DISPLAY menu is activated at the bottom of the display, as shown in Figure 1.16.

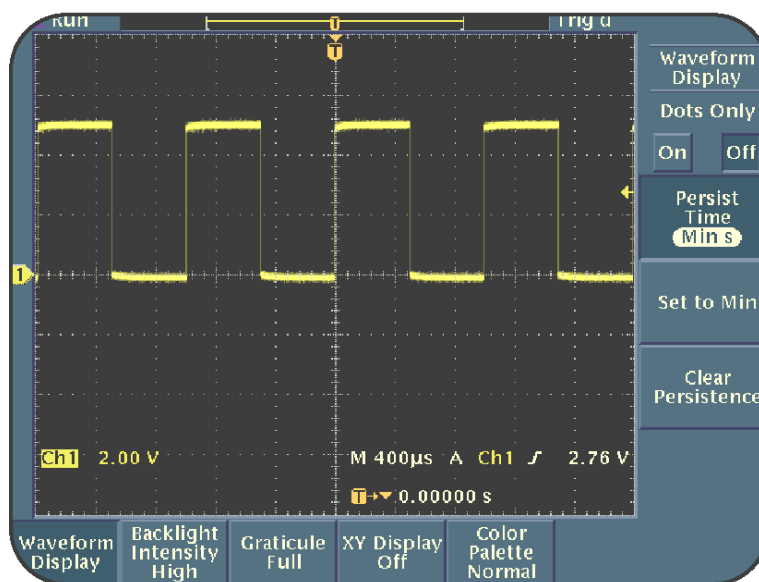

Figure 1.16: DISPLAY menu

1

Getting Started With TDS3000 Oscilloscopes

Menu Option	Description
Waveform Display	You use this option to set the display type to dots or vectors and control waveform persistence settings.
Backlight Intensity	You use this option to set the backlight intensity for the oscilloscope display.
Graticule	You use this option to set the graticule type to Full, Grid, Crosshair, or Frame.
XY Display	You use this option to turn the XY display mode on or off and set various settings for the XY display mode.
Color Palette	You use this option to set the oscilloscope display to color or monochrome.

For procedures using the DISPLAY menu function controls, see *DISPLAY Menu Function Controls* starting on page 6-28.

UTILITY Menu Function Controls

You use the UTILITY menu function controls to access the oscilloscope setup utility functions, such as selecting a display language, setting the system date and time, setting up hard copy and communication ports, and running internal diagnostic routines.

To activate the menu-based functions for the UTILITY menu function controls, perform the following step:

- On the top of the front panel, push the **UTILITY** menu button.

1

Getting Started With TDS3000 Oscilloscopes

The UTILITY menu is activated at the bottom of the display, as shown in Figure 1.17.

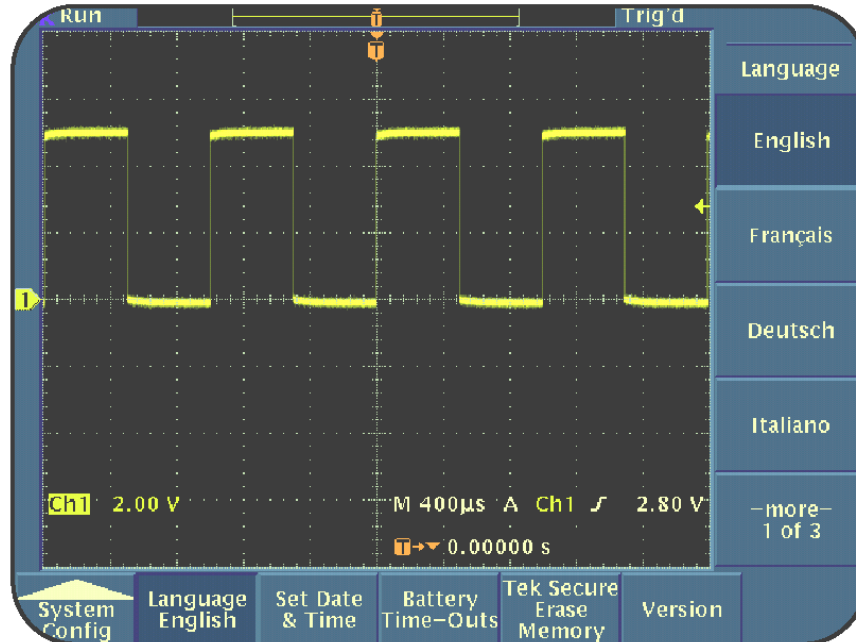

Figure 1.17: UTILITY menu

Menu Option	Description
System Config	You use this option to set the display language and date and time, control battery timeouts, and erase the memory locations of an oscilloscope.

System Apps	You use this option to control the utilities on an installed optional application module.
System I/O	You use this option to set up the communication ports of an oscilloscope, such as GPIB and RS-232.
System Hard Copy	You use this option to set hard copy parameters, such as file format, printer format, file compression, and print preview.
System Cal	You use this option to compensate the optimum signal path for an oscilloscope, calibrate the oscilloscope, and set a time after which the oscilloscope will require calibration.

1

Getting Started With TDS3000 Oscilloscopes

System Diags

You use this option to execute and control internal diagnostic routines for an oscilloscope, such as executing and looping diagnostic routines and viewing the error log.

For a procedure using the UTILITY menu function controls, see *UTILITY Menu Function Controls* starting on page 6-41.

Setting Up a TDS3000 Oscilloscope

In this section, you will learn how to set up a TDS3000 oscilloscope and compensate a passive voltage probe.

Grounding an Oscilloscope

Proper grounding is essential for your own safety, the safety of the oscilloscope, and for taking accurate measurements. This section discusses the procedure and advantages of properly grounding an oscilloscope before use.

To ground your TDS3000 oscilloscope, plug the three-pronged power cord into a wall power outlet grounded to earth ground. A TDS3000 oscilloscope can also be operated from an optional battery pack. When a TDS3000 oscilloscope is not connected to a grounded wall power outlet, you must make the ground connection via a wire between area ground and the rear panel Safety Ground post. See the TDS3000 User Manual for instructions on how to make this connection.

1

Getting Started With TDS3000 Oscilloscopes

Grounding protects the circuits of your oscilloscope. If your oscilloscope is not grounded, a high voltage spike in the input current can damage the circuits of the oscilloscope. Such a spike can also pass through the case of the oscilloscope and injure you.

Grounding is also necessary for taking accurate measurements with your oscilloscope. Ensure that your oscilloscope shares the same ground as the circuit you are testing.

If you are measuring integrated circuits (ICs), you need to ground yourself to prevent damage to the ICs. ICs have tiny conduction paths that can be damaged by the static electricity that builds up on your body. If your body has built up static charge and you touch the leads of an IC, you can render the IC useless. To prevent damage to ICs, you must wear a grounding strap that conducts the static charge from your body to earth ground.

Safety Precautions

You must observe certain safety precautions while setting up a TDS3000 oscilloscope in order to avoid injury to yourself and damage to the oscilloscope.

The following safety precautions are to be adhered to while operating the TDS3000 oscilloscope:

- Observe and understand all ratings and terminal markings on the oscilloscope before you start using it.
- Use the power cord designed for the oscilloscope. The power cord must have the appropriate power rating as per the specification in your country.
- Ensure that probes and test leads are not attached to a voltage source while connecting or disconnecting from the oscilloscope.

1

Getting Started With TDS3000 Oscilloscopes

- Ensure that the oscilloscope is properly grounded before you connect the various accessories, such as probes, to the input or output terminals of the oscilloscope.
- Connect the probe ground lead only to the ground potential.
- Ensure that you do not operate the oscilloscope either with any panels removed or with exposed circuitry.
- Ensure that the operational environment of the oscilloscope is properly ventilated and is not humid.
- Do not connect any oscilloscope input to any AC, DC, or spike voltage over the input rating.
- Do not connect any probe input to any AC, DC, or spike voltage over the probe rating.

Introduction to the Training 1 Signal Board

You will use the Training 1 signal board for most procedures in this Operator Training Kit. Figure 1.18 shows the Training 1 signal board.

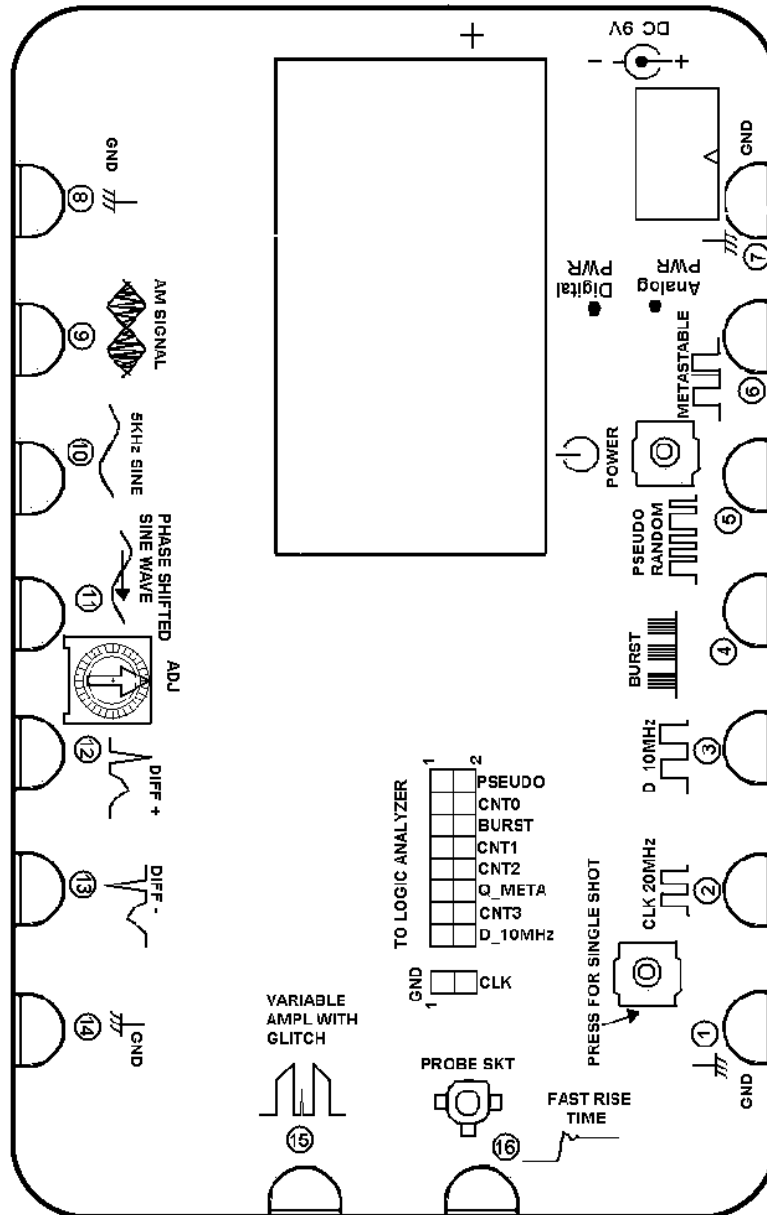

Figure 1.18: The Training 1 signal board

1

Getting Started With TDS3000 Oscilloscopes

The Training 1 signal board has various pins that generate different kinds of signals. Each pin is labeled according to the signal it generates. You can view and analyze these signals on your TDS3000 oscilloscope.

You can use either a 9-volt battery (NEDA type 1604, Alkaline recommended) or a line transformer with an output of 9-volts, 1A, to power the Training 1 signal board. A 9-volt battery is supplied with your Training 1 signal board. However, for long-term use you can also order the appropriate wall transformer with the recommended output for your country from Tektronix.

Part Numbers	Wall Transformer Accessories
119-4238-00	Australian plug 240V
119-4239-00	UK plug 240V
119-4240-00	Universal Euro plug 220V
119-4241-00	Japanese cert T-mark 100V
119-4242-00	U.S. plug 115V

Note: When using a wall transformer for power, you should remove the 9-volt battery from the Training 1 signal board.

You should also disconnect the wall transformer from the Training 1 signal board when the signal board is not in use. This is because even when both **Analog PWR** and **Digital PWR** indicator lights are off, wall power is still supplied to the Training 1 signal board.

The Training 1 signal board has a three-step switch. When you push POWER once, the analog signals of the Training 1 signal board are activated. When you push POWER twice, both analog and digital signals of the Training 1 signal board are activated. When you push POWER a third time, the Training 1 signal board is powered down.

Note: The **POWER** button does not remove all power from the Training 1 signal board. When you push the **POWER** button three times, the signal board is just put on standby.

1

Getting Started With TDS3000 Oscilloscopes

Pins 1 to 6 of the Training 1 signal board provide digital signals, while pins 9 to 16 provide analog signals. All pins labeled GND provide the common signal reference. For a description of the signal from each pin of the Training 1 signal board, see Appendix A, *Training 1 Signal Board: Signal Definitions*, starting on page A-1.

When you use the Training 1 signal board in analog-only mode, a 9-volt battery will last for approximately thirty hours. However, when you use the Training 1 signal board in analog-digital mode, a 9-volt battery will last for approximately 7-10 hours.

The Training 1 signal board has a built in power-save mode. The Training 1 signal board switches itself off automatically after being switched on for about 1 hour.

Probe Compensation

When you attach a passive voltage attenuation probe to an oscilloscope, the capacitances of both the probe cable and the oscilloscope's input combine. This combined capacitance must match the capacitance of the probe's input attenuation circuit. You must balance these capacitive effects with respect to the probe and oscilloscope combination.

Probes are designed to match the inputs of specific oscilloscope models. However, there are slight variations between oscilloscopes and even between different input channels in an oscilloscope. To minimize these variations, attenuating passive probes (10X and 100X probes) have built-in compensation networks. You need to adjust this network to compensate the probe for the oscilloscope channel that you are using.

Note: *You should compensate a passive voltage attenuation probe every time you change a probe/channel connection on your TDS3000 oscilloscope. This ensures that the probe accurately transfers the signal from a signal source to the oscilloscope.*

1

Getting Started With TDS3000 Oscilloscopes

The following procedure enables you to balance the capacitive elements of the CH1 and CH2 probes with an oscilloscope by compensating the probes.

Note: *This procedure assumes that the oscilloscope retains the settings from the previous procedure.*

To compensate the CH1 and CH2 probes, follow these steps:

1. Connect a P6139A 10X passive voltage attenuation probe to the **CH2** input connector.
2. Attach the CH2 probe tip and the ground lead to **PROBE COMP** and the ground connectors, respectively.
3. Both Channel 1 and Channel 2 probes should now be connected to the **PROBE COMP** pin.
4. In the VERTICAL section, push the **CH2** button to activate Channel 2.
5. In the ACQUIRE section, push the **AUTOSET** button.
6. In the **VERTICAL** section, turn the **SCALE** knob to set CH1 to **2.00V** on the oscilloscope display.

7. Turn the **VERTICAL POSITION** knob to position the CH1 waveform in the top half of the display.
8. In the VERTICAL section, push the **CH2** button to re-activate the controls for Channel 2.
9. Turn the **VERTICAL SCALE** knob to set CH2 to **2.00V** on the oscilloscope display.
10. Turn the **VERTICAL POSITION** knob to position the CH2 waveform in the bottom half of the display.

You should see two waveforms on the oscilloscope, similar to that shown in Figure 1.19.

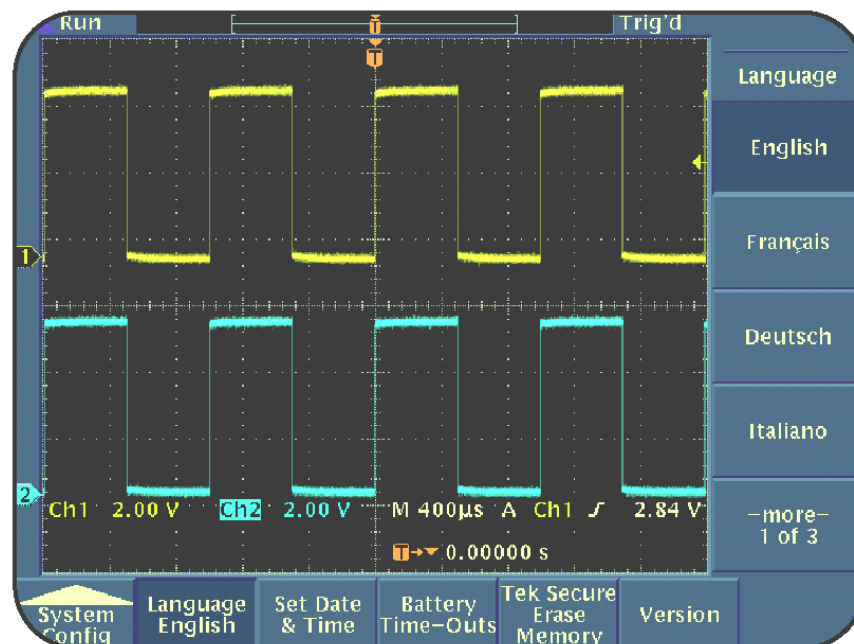

Figure 1.19: CH1 Probe Compensation Signal

1

Getting Started With TDS3000 Oscilloscopes

However, the waveforms could also have distorted corners. Such waveforms could be similar to the waveforms shown in Figure 1.20 or Figure 1.21.

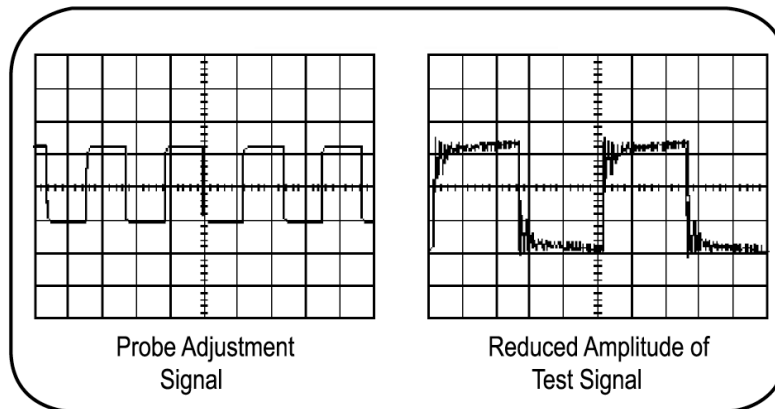

Figure 1.20: Undercompensated probe

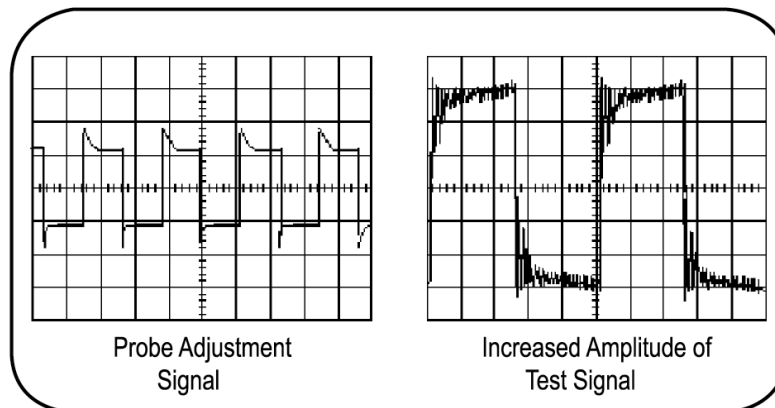

Figure 1.21: Overcompensated probe

An undercompensated or overcompensated probe can cause errors in measurement, especially with respect to pulse rise or fall times. To compensate the probes correctly, you must use the probe adjustment tool provided with the probes. The probe adjustment tool resembles a small screwdriver. You insert the probe adjustment tool in a small compensation adjustment slot on the side of the small box that connects the probe to the oscilloscope channel input.

Note: *100 MHz passive voltage attenuation probes that are provided with the lower bandwidth TDS3000 oscilloscopes have the compensation adjustment slot in the probe tip barrel instead of the probe compensation box at the oscilloscope BNC connection.*

After compensating the probe for each channel, you will observe a square waveform with square corners, similar to that shown in Figure 1.19.

1

Getting Started With TDS3000 Oscilloscopes

Summary

In this module, you learned about the following:

- The basic features of a TDS3000 oscilloscope.
- The differences between the various models of the TDS3000 series of oscilloscopes.
- The layout of the various controls on the front panel of a TDS3000 oscilloscope.
- The features of each primary control section.
- The features of each menu function control.
- The importance of grounding an oscilloscope before operations.
- The procedure of setting up a TDS3000 oscilloscope.
- The features of the Training 1 signal board that will be used for operational procedures in this Operator Training Kit.
- The procedure of compensating a passive probe for use with a TDS3000 oscilloscope.

2

Using VERTICAL Controls

This module focuses on using the VERTICAL controls of a TDS3000 oscilloscope to modify the displayed waveform.

This module includes the following sections:

- Setting Up a TDS3000 Oscilloscope for VERTICAL Controls
- Operating VERTICAL Controls

2

Using VERTICAL Controls

Setting Up VERTICAL Controls

Figure 2.1 shows the VERTICAL controls of a TDS3000 oscilloscope.

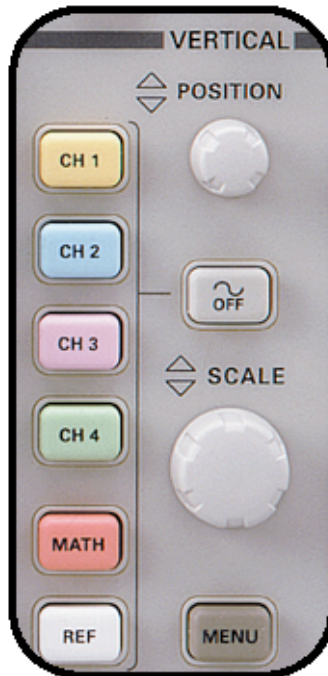

Figure 2.1: TDS3000 VERTICAL controls

Before you begin using the VERTICAL controls of a TDS3000 oscilloscope, you must set up the oscilloscope for operation exercises with the VERTICAL controls.

The following procedure sets up a TDS3000 oscilloscope for use with the VERTICAL controls.

To set up a TDS3000 oscilloscope for the VERTICAL controls, follow these steps:

1. Connect a P6139A 10X passive voltage attenuation probe to the **CH1** connector on the TDS3000 front panel.

Remove the CH2 probe from the CH2 input connector, if it is connected.

2. Connect the CH1 probe tip to the **D-10 MHz** signal on pin 3 of the Training 1 signal board and the CH1 probe ground lead to **GND** on pin 1.
3. On the Training 1 signal board, push the **POWER** button until the **Digital PWR** light is on.
4. On the top of the front panel, push the **SAVE/RECALL** menu button.
5. Push the appropriate bottom-screen menu button to select **Recall Factory Setup**.

2

Using VERTICAL Controls

6. Push the appropriate side-screen menu button to select **OK Confirm Factory Init.**
7. In the ACQUIRE section, push the **AUTOSET** button.

You should see a waveform similar to that shown in Figure 2.2.

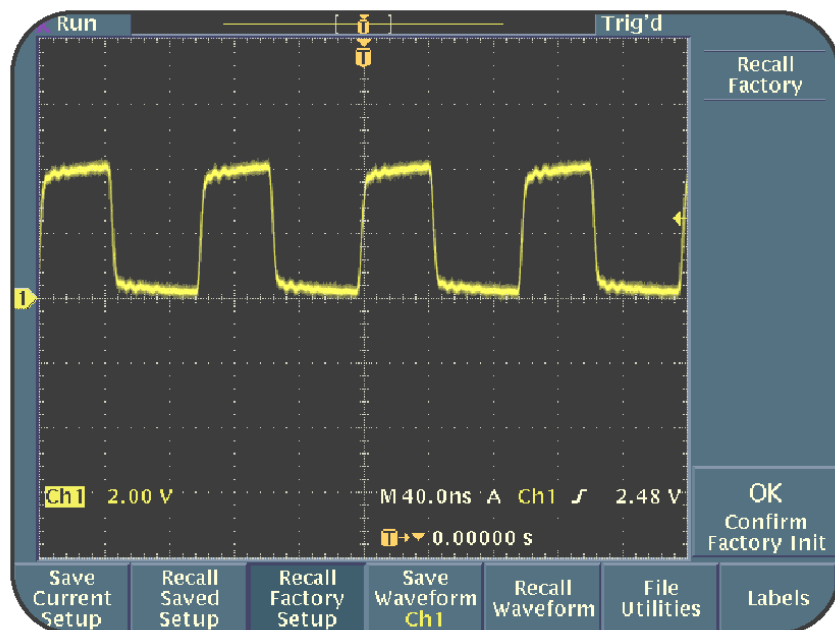

Figure 2.2: CLOCK signal

Operating VERTICAL Controls

In this section, you will perform various procedures to modify a displayed waveform by using the VERTICAL section controls.

Using VERTICAL Controls to Modify Acquisition and Display

The waveform shown in Figure 2.2 appears to be a single waveform. However, the waveform represents numerous waveforms triggered from the same signal and overlaid on one another.

In an analog oscilloscope, a waveform is displayed when an electron beam from the cathode ray tube sweeps the phosphor screen and makes the screen glow. If an electron beam strikes at a given point on the phosphor screen frequently, the screen glows brighter. The waveform on the display disappears when the electron beam is stopped. A TDS3000 oscilloscope has an intensity graded color LCD display. This enables a TDS3000 oscilloscope to display a waveform similar to an analog oscilloscope with a phosphor screen.

2

Using VERTICAL Controls

The following procedure enables you to use the VERTICAL controls to modify the acquisition and display of a waveform.

***Note:** This procedure assumes that the oscilloscope retains the settings from the previous procedure.*

To affect the acquisition and display of a displayed waveform by using the VERTICAL controls, follow these steps:

1. In the ACQUIRE section, push the **RUN/STOP** button.

This stops the signal acquisition by the oscilloscope.

2. In the **VERTICAL** section, turn the **POSITION** knob to move the waveform one division above its current position.

Observe that the displayed waveform becomes very dim.

3. In the ACQUIRE section, push the **RUN/STOP** button twice.

This reacquires the signal and stops the acquisition again.

4. In the **VERTICAL** section, turn the **POSITION** knob to move the waveform one division below its current position.

Observe that the displayed waveform again turns very dim.

2

Using VERTICAL Controls

You will see a waveform similar to that shown in Figure 2.3.

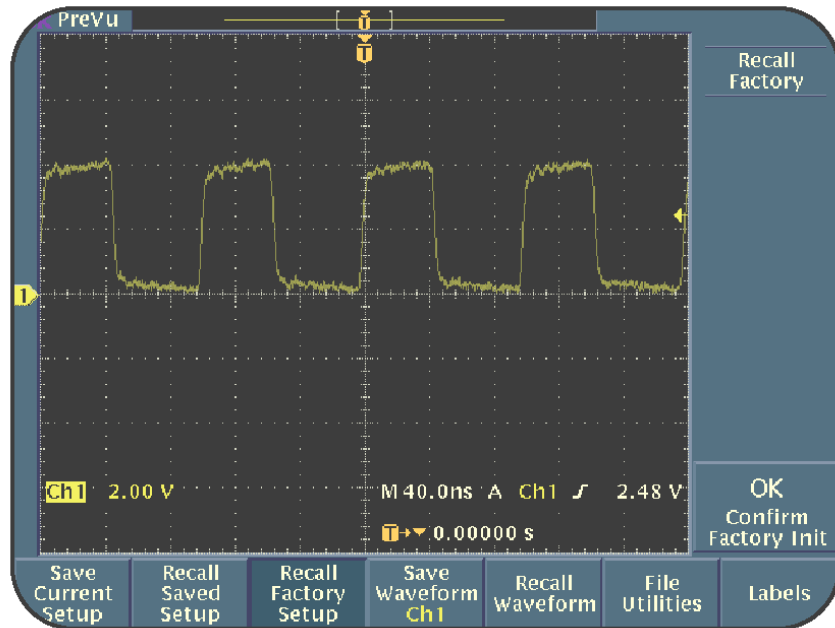

Figure 2.3: Dimmed waveform display with stopped signal acquisition and shifted waveform

5. In the ACQUIRE section, push the **RUN/STOP** button to resume signal acquisition.

The waveform appears dim because the oscilloscope display shows only the last sampled acquisition after the signal acquisition is stopped.

When you change the vertical position of the waveform, the oscilloscope displays the last waveform saved by the intensity graded display.

Working with Channel Displays

You can simultaneously view multiple waveforms on a TDS3000 oscilloscope. These include up to four waveforms from the input channels, four saved reference waveforms, and a math waveform.

Note: *Two-channel TDS3000 models display fewer waveforms.*

You can also choose to view the entire display in monochrome or each waveform in a different color.

Note: All reference waveforms are displayed in the white color.

The following procedure enables you to simultaneously display waveforms for all input channels of a TDS3000 oscilloscope.

2

Using VERTICAL Controls

Note: *This procedure assumes that the oscilloscope retains the settings from the previous procedure.*

To activate all input channels, follow these steps:

1. In the **VERTICAL** section, push the **MENU** button.
2. In the VERTICAL section, push the **CH2** button to display the blue CH2 waveform.
3. Turn the **VERTICAL POSITION** knob to position the CH2 trace just below the yellow CH1 waveform.
4. If you have a 4-channel model, push the **CH3** button to display the pink CH3 waveform.
5. Turn the **VERTICAL POSITION** knob to position the CH3 trace just below the blue CH2 trace.
6. If you have a 4-channel model, push the **CH4** button to display the green CH4 trace.
7. Turn the **VERTICAL POSITION** knob to position the CH4 trace just below the pink CH3 trace.

Note: *Two-channel TDS3000 models will not display CH3 (pink) or CH4 (green) waveforms.*

2

Using VERTICAL Controls

You will see a display similar to that shown in Figure 2.4.

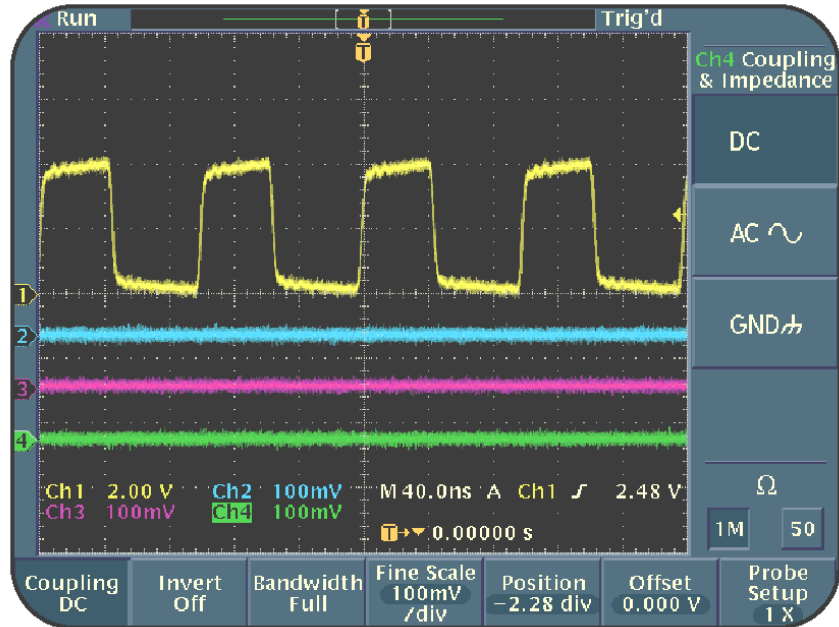

Figure 2.4: 4 Channel display

You can select any waveform by pushing the appropriate channel button in the VERTICAL section. You can also remove the waveform from the display by selecting a waveform and then pushing the OFF button in the VERTICAL section.

In addition, you can select different settings for each channel by using the VERTICAL MENU button to activate the vertical menu and then select the required menu options.

2

Using VERTICAL Controls

Switching the Input Coupling

Coupling is used to connect an electrical signal from one device to another. An example of coupling is connecting the Training 1 signal board to a TDS3000 oscilloscope. A TDS3000 oscilloscope allows you to select AC, DC, or ground coupling.

The following procedure enables you to view how different input coupling settings affect the displayed waveform.

***Note:** This procedure assumes that the oscilloscope retains the settings from the previous procedure.*

To switch between AC and DC coupling, follow these steps:

1. In the VERTICAL section, push the **CH1** button.
2. In the TRIGGER section, use the **LEVEL** knob to set the trigger level for **3.00V** on the oscilloscope display.
3. Push the appropriate bottom-screen menu button to select **Coupling DC**.

4. Push the appropriate side-screen menu button to select **AC**.

Note that the triggering for the signal stops and the waveform shifts down. The waveform shifts down because AC coupling blocks the DC component of the signal. However, the auto baseline trigger causes an untriggered waveform to appear on the oscilloscope display.

5. Push the appropriate side-screen menu button to select **DC**.
6. Push the appropriate bottom-screen menu button to select **Fine Scale**.
7. On the top of the front panel, turn the **general purpose** knob counterclockwise to vary the volts/division scale.

2

Using VERTICAL Controls

You will see a waveform similar to that shown in Figure 2.5.

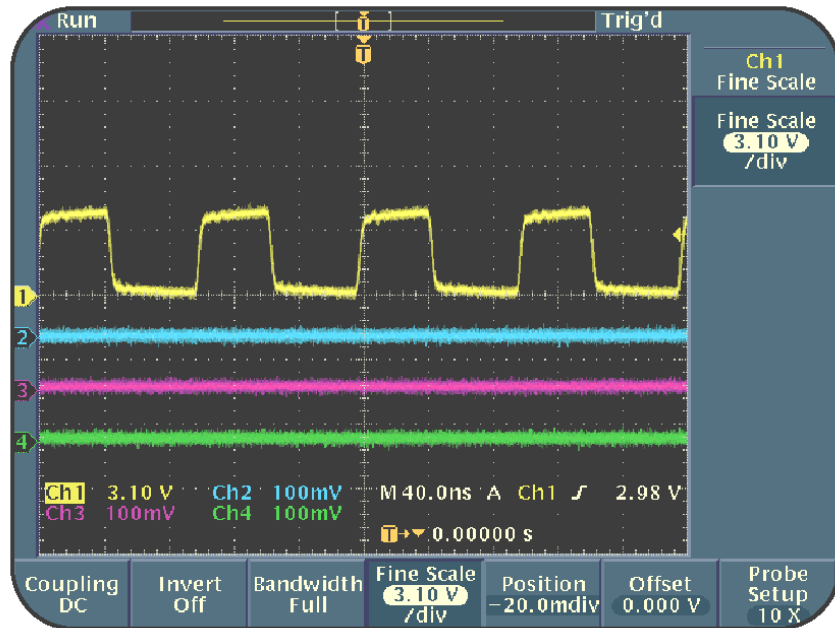

Figure 2.5: Modified input coupling

Notice that the general purpose knob adjusts the volts/div scale with a very fine resolution. In addition, when you vary the size of the waveform on the oscilloscope display, the trigger level moves up and down with the waveform.

Using Vertical Offset Controls

At times, you may need to look at high amplitude signals or small signal details at very high resolutions. You can view such signal details by using the vertical Offset control.

The following procedure enables you to change the vertical expansion reference with respect to the waveform by using the vertical Offset control. You will also change the volts/division to expand the displayed waveform detail of interest by using the VERTICAL SCALE knob.

To vertically expand a selected part of a waveform, follow these steps:

1. Verify that the CH1 probe tip is connected to the **D-10 MHz** signal on pin 3 and that the CH1 probe ground lead is connected to **GND** on pin 1 of the Training 1 signal board.

2

Using VERTICAL Controls

2. At the top of the front panel, push the **SAVE/RECALL** menu button.
3. Push the appropriate bottom-screen menu button to select **Recall Factory Setup**.
4. Push the appropriate side-screen menu button to select **OK Confirm Factory Init**.
5. In the ACQUIRE section, push the **AUTOSET** button.
6. In the **VERTICAL** section, turn the **SCALE** knob clockwise to set CH1 for **100 mV** on the oscilloscope display.

When you change the volts/division setting from 2.00 V to 100 mV, you expand the waveform vertically 20 times from its earlier display. Also, notice that the expansion is around the center graticule line and that the top of the waveform is 40 divisions above the center graticule line.

You will see a waveform similar to that shown in Figure 2.6.

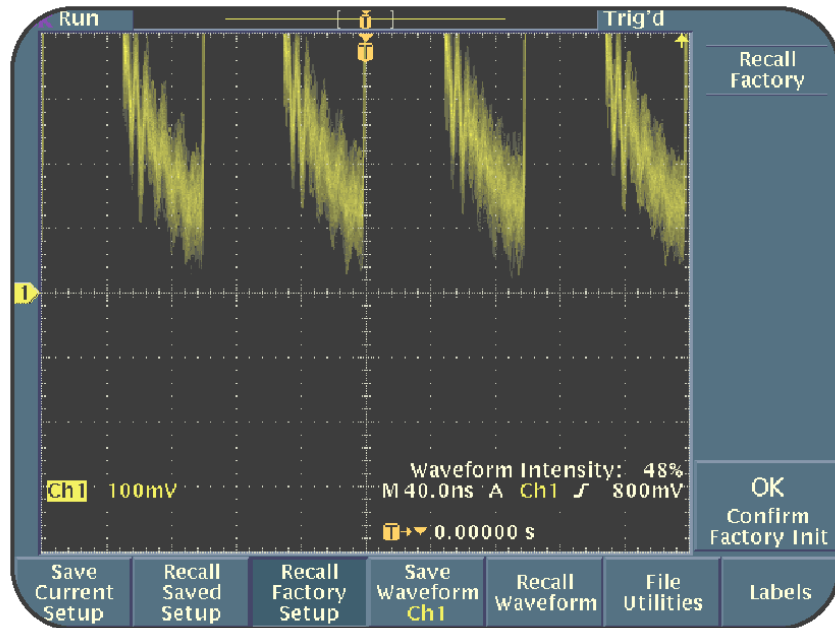

Figure 2.6: Vertically expanded waveform around the center graticule line

7. Turn the **VERTICAL SCALE** knob counter-clockwise to set CH1 for **2.00 V** on the oscilloscope display.

When you change the volts/division setting back from 100 mV to 2.00 V, the waveform moves back from 40 divisions to 2.0 divisions.

2

Using VERTICAL Controls

8. In the **VERTICAL** section, push the **MENU** button.
9. Push the appropriate bottom-screen menu button to select **Offset**.
10. At the top of the front panel, turn the **general purpose** knob to vertically align the top of the waveform with the yellow arrow, labeled **1**, at the left of the oscilloscope display.

This should also correspond to the center vertical graticule line.

11. In the **VERTICAL** section, turn the **SCALE** knob clockwise to set CH1 for **100 mV**.

When you set the volts/division setting to 100 mV, the ground reference of the waveform is 40 divisions below the center graticule line. The vertical **Offset** control is used to change the expansion reference with respect to the waveform.

12. At the top of the front panel, turn the **general purpose** knob to align the expanded top of the waveform with the center graticule line.

The voltage level of the **Offset** appears in the bottom-screen menu, under **Offset**.

You will see a waveform similar to that shown in Figure 2.7.

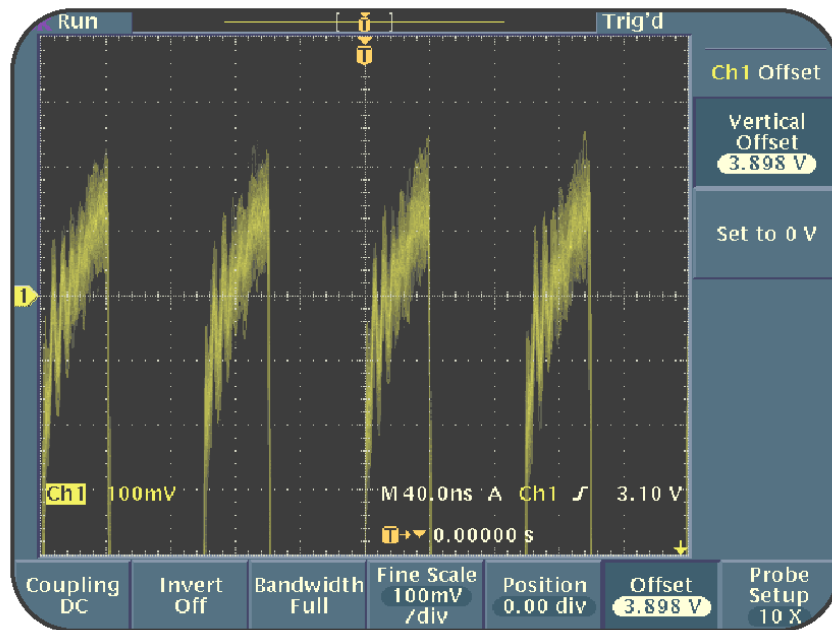

Figure 2.7: Changed vertical waveform expansion reference with respect to a waveform

In this procedure, you learned how to change the vertical waveform expansion reference with respect to a waveform by using the vertical Offset control. To summarize, the offset control is used to change the vertical point at which expansion can occur by using the VERTICAL SCALE knob. This is needed when better viewing of details on the waveform is required.

2

Using VERTICAL Controls

Using the MATH Menu

You can use the MATH menu controls to perform different mathematical operations on waveforms. For example, you can add, subtract, divide, and multiply waveforms. In addition, you can perform Fast Fourier Transform (FFT) operations on a waveform.

Note: *All TDS3000B models have FFT as a standard MATH function. All other TDS3000 models require an option for FFT.*

The following procedure shows how to use the MATH functions to obtain the differential of two waveforms.

To subtract one waveform from another, follow these steps:

1. Connect the CH 1 probe tip to the **DIFF +** signal on pin 12 and the CH1 ground lead to **GND** on pin 8 of the Training 1 signal board.

2. On the front panel, connect a P6139A passive voltage attenuation probe to the **CH2** input connector.
3. Connect the CH 2 probe tip to the **DIFF** – signal on pin 13 and the CH2 ground lead to **GND** on pin14 of the Training 1 signal board.
4. On the Training 1 signal board, push the **POWER** button until only the **Analog PWR** light is on.
5. On the top of the front panel, push the **SAVE/RECALL** menu button.
6. Push the appropriate bottom-screen menu button to select **Recall Factory Setup**.
7. Push the appropriate side-screen menu button to select **OK Confirm Factory Init**.

2

Using VERTICAL Controls

8. In the **VERTICAL** section, turn the **SCALE** knob to set CH1 for **500mV** on the oscilloscope display.
9. In the VERTICAL section, push the **CH 2** button.
10. Turn the **VERTICAL SCALE** knob to set CH2 for **500mV** on the oscilloscope display.
11. In the **HORIZONTAL** section, turn the **SCALE** knob counterclockwise to set the time base, displayed at the bottom of the oscilloscope display, for **M 400ms**.
12. In the VERTICAL section, push the **MATH** button.
13. Push the appropriate side-screen menu button to select **Set Operator to -**.

You will see a waveform similar to that shown in Figure 2.8.

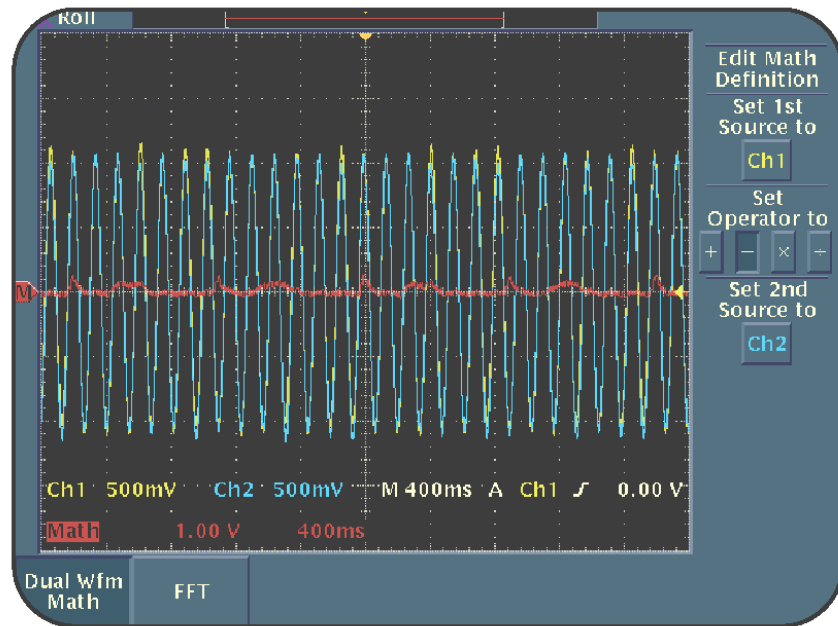

Figure 2.8: CH1-CH2

As you can see in Figure 2.8, the MATH function is able to extract a small differential heart beat signal from the large common mode sine wave that is on both Channel 1 and Channel 2 signal inputs.

2

Using VERTICAL Controls

Summary

In this module, you learned how to perform the following tasks:

- Set up a TDS3000 oscilloscope for VERTICAL controls.
- Modify the vertical scale calibration by using the VERTICAL **SCALE** knob.
- Position a waveform on the vertical scale by using the VERTICAL **POSITION** knob.
- Use the VERTICAL controls to modify the acquisition and display of a waveform.
- Simultaneously display waveforms for all input channels.
- View a detailed display of a waveform by changing the input coupling.
- Display an expanded vertical view of a selected portion of a waveform by using the vertical offset controls and the VERTICAL **SCALE** knob.
- Use the **CH1-CH2** MATH function to extract a small differential heartbeat signal from a large common mode sine wave signal.

3

Using HORIZONTAL Controls

This module focuses on the HORIZONTAL controls of a TDS3000 oscilloscope. In this module, you will use various procedures to modify a displayed waveform by using the HORIZONTAL controls.

This module includes the following sections:

- Setting Up a TDS3000 Oscilloscope for HORIZONTAL Controls
- Operating HORIZONTAL Controls

3

Using HORIZONTAL Controls

Setting Up HORIZONTAL Controls

Figure 3.1 shows the HORIZONTAL controls of a TDS3000 oscilloscope.



Figure 3.1: TDS3000 HORIZONTAL controls

Before you begin using the HORIZONTAL controls, you must set up the oscilloscope for operation exercises with the HORIZONTAL controls.

The following procedure sets up a TDS3000 oscilloscope for use with the HORIZONTAL controls.

This procedure will enable you to set the oscilloscope to its default settings for use with HORIZONTAL controls.

To set up a TDS3000 oscilloscope for the HORIZONTAL controls, follow these steps:

1. Connect a P6139A 10X passive voltage attenuation probe to the **CH1** connector on the front panel.
2. Connect the CH1 probe tip to the **D-10 MHz** signal on pin 3 and the CH1 probe ground lead to **GND** on pin 1 of the Training 1 signal board.
3. Remove the CH2 probe from the CH2 input connector, and then remove the CH2 probe tip and the ground lead from the Training 1 signal board.

3

Using HORIZONTAL Controls

4. On the Training 1 signal board, push the **POWER** button until the **Digital PWR** light is on.
5. On the top of the front panel, push the **SAVE/RECALL** menu button.
6. Push the appropriate bottom-screen menu button to select **Recall Factory Setup**.
7. Push the appropriate side-screen menu button to select **OK Confirm Factory Init**.
8. In the ACQUIRE section, push the **AUTOSET** button.

You will see a waveform similar to that shown in Figure 3.2.



Figure 3.2: CLOCK Signal

Notice that Figure 3.2 shows a bar graph with brackets on the top of the screen. The bar is of the same color as the selected channel, MATH, or REF, and represents the total record length of the waveform(s) on screen. The brackets indicate the portion of the waveform(s) displayed on the screen.

3

Using HORIZONTAL Controls

Operating HORIZONTAL Controls

The HORIZONTAL control section has two knobs, the SCALE knob and the POSITION knob.

SCALE knob

The HORIZONTAL SCALE knob is used to adjust the horizontal scale factor of a selected waveform. The horizontal scale of a waveform is measured in seconds/division. If you set the horizontal scale of a waveform as 2 seconds/division, then each division on the horizontal axis of the display graticule represents 2 seconds. Therefore, a graticule with 10 horizontal divisions can represent a waveform with a displayed time of 20 seconds.

POSITION knob

The HORIZONTAL POSITION knob is used to adjust the trigger point location relative to the acquired waveforms.

When you push the COARSE button on the top of the front panel, you can make adjustments with larger increments using the POSITION knob.

After setting up a TDS3000 oscilloscope for HORIZONTAL controls, you can begin the procedures to modify a displayed waveform and take measurements.

Affecting the Acquisition and Display of a Waveform

The HORIZONTAL POSITION knob is used to change the horizontal position of a displayed waveform. You can also use the HORIZONTAL POSITION knob in combination with other controls of the HORIZONTAL section to view specific details of a displayed waveform.

3

Using HORIZONTAL Controls

The following procedure demonstrates the steps to select a portion of a displayed waveform by using the HORIZONTAL POSITION knob.

***Note:** This procedure assumes that the oscilloscope retains the settings from the previous procedure.*

To change the horizontal position of a waveform, follow these steps:

1. In the HORIZONTAL section, push the **zoom** (magnifying glass) button.

Notice that the waveform with bar graph brackets on top of the screen now indicates the total acquired waveform with zoom (magnify) brackets.

You will see a display similar to that shown in Figure 3.3.

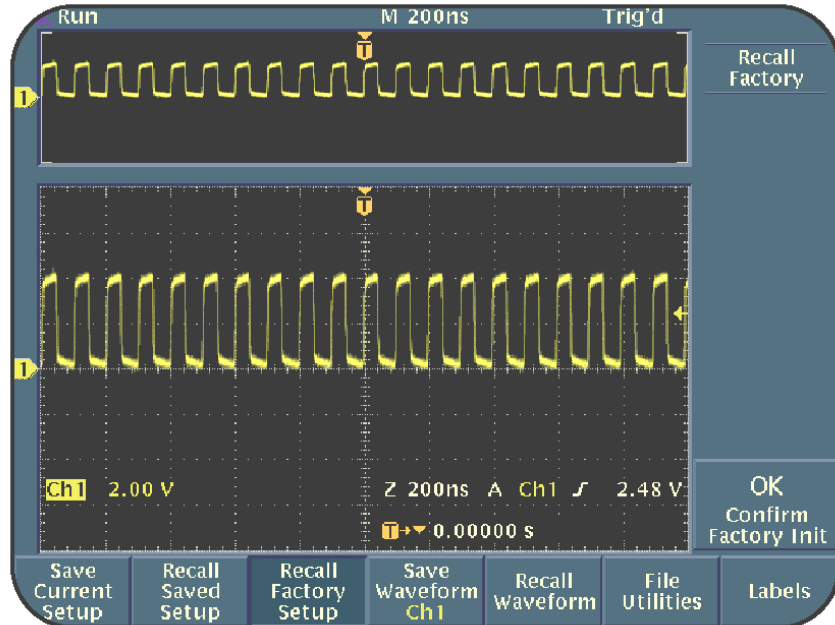

Figure 3.3: Zoom mode waveform display

2. Turn the **HORIZONTAL SCALE** knob clockwise to set the bottom waveform display for **Z 40.0ns**.

This magnifies the displayed waveform centered around the trigger point.

3

Using HORIZONTAL Controls

3. Turn the **HORIZONTAL POSITION** knob clockwise to align the closest rising edge of the lower displayed waveform before the trigger point to the center vertical graticule line of the lower waveform window.
4. Turn the **HORIZONTAL SCALE** knob to further magnify the selected rising edge to **Z 4.00ns** on the display, where Z denotes the zoom mode.
5. In the **ACQUIRE** section, push the **MENU** button.
6. Push the appropriate bottom-screen menu button to select **Horizontal Resolution Normal**.

You will see a waveform similar to that shown in Figure 3.4.

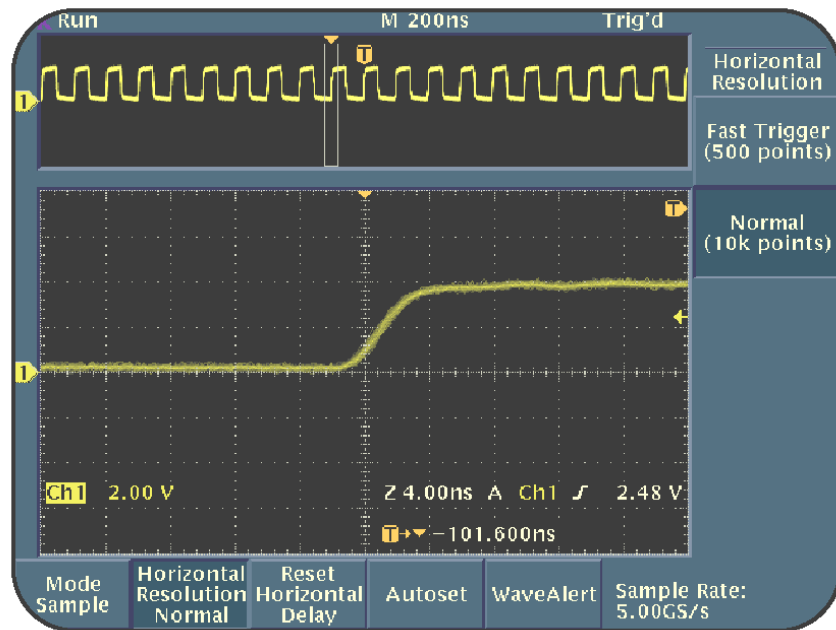

Figure 3.4: Magnified waveform display

In this procedure, you used the HORIZONTAL POSITION knob to select a portion of a displayed waveform. Then, you magnified the selected portion by using the zoom button and the HORIZONTAL SCALE knob.

3

Using HORIZONTAL Controls

Finally, you verified the horizontal resolution to be Normal such that the oscilloscope acquired a 10,000-point waveform. The zoom limit is 200X magnification.

If you set the horizontal resolution to Fast Trigger, the oscilloscope acquires 500-point waveforms at a high repetition rate. This lowers the zoom limit to a 10X magnification.

Changing the Zoom Mode Limits

You can use the zoom mode to magnify the time scale and change the magnification limits. To change the zoom limit, you change the horizontal resolution of the oscilloscope, which in turn changes the record length. The record length is the number of sample points in one complete waveform acquisition. You can select the Fast Trigger (500 points) or Normal (10k points) horizontal resolution modes.

The following procedure enables you to change the zoom limit.

Note: *This procedure assumes that the oscilloscope retains the settings from the previous procedure.*

To change the zoom limit, follow these steps:

1. Push the appropriate side-screen menu button to select **Fast Trigger (500 points)**.
2. In the **HORIZONTAL** section, turn the **POSITION** knob counterclockwise to center the rising edge of the trigger point.

You will see a waveform similar to that shown in Figure 3.5. Notice that the **M40.0ns** display at the top of the oscilloscope screen has a 10X difference with the **Z4.00ns** display at the bottom of the oscilloscope screen, for 500-point acquisitions in the **Fast Trigger** mode.

3

Using HORIZONTAL Controls

3. Push the appropriate side-screen menu button to select **Normal (10k points)**.
4. Push the appropriate side-screen menu button to select **Fast Trigger (500 points)**.

The zoom limit changes from 10X in the **Fast Trigger** mode to 50X in the **Normal** mode. The zoom limit for the **Normal** mode is 200X.

You will see a waveform similar to that shown in Figure 3.5.

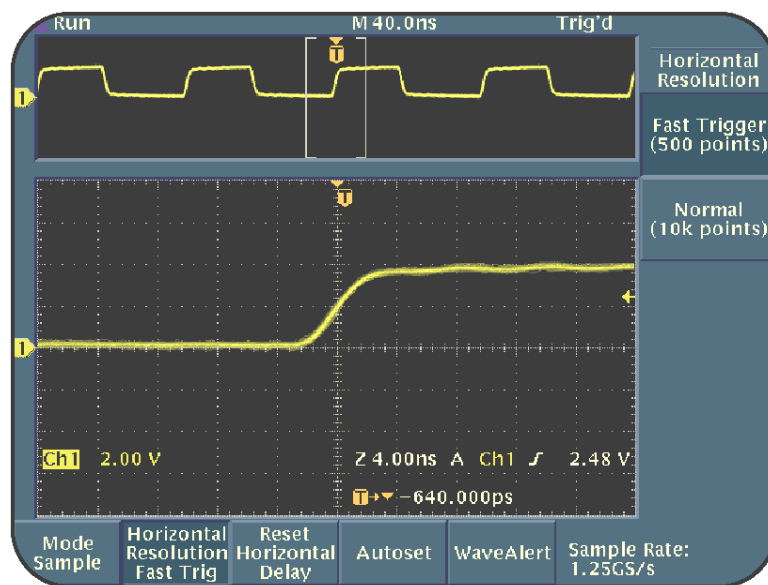

Figure 3.5: Magnified display with Fast Trigger (500 points) mode

When you switch between Fast Trigger (500 points) and Normal (10k points), the oscilloscope maintains the main waveform at the same time per division setting to ensure a constant view. This means that the sample rate, on the bottom of the oscilloscope display, changes by as much as 20 to 1. This occurs when you switch between 500 points and 10,000 points.

Delaying the Acquisition of a Waveform

The A trigger is the main reference for all acquisitions in a TDS3000 oscilloscope. However, you can also set a B-trigger to trigger events that occur after the A trigger. A TRIG and B TRIG can have separate sources, coupling, polarity, and levels.

In digital systems, one event may be used to enable the start of another event. However, the second event may not always be at a predictable time delay from the first enabling event. You can use the DELAY function in combination with the B trigger to reference the second event.

3

Using HORIZONTAL Controls

The following procedure enables you to use a second trigger to stabilize a displayed signal that is enabled after a specified delay from the first trigger.

To delay the signal acquisition to the B TRIG, follow these steps:

1. Connect the CH1 probe tip to the **BURST** signal on pin 4 and the CH1 probe ground lead to **GND** on pin 1 of the Training 1 signal board.
2. On the Training 1 signal board, push the **POWER** button until the **Digital PWR** light is on.
3. On the top of the front panel, push the **SAVE/RECALL** menu button.
4. Push the appropriate bottom-screen menu button to select **Recall Factory Setup**.
5. Push the appropriate side-screen menu button to select **OK Confirm Factory Init**.
6. In the **VERTICAL** section, turn the **SCALE** knob to set CH1 for **2.00V** on the oscilloscope display.

7. In the TRIGGER section, turn the **LEVEL** knob to set the trigger level for **3.00 V** on the oscilloscope display.
8. In the ACQUIRE section, turn the **WAVEFORM INTENSITY** knob to increase the intensity of the displayed waveform to maximum.
9. In the **HORIZONTAL** section, turn the **POSITION** knob counterclockwise until the first pulse after the trigger is aligned with the center vertical graticule line.

In this step, you introduced a delay of about **1.45000ms**.

10. Turn the **HORIZONTAL SCALE** knob to set the timebase to **M 1.00us**.
11. Turn the **HORIZONTAL POSITION** knob to position the waveform at the center of the oscilloscope display as best as possible.

3

Using HORIZONTAL Controls

You will see a waveform similar to that shown in Figure 3.6. These unstable signals overlapping on the screen are an overlap of many different delay conditions.

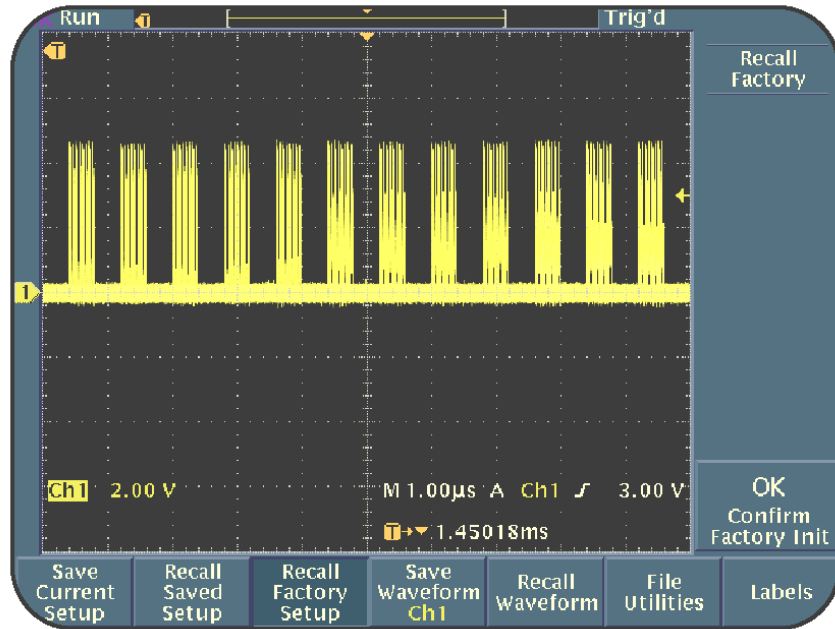

Figure 3.6: Unstable overlapping waveforms

Notice that the trigger markers show that the trigger point is positioned before the acquired waveform. The delay time, shown in the readout on the oscilloscope display, is the time from the trigger point to the expansion point at the center screen.

12. In the **TRIGGER** section, push the **MENU** button.
13. Push the appropriate bottom-screen menu button to select **Mode Auto & Holdoff**.
14. Push the appropriate side-screen menu button to select **Holdoff (Time)**.
15. At the top of the front panel, turn the **general purpose** knob to set the holdoff time between **10.000us** and **11.000us**.

Notice that the waveform still overlaps on the oscilloscope display.

16. In the **HORIZONTAL** section, turn the **SCALE** knob to set the timebase to **M 400us**.
17. Turn the **HORIZONTAL POSITION** knob clockwise until the larger orange **T** at the top of the display is two divisions left from the center of the oscilloscope display.

3

Using HORIZONTAL Controls

18. In the TRIGGER section, push the **B TRIG** button.
19. Turn the **LEVEL** knob to set the B-trigger level for **3.00 V** on the display.
20. Push the appropriate side-screen menu button to select **Set to Delay Time (B)**.

Notice that the **B Trigger After A** changes to about **800us**. This means that B Trig is now enabled after a delay of about **800us**.

21. In the **HORIZONTAL** section, turn the **SCALE** knob to set the time base to **M 100ns**.

You should now see a stabilized B trigger display as shown in Figure 3.7.

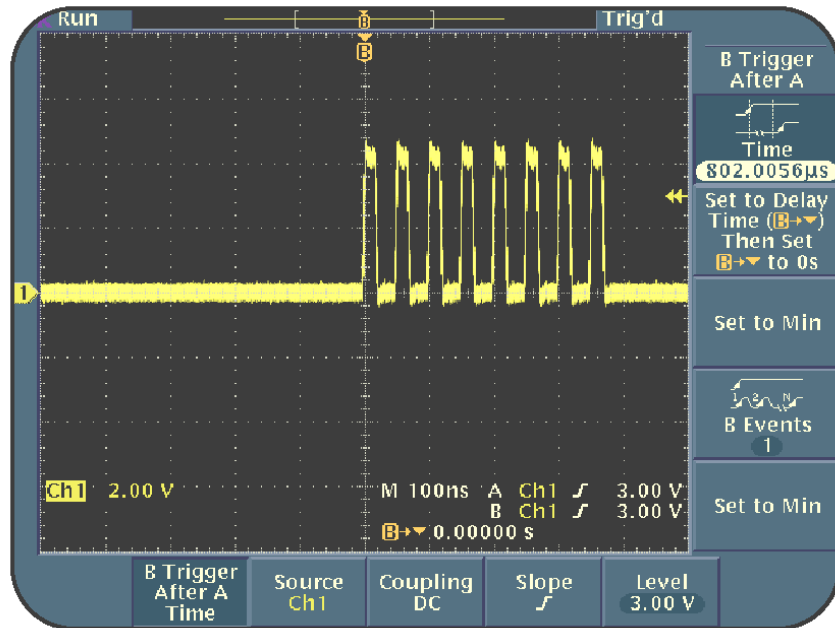

Figure 3.7: B TRIG enabled after a delay of about 800µs

This procedure enables B-trigger after A-trigger to stabilize unpredictable delayed events on the display. To summarize, you can use a second trigger (B Trig) to stabilize a displayed signal that is enabled after a specified delay from the first trigger (A Trigger).

3

Using HORIZONTAL Controls

Summary

In this module, you learned to perform the following tasks:

- Set up a TDS3000 oscilloscope for use with the HORIZONTAL controls.
- Modify the horizontal scale of a displayed waveform using the HORIZONTAL **SCALE** knob.
- Change the horizontal position of a displayed waveform using the HORIZONTAL **POSITION** knob.
- Select a portion of a displayed waveform using the HORIZONTAL **POSITION** knob.
- Expand the selected portion of a waveform by using the zoom function and the HORIZONTAL **SCALE** knob.
- Change the zoom limit.
- Delayed the acquisition of a waveform to be after A trigger by the **DELAY** function so that **B TRIG** can stabilize the uncertain delayed signal.

4

Using TRIGGER Controls

This module focuses on the TRIGGER controls of a TDS3000 oscilloscope. The module provides procedures that you can use to modify a displayed waveform by using TRIGGER controls.

This module includes the following sections:

- Setting Up a TDS3000 Oscilloscope for TRIGGER Controls
- Operating TRIGGER Controls

4

Using TRIGGER Controls

Setting Up TRIGGER Controls

Figure 4.1 shows the TRIGGER controls of a TDS3000 oscilloscope.



Figure 4.1: TDS3000 TRIGGER controls

The trigger function of an oscilloscope synchronizes the horizontal sweep at the correct point of the signal, which is essential for clear signal characterization.

TRIGGER controls allow you to stabilize repeating signals and capture single-shot waveforms. Before you can use the TRIGGER for operation exercises, you must ensure that the oscilloscope is set to its default setting.

To set up a TDS3000 oscilloscope for the TRIGGER controls, follow these steps.

1. Connect the CH1 probe tip to the **PSEUDO RANDOM** signal on pin 5 and the CH1 ground lead to **GND** on pin 7 of the Training 1 signal board.
2. On the Training 1 signal board, push the **POWER** button until the **Digital PWR** light is on.
3. On the top of the front panel, push the **SAVE/RECALL** menu button.

4

Using TRIGGER Controls

4. Push the appropriate bottom-screen menu button to select **Recall Factory Setup**.
5. Push the appropriate side-screen menu button to select **OK Confirm Factory Init**.
6. In the ACQUIRE section, push the **AUTOSET** button.
7. In the **VERTICAL** section, turn the **SCALE** knob to set Ch1 for **1.00V** on the oscilloscope display.
8. Use the **VERTICAL POSITION** knob to center the trace.

You will see a waveform similar to that shown in Figure 4.2.

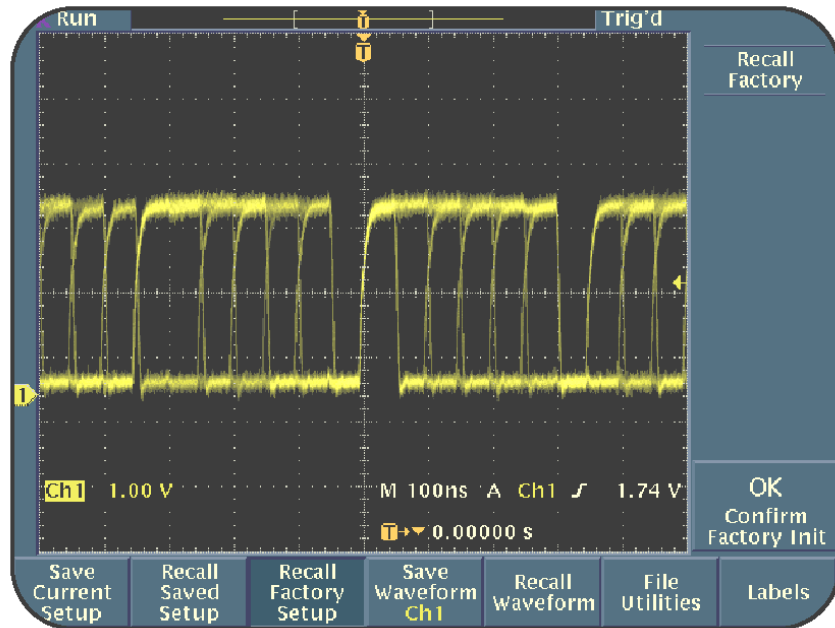

Figure 4.2: Pseudo random signal

Your TDS3000 oscilloscope is now set up for use with the TRIGGER controls. The next section covers various procedures that you can use to trigger complex signals and examine waveform details that are difficult to detect.

4

Using TRIGGER Controls

Operating TRIGGER Controls

After you set up a TDS3000 oscilloscope for TRIGGER controls, you can set a trigger for incoming signals. The advanced triggering functions of a TDS3000 oscilloscope allow you to trigger a complex signal and examine signal details.

Using Edge Triggering

You use Edge triggering to trigger on the rising or falling edge of an input signal at the signal threshold.

The following procedure enables you to locate and identify signal details by using Edge triggering.

Note: *This procedure assumes that the oscilloscope retains the settings from the previous procedure.*

To use Edge triggering to trigger on a signal, follow these steps:

1. In the **TRIGGER** section, push the **MENU** button.
2. Push the appropriate bottom-screen menu button to select **Type Edge**.

3. Push the appropriate bottom-screen menu button to select **Source**.

Ensure that **Ch1** is selected as the source.

4. Push the appropriate bottom-screen menu button to select **Coupling**.

5. Push the appropriate side-screen menu button to select **DC**.

This option may be selected by default.

6. Push the appropriate bottom-screen menu button to select **Slope**.

7. Push the appropriate side-screen menu button to select the **rising edge** option.

This option may be selected by default.

8. Push the appropriate bottom-screen menu button to select **Mode Auto & Holdoff**.

4

Using TRIGGER Controls

9. Push the appropriate side-screen menu button to select **Normal**.
10. Push the appropriate bottom-screen menu button to select **Level**.

This enables you to set the trigger level with the general purpose knob.

11. Turn the **general purpose** knob clockwise very slowly until the trigger level is set to **4.00V**.

This sets the oscilloscope to trigger only on the most positive trigger conditions of the signal. When the trigger level is adjusted past the most positive part of the signal, the **Normal** trigger mode freezes the last acquired waveform.

You will see a waveform similar to that shown in Figure 4.3.

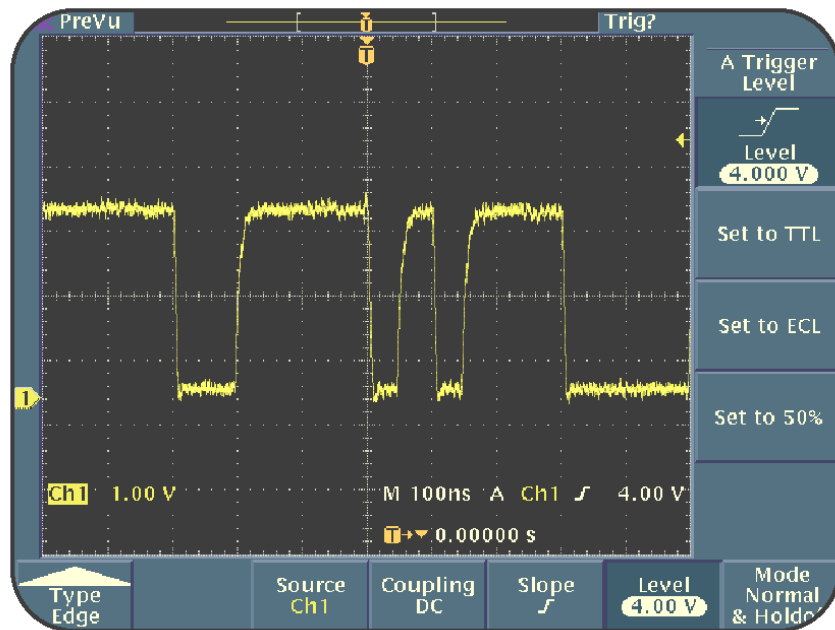

Figure 4.3:Edge triggering

Notice that the waveform shown in Figure 4.3 isolates and displays the most positive signal condition that was not visible in Figure 4.2. This is because one pulse width in this repeating complex signal has a higher amplitude. You can often locate and view such signal details by adjusting the trigger level for different values.

4

Using TRIGGER Controls

Using Variable Trigger Holdoff

You can use variable trigger holdoff on a TDS3000 oscilloscope to stabilize a complex repeating signal on the oscilloscope display.

The following procedure enables you to set a TDS3000 oscilloscope to trigger on a complex repeating signal.

Note: *This procedure assumes that the oscilloscope retains the settings from the previous procedure.*

To use trigger holdoff to trigger on a complex repeating signal, follow these steps:

1. In the TRIGGER section, push the **Set To 50%** button.
2. Push the appropriate bottom-screen menu button to select **Mode Normal & Holdoff**.
3. Push the appropriate side-screen menu button to select **Holdoff (Time)**.
4. On top of the front panel, turn the **general purpose** knob to set the holdoff time on the oscilloscope display for **5.90us**.

You will see a waveform similar to that shown in Figure 4.4.

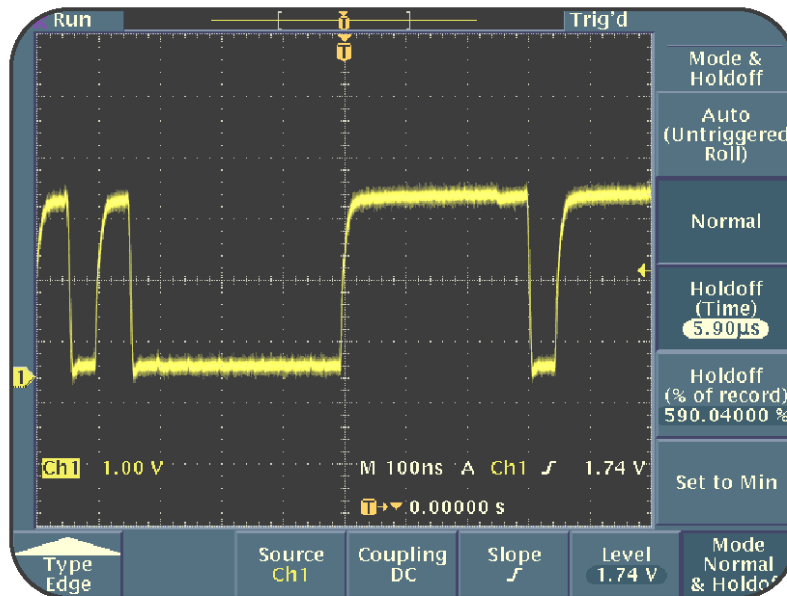

Figure 4.4: Triggering on complex repeating signals using trigger holdoff

In the above procedure, you set a TDS3000 oscilloscope to trigger on a complex repeating signal using trigger holdoff. This allows you to stabilize on the same part of the signal each time a triggered acquisition is displayed.

4

Using TRIGGER Controls

Assigning Trigger Holdoff for an AM Signal

Triggering a complex repeating signal at the interval of the signal's repeat time displays a stable waveform. You may need to analyze the waveform of the amplitude modulation of a complex repeating signal. For example, you might want to analyze the modulation index of a radio frequency transmitter. To observe a stable display of the amplitude modulation of a complex repeating signal, you must adjust the trigger level within the amplitude modulation region of the displayed waveform, and then assign a trigger holdoff for this amplitude modulation signal.

The following procedure enables you to analyze the amplitude modulation region of a complex repeating signal. You do this by assigning a trigger level and trigger holdoff in the amplitude modulation region of the amplitude modulated signal from pin 9 of the Training 1 signal board.

To assign a trigger holdoff and level for an AM signal, follow these steps:

1. Connect the CH1 probe tip to **AM SIGNAL** on pin 9 and the CH1 probe ground lead to **GND** on pin 8 of the Training 1 signal board.

2. On the Training 1 signal board, push the **POWER** button until only the **Analog PWR** light is on.
3. On the top of the front panel, push the **SAVE/RECALL** menu button.
4. Push the appropriate bottom-screen menu button to select **Recall Factory Setup**.
5. Push the appropriate side-screen menu button to select **OK Confirm Factory Init**.
6. In the **VERTICAL** section, turn the **SCALE** knob to set CH1 for **500mV** on the oscilloscope display.
7. In the TRIGGER section, turn the **LEVEL** knob to set the trigger level for **1.00 V** on the oscilloscope display.
8. In the **HORIZONTAL** section, turn the **SCALE** knob clockwise to set the timebase at the bottom of the oscilloscope display for **40.0us**.
9. In the **TRIGGER** section, push the **MENU** button.

4

Using TRIGGER Controls

10. Push the appropriate bottom-screen menu button to select **Mode Auto & Holdoff**.
11. Push the appropriate side-screen menu button to select **Holdoff (Time)**.
12. At the top of the front panel, turn the **general purpose** knob clockwise to set the holdoff time to approximately **100us**.
13. In the ACQUIRE section, use the **WAVEFORM INTENSITY** knob to vary the intensity of the displayed waveform to vary the intensity grading of the displayed signal, as you can do with an analog oscilloscope.

This is the intensity grading that the Digital Phosphor Oscilloscope (DPO) provides. The TDS3000 DPO uses a parallel-processing architecture to pass the signal to the raster-type display, which provides intensity graded viewing of signal characteristics in real time.

You will see a waveform similar to that shown in Figure 4.5.

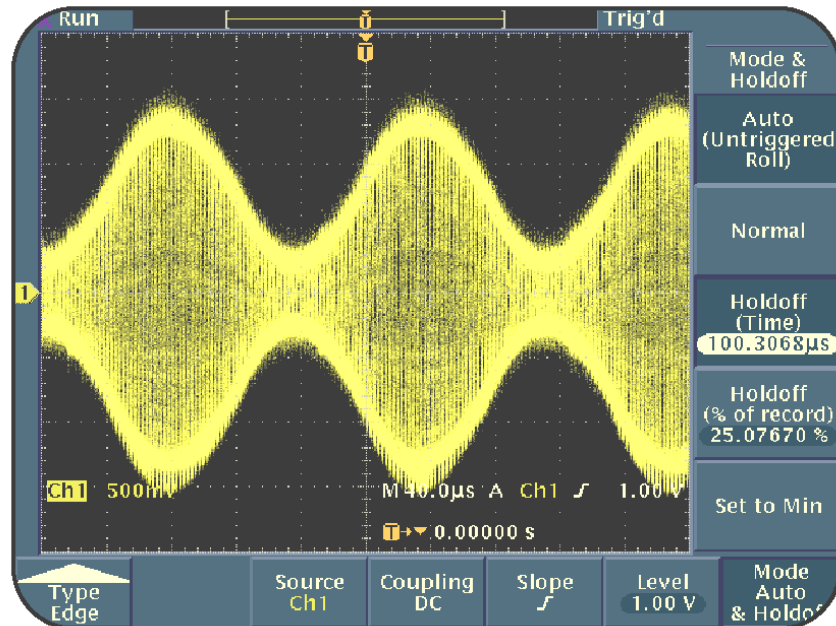

Figure 4.5: AM signal, with trigger holdoff

In this procedure, you stabilized the triggered display of the amplitude modulation region of a complex repeating signal. You did this by assigning a trigger holdoff in the amplitude modulation region of the signal.

4

Using TRIGGER Controls

Summary

In this module, you learned to perform the following tasks:

- Set up a TDS3000 oscilloscope for TRIGGER controls.
- Locate and identify signal details by using **Edge** triggering, combined with **Normal** triggering and trigger level adjustments.
- Use the trigger holdoff to stabilize the display of a complex repeating signal.
- Use the trigger holdoff and level controls to view a stable AM communications signal.

Note: *TDS3000 and TDS3000B models may be equipped with application modules that provide advanced triggering functions. These capabilities may include special Logic, Pulse, Video, and Communication signal triggering functions. This Operator Training Kit does not address these advanced triggering capabilities. For more information about these special triggering functions, you can contact your Tektronix representative for details.*

5

Using ACQUIRE Controls

This module focuses on the ACQUIRE controls of a TDS3000 oscilloscope. This module provides various procedures that you can use to modify a displayed waveform by using the ACQUIRE controls.

This module includes the following sections:

- Setting Up a TDS3000 Oscilloscope for ACQUIRE Controls
- Operating ACQUIRE Controls

5

Using ACQUIRE Controls

Setting Up ACQUIRE Controls

Figure 5.1 shows the ACQUIRE controls of a TDS3000 oscilloscope.



Figure 5.1: TDS3000 ACQUIRE controls

Before you begin using the ACQUIRE controls, you must set up the oscilloscope for operation exercises with the ACQUIRE controls.

This section provides a setup procedure for the ACQUIRE controls. This procedure sets the default settings required for procedures with ACQUIRE controls.

To set up a TDS3000 oscilloscope for ACQUIRE controls, follow these steps:

1. Connect the CH1 probe tip to the **VARIABLE AMPL WITH GLITCH** signal on pin 15 and the CH1 ground lead to **GND** on pin 14 of the Training 1 signal board.
2. On the Training 1 signal board, push the **POWER** button until only the **Analog PWR** light is on.
3. On the top of the front panel, push the **SAVE/RECALL** menu button.
4. Push the appropriate bottom-screen menu button to select **Recall Factory Setup**.

5

Using ACQUIRE Controls

5. Push the appropriate side-screen menu button to select **OK Confirm Factory Init**.
6. In the **TRIGGER** section, push the **MENU** button.
7. Push the appropriate bottom-screen menu button to select **Coupling**.
8. Push the appropriate side-screen menu button to select **HF Reject**.

HF Reject coupling filters the high frequency noise from the input signal.

9. In the TRIGGER section, turn the **LEVEL** knob to set the trigger level to **800mV** on the oscilloscope display.
10. Push the appropriate bottom-screen menu buttons to select **Mode Auto & Holdoff**.

11. Push the appropriate side-screen menu buttons to select **Normal**.
12. In the **VERTICAL** section, turn the **POSITION** knob to position the waveform down to fit the oscilloscope display.
13. In the ACQUIRE section, turn the **WAVEFORM INTENSITY** knob clockwise for maximum display intensity.
14. In the **ACQUIRE** section, push the **MENU** button.
15. Push the appropriate bottom-screen menu button to select **Mode Sample**.

This option may be selected by default.

5

Using ACQUIRE Controls

16. In the **HORIZONTAL** section, turn the **SCALE** knob counterclockwise to set the displayed timebase to **M 200ms**.

You will see a waveform similar to that shown in Figure 5.2.

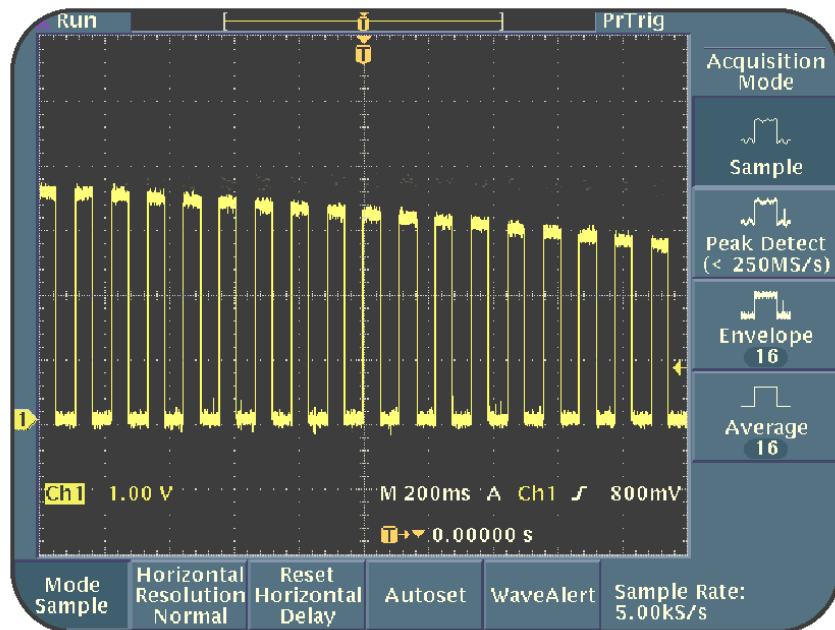

Figure 5.2: Noisy variable amplitude signal

Operating ACQUIRE Controls

You can control how an oscilloscope acquires signals and displays waveforms using the ACQUIRE controls on a TDS3000 oscilloscope.

Displaying Hidden Waveform Details

Figure 5.2 shows a noisy variable amplitude signal. However, the signal has more details than that are visible on the oscilloscope display. You can view the waveform in detail using the controls of the ACQUIRE section.

The following procedure enables you to capture very fast glitches by acquiring a waveform with the SINGLE SEQ acquisition mode, combined with the Peak Detect acquisition mode.

***Note:** This procedure assumes that the oscilloscope retains the settings from the previous procedure.*

To view a signal in detail, follow these steps:

1. In the ACQUIRE section, push the **SINGLE SEQ** button.

5

Using ACQUIRE Controls

2. Push the appropriate side-screen menu button to select **Peak Detect**.
3. Push the **SINGLE SEQ** button again.

You will see a waveform similar to that shown in Figure 5.3.

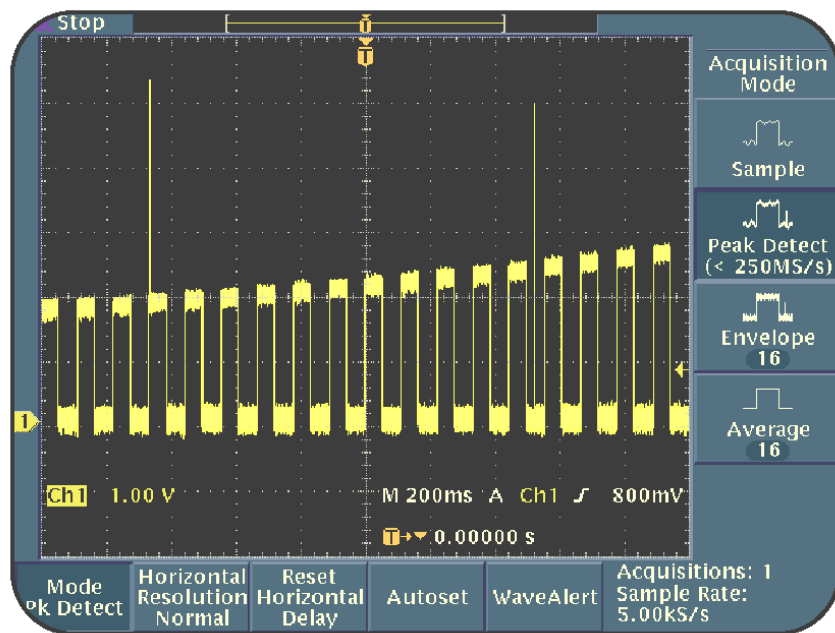

Figure 5.3: Noisy variable amplitude signal with glitches, captured with Peak Detect in SINGLE SEQ mode

In this procedure, you used the Peak Detect acquisition mode to capture glitches with very fast transition times. You can use the Peak Detect acquisition mode to capture fast signal glitches that fall between acquisition samples at slower time base settings. You use the Peak Detect acquisition mode when you need to see high-speed interference that couples into electronic signals. For example, consider a situation where you need to test a complex signal that controls a mechanical robot. You can use the Peak Detect mode to check the signal for glitches caused by various sources, such as light dimmers, motor controls, and design flaws.

Stopping the Acquisition System

In the previous procedure, you used the Peak Detect acquisition mode in the SINGLE SEQ mode to capture very fast transition glitches. You can also view glitches in signals without using the SINGLE SEQ mode.

The following procedure enables you to view signal glitches without the SINGLE SEQ acquisition mode.

5

Using ACQUIRE Controls

Note: *This procedure assumes that the oscilloscope retains the settings from the previous procedure.*

To view signal glitches on a TDS3000 oscilloscope without using the SINGLE SEQ acquisition mode, follow these steps:

1. In the ACQUIRE section, push the **RUN/STOP** button to restart acquisitions.
2. In the ACQUIRE section, turn the **WAVEFORM INTENSITY** knob counterclockwise to decrease the waveform intensity.

Notice how the glitches, as well as the signal transitions, become dim. This is the intensity grading that the Digital Phosphor Oscilloscope (DPO) provides.

You will see a waveform similar to that shown in Figure 5.4.

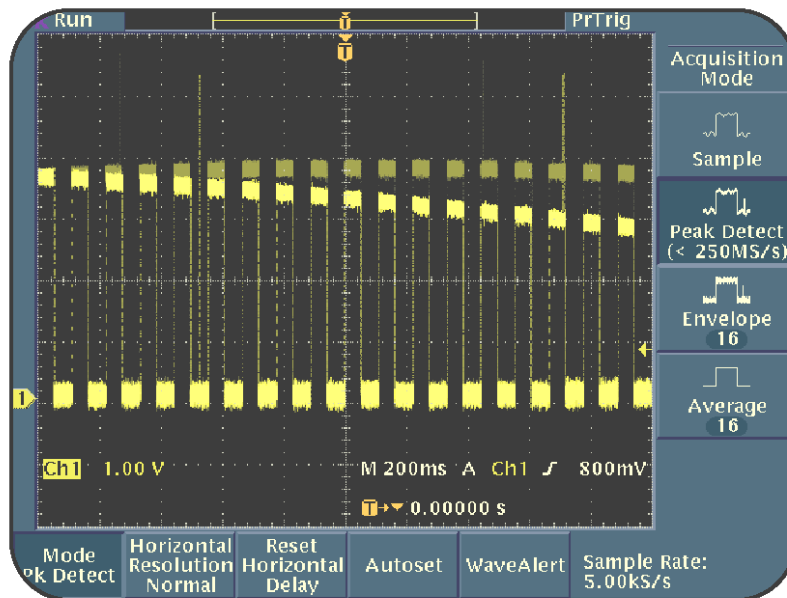

Figure 5.4: Noisy variable amplitude signal with glitches, captured with Peak Detect mode in an intensity graded display

You can see the glitches better by increasing the waveform intensity of the intensity graded display.

Note: You should be in the **Peak Detect** acquisition mode to view glitches for slow time base settings.

5

Using ACQUIRE Controls

Using the Average and Envelope Acquisition Modes

You can use the Average acquisition mode to reduce the random noise in a displayed signal by taking an average of multiple waveforms. The Average acquisition mode uses the Sample acquisition mode to acquire data and then takes an average of multiple waveforms to display a final waveform. You can take an average of 2, 4, 8, 16, 32, 64, 128, 256, or 512 waveforms to display each waveform. The Envelope acquisition mode, on the other hand, is used to continuously accumulate peak-detected waveforms.

The following procedure enables you to reduce the random noise in a displayed signal by taking an average of a number of waveforms. It then enables you to see displayed variation extremes in the acquired signal.

Note: *This procedure assumes that the oscilloscope retains the settings from the previous procedure.*

To use the average and envelope acquisition modes to acquire a waveform, follow these steps:

1. Push the appropriate bottom-screen menu button to select **Mode Pk Detect**.
2. Push the appropriate side-screen menu button to select **Sample**.
3. In the ACQUIRE section, turn the **WAVEFORM INTENSITY** knob clockwise to increase the waveform to maximum intensity.
4. In the **HORIZONTAL** section, turn the **SCALE** knob clockwise to set the displayed time base to **M 20.0ms**.

You can see a noisy trace on the screen.

5

Using ACQUIRE Controls

5. Push the appropriate side-screen menu button to select **Average**.

You can see traces on screen with less noise.

6. In the ACQUIRE section, push the **RUN/STOP** button.
7. In the **VERTICAL** section, turn the **POSITION** knob to move the trace a small amount.

You now see only the last averaged acquisition, as shown in Figure 5.5.

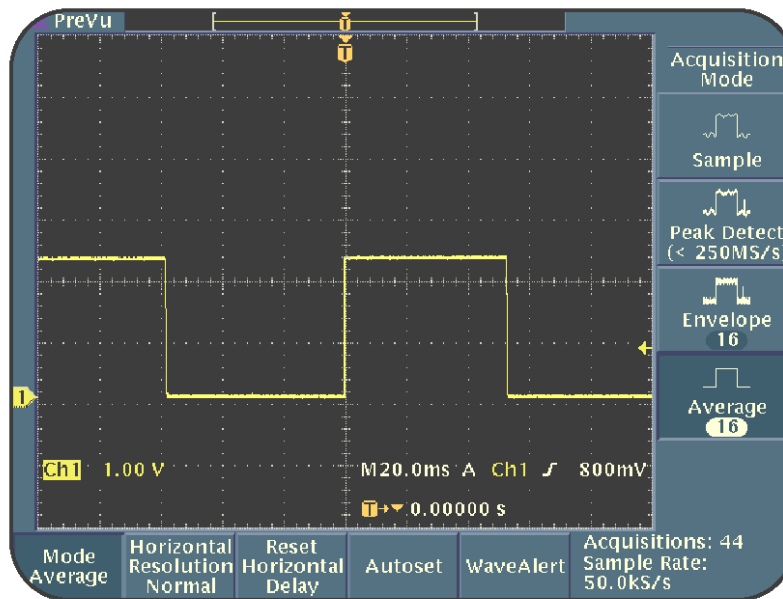

Figure 5.5: Reduced signal noise with the Average acquisition mode

8. In the ACQUIRE section, push the **RUN/STOP** button to restart the acquisitions.
9. Push the appropriate side-screen menu button to select **Envelope**.
10. At the top of the front panel, turn the **general purpose** knob clockwise to set the envelope to **Infinity**.

You will notice enveloped data with spikes as shown in Figure 5.6.

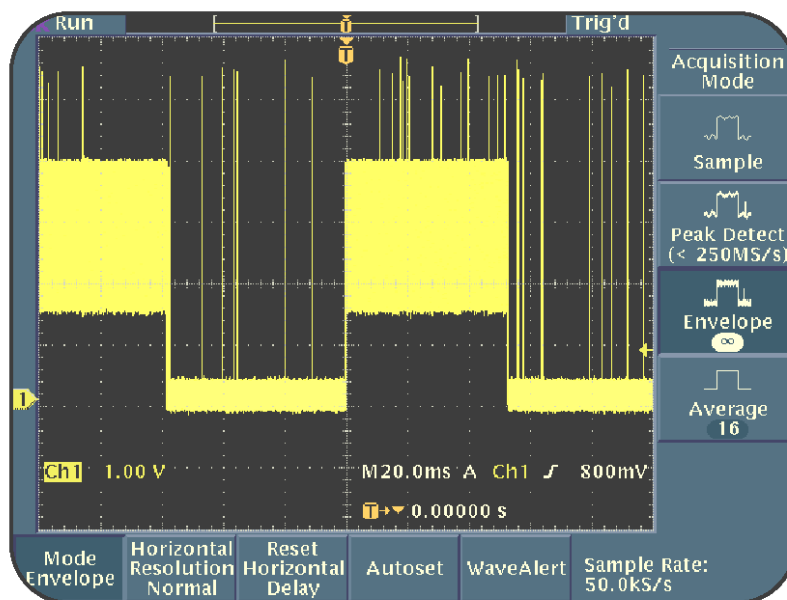

Figure 5.6: Accumulated peak-detected waveforms with the Envelope acquisition mode

5

Using ACQUIRE Controls

You observed that signal noise is reduced when you shift from the Sample to the Average acquisition mode. When you shift to the Envelope mode, you can see both old and new peak-detected data. This is possible because the Envelope mode accumulates peak-detected waveforms continuously until acquisitions are stopped.

Step Response

Probes and ground leads can cause signal distortions. Probe tips and ground leads have both capacitance and inductance. This probe capacitance and inductance can interact with the circuit to cause a damped sinusoidal variation on pulses with fast edge transitions. This effect of a probe tip and a ground lead on a pulse waveform is called ringing. Probe loading caused by a probe tip lead and ground lead can cause incorrect measurements and/or the circuit to fail.

The following procedure enables you to check the amount of signal distortion caused by the probe tip and ground lead.

To perform the step response demonstration, follow these steps:

1. Connect the CH1 probe tip to the **FAST RISE TIME** signal on pin 16 and the CH1 ground lead to **GND** on pin 1 of the Training 1 signal board.
2. On the top of the front panel, push the **SAVE/RECALL** menu button.
3. Push the appropriate bottom-screen menu button to select **Recall Factory Setup**.
4. Push the appropriate side-screen menu button to select **OK Confirm Factory Init**.
5. In the **VERTICAL** section, turn the **SCALE** knob to set CH1 for **200mV** on the oscilloscope display.
6. Turn the **VERTICAL POSITION** knob to position the CH1 trace two divisions above the bottom of the display.

5

Using ACQUIRE Controls

7. In the **HORIZONTAL** section, turn the **SCALE** knob clockwise for a time base readout of **M 4.00ns**.
8. In the **TRIGGER** section, push the **MENU** button.
9. Push the appropriate bottom-screen menu button to select **Mode Auto & Holdoff**.
10. Push the appropriate side-screen menu button to select **Normal**.
11. In the **TRIGGER** section, turn the **LEVEL** knob to set the trigger level to **300mV**.
12. On the Training 1 signal board, push the **PRESS FOR SINGLE SHOT** button to generate a high-speed single shot signal.

You will see a waveform similar to that shown in Figure 5.7.

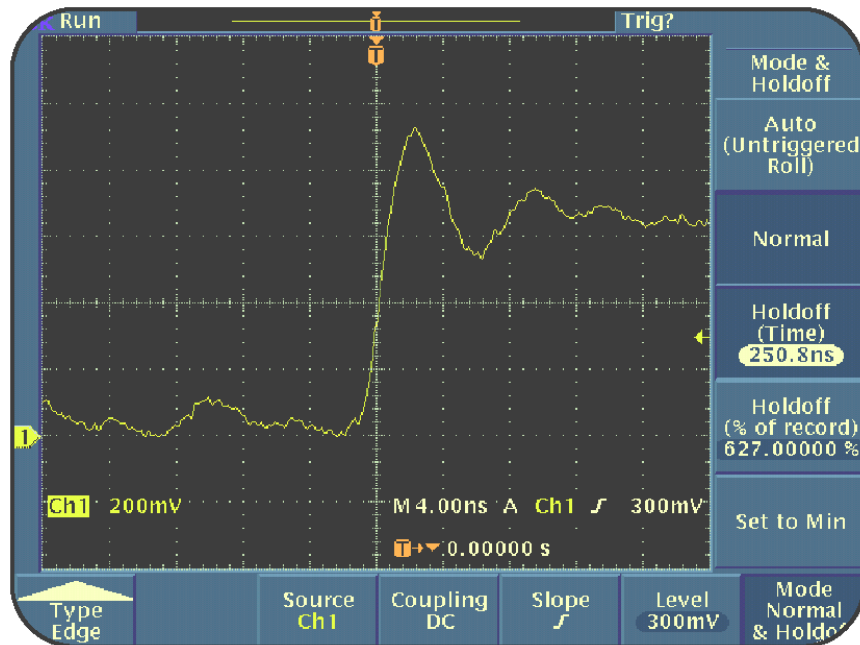

Figure 5.7: Step response waveform with ground lead

Note the large ring caused by the probe tip and the ground lead. The overshoot and ringing in the waveform is caused by the inductance of the probe ground and signal tip leads that interact with the probe and circuit capacitance.

5

Using ACQUIRE Controls

To view the step response signal without overshoot and ringing, follow these steps:

1. Pull the probe tip out of the probe tip lead.
2. Unscrew the plastic barrel sleeve from the probe tip and insert the exposed probe tip into the probe socket. Ensure that the probe barrel is grounded against the socket ground.
3. On the Training 1 signal board, push the **PRESS FOR SINGLE SHOT** button.

Notice that the step response waveform does not have ringing when the probe ground and signal tip leads are kept short.

You will see a waveform similar to that shown in Figure 5.8.

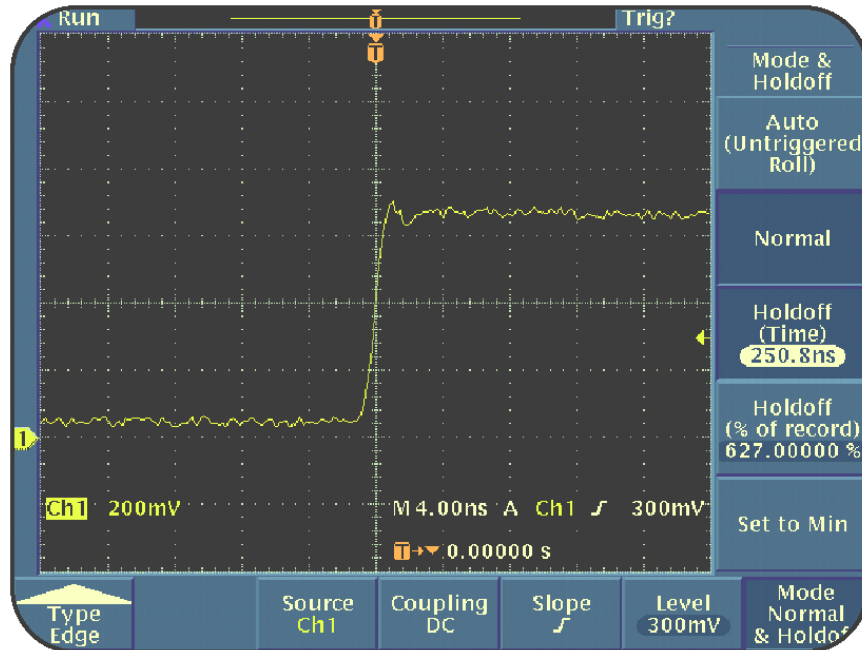

Figure 5.8: Step response waveform, without ground lead and probe tip extension

In this procedure, you used the single shot FAST RISE TIME signal on pin 16 of the Training 1 signal board to check the amount of signal distortion caused by the probe tip and ground lead.

5

Using ACQUIRE Controls

Summary

In this module, you learned how to perform the following tasks:

- Set up a TDS3000 oscilloscope for ACQUIRE controls.
- Modify a displayed waveform using the controls of the ACQUIRE section.
- Start and stop signal acquisitions.
- View hidden waveform details using **Peak Detect** acquisition mode.
- Acquire a waveform by using the **Average** and **Envelope** acquisition modes.
- Isolate signal distortions caused by probe leads and ground leads by using a high-speed single shot pulse.

6

Using Menu Function Controls

This module focuses on the menu function controls of a TDS3000 oscilloscope. In this module, you will learn how to use the menu function controls to measure, save, and modify a displayed waveform.

This module includes the following sections:

- **MEASURE** Menu Function Controls
- **SAVE/RECALL** Menu Function Controls
- **QUICKMENU** Function Controls
- **CURSOR** Menu Function Controls
- **DISPLAY** Menu Function Controls
- **UTILITY** Menu Function Controls

6

Using Menu Function Controls

Setting Up Menu Function Controls



Figure 6.1: TDS3000 front panel menu function controls

Before you begin using the menu function controls, you must set up the oscilloscope for operation exercises with these controls. This section provides a setup procedure for the menu function controls.

To set up a TDS3000 oscilloscope for menu function operations, follow these steps:

1. Connect the CH1 probe tip to the **CLK 20 MHz** signal on pin 2 and the CH1 ground lead to **GND** on pin 1 of the Training 1 signal board.
2. On the Training 1 signal board, push the **POWER** button until the **Digital PWR** light is on.

3. On the top of the front panel, push the **SAVE/RECALL** menu button.
4. Push the appropriate bottom-screen menu button to select **Recall Factory Setup**.
5. Push the appropriate side-screen menu button to select **OK Confirm Factory Init**.
6. In the ACQUIRE section, push the **AUTOSET** button.

You will see a waveform similar to that shown in Figure 6.2.

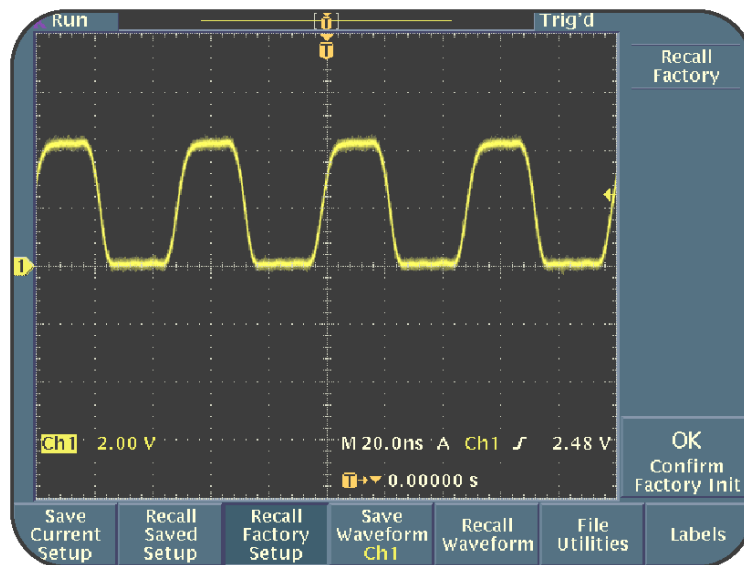

Figure 6.2: 20 MHz CLOCK signal

6

Using Menu Function Controls

Operating the Menu Function Controls

In this section, you will learn how to use the menu function controls in combination with the primary control sections to perform various functions, such as measuring a waveform, saving a waveform or a setup, setting factory settings for the oscilloscope, and selecting a display language.

MEASURE Menu Function Controls

You can make automatic measurements on a TDS3000 oscilloscope. For example, you can use the MEASURE menu function controls to measure the frequency, period, amplitude, and rise time of an input signal.

Taking Automatic Measurements

In the following procedure, you will use the MEASURE menu function controls to measure the frequency, positive pulse width, rise time, and amplitude of an input signal.

Note: *This procedure assumes that the oscilloscope retains the settings from the previous procedure.*

To take automatic measurements with a TDS3000 oscilloscope, follow these steps:

1. On the top of the front panel, push the **MEASURE** menu button.
2. Push the appropriate bottom-screen menu button to select **Select Measrmt for Ch1**.

This might be the default selection on your TDS3000 oscilloscope.

3. Push the appropriate side-screen menu button to select **-more-**.

This enables you to cycle between the 21 to 23 possible automated measurements you can make with a TDS3000 oscilloscope.

4. Push the appropriate side-screen menu button to select **-more- 1 of 6**.

6

Using Menu Function Controls

5. Push the appropriate side-screen menu button to select **Frequency**.

Notice that the average signal frequency is **20.00 MHz** and that it updates continuously.

6. Push the appropriate side-screen menu button to select **Positive Pulse Width**. (On TDS3000B models and non-B models with version 3.13 or later firmware, you will need to advance with **-more-** to select the appropriate option.)

Notice that the positive pulse width is updated continuously.

7. Push the appropriate side-screen menu button to select **-more-** until **Rise Time** appears as a selection on the side-screen menu.
8. Push the appropriate side-screen menu button to select **Rise Time**.

Notice that the value updates continuously.

9. Push the appropriate side-screen menu button to select **-more-** until **Amplitude** appears as a selection on the side-screen menu.
10. Push the appropriate side-screen menu button to select **Amplitude**.

Notice that the average amplitude is about **4.10 V** and that it updates continuously.

11. In the lower right corner of the display section, push the **MENU OFF** button.

6

Using Menu Function Controls

You will see a waveform similar to that shown in Figure 6.3.

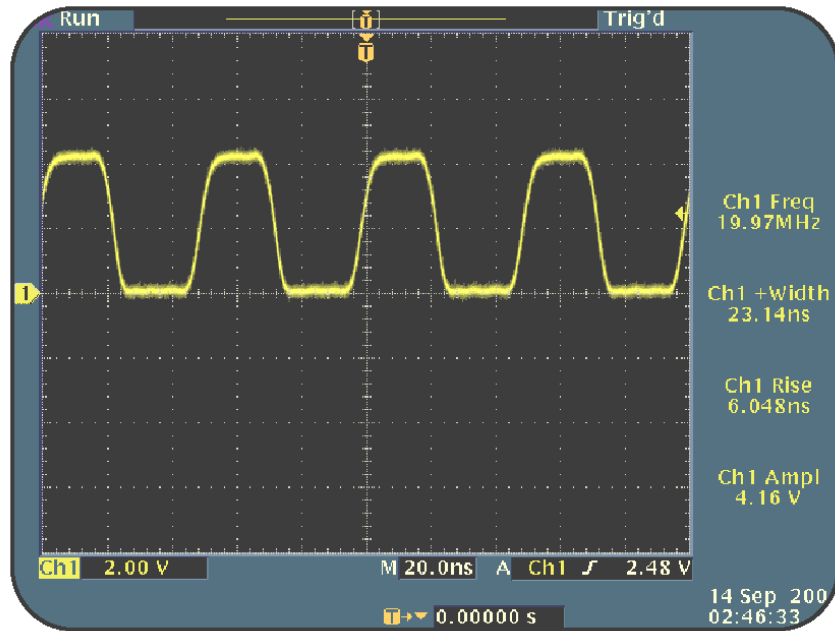

Figure 6.3: Automatic measurements

Figure 6.3 shows the waveform with the four measurements updating automatically. You can use a TDS3000 oscilloscope to take a maximum of four measurements at a time. You can select any input channel, math channel, or reference channel as the input signal for taking measurements.

Measuring Two Signals

In the previous procedure, you took automatic measurements of an input signal. You can also use the MEASURE menu function controls to measure two signals simultaneously.

In the following procedure, you will simultaneously measure two signals by using the MEASURE menu function controls.

***Note:** This procedure assumes that the oscilloscope retains the settings from the previous procedure.*

To measure two signals by using the MEASURE menu function controls, follow these steps:

1. Connect the CH2 probe to the CH2 input connector.
2. Connect the CH2 probe tip to the **PSEUDO RANDOM** signal on pin 5 and the CH2 ground lead to **GND** on pin 7 of the Training 1 signal board.
3. On the Training 1 signal board, push the **POWER** button until the **Digital PWR** light is on.
4. In the VERTICAL section, push the **CH2** button.

6

Using Menu Function Controls

5. In the **VERTICAL** section, turn the **SCALE** knob to set Ch2 for **2.00V** on the oscilloscope display.
6. Turn the **VERTICAL POSITION** knob to position the **CH2** waveform in the lower half of the oscilloscope display.
7. On the top of the front panel, push the **MEASURE** menu button.
8. Push the appropriate bottom-screen menu button to select **Remove Measrmnt**.
9. Push the appropriate side-screen menu button to select **Measurement 4**.
10. Push the appropriate bottom-screen menu button to select **Select Measrmnt for CH2**.
11. Push the appropriate side-screen menu buttons to select **Amplitude**.

You will see a display similar to that shown in Figure 6.4.

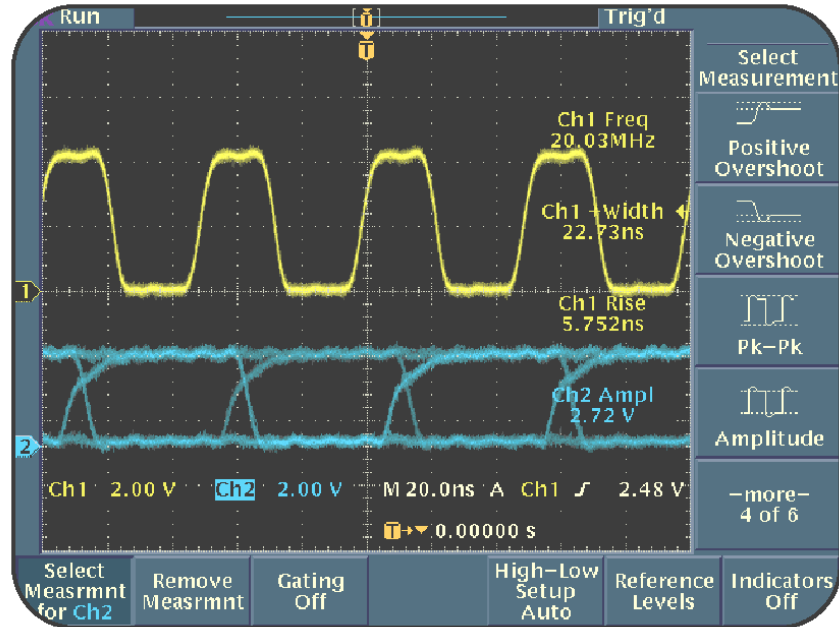

Figure 6.4: Simultaneous amplitude measurement of CH1 and CH2

Observe that the amplitude of CH2 is displayed along with the three measurements on CH1.

6

Using Menu Function Controls

Verifying an Incoming Signal

Sometimes, you may need to verify whether or not an incoming signal has a specified rising edge. Typically, the transition time from a low logic level (0.8 V) to a high logic level (2.0 V) must be 10 ns or less.

The following procedure enables you to verify the rising edge of an incoming signal by using the MEASURE menu function controls.

***Note:** This procedure assumes that the oscilloscope retains the settings from the previous procedure.*

To verify an incoming signal by using the MEASURE menu function controls, follow these steps:

1. On the top of the front panel, push the **SAVE/RECALL** menu button.
2. Push the appropriate bottom-screen menu button to select **Recall Factory Setup**.
3. Push the appropriate side-screen menu button to select **OK Confirm Factory Init**.
4. In the ACQUIRE section, push the **AUTOSET** button.

5. On the top of the front panel, push the **MEASURE** menu button.
6. Push the appropriate bottom-screen menu button to select **Select Measrmnt for CH1**.
7. Push the appropriate side-screen menu button to select **-more-** until **Rise Time** appears as a selection on the side-screen menu.
8. Push the appropriate side-screen menu button to select **Rise Time**.
9. Push the appropriate bottom-screen menu button to select **Reference Levels**.
10. Push the appropriate side-screen menu button to select **Set Levels in units**.
11. Push the appropriate side-screen menu button to select **High Ref**.

6

Using Menu Function Controls

12. On the top of the front panel, use the **general purpose** knob and the **COARSE** button to set the **High Ref** voltage to **2.00V**.

You use the **COARSE** button to make large increments with the general purpose knob. If you see the measurement displayed in fV, pV, uV or mV, you need to use the **COARSE** button in conjunction with the general purpose knob to advance to **2.00V**.

13. Push the appropriate side-screen menu button to select **Low Ref**.

14. On the top of the front panel, use the **general purpose** knob and the **COARSE** button to set the **Low Ref** voltage to **800mV**.

The measurement verifies that the transition time meets the specification of being less than 10ns.

You will see a display similar to that shown in Figure 6.5.

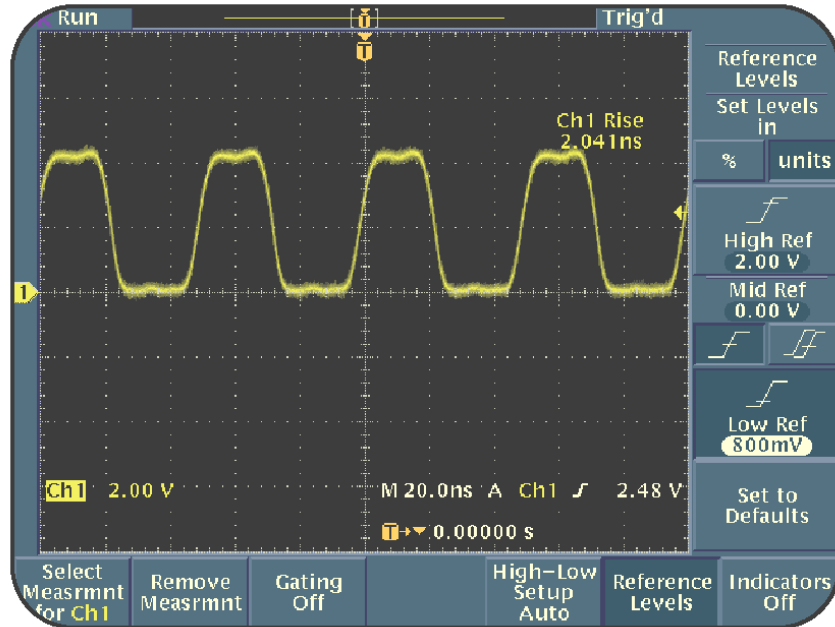

Figure 6.5: Verifying an incoming signal

Rise time is typically measured between the 10% and 90% amplitude levels of a signal. In this procedure, you measured the rise time of the signal between the 0.8 V and 2.0 V levels.

You can also customize the rise time measurement to measure a signal between any two reference levels. You can set each of the two reference levels to a specific percent of the signal amplitude or to a specific level in vertical units, such as volts.

6

Using Menu Function Controls

SAVE/RECALL Menu Function Controls

You can save and recall instrument setups and waveforms in a TDS3000 oscilloscope. You can use the SAVE/RECALL menu function controls to save and recall up to 10 instrument setups.

In addition, the SAVE/RECALL menu function controls allow you to save a waveform from any input channel, MATH, or reference memory location, and save this waveform to one of four nonvolatile memory locations or to a floppy disk.

Saving and Recalling an Instrument Setup

In the following procedure, you will save and recall an instrument setup by using the SAVE/RECALL menu function controls.

Note: *This procedure assumes that the oscilloscope retains the settings from the previous procedure.*

To save and recall an instrument setup in a TDS3000 oscilloscope, follow these steps:

1. On the top of the front panel, push the **SAVE/RECALL** menu button.

2. Push the appropriate bottom-screen menu button to select **Save Current Setup**.

Observe that the side-screen menu provides options to save the selected instrument setup to one of the 10 internal setup memory locations or to a floppy disk.

3. Push the appropriate side-screen menu button to select **To Setup 1**.

If the selected memory location already contains a saved setup, you might need to use the appropriate side-screen menu button to select **OK Overwrite Saved Setup**. Observe that the oscilloscope saves the setup with the current date and time.

4. Push the appropriate bottom-screen menu button to select **Recall Factory Setup**.
5. Push the appropriate side-screen menu button to select **OK Confirm Factory Init**.

You will see an untriggered waveform on the oscilloscope. This waveform appears blurred.

6

Using Menu Function Controls

6. Push the appropriate bottom-screen menu button to select **Recall Saved Setup**.
7. Push the appropriate side-screen menu button to select **Setup 1**.

You will see a waveform similar to that shown in Figure 6.6.

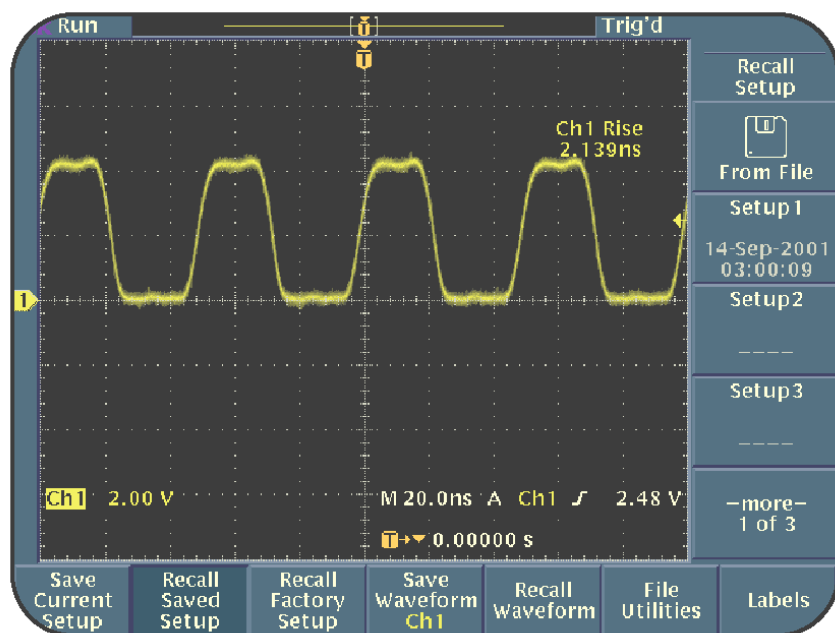

Figure 6.6: Recalled instrument setup

Saving and Recalling a Waveform

In the previous procedure, you saved and recalled an instrument setup using the SAVE/RECALL menu function controls. In this procedure, you will save and recall a waveform to/from a reference location by using the SAVE/RECALL menu function controls.

***Note:** This procedure assumes that the oscilloscope retains the settings from the previous procedure.*

To save a waveform to a reference location, follow these steps:

1. On the top of the front panel, push the **SAVE/RECALL** menu button.
2. Push the appropriate bottom-screen menu button to select **Save Waveform**.
3. Push the appropriate side-screen menu button to select **To Ref1**.

6

Using Menu Function Controls

To recall a saved waveform from a reference location, follow these steps:

1. On the top of the front panel, push the **SAVE/RECALL** menu button.
2. Push the appropriate bottom-screen menu button to select **Recall Waveform**.
3. Push the appropriate side-screen menu button to select **Ref1**.

The reference waveform appears over the original waveform and is displayed in white color.

The following procedure enables you to control the display of the reference waveform, follow these steps.

To modify the position of the reference waveform:

1. In the **VERTICAL** section, turn the **POSITION** knob to move the reference waveform away from the live waveform.

2. In the **VERTICAL** section, push the white **REF** button.
3. In the **VERTICAL** section, push the **OFF** button.
4. Push the appropriate bottom-screen menu button to select **Ref1 (On)**.

You will see a display similar to that shown in Figure 6.7.

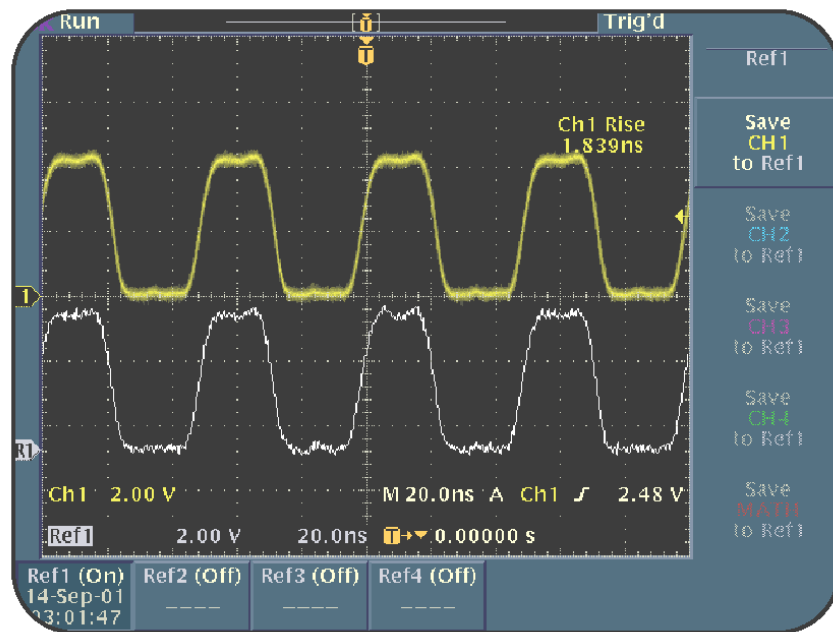

Figure 6.7: Recalled reference waveform

6

Using Menu Function Controls

QUICKMENU Function Control

The QUICKMENU function control enables you to quickly and conveniently access the most frequently used functions of the VERTICAL, HORIZONTAL, TRIGGER, and ACQUIRE sections on the front panel.

The following procedure enables you to use the QUICKMENU function control to access frequently used controls.

***Note:** This procedure assumes that the oscilloscope retains the settings from the previous procedure.*

To access frequently used functions by using the QUICKMENU function control, follow these steps:

1. In the VERTICAL section, push the **CH1** button.
2. On the top of the front panel, push the **QUICKMENU** menu button.
3. Push the appropriate bottom-screen menu button to select (if available first **MENU Scope**, then) **Bandwidth 20 MHz**.

4. Push the appropriate bottom-screen menu button to select **Fast Trigger**.

Note that the signal intensity changes when you select **Fast Trigger**.

5. Push the appropriate bottom-screen menu button to select **Mode Avg 16**.
6. Push the appropriate side-screen menu button to select **Slope** to be on the **falling edge** option.

6

Using Menu Function Controls

You will see a display similar to that shown in Figure 6.8.

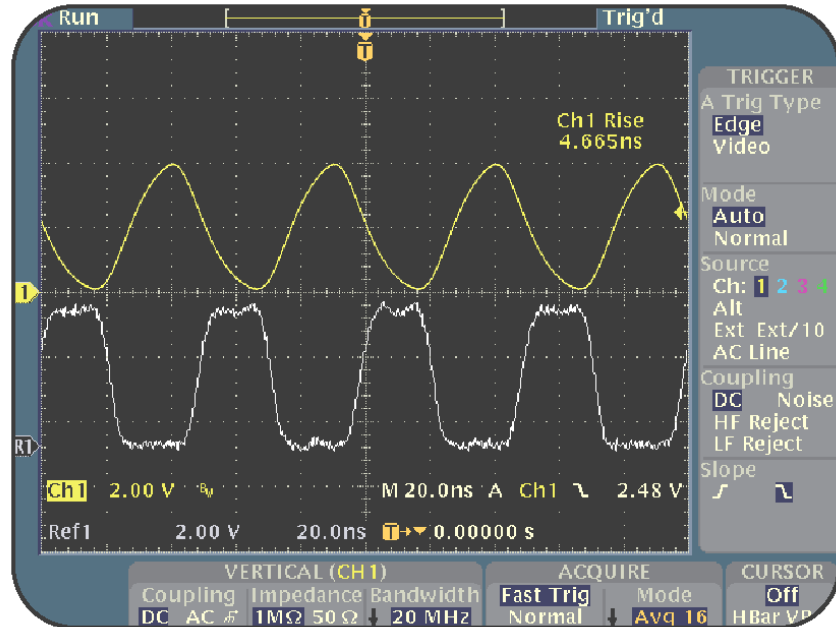

Figure 6.8: QUICKMENU display

You can also use the QUICKMENU display to access and change various oscilloscope setup functions that are not directly accessible through the front panel or a single button push.

CURSOR Menu Function Controls

The CURSOR menu function controls allow you to determine the vertical or horizontal waveform voltage/amplitude and time/frequency values.

You can use the CURSOR menu function controls to manually select the paired horizontal H Bars (voltage) and vertical V Bars (time) and view their positions. You can toggle between the vertical or horizontal cursors by using the SELECT button on the top of the front panel. You can also control the position of these cursors by using the general purpose knob.

The active cursor is displayed as the solid line while the non-active cursor is displayed as the dotted line. The cursor bars and the associated readouts have the same color as the selected waveform.

Determining Baseline and Delta Measurements

Cursors are used to make measurements between two waveform locations. The position of the active cursor is considered the baseline and the distance between the two cursors is considered the delta measurement.

6

Using Menu Function Controls

The following procedure enables you to determine the baseline and delta measurements of both volts and time, when time is selected and voltage is measured.

***Note:** This procedure assumes that the oscilloscope retains the settings from the previous procedure.*

To determine baseline and delta measurements, follow these steps:

1. On the top of the front panel, push the **SAVE/RECALL** menu button.
2. Push the appropriate bottom-screen menu button to select **Recall Factory Setup**.
3. Push the appropriate side-screen menu button to select **OK Confirm Factory Init**.
4. In the ACQUIRE section, push **AUTOSET**.
5. On the top of the front panel, push the **CURSOR** menu button.
6. Push the appropriate bottom-screen menu button to select **Function Off**.
7. Push the appropriate side-screen menu button to select **V Bars**.

8. Push the appropriate side-screen menu button to select **Bring Both Cursors On Screen**.
9. On the top of the front panel, use the **general purpose** knob to position the active cursor at the topmost point of the waveform.
10. On the top of the front panel, push the **SELECT** button.
11. Use the **general purpose** knob to position the active cursor at the lowest point of the waveform.

You will see a display similar to that shown in Figure 6.9.

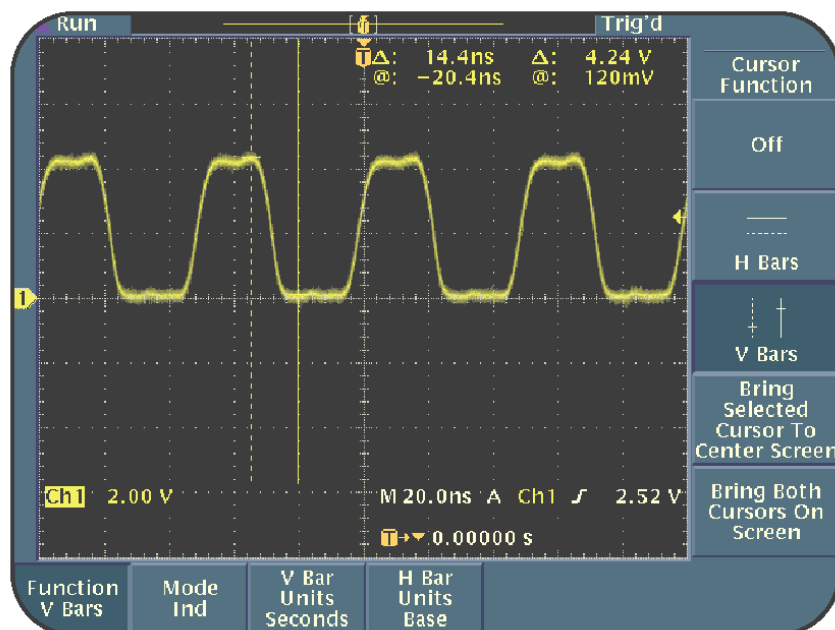

Figure 6.9: Cursors V Bar measurement

6

Using Menu Function Controls

Notice that the vertical cursors provide baseline and delta measurements of both voltage and time, when time is selected and voltage is measured.

DISPLAY Menu Function Controls

The DISPLAY menu function controls allow you to control how waveforms are displayed on a TDS3000 oscilloscope. You can use various menu options of the DISPLAY menu, such as Waveform Display, Backlight Intensity, Graticule, XY Display, and Color Palette, to change the appearance of the waveform display.

Selecting the Display Type

The following procedure enables you to change the appearance of a waveform by changing the display type of the waveform.

To change the display type of a waveform, follow these steps:

1. On the top of the front panel, push the **DISPLAY** menu button.
2. Push the appropriate bottom-screen menu button to select **Backlight Intensity High**.
3. Push the appropriate side-screen menu button to select **Medium**.

4. Push the appropriate bottom-screen menu button to select **Graticule Full**.
5. Push the appropriate side-screen menu button to select **Grid**.
6. Push the appropriate bottom-screen menu button to select **Color Palette Normal**.
7. Push the appropriate side-screen menu button to select **Monochrome**.

You will see a display similar to that shown in Figure 6.10.

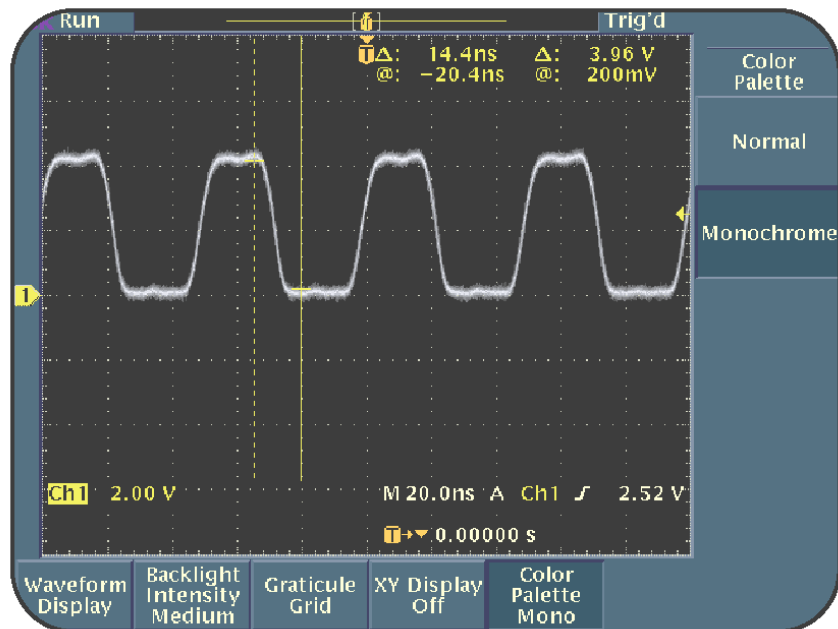

Figure 6.10: Monochrome display mode

6

Using Menu Function Controls

Using the Persistence Mode

You can use the Persist mode to allow old waveform data to remain visible with the current waveform data on the oscilloscope display. You can use persistence to track infrequent signal anomalies that accumulate in the oscilloscope display.

The following procedure enables you to simultaneously view both old and new waveforms by using the Infinite Persistence mode.

To select a persistence time for a displayed waveform, follow these steps:

1. Connect the CH1 probe tip to the **D-10 MHz** signal on pin 3 and the CH1 probe ground lead to **GND** on pin 1 of the Training 1 signal board.
2. On the Training 1 signal board, push the **POWER** button until the **Digital PWR** light is on.
3. At the top of the front panel, push the **SAVE/RECALL** menu button.
4. Push the appropriate bottom-screen menu button to select **Recall Factory Setup**.

5. Push the appropriate side-screen menu button to select **OK Confirm Factory Init**.
6. In the ACQUIRE section, push the **AUTOSET** button.
7. In the **HORIZONTAL** section, turn the **SCALE** knob counter-clockwise to set the timebase for **M 1.00us**.
8. In the ACQUIRE section, turn the **WAVEFORM INTENSITY** knob clockwise to set to maximum intensity.
9. In the ACQUIRE section, push the **RUN/STOP** button.
10. In the **VERTICAL** section, turn the **POSITION** knob to reposition the trace.

6

Using Menu Function Controls

You will see a vector waveform similar to that shown in Figure 6.11.

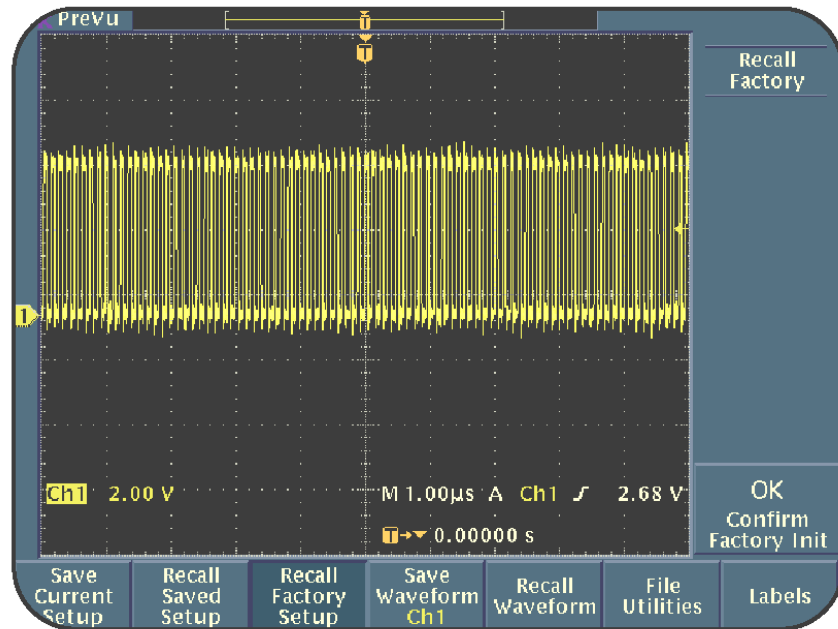

Figure 6.11: Clock signal in vector form

11. On the top of the front panel, push the **DISPLAY** menu button.
12. Push the appropriate bottom-screen menu button to select **Waveform Display**.

13. Push the appropriate side-screen menu button to set **Dots Only On**.
14. In the ACQUIRE section, push the **RUN/STOP** button twice.
15. In the **VERTICAL** section, turn the **POSITION** knob to reposition the trace.

You will see a waveform displayed in dots, similar to that shown in Figure 6.12.

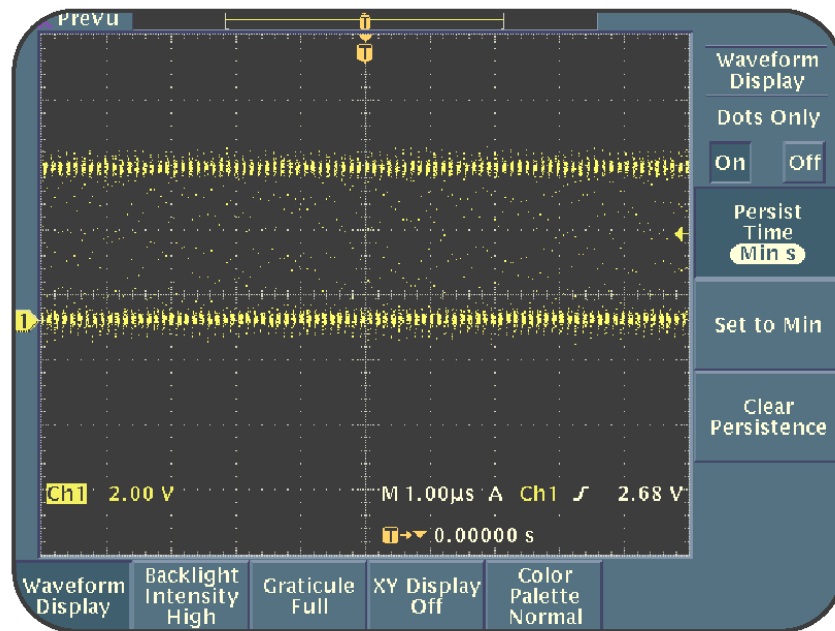

Figure 6.12: Clock signal with Dots Only On

6

Using Menu Function Controls

16. Push the appropriate side-screen menu button to select **Persist Time**.
17. At the top of the front panel, use the **general purpose** knob to select **Infinite**.
18. In the ACQUIRE section, push the **RUN/STOP** button.
19. Disconnect the Ch1 probe tip from the Training 1 signal board.

Notice that the old waveform data remains on the display.

20. In the **VERTICAL** section, turn the **POSITION** knob to reposition the trace.

Notice that the old infinite persistence signal information is erased when a control, such as the **VERTICAL POSITION** knob, is used.

In this procedure, you learned to simultaneously view both old and new waveforms by using the Infinite Persistence mode.

Using the XY Display Mode

You can display waveforms in XY or YT formats. When you choose the XY display format, Channel 1 is displayed on the horizontal axis and other channels can be displayed on the vertical axis. When you choose the YT format, the vertical voltage is displayed in relation to time.

You use the XY display format to measure the phase relationship between two synchronous signals. For example, you can measure a Quadrature Amplitude Modulation (QAM) communication signal with an XY constellation diagram.

The following procedure enables you to see the phase relationship between two synchronous sine waves by displaying the signals in the XY format.

To use the XY format to display a waveform, follow these steps:

1. Connect the CH1 probe tip to the **5KHz SINE** signal on pin 10 and the CH1 ground lead to **GND** on pin 8 of the Training 1 signal board.

6

Using Menu Function Controls

2. Connect the CH2 probe tip to the **PHASE SHIFTED SINE WAVE** signal on pin 11 and the CH2 ground lead to **GND** on pin 14 of the Training 1 signal board.
3. On the Training 1 signal board, push the **POWER** button until only the **Analog PWR** light is on.
4. On the top of the front panel, push the **SAVE/RECALL** menu button.
5. Push the appropriate bottom-screen menu button to select **Recall Factory Setup**.
6. Push the appropriate side-screen menu button to select **OK Confirm Factory Init**.
7. In the **VERTICAL** section, turn the **SCALE** knob to set Ch1 for **200mV** on the oscilloscope display.
8. In the **VERTICAL** section, push the **CH2** button.
9. Turn the **VERTICAL SCALE** knob to set Ch2 for **200mV** on the oscilloscope display.

10. On the top of the front panel, push the **DISPLAY** menu button.
11. Push the appropriate bottom-screen menu button to select **XY Display Off**.
12. Push the appropriate side-screen menu button to select **Triggered XY**.
13. On the Training 1 signal board, turn the **ADJ** knob to display the XY signal as a circle.

You will see a waveform similar to that shown in Figure 6.13.

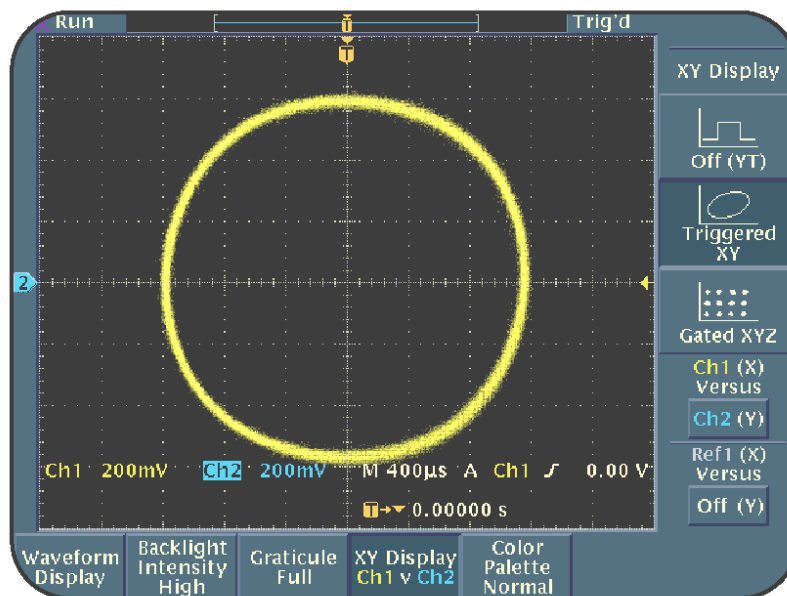

Figure 6.13: Phase relationship between two synchronous sine waves in the XY display format

6

Using Menu Function Controls

You can use the XY display format to measure the phase shift between two synchronous signals with a phase difference. In this case, the circle means that the two signals are both sine waves, and that they are 90 degrees out of phase with respect to each other. On the oscilloscope display, you see the XY signal with CH 1 on the horizontal axis and CH 2 on the vertical axis.

14. In the **VERTICAL** section, push the **MENU** button.
15. Push the appropriate bottom-screen menu button to select **Coupling DC**.
16. Push the appropriate side-screen menu button to select **GND**.

When you select **GND**, the CH 2 waveform is removed from the oscilloscope display. Notice the trigger status **Trig'd** at the top of the oscilloscope display. This is because CH 1 is connected to the triggering circuit and is the triggering signal.

17. Push the appropriate side-screen menu button to select **DC**.

You can see the circle reappear on the oscilloscope display.

18. In the VERTICAL section, push the **CH1** button.
19. Push the appropriate bottom-screen menu button to select **Coupling DC**.
20. Push the appropriate side-screen menu button to select **GND**.

Notice the vertical line that appears on the oscilloscope display. This is because the Ch1 waveform was removed from the circuit. Also notice that the trigger status changed from **Trig'd** to **Auto** at the top of the screen. This is because the CH 1 signal was removed from the trigger circuit. Now, the **Auto** trigger mode makes acquisitions occur without a signal trigger.

21. Push the appropriate side-screen menu button to select **DC**.

Note that the circle reappears on the oscilloscope display.

6

Using Menu Function Controls

22. In the ACQUIRE section, turn the **WAVEFORM INTENSITY** knob to vary the intensity of the displayed waveform.

The **WAVEFORM INTENSITY** knob enables you to vary the intensity of the displayed waveform and see the various intensity grading levels. This simulates the intensity graded feature of an analog oscilloscope display. This is the intensity grading that the DPO provides.

Notice the side-screen menu button, Gated XYZ. The Gated XYZ button is used to gate the XY mode by a third channel. Using the Gated XYZ mode, you can qualify XY sample pairs with a third gating signal. This is important when analyzing serial communication signals.

Quadrature Amplitude Modulation (QAM) requires three channels, I (in phase signal), Q (quadrature signal), and the qualifying clock signal. Measurements are then made by using the Gated XYZ mode to view a constellation diagram of this communication signal. This is called physical layer signal analysis.

In this procedure, you saw the phase relationship between two synchronous sine wave signals by displaying these two signals in the XY format.

UTILITY Menu Function Controls

The UTILITY menu function controls provide access to the different utilities of a TDS3000 oscilloscope. The UTILITY menu function controls enable you to perform various tasks. These tasks may include changing the display language, setting up the hard copy parameters, or executing diagnostic checks on the oscilloscope functions.

The following procedure demonstrates the steps to set up a TDS3000 oscilloscope to save or copy a screen image to a file.

To set up an oscilloscope to save or copy a screen image to a file, follow these steps:

1. Connect the CH1 probe tip to the **CLK 20 MHz** signal on pin 2 and the CH 1 ground lead to **GND** on pin 1 of the Training 1 signal board.
2. On the Training 1 signal board, push the **POWER** button until only the **Digital PWR** light is on.
3. On the top of the front panel, push the **SAVE/RECALL** button.
4. Push the appropriate bottom-screen menu button to select **Recall Factory Setup**.

6

Using Menu Function Controls

5. Push the appropriate side-screen menu button to select **OK Confirm Factory Init**.
6. In the ACQUIRE section, push the **AUTOSET** button.
7. On the top of the front panel, push the **UTILITY** menu button.
8. Push the appropriate bottom-screen menu button to select **System Config**, and then keep pushing the same button until you select **System Hard Copy**.
9. Push the appropriate bottom-screen menu button to select **Format**.
10. Push the appropriate bottom-screen menu button to select **-more-** until **TIFF** appears as a selection on the side-screen menu.
11. Push the appropriate side-screen menu button to select **TIFF**.
12. Push the appropriate bottom-screen menu button to select **Options**.
13. Push the appropriate side-screen menu button to select **Landscape**.

14. Push the appropriate bottom-screen menu button to select **Port**.
15. Push the appropriate side-screen menu button to select **File**.
16. Push the appropriate bottom-screen menu button to select **Format TIFF**.

You will see a display similar to that shown in Figure 6.14.

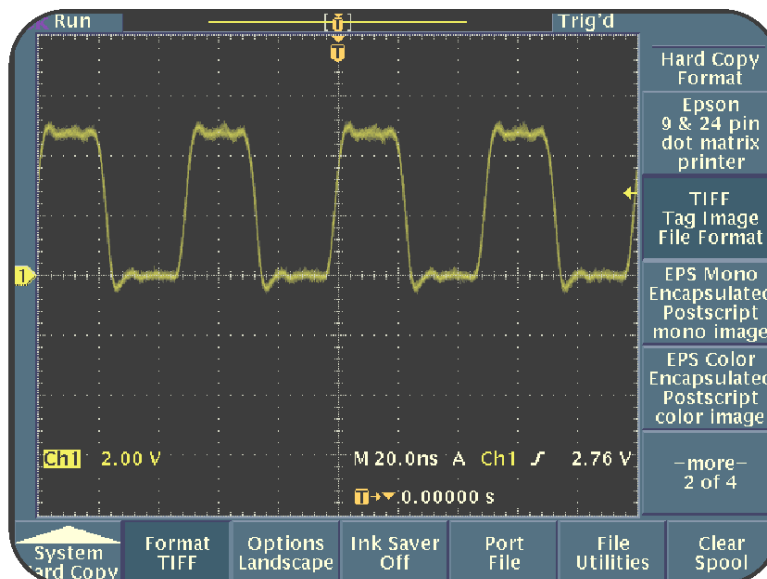

Figure 6.14: Utility setup to save or copy a screen image to a file

Figure 6.14 shows the setup that enables the Hard Copy function. Each time the hard copy button (with a printer icon), located at the lower left corner of the oscilloscope display, is pushed, the defined hard copy setup is executed.

6

Using Menu Function Controls

Summary

In this module, you learned how to use the menu options for the following menu function controls:

- **MEASURE**
- **SAVE/RECALL**
- **QUICKMENU**
- **CURSOR**
- **DISPLAY**
- **UTILITY**

You have now completed all chapters of the TDS 3000 Series Oscilloscope Operator Training Kit.

Tektronix congratulates you for your work to be a better oscilloscope user.

Appendix A

Training 1 Signal Board: Signal Definitions

Appendix A

Training 1 Signal Board: Signal Definitions

Following is the regulatory compliance information for the Training 1 signal board.

European Union	EC Council EMC Directive 89/336/EEC, amended by 93/68/EEC. Demonstrated using: <ul style="list-style-type: none">• IEC 61326:1997 Product Family Standard for Electrical Equipment for Measurement, Control, and Laboratory Use- EMC Requirements• IEC 61000-3-2: AC Powerline Harmonic Emissions
Australia and New Zealand	EMC Framework, demonstrated per Emission Standard AS/NZS 2064 (Industrial, Scientific, and Medical Equipment).
USA	Complies with the requirements of FCC, CFR Title 47, Part 15, Subpart B, Class A.

Appendix A

Training 1 Signal Board: Signal Definitions

Figure A1.1 depicts the layout of the Training 1 signal board.

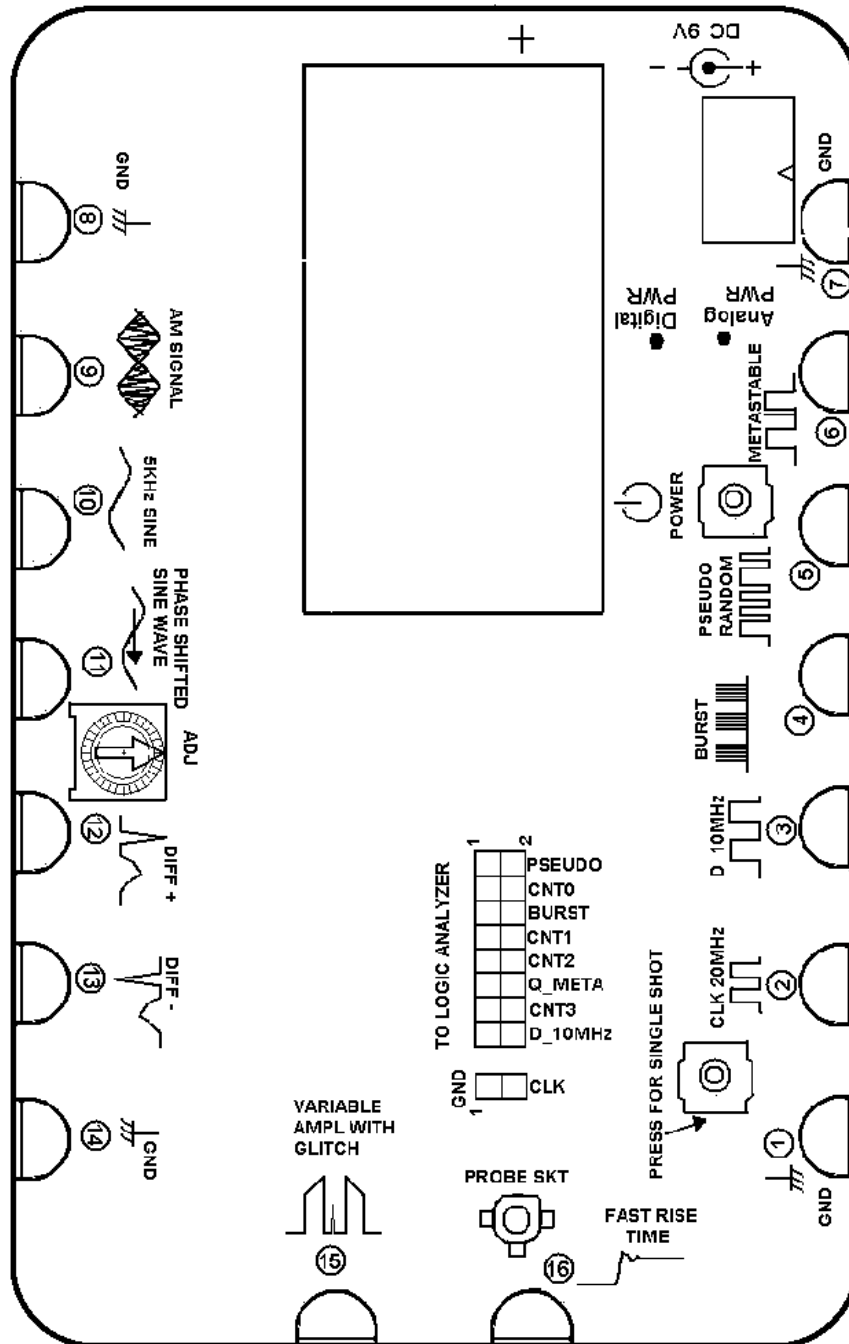

Figure A1.1: Training 1 signal board

Appendix A

Training 1 Signal Board: Signal Definitions

Pins 1, 7, 8, and 14	GND
Description	These pins provide the ground reference for the Training 1 signal board.
Pin 2	CLK 20 MHz
Specification	20 MHz digital signal, 4 V peak-to-peak
Description	This signal is the control clock for all of the digital signals on the Training 1 signal board.
Pin 3	D_10 MHz
Specification	10 MHz digital signal, 4 V peak-to-peak
Description	This signal is a 10 MHz digital data signal.
Pin 4	BURST (also found on the 2x8 pin connector)
Specification	Digital signal, 4 V peak-to-peak
Description	This signal is a repetitive pulse stream consisting of four groups of eight 16 to 24 ns pulses separated by 1.3 ms of inactivity. Verification of this signal requires two measurements at two different time scales.

Appendix A

Training 1 Signal Board: Signal Definitions

Pin 5	PSEUDO RANDOM
Specification	20 MHz digital clock signal, 3 V peak-to-peak
Description	This NRZ/OC1 pseudo random signal can be used to show how to trigger on a complex yet repeating signal sequence, such as a communication signal or computer control signal, with the use of trigger holdoff on a TDS200 or a TDS3000 oscilloscope.
Pin 6	METASTABLE
Specification	Digital signal, 3 V peak-to-peak
Description	This signal is a 10 MHz square wave that contains an occasional glitch caused by a metastable state in the flip-flop. A logic analyzer or an advanced oscilloscope set to trigger on narrow pulse widths will find these glitches.

Appendix A

Training 1 Signal Board: Signal Definitions

Pin 9	AM SIGNAL
Specification	Analog signal Frequency: 5 kHz sine wave with 1 MHz carrier Amplitude: 3 V peak-to-peak
Description	This amplitude modulated signal uses a 5 kHz sine wave signal source and a 1 MHz carrier frequency. The output should look like a sine wave with a positive DC component and an inverted sine wave with a negative DC component with shading between. This signal can be used to show the varying characteristics of one signal being amplitude modulated onto another signal, such as in radio frequency applications. These characteristics can be shown on a TDS200 or a TDS3000 oscilloscope by using trigger holdoff and variable persistence.
Pins 10 and 11	5 kHz SINE and PHASE SHIFTED SINE WAVE
Specification	Analog signal Positive phase shift: 0–135 degrees Frequency: About 5 kHz Amplitude: 1 V

Appendix A

Training 1 Signal Board: Signal Definitions

Description The phase difference between these two 5 kHz sine waves is varied using a potentiometer. The maximum phase shift between the two sine waves is determined by turning the potentiometer to both extremes. This set of signals can be used to demonstrate the phase relationship of two time related signals, such as voltage and current in a power supply, by using the **X/Y** display mode on a TDS200 or a TDS3000 oscilloscope.

Pins 12 and 13 DIFF + and DIFF –

Specification Analog signals

Frequency: 7 Hz, with 1Hz background

Amplitude: 2 V common with 250 mV differential

Description The differential signal from pins 12 and 13 is a 1 Hz heartbeat signal with a 250 mV amplitude. It is combined with a 2 Volt common mode 7 Hz sine wave. This signal can be used to demonstrate how to separate differential signals from common mode signals. Subtracting one channel from another on a TDS200 or a TDS3000 oscilloscope can reject common mode signals.

Appendix A

Training 1 Signal Board: Signal Definitions

Pin 15	VARIABLE AMPL WITH GLITCH
Specification	Analog signal Frequency: 10 Hz Amplitude: Variable between 1 V and 4 V, following sine wave at 0.1Hz rate 20ns asynchronous glitch, 5V amplitude, at 1Hz rate
Description	This signal is a 10 Hz square wave with an amplitude that follows a 0.1 Hz sine wave. In addition, a +5 VDC 20 ns pulse combines with the signal at an asynchronous 1 Hz rate. The glitch is visible on an oscilloscope if the sweep speed is increased and set to trigger on a narrow pulse. This signal can be used to demonstrate how to capture and analyze infrequent high-speed glitches with the use of the Peak Detect acquisition mode on a TDS200 or a TDS3000 oscilloscope.
Pin 16	FAST RISE TIME
Specification	Analog signal Amplitude: About 0.6 V 1 ns to 2 ns rise time

Appendix A

Training 1 Signal Board: Signal Definitions

Description	This signal is a 100 ns wide 0.6 Volt pulse with a rise time of <2 ns. The signal is generated each time the PRESS FOR SINGLE SHOT button is pressed on the Training 1 signal board. This signal can be used to demonstrate the unwanted effects of the ground lead when probing high speed circuits.
2x8 Pin Connector	<p>D_10MHz: Duplicate of the 10 MHz data signal from pin 3.</p> <p>Q_META: Duplicate of the METASTABLE signal from pin 6.</p> <p>PSEUDO: Duplicate of the PSEUDO RANDOM signal from pin 5.</p> <p>CNT0, CNT1, CNT2, and CNT3: This signal is a 10 MHz count pattern that is run continuously</p>

Appendix B

Glossary

Term	Description
AC Coupling	A mode that blocks the DC component of a signal but passes the dynamic (AC) component of the signal. Useful for observing an AC signal that is normally riding on a DC signal.
Acquisition	The process of sampling signals from input channels, digitizing the samples, processing the results into data points, and assembling the data points into a waveform record. The waveform record is stored in memory.
Attenuation	The degree the amplitude of a signal is reduced when it passes through an attenuating device such as a probe or attenuator (the ratio of the input measure to the output measure).
Auto Trigger Mode	A trigger mode that causes the oscilloscope to automatically acquire if it does not detect a valid trigger event.

Appendix B

Glossary

Autoset	A feature that automatically sets the vertical, horizontal, and trigger controls to provide a usable display.
Average Acquisition Mode	A mode in which the oscilloscope acquires and displays a waveform that is the averaged result of several acquisitions. The oscilloscope acquires data as in the sample mode and then averages it according to a specified number of averages. Averaging reduces uncorrelated noise in the displayed signal.
Bandwidth	The frequency range of an oscilloscope used to measure a sine wave signal accurately. Bandwidth specifies the frequency at which the displayed sine wave reduces to 70.7% of the applied sine wave signal amplitude.

Appendix B

Glossary

B Trigger	A second trigger that occurs after a given time or number of events from the main A trigger. The B trigger can be used in combination with the A trigger to capture complex events.
Complex Wave	Combines the characteristics of sine waves, square waves, step waves, and pulse waves.
Cursors	Paired markers that you can use to make measurements between two waveform locations. The oscilloscope displays the values (expressed in volts, time, or frequency) of the position of the active cursor and the distance between the two cursors.
DC Coupling	A mode that passes both AC and DC signal components to the circuit. Available for both the trigger system and the vertical system.

Appendix B

Glossary

Delay	A means to delay the acquisition to start after the trigger event has occurred. The trigger point need not be within a waveform when delay is on.
Display	The word used to refer to the screen of the oscilloscope.
Edge Trigger	Triggering that occurs when the oscilloscope detects the source passing through a specified voltage level in a specified direction (the trigger slope).
Envelope Acquisition Mode	An acquisition mode in which a TDS3000 oscilloscope acquires and displays a waveform that shows the variation extremes of several acquisitions.
External Trigger	Triggering that occurs when the oscilloscope detects the external input signal passing through a specified voltage level in a specified direction.

Appendix B

Glossary

Frequency	Represents the number of times a signal repeats itself in one second. The frequency of a signal is measured in Hertz (Hz).
Ground (GND) Coupling	Coupling option that disconnects the input signal from the vertical system.
Ground Lead	The ground reference lead for an oscilloscope probe.
Hard Copy	An electronic copy of the display in a format useable by a printer or plotter.
Holdoff	A specified amount of time that must elapse after a trigger signal before the trigger circuit will accept another trigger signal. Holdoff helps ensure a stable display.
Horizontal Cursors	The two horizontal bars that you position to measure the voltage parameters of a waveform. The oscilloscope displays the value of the active (moveable) cursor with respect to ground and the voltage value between the bars.

Appendix B

Glossary

Normal Trigger Mode	A mode where the oscilloscope does not acquire a waveform record unless a valid trigger event occurs. It waits for a valid trigger event before acquiring waveform data.
Peak Detect Acquisition Mode	An acquisition mode that captures spikes and glitches that may occur between normal sample points. A mode in which the oscilloscope creates a pair of record points during each sample interval. Each pair consists of the maximum and minimum input voltage during the interval.
Period	A period is the time in which a signal completes one cycle.
Persistence	A method of retaining old data on the display for a period of time. With persistence turned off, the points decay quickly. With persistence on, the points decay more slowly or not at all.
Phase	Movement of a sine wave through 360° in one cycle. Used to calculate the elapsed time from the reference or beginning point of the sine wave.

Appendix B

Glossary

Phase Shift	Refers to the degrees of difference between two similar synchronous signals.
Pretrigger	The specified portion of the waveform record that contains data acquired before the trigger event.
Pulse Wave	Represents a sudden change in signal level followed by a return to the original level.
QuickMenu	An alternate display presentation in a TDS3000 oscilloscope that lets you control the most commonly used functions with the bottom- and side-screen menu buttons.
RS-232	The serial communication port used to connect to a hard-copy device, computer, controller, or terminal.
Record Length	The specified number of samples in a waveform.
Rectangular Wave	Displayed when the high and low time periods of a square wave are unequal.

Appendix B

Glossary

Reference Waveform	A saved waveform selected for display. You can save and display up to four reference waveforms on a TDS200 or TDS3000 oscilloscope, depending on the model.
Rise Time	The time taken by a step or pulse to rise from 10% to 90% amplitude level.
Sample Acquisition Mode	A mode in which the oscilloscope samples and displays each recorded sample point. As more time is required for an acquisition with a fixed record length (by changing the time per division), the sample interval (the time between acquired samples) must increase. This in turn reduces the displayed sample rate.
Sample Interval	The time interval between successive samples in a waveform record. Changing the time base changes the sample interval.

Appendix B

Glossary

Sawtooth Wave	Has a rising rate of change that is different (faster or slower) from the falling rate of change.
Sine Wave	Basic waveform that represents voltage change with time. Signals produced by the oscillator circuit in a signal generator are sine waves. Most AC power sources produce sine waves.
Square Wave	Represents voltage signals that turn on and off at regular intervals. It is a standard wave for testing amplifiers, televisions, radios, and computer circuits.
Step Wave	Indicates a sudden change in voltage, which may be the result of turning on an electric switch.
Sweep Speed	The speed at which a waveform can sweep across the screen of an analog oscilloscope. The sweep speed of an oscilloscope is stated in time per division (sec/div).

Appendix B

Glossary

TekProbe Interface	An interface that communicates information, such as the probe type and its attenuation factor, between a probe and a TDS3000 oscilloscope. The interface also supplies power to active voltage probes.
Time Base	The set of parameters that let you define the time axis attributes of a waveform record. The time base determines how fast and how long to acquire record points.
Triangle Wave	Has a rising rate of change equal to the falling rate of change.
Vertical Cursors	The two vertical bars you position to measure the time parameter of a waveform record. The oscilloscope displays the value of the active cursor with respect to trigger and the time value between the bars.
Vertical Sensitivity	The range within which an amplifier can amplify a weak signal. Vertical sensitivity is stated in volts per division (volts/div).

Appendix B

Glossary

Video Trigger	Triggering on the line or field sync pulses of a composite video signal.
XY Format	A display format that compares the voltage level of two waveform records point by point. It is useful for studying phase relationships between two waveforms.
YT Format	The conventional oscilloscope display format. It shows the voltage of a waveform record (on the vertical axis) as it varies over time (on the horizontal axis).