

GE
Measurement & Control

Druck DPI 104

Digital Pressure Indicator
User manual - K0394

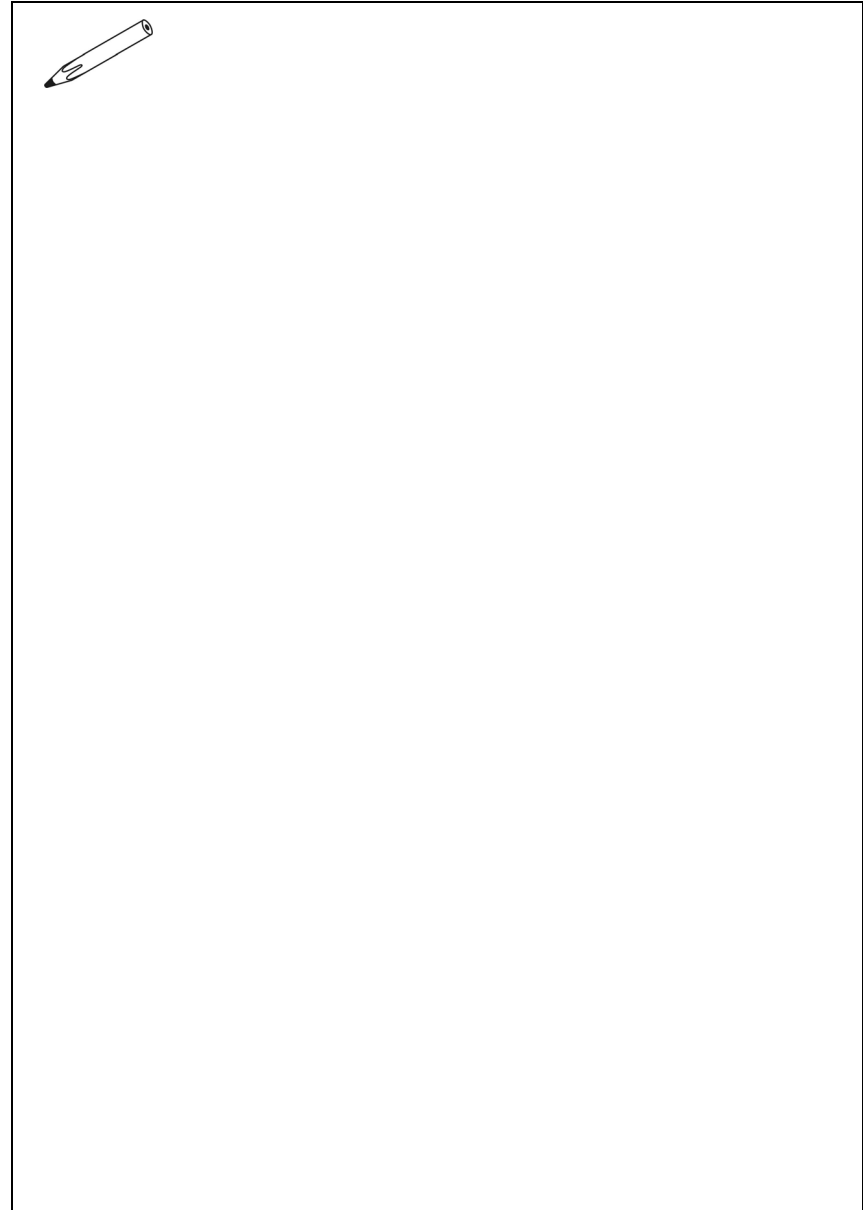

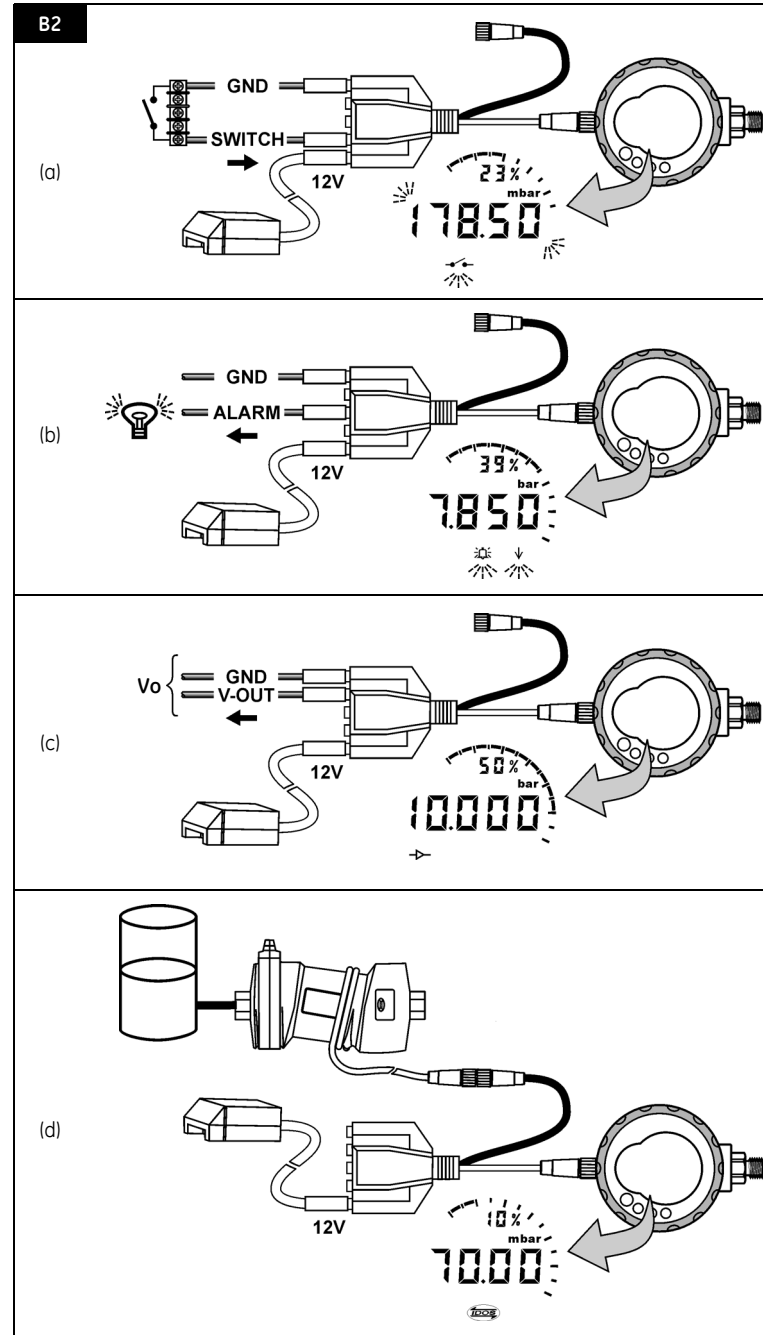
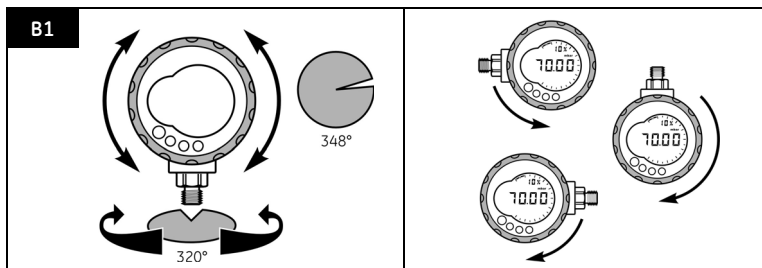
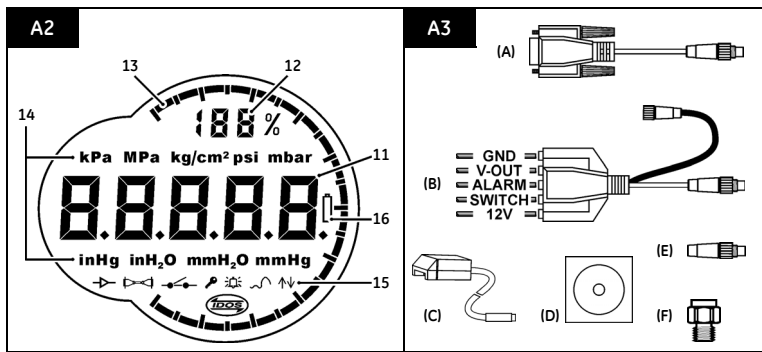
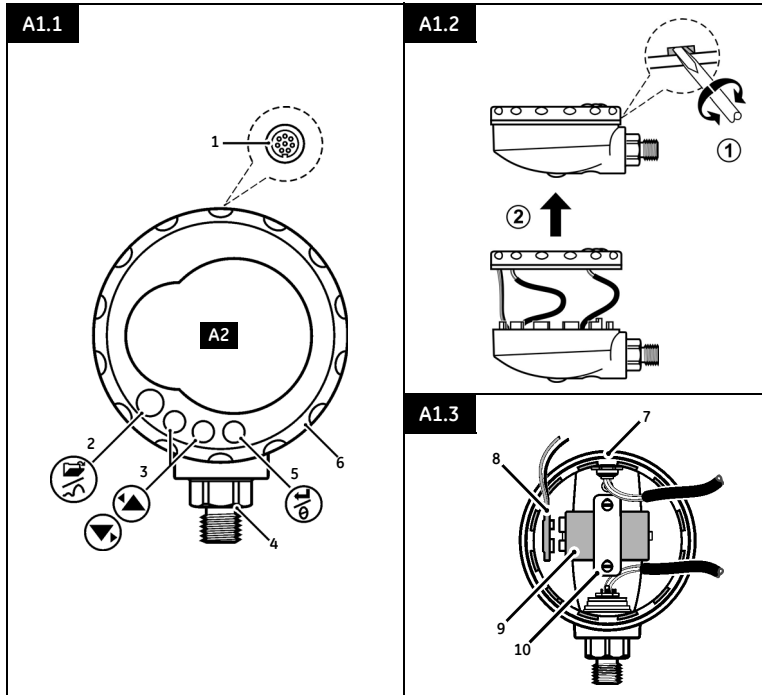

Customer service

Visit our web site: www.ge-mcs.com

Table of Contents

Table of Contents	1	Maintenance	18
Introduction	2	Replace the batteries	18
Safety	2	Restore the original configuration	18
Marks and symbols	2	Calibration	18
To Start	3	Equipment and conditions	19
Key to figure A1 (Instrument)	3	Procedures	19
Key to figure A2 (Display)	4	Specification	23
Key to figure A3 (Accessories)	4	General	23
Prepare the instrument	5	Environmental conditions	23
Power on or off	5	Electrical	23
Menu operation	5	Additional data	23
Installation	7	Pressure measurement	24
DPI 104 battery	7		
DPI 104 position	7		
Pressure connections	8		
Electrical connections	8		
External power	9		
Operation	9		
Menu: Set units	9		
Menu: Set tare (or set zero)	9		
Menu: Monitor maximum/minimum	11		
Menu: Monitor a pressure switch	11		
Menu: Calibration	12		
Menu: Set low/high alarm	12		
Menu: Supply voltage output (Vout)	13		
Menu: Set Vout scale factor	14		
Menu: Set automatic power OFF	14		
Menu: Set lock code	14		
Menu: Set scan rate	15		
Menu: Monitor external IDOS	15		
Menu: Set FSO low/high registers	16		
Software/network connections	17		
Error indications	17		

Introduction

The Druck DPI 104 is a digital pressure indicator that measures the pressure of liquid, gas or vapor and shows the pressure value on a liquid crystal display (LCD). It also has the Intelligent Digital Output Sensor (IDOS) technology to use data from a Universal Pressure Module (UPM).

The DPI 104 includes the functions that follow:

Function
* Measure pressure - Accuracy: 0.05% full scale (FS)
Large 5-digit main display with 11 pressure units
Adjustable Full Scale Output (FSO)
20 segment analog dial in increments of 5% FSO (large division marks = 10% increments).
2.5 digit percentage indicator (0-100% FSO)
8-pin connector port: For RS232, **IDOS UPM, external power supply
Alarm output for high/low pressure conditions
Switch input to monitor an external pressure switch
Analogue voltage output (Vout/Vo): 0.05 to 5 Vdc
Other functions: maximum/minimum, tare, Vout scale factor, automatic power off



* Refer to —enu operations.

** Optional item

Safety

Before using the DPI 104, read and understand all the related data. This includes: all local safety procedures, Safety instructions and User Guide and this publication.







Other marks and symbols

	Complies with European Union directives
	Warning - refer to the manual
	Do not dispose of this product as household waste. Refer to Maintenance.

To Start













Key to figure A1 (Instrument)

Table 1: Key to figure A1

Item	Description
1.	8-pin connector for external power supplies, RS232/UPM connections and signal input/output.
2. • 	Power on button.
•	Menu mode: Press and hold to show the first menu option. To move down the menu structure, press repeatedly, or continue to press and hold.
•	Reject or stop the change to a value.
•	In maximum/minimum mode. Press to show the maximum and minimum values since the last reset.
	 ↑ = maximum  ↓ = minimum
3.  	In menu mode: - On/OFF selection - Move the decimal left/right - Increase/decrease a value
4.	Pressure sensor and connector with 320° of turn: gauge (g), absolute (a) or sealed gauge (sg). Refer to menu operations, page 5.
5. • 	In menu mode: - Accepts a menu selection - Accepts a value - Shows the next menu level
•	In <i>Tare mode</i> : Set the pressure value on the display to zero.
•	In maximum/minimum mode. Reset the maximum/minimum values.
6.	Display bezel with 348° of turn.
7.	O-ring.
8.	Battery connector.
9.	Battery: 9 V Alkaline (supplied but not installed). Refer to menu operations, page 5.
10.	Battery clamp with two screws.

**Key to figure A2
(Display)**

Table 2: Key to figure A2

Item	Description
11.	5-digit main display.
12.	2.5-digit percentage indicator (0-100% FSO). %FSO = [applied pressure / (FSOHigh – FSOLow)] * 100
13.	20 segment analog dial in increments of 5% FSO (large division marks = 10% increments). %FSO = [applied pressure / (FSOHigh – FSOLow)] * 100
14.	The units of measurement: kPa, MPa, kg/cm ² , psi, mbar, bar, mmHg, mmH ₂ O, mH ₂ O, inH ₂ O, inHg.
15.	Mode indication.
	Voltage output (Vout) mode - On.
	RS232 connection. The data transmit/receive function is active.
	Switch mode - On. To monitor an external pressure switch.  = switch closed  = switch open
	Menu Lock mode - On. To restrict access to the menu functions.
	Alarm mode - On. The symbol flashes when the measured value satisfies one of the alarm conditions.  ↑ = High alarm  ↓ = Low alarm
	Maximum/minimum mode - On.
	IDOS UPM mode - On. To monitor pressure from a UPM
16. 	Low battery power indication: Battery life ≤ 15%.

**Key to figure A3
(Accessories)**

Table 3: (Part of Table) Key to figure A3

Option	Description
(A)	Part No. IA4090-1-V0: DPI 104 to PC RS232 cable (8-pin to 9-pin D-type connector). To transmit data to a PC for applicable monitor and control software (accessory D).
(B)	Part No. IA4101-1-V0: DPI 104 to UPM cable assembly. The assembly has these connections: UPM cable + 5-pin connector: To give an IDOS UPM a 3 V power supply and an RS232 connection to the DPI 104 - Figure B2 (d). GND: Ground connection. V-OUT: To supply a voltage output (Vo) - Figure B2 (c). ALARM: To supply an alarm output - Figure B2 (b). SWITCH: To monitor an external switch - Figure B2 (a). 12V: 12V input for accessory C - Figure B2. <i>Note: The assembly can supply 12 V to the DPI 104 and 3 V to the IDOS UPM.</i>
(C)	Part No. 191-129: Universal 12V power supply for accessory B.
(D)	Part No. 1S-SICALPRO-DPI104: SiCal PRO monitor and control software. This includes accessory A. <i>Note: Intecal calibration software is also available. To download a copy, visit: www.ge-mcs.com</i>

Table 3: (Part of Table) Key to figure A3

Option	Description
(E)	Part No. 1S-04-0027: 8-pin connector for A1: item 1. Refer to Table 6.
(F)	Part No. 182-190: DPI 104 high pressure adaptor (9/16 UNF to 3/8 BSP) for a PV212 hydraulic hand pump [range ≥ 1000 bar (15000 psi)].

Prepare the instrument

Before using the instrument for the first time:

- Make sure that the instrument is complete and undamaged.
- Install the battery (refer to installation, Table 4: page 7). Then re-attach the display bezel [A1: item 6].















Power on or off

Refer to Quick Start, Safety Instructions and User Guide.

When the power is off, the last set of configuration options stays in memory.

Note: The DPI 104 uses a small quantity of power while it is OFF. To put into storage for a long period, disconnect the battery (refer to menu operations).

Menu operation

	Menu Description	Steps		Result/Subsequent steps
		1	2	
 OFF	= Power supply: OFF only.		-	Power goes off.
 units	= Set units: (A2: item 14).			Pressure value changes to the applicable units: psi, mbar, bar ...
 On	= Set tare (or set zero): Set to On or OFF.			On ▶ tA 00.000 : Set a tare value (refer to Table 7, page 9).
 OFF	= Monitor maximum/minimum: Set to On or OFF.			Monitor function is set on or off.
 OFF	= Monitor a pressure switch: Set to On or OFF.			Monitor function is set on or off.
	(Continued - Page 6).			

		Menu Description		Steps		Result/Subsequent steps
				1	2	
	C	= Calibration: To continue, set the correct calibration access code = last four digits of S/N. <u>*****</u>			C0 (correct the zero offset value) ► C2 (do a two-point pressure calibration) ► V2 (do a two-point voltage calibration), refer to menu operations.	
	A OFF	= Set low/high alarm: Set to On or OFF.			On ► 000.0 ↓ ► 100.0 ↑ Set a value for the low and/or high alarm (0 to 105% FSO).	
	OFF	= Supply voltage output (Vout): Set to OFF, P-V, or US.			P-V: Vout is proportional to the pressure value on the display. Make sure the Vout scale factor is correct. US ► 000.0: Set a Vout value (0 to 100%) to control an external pressure regulator. Make sure the Vout scale factor is correct.	
	S 1.00	= Set Vout scale factor: A Vout adjustment.			If applicable, set a new Vout scale factor (0.01 to 9.99), factory value = 1.00.	
	Au On	= Set automatic power OFF: Set to On or OFF.			On ► Au 15 : Set the period for automatic power OFF (1 to 99 minutes), factory value = 15 minutes.	
	L OFF	= Set lock code: A menu protection facility. Set to On or OFF.			On ► L 000 : Set a new lock code (if necessary), factory code = 000.	
	Sc 02	= Set scan rate: A rate that the DPI 104 uses to take pressure samples.			Set an applicable rate (02 to 10 Hz), factory value = 02 Hz.	
	OFF	= Monitor external IDOS: Set to On or OFF.			Monitor function is set on or off.	
	FS ↓	= Set FSO low register: To set a different range for these functions: analog display, %, alarm.			Set a value for the low end of the range (refer to Table 8, page 16). Factory value = Factory calibration value.	
FS ↑	= Set FSO high register: To set a different range for these functions: analog display, %, alarm.			Set a value for the high end of the range (refer to Table 8, page 16). Factory value = Factory calibration value.		

Normal display

Installation

This section shows how to install and connect the DPI 104.

Warning:

To prevent an explosion or fire, use only the GE specified battery and external supply.

DPI 104 Battery

Use the procedures in Table 4 to install or replace the battery.

Table 4: Installation procedures - Battery

Step	Procedure
1	If applicable, set the power to off and isolate the external power supply.
2	Remove the display bezel (Figure A1.2).
3	Make sure that the o-ring [A1: item 7] and the related surfaces are serviceable. Use only original parts supplied by the manufacturer.
4	Remove the battery clamp [A1: item 10].
5	If applicable, disconnect the battery connector [A1: item 8] and *discard the used battery.
6	Attach the battery connector [A1: item 8] to the new battery.
7	Install the new battery (Figure A1.3) and re-attach the battery clamp [A1: item 10].
8	Push the display bezel [A1: item 6] back into position until it is fully engaged.

* Use an applicable recycling facility.

DPI 104 position

Attach the DPI 104 in a safe configuration that prevents unwanted stress (for example vibration, physical impact, shock, mechanical and thermal stresses).

To get the best installation position, turn the pressure connector (A1: item 4) and the display bezel (A1: item 6) to give the best view of the display (Figure B1). End stops set the limits in each axis.

CAUTION: Do not use force to turn the pressure connector or the bezel farther than the end stops. Using force can damage the instrument.

Pressure connections

CAUTION: Do not use the body of the DPI 104 to tighten the pressure connection, this can cause damage. Use the flat faces on the pressure connector to hold the body and tighten the pressure union.

Use an applicable method to seal the pressure connections, and then tighten to the applicable torque (Figure 1 and Table 5).



a) 1/4 NPT:
Pressure < 1000 bar (15000 psi)



b) G1/4:
Pressure < 1000 bar (15000 psi)



c) 9/16 x 18 UNF cone:
Pressure ≥ 1000 bar (15000 psi)

Figure 1: Connection methods

Table 5: Key to figure 1

Item	Description
1.	Applicable DPI 104 pressure connector. Maximum torque: 1/4 NPT: 68 Nm (50 lbf.ft) G1/4: 20 Nm (15 lbf.ft) 9/16 x 18 UNF cone: 34 Nm (25 lbf.ft).
2.	(1/4 NPT only) Thread with an applicable sealant.
3.	(G1/4 only) Applicable bonded seal.

Electrical connections

The DPI 104 includes an 8-pin electrical connector (A1: item 1). Table 6 shows the pin connections.

Table 6: Connections for the 8-Pin connector

Connector	Pin	Input/Output	Description
	1.	Input	12-24 Vdc power supply (+)
	2.	Input	Signal ground (GND)
	3.	Output	RS232 transmit (Tx)
	4.	Input	RS232 receive (Rx)
	5.	Output	Voltage output (Vo)
	6.	Output	Alarm output
	7.	Input	Pressure switch input
	8.	Output	No connection

Table 3, page 4 gives the optional accessories that use the connector.

Note: Use only original parts supplied by the manufacturer.

The RS232 interface makes a serial network of units (maximum: 99). Refer to menu operation, page 5.

External power

Recommendation

For the following functions and operations use an external power supply :

- Functions: Maximum/minimum, Switch, Low/high alarm, Vout, IDOS
- Operations that use the DPI 104 for long periods.

Operation

This section shows how to use the DPI 104.

Menu: Set units

There are 11 different units to measure pressure, refer to the menu operation, page 5.

Units - Set-up

Refer to Safety Instructions and User Guide, publication K0387.

Menu: Set tare (or set zero)

Use the tare function to adjust the pressure value on the display, refer to Table 7, below.

Table 7: Permitted tare values

Range	Permitted tare values
g: 0.7 bar (10 psi)	-0.7 bar (-10 psi) to 105% FS
a, sg, g: ≥ 2 bar (30 psi)	-1 bar (-15 psi) to 105% FS

If a value is set that is not in the permitted range, the value goes back to the last accepted value.

Tare - Set-up and use

Menu: Set this function to *On* (refer to menu operation, page 5).

When this function is *On*, there are two options to set a tare value (tA):

- *Menu option:* Set the menu “ t *On*”, then set a tA value:

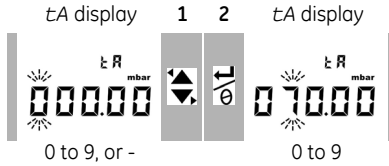

Repeat steps **1** & **2** for each digit and for the decimal point.

- *Zero option:* Step **1** lets you set a value for tA . Press and hold.

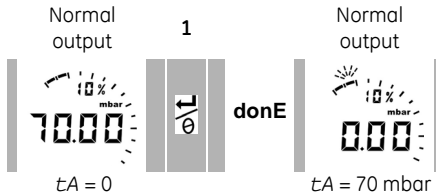

When tA is not zero, the last segment on the analog dial flashes.

To make sure that there is an indication of the correct pressure: While tare is *On*, the analog dial and % indication show values calculated from the calibrated range without the tare adjustment.

Tare - With Lock

If the menu lock is *On* with a lock code set < 500, the zero option is rejected - Error code (E0002).

Tare - With Alarm and/or Vout

If the zero option is used to set a tare value (tA) while the alarm and/or *Vout* functions are *On*, the display counts down from: $tArE9$ to $tArE0$.



To cancel the specified tA value, press this button.



To continue with the specified tA value, press this button OR let the count complete.

When setting a tA value, the alarm and *Vout* functions use values calculated from the calibrated range and the pressure value on the display.

Tare - With FSO values

To make sure that there is an indication of the correct pressure while tare is *On*, the FSO Low and/or FSO High values are not used.

Menu:  Monitor maximum/minimum

Maximum/minimum - Set-up and use

Use this function to monitor the maximum and minimum pressure. It uses the specified scan rate (refer to menu operation, page 5).

Recommendation

To save battery power use an external power supply.

Menu: Set function to *On* (refer to menu operation, page 5). To save battery power use an external power supply.

When function is *On*, use steps **1** & **2** to show the maximum/minimum since the last reset.

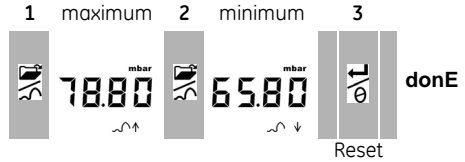

Step **3** resets the values for maximum/minimum, press and hold.

Menu:  Monitor a pressure switch

Pressure switch input - Set-up and use

Use this function to measure the performance of a pressure switch (mechanical operation and hysteresis). It uses the specified scan rate (refer to menu operation, page 5).

Recommendation

To save battery power use an external power supply.

1. Connect the DPI 104 with the applicable Table 3 accessories, page 4:
Accessories B/C - refer to cover, Figure B2 (a).
Accessory E - refer to Figure 2, below/Table 6, page 8.
2. Menu: Set function to *On* (refer to menu operation, page 5).

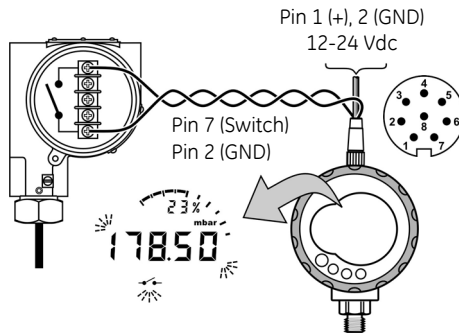



Figure 2: Example configuration - Switch input

These examples (Figure B2 (a)/, above) show the display when the switch condition changes (open or closed). The analog dial and the % indication continue to monitor the normal pressure.

The switch symbol and the value on the main display flash to give the switch condition and the switch pressure.

Press  To reset the monitor function.

Menu: Calibration

Refer to the menu operations section.

Menu: Set low/high alarm

Use the alarm function to show when the pressure is not in the specified limits for the system.

Set applicable values in the range 0 to 105% FSO:

$$\%FSO = [\text{Applied Pressure} / (\text{FSO High} - \text{FSO Low})] \times 100$$

Note: When setting a tare value, the alarm function uses the calibrated range and the pressure value on the display (refer to menu operation, page 5).

The alarm indication is available on the display and as a signal output (Table 6). Figure B2 (b) shows an example configuration with Table 3 accessories B and C, page 4.

While there is an alarm condition, the applicable alarm symbol (high or low) flashes on the display (A2: item 15).

Recommendation

To save battery power use an external power supply.

Low/high alarm - Set-up and use

Menu: Set function to *On* (refer to menu operation, page 5). Then use these steps to set the low and/or high alarm.

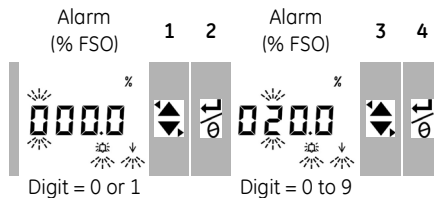

5. To finish, repeat steps 3 & 4 for each digit.

If the value entered is not correct, the value resets to the nearest permitted value. That is:

- a value in the range 0 to 105% FSO
- a low alarm value < high alarm value

To accept or change the new value, repeat steps 1 to 5.

Press  To cancel the new value.

Menu: → **Supply voltage output (Vout)**

Use the Vout function to supply a voltage output (0.05 to 5 V) to an external system. Two options are as follows:

- P-V:* Vout is proportional to the pressure value on the display.
- US:* *User mode.* Set a value in the Vout register (0 to 100%) to control an external pressure regulator.

Recommendation

To save battery power use an external power supply.

P-V mode voltage calculation

Example DPI 104: FSO = 20 bar (or 300 psi),
Vout scale factor = 1.00.

Applying 10 bar (or 150 psi) to this DPI 104:

$$V_{out} = (10/20 * 5V) / 1.0 \text{ OR } (150/300 * 5V) / 1.0 = 2.5 V$$

US mode voltage calculation

This calculation uses the values set up for the Vout register and the Vout scale factor.

If the pressure ranges for the DPI 104 and the regulator are different, set a new Vout scale factor (refer to menu operations).

$$V_{out} = \left[\frac{(V_{out} \text{ register} / 100) * 5V}{V_{out} \text{ scale factor}} \right]$$

Example - If the Vout register is set to 25%, and the Vout scale factor is set to 0.5:

$$V_{out} = (25/100 * 5V) / 0.5 = 2.5 V$$

Voltage output (Vout) - Set up and use

1. Connect the DPI 104 with the applicable Table 3 accessories: Accessories B/C - refer to cover, Figure B2 (c). Accessory E - refer to Figure 3, below/Table 6, page 8.
2. Menu: Set function to *OFF, P-V, US* (refer to menu operation, page 5).

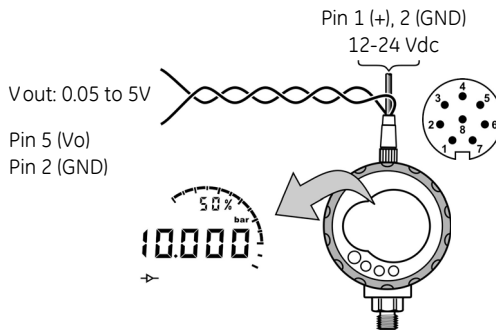

Figure 3: Example configuration: Vout

Menu: Set Vout scale factor

When the Vout function is set to P-V or US mode, the Vout scale factor becomes part of the Vout calculation (refer to menu operations).

If the pressure ranges for the DPI 104 and the external pressure regulator are different, an applicable scale factor (0.01 to 9.99) must be set.

Example - To get a 25 bar (or a 375 psi) line pressure with:

- an External pressure regulator:
FSO = 100 bar (or 1500 psi)
- a DPI 104: FSO = 200 bar (or 3000 psi)

In this example:

$$\text{Scale factor} = 100/200 \text{ OR } 1500/3000 = 0.5$$

$$\begin{aligned} \text{Vout register (\%)} &= (25/200) \times 100 \text{ OR } (375/3000) \times 100 \\ \text{(DPI 104)} &= 12.5\% \end{aligned}$$

To get a 25 bar (or a 375 psi) line pressure, the DPI 104 uses these values to supply the Vout value shown below:

$$\text{Vout} = (12.5/100 * 5V) / 0.5 = 1.25 V$$

Menu: Set automatic power OFF

The power goes off in a specified period after the last button press or external software operation.

Recommendation

Use this function for maximum battery life.

Note: The DPI 104 uses a small quantity of power when OFF. For storage, disconnect the battery (refer to menu operation, page 5).

Automatic power OFF - Set-up and use

Menu: Set this function to On. Then set an applicable value in the range 1 to 99 minutes, refer to menu operation, page 5.

Note: If continuous operation is required, set to OFF and use an external power supply.

Menu:  Set lock code

Use the lock function to prevent accidental changes to the configuration. Two options are as follows:

- *Lock code < 500:* This locks the menu and the tare function.
Factory code = 000
- *Lock code > 499:* This locks the menu but the zero option to set a tare value is still available.

Refer to menu operation, page 5.

Lock code - Set-up and use

Menu: Set to On (refer to menu operation, page 5). Use the steps that follow to set a new code.

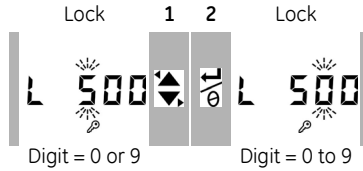

3. Complete the lock code, repeat steps 1 & 2 for each digit.
4. To change the menu options, the display shows: L - - -
5. Enter the applicable code.

To reset the code to the factory code, do a restore operation. Refer to menu operations, page 5.

Menu: Set scan rate

This function sets the rate that the DPI 104 uses to take pressure samples from the internal sensor.

The nominal update rate for the display is 2 Hz. The up-date rate for the maximum/minimum function and the switch function is greater than or equal to the specified scan rate.

Note: Increasing the scan rate, increases the power consumption.

Scan rate - Set-up and use

Menu: Set an applicable value in the range 2 to 10 Hz, refer to menu operation, page 5.

Menu:  Monitor external IDOS

Use this function to read the pressure from an external IDOS UPM. All the other DPI 104 pressure functions are available but not the calibration function.

Example: Set tare (or set zero), Monitor maximum/minimum.

This function does not supply power to the IDOS UPM and needs accessories B and C, refer to Table 3, page 4.

Monitor external IDOS - Set-up and use

1. Connect the DPI 104 (Figure B2 (d)).
2. Menu: Set to On (refer to menu operation, page 5).

Menu: Set FSO low/high registers

Use the FSO low/high registers to set a different range for the functions that follow: analog display, % indication, low/high alarm. Initially, these register values are set to the factory calibration values. Example:

Calibrated range: 0.7 bar (10 psi) gauge.
Selected units: mbar

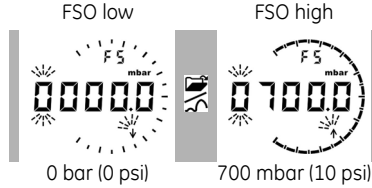

Table 8 gives the permitted FSO values.

Table 8: Permitted FSO values

Range	Permitted FSO values
All ranges: a, sg	0 to 105% FS
g: 0.7 bar (10 psi)	-0.7 bar (-10 psi) to 105% FS
g: ≥ 2 bar (30 psi)	-1 bar (-15 psi) to 105% FS
All ranges	FSO low < FSO high

FSO low/high registers - Set-up and use

Menu: Set the menu option to the FSO low register (refer to menu operations, page 5). Use these steps to set an applicable value in the permitted range, refer to Table 8 above:

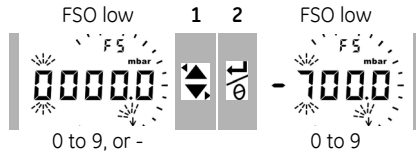

3. Repeat steps 1 & 2 for each digit and for the decimal point. If an incorrect value is entered, the value resets to the nearest permitted value, refer to Table 8 above.

To accept or change the new value, repeat steps 1 to 3.

Press  To cancel the new value.

4. If necessary, repeat the procedure for the FSO high register.

Software/network connections 

External software can be used with the DPI 104 (Table 3 accessories A or D, page 4). If SiCal PRO (accessory D) is used, all the menu commands and display data are available.

Note: To use SiCal PRO, it must have the serial number of each unit to be used with (DPI 104, IDOS UPM, PC6-IDOS). Supply the necessary serial numbers with an order or contact GE at www.ge-mcs.com.

 This symbol appears when the DPI 104 transmits or receives data.

Set-up a DPI 104 network

Set-up a network of up to 99 units in series ('daisy chain'). Figure 4 shows the electrical connections to do this, refer to Table 6 page 8.

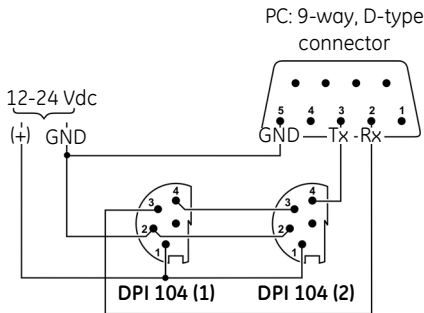

Figure 4: Connections for a DPI 104 network

Error codes

Table 9: Error codes/indications

Code	Description	Action
E0001	Incorrect unlock code.	Use the correct code.
E0002	The tare facility is not available because the menu lock is On and the lock code < 500.	Change the menu configuration.
E0004	Start-up error.	Do a restore operation (refer to menu operation, page 5).
E0005	External IDOS UPM not found.	Make sure that all the related equipment and connections are serviceable.
E0006	Incorrect calibration access code.	Use the correct code.
E0007	The power supply voltage is too low to do a calibration.	Use an external power supply or replace the battery.
E0009	Unable to supply the specified Vout.	Example: Low battery. Use an external power supply or replace the battery. Bad connection. Make sure that all the related equipment and connections are serviceable.
OLoAd	Applied pressure ≥ 110% FS.	Reduce the pressure.
99999/-9999	There are not enough digits in the main display to give the correct pressure value.	Change the measurement units.

Maintenance

- Cleaning* Clean the case with a moist, lint-free cloth and a weak detergent. Do not use solvents or abrasive materials.
- Inspecting* Make sure that there is no damage to the threads and o-rings, free of grit and other obstructions.
- Repair* Return the instrument to the manufacturer or an approved service agent for all repairs.
- Recycling* Do not dispose of this product as household waste. Use an approved organisation that collects and/or recycles waste electrical and electronic equipment.
For more information, contact one of the following:
- GE customer service department: www.ge-mcs.com
 - Local government office.

Replace the batteries To replace the batteries, refer to menu operation, page 5.
Note: When replacing batteries all the configuration options stay in memory.

Restore the original configuration To restore the unit to the original factory configuration,

- Press and hold all four buttons until the display goes off (≈ five seconds).
- The unit will restart.

Menu operations shows the factory settings.
The lock code is reset to the factory code (000).

Calibration

Return the DPI 104 to the manufacturer or an approved service agent for calibration.
Note: GE can provide a calibration service that is traceable to international standards.

If using an alternative calibration facility, make sure that it uses these standards.

Equipment and conditions

To do an accurate calibration, requires:

- the calibration equipment specified in Table 10, below.
- a stable temperature environment: $20 \pm 1^\circ\text{C}$ ($68 \pm 2^\circ\text{F}$).

Table 10: Calibration equipment

Function	Calibration equipment
Pressure	An applicable pressure standard (primary or secondary) with a total uncertainty of 0.01% reading or better. Make the pressure connection to A1: item 4. Refer to menu operations.
Volts (V)	Volts calibrator. Accuracy: 0.025% reading or better. Make the Vout connection to A1: item 1. Refer to menu operations

Procedures

1. Connect the applicable calibration equipment (Table 10).
2. Menu: Set the menu option to C ____.
3. Set the calibration access code = last four digits of the serial number (refer to Menu operation, page 5).

There are three calibration options (Table 11, below):

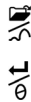

- Press this button to move to the next option without a change to the values.
- Press this button to stop and make changes to a value.
- To return to the normal display, wait eight seconds.

Table 11: Calibration options

Option	Description
C0:	Set the necessary offset value for the instrument to give the correct pressure related to zero: All ranges g or sg: Zero (bar/psi); Ranges a: Ambient pressure*
C2:	Do a two-point pressure calibration. All ranges g or sg: P1 = Zero (bar/psi); P2* = FS Ranges a: P1* = Ambient pressure; P2* = FS
V2:	Do a two-point voltage calibration. All ranges: P1** = 0.1000 V; P2** = 5.0000 V

* adjustable by 5% FS; ** adjustable by 50 mV

C0 (Zero offset)

The DPI 104 shows the following displays:

1. The calibration point to be used for C0. This value is only adjustable for an absolute type DPI 104 (Table 11, page 19). C0 - Gauge = 0000.0

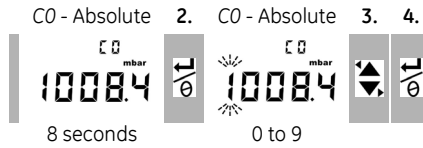

5. Repeat steps 3. & 4. for each digit and for the decimal point. The value is ignored if it is not in the permitted limits (Table 11). The value is then used as the Set Point (SP) on the subsequent displays.
6. This sequence of displays will follow:

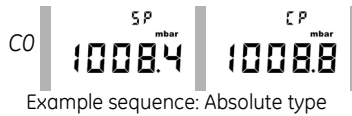

The SP value is followed by the measured pressure - current pressure (CP). This sequence continues until the offset value is accepted or rejected.

7. When the pressure is stable:
 - Press this button to accept the new offset value.
 - The display shows "donE", and then the next calibration option (C2).
 - Press this button to reject the new offset value and move to the next calibration option (C2).

The value is ignored if it is not in the permitted limits (5% FS) or if the CP value is not stable.

C2 (two-point pressure calibration)

Point 1 (P1) - The DPI 104 shows the following displays:

1. The calibration point to be used for C2 - Point 1. This value is only adjustable for an absolute type DPI 104 (Table 11, page 19). C2 - Point 1 (Gauge) = 0000.0

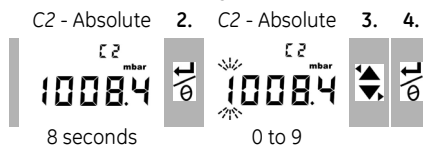

- Repeat steps 3. & 4. for each digit and for the decimal point. The value is ignored if it is not in the permitted limits (Table 11, page 19).

This value is then used as the set point (SP) for point 1 on the subsequent displays.



- This sequence of displays will follow:



Example sequence: Absolute type

The SP value is followed by the measured pressure - CP. This sequence continues until the point 1 value is accepted or rejected.

- When the pressure is stable:

-  • Press this button to accept the new P1 value.
-  • The display shows the calibration point C2 - point 2 (C2).
-  • Press this button to reject the new P1 value and move to the next calibration option (V2).

The value is ignored if it is not in the permitted limits (5% FS) or if the CP value is not stable.

Point 2 (P2) - Use the same steps (1 to 5 above) to set C2 - Point 2. This is the FS value and it is adjustable for the absolute and gauge type DPI 104 (Table 11).





- This sequence of displays will follow:



Example sequence: Absolute type

The SP value is followed by the measured pressure - CP. This sequence continues until the point 2 value is accepted or rejected.

- When the pressure is stable:

-  • Press this button to accept the new P2 value.
-  • The display shows "donE", and does a two-point calibration.
-  • The instrument will restart.
-  • Press this button to reject the new P2 value and move to the next calibration option (V2).

The value is ignored if it is not in the permitted limits (5% FS) or if the CP value is not stable.

V2 (two-point voltage calibration)

Point 1 (P1) - The DPI 104 shows the following displays:

1. The calibration point to be used for V2 - Point 1.

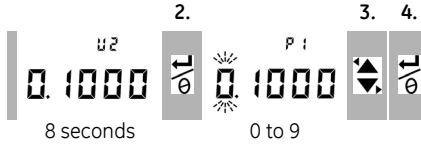

After step 2, the DPI 104 sets Vout to 0.1 V. Correct the value (P1) to the value shown on the voltage calibrator.

5. Repeat steps 3. & 4. for each digit. The value is ignored if it is not in the permitted limits (Table 11, page 19).

Point 2 (P2) - If P1 has a permitted value, the DPI 104 shows these displays:

1. The calibration point to be used for V2 - Point 2.

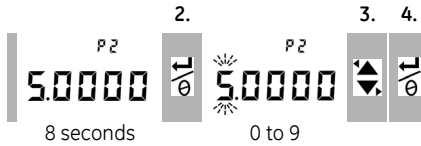

After step 2, the DPI 104 sets Vout to 5.0 V. Correct the value (P2) to the value shown on the voltage calibrator.

5. Repeat steps 3. & 4. for each digit. The value is ignored if it is not in the permitted limits (Table 11, page 19).
6. If P2 has a permitted value, the DPI 104 uses the new P1/P2 values to adjust the output (Vt):



- Press this button to accept the V2 calibration.
- The display shows "donE".
- The instrument will restart.
- Press this button to reject the V2 calibration and move to the next menu option.

Specification

General

Display	LCD
EMC	EN 61326-1
Electrical Safety	EN 61010-1
Pressure Safety	Pressure Equipment Directive - Class: Sound Engineering Practice (SEP).
Power supply	9V, IEC 6LR61, ANSI/NEDA 1604 battery, OR use an external 12-24 Vdc 50mA supply.

Environmental conditions

The DPI 104 is suitable for indoor use with the following environmental requirements. It is permitted to use the DPI 104 outdoors as a portable instrument if the environmental requirements are met

Operating temperature	-10 to 50°C (14 to 122°F).
Storage temperature	-20 to 70°C (-4 to 158°F).
Ingress Protection	IP65 *.
Operating Humidity	0 to 95% relative humidity (RH) non-condensing
Vibration	Def Stan 66-31; 8.4 cat III.
Operating altitude	2000 metres (6560 ft).
Pollution degree	2

* The DPI 104 has been assessed to the European IEC60529 standard as having an ingress protection rating of IP65, but this is for reliability purposes and not for safety reasons.

Electrical

Switch input	Maximum impedance: 200Ω (mechanical contact only).
Alarm output	Type: Open drain Field Effect Transistor (FET) Maximum (mA): 250 mA; Maximum (V): 24 Vdc.
Analog output	0.05 to 5 Vdc; Minimum load: 500 Ω; Accuracy: 0.1% FS at 20°C (68°F) - user mode only. Temperature coefficient: 0.007% FS / °C (0.0039% FS / °F).
Battery life	Up to one year for pressure measurements: Au (power save facility) - On; maximum/minimum, alarm, Vout, switch - all set to OFF.
RS232/Network capacity	For: IDOS UPM, external software, or up to 99 units in series ('daisy chain').

Additional Data

Materials	Case: Acrylonitrile Butadiene Styrene (ABS) **
Approved	CE Marked.
Size	Diameter = 95 mm (3.74 in); Depth = 55 mm (2.2 in) Typical length (with connector) ≈ 120 mm (4.7 in).
Weight	350g (12.5 oz).

**The case of the DPI 104 is not suitable for prolonged exposure to ultra-violet light.

Pressure measurement

Range: gauge (g), absolute (a), sealed gauge (sg)			Resolution		Maximum Working Pressure (MWP)		Media notes
bar*	psi*	Type	mbar	psi	bar	psi	
(-0.7) 0 to 0.7	(-10.0) 0 to 10	g*	0.01	0.001	0.77	11.2	1
(-1.0) 0 to 2.0	(-15.0) 0 to 30	g* or a	0.1	0.001	2.2	32	1
(-1.0) 0 to 7.0	(-15.0) 0 to 100	g* or a	0.1	0.01	7.7	111.7	2
(-1.0) 0 to 20	(-15.0) 0 to 300	g* or a	1	0.01	22	319	2
(-1.0) 0 to 70	(-15.0) 0 to 1000	g* or a	1	0.1	77	1117	2
0 to 200	0 to 3000	sg	10	0.1	220	3190	2
0 to 350	0 to 5000	sg	10	0.1	385	5583	2
0 to 700	0 to 10000	sg	10	1	770	11165	2
0 to 1000	0 to 15000	sg	100	1	1100	15950	3
0 to 1400	0 to 20000	sg	100	1	1540	22330	3

* Negative ranges shown in (...) - gauge units only.

Media notes:

- Non-corrosive, non-conductive liquid or non-corrosive, dry gas.
- Media applicable to stainless steel (316).
- Media applicable to Inconel 625

Accuracy (0 to FS)	0.7 bar (10 psi): 0.15% FS All ranges \geq 2 bar (30 psi): 0.05% FS
Units	kPa, MPa, kg/cm ² , psi, mbar, bar, mmHg, mmH ₂ O, mH ₂ O, inH ₂ O, inHg
Pressure connections	Ranges \leq 700 bar (10000 psi): 1/4 NPT male OR G1/4 male. Ranges $>$ 700 bar (10000 psi): 9/16 x 18 male cone.