

## User's Manual (detailed) Network Guide

### Thank you for purchasing this product.

This manual is intended to explain only the network function. For proper use of this product, please refer to this manual and the other manuals for this product.

**⚠ WARNING** ▶ Before using this product, be sure to read all manuals for this product. After reading them, store them in a safe place for future reference.

### Features

This projector has the network function that brings you the following main features.

- ✓ **Web Control** : allows you to monitor and control the projector through a network from a computer, smartphone and tablet device. (📖 35)
- ✓ **Network Presentation** : allows the projector to project computer, images transmitted through a network. (📖 76)
- ✓ **My Image** : allows the projector to store up to four still images and project them. (📖 80)
- ✓ **Messenger** : allows the projector to display text sent from a computer through a network. (📖 81)
- ✓ **Network Bridge** : allows you to control an external device through the projector from a computer. (📖 84)

**NOTE** • The information in this manual is subject to change without notice.  
• The illustrations in this manual are for illustrative purposes. They may differ slightly from your projector.  
• The manufacturer assumes no responsibility for any errors that may appear in this manual.  
• The reproduction, transfer or copy of all or any part of this document is not permitted without express written consent.

## Contents



<b>Caution</b> .....	<b>5</b>
<b>1. Network Function</b> .....	<b>6</b>
1.1 Web Control .....	6
1.2 Network Presentation .....	7
1.3 My Image Function .....	8
1.4 Messenger Function .....	9
1.5 Network Bridge Function .....	10
1.6 Other Functions .....	11
1.6.1 E-mail Alerts .....	11
1.6.2 Projector Management using SNMP .....	11
1.6.3 Event Scheduling .....	11
1.6.4 Command Control via the Network .....	11
<b>2. Connection to the network</b> .....	<b>12</b>
2.1 Connection via wireless LAN .....	13
2.1.1 Connection in Simple Access Point Mode .....	15
2.1.2 Connection in Infrastructure Mode .....	16
2.2 Connection via wired LAN .....	18
2.3 Applications .....	20
2.4 NETWORK Menu .....	21
<b>3. Web Control</b> .....	<b>35</b>
3.1 Projector Web Control .....	38
3.1.1 Login .....	38
3.1.2 Network Information .....	40
3.1.3 Network Settings .....	41
3.1.3.1 Common Setup .....	41
3.1.3.2 Wireless Setup .....	43
3.1.3.3 Wired Setup .....	46
3.1.3.4 Other Setup .....	47
3.1.4 Port Settings .....	48
3.1.5 Mail Settings .....	49
3.1.6 Alert Settings .....	51
3.1.7 Schedule Settings .....	52
3.1.7.1 Schedule Management .....	52
3.1.7.2 Program List .....	53
3.1.7.3 Program Edit .....	54
3.1.7.4 Program Copy .....	55



3.1.8 Date/Time Settings .....	56
3.1.9 Security Settings .....	58
3.1.9.1 User Account .....	58
3.1.9.2 Network Control .....	59
3.1.9.3 Network Presentation .....	60
3.1.9.4 SNMP .....	61
3.1.10 Projector Control .....	62
3.1.11 Remote Control .....	63
3.1.12 Projector Status .....	64
3.1.13 Connection Test .....	65
3.1.14 Network Restart .....	66
<b>3.2 Crestron e-Control® .....</b>	<b>67</b>
3.2.1 Main window .....	69
3.2.2 Tools window .....	71
3.2.3 Info window .....	73
3.2.4 Help Desk window .....	74
3.2.5 Emergency Alert .....	75
<b>4. Network Presentation .....</b>	<b>76</b>
4.1 Outline .....	76
4.2 Display Mode .....	77
4.2.1 Single PC mode .....	77
4.2.2 Multi PC mode .....	77
4.3 Multi Projector Mode .....	78
4.4 Moderator Control Mode .....	78
4.5 Port Number .....	79
<b>5. My Image Function .....</b>	<b>80</b>
<b>6. Messenger Function .....</b>	<b>81</b>
6.1 Outline .....	81
6.2 Display Style .....	82
<b>7. Network Bridge Function .....</b>	<b>84</b>
7.1 Connecting devices .....	84
7.2 Communication setup .....	85
7.3 Communication port .....	85
7.4 Transmission method .....	86
7.4.1 HALF-DUPLEX .....	86
7.4.2 FULL-DUPLEX .....	87



<b>8. Other Functions .....</b>	<b>88</b>
8.1 E-mail Alerts .....	88
8.2 Projector Management using SNMP .....	91
8.3 Event Scheduling .....	93
8.4 Command Control via the Network .....	97
8.5 Crestron Connected™ .....	102
<b>9. Troubleshooting .....</b>	<b>103</b>
<b>10. Warranty and after-sales service .....</b>	<b>112</b>

**Note:** The Dukane models described in this document are manufactured by Hitachi and uses the same firmware, software programs, control code, and accessory parts. The equivalent Dukane to Hitachi models are 8133WSS (LP-AW3001) and 8142WSS (LP-AW4001).

**Caution**

- Be sure to confirm that the projector has been installed and connected safely even if it is turned on automatically.
- If you connect the projector to an existing network, consult a network administrator before setting server addresses.
- Attaching an optional wireless adapter to the projector enables wireless connection. Follow the cautions below when you use the wireless adapter.

**[Restriction on plugging and unplugging the wireless adapter (option)]**

Before you insert or pull out the wireless adapter from the projector, turn off the power of the projector and pull out the power cord's plug from the outlet. Do not touch the wireless adapter that is connected to the projector while the projector is receiving AC power. Do not use any extension cable or device when connecting the adapter to the projector.

**[Security precautions when using wireless LAN (option)]**

It is recommended that security settings, such as SSID and ENCRYPTION, are specified when using wireless LAN communication. If the security settings are not specified, the contents may be intercepted or it may cause unauthorized access to the system. For details on wireless LAN security settings, refer to **3.1 Projector Web Control**. Although the projector has security functions, they do not always guarantee prevention of the risks mentioned above.

⚠ CAUTION ► You do not need a radio license to use the adapter, but you should be aware of the following:

**• DO NOT USE NEAR THE FOLLOWING!**

- Microwave ovens
- Industrial, scientific or medical devices
- Designated low power radio stations
- Premises radio stations
- Using this projector near the above may cause radio interference, which would result in a decrease in transmission speed or interruption, and even lead to malfunctioning of devices such as pacemakers.
- Depending on the location where this projector is used, radio wave interference may occur, which may result in a decrease in transmission speed or interruption in communication. In particular, please be aware that using the wireless adapter at locations where there is reinforced steel, other types of metals or concrete is likely to cause radio wave interference.
- Available Channels  
This projector uses the 5 GHz and 2.4 GHz radio frequency band, but depending on the country or region you are in, the channels that you can use might be limited. Please consult your dealer for information on the usable channels.
- Bringing this projector out of the country or region you reside in and using it there could lead to a violation of the radio laws of that country or region.
- The W52 is for indoor use only. Outdoor use is prohibited.

# 1. Network Function

This chapter describes the outline of network function.

## 1.1 Web Control

Connecting the projector and the computer via the network, remote control and status monitoring of the projector can be performed by Web browser.

Two types of interface, “Projector Web Control” and “Crestron e-Control®” are available for this projector. (📖 35)

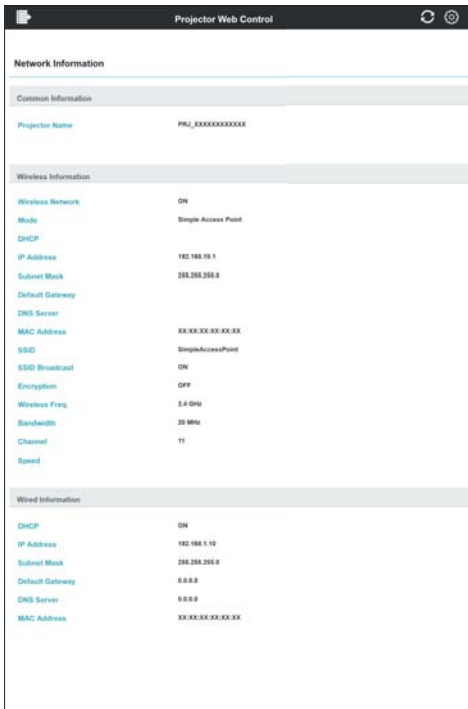

Projector Web Control



Crestron e-Control®

## 1.2 Network Presentation

The projector can display or play back the computer screen images and audio data that are transmitted through the network.

To use Network Presentation, an exclusive application, "LiveViewer" is required. The following application is required to use Network Presentation.

OS	Application
Windows®	LiveViewer
Mac OS X®	LiveViewer
iOS(iPhone/iPad)	Projector Quick Connection
Android	Projector Quick Connection

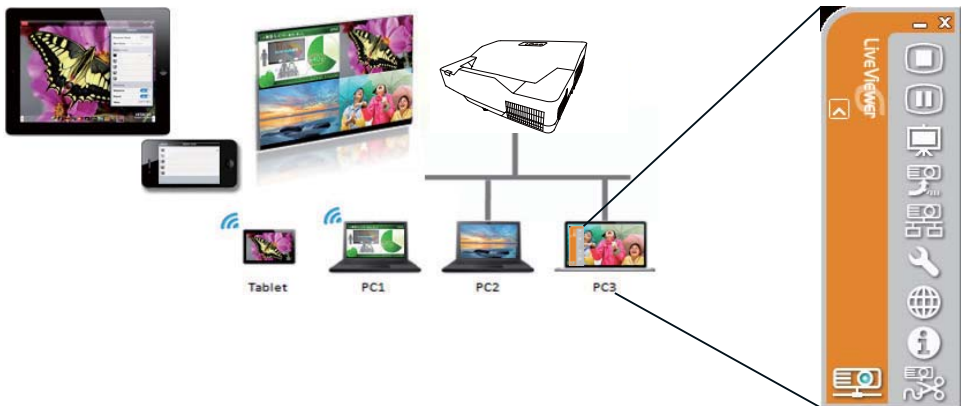

### 1.3 My Image Function

The projector can display still images transferred via the network.

It is possible to allocate up to 4 image files.

MY IMAGE transmission requires an exclusive application for your computer.

Use the application to transfer the image data.

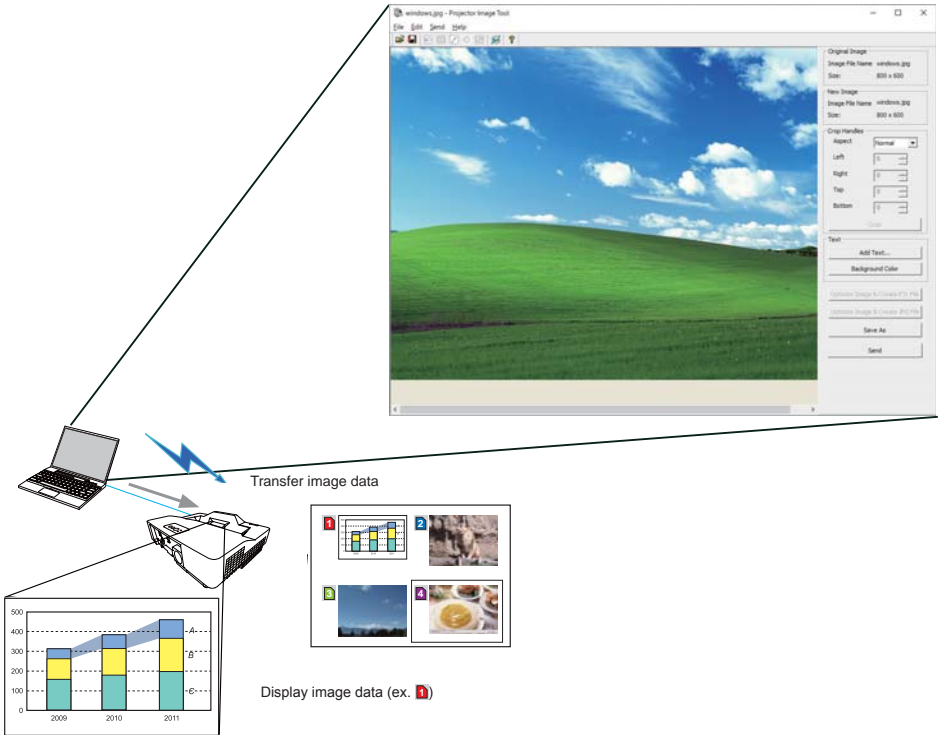



## 1.4 Messenger Function

The projector can display text data transferred via the network on the screen and play back audio data inside the projector. Up to 12 text data can be stored.

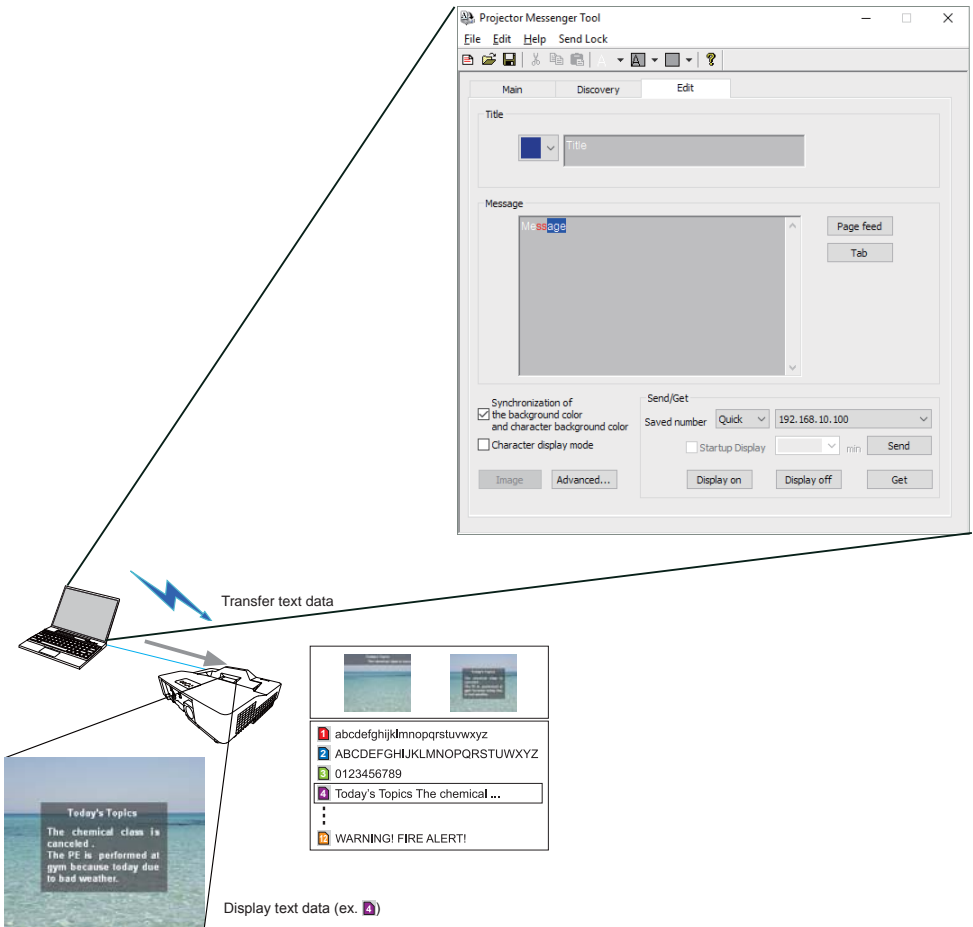

### 1.5 Network Bridge Function

This projector is equipped with the NETWORK BRIDGE function to perform mutual conversion of a network protocol and a serial interface. By making use of the NETWORK BRIDGE function, a computer connected to the projector via wireless or wired LAN is able to control an external device via RS-232C communication using the projector as a network device.

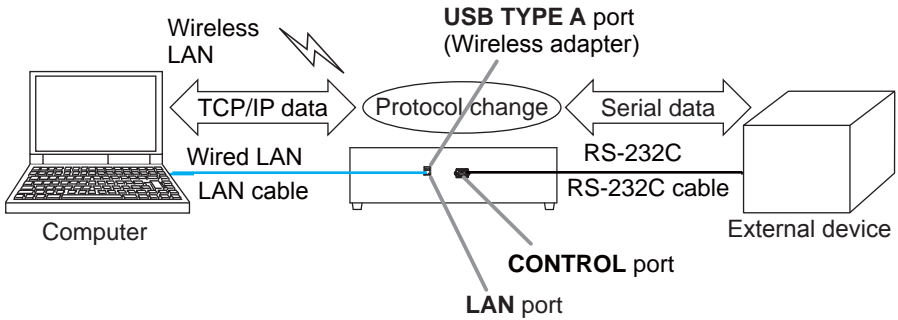

## 1.6 Other Functions

### 1.6.1 E-mail Alerts

The projector can automatically send an alert message to the specified e-mail addresses when the projector detects a certain condition requiring maintenance or detected an error. (📖 88)

### 1.6.2 Projector Management using SNMP

The SNMP (Simple Network Management Protocol) enables to manage the projector information, which is a failure or warning status, from the computer on the network. The SNMP management software will be required on the computer to use this function. (📖 91)

### 1.6.3 Event Scheduling

The scheduling function enables to setup scheduled events including power on / power off. It enables to be “self-management” projector. The schedule can be set in Projector Web Control or OPTION-SCHEDULE menu in the projector. (📖 93)

### 1.6.4 Command Control via the Network

You can configure and control the projector via the network using RS-232C commands. (📖 97)

## 2. Connection to the network

The connection method of wireless LAN and wired LAN is as follows.

### Wireless LAN (USB-WL-5G)

Item	Description
Standard	IEEE802.11a/b/g/n/ac
Channel <sup>*1</sup>	2.4 GHz : 1~11ch 5 GHz : 36/40/44/48ch (W52) 149/153/157/161/165ch (W58)
Encryption <sup>*2</sup>	WPA2-PSK(AES/TKIP), WPA-PSK(AES/TKIP), WEP(64/128bit)
Bandwidth	2.4 GHz : 20/40MHz 5 GHz : 20/40/80MHz

\*1: Available channels may vary according to area.

\*2: WEP is only for INFRASTRUCTURE mode.

### Wired LAN

Item	Description
Standard	100BASE-TX / 10BASE-T
Port	RJ-45

**NOTE** • The network function is not available when STANDBY MODE is set to NETWORK(WOL) or SAVING and the projector is in standby mode. Connect the projector to the network after setting STANDBY MODE to QUICK START or NORMAL. (📖SETUP menu in the Operating Guide)

- Depending on the type of wireless network device and computer you are using, the projector may not be able to communicate properly with your computer, even if the computer is equipped with a built-in wireless LAN function. To eliminate communication problems, use a Wi-Fi® certified wireless network device.
- Connect the optional wireless adapter (USB-WL-5G) to the **USB TYPE A** port of the projector when using the wireless LAN. (📖14 in the Operating Guide)

## 2.1 Connection via wireless LAN

Wireless LAN has two types of connection, Simple Access Point and Infrastructure.



Fig. 2.2.a Without an access point communication (Simple Access Point)

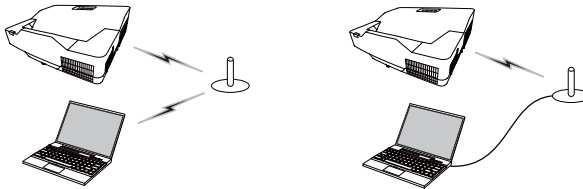

Fig. 2.2.b With an access point communication (Infrastructure)

- \* Simple Access Point is a mode which connects to computers directly. This projector can assign IP addresses to up to 10 devices.
- \* Infrastructure is one of the wireless LAN communication methods with having an access point to communicate. If communicating with existing network, consult with your network administrator.

### NOTE

- If using a wireless network function, please make sure that NETWORK - WIRELESS NETWORK setting is ON.
- Network settings can also be changed in Network Settings of Projector Web Control.
- Wireless LAN initial settings for the projector are as follows.
  - Mode: Simple Access Point
  - IP address: 192.168.10.1
  - Subnet Mask: 255.255.255.0
  - SSID: SimpleAccessPoint
  - SSID Broadcast: ON
  - Encryption: OFF
  - Wireless Freq.: 2.4 GHz
  - Channel: 11
- The same network address cannot be used for both wireless LAN and wired LAN.
- Communication speed of the projector may be deteriorated in Simple Access Point mode depending on the number of connected devices.

### 2.1.1 Connection in Simple Access Point Mode

Set the following when connecting the projector and the computer in Simple Access Point mode.

#### Projector setting

- 1) Turn on the projector.
- 2) Press the **MENU** button on the remote control or the control panel of the projector.  
The MENU you last used will appear.

Use the cursor button to select the following.

EASY MENU > ADVANCED MENU >  
NETWORK > NETWORK SETUP >  
WIRELESS SETUP

- 3) Set the following items in WIRELESS SETUP.
  - MODE: SIMPLE ACCESS POINT
  - IP ADDRESS
  - SSID
  - SSID BROADCAST
  - ENCRYPTION

Select APPLY, then press the **ENTER** button to reflect the settings.



#### About network settings

- The fourth octet of the projector's IP address is fixed to 1.
- Subnet mask of the projector is fixed to 255.255.255.0.

#### Computer setting

- 1) The DHCP server function of the projector is always enabled. Enable the DHCP setting of the computer.
- 2) Select SSID set for the projector by following the procedure of wireless connection of the computer. Enter encryption key by following the computer's instruction if it is encrypted.

**NOTE** • As for the procedure of setting network and wireless connection for the computer, refer to the manual of the computer or wireless LAN device.  
• Up to 10 devices can be connected to the projector in Simple Access Point mode.

### 2.1.2 Connection in Infrastructure Mode

Set the following when connecting the projector and the computer in Infrastructure mode.

#### Projector setting

- 1) Turn on the projector.
- 2) Press the **MENU** button on the remote control or the control panel of the projector.

The MENU you last used will appear.

Use the cursor button to select the following.

EASY MENU > ADVANCED MENU > NETWORK > NETWORK SETUP > WIRELESS SETUP

- 3) Set the following items in WIRELESS SETUP.

- MODE: INFRASTRUCTURE
- DHCP
- IP ADDRESS
- SUBNET MASK
- DEFAULT GATEWAY
- DNS SERVER
- SSID
- ENCRYPTION



As for setting an IP address, refer to About IP address. (📖 19)

Select APPLY, then press the **ENTER** button to reflect the settings.



## Connection in Infrastructure Mode (continued)

### SSID SCAN LIST function

The connection can be set up by selecting from SSID SCAN LIST without setting SSID and ENCRYPTION in WIRELESS SETUP. The procedure of connecting by SSID SCAN LIST is as follows.

- 1) Select SSID SCAN LIST in WIRELESS SETUP on NETWORK - NETWORK SETUP.  
The list of SSID in wireless network is displayed.
- 2) Select SSID in wireless network that you want to connect in SSID SCAN LIST.  
The display to enter the encryption key appears if it is encrypted. Enter the encryption key by using software keyboard.
- 3) The icon indicating connected (  ) is displayed in SSID SCAN LIST screen when the connection is complete.

#### NOTE

- Transmission speed may be slow depending on the settings of an access point.
- If the projector and the computer exist in the same network (i.e., same network address), you can leave the default gateway field blank.
- When the projector and the computer exist in different networks, the default gateway must be set. Consult with the network administrator in detail.
- Set wireless LAN for the projector by following the instructions of your network administrator when connecting to the existing network.
- Open System Authentication is used for WEP encryption, and Shared Key Authentication is not supported. The authentication with an access point succeeds and it is regarded that the connection is established normally even when entering illegal encryption key due to Open System Authentication, but data cannot actually be transmitted.
- IP ADDRESS, SUBNET MASK, and DEFAULT GATEWAY should be set in advance when DHCP is set to OFF.
- When DNS SERVER at DHCP OFF is set to other than "0.0.0.0", this projector uses user setting at DHCP OFF as DNS server address even if DHCP is set to ON and the projector can automatically obtain DNS SERVER setting from DHCP server.

### 2.2 Connection via wired LAN

The connection via wired LAN is available. Set wired LAN for the projector by following the instructions of your network administrator when connecting to the existing network.

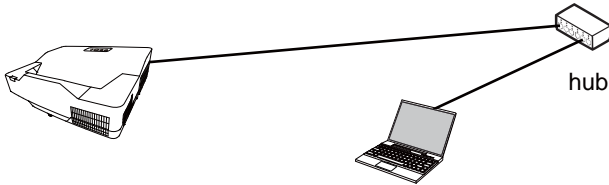

#### ■ Connection setup of wired LAN

- 1) Connect the projector to the computer via a hub with a LAN cable (CAT-5e or higher).
- 2) Press the **MENU** button on the remote control or the control panel of the projector.  
The MENU you last used will appear.  
Use the cursor button to select the following.  
EASY MENU > ADVANCED MENU > NETWORK  
> NETWORK SETUP > WIRED SETUP
- 3) Set the following items in WIRED SETUP.

- DHCP
- IP ADDRESS
- SUBNET MASK
- DEFAULT GATEWAY
- DNS SERVER

As for setting an IP address, refer to About IP address. (📖 19)

Select APPLY, then press the **ENTER** button to reflect the settings.



[About IP address]

■ Setting manually

The Network address portion of the IP address setting on your computer must be the same as the setting on the projector. Also, the entire IP address on the computer must not overlap with that of the other devices on the same network, including the projector.

The projector's settings are as follows.

IP address: 192.168.1.254

Subnet mask: 255.255.255.0

(Network address: 192.168.1 in this case)

Therefore, specify the computer's IP address as follows.

IP address: 192.168.1.xxx (xxx shows decimal number.)

Subnet mask: 255.255.255.0

(Network address: 192.168.1 in this case)

For example

Select from 1 to 254 for "xxx" not duplicating with any other equipments.

In this case, since the IP address of the projector is "192.168.1.254", specify a setting between 1 to 253 for the computer.

■ Setting automatically

When a DHCP server exists in the connected network, it assigns an IP address to the projector and the computer automatically. If DHCP server is not available, set IP ADDRESS, SUBNET MASK, DEFAULT GATEWAY and DNS SERVER.

NOTE

- The same network address cannot be used for both wireless LAN and wired LAN.
- If the projector and the computer exist in the same network (i.e., same network address), you can leave the default gateway field blank.
- When the projector and the computer exist in different networks, the default gateway must be set. Consult to the network administrator in detail.
- When DNS SERVER at DHCP OFF is set to other than "0.0.0.0", this projector uses user setting at DHCP OFF as DNS server address even if DHCP is set to ON and the projector can automatically obtain DNS SERVER setting from DHCP server.

### 2.3 Applications

The latest version of the application software can be downloaded from the website below.

<http://www.dukaneav.com>

For iOS/Android Network Presentation software, refer to the URL below for the details and downloads of Projector Quick Connection.

<http://www.dukaneav.com>

#### [System Requirements for Applications]

Application	Hardware and Software
LiveViewer	Refer to the manual of the application for details.
Projector Quick Connection	
Projector Image Tool (PJImg)	
Projector Messenger Tool (PJMessenger)	

## 2.4 NETWORK Menu

Remember that incorrect network settings on this projector may cause trouble on the network. Be sure to consult with your network administrator before connecting to an existing access point on your network.

Select “NETWORK” from the main menu to access to the following functions.



**NOTE** • The projector does not allow both wireless and wired LAN to be connected to the same network.



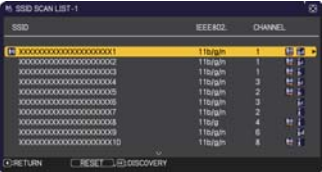

- If you do not use SNTP, then you must set the DATE AND TIME during the initial installation. (📖OPTION menu in the Operating Guide)
- The network function is not available when STANDBY MODE is set to NETWORK(WOL) or SAVING and the projector is in standby mode. Connect the projector to the network after setting STANDBY MODE to QUICK START or NORMAL. (📖SETUP menu in the Operating Guide)
- When using wireless network function, set NETWORK - WIRELESS NETWORK to ON.

Item	Description
<p><b>NETWORK INFORMATION</b></p>	<p>Displays the network information of the projector.</p> <ul style="list-style-type: none"> <li>• WIRELESS INFORMATION</li> <li>• WIRED INFORMATION</li> <li>• OTHER INFORMATION</li> </ul> <div style="border: 1px solid black; border-radius: 10px; padding: 5px; margin-top: 10px;"> <p>NOTE • IP ADDRESS, SUBNET MASK and DEFAULT GATEWAY indicate “0.0.0.0” when DHCP is ON and the projector has not gotten address from DHCP server.</p> </div>
<p><b>WIRELESS NETWORK</b></p>	<p>Switches ON/OFF of wireless network function.</p>

(continued on next page)

Item	Description	
<p style="text-align: center;"><b>NETWORK SETUP / WIRELESS SETUP</b></p>		<p>Configures wireless network. Configured values are saved after selecting "APPLY".</p>  <div style="border: 1px solid black; padding: 10px; margin-top: 10px;"> <p><b>NOTE</b></p> <ul style="list-style-type: none"> <li>Configured values are not saved if Menu disappears before selecting "APPLY".</li> <li>Be sure to execute "APPLY" after changing the settings.</li> </ul> </div>
	<p><b>SSID SCAN LIST</b></p>	<p>Searches available wireless network and displays the list of SSID. You can select SSID to connect from the list. (1) SSID on available wireless network is displayed after selecting SSID SCAN LIST and press the ► button.</p>  <div style="border: 1px solid black; padding: 10px; margin-top: 10px;"> <p><b>NOTE</b></p> <ul style="list-style-type: none"> <li>The wireless network using the encryption method not supported by the projector is not displayed in the search list.</li> <li>A network device of Ad Hoc is not displayed on SSID SCAN LIST.</li> </ul> </div>

(continued on next page)

Item	Description			
<p><b>NETWORK SETUP / WIRELESS SETUP (continued)</b></p>	<p><b>SSID SCAN LIST (continued)</b></p>	<table border="1"> <thead> <tr> <th data-bbox="430 177 542 213">Icon</th> <th data-bbox="542 177 1012 213">Description</th> </tr> </thead> </table>	Icon	Description
		Icon	Description	
			<p>The projector is connecting to the wireless network.</p>	
			<p>The wireless network is encrypted.</p>	
	<p>The intensity of radio wave.</p>			
		<p>(2) Select SSID that you want to connect and press the ► or <b>ENTER</b> button. The display to enter the encryption key appears if SSID is encrypted. Enter the characters by using software keyboard. Move the cursor to OK and press the ►, <b>ENTER</b> or <b>↵</b> button after entering.</p> <div data-bbox="493 596 975 874" style="border: 1px solid black; padding: 5px; margin: 10px auto; width: fit-content;">  </div> <div data-bbox="449 890 1012 1011" style="border: 1px solid black; border-radius: 15px; padding: 10px; margin: 10px auto; width: fit-content;"> <p><b>NOTE</b></p> <ul style="list-style-type: none"> <li>• If you select the [HIDE THE CHARACTERS] checkbox, the characters are hidden.</li> </ul> </div>		

(continued on next page)



Item	Description
<p><b>NETWORK SETUP / WIRELESS SETUP (continued)</b></p>	<p><b>SSID SCAN LIST (continued)</b></p> <p>(3) The OSD below is displayed while the connection is in progress.</p> <p><b>CONNECTING...</b></p> <p>The keys other than <b>RESET</b> button are not available while the connection is in progress. The connection process is interrupted when pressing the <b>RESET</b> button.</p> <p>The OSD below is displayed when the connection process is complete.</p> <p><b>SUCCEEDED</b> : Connection succeeded</p> <p>The message below is displayed when the connection is not established correctly.</p> <p><b>FAILED</b> : Connection failed</p> <p><b>ENCRYPTION LOCK</b> : Encryption Lock enabled</p> <div style="border: 1px solid black; padding: 10px; margin: 10px 0;"> <p><b>NOTE</b></p> <ul style="list-style-type: none"> <li>• Encryption settings cannot be changed when encryption lock is enabled in Network Settings – Wireless Setup in Projector Web Control. Refer to Encryption Lock. (43)</li> <li>• Open System Authentication is used for WEP encryption, and Shared Key Authentication is not supported. The authentication with an access point is succeeded and it is regarded that the connection is established normally even when entering illegal encryption key due to Open System Authentication, but data cannot actually be transmitted.</li> </ul> </div> <p>(4) The icon indicating the connection status () is displayed in SSID SCAN LIST when the connection is complete.</p>

(continued on next page)

Item	Description	
<p><b>NETWORK SETUP / WIRELESS SETUP (continued)</b></p>	<p><b>SSID SCAN LIST (continued)</b></p>	 <p>This function is not available in SIMPLE ACCESS POINT mode.</p>
	<p><b>MODE</b></p>	<p>Switches between SIMPLE ACCESS POINT and INFRASTRUCTURE.                      Select the mode of the network communication system. Select according to the settings of your computer.</p> <p style="text-align: center;">SIMPLE ACCESS POINT                      ⇕                      INFRASTRUCTURE</p> <div style="border: 1px solid black; padding: 10px; margin-top: 10px;"> <p><b>NOTE</b></p> <ul style="list-style-type: none"> <li>• The setting changed before switching MODE without selecting "APPLY" is cancelled.</li> <li>• When switching MODE, it takes 60 seconds to be able to use wireless LAN. In the meantime, the operating speed of the projector may be decreased and NETWORK INFORMATION may not be displayed correctly.</li> </ul> </div>

(continued on next page)

Item	Description	
<b>NETWORK SETUP / WIRELESS SETUP (continued)</b>	<b>DHCP</b>	Configures whether IP address is automatically obtained or not. Use the ▲/▼ buttons to turn DHCP on/off. ON ⇔ OFF This function is not available in SIMPLE ACCESS POINT mode.
	<b>IP ADDRESS</b>	[MODE:SIMPLE ACCESS POINT] Refer to "Connection in Simple Access Point Mode". (15) [MODE:INFRASTRUCTURE] Configures the IP address when DHCP is OFF.
	<b>SUBNET MASK</b>	[MODE:SIMPLE ACCESS POINT] This setting is fixed to 255.255.255.0. [MODE:INFRASTRUCTURE] Configures the subnet mask when DHCP is OFF.
	<b>DEFAULT GATEWAY</b>	Configures the default gateway when DHCP is OFF. This function is not available in SIMPLE ACCESS POINT mode.
	<b>DNS SERVER</b>	Configures the DNS server when DHCP is OFF. This function is not available in SIMPLE ACCESS POINT mode.









(continued on next page)

Item	Description	
<b>NETWORK SETUP / WIRELESS SETUP (continued)</b>	<b>SSID</b>	Configures SSID for wireless network. Enter SSID by using software keyboard. Refer to PROJECTOR NAME ( 30 ) for how to use software keyboard.
	<b>SSID BROADCAST</b>	Configures SSID BROADCAST. When this function is set to OFF, SSID of the projector is not displayed in wireless connection list of the device. This function is not available in INFRASTRUCTURE mode.
	<b>ENCRYPTION</b>	Select the encryption method to be used. WPA2-PSK(AES) ↔ WPA2-PSK(TKIP) ↕  ↕ OFF  WPA-PSK(AES) ↕  ↕ WEP 64bit ↔ WEP 128bit ↔ WPA-PSK(TKIP)  WEP 64bit and WEP 128bit are available only in INFRASTRUCTURE mode.  It is required to enter the encryption key when selecting the encryption method other than OFF and pressing the ► button.  <div data-bbox="449 868 1020 1187" style="border: 1px solid black; padding: 5px;"><p><b>NOTE</b></p><ul style="list-style-type: none"><li>• WPA2-PSK (AES) is recommended for encryption method of IEEE802.11n/ac. Transmission speed in IEEE802.11n/ac may be slow when other encryption method (OFF, WEP, WPA-PSK (TKIP), WPA-PSK(AES), WPA2-PSK (TKIP)). Change the setting to "AES" if encryption other than "AES" is set.</li><li>• Encryption method not included in the selected item cannot be available.</li></ul></div>

(continued on next page)

Item	Description	
<b>NETWORK SETUP / WIRED SETUP</b>	Configures wired network. Configured values are saved after selecting "APPLY".  <div style="border: 1px solid black; padding: 5px; margin-top: 10px;"> <p><b>NOTE</b></p> <ul style="list-style-type: none"> <li>• Configured values are not saved if Menu disappears before selecting "APPLY".</li> <li>• Be sure to execute "APPLY" after changing the settings.</li> </ul> </div>	
	<b>DHCP</b>	Configures whether IP address is automatically obtained or not. ON ⇄ OFF
	<b>IP ADDRESS</b>	Configures the IP address when DHCP is OFF.
	<b>SUBNET MASK</b>	Configures the subnet mask when DHCP is OFF.
	<b>DEFAULT GATEWAY</b>	Configures the default gateway when DHCP is OFF.
	<b>DNS SERVER</b>	Configures the DNS server when DHCP is OFF.
<b>NETWORK SETUP / SNTP SETUP</b>	<b>SNTP SERVER</b>	When you get the time via the network, specify SNTP server with IP address or domain name. Up to 255 characters can be entered for domain name. They are entered by using software keyboard. Refer to PROJECTOR NAME (P.30) for how to use software keyboard.
	<b>TIME DIFFERENCE</b>	Enter the time difference. Set the same time difference as the one set on your computer. If unsure, consult your network administrator. Use the ► button to return to the menu after setting the TIME DIFFERENCE.

(continued on next page)

Item	Description
<b>NETWORK SETUP / PROJECTOR NAME</b>	<p>Any name can be set to the projector to identify it on the network.</p> <p>(1) Select the PROJECTOR NAME and press the ► button. The PROJECTOR NAME dialog will be displayed.</p>  <p>Use displayed software keyboard to enter PROJECTOR NAME.</p> <p>(2) The current PROJECTOR NAME will be displayed on the first 3 lines. Use the <b>ENTER</b> or  button to select and enter characters. To erase 1 character at one time, press the <b>RESET</b> button or press the ◀ and  button at the same time. Also if you move the cursor to DELETE or CLEAR ALL on screen and press the <b>ENTER</b> or  button, 1 character or all characters will be erased. Up to 64 characters can be input for the PROJECTOR NAME.</p> <p>(3) To change an already inserted character, move the cursor to one of the first 3 lines, and move the cursor on the character to be changed. After pressing the <b>ENTER</b> or  button, the character is selected. Then, follow the same procedure as described at the item (2) above.</p>  <p>(4) To finish entering text, move the cursor to the OK on screen and press the ►, <b>ENTER</b> or  button.</p> <p>To revert to the previous PROJECTOR NAME without saving changes, move the cursor to the CANCEL on screen and press the ◀, <b>ENTER</b> or  button.</p> 

(continued on next page)

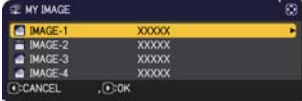
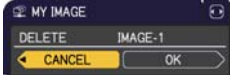

Item	Description
<b>MY IMAGE</b>	<p>Selecting this item displays the MY IMAGE menu. Use the application to transfer the image data. It can be downloaded from the website.</p>  <p>Refer to 5. My Image Function (📖 80) for the details of MY IMAGE.</p> <p>Select an item of still image by the MY IMAGE and the ► or <b>ENTER</b> button to display the image.</p> <ul style="list-style-type: none"> <li>• The item without stored image cannot be selected.</li> <li>• Each image name is displayed in 16 characters or less.</li> </ul> <p><b>To switch the image displayed</b> Use the ▲/▼ buttons.</p> <p><b>To return to the menu</b> Press the ◀ button on the remote control.</p> <p><b>To erase the displayed image and its source file in the projector.</b></p> <p>(1) Press the <b>RESET</b> button on the remote control while displaying an image to display the MY IMAGE DELETE menu.</p>  <p>(2) Press the ► button to erase. To stop erasing, press the ◀ button.</p>

(continued on next page)

Item	Description	
<b>EXTERNAL CONTROL</b>	<b>AMX D.D. (AMX Device Discovery)</b>	Use the ▲/▼ buttons to turn the AMX Device Discovery on/off. ON ⇔ OFF When ON is selected, the projector can be detected by controllers of AMX connected to the same network. For the details of AMX Device Discovery, visit the AMX website. URL: <a href="http://www.amx.com/">http://www.amx.com/</a>
	<b>CRESTRON</b>	Use the ▲/▼ buttons to turn the Crestron Connected™ on/off. ON ⇔ OFF When ON is selected, controlling and managing the projector can be performed by using the controllers of Crestron® connected to the same network. For the details of Crestron Connected™, visit the following website. URL: <a href="http://www.crestron.com/">http://www.crestron.com/</a>

(continued on next page)



Item	Description	
<b>OTHER OPERATION</b>	<p>To use Network Presentation, an exclusive application is required. Refer to 4. Network Presentation (📖 76) for the details of Network Presentation.</p>	
	<b>QUIT PRESENTER MODE</b>	<p>If you set a computer to the Presenter mode while its image is projected, the projector is occupied by the computer and access from any other computer is blocked. Use this function to quit the Presenter mode and allow other computers to access the projector. Select this item to display a dialog. Press the ► button to choose OK in the dialog. The Presenter mode is cancelled and a message is displayed indicating the result.</p>
	<b>MULTI PC MODE</b>	<p>If you set one or more computers to the Multi PC mode and send their images to the projector, you can select the display mode on the projector from two options below.</p> <ul style="list-style-type: none"> <li>- Single PC mode: displays the image of the selected computer on full screen.</li> <li>- Multi PC mode: displays the images sent from up to four computers on screen that is divided into quarter sections.</li> </ul> <p>Select this item to display a dialog. Use the dialog to change the display mode as explained below.</p> <ul style="list-style-type: none"> <li>• To change from Multi PC mode to Single PC mode, select one of computers in the dialog using the ▲/▼/◀/▶ buttons and press the <b>ENTER</b> or  button.</li> </ul> <p>Press the ► button to choose OK, and then press <b>ENTER</b> or  again. The image for the selected computer is displayed on full screen. (continued on next page)</p>

(continued on next page)

Item	Description	
OTHER OPERATION (continued)	MULTI PC MODE (continued)	<ul style="list-style-type: none"> <li>To change from Single PC mode to Multi PC mode, press the ► button to choose OK in the dialog and press the <b>ENTER</b> or <b>↵</b> button. The display mode is changed.</li> <li>The Presenter mode setting of the selected computer becomes valid when the display mode is changed to Single PC mode. Also, the Presenter mode setting becomes invalid when the display mode is changed to Multi PC mode, regardless of the setting on the computers.</li> </ul> 
	DISPLAY USER NAME	Selecting this item displays the user name. This function helps you identify from which computer the current image is sent.

## 3. Web Control

You can adjust or control the projector via a network from a web browser on a computer connected to the same network.

### ■ Projector Web Control

You can control the projector, collect the status such as input status, and set e-mail or schedule, etc. in Projector Web Control.

Recommended web browser

- Internet Explorer® 11
- Microsoft® Edge

Web Control cannot be displayed by old versions of the browser.  
Please use the latest version.

The screenshot shows the 'Projector Web Control' interface with a 'Network Information' section. It is divided into 'Common Information', 'Wireless Information', and 'Wired Information'.

Common Information	
Projector Name	PUXXXXXXXXXX

Wireless Information	
Wireless Network	ON
Mode	Single Access Point
DHCP	
IP Address	192.168.1.1
Subnet Mask	255.255.255.0
Default Gateway	
DNS Server	
MAC Address	XX:XX:XX:XX:XX:XX
SSID	SingleAccessPoint
SSID Broadcast	ON
Encryption	OFF
Wireless Proxy	2.4 GHz
Bandwidth	30 Mbps
Channel	11
Speed	

Wired Information	
DHCP	ON
IP Address	192.168.1.10
Subnet Mask	255.255.255.0
Default Gateway	0.0.0
DNS Server	0.0.0
MAC Address	XX:XX:XX:XX:XX:XX

### NOTE

- Web browsers other than recommended ones may not work.
- If JavaScript® is disabled in your web browser configuration, you must enable JavaScript® in order to use the projector web pages properly. See the Help files for your web browser for details on how to enable JavaScript®.
- It is recommended that all web browser updates are installed.
- If data is transferred via wireless and wired LAN at the same time, the projector may not process the data correctly.

(continued on next page)

#### ■ Crestron e-Control®

Crestron e-Control® is a control interface using a web browser provided by Crestron Electronics, Inc..

Crestron e-Control® can control and monitor the projector.



- NOTE
- Crestron e-Control® is created using Flash®. You need to install Adobe® Flash® Player on your computer to use Crestron e-Control®. Crestron e-Control® is not displayed in a web browser that does not support Flash®.
  - In any of the following cases, Crestron e-Control® cannot be used.
    - Network Settings - Other Setup - Crestron e-Control is "Disable" (📖 47)
    - Network Settings - Common Setup - Crestron is "OFF" (📖 42)
    - NETWORK menu - EXTERNAL CONTROL - CRESTRON is "OFF" (📖 32)

### Access from Web browser

- 1) Please start a Web browser of device.
- 2) Enter the projector's IP address into URL input box of the Web browser as the example below, and then press the Enter key.  
Example: If the IP address of the projector is set to 192.168.1.10.  
"http://192.168.1.10/"
- 3) If a correct URL is input, and the projector and your computer are connected to the same network correctly, the selection window will be displayed.



**NOTE** • Do not control the projector with the projector's menu or remote control, and via Web Control at the same time. It may cause some operational errors in the projector.

• The language used on the Projector Web Control is the same as that of the OSD on the projector. If you want to change it, you need to change the OSD language on the projector. (📖SCREEN menu in the Operating Guide)

## 3.1 Projector Web Control

### 3.1.1 Login

To use the Projector Web Control function, you need to login with your user name and password.

Below are the factory default settings for user name and password.



Login window

<b>User name</b>	Administrator
<b>Password</b>	<blank>



Enter your user name and password, and then click the **[OK]**. If you login successfully, the screen below will be displayed.



### 3.1 Projector Web Control (continued)

#### ■ Displaying the Main menu and Option menu.

In the Header area of the upper part of the screen, the following operations are available.

Item	Description
 (Menu)	Displays the Main menu. The detailed screen is displayed by clicking on the item in the Main menu. The Main menu can be closed by clicking the Close button or outer area of the Main menu.
 (Reload)	Updates the screen.
 (Option)	Opens or closes the Option menu. The computer screen or the mobile screen can be selected by Option menu.

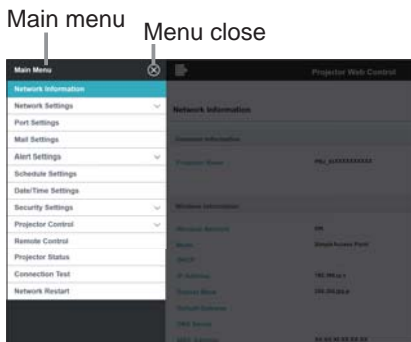
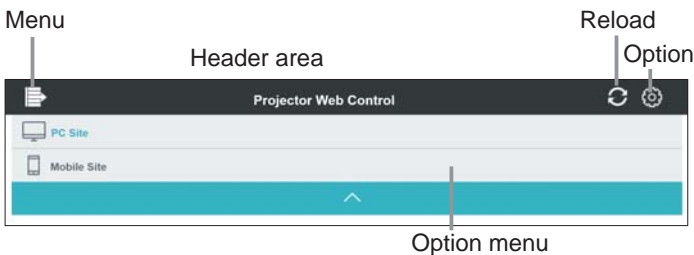

Click the desired operation or configuration item on the main menu.

### 3.1 Projector Web Control (continued)

#### 3.1.2 Network Information

Displays the network setting information of the projector.

The screenshot shows the 'Projector Web Control' interface with the 'Network Information' section expanded. The interface is divided into three main sections: Common Information, Wireless Information, and Wired Information. Each section contains a list of network-related settings and their values.

Common Information	
Projector Name	PRJ_XXXXXXXXXXXX

Wireless Information	
Wireless Network	ON
Mode	Simple Access Point
DHCP	
IP Address	192.168.10.1
Subnet Mask	255.255.255.0
Default Gateway	
DNS Server	
MAC Address	XX:XX:XX:XX:XX:XX
SSID	SimpleAccessPoint
SSID Broadcast	ON
Encryption	OFF
Wireless Freq.	2.4 GHz
Bandwidth	20 MHz
Channel	11
Speed	

Wired Information	
DHCP	ON
IP Address	192.168.1.10
Subnet Mask	255.255.255.0
Default Gateway	0.0.0.0
DNS Server	0.0.0.0
MAC Address	XX:XX:XX:XX:XX:XX



### 3.1 Projector Web Control (continued)

#### 3.1.3 Network Settings

##### 3.1.3.1 Common Setup

Configures the settings common to wireless and wired LAN.

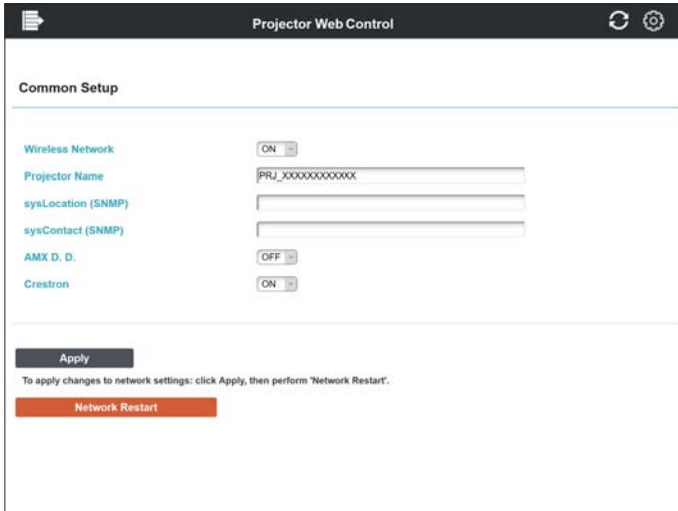

The screenshot shows the 'Projector Web Control' interface with the 'Common Setup' section. The settings are as follows:

Setting	Value
Wireless Network	ON
Projector Name	PRJ_XXXXXXXXXXXX
sysLocation (SNMP)	
sysContact (SNMP)	
AMX D. D.	OFF
Crestron	ON

Buttons: Apply, Network Restart

Note: To apply changes to network settings: click Apply, then perform "Network Restart".

When changing the settings, click the [Network Restart] button after clicking the [Apply] button to reflect the settings of the projector.

**NOTE**

- If you connect the projector to an existing network, consult a network administrator before setting server addresses.
- The projector does not allow both wireless and wired LAN to be connected to the same network. Do not set the same network address for both wireless and wired LAN.

(continued on next page)

**3.1 Projector Web Control - Network Settings (continued)**

Item	Description
<b>Wireless Network</b>	Switches ON/OFF of wireless network function.
<b>Projector Name *1</b>	Configures the name of the projector.
<b>sysLocation (SNMP) *2</b>	Configures the location to be referred to when using SNMP.
<b>sysContact (SNMP) *2</b>	Configures the contact information to be referred to when using SNMP.
<b>AMX D.D. *3 (AMX Device Discovery)</b>	Switches ON/OFF of AMX Device Discovery. When ON is selected, the projector can be detected and controlled by AMX device connected to the same network.
<b>Crestron *4</b>	Switches ON/OFF of Crestron® function. When ON is selected, Crestron® can control the projector from the controllers of Crestron® device connected to the same network.

\*1 The text length can be up to 64 alphanumeric characters and symbols. Only symbols "!"#\$%&'()\*+,-./:;<=>?@[^\]\_`{|}~ and space" can be used.

\*2 The text length can be up to 255 alphanumeric characters.

\*3 Refer to the AMX website for the details of the AMX Device Discovery.

URL: <http://www.amx.com>

\*4 Refer to the chapter "8.5 Crestron Connected™" for the details of the Crestron®.

## 3.1 Projector Web Control - Network Settings (continued)

### 3.1.3.2 Wireless Setup

Configures the wireless LAN settings.

The screenshot shows the 'Projector Web Control' interface for 'Wireless Setup'. It is divided into three main sections:

- Simple Access Point settings:**
  - Mode:** Single Access Point
  - Encryption Lock:** OFF
  - IP Configuration:** IP Address (192.168.10.1), Subnet Mask (255.255.255.0)
  - SSID:** ServiceAccessPoint
  - SSID Broadcast:** ON
  - Encryption:** OFF
  - WPA Passphrase:** [Empty field]
  - Wireless Freq.:** 2.4GHz
  - Bandwidth:** 20MHz
  - Channel:** 11
- Infrastructure settings:**
  - IP Configuration:** DHCP ON, DHCP OFF (selected), IP Address (192.168.10.204), Subnet Mask (255.255.255.0), Default Gateway (0.0.0.0), Web Server (0.0.0.0)
  - SSID:** [Empty field]
  - Encryption:** OFF
  - WEP Key:** [Empty field]
  - WPA Passphrase:** [Empty field]
- Bottom Section:**
  - Apply:** [Apply button]
  - Network Restart:** [Network Restart button]

When changing the settings, click the [Network Restart] button after clicking the [Apply] button to reflect the settings of the projector.

Item	Description
<b>Mode</b>	Switches wireless connection mode.
<b>Encryption Lock</b>	Switches ON/OFF of Encryption Lock. When Encryption Lock is set to ON, these settings cannot be changed by the menu of the projector. Mode / SSID / SSID Broadcast / Encryption / Encryption key (WEP key, WPA Passphrase)

(continued on next page)

### 3.1 Projector Web Control - Network Settings (continued)

#### 1. Simple Access Point settings

Item	Description
<b>IP Configuration</b>	Configures the IP Address of the projector in Simple Access Point mode. Subnet Mask of this mode is fixed to 255.255.255.0.
<b>SSID *1</b>	Configures SSID of Simple Access Point mode.
<b>SSID Broadcast</b>	Switches ON/OFF of SSID Broadcast. When this function is set to OFF, SSID of the projector is not displayed in wireless connection list of the device.
<b>Encryption</b>	Selects data encryption method.
<b>WPA Passphrase *2</b>	Configures WPA Passphrase.
<b>Wireless Freq.</b>	Configures the frequency for the wireless connection.
<b>Bandwidth</b>	Configures the frequency bandwidth for the wireless connection. If you want to get a higher link speed, change this to 40MHz or 80MHz.  <div style="border: 1px solid black; border-radius: 10px; padding: 10px; margin-top: 10px;"> <p>NOTE • Depending on your internet connection, the projector may not operate with the bandwidth you set or you may not get a higher link speed.</p> </div>
<b>Channel</b>	Selects the wireless channel. The selectable channels are different depending on the wireless frequency band and Bandwidth.  <div style="border: 1px solid black; border-radius: 10px; padding: 10px; margin-top: 10px;"> <p>NOTE • This projector uses the 5 GHz and 2.4 GHz radio frequency band, but depending on the country or region you are in, the channels that you can use might be limited. Please consult your dealer for information on the usable channels.</p> </div>

\*1 The text length can be up to 32 alphanumeric characters and symbols. Only symbols “!\"#\$%&'()\*+,-./:;<=>?@[\\]^\_`{|}~ and space” can be used.

\*2 The text length can be 8 to 63 alphanumeric characters and symbols. Only symbols “!\"#\$%&'()\*+,-./:;<=>?@[\\]^\_`{|}~ and space” can be used.

(continued on next page)

### 3.1 Projector Web Control - Network Settings (continued)

#### 2. Infrastructure settings

Item	Description									
<b>IP Configuration</b>	Configures the network settings of the projector in Infrastructure mode. [DHCP ON] Enables DHCP. [DHCP OFF] Disables DHCP. Configures IP Address, Subnet Mask, Default Gateway and DNS server.									
<b>SSID *1</b>	Configures the SSID of Infrastructure mode.									
<b>Encryption</b>	Selects data encryption method.									
<b>WEP Key</b>	Inputs the WEP key. Either ASCII characters or hexadecimal numbers can be used. However, a combination of both cannot be used. <table border="1" data-bbox="386 734 983 826"> <thead> <tr> <th>Encryption</th> <th>ASCII characters</th> <th>HEX numbers</th> </tr> </thead> <tbody> <tr> <td>WEP 64bit</td> <td>5 characters</td> <td>10 characters</td> </tr> <tr> <td>WEP 128bit</td> <td>13 characters</td> <td>26 characters</td> </tr> </tbody> </table>	Encryption	ASCII characters	HEX numbers	WEP 64bit	5 characters	10 characters	WEP 128bit	13 characters	26 characters
Encryption	ASCII characters	HEX numbers								
WEP 64bit	5 characters	10 characters								
WEP 128bit	13 characters	26 characters								
<b>WPA Passphrase *2</b>	Inputs WPA Passphrase.									

\*1 The text length can be up to 32 alphanumeric characters and symbols. Only symbols "!"#\$%&'()\*+,-./:;<=>?@[\\]^\_`{|}~ and space" can be used.

\*2 The text length can be 8 to 63 alphanumeric characters and symbols. Only symbols "!"#\$%&'()\*+,-./:;<=>?@[\\]^\_`{|}~ and space" can be used.

**NOTE** • If Encryption Lock is ON, wireless connection is performed only when it can be connected without changing the current settings.

- The channels may vary depending on the country. In addition, depending on the country or region, it may be required to use a wireless network card that conforms to the standards in the respective country or region.
- If you connect the projector to an existing network, consult a network administrator before setting server addresses.
- The projector does not allow both wireless and wired LAN to be connected to the same network. Do not set the same network address for both wireless and wired LAN.

### 3.1 Projector Web Control - Network Settings (continued)

#### 3.1.3.3 Wired Setup

Configures the wired LAN settings.

The screenshot shows the 'Projector Web Control' interface. The page title is 'Wired Setup'. Under the 'IP Configuration' section, the 'DHCP ON' option is selected. The configuration fields are as follows:

Field	Value
IP Address	192.168.1.254
Subnet Mask	255.255.255.0
Default Gateway	0.0.0.0
DNS Server	0.0.0.0

Buttons: Apply, Network Restart. Note: To apply changes to network settings: click Apply, then perform 'Network Restart'.

When changing the settings, click the [Network Restart] button after clicking the [Apply] button to reflect the settings of the projector.

Item	Description
IP Configuration	Configures network settings. [DHCP ON] Enables DHCP. [DHCP OFF] Disables DHCP. Configures IP Address, Subnet Mask, Default Gateway, and DNS server.

### 3.1 Projector Web Control - Network Settings (continued)

#### 3.1.3.4 Other Setup

Configures other network settings.



When changing the settings, click the [Apply] button to reflect the settings of the projector.

Item	Description
<b>Crestron e-Control</b> *1	Configures Enable/Disable of Crestron e-Control®.

\*1 Refer to chapter “3.2 Crestron e-Control®” for the details of the Crestron e-Control®.

### 3.1 Projector Web Control (continued)

#### 3.1.4 Port Settings

Configures the network communication port.

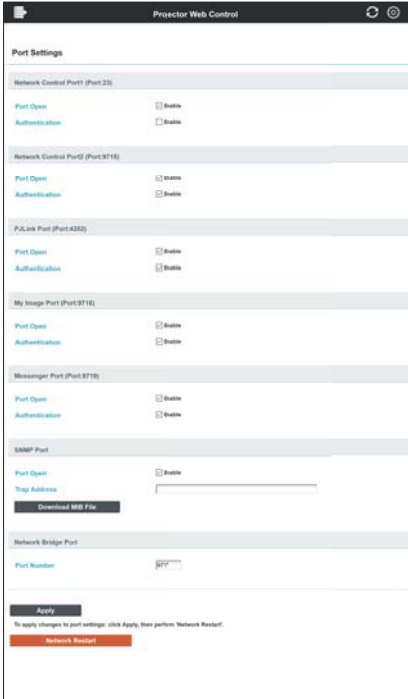

When changing the settings, click the [Network Restart] button after clicking the [Apply] button to reflect the settings of the projector.

Item	Description
<b>Port Open</b>	Configures Enable/Disable of the Port Open. When disabling unused port function, the access from an illegal user can be prevented.
<b>Authentication</b>	Configures Enable/Disable of Authentication.
<b>Trap Address *1</b>	Configures the destination of the SNMP trap. This item can be set not only by IP address but also by domain name.
<b>Download MIB File</b>	Downloads a MIB file for SNMP from the projector.
<b>Port Number</b>	Configures the port number used to the Network Bridge function.

\*1 The text length can be up to 255 alphanumeric characters, "-", and ".".



### 3.1 Projector Web Control (continued)

#### 3.1.1.5 Mail Settings

Configures the e-mail settings.

When changing the settings, click the [Apply] button to reflect the settings of the projector. This setting can be restored to the initial setting when clicking the [Reset] button. Sends a test e-mail when clicking [Send Test Mail].

Item	Description
<b>Send Mail</b>	Configures Enable/Disable of sending e-mail. The contents of the e-mail can be edited on each screen of the Alert Settings.
<b>Authentication</b>	Selects the authentication method.
<b>User Name</b> *1	Enter the same user name of the SMTP server or POP server.
<b>Password</b> *1	Enter the same password of the SMTP server or POP server.

\*1 The text length can be up to 63 alphanumeric characters and symbols. Only symbols “!\"#\$%&'()\*+,-./:;<=>@[\\]^\_`{|}~ and space” can be used.

(continued on next page)

### 3.1 Projector Web Control - Mail Settings (continued)

#### 1. SMTP / POP Server

Item	Description
<b>Server Address *1</b>	Configures the SMTP server address or the POP server address. This item can be set not only by IP address but also by domain name.
<b>Port Number</b>	Configures the port number of the SMTP server or the POP server.

\*1 The text length can be up to 255 alphanumeric characters, "-", and ".".

#### 2. Mail Address

Item	Description
<b>Sender E-mail Address *1</b>	Configures the sender e-mail address.
<b>Recipient E-mail Address *1</b>	Configures the e-mail address of up to five recipients. You can also specify the [to] or [cc] for each address.

\*1 The text length can be up to 255 alphanumeric characters, "-", ".", "\_", and "@".

**NOTE** • You can confirm whether the mail settings work correctly by using the **[Send Test Mail]** button. Enable Send Mail setting before clicking the **[Send Test Mail]**.

- If you connect the projector to an existing network, consult a network administrator before setting server addresses.
- To use a domain name to the address of the SMTP server or POP server, setting the DNS server is necessary.
- The characters used for mail address may not be allowed depending on mail server.

### 3.1 Projector Web Control (continued)

#### 3.1.6 Alert Settings

Configures notifications of errors/warnings.

Refer to chapter “8.1 E-mail Alerts” for the details of the above errors/warnings. When changing the settings, click the **[Apply]** button to reflect the settings of the projector.

This setting can be restored to the initial setting when clicking the **[Reset]** button.

Item	Description
<b>Alarm Time</b> *1	Configures the time to alert.
<b>SNMP Trap</b> *2	Click the <b>[Enable]</b> check box to enable SNMP Trap alerts.
<b>Send Mail</b>	Click the <b>[Enable]</b> check box to enable e-mail alerts.
<b>Mail Subject</b> *3	Configures the subject line of the e-mail to be sent.
<b>Mail Text</b> *4	Configures the text of the e-mail to be sent.

\*1 Only Filter Time Alarm.

\*2 The setting item of Cold Start and Authentication Failure is SNMP Trap only.

\*3 The text length can be up to 100 alphanumeric characters and symbols. Using any Multi-byte character may shorten the text. Only symbols “!\"#\$%&'()\*+,-./:;<=>?@[\\]^\_`{|}~ and space” can be used.

\*4 The text length can be up to 1024 alphanumeric characters and symbols. Using any Multi-byte character may shorten the text. Only symbols “!\"#\$%&'()\*+,-./:;<=>?@[\\]^\_`{|}~ and space” can be used.

### 3.1 Projector Web Control (continued)

#### 3.1.7 Schedule Settings

##### 3.1.7.1 Schedule Management

Configures the schedule settings.

Refer to chapter “8.3 Event Scheduling” for the details of the schedule settings.

Click the checkbox of the specific day or day to perform a schedule, and select the program number to use.

When setting the specific date, enter the date (month/day).

Click the **[Apply]** button to save the settings in the projector.

Confirm the event information registered in each program on the screen.

**NOTE** • Be sure to set the date and time before enabling scheduled events.

#### 1. Program List

Click the "Program List" button to show the program.

( Refer to “3.1.7.2 Program List”)

#### 2. Program Edit

Click the "Program Edit" button to edit the program.

(Refer to “3.1.7.3 Program Edit”)

#### 3. Program Copy

Click the "Program Copy" button to copy the program.

(Refer to “3.1.7.4 Program Copy”)

### 3.1 Projector Web Control - Schedule Settings (continued)

#### 3.1.7.2 Program List

Displays the event information registered in each program.

The screenshot shows the 'Projector Web Control' interface. At the top, there's a navigation bar with a menu icon, the title 'Projector Web Control', and refresh and settings icons. Below this is the 'Schedule Settings' section. Underneath, there's a 'Program List' header. To the right of the header is a blue 'Back' button. Below the header are two buttons: 'Expand All' and 'Collapse All'. The 'Program-1' section is expanded, showing a table with the following data:

#	Time	Event (Parameter)
1	08:00	Power [ON]
2	17:00	Power [STANDBY]

Below the table, programs 2 through 16 are listed, each with a downward arrow indicating they can be expanded.

Click the **[Back]** button to go back to the Schedule Management screen.

### 3.1 Projector Web Control - Schedule Settings (continued)

#### 3.1.1.7.3 Program Edit

Edits the program.

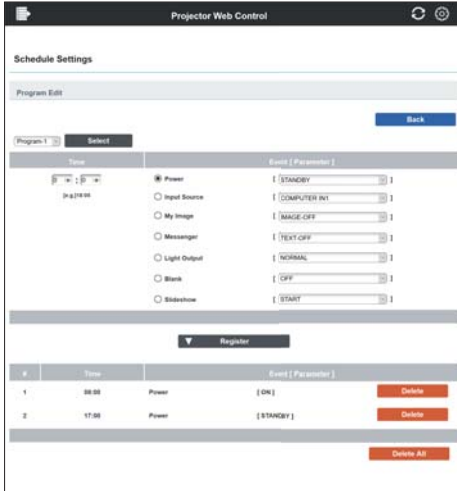

Select the program number to edit, and set the event and time to execute. Click the **[Register]** button to add the event to a selected program number.

Click the **[Delete]** button to delete an event.

Click the **[Delete All]** button to delete all the events.

Click the **[Back]** button to go back to the Schedule Management screen.

The projector can control the following events automatically by using the schedule function.

Item	Description
<b>Power</b>	Configures power control.
<b>Input Source</b>	Configures the switching of Input Source.
<b>My Image</b>	Configures the display of My Image.
<b>Messenger</b>	Configures the display of Messenger text data.
<b>Light output</b>	Configures the switching of Light output.
<b>Blank</b>	Configures On/Off of Blank.
<b>Slideshow</b>	Configures the Start/Stop parameters for the slideshow.

#### NOTE

- A maximum of 16 programs of schedule can be set.
- A maximum of 20 events can be registered in one program.

### 3.1 Projector Web Control - Schedule Settings (continued)

#### 3.1.7.4 Program Copy

Configures the program copy.

Projector WebControl

Schedule Settings

Program Copy

Back

Program 1 Select

#	Time	Event [ Parameter ]
1	09:00	Power [ ON ]
2	17:00	Power [ STANDBY ]

Program-1  
▼ Copy to  
Program-2

Edit

Program 2 Select

#	Time	Event [ Parameter ]
1	09:45	Power [ ON ]
2	12:15	Power [ STANDBY ]

Select the original program number (dropdown list of the upper part of the screen) and program number (dropdown list of the lower part of the screen).

Click the **[Copy to]** button to copy the program.

Click the **[Edit]** button to edit the event of copied program after copying the program.

Click the **[Back]** button to go back to the Schedule Management screen.

#### NOTE

- The same program No. cannot be selected for both the program from which and the program to which you copy.

### 3.1 Projector Web Control (continued)

#### 3.1.1.8 Date/Time Settings

Configures the date/time.

The screenshot shows the 'Date/Time Settings' page in the Projector Web Control interface. It features several sections:

- Date/Time Settings:** Includes 'Current Date' (year/month/day), 'Current Time' (hour/minute/second), and 'Time Difference' (GMT offset).
- Daylight Savings Time:** A checkbox to enable this feature, with 'Start' and 'End' sections for month, week, day, and time.
- SNTP:** Fields for 'Server Address' and 'Cycle'.
- Buttons:** An 'Apply' button and a 'Network Restart' button.
- Instructions:** A note stating 'To apply changes to datetime settings, click Apply, then perform "Network Restart".'

When changing the settings, click the **[Network Restart]** button after clicking the **[Apply]** button to reflect the settings of the projector.

Item	Description
<b>Current Date</b>	Configures the current date.
<b>Current Time</b>	Configures the current time.
<b>Time Difference</b>	Configures the time difference to Greenwich Mean Time.

(continued on next page)



### 3.1 Projector Web Control - Date/Time Settings (continued)

#### 1. Daylight Saving Time

Select the checkbox when using daylight saving time.

Item	Description
<b>Start</b>	Configures the date and time daylight saving time begins.
<b>Month</b>	Configures the month daylight saving time begins.
<b>Week</b>	Configures the week of the month daylight saving time begins.
<b>Day</b>	Configures the day of the week daylight saving time begins.
<b>Time</b>	Configures the time daylight saving time begins.
<b>End</b>	Configures the date and time daylight saving time ends.
<b>Month</b>	Configures the month daylight saving time ends.
<b>Week</b>	Configures the week of the month daylight saving time ends.
<b>Day</b>	Configures the day of the week daylight saving time ends.
<b>Time</b>	Configures the time daylight saving time ends.

#### 2. SNTP

Item	Description
<b>Server Address</b> *1	Configures the SNTP server address. This item can be set not only by IP address but also by domain name.
<b>Cycle</b>	Configures the interval at which to retrieve Date and Time information from the SNTP server.

\*1 The text length can be up to 255 alphanumeric characters, "-", and ".".

**NOTE**

- To enable the SNTP function, the time difference must be set.
- The projector will retrieve Date and Time information from the time server and override time settings when SNTP is enabled.
- The internal clock's time may not remain accurate. Using SNTP is recommended to maintain accurate time.
- The internal battery is required to be replaced when the time is off soon after setting date and time.
- To use a domain name for the address of the SNTP server, setting the DNS server is necessary.

### 3.1 Projector Web Control (continued)

#### 3.1.9 Security Settings

##### 3.1.9.1 User Account

Configures the user name and password for login to Projector Web Control screen.

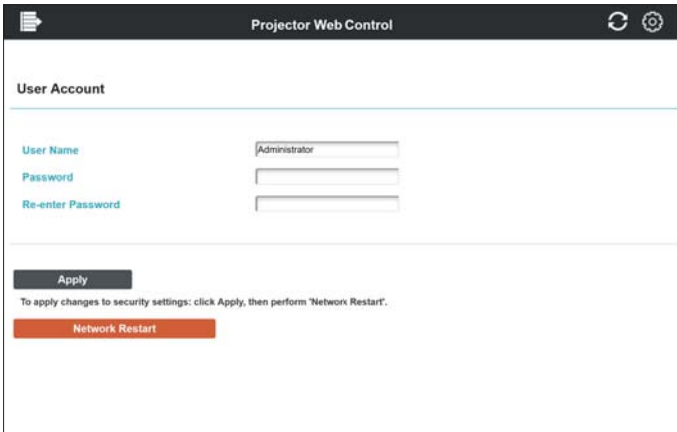

The screenshot shows the 'User Account' configuration page in the Projector Web Control interface. The page has a dark header with a menu icon on the left and refresh and settings icons on the right. The main content area is white and contains the following elements:

- User Account** section header.
- User Name** label and an input field containing the text 'Administrator'.
- Password** label and an empty input field.
- Re-enter Password** label and an empty input field.
- An **Apply** button.
- A note: 'To apply changes to security settings: click Apply, then perform 'Network Restart'.'
- A **Network Restart** button.

When changing the settings, click the **[Network Restart]** button after clicking the **[Apply]** button to reflect the settings of the projector.

Item	Description
<b>User Name</b>	Configures the user name.
<b>Password</b>	Configures the password.
<b>Re-enter Password</b>	Re-enter the above password for verification.

#### NOTE

- Please do not forget the user name and password.

### 3.1 Projector Web Control - Security Settings (continued)

#### 3.1.9.2 Network Control

Configures the password for authentication in the projector control.

When changing the settings, click the **[Network Restart]** button after clicking the **[Apply]** button to reflect the settings of the projector.

Item	Description
<b>Password</b>	Configures the password.
<b>Re-enter Password</b>	Re-enter the above password for verification.

#### NOTE

- This password is used in common for the function using the following communication ports.

Network Control Port1 (Port: 23)

Network Control Port2 (Port: 9715)

PJLink Port (Port: 4352)

My Image Port (Port: 9716)

Messenger Port (Port: 9719)

### 3.1 Projector Web Control - Security Settings (continued)

#### 3.1.1.9.3 Network Presentation

Configures the password for the display restriction of the projected screen of Network Presentation.

The screenshot shows the 'Projector Web Control' interface. At the top, there is a header with a menu icon, the title 'Projector Web Control', and refresh and settings icons. Below the header, the section is titled 'Network Presentation'. There are two input fields: 'Password' and 'Re-enter Password'. Below these fields is an 'Apply' button. A message states: 'To apply changes to security settings: click Apply, then perform 'Network Restart''. At the bottom, there is a red 'Network Restart' button.

When changing the settings, click the **[Network Restart]** button after clicking the **[Apply]** button to reflect the settings of the projector.

Item	Description
<b>Password</b>	Configures the password. When the password is set to blank, the authentication is invalid.
<b>Re-enter Password</b>	Re-enter the above password for verification.

### 3.1 Projector Web Control - Security Settings (continued)

#### 3.1.9.4 SNMP

Configures the community name to use SNMP.

When changing the settings, click the **[Network Restart]** button after clicking the **[Apply]** button to reflect the settings of the projector.

Item	Description
<b>Community Name</b>	Configures the community name.

### 3.1 Projector Web Control (continued)

#### 3.1.10 Projector Control

Configures the function of each item in the projector menu.

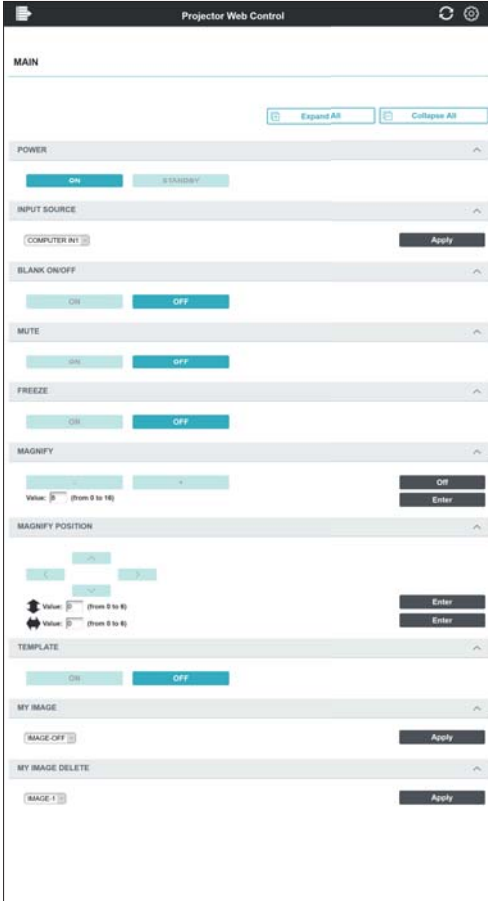

Menu varies depending on the model.

#### NOTE

- If the settings are changed in the menu or by the remote control while changing the settings on this screen, the display and the actual setting may not match. In that case, click the Reload (🔄) button to refresh the screen.

### 3.1 Projector Web Control (continued)

#### 3.1.11 Remote Control

The menu operation and the input source switching can be performed on this screen like a remote control.

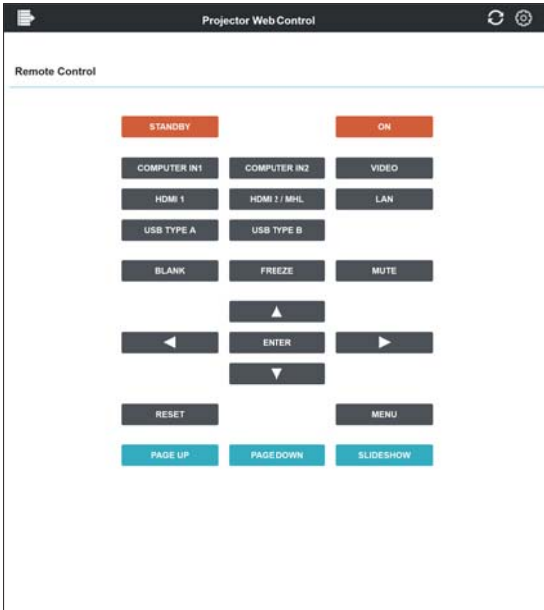

Menu varies depending on the model.

#### NOTE

- Holding down a button is not supported on this screen. The button should be clicked repeatedly to operate continuously.
- When clicking the button quickly and repeatedly, some commands may not be sent correctly. Click it at intervals.
- When the **[STANDBY]** or **[ON]** button is pressed, a message window comes up to confirm the operation. To control the power, press **[OK]**, otherwise press **[Cancel]**.

### 3.1 Projector Web Control (continued)

#### 3.1.12 Projector Status

Displays the information of each status.

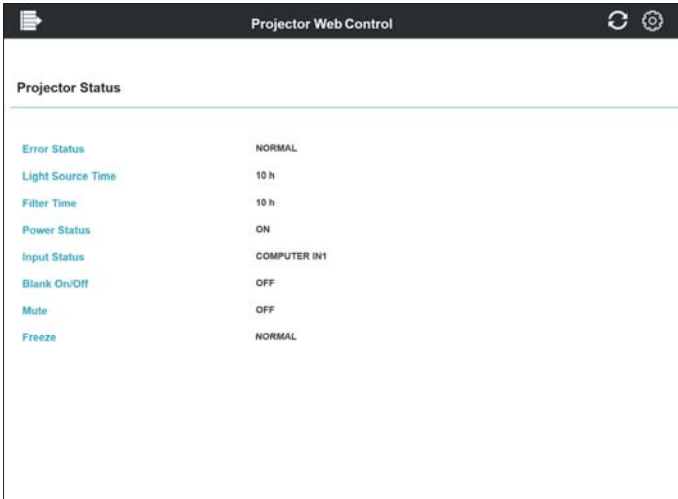

Projector Status	
Error Status	NORMAL
Light Source Time	10 h
Filter Time	10 h
Power Status	ON
Input Status	COMPUTER IN1
Blank On/Off	OFF
Mute	OFF
Freeze	NORMAL

Displayed information varies depending on the model.



### 3.1 Projector Web Control (continued)

#### 3.1.13 Connection Test

Checks the connection to specified IP address.

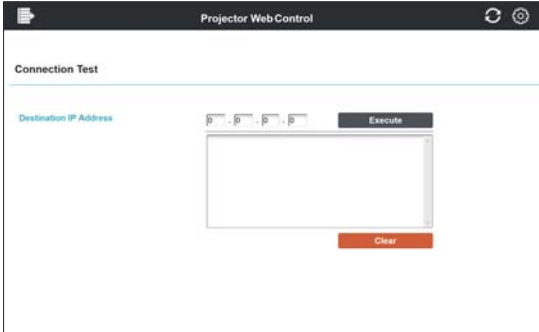

Item	Description
Destination IP Address	Click the <b>[Execute]</b> button to test the connection after entering IP address to connect to.

Display example of the connection succeeded

```
PING 192.168.1.200 (192.168.1.200): 56 data bytes
64 bytes from 192.168.1.200: seq=0 ttl=128 time=2.136 ms
64 bytes from 192.168.1.200: seq=1 ttl=128 time=0.524 ms
```

```
--- 192.168.1.200 ping statistics ---
2 packets transmitted, 2 packets received, 0% packet loss
round-trip min/avg/max = 0.524/1.330/2.136 ms
```

Display example of the connection failed

```
PING 192.168.100.200 (192.168.100.200): 56 data bytes
```

Destination host unreachable.

#### NOTE

- Confirm information of the target IP address with network administrator.
- Connection test may result in an error even if the connection is performed properly when the packets for checking the connection are discarded before arriving at the target depending on the settings of firewall or packet filtering, etc.
- The result of the connection test is displayed only in English.

### 3.1 Projector Web Control (continued)

#### 3.1.14 Network Restart

Restarts the network connection.

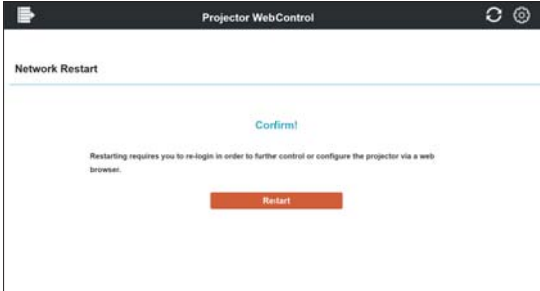

**NOTE** • When the projector has connected successfully with the same network setting as before it restarts, the Network Information screen is automatically displayed after having restarted. The following screen is displayed if the projector cannot connect to the network due to the change of network setting, etc. Finish a browser and start it again.



## 3.2 Crestron e-Control®



The Main window as shown above is displayed at first. However, if you have enabled User Password on the Tools window (71), a dialog prompting you to enter the password as shown on the right will be displayed, and no operation is enabled until you have entered the password. After entering the preset password, the dialog disappears and the Main window will be displayed. As shown below, you can open a window by clicking the corresponding tab at the top right of the window.



User Password dialog

Tab	Description
<b>Logout</b>	Logs out from e-Control®. This tab appears only when User Password of the Tools window is enabled.
<b>Tools</b>	Opens Tools window. (71)
<b>Info</b>	Opens Info window. (73)
<b>Contact IT Help</b>	Opens Help Desk window. (74)

### 3.2 Crestron e-Control® (continued)

NOTE • In any of the following cases, Crestron e-Control® cannot be used.

- Network Settings - Other Setup - Crestron e-Control is "Disable" (📖 47)
- Network Settings - Common Setup - Crestron is "OFF" (📖 42)
- NETWORK menu - EXTERNAL CONTROL - CRESTRON is "OFF" (📖 32)

Set Crestron to on and enable Crestron e-Control®, then close the web browser.

Next, restart the web browser, followed by entering the projector's IP address.

- Only English is supported on Crestron e-Control®.
- If the connection is terminated, the "Loading..." screen will appear. Check the connection between the projector and the computer, then return or refresh the Web page.
- The control from Crestron e-Control® is supported only via wired LAN.

## 3.2 Crestron e-Control® (continued)

### 3.2.1 Main window



You can operate the basic controls of the projector on this screen.

**NOTE** • If the projector is in the standby mode, only the **[Power]** button can be operated.

1. Click a button and operate as follows.

Button	Description
<b>Power</b>	Turns the power on/off.
<b>Vol - / Vol +</b>	Adjusts the volume setting.
<b>Mute</b>	Turns Mute on/off.

#### 2. Sources List

You can click a button to switch the input channel. The cursor will move according to the currently selected input port.

Button	Description
<b>Computer In1</b>	Selects input from <b>COMPUTER IN1</b> port.
<b>Computer In2</b>	Selects input from <b>COMPUTER IN2</b> port.
<b>HDMI 1</b>	Selects input from <b>HDMI 1</b> port.
<b>HDMI 2 / MHL</b>	Selects input from <b>HDMI 2 / MHL</b> port.
<b>Video</b>	Selects input from <b>VIDEO</b> port.
<b>LAN</b>	Selects input from <b>LAN</b> port.
<b>USB TYPE A</b>	Selects input from <b>USB TYPE A</b> port.
<b>USB TYPE B</b>	Selects input from <b>USB TYPE B</b> port.

**3.2 Crestron e-Control® - Main window (continued)**

3. Click a button and operate as follows. To show the hidden buttons, click the ◀ / ▶ icons at the left and right ends.

Button	Description
<b>Freeze</b>	Turns Freeze on/off.
<b>Contrast</b>	Adjusts the contrast setting.
<b>Brightness</b>	Adjusts the brightness setting.
<b>Color</b>	Adjusts the color setting.
<b>Sharpness</b>	Adjusts the sharpness setting.
<b>Magnify</b>	Controls the magnification setting using the [+] / [-] buttons. Use the [▲] [▼] [◀] [▶] buttons to move to the area you want to magnify.
<b>Auto</b>	Performs the automatic adjustment.
<b>Blank</b>	Turns the BLANK screen on/off.

4. Click the button and operate in the same way as the bundled remote control.

Button	Description
<b>Menu</b>	Assigned the same operation as <b>MENU</b> button.
<b>Enter</b>	Assigned the same operation as <b>ENTER</b> button.
<b>Reset</b>	Assigned the same operation as <b>RESET</b> button.
▲	Assigned the same operation as ▲ button.
▼	Assigned the same operation as ▼ button.
◀	Assigned the same operation as ◀ button.
▶	Assigned the same operation as ▶ button.

## 3.2 Crestron e-Control® (continued)

### 3.2.2 Tools window

Configures the settings between the projector and Crestron® control system. Click the **[Exit]** button to return to the Main window.

**NOTE**

- If two-byte characters are used, the input text or numbers cannot be set correctly.
- Any items on this window cannot be left blank.

#### 1. Crestron® Control

Configures the settings of Crestron® control system devices.

Item	Description
<b>IP Address</b>	Configures the IP address of the control system.
<b>IP ID</b>	Configures the IP ID of the control system.
<b>Port</b>	Specifies the port number used for communication by the control system.

To apply the settings, click the **[Send]** button.

#### 2. Projector

Configures the network settings of the projector.

Item	Description
<b>Projector Name</b>	Configures the name of the projector. The length of the Projector Name can be up to 64 alphanumeric characters.
<b>Location</b>	Configures the location name of the projector. You can specify a Location name up to 32 alphanumeric characters.
<b>Assigned To:</b>	Configures the user name for the projector. You can specify a user name up to 32 alphanumeric characters.

The usable symbols are space and the following:

!"#\$%&'()\*+,-./:;<=>?@[\\]^\_`{|}~

To apply the settings, click the **[Send]** button.

### 3.2 Crestron e-Control® - Tools window (continued)

#### 3. Projector

Configures the network settings of the projector.

Item	Description
<b>DHCP</b>	Enables DHCP.
<b>IP Address</b>	Configures the IP address when DHCP is disabled.
<b>Subnet Mask</b>	Configures the subnet mask when DHCP is disabled.
<b>Default Gateway</b>	Configures the default gateway when DHCP is disabled.
<b>DNS Server</b>	Configures the DNS server address when DHCP is disabled.

To apply the settings, click the **[Send]** button.

#### 4. User Password

Configures the User Password. To prompt the entry of User Password before starting e-Control®, select the checkbox.

Item	Description
<b>New Password</b>	Configures the password. You can specify a password up to 26 alphanumeric characters. The usable symbols are space and the following: !"#\$%&'()*+,-./:;<=>?@[\\]^_`{ }~
<b>Confirm</b>	Reenter the above password for verification. If the password is incorrect, an error message is displayed.

To apply the settings, click the **[Send]** button.

#### 5. Admin Password

Configures the Admin Password. To prompt the entry of Admin Password before displaying the Tools window, select the checkbox.

Item	Description
<b>New Password</b>	Configures the password. You can specify a password up to 26 alphanumeric characters. The usable symbols are space and the following: !"#\$%&'()*+,-./:;<=>?@[\\]^_`{ }~
<b>Confirm</b>	Reenter the above password for verification. If the password is incorrect, an error message is displayed.

To apply the settings, click the **[Send]** button.



## 3.2 Crestron e-Control® (continued)

### 3.2.3 Info window

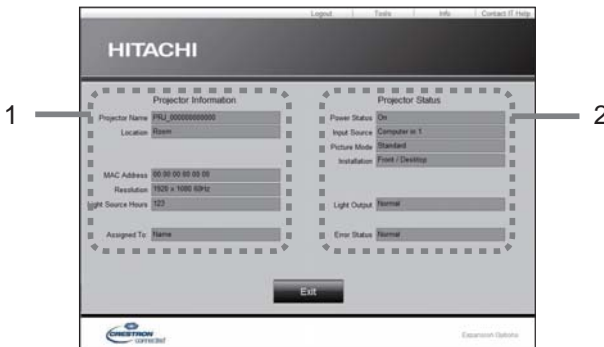

Displays the current settings and status of the projector.  
Click the **[Exit]** button to return to the Main window.

#### 1. Projector Information

Item	Description
<b>Projector Name</b>	Displays the projector name settings.
<b>Location</b>	Displays the location name of the projector.
<b>MAC Address</b>	Displays the wired LAN MAC address of the projector.
<b>Resolution</b>	Displays the resolution and vertical frequency of the signal input selected on the projector.
<b>Light Source Hours</b>	Displays the usage time for the light source.
<b>Assigned To:</b>	Displays the user name for the projector.

#### 2. Projector Status

Item	Description
<b>Power Status</b>	Displays the power status.
<b>Input Source</b>	Displays the input signal source.
<b>Picture Mode</b>	Displays the picture mode setting.
<b>Installation</b>	Displays the installation setting.
<b>Light Output</b>	Displays the light output setting.
<b>Error Status</b>	Displays the error status.

**NOTE** • Projector Name, Location and the user name for Assigned To: may appear truncated if they are too long.

### 3.2 Crestron e-Control® (continued)

#### 3.2.4 Help Desk window



Sends/receives messages to/from the administrator for Crestron RoomView® Express and Fusion RV®.

Button	Description
<b>Send</b>	Sends a message.
	Checks the received message.

## 3.2 Crestron e-Control® (continued)

### 3.2.5 Emergency Alert



When the administrator for Crestron RoomView® Express and Fusion RV® sends out an alert message, it will be displayed on the screen. You can reply to the alert message via a chat format. Input a message in the box below the alert message, and click the **[Send]** button.

**NOTE**

- For the details of Emergency Alert, refer to the manual of Crestron RoomView® Express or Fusion RV®.
- The alert message from Crestron RoomView® and Fusion RV® is displayed on the screen of the projector in the way similar to the real-time text of the Messenger function. (81) If another real-time text is displayed on the screen, it will be overwritten by the alert message. However, if the priority of the real-time text is set to high, the alert message does not appear on the screen. For the details, refer to the manual for the application of the Messenger.

## 4. Network Presentation

### 4.1 Outline

The projector can display or play back the computer screen images and audio data that are transmitted through the network. This Network Presentation feature helps you to smoothly make your presentations and conduct conferences.



To use Network Presentation, an exclusive application, "LiveViewer" is required ([📖20](#)).

For details of Network Presentation and instructions to install the "LiveViewer", refer to the manual for "LiveViewer".

**NOTE** • The use of "LiveViewer" function depends on the model you are using. If you want to use the latest "LiveViewer", please refer to the appropriate group item in the "LiveViewer" User's Manual. This model will be in the Group of H.

## 4.2 Display Mode

LiveViewer has two display modes, Single PC mode and Multi PC mode.

### 4.2.1 Single PC mode

The Single PC mode can display images in full screen from one computer to the projector/switcher via wireless LAN or wired LAN.

#### ■ Presenter Mode

In the Single PC mode, the projector can be occupied by one computer and can block access from any other computers (if Presenter Mode is set to ON in LiveViewer). While making your presentation, you don't need to worry that the image on screen will be unexpectedly switched to an image sent by another computer. Presenter Mode can be set to ON in the option menu in the LiveViewer.

### 4.2.2 Multi PC mode

The projector can display images of up to four computers connected at the same time.



### 4.3 Multi Projector Mode

In the Multi Projector/Multi Display mode, up to 12 projectors or switchers connected to projectors can connect with the computer via wireless or wired LAN simultaneously.

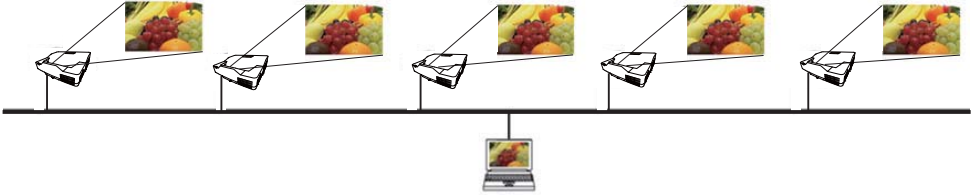

This function is for Windows users only.

### 4.4 Moderator Control Mode

One computer can be assigned as Moderator (Host) to control all other computers (Clients) or the switchers connected with the projector via wireless LAN or wired LAN. Since Clients cannot control the LiveViewer and the projector, the Host can proceed with the program as arranged smoothly and safely.

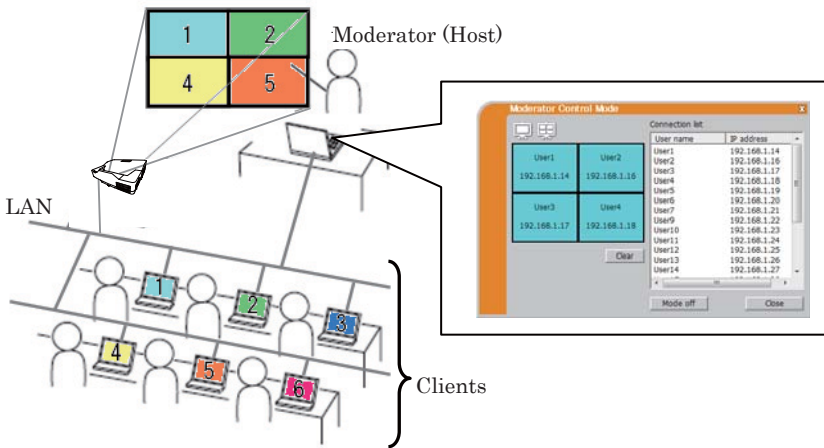

This function is for Windows users only.

## 4.5 Port Number

The port numbers used for LiveViewer are shown below.

Port No.	Protocol
5500	TCP
5900	TCP
5901	TCP
9720	TCP

### NOTE

- When other application uses the ports above, LiveViewer and Projector Quick Connection may not work.

## 5. My Image Function

The projector can display still images transferred via the network. It is possible to allocate up to 4 image files.

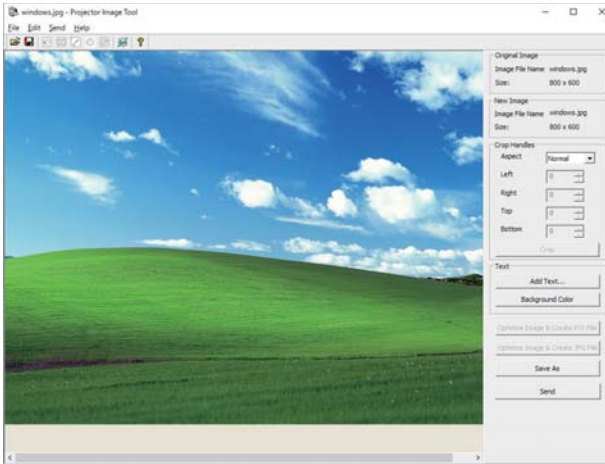

MY IMAGE transmission requires an exclusive application for your computer.  
([BOOK 20](#))

Use the application to transfer the image data.

For information on the necessary settings and operations for the computer and projector, refer to the manual for the application.

To display the transferred image, select the MY IMAGE item in the NETWORK menu. For more information, please see the description of the MY IMAGE item of the NETWORK menu.

- NOTE**
- Using MY BUTTON registered as MY IMAGE can display transferred image. ([BOOK OPTION](#) menu in the Operating Guide)
  - The image file also can be displayed by using schedule function from the web browser. ([BOOK 93](#))
  - If data is transferred via wireless and wired LAN at the same time, the projector may not be able to process the data correctly.



## 6. Messenger Function

### 6.1 Outline

The projector can display text data transferred via the network on the screen and play back audio data inside the projector.

The text data can be displayed on the screen in two ways. One is to display the text transferred from the computer on real time, and the other is to choose the text data stored in the projector and display it.

It is possible to store up to 12 text data.

Refer to the manual of Messenger tool for details.

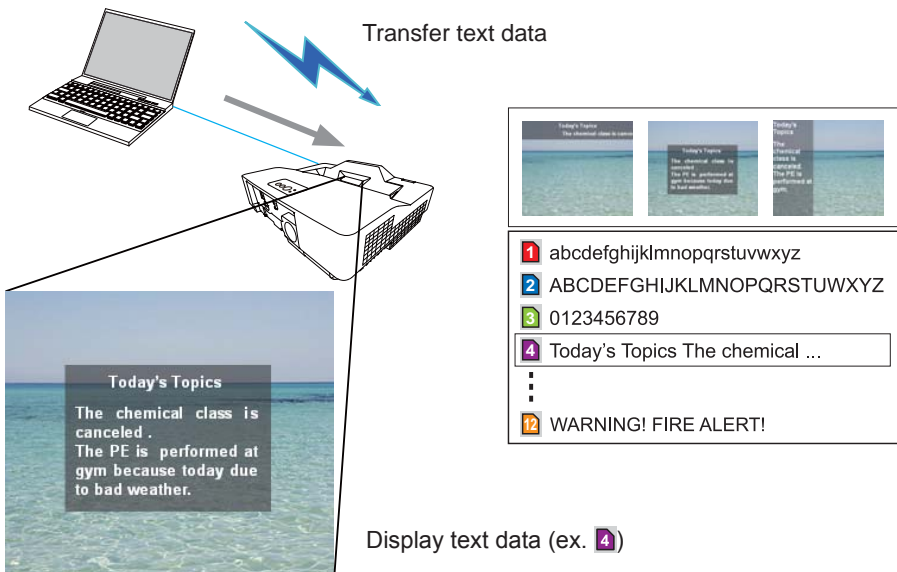

- (1) Scroll
- (2) Box (Scroll up)
- (3) Pop on
- (4) Picture Side

Messenger function requires an exclusive application for your computer. (📖 20)  
To edit, transfer and display the text data, use the application.

For information on the necessary settings and operations for the computer and projector, refer to the manual for the application.

## 6.2 Display Style

There are 4 types of message display style. The following is the description of each type.

### 1) Scroll

The message scrolls to the left in the message display area.



### 2) Box (Scroll up)

The message scrolls upwards in the square message display area.

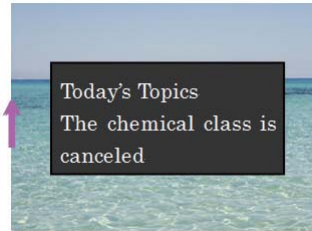

### 3) Pop on

The message is displayed in full view in the square message display area.

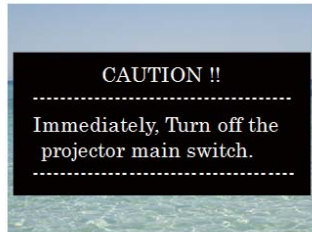

### 4) Picture Side

The message is displayed in the message display area on the right or left.  
This style is available only for WXGA model projector.

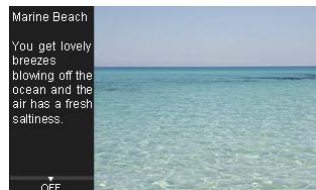

- NOTE • Using **MY BUTTON** registered as MESSENGER can turn the displaying messenger text on/off. (📖OPTION menu in the Operating Guide)
- The text file also can be displayed by using schedule function via the web browser. (📖93)
  - If data is transferred via wireless and wired LAN at the same time, the projector may not process the data correctly.

## 7. Network Bridge Function

This projector is equipped with the NETWORK BRIDGE function to perform mutual conversion of a network protocol and a serial interface.

By making use of the NETWORK BRIDGE function, a computer connected to the projector via wireless or wired LAN is able to control an external device via RS-232C communication using the projector as a network device.

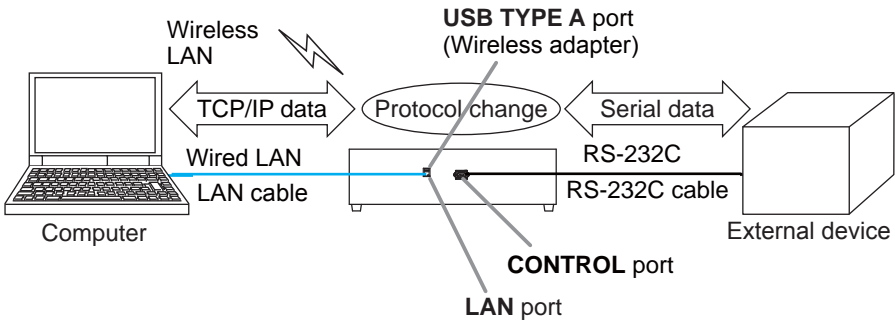

### 7.1 Connecting devices

- 1) Connect the projector's **LAN** port to the computer's LAN port with a LAN cable, or connect the wireless adapter to the **USB TYPE A** port.
- 2) Connect the projector's **CONTROL** port and the device's RS-232C port with an RS-232C cable, for RS-232C communication.

**NOTE** • Before connecting the devices, read the manuals for the devices to ensure the connection. For RS-232C connection, check the specifications of each port and use the suitable cable. (📖 Connection to the ports in the Operating Guide - Technical)

## 7.2 Communication setup

To configure the setup of the communication using NETWORK BRIDGE for the projector, use items in the COMMUNICATION menu. Open the menu of the projector and select the OPTION - SERVICE - COMMUNICATION menu. (OPTION menu > SERVICE > COMMUNICATION in the Operating Guide)

- 1) In the COMMUNICATION TYPE menu, select NETWORK BRIDGE (WIRELESS or WIRED depending on the type of connection you use) for the **CONTROL** port.
- 2) Using the SERIAL SETTINGS menu, select the proper baud rate and parity for the **CONTROL** port, according to the specification of the RS-232C port of the connected device. Default settings are as follows.

Item	Condition
BAUD RATE	19200bps
PARITY	NONE
Data length	8 bit (fixed)
Start bit	1 bit (fixed)
Stop bit	1 bit (fixed)

- 3) Using the TRANSMISSION METHOD menu, set up the proper method for the **CONTROL** port according to your use.

### NOTE

- Using the COMMUNICATION menu, set up the communication. Remember that an unsuitable setup could cause malfunction of communication.
- When either one of the NETWORK BRIDGE settings is selected in the COMMUNICATION TYPE menu, RS-232C commands cannot be received from the **CONTROL** port.

## 7.3 Communication port

For the NETWORK BRIDGE function, send the data from the computer to the projector with using the Network Bridge Port configured in the Port Settings of web browser. (48)

- NOTE • It is set to 9717 by default.

## 7.4 Transmission method

The transmission method can be selected from the menus, only when the NETWORK BRIDGE is selected for the COMMUNICATION TYPE.

( OPTION menu > SERVICE > COMMUNICATION in the Operating Guide)

HALF-DUPLEX ↔ FULL-DUPLEX

### 7.4.1 HALF-DUPLEX

This method lets the projector make two way communication, but only one direction, either transmitting or receiving data, is allowed at a time.

The method does not allow the projector to receive the data from the computer while waiting for response data from an external device. After the projector receives the response data from an external device or the response limit time is past, the projector can receive the data from the computer.

That means that the projector controls transmitting and receiving the data to synchronize the communication.

To use the HALF-DUPLEX method, set up the RESPONSE LIMIT TIME following the instructions below.

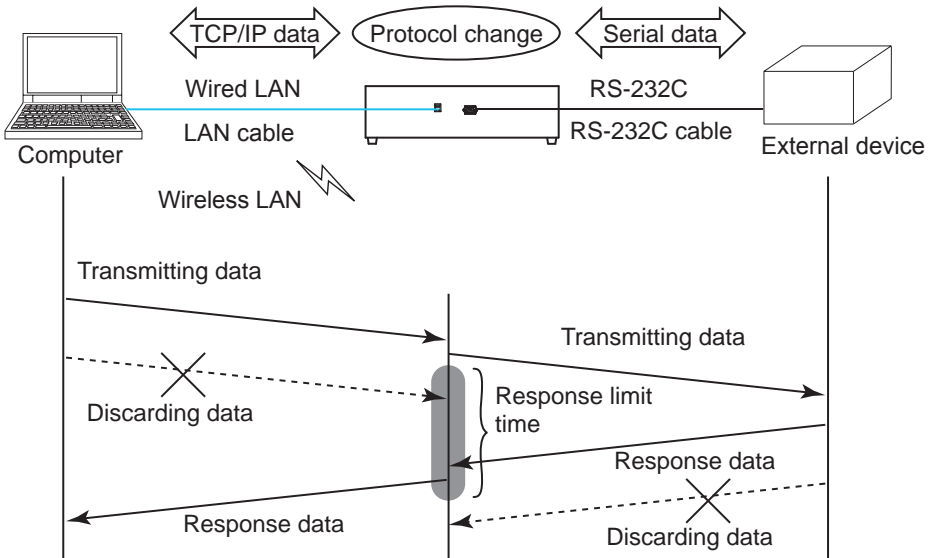

Using the RESPONSE LIMIT TIME menu, set the waiting time for response data from an external device. ( OPTION menu > SERVICE > COMMUNICATION in the Operating Guide)

OFF ↔ 1s ↔ 2s ↔ 3s (↔ OFF)

#### 7.4 Transmission method (continued)

**NOTE**

- With using the HALF-DUPLEX method, the projector can send out 254 byte data at the maximum at a time.
- If it is not required to monitor the response data from an external device and the RESPONSE LIMIT TIME is set to OFF, the projector can receive the data from the computer and send it out to an external device continuously. The OFF is selected as the default setting.

##### 7.4.2 FULL-DUPLEX

This method lets the projector make two way communication, transmitting and receiving data at the same time, without monitoring response data from an external device.

With using this method, the computer and an external device will send the data out of synchronization. If it is required to synchronize them, set the computer to make the synchronization.

**NOTE**

- When the computer controls the synchronization of receptions and transmissions, the external device may not be controlled properly depending on the status of data processing of the projector.

## 8. Other Functions

### 8.1 E-mail Alerts

The projector can automatically send an alert message to the specified e-mail addresses when the projector detects a certain condition requiring maintenance or detected an error.

**NOTE** • Up to five e-mail addresses can be specified.

- The projector may not be able to send e-mail if the projector suddenly loses power.
- Mails may not be sent correctly depending on the mail environment you are using.

Alerts available to E-mail alerts are as follows. (\*)

Item	Description
<b>Cover Error</b>	The upper case has not been properly fixed.
<b>Fan Error</b>	The cooling fan is not operating.
<b>Light Source Error</b>	The light source does not light, and there is a possibility that interior portion has become heated.
<b>Temp Error</b>	There is a possibility that the interior portion has become heated.
<b>Air Flow Error</b>	The internal temperature is rising.
<b>Cold Error</b>	There is a possibility that the interior portion has become overcooled.
<b>Filter Error</b>	Filter time over.
<b>Other Error</b>	Errors or Warnings other than the above. If this error is displayed, please contact your dealer.
<b>Schedule Execution Error</b>	Failed to execute scheduled events.
<b>Filter Time Alarm</b>	Filter Time has exceeded the specified alarm limit.
<b>Transition Detector Alarm</b>	Transition Detector Alarm. (📖 <b>SECURITY menu</b> in the <b>Operating Guide</b> )

\* Supported alerts vary depending on the model.

(continued on next page)



NOTE • The timing of receiving Filter Error e-mail is depending on the FILTER MESSAGE setting in the LIGHT & FILTER item of the SETUP menu which determines the period until the filter message is displayed on the projector screen. An e-mail will be sent when the usage time of the filter exceeds the set time limit. No notification e-mail will be sent if the FILTER MESSAGE is set to OFF. (📖SETUP menu in the Operating Guide)

- **Filter Time Alarm** is a threshold for e-mail notification of the filter time. When the Filter Time exceeds the limit configured in the Projector Web Control, an e-mail will be sent.

To use the projector's e-mail alert function, please configure the following items through a web browser.

### Mail Settings (📖 49)

- 1) Select **[Mail Settings]** on main menu in Projector Web Control.
- 2) Configure each item in Mail Settings page. Refer to item 3.1.5 Mail Settings (📖 49) for further information.
- 3) Click the **[Apply]** button to save the settings.
- 4) Click the **[Send Test Mail]** button to confirm that the e-mail settings are correct.

The following mail will be delivered to the specified addresses.

Subject line: Test Mail <Projector name>

Text : Send Test Mail

Date	<Testing date>
Time	<Testing time>
IP Address	<Projector IP address>
MAC Address	<Projector MAC address>

### Alert Settings (📖 51)

- 1) Select **[Alert Settings]** on main menu in Projector Web Control.
- 2) Select and configure each alert item. Refer to item 3.1.6 Alert Settings (📖 51) for further information.
- 3) Click the **[Apply]** button to save the settings.

Failure/Warning e-mails are formatted as follows:

Subject line: <Mail title> <Projector name>

Text : <Mail text>

Date	<Failure/Warning date>
Time	<Failure/Warning time>
IP Address	<Projector IP address>
MAC Address	<Projector MAC address>

## 8.2 Projector Management using SNMP

The SNMP (Simple Network Management Protocol) enables to manage the projector information, which is a failure or warning status, from the computer on the network.

**NOTE** • It is recommended that SNMP functions are executed by a network administrator.

- SNMP management software must be installed on the computer to monitor the projector via SNMP.

### Standard MIB (MIB-2)

You can refer to the following items defined in system group of Standard MIB (MIB-2).

Item	Description
sysName	Projector name is set.
sysLocation	The information on where it is located. It has character string set in sysLocation (SNMP) in Projector Web Control - [Network Settings] - [Common Setup].
sysContact	The information on the administrator's contact information. It has character string set in sysContact (SNMP) in Projector Web Control - [Network Settings] - [Common Setup].

### Enhanced MIB

You can get configuration information by using Enhanced MIB for projectors. Enhanced MIB for projectors can be downloaded from [Port Settings] page in Projector Web Control.

### Trap

When an error or warning occurs in the projector, a notification can be sent to the specified address.

In addition to e-mail alert shown in 8.1 E-mail Alerts ( 88), the following notification can be sent.

Item	Description
Cold Start	When the projector is supplied with the power, it works as below. <ul style="list-style-type: none"> <li>• If the STANDBY MODE is set to the QUICK START or NORMAL: the projector's power status changes from "OFF" to "Standby state".</li> <li>• If the STANDBY MODE is set to the NETWORK(WOL) or SAVING: the projector's power status changes from "Standby state" to "ON (light source is turned on)".</li> </ul> (  SETUP menu in the Operating Guide).
Authentication Failure	The SNMP access is detected from the invalid SNMP community.

Setup the following functions through WEB browser, if you want to manage the projector by SNMP.

### Port Settings (📖 48)

- 1) Select **[Port Settings]** on main menu in Projector Web Control.
- 2) Click the **[Download MIB File]** to download a MIB file.
- 3) Click the **[Enable]** check box to open the SNMP Port. Set the address to send the SNMP trap to when a Failure/Warning occurs.

### Security Settings (📖 58)

- 1) Select **[Security Settings]** on main menu in Projector Web Control.
- 2) Click the **[SNMP]** and set the community name on the displayed screen.

### Alert Settings (📖 51)

Configure the settings for Trap transmission of Failures/Warnings.

- 1) Select **[Alert Settings]** on main menu in Projector Web Control.
- 2) Select the Failure/Warning item to be configured.
- 3) Click the **[Enable]** check box to send out the SNMP trap for Failures/Warnings.  
Clear the **[Enable]** check box when SNMP trap transmission is not required.
- 4) Click the **[Apply]** button to save the settings.

**NOTE** • Register the downloaded MIB file to SNMP manager program to be used.  
• Be sure to execute Network Restart when the settings of **[Port Settings]** or **[Security Settings]** is changed.

## 8.3 Event Scheduling

The scheduling function enables to setup scheduled events including power on / power off. It enables to be “self-management” projector.

Note the following before setting the schedule.

**NOTE** • Schedule can also be set in OPTION - SCHEDULE menu of the projector. (Refer to Operating Guide – OPTION).

- A maximum of 16 programs of schedule can be set. A maximum of 20 events can be registered in 1 program.
- No events are registered in program 1 – 16 with factory default settings. The program is required to be set in advance when using the schedule function for the first time.
- The priority for scheduled events is as follows 1) specific date 2) weekly
- Up to 10 specific dates are available for scheduled events. Priority is given to those with the lower numbers when more than one event has been scheduled for the same date and time (e.g., ‘Specific date No. 1’ has priority over ‘Specific date No. 2’ and so on.
- The power on event has the lowest priority among all the events set at the same time.
- Be sure to set the date and time before enabling scheduled events. (56)
- After the projector is moved, check the date and time set for the projector before configuring the schedules.
- The internal clock’s time may not remain accurate. Using SNTP is recommended to maintain accurate time.
- Certain error state in the projector (such as temperature error, light source error) will prevent the projector from appropriate execution of scheduled functions/events.
- Events “**My Image**” and “**Messenger**” will not be executed appropriately and result in “schedule execution error” status when the light source does not light and/or data to be displayed are not stored in the projector at the time when scheduled event is executed.
- Events “**Input Source**” and “**My Image**” is not executed if security function is enabled and the projector is locked due to the function.
- If no USB memory device is inserted to the projector or no image data for display exists at the scheduled event time, a schedule execution error occurs against the scheduled Slide show event.
- When you start the Slide show, input source will be automatically switched to the **USB TYPE A** port.
- Image files stored in the root directory of the USB memory device will be displayed for the scheduled Slide show.

The procedure to set the schedule in Projector Web Control is described in the following.

Setting the program is necessary to use the schedule function. Various events such as power on/off or switching input source, and the time to execute the events are to be registered in the program. No events are registered in program 1 – 16 with factory default settings. Set the program following the steps below. In the case that the program has already been set, skip to step 6).

1) Select **[Schedule Settings]** on main menu in Projector Web Control.



2) Click the **[Program Edit]** button to display the program edit screen. Select the program you want to edit in dropdown list and click the **[Select]** button.

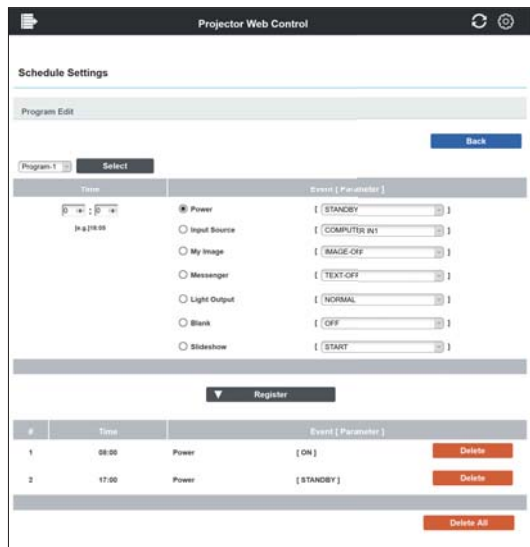

- 3) After setting the time, events and parameters, click the **[Register]** to add the new event.  
Click the **[Delete]** button when you want to delete an event.  
Click the **[Delete All]** button when you want to delete all the events in the currently selected program.
- 4) When you want to edit the program with other number continuously, select the program you want to edit in dropdown list and click the **[Select]** button.
- 5) Click the **[Back]** button to go back to schedule management screen after finishing the program setting.  
Click the **[Program List]** button to display the program list screen.  
In this screen, the event information registered in each program number can be confirmed.

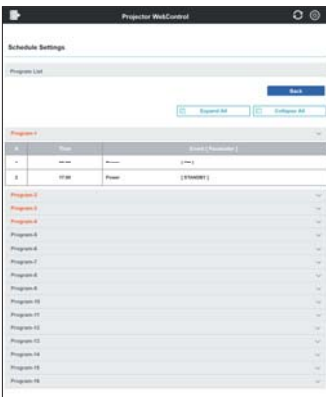

The procedure to assign the program set in the step 1) ~ 5) to the schedule is described in the following.

- 6) Click the checkbox of the schedule to be executed (e.g. Click the checkbox of "Monday", when it is to be executed on Mondays) in the schedule management screen.
- 7) Select the program to be executed in dropdown list.  
You can confirm the event information registered in each program in the program list on the bottom of the screen.  
When setting the Specific date No.1 ~ 10, enter the date (month/day).
- 8) Click the **[Apply]** button to save the schedule settings in the projector.  
Repeat step 6) ~ 8) similarly to set the schedule you want to execute.

The schedule settings are now complete.

Finally, confirm the time stored in the projector is correctly set.

### ■ How to copy the program

When you copy the currently selected program to other program, click the **[Program Copy]** button.

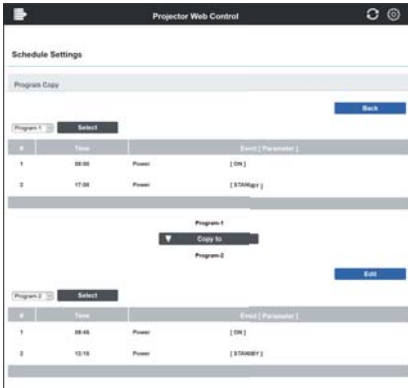

Click the **[Copy to]** button after selecting the program to which you want to copy in dropdown list.

The same program as the currently selected one cannot be specified as the program to which you want to copy.

Click the **[Edit]** button to edit the event of copied program after copying the program.



## 8.4 Command Control via the Network

You can configure and control the projector via the network using RS-232C commands.

### Communication Port

The following two ports are assigned for the command control.

TCP #23 (**Network Control Port1 (Port: 23)**)

TCP #9715 (**Network Control Port2 (Port: 9715)**)

**NOTE** • Command control is available only via the specified port above.

### Command Control Settings (48)

Configure the following items from a web browser when command control is used.

The screenshot shows the 'Projector Web Control' interface. Under 'Port Settings', there are several sections:

- Network Control Port1 (Port: 23)**: Port Open and Authentication are checked.
- Network Control Port2 (Port: 9715)**: Port Open and Authentication are checked.
- P-Link Port (Port: 4332)**: Port Open and Authentication are unchecked.
- My Image Port (Port: 9716)**: Port Open and Authentication are unchecked.
- Messenger Port (Port: 9719)**: Port Open and Authentication are unchecked.
- SNMP Port**: Port Open is unchecked. There is a 'Trap Address' field and a 'Download MB File' button.
- Network Bridge Port**: Port Number is set to 9715. There is an 'Apply' button and a 'Network Restore' button.

At the bottom, a message reads: 'To apply changes to port settings, click Apply, then perform Network Restore.'

**Example:** If the IP address of the projector is set to **192.168.1.10**:

- 1) Enter "**http://192.168.1.10/**" into the address bar of the web browser, and select Projector Web Control from the selection window.
- 2) Enter your user name and password, and then click the **[OK]**.
- 3) Click the **[Port Settings]** on the main menu.
- 4) Click the **[Enable]** check box to open **Network Control Port1 (Port: 23)** to use TCP #23. Click the **[Enable]** check box for the **[Authentication]** setting when authentication is required, otherwise clear the check box.
- 5) Click the **[Enable]** check box to open **Network Control Port2 (Port: 9715)** to use TCP #9715. Click the **[Enable]** check box for the **[Authentication]** setting when authentication is required, otherwise clear the check box.

### 8.4 Command Control via the Network (continued)

- 6) Click the **[Apply]** button to save the settings.  
When the authentication setting is enabled, the following settings are required. (📖58)
- 7) Click the **[Security Settings]** on the main menu.
- 8) Click the **[Network Control]** and enter the desired password.  
\* See NOTE.
- 9) Click the **[Apply]** button to save the settings.

**NOTE** • The Password will be the same for **Network Control Port1 (Port: 23)**, **Network Control Port2 (Port: 9715)**, **PJLink Port (Port: 4352)**, **My Image Port (Port: 9716)** and **Messenger Port (Port: 9719)**.  
• The new configuration settings are activated after restarting the network connection. When the configuration settings are changed, you must restart the network connection. You can restart the network connection from Network Restart on the main menu. (📖66)

## 8.4 Command Control via the Network (continued)

### Command Format

Command formats differ among the different communication ports.

- TCP #23

You can use the RS-232C commands without any changes. The reply data format is the same as the RS-232C commands. ([RS-232C Communication in the Operating Guide - Technical](#))

However, the following reply will be sent back in the event of authentication failure when authentication is enabled.

<Reply in the event of an authentication error>

Reply	Error code	
0x1F	0x04	0x00

- TCP #9715

#### Send Data format

The following formatting is added to the header (0 x 02), Data length (0 x 0D), Checksum (1 byte) and Connection ID (1 byte) of the RS-232C commands.

Header	Data length	RS-232C command	Check Sum	Connection ID
0x02	0x0D	13 bytes	1 byte	1 byte

- Header → 0x02, Fixed
- Data length → RS-232C commands byte length (0x0D, Fixed)
- RS-232C command → RS-232C commands that start with 0xBE 0xEF (13 bytes)
- Check Sum → This is the value to make zero on the addition of the lower 8 bits from the header to the checksum.
- Connection ID → Random value from 0 to 255 (This value is attached to the reply data)

**8.4 Command Control via the Network (continued)****Reply Data format**

The connection ID (the data is same as the connection ID data on the sending data format) is attached to the RS-232C commands reply data.

<ACK reply>

Reply	Connection ID
0x06	1 byte

<NAK reply>

Reply	Connection ID
0x15	1 byte

<Error reply>

Reply	Error code	Connection ID
0x1C	2 bytes	1 byte

<Data reply>

Reply	Data	Connection ID
0x1D	2 bytes	1 byte

<Projector busy reply>

Reply	Status code	Connection ID
0x1F	2 bytes	1 byte

<Authentication error reply>

Reply	Authentication Error code		Connection ID
0x1F	0x04	0x00	1 byte

### **8.4 Command Control via the Network (continued)**

#### Automatic Connection Break

The TCP connection will be automatically disconnected after there is no communication for 30 seconds after being established.

#### Authentication

The projector does not accept commands without authentication success when authentication is enabled. The projector uses a challenge response type authentication with an MD5 (Message Digest 5) algorithm.

When the projector is using a LAN, a random 8 bytes will be returned if authentication is enabled. Bind this received 8 bytes and the Password and digest this data with the MD5 algorithm and add this in front of the commands to send.

The following is a sample if the Password is set to “password” and the random 8 bytes are “a572f60c”.

- 1) Connect the projector.
- 2) Receive the random 8 bytes “a572f60c” from the projector.
- 3) Bind the random 8 bytes “a572f60c” and the Password “password” and it becomes “a572f60cpassword”.
- 4) Digest this bind “a572f60cpassword” with MD5 algorithm.  
It will be “e3d97429adffa11bce1f7275813d4bde”.
- 5) Add this “e3d97429adffa11bce1f7275813d4bde” in front of the commands and send the data.  
Send “e3d97429adffa11bce1f7275813d4bde”+command.
- 6) When the sending data is correct, the command will be performed and the reply data will be returned. Otherwise, an authentication error will be returned.

**NOTE** • As for the transmission of the second or subsequent commands, the authentication data can be omitted when the same connection.

## 8.5 Crestron Connected™

Crestron Connected™ is a multi-user resource management program provided by Crestron Electronics, Inc. It is an application for managing and controlling the projector and other AV devices collectively.

For the details of Crestron Connected™, refer to the Crestron® website.

URL: <http://www.crestron.com>

The following communication interfaces can be used to manage the entire facility.

- 1) Crestron Fusion RV® / Crestron RoomView® Express / Crestron RoomView® Server Edition  
Fusion RV®, RoomView® Express and RoomView® Server Edition are software provided by Crestron Electronics, Inc. They are used for managing all the AV devices, and are also able to communicate with the help desk as well as send out alert messages.

For the details of the software, refer to the following website.

URL: <http://www.crestron.com/getroomview>

- 2) Crestron e-Control®

Crestron e-Control® is a system controller that can be operated via a web browser. (📖 67)

## 9. Troubleshooting

Phenomenon: Cannot communicate with the projector. (Wired network)

Item to be checked	Solutions
Is the projector turned on?	Turn on the projector.
Is the network device such as a router, etc. turned on?	Turn on the network device.
Is STANDBY MODE set to NETWORK(WOL) or SAVING?	The network function is not available when STANDBY MODE is set to NETWORK(WOL) or SAVING. If you want to use the network function in the standby mode, set to QUICK START or NORMAL.
Is LAN cable connected?	Connect the LAN cable.
Is MAC address displayed correctly in the NETWORK INFORMATION - WIRED INFORMATION menu?	Contact your dealer when MAC address on the label put on the projector does not match MAC address displayed in the NETWORK INFORMATION - WIRED INFORMATION menu.
Are the network settings such as IP address set correctly?	Check the network settings in the NETWORK INFORMATION - WIRED INFORMATION menu. Consult with your network administrator for details.
Is firewall or packet filtering set in a router, etc.?	Consult with your network administrator.
Is the same network address set for wireless LAN and wired LAN of the projector?	The same network address cannot be used for wireless LAN and wired LAN. Set different network address for wireless LAN and wired LAN.
Is the wired network adapter of the computer enabled?	Refer to the user's manual of the computer and enable the wired network adapter.

Phenomenon: Cannot communicate with the projector. (Wireless network)

### 1. Common

Item to be checked	Solutions
Is the projector turned on?	Turn on the projector.
Is the network device such as an access point, etc. turned on?	Turn on the network device.
Is STANDBY MODE set to NETWORK(WOL) or SAVING?	The network function is not available when STANDBY MODE is set to NETWORK(WOL) or SAVING. If you want to use the network function in the standby mode, set to QUICK START or NORMAL.
Are the network settings such as IP address set correctly?	Check the network settings in the NETWORK INFORMATION - WIRELESS INFORMATION menu. Consult with your network administrator for details.
Is the USB wireless adapter (optional parts : USB-WL-5G) inserted into <b>USB TYPE A</b> port of the projector?	Insert the USB wireless adapter.
Is an optional USB wireless adapter used?	The USB wireless adapter available to this projector is optional USB-WL-5G only.
Is LED of the USB wireless adapter blinking?	When LED of the USB wireless adapter does not blink in over 1 minute after inserting, pull out and insert the USB wireless adapter again. If the problem persists, the USB wireless adapter may be broken. Contact your dealer.



Phenomenon: Cannot communicate with the projector. (Wireless network) (continued)

### 1. Common (continued)

Item to be checked	Solutions
Is an encryption method which is not supported by the projector used?	<p>The followings are encryption methods supported by the projector:</p> <ul style="list-style-type: none"> <li>•WPA2-PSK(AES)</li> <li>•WPA2-PSK(TKIP)</li> <li>•WPA-PSK(AES)</li> <li>•WPA-PSK(TKIP)</li> <li>•WEP128bit (Available only in INFRASTRUCTURE mode)</li> <li>•WEP64bit (Available only in INFRASTRUCTURE mode)</li> </ul> <p>This projector cannot be connected to the wireless network using the encryption methods other than the above.</p>
Does the radio frequency match between the device and the projector?	<p>Confirm the available frequency of the device. Change the projector setting to available frequency. It may be better by changing the channel setting.</p>
Is the wireless network adapter of the computer enabled?	<p>Refer to the user's manual of the computer and enable the wireless network adapter.</p>
Is the DHCP setting of the computer disabled?	<p>Enable the DHCP setting of the computer. Refer to the user's manual of the computer or wireless LAN device for the setting procedure of network and wireless connection of the computer.</p>

Phenomenon: Cannot communicate with the projector. (Wireless network) (continued)

### 1. Common (continued)

Item to be checked	Solutions
Does the IP address overlap with that of the other devices?	When the IP address overlaps, turn off your Wi-Fi <sup>®</sup> device and turn on again.
Is WIRELESS NETWORK set to OFF?	Set WIRELESS NETWORK to ON.
Is the wireless adapter connected to the projector?	Insert the wireless adapter to the <b>USB TYPE A</b> port of the projector.

### 2. SIMPLE ACCESS POINT

Item to be checked	Solutions
Are over 10 devices connected to the projector?	<ul style="list-style-type: none"> <li>• Confirm the number of the devices connected to the projector. Up to 10 devices can be connected to the projector in Simple Access Point mode.</li> <li>• When the projector is connected to the maximum numbers of devices, connect after disconnecting the device currently connected.</li> </ul>

Phenomenon: Cannot communicate with the projector. (Wireless network) (continued)

### 3. INFRASTRUCTURE

Item to be checked	Solutions
Is firewall or packet filtering set in an access point, etc.?	Consult with your network administrator.
Is the wireless network to connect encrypted?	Set the encryption settings of the projector again and reconnect.
Is signal strength of wireless network displayed in the SSID SCAN LIST menu weak?	<ul style="list-style-type: none"> <li>· Put the projector close to the wireless device.</li> <li>· When the projector is near the steel door, the radio wave may not reach to the wireless device. In that case, keep the projector away from the door.</li> <li>· Consult with your network administrator because there may be an interfering wireless device.</li> </ul>
Is the same network address set for wireless LAN and wired LAN of the projector?	The same network address cannot be used for wireless LAN and wired LAN. Set different network address for wireless LAN and wired LAN.

Phenomenon: Cannot use wireless LAN and wired LAN at the same time.

Item to be checked	Solutions
Is the same network address set for wireless LAN and wired LAN of the projector?	The same network address cannot be used for wireless LAN and wired LAN. Set different network address for wireless LAN and wired LAN.
Are you trying to access to different network via a router?	Either wired LAN or wireless LAN can access to different network. Set default gateway of either wired LAN or wireless LAN to 0.0.0.0.

Phenomenon: Web(Projector Web Control) is not displayed correctly.

Item to be checked	Solutions
Is the correct URL entered in Web browser?	Enter the IP address of the projector in Web browser.
Is JavaScript <sup>®</sup> enabled?	Enable JavaScript <sup>®</sup> . How to set is different depending on the Web browser. Refer to Help of Web browser, etc. for details.
Is recommended Web browser used?	Recommended Web browsers are Internet Explorer <sup>®</sup> 11 and Microsoft <sup>®</sup> Edge. Projector Web Control may not displayed correctly except in recommended browser.
Is the cache of the screen displayed earlier remaining?	Clear the cache. How to set is different depending on the Web browser. Refer to Help of Web browser, etc. for details.
Is Cookie in your browser disabled?	When Cookie is disabled, the mobile screen cannot be displayed. Enable Cookie setting of your browser.

Phenomenon: Crestron e-Control<sup>®</sup> is not displayed.

Item to be checked	Solutions
Has Adobe <sup>®</sup> Flash <sup>®</sup> Player been installed?	Adobe <sup>®</sup> Flash <sup>®</sup> Player is required to display Crestron e-Control <sup>®</sup> . Install Adobe <sup>®</sup> Flash <sup>®</sup> Player.
Is Web browser that does not support Adobe <sup>®</sup> Flash <sup>®</sup> Player used?	Use a Web browser that supports Adobe <sup>®</sup> Flash <sup>®</sup> Player.
Are Crestron e-Control <sup>®</sup> settings on Network Settings - Other Setup screen of the Projector Web Control disabled?	Enable Crestron e-Control <sup>®</sup> settings on Network Settings - Other Setup screen of the Projector Web Control.
Is Crestron in Projector Web Control - Network Settings - Common Setup set to OFF?	Set Crestron in Projector Web Control - Network Settings - Common Setup to ON.

Phenomenon: Cannot send an e-mail correctly.

Item to be checked	Solutions
Are e-mail settings correct?	Check the settings on the Mail Settings screen of the Projector Web Control.
Are the settings of Sender e-mail Address correct?	Set valid e-mail address.
Is a test e-mail sent correctly?	Check if a test e-mail is sent correctly by pressing the [Send Test Mail] button on the Mail Settings screen of the Projector Web Control.
Is only e-mail regarding the specific Error/Warning not sent correctly?	Check if the specific Error/Warning is set to be sent on the Mail Settings screen of the Projector Web Control.

Phenomenon: An e-mail does not reach only to the specific address.

Item to be checked	Solutions
Is e-mail address set correctly?	Check the settings on the Mail Settings screen of the Projector Web Control.
Is filtering or forwarding set for the e-mail address in the mail server?	Consult with your network administrator.

Phenomenon: The schedule is not executed correctly.

Item to be checked	Solutions
Is the projector turned on?	Turn on the projector.
Is STANDBY MODE set to NETWORK(WOL) or SAVING?	The schedule function is not available when STANDBY MODE is set to NETWORK(WOL) or SAVING. If you want to use the schedule function in the standby mode, set to QUICK START or NORMAL.
Is the time set correctly?	Check the settings of Date and Time.
Is the image data to be displayed in the schedule function registered? (When the event of My Image is set.)	Register the image data to be displayed with the projector by using exclusive application software.
Is the message data to be displayed in the schedule function registered? (When the event of Messenger is set.)	Register the message data to be displayed with the projector by using exclusive application software.
Is the light source of the projector lighting?	The event of My Image, Messenger and Blank are not executed when the light source is not lighting. Set the program of the schedule function so that the event of MyImage, Messenger and Blank can be executed when the light source is lighting.
Is the program to be executed set correctly?	Check the settings of Schedule Settings of the Projector Web Control.
Are there any events set at the same time?	Some events cannot be executed at the same time. Set them to be executed at the different time or change the order.

\* The schedule function may not operate correctly depending on the status of the projector.

Phenomenon: The time settings are not correct.

Item to be checked	Solutions
Is battery set?	Set the battery. The battery is considered to be exhausted if the time is off soon after setting date and time. In that case, replace the battery.
Is the date and time set correctly?	Check the settings of Date/Time Settings menu of the Projector Web Control or DATE AND TIME menu of the projector.
Is the projector connected to the network correctly when getting the time via the network?	Connect to the network.
Is SNTP server set correctly when getting the time via the network?	Check the settings of SNTP server. Consult with your network administrator regarding the settings of SNTP server.
Is the time difference set correctly when getting the time via the network?	When getting the time via the network, the correct time is not displayed if the time difference is not set. Set the time difference.

Phenomenon: Cannot control the external device by using Network Bridge.

Item to be checked	Solutions
Is Network Bridge settings enabled?	Check the settings in OPTION - SERVICE - COMMUNICATION - COMMUNICATION TYPE menu.
Is STANDBY MODE set to NETWORK(WOL) or SAVING?	The Network Bridge is not available when STANDBY MODE is set to NETWORK(WOL) or SAVING. Set STANDBY MODE to QUICK START or NORMAL, and set NETWORK BRIDGE (WIRELESS/WIRED) in the COMMUNICATION TYPE menu.
Are the serial settings set correctly?	Check the serial settings of the projector and the external device.

## 10. Warranty and after-sales service

If an abnormal operation (such as smoke, strange odor or excessive sound) should occur, stop using the projector immediately.

If this does not resolve the problem, please consult your dealer or service company. They will tell you what warranty condition is applied.

Please check the following web address where you may find the latest information for this projector.

**DUKANE CORP AV SERVICE DEPT**  
2900 Dukane Drive  
St Charles, IL 60174  
800-676-2487 / 630-762-  
Fax 630-584-5156  
avservice@dukane.com  
www.dukaneav.com

### Trademark acknowledgment

- Microsoft® and Internet Explorer®, Windows® are registered trademark of Microsoft Corporation in the U.S. and/or other countries.
  - Mac®, Mac OS® and OS X® are registered trademarks of Apple Inc. in the U.S. and/or other countries.
  - Adobe® and Flash® are registered trademarks of Adobe Systems Incorporated.
  - Oracle and Java are registered trademarks of Oracle and/or its affiliates.
  - HDMI™, the HDMI logo and High-Definition Multimedia Interface are trademarks or registered trademarks of HDMI Licensing LLC in the United States and other countries.
  - Crestron®, Crestron e-Control®, e-Control®, Crestron Connected™, Fusion RV®, Crestron RoomView® and RoomView™ are trademarks or registered trademarks of Crestron Electronics, Inc. in the United States and other countries.
  - Trademark PJLink is a trademark applied for trademark rights in Japan, the United States of America and other countries and areas.
  - MHL®, the MHL logo, and Mobile High-Definition Link are trademarks or registered trademarks of MHL, LLC in the United States and other countries.
  - Wi-Fi® is registered trademarks of Wi-Fi Alliance®.
- Other names may be trademarks of their respective owners.

