

LCD Projector

8133WISS/8142WISS

DUKANE

User's Manual (detailed)
Operating Guide

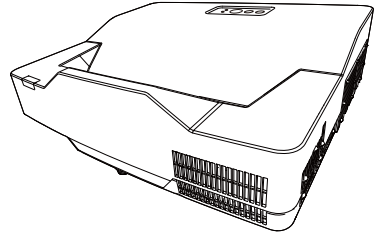

Thank you for purchasing this projector.

⚠ WARNING ▶ Before using this product, please read all manuals for this product. Be sure to read “**Safety Guide**” first. After reading them, store them in a safe place for future reference.

About this manual

Various symbols are used in this manual. The meanings of these symbols are described below.

⚠ WARNING This symbol indicates information that, if ignored, could possibly result in personal injury or even death due to incorrect handling.

⚠ CAUTION This symbol indicates information that, if ignored, could possibly result in personal injury or physical damage due to incorrect handling.

NOTICE This entry notices of fear of causing trouble.



Please refer to the pages written following this symbol.

NOTE

- The information in this manual is subject to change without notice.
- The illustrations in this manual are for illustrative purposes. They may differ slightly from your projector.
- The manufacturer assumes no responsibility for any errors that may appear in this manual.
- The reproduction, transfer or copy of all or any part of this document is not permitted without express written consent.

Contents



Introduction	3	SETUP menu	55
Features	3	D-ZOOM, D-SHIFT, PICTURE POSITION,	
Checking the contents of package	3	GEOMETRY CORRECTION, SETUP MEMORY,	
Part names	4	LIGHT & FILTER, INSTALLATION, STANDBY MODE,	
Setting up	8	OSD MESSAGE, STANDBY OUTPUT	
Arrangement	8	AUDIO menu	63
Connecting with your devices	11	VOLUME, SPEAKER, AUDIO SOURCE	
Fastening the adapter cover	18	SCREEN menu	64
Connecting to a power supply	19	LANGUAGE, MENU POSITION, BLANK,	
Using the security bar and slot	20	AUTO BLANK, START UP, MyScreen,	
Remote control	21	MyScreen Lock, SOURCE NAME, TEMPLATE,	
Interactive pen	24	C.C.	
Power on/off	25	OPTION menu	69
Operating	27	SEARCH SKIP, AUTO SEARCH,	
Adjusting the volume	27	DIRECT POWER ON, AUTO POWER ON,	
Temporarily muting the sound	27	AUTO POWER OFF, MY BUTTON, SCHEDULE,	
Selecting an input signal	28	SERVICE	
Selecting an aspect ratio	28	NETWORK menu	84
Calibration	29	SECURITY menu	85
Adjusting the projector's elevator	30	SECURITY PASSWORD CHANGE,	
Adjusting the zoom and focus	30	MyScreen PASSWORD, PIN LOCK,	
Using the automatic adjustment feature	31	TRANSITION DETECTOR, MY TEXT PASSWORD,	
Correcting the distortions	32	MY TEXT DISPLAY, MY TEXT WRITING,	
Limiting OSD display	34	CLONING LOCK	
Using the magnify feature	35	Presentation tools	91
Temporarily freezing the screen	36	Interactive function	91
Temporarily blanking the screen	36	PC-LESS Presentation	118
Using the menu function	37	USB Display (Windows® computer)	127
EASY MENU	39	Maintenance	131
IWB CALIBRATE, ASPECT, D-ZOOM, KEYSTONE,		Cleaning and replacing the air filter	131
PERFECT FIT, PICTURE MODE, LIGHT OUTPUT,		Replacing the internal clock battery	133
INSTALLATION, RESET, FILTER TIME, LANGUAGE,		Caring for the projection	
ADVANCED MENU, EXIT		window and camera lens	134
IWB menu	42	Other care	135
PICTURE menu	43	Troubleshooting	136
BRIGHTNESS, CONTRAST, COLOR, TINT,		Related messages	136
SHARPNESS, PICTURE QUALITY, DYNAMIC BLACK,		Regarding the indicator lamps	138
MY MEMORY		Resetting all settings	141
IMAGE menu	47	Phenomena that may be easy to	
ASPECT, OVER SCAN, V POSITION, H POSITION,		be mistaken for machine defects	141
H PHASE, H SIZE, AUTO ADJUST EXECUTE		Specifications	153
INPUT menu	50		
PROGRESSIVE, VIDEO NR, COLOR SPACE,			
VIDEO FORMAT, DIGITAL RANGE, COMPUTER IN,			
FRAME LOCK, RESOLUTION, MHL STANDBY PWR.			

Introduction

Features

The projector provides you with the broad use by the following features.

- ✓ The unique optics system produces a large projected image in a short distance, which provides you with various ways of use.
- ✓ This projector has a variety of I/O ports that supposedly cover for any business scene.
- ✓ The **HDMI** port can support various image equipment which have digital interface to get clearer pictures on a screen.
- ✓ Has an HDCR and an ACCENTUALIZER features which are original image stabilizer for a clearer image.
- ✓ Has a DICOM® ("Digital Imaging and Communication in Medicine") simulation mode. This mode simulates the DICOM standard, which is a standard applicable to digital communications in medicine.
- ✓ This projector can be controlled and monitored via LAN connection. Furthermore, you can use the designated USB wireless adapter (optional) to establish wireless LAN connection.
- ✓ The built-in 16W speaker can deliver sufficient sound volume in a large space like a classroom without external speakers.
- ✓ This projector's network supports the PJLink™ standard. PJLink™ is a unified standard for operating and controlling data projectors. For specifications of PJLink™, see the web site of the PJLink™.
- ✓ The Interactive Pen included with the projector allows you to write or draw directly on the projected image. Also, you can control the connected computer on the screen in the same way as using a mouse.

Checking the contents of package

Please see the **Contents of package** section in the **User's Manual (concise)** which is a book. Your projector should come with the items shown there. Contact your dealer immediately if any items are missing.

NOTE • Keep the original packing materials, for future reshipment. Be sure to use the original packing materials when moving the projector. Use special caution for the lens.

Note: The Dukane models described in this document are manufactured by Hitachi and uses the same firmware, software programs, control code, and accessory parts. The equivalent Dukane to Hitachi models are 8133WISS (LP-TW3001) and 8142WISS (LP-TW4001).

Part names

Projector

- (1) Control panel (📖 5)
- (2) Elevator feet (x 3) (📖 30)
- (3) Remote sensor (📖 22)
- (4) Projection window (📖 134)
- (5) Intake vents
- (6) Filter cover (📖 137)
The air filter and intake vent are inside.
- (7) Speaker (📖 14, 27, 63)
- (8) Exhaust vent
- (9) **AC** (AC inlet) (📖 19)
- (10) Ports (📖 5)
- (11) Security bar (📖 20)
- (12) Security slot (📖 20)
- (13) Spacer (x 2) (📖 30)
- (14) Battery cover (📖 133)
- (15) Camera lens (📖 134)

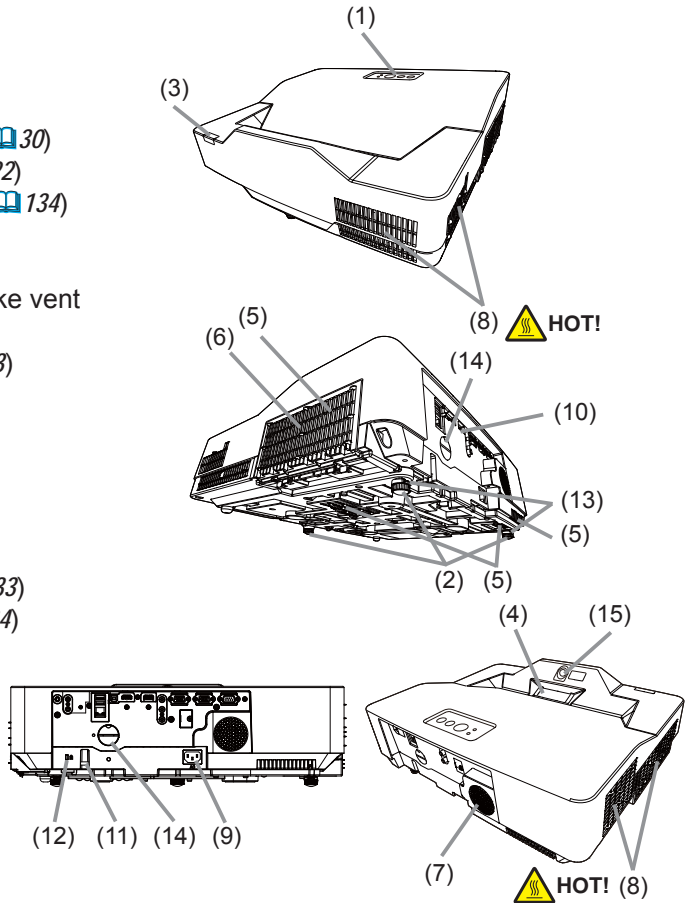

- ⚠ **WARNING** ▶ **HOT!** : Do not touch around the exhaust vents during use or just after use, since it is too hot.
- ▶ Never look into the projection window while the projection light source is on, since the projection ray may cause a trouble on your eyes.
 - ▶ Do not use the security bar and slot to prevent the projector from falling down, since it is not designed for it.
- ⚠ **CAUTION** ▶ Maintain normal ventilation to prevent the projector from heating up. Do not cover, block or plug up the vents. Do not place anything that can stick or be sucked to the vents, around the intake vents. Clean the air filter periodically.

Part names (continued)

Control panel

- (1) **STANDBY/ON** button (📖25)
- (2) **INPUT** button (📖28)
- (3) **POWER/STATUS1** indicator (📖25, 138)
- (4) **STATUS2** indicator (📖138)

Buttons ◀/▶/▲/▼

- (5) **FOCUS +/-** buttons

when no menu is displayed (📖31), or

Cursor ◀/▶ buttons

when a menu is displayed (📖37). FOCUS +/- function is invalid when the **USB TYPE A** port is selected as the input source.

- (6) **MENU** buttons

when no menu is displayed (📖37), or Cursor ▲/▼ buttons

when a menu is displayed (📖37).

The ◀/▶/▲/▼ buttons on the projector work only as the cursor buttons while the template is displayed (📖67).

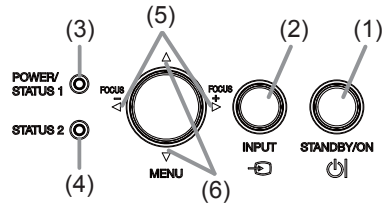

Ports (📖11 ~ 16)

- (1) **USB TYPE A** port (x2)
- (2) **LAN** port
- (3) **USB TYPE B** port
- (4) **HDMI 1** port
- (5) **HDMI 2 / MHL** port
- (6) **AUDIO IN1** port
- (7) **AUDIO IN2** port
- (8) **AUDIO IN3(L,R)** ports
- (9) **AUDIO OUT** port
- (10) **COMPUTER IN1** port
- (11) **COMPUTER IN2 / MONITOR OUT** port
- (12) **VIDEO** port
- (13) **CONTROL** port
- (14) **FINGER TOUCH** port *

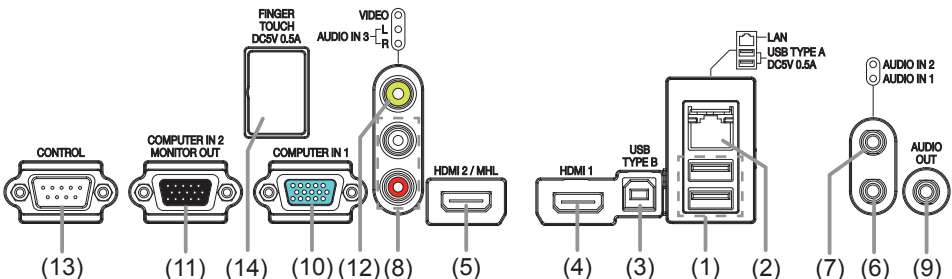

NOTE * FINGER TOUCH port is a port used only when using the optional part (FT-01B). A cover is attached for protecting the port. Do not remove the cover. Refer to the manual of the optional part (FT-01B) for detail.

Part names (continued)

Remote control

- (1) **INPUT** button (📖 28)
- (2) **MY BUTTON-1** button (📖 72, 73)
- (3) **MY BUTTON-2** button (📖 72, 73)
- (4) **STANDBY/ON** button (📖 25)
- (5) **ASPECT** button (📖 28)
- (6) **PhyP** *
- (7) **AUTO** button (📖 31)
- (8) **FREEZE** button (📖 36)
- (9) **MAGNIFY ON** button (📖 35)
- (10) **FOCUS +** button (📖 31)
- (11) **ZOOM +** button (📖 30)
- (12) **VOLUME +** button (📖 27)
- (13) **MAGNIFY OFF** button (📖 35)
- (14) **FOCUS -** button (📖 31)
- (15) **ZOOM -** button (📖 30)
- (16) **VOLUME -** button (📖 27)
- (17) **PAGE UP** button (📖 23)
- (18) **GEOMETRY** button (📖 32)
- (19) **PICTURE** button
- (20) **MUTE** button (📖 27)
- (21) **PAGE DOWN** button (📖 23)
- (22) **INTERACTIVE** button (📖 29)
- (23) **NETWORK** button
- (24) **BLANK** button (📖 36)
- (25) **ESC** button (📖 37)
- (26) **MENU** button (📖 37)
- (27) **ENTER** button (📖 37)
- (28) **OSD MSG** button (📖 34)
- (29) **RESET** button (📖 37)
- (30) **▲/▼/◀/▶** cursor buttons (📖 37)
- (31) Battery cover (📖 21)

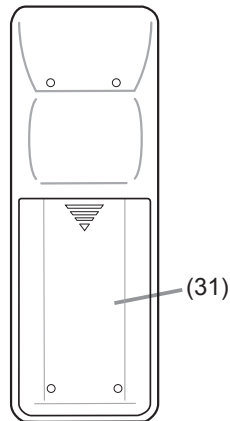
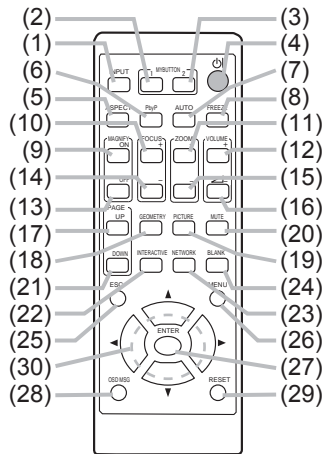

Back of
the remote control

NOTE • Any button marked with “*” is not supported on this projector (📖 137).

Part names (continued)

Interactive pen

(1) **Pen tip** (📖24)

(2) **Battery cover** (📖24)

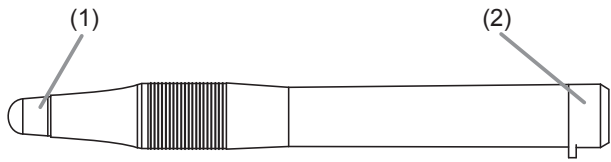

NOTE • Interactive Pen is henceforth denoted as "pen".

Setting up

Install the projector according to the environment and manner the projector will be used in.

Arrangement

Refer to table **T-1** and figures **F-1** and **F-2** at the end of User's Manual (concise) to determine the screen size and projection distance.

The values shown in the table are calculated for a full size screen.

Ⓐ Screen size (diagonal) ⓑ1, ⓑ2 Projection distance ($\pm 8\%$) ⓒ1, ⓒ2 Screen height ($\pm 8\%$)

- For the case of installation in special conditions such as on the wall or ceiling, the specified mounting accessories and service may be required. If you install the projector vertically on a table or desk, be sure to use the designated optional accessories. Before installing the projector, consult your dealer about your installation.
- The screen position may shift after installation if the projector is mounted on locations such as the wall or ceiling, due to the flexibility of the plastic projector body. If readjustment is necessary, consult with your dealer or service personnel.
- The projected image position and/or focus may change during warm-up (approx. 30 minutes after the light source is turned on) or when the ambient conditions change. Readjust the image position and/or focus as necessary.
- Since the projector features an ultra short throw, be aware that it is required to select a screen carefully to have better performance.
 - A soft screen such as a pull-down screen may cause serious distortion of a projected image. A hard screen such as a board screen is recommended for use with this projector.
 - A high-gain screen such as a bead screen that has narrow viewing angle is not suitable for this projector. A low-gain screen (around 1.0) such as a matte screen that has wide viewing angle is recommended for use with this projector.
 - A screen with a weave pattern may cause moire on the projected image, which is not a failure of the projector. A screen that has less moire effects is recommended for use with this projector.

⚠ WARNING ► Place the projector in a stable horizontal position. If the projector falls or is knocked over, it could cause injury and/or damage to the projector. Using a damaged projector could then result in fire and/or electric shock.

- Do not place the projector on an unstable, slanted or vibrational surface such as a wobbly or inclined stand.
- Do not place the projector on its side or front position. If you install the projector vertically on a table or desk, be sure to use the designated optional accessories. Consult with your dealer.
- Consult with your dealer before a special installation such as on the wall or ceiling.

(continued on next page)

Arrangement (continued)

△WARNING ► Place the projector in a cool place, and ensure that there is sufficient ventilation. The high temperature of the projector could cause fire, burns and/or malfunction of the projector.

- Do not stop-up, block or otherwise cover the projector's vents.
- Keep a space of 50 cm or more between the sides of the projector and other objects such as walls.
- Do not place or attach anything that would block the projection window, camera lens or vent holes.
- Do not place the projector on metallic thing or anything weak in heat.
- Do not place the projector on carpet, cushions or bedding.
- Do not place the projector in direct sunlight or near hot objects such as heaters. Do not place the projector where the air from an air conditioner or similar unit will blow on it directly.
- Do not place anything near the projection window or vents, or on top of the projector. It causes high temperature and could result in fire or smoke.
 - Do not put anything such as a remote control on the projection window.
 - Do not put anything on the projector. It slips down and blocks the projection window.
- Do not place anything that may be sucked into or stick to the vents on the bottom of the projector. This projector has some intake vents also on the bottom.
- Do not place the projector anywhere where it may get wet. Getting the projector wet or inserting liquid into the projector could cause fire, electric shock and/or malfunction of the projector.
- Do not place the projector in a bathroom or the outdoors.
- Do not place anything containing liquid near the projector.
- Do not place the projector where any oils, such as cooking or machine oil, are used. Oil may harm the product, resulting in malfunction, or falling from the mounted position. Do not use adhesive such as threadlocker, lubricant and so on.
- Use only the mounting accessories the manufacturer specified, and leave installing and removing the projector with the mounting accessories to the service personnel.
- Read and keep the user's manual of the mounting accessories used.

(continued on next page)

Arrangement (continued)

⚠ CAUTION ▶ Avoid placing the projector in smoky, humid or dusty place. Placing the projector in such places could cause fire, electric shock and/or malfunction of the projector.

- Do not place the projector near humidifiers, smoking spaces or a kitchen. Also do not use an ultrasonic humidifier near the projector. Otherwise chlorine and minerals contained in tap water are atomized and could be deposited in the projector causing image degradation or other problems.
- ▶ Position the projector to prevent light from directly hitting the projector's remote sensor.
- ▶ Do not place the product in a place where radio interference may be caused.
- ▶ Do not place this product in a magnetic field.
- ▶ Do not touch the camera lens with your fingers.

NOTE • The incoming light to the screen from the projector has a large angle. While the white image is on the screen, you may see it with colors, but this is because of the type of the screen used or the angles viewed, and it is not a malfunction.

- When the ambient temperature is around 35 to 40°C, the brightness of light source is reduced automatically.
- Installation position, picture mode, altitude, and operating environment may affect the brightness of the display.

Connecting with your devices

Before connecting the projector to a device, consult the manual of the device to confirm that the device is suitable for connecting with this projector and prepare the required accessories, such as a cable in accord with the signal of the device. Consult your dealer when the required accessory did not come with the product or the accessory is damaged.

After making sure that the device and projector are turned off, connect them following the instructions below.

△WARNING ► Use only the appropriate accessories. Otherwise it could cause a fire or damage to the device and the projector.

- Use only the accessories specified or recommended by the projector's manufacturer. Consult your dealer when the required accessory did not come with the product or the accessory is damaged. It may be regulated under some standard.
- For a cable with a core at only one end, connect the end with the core to the projector. That may be required by EMI regulations.
- Neither disassemble nor modify the projector and the accessories.
- Do not use the damaged accessory. Be careful not to damage the accessories. Route a cable so that it is neither stepped on nor pinched out.

△CAUTION ► Do not turn on or off the projector while connected to a device in operation, unless that is directed in the manual of the device. Otherwise it may cause malfunction in the device or projector.

- Be careful not to mistakenly connect a connector to a wrong port. Otherwise it may cause malfunction in the device or projector.
- When connecting a connector to a port, make sure that the shape of the connector fits the port.
- Tighten the screws to connect a connector equipped with screws to a port.
- Use the cables with straight plugs, not L-shaped ones, as the input ports of the projector are recessed.

(continued on next page)

Connecting with your devices (continued)

About Plug-and-Play capability

- Plug-and-Play is a system composed of a computer, its operating system and peripheral equipment (i.e. display devices). This projector is VESA DDC 2B compatible. Plug-and-Play can be used by connecting this projector to a computer that is VESA DDC (display data channel) compatible.
 - Take advantage of this feature by connecting a computer cable to the **COMPUTER IN1** port (DDC 2B compatible). Plug-and-Play may not work properly if any other type of connection is attempted.
 - Please use the standard drivers in your computer as this projector is a Plug-and-Play monitor.

- When AUTO is selected for the **COMPUTER IN1** or **COMPUTER IN2** port in COMPUTER IN of the INPUT menu, that port will accept component video signals (52).
- When the **USB TYPE B** port and the computer's USB type A port are connected, you can use the **USB TYPE B** port as a picture input port from the computer, use the remote control as a simple mouse and keyboard of the computer, or use the Interactive Function (23).

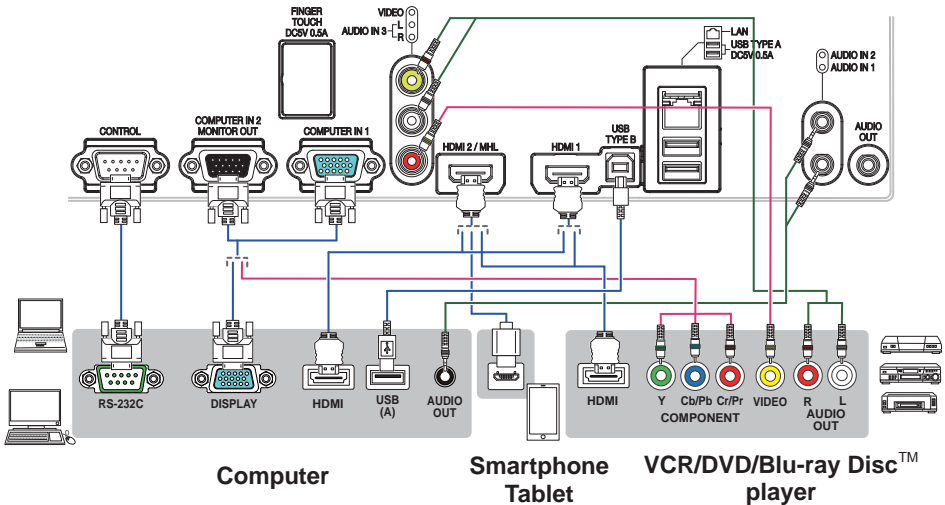

(continued on next page)

Connecting with your devices (continued)

NOTE • Before connecting the projector to a computer, consult the computer's manual and check the compatibility of the signal level, the synchronization methods and the display resolution output to the projector.

- Some signal may need an adapter to input this projector.
- Some computers have multiple screen display modes that may include some signals which are not supported by this projector.
- Although the projector can display signals with resolution up to UXGA (1600X1200), the signal will be converted to the projector's panel resolution before being displayed. The best display performance will be achieved if the resolutions of the input signal and the projector panel are identical.
- If you connect this projector and a notebook computer, you need output the display to an external monitor, or output simultaneously to the internal display and an external monitor. Consult the computer's manual for the setting.
- Depending on the input signal, the automatic adjustment function of this projector may take some time and not function correctly.
- Note that a composite sync signal or sync-on-green signal may confuse the automatic adjustment function of this projector ( 52).
- If the automatic adjustment function does not work correctly, you may not see the dialog to set the display resolution. In such a case, use an external display device. You may be able to see the dialog and set an appropriate display resolution.
- The **HDMI** port of this model is compatible with HDCP (High-bandwidth Digital Content Protection) and therefore capable of displaying a video signal from HDCP compatible DVD players or the like.
- The **HDMI** supports the following signals.
Video signal : 480i@60, 480p@60, 576i@50, 576p@50, 720p@50/60, 1080i@50/60, 1080p@50/60
Audio signal : Format Linear PCM
Sampling frequency 48kHz / 44.1kHz / 32kHz
- This projector can be connected with another equipment that has HDMI™ connector, but with some equipment the projector may not work properly, something like no video.
- Be sure to use an HDMI™ cable that has the HDMI™ logo.
- Use a Category 2-certified HDMI™ cable to input 1080p@50/60 signal to the projector.
- When the projector is connected with a device having DVI connector, use a DVI to HDMI™ cable to connect with the **HDMI** input.

(continued on next page)

Connecting with your devices (continued)

NOTE

- The MHL supports the following signals. For Video signals, refer to User's Manual (detailed) Operating Guide –Technical.
- Audio signal : Format Linear PCM
Sampling frequency 48kHz / 44.1kHz / 32kHz
- Be sure to use an MHL® cable that has the MHL logo.

- If you insert a USB storage device, such as a USB memory, into the **USB TYPE A** port and select the port as the input source, you can view images stored in the device ( 118).

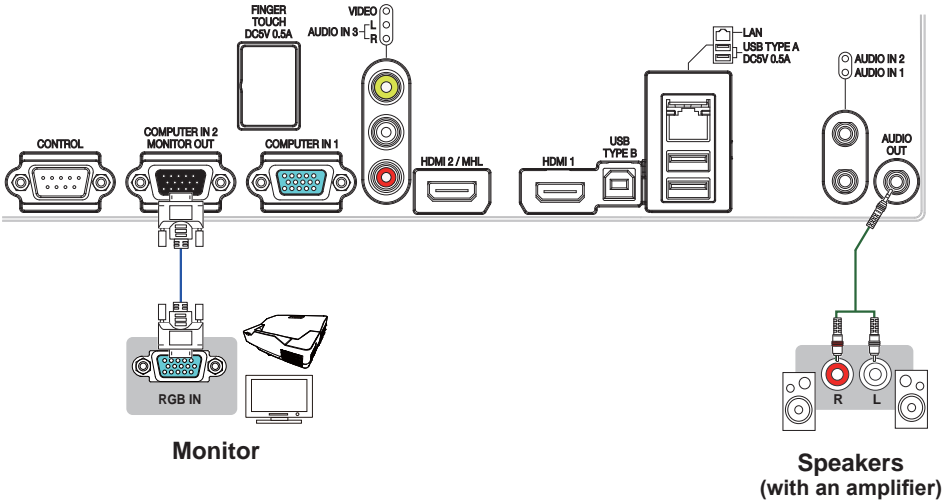

(continued on next page)

Connecting with your devices (continued)

To use network functions of the projector, connect the **LAN** port with the computer's LAN port, or with an access point that is connected to the computer with wireless LAN, using a LAN cable. To use NETWORK BRIDGE function, also connect the **CONTROL** port and an RS-232C port of the external device to communicate as a network terminal. See the **User's Manual - Network Guide** for details of the network functions.

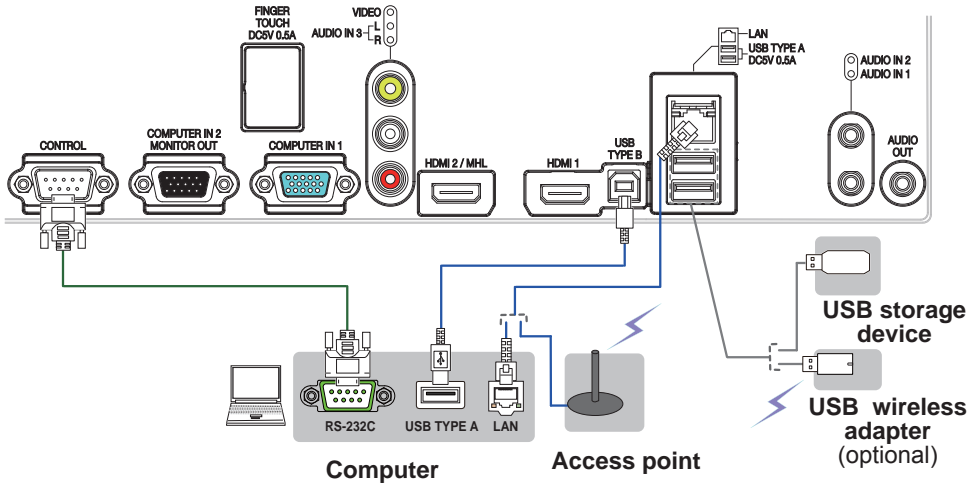

⚠ CAUTION ▶ Before connecting the projector to a network system, be sure to obtain the consent of the administrator of the network.

▶ Do not connect the **LAN** port to any network that might have the excessive voltage.

▶ The designated USB wireless adapter that is sold as an option is required to use the wireless network function of this projector.

▶ Before removing the USB storage device from the port of the projector, be sure to use the REMOVE USB function on the thumbnail screen to secure your data (127).

▶ Do not use any extension cable or device when connecting the adapter to the projector. Before you insert or pull out the USB wireless adapter from the projector, turn off the power of the projector and pull out the power cord's plug from the outlet. Do not touch the USB wireless adapter while the projector is receiving AC power.

▶ To connect both the LAN cable and USB device to the projector, use a LAN cable that is flat on the side where the plug's wire is visible. Otherwise, both of them cannot be connected correctly, or the wire may break (malfunction).

(continued on next page)

Connecting with your devices (continued)

- NOTE
- If an oversized USB storage device blocks the **LAN** port, use a USB extension cable to connect the USB storage device.
 - One USB wireless adapter (optional) can be connected to a projector.

Connecting with your devices (continued)**Fastening the cable**

Use the supplied cable tie to fasten the cables.

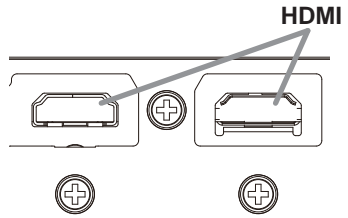

Remove the screw located on the lower side of **HDMI** connector and use it to attach the HDMI cable holder.

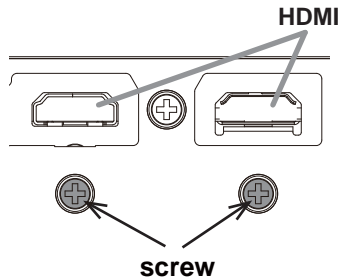

It is recommended to fasten the HDMI cables by using the HDMI cable holder and the Cable tie to prevent them from coming off. Use a Cable tie with the size of 2.0 x 4.0mm or smaller.

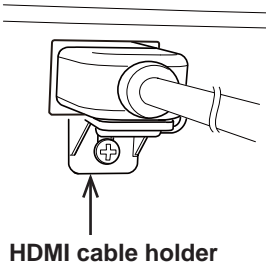
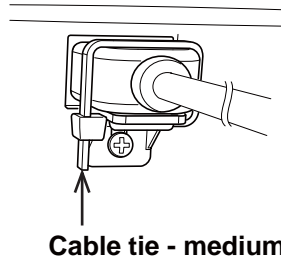
No cable tie**With cable tie**

⚠ WARNING ▶ Do not fasten the cables other than HDMI.

⚠ CAUTION ▶ To fasten the cable, use a supplied Cable tie or plastic tie with the size of 2.0 x 4.0mm or smaller. A metallic tie may cause damage to the cables and tie holder.

▶ Do not bind the cables too tightly. The cables or the hole might be damaged.

Connecting with your devices (continued)

Ferrite core for MHL cable

When connecting a MHL cable to this projector, attach the ferrite core that is supplied with the projector to the MHL cable. Refer to the following figure to attach the core to the cable nearby one end of the cable firmly, and secure it using the cable tie. Be sure to connect the end of the cable to the projector.

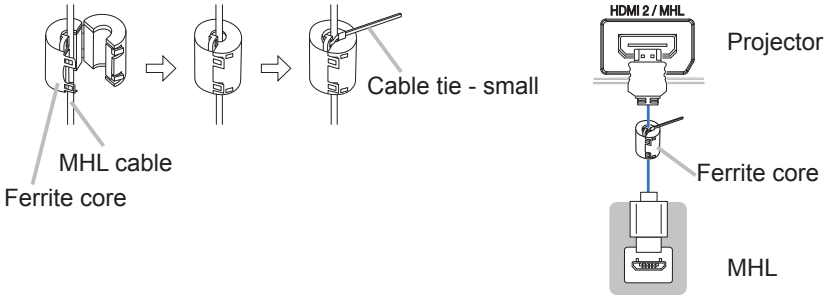

Fastening the adapter cover

Use the supplied adapter cover to prevent the USB wireless adapter (optional) from coming off easily and prevention from burn injury.

1. Loosen the screw (marked with triangle) on the bottom left of the **USB TYPE A** port.
2. Insert the tab of the cover into the hole at the upper right of the **USB TYPE A** port in the direction of the arrow.
3. Align the screw holes on the projector and the cover. Then insert the screw removed from the projector into the hole and tighten the screw.

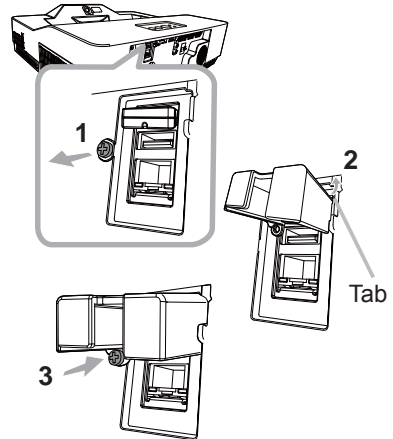

⚠WARNING ► Keep small parts away from children and pets. Take care not to put in the mouth. Heat may build up in the USB wireless adapter, so disconnect the projector power cord for more than 10 minutes before touching it to avoid possible burns.

Connecting to a power supply

1. Put the connector of the power cord into the **AC** (AC inlet) of the projector.
2. Firmly plug the power cord's plug into the outlet. In a couple of seconds after the power supply connection, the **POWER/STATUS1** indicator will light up in steady orange.

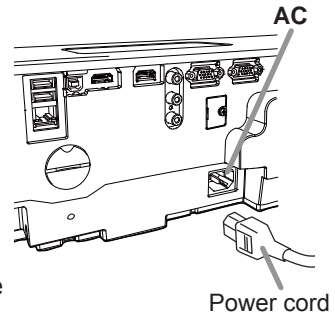

Please remember that when the DIRECT POWER ON function is activated (📖 70), the connection of the power supply makes the projector turn on.

When the AUTO POWER ON function is activated and the projector is receiving an input signal, it is turned on by connecting to the power supply. (📖 70)

⚠ WARNING ► Please use extra caution when connecting the power cord, as incorrect or faulty connections may result in fire and/or electrical shock.

- Do not touch the power cord with a wet hand.
- Only use the power cord that came with the projector. If it is damaged, consult your dealer to get a new one. Never modify the power cord.
- Only plug the power cord into an outlet whose voltage is matched to the power cord. The power outlet should be close to the projector and easily accessible. Unplug the power cord for complete disconnection.
- Do not distribute the power supply to multiple devices. Doing so may overload the outlet and connectors, loosen the connection, or result in fire, electric shock or other accidents.
- Do not press the main body of projector on the power cord.
- Connect the ground terminal for the AC inlet of this unit to the ground terminal of the building using an appropriate power cord (bundled).

Using the security bar and slot

A commercially available anti-theft chain or wire can be attached to the security bar on the projector. Refer to the figure to choose an anti-theft chain or wire.

Also this product has the security slot for the Kensington lock.

For details, see the manual of the security tool.

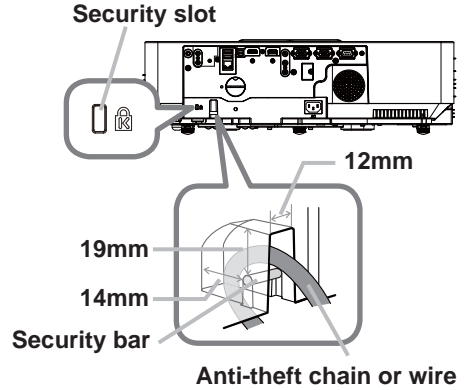

⚠ WARNING ▶ Do not use the security slot to prevent the projector from falling down, since it is not designed for it.

⚠ CAUTION ▶ Do not place anti-theft chain or wire near the exhaust vents. It may become too hot.

NOTE • The security bar and slot is not comprehensive theft prevention measures. It is intended to be used as supplemental theft prevention measure.

When using the optional suspension bracket (HAS-9110), fix the bundled hook metal and screws securely, and attach the drop-prevention chain.

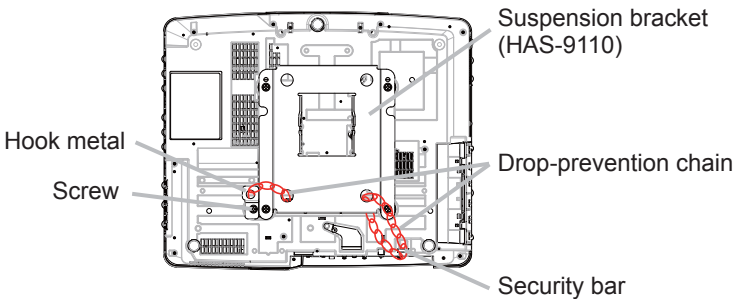

- Pass the drop-prevention chain through the hole of the optional suspension bracket and hook metal, and fix it securely with a quick link.

- Fix the drop-prevention chain with a quick link so that it cannot have any slack as shown in the drawing.

Remote control

Installing the batteries

Please insert the batteries into the remote control before using it. If the remote control starts to malfunction, try to replace the batteries. If you will not use the remote control for long period, remove the batteries from the remote control and store them in a safe place.

1. Remove the battery cover.
2. Align and insert the two AA batteries (Use the appropriate AA carbon-zinc or alkaline batteries (non-rechargeable) in accordance with laws and regulations.) according to their plus and minus terminals as indicated in the remote control.
3. Put the battery cover back to the former state.

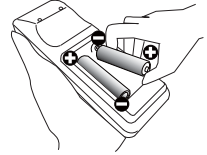

⚠ WARNING ▶ Always handle the batteries with care and use them only as directed. Improper use may result in battery explosion, cracking or leakage, which could result in fire, injury and/or pollution of the surrounding environment.

- Be sure to use only the specified batteries. Do not use batteries of different types at the same time. Do not mix a new battery with used one.
- Make sure the plus and minus terminals are correctly aligned when loading a battery.
- Keep a battery away from children and pets.
- Do not recharge, short circuit, solder or disassemble a battery.
- Do not place a battery in a fire or water. Keep batteries in a dark, cool and dry place.
- If you observe battery leakage, wipe out the leakage and then replace a battery. If the leakage adheres to your body or clothes, rinse well with water immediately.
- Obey the local laws on disposing the battery.

About the remote control signal

The remote control works with the projector's remote sensor. This projector has a remote sensor on the front.

The sensor senses the signal within the following range when the sensor is active:

60 degrees (30 degrees to the left and right of the sensor) within about 3 meters.

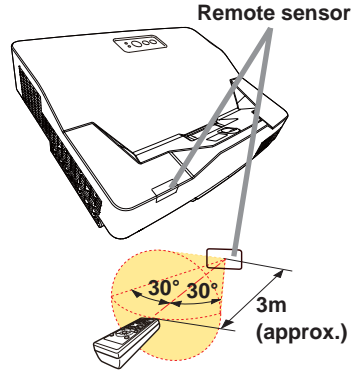

NOTE

- The remote control signal reflected in the screen or the like may be available. If it is difficult to send the signal to the sensor directly, attempt to make the signal reflect.
- The remote control uses infrared light to send signals to the projector (Class 1 LED), so be sure to use the remote control in an area free from obstacles that could block the remote control's signal to the projector.
- The remote control may not work correctly if strong light (such as direct sun light) or light from an extremely close range (such as from an inverter fluorescent lamp) shines on the remote sensor of the projector. Adjust the position of projector avoiding those lights.

Changing the frequency of remote control signal

The accessory remote control has the two choices on signal frequency Mode 1:NORMAL and Mode 2:HIGH. If the remote control does not function properly, attempt to change the signal frequency.

In order to set the Mode, please keep pressing the combination of two buttons listed below simultaneously for about 3 seconds.

- (1) Set to Mode 1:NORMAL... **VOLUME -** and **RESET** buttons
- (2) Set to Mode 2:HIGH... **MAGNIFY OFF** and **ESC** buttons

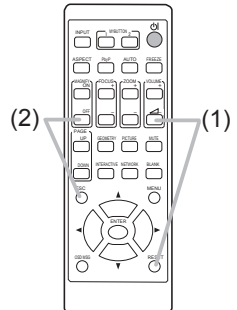

Please remember that the REMOTE FREQ. in the SERVICE item of the OPTION menu ( 78) of the projector to be controlled should be set to the same mode as the remote control.

Using as a simple PC mouse & keyboard

The accessory remote control works as a simple mouse and keyboard of the computer, when the projector's **USB TYPE B** port and the computer's type A USB port are connected.

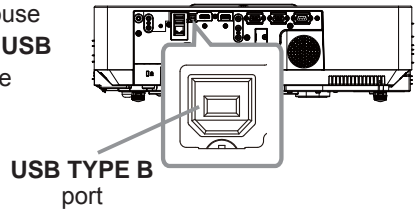

- (1) **PAGE UP key:** Press the **PAGE UP** button.
- (2) **PAGE DOWN key:** Press the **PAGE DOWN** button.
- (3) **Mouse left button:** Press the **ENTER** button.
- (4) **Move pointer:** Use the cursor buttons **▲**, **▼**, **◀** and **▶**.
- (5) **ESC key:** Press the **ESC** button.
- (6) **Mouse right button:** Press the **RESET** button.

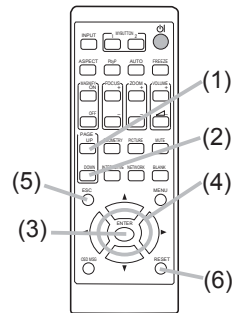

△NOTICE ▶ Improper use of the simple mouse & keyboard function could damage your equipment. While using this function, please connect this product only to a computer. Be sure to check your computer's manuals before connecting this product to the computer.

NOTE When the simple mouse & keyboard function of this product does not work correctly, please check the following.

- When a USB cable connects this projector with a computer having a built-in pointing device (e.g. track ball) like a laptop PC, open BIOS setup menu, then select the external mouse and disable the built-in pointing device, because the built-in pointing device may have priority to this function.
- Windows® 7 or higher is required for this function. And also this function may not work depending on the computer's configurations and mouse drivers. This function can work with the computer which can operate general USB mouse or keyboard.
- You cannot do things like pressing two buttons at once (for instance, pressing two buttons at the same time to move the mouse pointer diagonally).
- This function is activated only when the projector is working properly. This function is not available in any of the following cases:
 - While the light source is warming up. (The **POWER/STATUS1** indicator blinks in green.)
 - When **USB TYPE A** port is selected.
 - While displaying BLANK (📖 36) or MY IMAGE screen.
 - When any menu is displayed on the screen.
 - While using the cursor buttons to operate the sound or screen functions such as adjusting the sound volume, correcting the keystone, correcting the picture position and magnifying the screen.

Interactive pen

Installing the battery

1. Turn the battery cover of the pen to the left to open it.
2. As illustrated in the diagram, insert the AAA battery into the battery cover with the - end facing the front.



(Use the appropriate AAA alkaline batteries (non-rechargeable) in accordance with laws and regulations.)

3. Attach the battery cover by turning it to the right until it is completely closed.

- If you will not use the pen for long period, remove the batteries from the pen and store them in a safe place.
- If the pen do not operate properly, change the batteries to other maker's product.

Exchanging the tip of the pen

When the tip of the pen is shortened due to wearing, exchange it according to the following procedure.

1. Remove the tip of the pen referring to the illustration.
2. Fit a new tip into the place and push it so that it clicks.

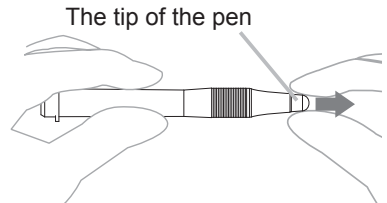

⚠ WARNING ▶ Always handle the batteries with care and use them only as directed. Improper use may result in battery explosion, cracking or leakage, which could result in fire, injury and/or pollution of the surrounding environment.

- Be sure to use only the batteries specified.
- Do not hold a battery with tweezers or the like.
- Make sure the plus and minus terminals are correctly aligned when loading a battery.
- Keep a battery away from children and pets.
- Do not recharge, short circuit, solder or disassemble a battery.
- Do not place a battery in a fire or water. Keep batteries in a dark, cool and dry place.
- If you observe battery leakage, wipe out the leakage and then replace a battery. If the leakage adheres to your body or clothes, rinse well with water immediately.
- Obey the local laws on disposing the battery.
- Keep the tip of the pen away from children and pets. Exercise care to prevent them from swallowing the tip of the pen or the pack of spare accidentally. If swallowed consult a physician immediately for emergency treatment.

⚠ CAUTION ▶ Do not drop the pen or mishandle it.

- Do not keep the tip of the pen directed to a bottom. It may cause damage, trouble and the consumption of the battery.

Power on/off

Turning on the power

1. Make sure that the power cord is firmly and correctly connected to the projector and the outlet.
2. Make sure that the **POWER/STATUS1** indicator is steady orange (📖 138).
3. Press **STANDBY/ON** button on the projector or the remote control. The projection light source will light up, and the **POWER/STATUS1** indicator will begin blinking green. When the power is completely on, the indicator will stop blinking and light in steady green (📖 138).

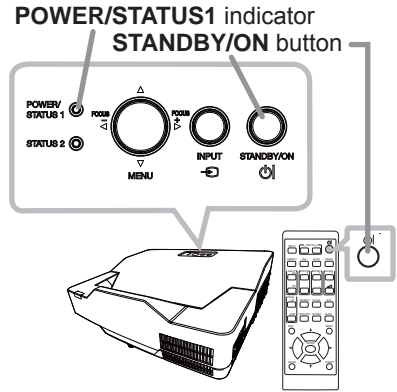

To display the picture, select an input signal according to the section **Selecting an input signal** (📖 28).

(continued on next page)

⚠WARNING ▶ Never look into the projection window while the projection light source is on, since the projection ray may cause a trouble on your eyes.

▶ Do not place the projector vertically as shown in the figure on the right. It could cause malfunction or injury. If you install the projector on a table or desk, be sure to use the designated optional accessories.

▶ The projection window of this machine is made of glass. It can be damaged by excessive force or an impact. Read the following important warnings carefully, and follow them for your own safety.

- Do not apply excessive force on or allow impact to the projection window.

- Keep the projector out of the reach of children.

- If the projection window is broken, the projected image will be distorted. Never touch a broken projection window, and contact your dealer.

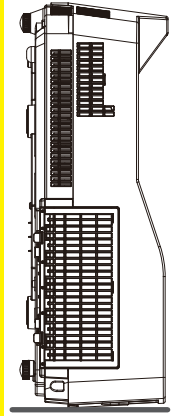

Turning off the power

1. Press the **STANDBY/ON** button on the projector or the remote control.
 - The message “Power off?” will appear on the screen for about 5 seconds.
2. Press the **STANDBY/ON** button again while the message appears.
 - The light source will go off, and the **POWER/STATUS1** indicator will begin blinking in orange. Then the **POWER/STATUS1** indicator will stop blinking and light in steady orange when the light source cooling is completed ([📖 138](#)).

⚠WARNING ▶ Do not touch around the exhaust vents during use or just after use, since it is too hot.

▶ Unplug the power cord for complete disconnection. The power outlet should be close to the projector and easily accessible.

NOTE • Turn the power on/off in right order. Please power on the projector prior to the connected devices.

• This projector has the function that can make the projector automatically turn on/off. Please refer to the **DIRECT POWER ON** ([📖 70](#)), **AUTO POWER ON** ([📖 70](#)) and **AUTO POWER OFF** ([📖 71](#)) items of the **OPTION** menu.

Operating

Adjusting the volume

- Use the **VOLUME +/VOLUME -** buttons to adjust the volume.
 - A dialog will appear on the screen to aid you in adjusting the volume. If you do not do anything, the dialog will automatically disappear after about ten seconds.
- When \times is selected for current picture input port, the volume adjustment is disabled. Please see AUDIO SOURCE item of AUDIO menu ([63](#)).
 - Even if the projector is in the standby mode, the volume is adjustable when both of the following conditions are true:
 - An option other than \times is selected for AUDIO OUT in the STANDBY OUTPUT item of the SETUP menu ([62](#)).
 - NORMAL or QUICK START is selected in the STANDBY MODE item of the SETUP menu ([60](#)).

VOLUME +/- button

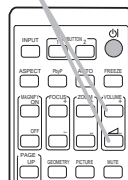

Temporarily muting the sound

Press **MUTE** button on the remote control.
A dialog will appear on the screen indicating that you have muted the sound.

To restore the sound, press the **MUTE**, **VOLUME +** or **VOLUME -** button. Even if you do not do anything, the dialog will automatically disappear after a few seconds.

MUTE button

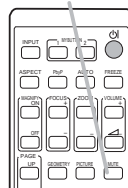

NOTE • When \times is selected for current picture input port, the sound is always muted.

Please see AUDIO SOURCE item of AUDIO menu ([63](#)).

• C.C. (Closed Caption) is automatically activated when sound is muted and an input signal containing C.C. is received. This function is available only when the signal is NTSC for **VIDEO** or 480i@60 for **COMPUTER IN1** or **COMPUTER IN2**, and when AUTO is selected for DISPLAY in the C.C. menu under the SCREEN menu ([68](#)).

Selecting an input signal

1. Press the **INPUT** button on the projector or the remote control. Select a desirable input referring to the displayed input list.

INPUT button

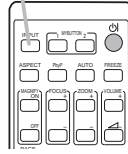

INPUT button

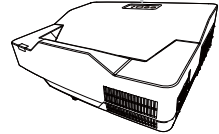
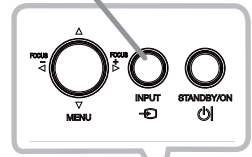

- While ON is selected for AUTO SEARCH item in OPTION menu (69), the projector will keep checking the ports in above order repeatedly till an input signal is detected. The ports can be set to be ignored in searching by the AUTO SEARCH function.
- It may take several seconds to project the images from the **USB TYPE B** port.

Selecting an aspect ratio

1. Press **ASPECT** button on the remote control.
 - Each time you press the button, the projector switches the mode for aspect ratio in turn.

ASPECT button

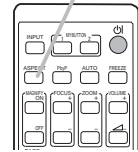

- For a computer signal, an HDMI™ signal, a video signal or component video signal

NORMAL → 4:3 → 16:9 → 16:10 → 14:9 → ZOOM → NATIVE



- For an input signal from the LAN, USB TYPE A or USB TYPE B port, or if there is no signal

16:10 (fixed)

- **ASPECT** button does not work when no proper signal is input.
- NORMAL mode keeps the original aspect ratio setting.
- The on-screen menu might be displayed outside of the image display area depending on the adjustment value of the ASPECT, D-ZOOM, KEYSTONE, KEYSTONE and PERFECT FIT. Changing the values of ASPECT, D-ZOOM, KEYSTONE, KEYSTONE and PERFECT FIT may fix the symptom.

Calibration

Press the **INTERACTIVE** button on the remote control.

Displays the INTERACTIVE dialog.

You can execute calibration of the Interactive Function in the INTERACTIVE dialog.

Use the ◀/▶ cursor buttons to switch IWB MODE for the currently selected input port.

Use the ◀/▶ cursor buttons to switch ON/OFF of FINGER TOUCH.

See the Interactive Function (📖 97).

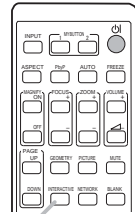

INTERACTIVE
button



Adjusting the projector's elevator

The projector has 2 Rear feet for adjusting the horizontal position and inclination. You can use the projector as it is with attached Spacers of Rear feet. You can make more precise adjustments by detaching the spacers and turning the Rear feet.

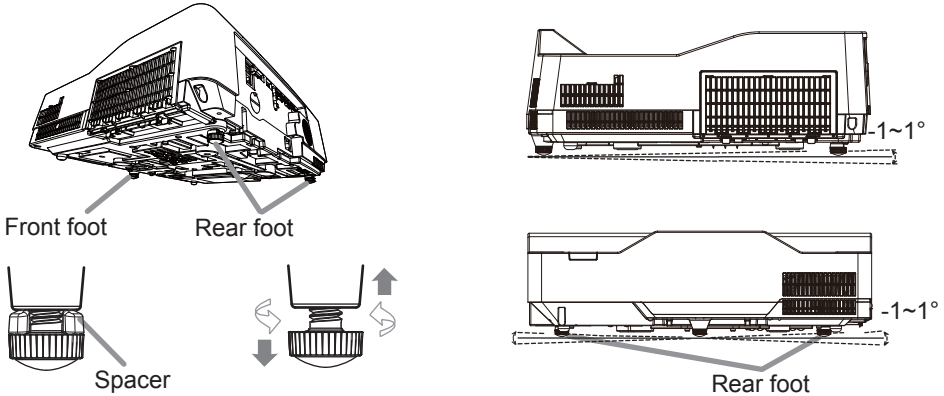

△WARNING ► Keep the spacers away from children and pets. Be careful not to let them swallow the spacers. If swallowed, consult a physician immediately for emergency treatment.

NOTE • The adjustment angle can be adjusted up to plus or minus 1° each of foot.

• You can attach the spacers to set the projector back to the factory default after adjusting the foot. If you change the place to install the projector in the future, it is recommended to keep the spacers and reuse them.

Adjusting the zoom and focus

Press the **ZOOM +** or **ZOOM -** button on the remote control to display D-ZOOM dialog on screen.

Use the **ZOOM +** and **ZOOM -** buttons to adjust the picture size.

To finish the operation, do not touch these buttons for about ten seconds until the dialog is disappeared.

• If you want to expand a part of the image, use the magnify function (📖 35).

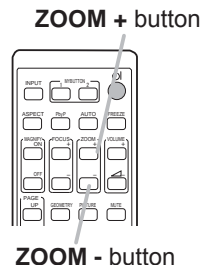

(continued on next page)

Press the **FOCUS +** or **FOCUS -** button on the remote control, or **FOCUS +** or **FOCUS -** button on the projector (65) while no menu is on screen, to display the FOCUS box on screen. Use the **FOCUS +** and **FOCUS -** buttons to adjust the screen focus. After the focus adjustment, wait for a while until the FOCUS box is disappeared, if you want to display any other menu on screen by pressing the **MENU** button on the projector.

- The ◀/▶/▲/▼ buttons on the projector work only as the cursor buttons while the template is displayed (67).
- The **FOCUS +/-** button on the projector is invalid when the **USB TYPE A** port is selected as the input source.

FOCUS + button

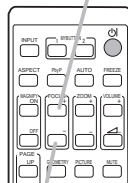

FOCUS - button

Using the automatic adjustment feature

1. Press **AUTO** button on the remote control.
 - Pressing this button performs the following.

○ For a computer signal

The vertical position, the horizontal position and the horizontal phase will be automatically adjusted.

Make sure that the application window is set to its maximum size prior to attempting to use this feature. A dark picture may still be incorrectly adjusted. Use a bright picture when adjusting.

○ For a video signal

The video format best suited for the respective input signal will be selected automatically. This function is available only when the AUTO is selected for the VIDEO FORMAT item in the INPUT menu (57). The vertical position and horizontal position will be automatically set to the default.

○ For a component video signal

The vertical position and horizontal position will be automatically set to the default. The horizontal phase will be automatically adjusted.

- The automatic adjustment operation requires approx. 10 seconds. Also please note that it may not function correctly with some input.
- When this function is performed for a video signal, a certain extra such as a line may appear outside a picture.
- When this function is performed for a computer signal, a black frame may be displayed on the edge of the screen, depending on the PC model.
- The items adjusted by this function may vary when the FINE or DISABLE is selected for the AUTO ADJUST item of the SERVICE item in the OPTION menu (77).

AUTO button

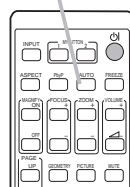

Correcting the distortion

To correct the distortion of projected screen, you can select one of two options, **KEYSTONE** and **PERFECT FIT**. First press the **GEOMETRY** button to display the **GEOMETRY CORRECTION** menu, and point at one of the items with the **▲/▼** buttons.

KEYSTONE: allows you to adjust the vertical and horizontal keystone.

PERFECT FIT: allows you to adjust each of the screen corners and sides to correct the distortion.

Use **KEYSTONE / PERFECT FIT** for adjustment.

When one of them is selected, the other item is not available.

Then follow the procedure shown below for the item you selected.

GEOMETRY button

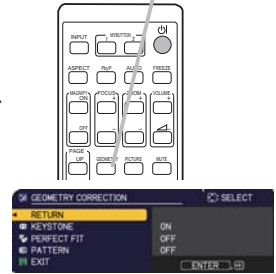

NOTE • The menu or dialog will automatically disappear after several seconds of inactivity. Press the **GEOMETRY** button again, or point the cursor at **EXIT** in the dialog and press the **▶** or **ENTER** button to end the operation and close the menu or dialog.

• This function is unavailable when **TRANSITION DETECTOR** is ON. (88)

○ **KEYSTONE**:

When **KEYSTONE** is pointed at, pressing the **▶** or **ENTER** button displays the **KEYSTONE** dialog.

1. Select the vertical or horizontal keystone (▲ / ▼) with the **▲/▼** buttons.
2. Use the **◀/▶** buttons to adjust the keystone distortion.



NOTE • Point at **RETURN** in the dialog with the **▲/▼** buttons and press **◀** or **ENTER** button to return to the **GEOMETRY CORRECTION** menu.

Correcting the distortion (continued)

○ PERFECT FIT:

When PERFECT FIT is pointed at, pressing the ► or **ENTER** button displays the PERFECT FIT dialog.

This projector is equipped with a test pattern for PERFECT FIT. Select PATTERN with the ▲/▼ buttons, then press the ◀/▶ buttons to switch on and off.



1. Select SETUP with the ▲/▼ buttons and press the ► or **ENTER** button.
2. Select one of the corners or sides to be adjusted with the ▲/▼/◀/▶ buttons and press the **ENTER** or **↻** button.
3. Adjust the selected part as below.
 - For adjusting a corner, use the ▲/▼/◀/▶ buttons to adjust the position of the corner.
 - Use the ▲/▼ buttons to adjust the distortion of the upper or lower side after adjusting the position with the ◀/▶ buttons.
 - Use the ◀/▶ buttons to adjust the distortion of the left or right side after adjusting the position with the ▲/▼ buttons.
 - To adjust another corner or side, press the **ENTER** or **↻** button and follow the procedure from step 2.

(continued on next page)

Correcting the distortion (continued)

4. This projector is equipped with a memory feature for PERFECT FIT adjustment. Up to 3 sets of adjustments can be stored.

- **LOAD:**

To recall stored adjustments, select one of the "LOAD" options numbered 1 to 3 (number of the memory) with the ▲/▼ buttons and press the ►, **ENTER** or  button.

Remember that the current adjusted condition will be lost by loading data. If you want to keep the current adjustment, please save it before performing a LOAD function.

- **SAVE:**

To store the current PERFECT FIT adjustment, select one of the "SAVE" options numbered 1 to 3 (number of the memory) with the ▲/▼ buttons and press the ►, **ENTER** or  button.

Remember that the current data stored in a memory will be lost by saving new data into the memory.

NOTE • The LOAD functions whose linked memory has no data are skipped.
 • There may be some noise and the screen may flicker for a moment when loading data. This is not malfunction.

Limiting OSD display

To change this function, follow the steps below.

1. Press the **OSD MSG** button on the remote control for 3 seconds.
2. The INHIBIT OSD will be displayed.

While this OSD is displayed, press the **OSD MSG** button again on the remote control.

3. Toggle and change the function.

NORMAL ⇔ SILENT ⇔ INHIBIT



OSD MSG button

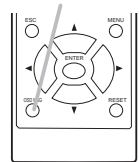

Using the magnify feature

1. Press the **MAGNIFY ON** button on the remote control.
The picture will be magnified, and the MAGNIFY dialog will appear on the screen. When the **MAGNIFY ON** button is pressed for the first time after the projector is turned on, the picture will be zoomed by 1.5 times. On the dialog, triangle marks to show each direction will be displayed.

MAGNIFY ON/OFF button

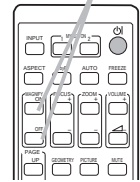

2. The display magnification of the projector switches in order with every press of the **MAGNIFY ON** button.

- For computer signals, HDMI™ (RGB) signals, input signals from the LAN, USB TYPE A or USB TYPE B port

1.5 times → 2 times → 3 times → 4 times → 1 time



- For video signals, component video signals or HDMI™ (Component) signals

1.5 times → 2 times → 1 time



3. While the triangles are displayed on the dialog, use the ▲/▼/◀/▶ cursor buttons to shift the magnifying area.

4. Press the **MAGNIFY OFF** button on the remote control to exit magnification.

- The MAGNIFY dialog will automatically disappear in several seconds with no operation. The dialog will appear again if the **MAGNIFY ON** button is pressed when the dialog has automatically disappeared.
- The magnification is automatically disabled when the displaying signal or its display condition is changed.
- While the magnification is active, the keystone distortion condition may vary. It will be restored when the magnification is disabled.
- Some horizontal stripes might be visible on the image while magnification is active.
- This function is not available in the following cases:
 - A sync signal in the range which is not supported is input.
 - There is no input signal.

Temporarily freezing the screen

1. Press the **FREEZE** button on the remote control.
The “FREEZE” indication will appear on the screen (however, the indication will not appear when the OFF is selected for the OSD MESSAGE item in the SETUP menu (62)), and the projector will go into the FREEZE mode, which the picture is frozen.
To exit the FREEZE mode and restore the screen to normal, press the **FREEZE** button again.

FREEZE button

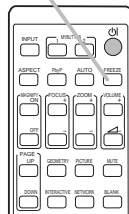

- The projector automatically exits from the FREEZE mode when some control buttons are pressed.
- If the projector continues projecting a still image for a long time, the LCD panel might possibly be burned in. Do not leave the projector in the FREEZE mode for too long.
- Images might appear degraded when this function is operated, but it is not a malfunction.

Temporarily blanking the screen

Press **BLANK** button on the remote control.

The BLANK screen will be displayed instead of the screen of input signal. Please refer to BLANK item in SCREEN menu (64).

To exit from the BLANK screen and return to the input signal screen, press **BLANK** button again.

BLANK button

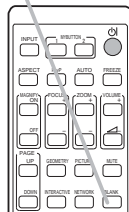

- The projector automatically exits from the BLANK mode when some control buttons are pressed.

⚠ WARNING ▶ If you wish to have a blank screen while the light source is on, use the BLANK function.
Taking any other action may cause the damage on the projector. Blocking the beam by something causes high temperature and could result in fire or smoke.

NOTE • The sound is not muted even if the BLANK screen is displayed. If necessary, adjust the volume or mute the sound in advance.

Using the menu function

This projector has the following menus:

IWB, PICTURE, IMAGE, INPUT, SETUP, AUDIO, SCREEN, OPTION, NETWORK, SECURITY and EASY MENU.

EASY MENU consists of functions often used, and the other menus are classified into each purpose and brought together as the ADVANCED MENU.

Each of these menus is operated using the same methods. While the projector is displaying any menu, the **MENU** button on the projector works as the cursor buttons. The basic operations of these menus are as follows.

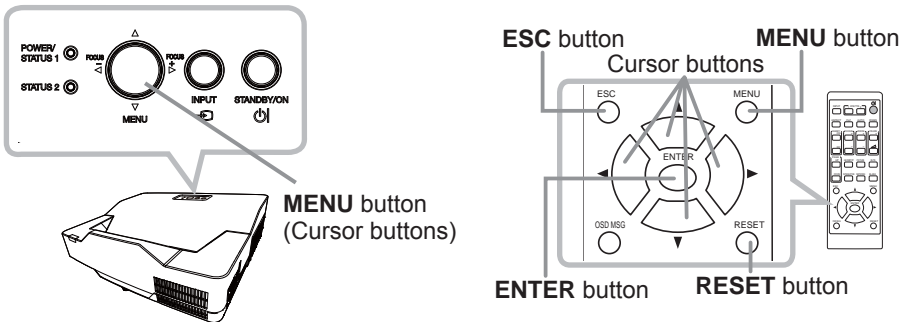

1. To start the MENU, press the **MENU** button. The MENU you last used (EASY or ADVANCED) will appear. EASY MENU has priority to appear just after powered on.

2. In the EASY MENU

- (1) Use the ▲/▼ cursor buttons to select an item to operate. If you want to change it to the ADVANCED MENU, select the ADVANCED MENU.
- (2) Use the ◀/▶ cursor buttons to operate the item.



In the ADVANCED MENU

- (1) Use the ▲/▼ cursor buttons to select a menu. If you want to change it to the EASY MENU, select the EASY MENU. The items in the menu appear on the right side.
- (2) Press the ▶ cursor button or **ENTER** button to move the cursor to the right side. Then use the ▲/▼ cursor buttons to select an item to operate and press the ▶ cursor button or **ENTER** button to progress. The operation menu or dialog of the selected item will appear.
- (3) Use the buttons as instructed in the OSD to operate the item.



(continued on next page)

Using the menu function (continued)

3. To close the MENU, press the **MENU** button again or select EXIT and press the ◀ cursor button or **ENTER** button. Even if you do not do anything, the dialog will automatically disappear after about 30 seconds.
 - Some functions cannot be performed when a certain input port is selected, or when a certain input signal is displayed.
 - When you want to reset the operation, press the **RESET** button on the remote control during the operation. Note that some items (ex. LANGUAGE, VOLUME) cannot be reset.
 - In the ADVANCED MENU, when you want to return to the previous display, press the ◀ cursor button or **ESC** button on the remote control.

Indication in OSD (On Screen Display)

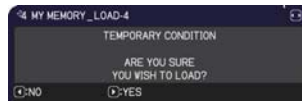
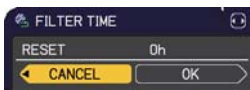

The meanings of the general words on the OSD are as follows.

Indication	Meaning
EXIT	Selecting this word finishes the OSD menu. It is the same as pressing the MENU button.
RETURN	Selecting this word returns the menu to the previous menu.
CANCEL or NO	Selecting this word cancels the operation in the present menu and returns to the previous menu.
OK or YES	Selecting this word executes the prepared function or shifts the menu to the next menu.

EASY MENU

From the EASY MENU, items shown in the table below can be performed.

Select an item using the ▲/▼ cursor buttons. Then perform it according to the following table.



Item	Description
IWB CALIBRATE	Pressing the ► button displays the IWB CALIBRATE dialog. See the Interactive Function (📖 97).
ASPECT	Using the ◀/▶ buttons switches the mode for aspect ratio. See the ASPECT item in IMAGE menu (📖 47).
D-ZOOM	Using the ◀/▶ cursor buttons adjusts the magnification ratio. Small ↔ Large See the D-ZOOM item in the SETUP menu (📖 55). • The on-screen menu might be displayed outside of the image display area depending on the adjustment value of the ASPECT, D-ZOOM, ◻ KEYSTONE, ◻ KEYSTONE and PERFECT FIT. Changing the values of ASPECT, D-ZOOM, ◻ KEYSTONE, ◻ KEYSTONE and PERFECT FIT may fix the symptom.
KEYSTONE	Pressing the ► button displays the dialog for correcting the keystone distortion (📖 56).
PERFECT FIT	Pressing the ► button displays the dialog for adjusting the shape of the projected image in each of the corners and sides. See the PERFECT FIT item in SETUP menu (📖 56).

(continued on next page)

Item	Description
PICTURE MODE	<p>Using the ◀/▶ buttons switches the picture mode. The picture modes are combinations of GAMMA and COLOR TEMP settings. Choose a suitable mode according to the projected source.</p> <ul style="list-style-type: none"> • Lines or other noise might appear on the screen when this function is operated, but it is not a malfunction. • DICOM SIM. is the projector's DICOM® ("Digital Imaging and Communication in Medicine") simulation mode. This mode simulates the DICOM standard, which is a standard applicable to digital communications in medicine, and can be useful for displaying medical images, such as X-rays photos. This projector is not a medical device and is not compliant to the DICOM standard, and neither the projector nor the DICOM SIM. mode should be used for medical diagnosis.
LIGHT OUTPUT	<p>Pressing the ▶ button displays the dialog for light output. See the LIGHT OUTPUT item of the LIGHT & FILTER item in SETUP menu. (p. 58)</p> <ul style="list-style-type: none"> • When the ambient temperature is around 35 to 40°C, the brightness of light source is reduced automatically. • When the vertical frequency of the input signal is 50Hz, the brightness of light source may be reduced automatically to reduce flicker. If you do not want to reduce the brightness, set FLICKER REDUCTION to OFF. (p. 77) • The brightness of the light source may be reduced depending on the direction of the projection.
INSTALLATION	<p>Pressing the ▶ button displays the INSTALLATION dialog. See the INSTALLATION item in SETUP menu (p. 59).</p>
RESET	<p>Performing this item resets all of the EASY MENU items except the FILTER TIME and LANGUAGE. A dialog is displayed for confirmation. Selecting the OK using the ▶ button performs resetting.</p>
FILTER TIME	<p>The usage time of the air filter is shown in the menu. Performing this item resets the filter time which counts usage time of the air filter. A dialog is displayed for confirmation. Selecting the OK using the ▶ button performs resetting. See the FILTER TIME item of the LIGHT & FILTER item in SETUP menu. (p. 58)</p>

(continued on next page)

Item	Description
LANGUAGE	Using the ◀/▶ buttons changes the display language. See the LANGUAGE item in SCREEN menu (📖 64).
ADVANCED MENU	Press the ▶ or ENTER button to use the menu of PICTURE, IMAGE, INPUT, SETUP, AUDIO, SCREEN, OPTION, NETWORK or SECURITY.
EXIT	Press the ◀ or ENTER button to finish the OSD menu.

IWB menu

Select an item using the ▲/▼ cursor buttons, and press the ► cursor button or **ENTER** button to execute the item.

See the Interactive Function (📖 91).

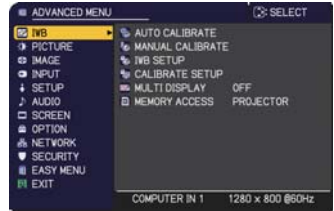

PICTURE menu

From the PICTURE menu, items shown in the table below can be performed.

Select an item using the ▲/▼ cursor buttons, and press the ► cursor button or **ENTER** button to execute the item. Then perform it according to the following table.



Item	Description
BRIGHTNESS	Using the ◀/▶ buttons adjusts the brightness. Dark ⇄ Light
CONTRAST	Using the ◀/▶ buttons adjusts the contrast. Weak ⇄ Strong
COLOR	Using the ◀/▶ buttons adjusts the strength of whole color. Weak ⇄ Strong
TINT	Using the ◀/▶ buttons adjusts the tint. Reddish ⇄ Greenish
SHARPNESS	Using the ◀/▶ buttons adjusts the sharpness. Weak ⇄ Strong <ul style="list-style-type: none"> • There may be some noise and/or the screen may flicker for a moment when an adjustment is made. This is not a malfunction.

(continued on next page)

Item	Description
PICTURE QUALITY	<p>Selecting this item displays the PICTURE QUALITY menu.</p> <p>Select an item using the ▲/▼ buttons, and press the ► button or the ENTER button on the remote control to execute the item.</p> 
	<p>PICTURE MODE</p> <p>After selecting USER-1 / USER-2 / USER-3, the following features are adjustable.</p> <p>Gamma, Color Temp</p>
	<p>GAMMA</p> <p>This feature is only available when USER-1 / USER-2 / USER-3 is selected.</p> <p>Using the ▲/▼ buttons switches the gamma mode.</p> <p>DEFAULT-1 ⇔ CUSTOM-1 ⇔ DEFAULT-2 ⇔ CUSTOM-2 ⇕ CUSTOM-8 ⇕ DEFAULT-8 ⇕ CUSTOM-7 ⇕ DEFAULT-7 ⇕ CUSTOM-6 ⇔ DEFAULT-6 ⇔ CUSTOM-5 ⇔ DEFAULT-5</p> <p style="text-align: right;"> STANDARD DEFAULT-1 HDR-2 2 1 </p>

(continued on next page)

Item	Description
<p>PICTURE QUALITY (continued)</p>	<p>GAMMA (continued)</p> <p>Selecting a mode whose name includes CUSTOM and then pressing the ► button or the ENTER button displays a dialog to aid you in adjusting the mode. This function is useful when you want to change the brightness of particular tones. Choose an item using the ◀/▶ buttons, and adjust the level using the ▲/▼ buttons.</p> <ul style="list-style-type: none"> • Lines or other noise might appear on the screen when this function is operated, but it is not a malfunction.
	<p>COLOR TEMP</p> <p>This feature is only available when USER-1 / USER-2 / USER-3 is selected.</p> <p>Using the ▲/▼ buttons switches the color temperature mode.</p> <p style="text-align: center;"> HIGH ⇔ CUSTOM-1 ⇔ MID-1 ⇔ CUSTOM-2 ⇕ ⇕ CUSTOM-7 ⇔ MID-2 ⇕ ⇕ Hi-BRIGHT-3 ⇔ CUSTOM-3 ⇕ ⇕ CUSTOM-6 ⇔ LOW ⇕ ⇕ Hi-BRIGHT-2 ⇔ CUSTOM-5 ⇔ Hi-BRIGHT-1 ⇔ CUSTOM-4 </p> <p>Selecting a mode whose name includes CUSTOM and then pressing the ► button or the ENTER button displays a dialog to aid you in adjusting the OFFSET and GAIN of the selected mode. OFFSET adjustments change the color intensity on the whole tones. GAIN adjustments mainly affect color intensity on the brighter tones. Choose an item using the ◀/▶ buttons, and adjust the level using the ▲/▼ buttons.</p> <ul style="list-style-type: none"> • Lines or other noise might appear on the screen when this function is operated, but it is not a malfunction.

(continued on next page)

Item	Description
<p>PICTURE QUALITY (continued)</p>	<p>ACCENTUALIZER ACCENTUALIZER is a function to improve the legibility. Using the ◀/▶ buttons adjusts the sharpness.</p> <p>Weak ⇔ Strong</p> <ul style="list-style-type: none"> • There may be some noise and/or the screen may flicker for a moment when an adjustment is made. This is not a malfunction.
	<p>HDCR A function to show a clear picture in a bright room. Using the ◀/▶ buttons adjusts the contrast.</p>
<p>DYNAMIC BLACK</p>	<p>Turn on/off the DYNAMIC BLACK function. Configures the projector to automatically adjust the contrast of the input image. When a black video signal is input, the projector dynamically adjusts the picture contrast . This function may not work correctly when analog signals contain noise.</p>
<p>MY MEMORY</p>	<p>This projector has 4 memories for adjustment data (for all the items of the PICTURE menu). Selecting a function using the ▲/▼ buttons and pressing the ▶ or ENTER button performs each function.</p> <p style="text-align: center;"> ↳LOAD-1 ⇔ LOAD-2 ⇔ LOAD-3 ⇔ LOAD-4↳ ↳SAVE-4 ⇔ SAVE-3 ⇔ SAVE-2 ⇔ SAVE-1↳ </p> <p><u>LOAD-1, LOAD-2, LOAD-3, LOAD-4</u> Performing a LOAD function loads the data from the memory linked in the number included in the function's name, and adjusts the picture automatically depending on the data.</p> <ul style="list-style-type: none"> • The LOAD functions whose linked memory has no data are skipped. • Remember that the current adjusted condition will be lost by loading data. If you want to keep the current adjustment, please save it before performing a LOAD function. • There may be some noise and the screen may flicker for a moment when loading data. This is not malfunction. • You can perform the LOAD function using MY BUTTON. Please see MY BUTTON item in OPTION menu (p. 72). <p><u>SAVE-1, SAVE-2, SAVE-3, SAVE-4</u> Performing a SAVE function saves the current adjustment data into the memory linked in the number included in the function's name.</p> <ul style="list-style-type: none"> • Remember that the current data stored in a memory will be lost by saving new data into the memory.

IMAGE menu

From the IMAGE menu, items shown in the table below can be performed.

Select an item using the ▲/▼ cursor buttons, and press the ► cursor button or **ENTER** button to execute the item. Then perform it according to the following table.



Item	Description
ASPECT	<p>Using the ▲/▼ buttons switches the mode for aspect ratio.</p> <p>For a computer signal, an HDMI™ signal, a video signal or component video signal</p> <p>NORMAL ⇔ 4:3 ⇔ 16:9 ⇔ 16:10 ⇔ 14:9 ⇔ ZOOM ⇔ NATIVE</p> <p>↑—————↑</p> <p>For an input signal from the LAN, USB TYPE A or USB TYPE B port, or if there is no signal</p> <p>16:10 (fixed)</p> <ul style="list-style-type: none"> • The NORMAL mode keeps the original aspect ratio of the signal.
OVER SCAN	<p>Using the ◀/▶ buttons adjusts the over-scan ratio.</p> <p>Small (It magnifies picture) ⇔ Large (It reduces picture)</p> <ul style="list-style-type: none"> • This item cannot be selected for a computer signal of COMPUTER IN port, and LAN, USB TYPE A, USB TYPE B port.

(continued on next page)

Item	Description
V POSITION	<p>Using the ◀/▶ buttons adjusts the vertical position. Down ⇄ Up</p> <ul style="list-style-type: none"> • Over-adjusting the vertical position may cause noise to appear on the screen. If this occurs, please reset the vertical position to the default setting. Pressing the RESET button when the V POSITION is selected will reset the V POSITION to the default setting. • When this function is performed on a video signal, the range of this adjustment depends on OVER SCAN (47) setting. It is not possible to adjust when OVER SCAN is set to 10. • This function is unavailable for a signal from the LAN, USB TYPE A, USB TYPE B, HDMI 1 or HDMI 2 / MHL port.
H POSITION	<p>Using the ◀/▶ buttons adjusts the horizontal position. Right ⇄ Left</p> <ul style="list-style-type: none"> • Over-adjusting the horizontal position may cause noise to appear on the screen. If this occurs, please reset the horizontal position to the default setting. Pressing the RESET button when the H POSITION is selected will reset the H POSITION to the default setting. • When this function is performed on a video signal, the range of this adjustment depends on OVER SCAN (47) setting. It is not possible to adjust when OVER SCAN is set to 10. • This function is unavailable for a signal from the LAN, USB TYPE A, USB TYPE B, HDMI 1 or HDMI 2 / MHL port.
H PHASE	<p>Using the ◀/▶ buttons adjusts the horizontal phase to eliminate flicker. Right ⇄ Left</p> <ul style="list-style-type: none"> • This item can be selected only for a computer signal or a component video signal. This function is unavailable for a signal from the LAN, USB TYPE A, USB TYPE B, HDMI 1 or HDMI 2 / MHL port.

(continued on next page)

Item	Description
H SIZE	<p>Using the ◀/▶ buttons adjusts the horizontal size. Small ⇄ Large</p> <ul style="list-style-type: none"> • This item can be selected only for a computer signal. This function is unavailable for a signal from the LAN, USB TYPE A, USB TYPE B, HDMI 1 or HDMI 2 / MHL port. • When this adjustment is excessive, the picture may not be displayed correctly. In such a case, please reset the adjustment by pressing the RESET button on the remote control during this operation. • Images might appear degraded when this function is operated, but it is not a malfunction.
AUTO ADJUST EXECUTE	<p>Selecting this item performs the automatic adjustment feature.</p> <p>For a computer signal The vertical position, the horizontal position and the horizontal phase will be automatically adjusted. Make sure that the application window is set to its maximum size prior to attempting to use this feature. A dark picture may still be incorrectly adjusted. Use a bright picture when adjusting.</p> <p>For a video signal The video format best suited for the respective input signal will be selected automatically. This function is available only when the AUTO is selected for the VIDEO FORMAT item in the INPUT menu (☰57). The vertical position and horizontal position will be automatically set to the default.</p> <p>For a component video signal The vertical position and horizontal position will be automatically set to the default. The horizontal phase will be automatically adjusted.</p> <ul style="list-style-type: none"> • The automatic adjustment operation requires approx. 10 seconds. Also please note that it may not function correctly with some input. • When this function is performed for a video signal, a certain extra such as a line may appear outside a picture. • When this function is performed for a computer signal, a black frame may be displayed on the edge of the screen, depending on the PC model. • The items adjusted by this function may vary when the FINE or DISABLE is selected for the AUTO ADJUST item of the SERVICE item in the OPTION menu (☰77).

INPUT menu

From the INPUT menu, items shown in the table below can be performed.

Select an item using the ▲/▼ cursor buttons, and press the ► cursor button or **ENTER** button to execute the item. Then perform it according to the following table.



Item	Description
PROGRESSIVE	<p>Using the ▲/▼ buttons switches the progress mode. TV ⇄ FILM ⇄ OFF ↑—————↑</p> <ul style="list-style-type: none"> • This function works only for a video signal, component video signal (of 480i@60 or 576i@50 or 1080i@50/60) and an HDMI™ signal (of 480i@60 or 576i@50 or 1080i@50/60). • When TV or FILM is selected, the screen image will be sharp. FILM adapts to the 2-3 Pull-Down conversion system. But these may cause a certain defect (for example, jagged line) of the picture for a quick moving object. In such a case, please select OFF, even if the screen image may lose sharpness.
VIDEO NR	<p>Using the ▲/▼ buttons switches the noise reduction mode. HIGH ⇄ MID ⇄ LOW ↑—————↑</p> <ul style="list-style-type: none"> • This function works only for a video signal, component video signal (of 480i@60 or 576i@50 or 1080i@50/60) and an HDMI™ signal (of 480i@60 or 576i@50 or 1080i@50/60).
COLOR SPACE	<p>Using the ▲/▼ buttons switches the mode for color space. AUTO ⇄ RGB ⇄ SMPTE240 ⇄ REC709 ⇄ REC601 ↑—————↑</p> <ul style="list-style-type: none"> • This item can be selected only for a computer signal, component video signal(except for signals from the LAN, USB TYPE A and USB TYPE B ports) or an HDMI™ signal. • The AUTO mode automatically selects the optimum mode. • The AUTO operation may not work well at some signals. In such a case, it might be good to select a suitable mode except AUTO.



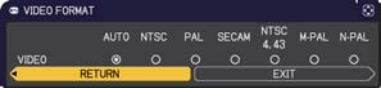
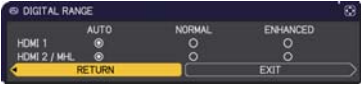

(continued on next page)

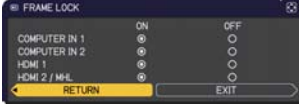
Item	Description
VIDEO FORMAT	<p>The video format for VIDEO port can be set.</p> <p>Using the ◀/▶ buttons switches the mode for video format.</p>  <p>AUTO ⇔ NTSC ⇔ PAL ⇔ SECAM ⤴ N-PAL ⇔ M-PAL ⇔ NTSC4.43 ⤵</p> <ul style="list-style-type: none"> • This item is performed only for a video signal from the VIDEO port. • The AUTO mode automatically selects the optimum mode. • The AUTO operation may not work well for some signals. If the picture becomes unstable (e.g. an irregular picture, lack of color), please select the mode according to the input signal.
DIGITAL RANGE	<p>The digital range of HDMI™/MHL input signals from the HDMI 1 and HDMI 2 / MHL ports can be set.</p> <p>(1) Use the ▲/▼ buttons to select the HDMI port to be set.</p>  <p>(2) Use the ◀/▶ buttons to select the digital range.</p> <p>AUTO ⇔ NORMAL ⇔ ENHANCED</p> <p>⤴—————⤵</p> <p>AUTO: automatically sets the optimum mode. NORMAL: sets the suitable mode for DVD signals. (16-235) ENHANCED: sets the suitable mode for computer signals. (0-255)</p> <ul style="list-style-type: none"> • If the contrast of the screen image is too strong or too weak, try finding a more suitable mode.

(continued on next page)

Item	Description
<p>COMPUTER IN</p>	<p>The computer input signal type for COMPUTER IN1 and IN2 ports can be set.</p> <p>(1) Use the ▲/▼ buttons to select the COMPUTER IN port to be set.</p> <p>(2) Use the ◀/▶ buttons to select the computer input signal type.</p> <p>(COMPUTER IN1) AUTO ⇔ SYNC ON G OFF (COMPUTER IN2) AUTO ⇔ SYNC ON G OFF ⇔ MONITOR OUT</p> <ul style="list-style-type: none"> • Selecting the AUTO mode allows you to input a sync on G signal or component video signal from the port (13). • In the AUTO mode, the picture may be distorted with certain input signals. In such a case, remove the signal connector so that no signal is received and select the SYNC ON G OFF, and then reconnect the signal. 
<p>FRAME LOCK</p>	<p>Set the frame lock function on/off for each port.</p> <p>(1) Use the ▲/▼ buttons to select the input ports.</p> <p>(2) Use the ◀/▶ buttons to turn the frame lock function on/off.</p> <p>ON ⇔ OFF</p> <ul style="list-style-type: none"> • This item can be performed only on a signal with a vertical frequency of 49 to 51Hz, 59 to 61 Hz. • When ON is selected, moving pictures are displayed more smoothly. • This function is unavailable for a signal from the HDMI 1 and HDMI 2 / MHL (of 480i@60 or 576i@50 or 1080i@50/60) port. 

(continued on next page)

Item	Description
RESOLUTION	<p>The resolution for the COMPUTER IN1 and COMPUTER IN2 input signals can be set on this projector.</p> <p>(1) In the INPUT menu, select the RESOLUTION using the ▲/▼ buttons and press the ► button. The RESOLUTION menu will be displayed.</p>  <p>(2) In the RESOLUTION menu, select the resolution you wish to display using the ▲/▼ buttons. Selecting AUTO will set a resolution appropriate to the input signal.</p> <p>(3) Pressing the ► or ENTER button when selecting a STANDARD resolution will automatically adjust the horizontal and vertical positions, clock phase and horizontal size. The INPUT_INFORMATION dialog will be displayed.</p>  <p>(4) To set a custom resolution, use the ▲/▼ buttons to select the CUSTOM and the RESOLUTION_CUSTOM box will be displayed. Set the horizontal (HORZ) and vertical (VERT) resolutions using the ▲/▼/◀/▶ buttons. This function may not support all resolutions.</p>  <p>(5) Move the cursor to OK on screen and press the ► or ENTER button. The message "ARE YOU SURE YOU WISH TO CHANGE RESOLUTION?" appears. To save the setting, press the ► button. The horizontal and vertical positions, clock phase and horizontal size will be automatically adjusted. The INPUT_INFORMATION dialog will be displayed.</p>  <p>(6) To revert back to the previous resolution without saving changes, move the cursor to CANCEL on screen and press the ◀ or ENTER button. The screen will then return to the RESOLUTION menu displaying the previous resolution.</p> <ul style="list-style-type: none"> • For some pictures, this function may not work well.

(continued on next page)

Item	Description
MHL STANDBY PWR.	<p>Using the ▲/▼ buttons switches the MHL STANDBY PWR. ON/ OFF.</p> <p>ON ⇔ OFF</p> <ul style="list-style-type: none">• When the MHL STANDBY PWR. is set to OFF, MHL power feeding is unavailable with standby mode.• When the MHL STANDBY PWR. is set to OFF, MHL audio is unavailable.• When the STANDBY MODE is set to SAVING/NETWORK(WOL), the MHL STANDBY PWR. menu cannot be operated and MHL power feeding is unavailable with standby mode (p.60).• When the MHL STANDBY PWR. is set to ON, there may be some noise with standby mode. This is not malfunction.

SETUP menu

From the SETUP menu, items shown in the table below can be performed.

Select an item using the ▲/▼ cursor buttons, and press the ► cursor button or **ENTER** button to execute the item. Then perform it according to the following table.







Item	Description
D-ZOOM	Using the ◀/▶ cursor buttons adjusts the magnification ratio. Small ⇔ Large • The on-screen menu might be displayed outside of the image display area depending on the adjustment value of the ASPECT, D-ZOOM, [] KEYSTONE, [] KEYSTONE and PERFECT FIT. Changing the values of ASPECT, D-ZOOM, [] KEYSTONE, [] KEYSTONE and PERFECT FIT may fix the symptom.
D-SHIFT	Using the ◀/▶/▲/▼ cursor buttons adjusts the picture position. • The D-SHIFT adjustment values are not valid when the D-ZOOM is set to 320 (full screen).

(continued on next page)

Item	Description
<p>PICTURE POSITION</p>	<p>Using the ▲/▼/◀/▶ cursor buttons selects the desirable picture position. The PICTURE POSITION is not changed if any of the following cases apply.</p> <ul style="list-style-type: none"> • There is no non-display area (black display or background display) or it is not displayed on the screen. • One of the following messages is displayed on the screen: "NO INPUT IS DETECTED" "SYNC IS OUT OF RANGE" "INVALID SCAN FREQ." • The BLANK or TEMPLATE function is selected.
<p>GEOMETRY CORRECTION</p>	<p>KEYSTONE Selecting this item displays the KEYSTONE dialog. For details, see KEYSTONE in Correcting the distortion (p.32).</p> <ul style="list-style-type: none"> • The adjustable range of this function will vary among inputs. For some inputs, this function may not work well. • When the zoom adjustment is set to the TELE (telephoto focus), this function may be excessive. This function should be used when the zoom adjustment is set to the full WIDE (wide-angle focus) whenever possible. • This function is unavailable when TRANSITION DETECTOR (p.88) is ON or the screen is adjusted by PERFECT FIT (p.33). <p>PERFECT FIT Selecting this item displays the PERFECT FIT dialog. For details, see PERFECT FIT in Correcting the distortion (p.33).</p> <ul style="list-style-type: none"> • This function is unavailable when TRANSITION DETECTOR (p.88) is ON or the screen is adjusted by KEYSTONE (p.32). <p>PATTERN Select PATTERN with ▲/▼ buttons. Displayed pattern [Off/1/2/3/4/5/6] can be switched with ◀/▶ buttons.</p> <p>PATTERN 1: Frame PATTERN 2: Red Grid PATTERN 3: Green Grid PATTERN 4: Blue Grid PATTERN 5: Vertical 9 steps PATTERN 6: Horizontal 9 steps OFF: Displays the input signal.</p>

(continued on next page)

Item	Description
<p>SETUP MEMORY</p>	<p>This projector has 3 memories for adjustment data (below).</p> <ul style="list-style-type: none"> • SETUP menu <ul style="list-style-type: none"> • D-ZOOM • D-SHIFT • PICT. POSIT. H •  KEYSTONE •  KEYSTONE • PERFECT FIT • IWB Calibration Data <p>Selecting a function using the ▲/▼ buttons and pressing the ► or ENTER button performs each function.</p> <p style="text-align: center;">  </p> <p><u>LOAD-1, LOAD-2, LOAD-3</u></p> <p>Performing a LOAD function loads the data from the memory linked in the number included in the function's name, and changes the setting mentioned above at the once.</p> <ul style="list-style-type: none"> • The LOAD functions whose linked memory has no data are skipped. • Remember that the current adjusted condition will be lost by loading data. If you want to keep the current adjustment, please save it before performing a LOAD function. • There may be some noise and the screen may flicker for a moment when loading data. This is not malfunction. • You can display SETUP MEMORY menu directly, using the MY BUTTON. Please see MY BUTTON item in OPTION menu ( 73). <p><u>SAVE-1, SAVE-2, SAVE-3</u></p> <p>Performing a SAVE function saves the current adjustment data into the memory linked in the number included in the function's name.</p> <ul style="list-style-type: none"> • Remember that the current data being stored of a memory will be lost by saving new data into the memory.

(continued on next page)

Item	Description
LIGHT & FILTER	<p>Using the ▲/▼ buttons switches the LIGHT OUTPUT. NORMAL ⇔ LONG LIFE 1 ⇔ LONG LIFE 2 ⇔ WHISPER </p> <ul style="list-style-type: none"> • When the ambient temperature is around 35 to 40°C, the brightness of light source is reduced automatically. • When NORMAL is selected, you can change the brightness. • LONG LIFE 1 and LONG LIFE 2 are specialized modes for long life of the light source. They restrict the brightness of a light source and perform appropriate cooling for the long life of a light source. • WHISPER is a specialized mode for low noise. It restricts the brightness of a light source. • When the vertical frequency of the input signal is 50Hz, the brightness of light source may be reduced automatically to reduce flicker. If you do not want to reduce the brightness, set FLICKER REDUCTION to OFF. (177) • The brightness of the light source may be reduced depending on the direction of the projection.
	<p>LIGHT SOURCE TIME</p> <p>The light source time is the usage time of the light source.</p>
	<p>FILTER TIME</p> <p>The filter time is the usage time of the air filter, counted after the last resetting. Pressing the RESET button on the remote control or the ► button of the projector displays a dialog. To reset the filter time, select the OK using the ► button. CANCEL ⇔ OK</p> <ul style="list-style-type: none"> • Please reset the filter time only when you have cleaned or replaced the air filter, for a suitable indication about the air filter. • For the air filter cleaning, see the section “Cleaning and replacing the air filter” (131).
	<p>FILTER MESSAGE</p> <p>Use the ▲/▼ button to set the timer for notifying by the message when to replace the filter unit After choosing an item except OFF, the message “REMINDER *** HRS PASSED” will appear after the timer reaches the interval time set by this feature (137). When the OFF is chosen, the message will not appear. Utilize this feature to keep the air filter clean, setting the suitable time according to your environment of this projector.</p> <ul style="list-style-type: none"> • Please take care of the filter unit periodically, even if there is no message. If the air filter becomes to be blocked by dust or other matter, the internal temperature will rise, which could cause malfunction, or reduce the lifetime of the projector. • Please be careful with the operating environment of the projector and the condition of the filter unit.

(continued on next page)

Item	Description
<p>INSTALLATION</p>	<p>Pressing the ► button displays the dialog for changing the INSTALLATION setting.</p>  <p>Use the ▲/▼ buttons to select the desired setting on the INSTALLATION dialog. This function is unavailable when TRANSITION DETECTOR (📖 88) is ON.</p>

(continued on next page)

Item	Description
<p>STANDBY MODE</p>	<p>Using ▲/▼ buttons switches the standby mode setting.</p> <p>QUICK START: For quick start-up (Standby power increases). When the projector is set to QUICK START and in standby mode, POWER/STATUS1 indicator blinks in Green 2 times for about 3 seconds. QUICK START is disabled in 30 minutes and the mode switches to NORMAL standby. In this case, POWER/STATUS1 indicator blinks in orange. Startup screen is not displayed when the projector is started in QUICK START. Fan operates while QUICK START is enabled.</p> <p>NORMAL: For using communication functions in the standby mode.</p> <p>NETWORK(WOL): For using Wake on LAN (WOL) function on wired network while reducing power consumption.</p> <p>SAVING: Reduces power consumption minimally.</p> <ul style="list-style-type: none"> • When NETWORK (WOL) or SAVING is selected, the following restrictions apply. <ul style="list-style-type: none"> - The RS-232C communication control except to turn the projector on are disabled while the projector is in the standby mode. If the COMMUNICATION TYPE in the COMMUNICATION menu is set to NETWORK BRIDGE, all of the RS-232C commands are disabled (☞ 79). - STANDBY OUTPUT is invalid. - The HDMI Link functions is disabled while the projector is in the standby mode. - SCHEDULE function (Ex. POWER-ON) in the standby mode will not be operated. - The MHL STANDBY PWR. menu cannot be operated and MHL power feeding is unavailable with standby mode (☞ 54). - It takes a while until the projector is available after starting up. • When NETWORK (WOL) is selected, only Wake on LAN (WOL) on wired LAN is accepted while the projector is in the standby mode. <ul style="list-style-type: none"> - CLONING load function is invalid while the projector is in standby mode.

(continued on next page)

Wake-On LAN (WOL) function

If you select NETWORK(WOL) in SETUP menu > STANDBY MODE, you can use the Wake-On LAN(WOL) function of wired network while saving power consumption in standby state.

Operation

Various communication functions can be used after the projector goes into NORMAL standby mode by receiving WOL Magic packet in standby state. However, the projector automatically goes back to NETWORK(WOL) standby mode with less power consumption if 10 minutes have passed after the projector goes into NORMAL standby mode by WOL Magic packet. It takes about 1 minute on a wired network or about 2 minutes on a wireless network until communication functions are available after WOL Magic packet has been received.

WOL Magic packet

Item	Specifications
Network	Wired network only
Protocol	UDP
Destination address	Broadcast address
Destination port number	Arbitrary
WOL Magic packet	A packet using MAC address of wired LAN of the projector (FF:FF:FF:FF:FF:FF(6 bytes)) followed by 102-byte data with MAC Address(6 bytes) repeated 16 times

(Example) WOL Magic packet for MAC Address: 01:02:03:04:05:06
 FF:FF:FF:FF:FF:FF: 01:02:03:04:05:06: 01:02:03:04:05:06: 01:02:03:04:05:06:
 01:02:03:04:05:06: 01:02:03:04:05:06: 01:02:03:04:05:06: 01:02:03:04:05:06:
 01:02:03:04:05:06: 01:02:03:04:05:06: 01:02:03:04:05:06: 01:02:03:04:05:06:
 01:02:03:04:05:06: 01:02:03:04:05:06: 01:02:03:04:05:06: 01:02:03:04:05:06:
 01:02:03:04:05:06:

NOTICE

Supported WOL Magic packet is a packet to be sent to broadcast address. General routers may not forward a packet of broadcast address to a device with a different network address by default. If you use a router like this, WOL function cannot be used for the projector that is not in the same network address. Consult with your network administrator about router settings. This function is available only in wired network and is not supported in wireless network.

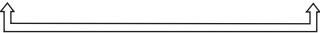
Item	Description
<p>OSD MESSAGE</p>	<p>Using the ▲/▼ buttons turns on/off the message function. NORMAL ↔ SILENT ↔ INHIBIT </p> <ul style="list-style-type: none"> ■NORMAL : OSD message is displayed normally. ■SILENT : The following message functions do not work. <ul style="list-style-type: none"> “AUTO IN PROGRESS” while automatically adjusting. “NO INPUT IS DETECTED” “SYNC IS OUT OF RANGE” “INVALID SCAN FREQ.” “NOT AVAILABLE” “Searching...” while searching for the input. “Detecting...” while an input signal is detected. The indication of the input signal displayed by changing. The indication of the aspect ratio displayed by changing. The indication of the PICTURE MODE displayed by changing. The indication of the MY MEMORY displayed by changing. The indication of “FREEZE” and “II” while freezing the screen by pressing the FREEZE button. The indication of the TEMPLATE displayed by changing. The indication of the LIGHT OUTPUT displayed by changing. ■INHIBIT : All message functions do not work. The available buttons are as follows. STANDBY, ON <p>* Use the OSD MSG button on the remote control to exit INHIBIT (⏏6).</p>
<p>STANDBY OUTPUT</p>	<p><u>AUDIO OUT</u> To select the sound output in the standby mode.</p> <ul style="list-style-type: none"> • When the STANDBY MODE is set to NETWORK(WOL) or SAVING, the STANDBY OUTPUT menu cannot be operated. • When the MHL STANDBY PWR. (⏏54) is set to OFF, MHL audio is unavailable in the standby mode.

AUDIO menu

From the AUDIO menu, items shown in the table below can be performed. Select an item using the ▲/▼ cursor buttons, and press the ► cursor button or the **ENTER** button to execute the item. Then perform it according to the following table.



Item	Description
VOLUME	Using the ◀/▶ buttons adjusts the volume. Low ⇄ High
SPEAKER	Using the ▲/▼ buttons turns on/off the built-in speaker. ON ⇄ OFF When OFF is selected, the built-in speaker does not work.
AUDIO SOURCE	<p>While the image signal from the input port chosen in step (1) is projected, the audio signal from the input port selected in step (2) is output to both the AUDIO OUT port and built-in speaker of this projector. However, the built-in speaker does not work when SPEAKER is set to OFF.</p> <p>(1) Choose a picture input port using the ▲/▼ buttons.</p> <p>(2) Select an audio input port or the mute icon using the ◀/▶ buttons. The icons indicate the following;</p> <div style="display: flex; justify-content: space-around;"> <div style="text-align: center;"> <p>No.1: AUDIO IN1 port</p> <p>No.3: AUDIO IN3 port</p> <p>No.5: USB TYPE B port</p> <p>No.7: HDMI 2 / MHL port</p> </div> <div style="text-align: center;"> <p>No.2: AUDIO IN2 port</p> <p>No.4: LAN port</p> <p>No.6: HDMI 1 port</p> <p>⌘: mutes the sound</p> </div> </div> <ul style="list-style-type: none"> • Audio input from port No.4 to 7 can only be selected by each of the picture input ports. • C.C. (Closed Caption) is automatically activated when ⌘ is selected and an input signal containing C.C. is received. This function is available only when the signal is NTSC for VIDEO or 480i@60 for COMPUTER IN1 or COMPUTER IN2, and when AUTO is selected for DISPLAY in the C.C. menu under the SCREEN menu (▶ 68).



SCREEN menu

From the SCREEN menu, items shown in the table below can be performed.

Select an item using the ▲/▼ cursor buttons, and press the ► cursor button or **ENTER** button to execute the item. Then perform it according to the following table.





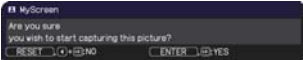
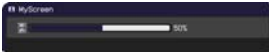

Item	Description
LANGUAGE	<p>Using the ▲/▼/◀/▶ buttons switches the OSD (On Screen Display) language.</p> <p>ENGLISH ⇄ FRANÇAIS ⇄ DEUTSCH ⇄ ESPAÑOL ↑ (shown in the LANGUAGE dialog) ↓</p> <p>Press the ENTER or OK button to save the language setting.</p>
MENU POSITION	<p>Using the ▲/▼/◀/▶ buttons adjusts the menu position. To quit the operation, press the MENU button on the remote control or keep no operation for about 10 seconds.</p>
BLANK	<p>Using the ▲/▼ buttons switches the mode for the blank screen. The blank screen is a screen for the temporarily blanking feature (📖 36). It is displayed by pressing the BLANK button on the remote control.</p> <p>MyScreen ⇄ ORIGINAL ⇄ BLUE ⇄ WHITE ⇄ BLACK ↑ ↓</p> <p><u>MyScreen</u> : Screen can be registered by the MyScreen item (📖 65). <u>ORIGINAL</u> : Screen preset as the standard screen. <u>BLUE, WHITE, BLACK</u> : Plain screens in each color.</p> <ul style="list-style-type: none"> • To avoid remaining as an afterimage, the MyScreen or ORIGINAL screen will change to the plain black screen after several minutes.
AUTO BLANK	<p>Using the ▲/▼ buttons switches the mode for the AUTO BLANK screen.</p> <p>BLUE ⇄ WHITE ⇄ BLACK ↑ ↓</p> <ul style="list-style-type: none"> • To avoid remaining as an afterimage, displayed image will change to the designated blank color screen by AUTO BLANK after several minutes in the following conditions. <ul style="list-style-type: none"> - When MyScreen or ORIGINAL is displayed as BLANK screen. - When start-up screen is displayed.

(continued on next page)

Item	Description
START UP	<p>Using the ▲/▼ buttons switches the mode for the start-up screen. The start-up screen is a screen displayed when no signal or an unsuitable signal is detected.</p> <p>MyScreen ⇄ ORIGINAL ⇄ OFF</p>  <p><u>MyScreen</u> : Screen can be registered by the MyScreen item (65). <u>ORIGINAL</u> : Screen preset as the standard screen. <u>OFF</u> : Plain black screen.</p> <ul style="list-style-type: none"> • To avoid remaining as an afterimage, the MyScreen or ORIGINAL screen will change to the AUTO BLANK screen (64) after several minutes. • When the ON is selected to the MyScreen PASSWORD item in the SECURITY menu (86), the START UP is fixed to MyScreen.
MyScreen	<p>This item allows you to capture an image for use as a MyScreen image which can be used as the BLANK screen and START UP screen. Display the image you want to capture before executing the following procedure.</p> <p>Selecting this item displays a dialog titled “MyScreen”. It will ask you if you start capturing an image from the current screen.</p>  <p>Please wait for the target image to be displayed, and press the ENTER or ↵ button to start registration.</p> <p>To restore the screen and return to the previous dialog, press the RESET button on the remote control.</p>  <p>Registration may take several minutes.</p> <p>When the registration is completed, the registered screen and the following message is displayed for several seconds: “MyScreen registration is finished.”</p> <p>If the registration failed, the following message is displayed: “A capturing error has occurred. Please try again.”</p> <ul style="list-style-type: none"> • This function cannot be selected when the ON is selected to the MyScreen Lock item (66). • This function cannot be selected when the ON is selected to the MyScreen PASSWORD item in SECURITY menu (86). • This function is unavailable for a signal from the LAN, USB TYPE A, USB TYPE B, HDMI 1 or HDMI 2 / MHL port.

(continued on next page)

Item	Description
MyScreen Lock	<p>Using the ▲/▼ buttons turns on/off the MyScreen lock function. ON ⇄ OFF</p> <p>When the ON is selected, the item MyScreen is locked. Use this function for protecting the current MyScreen.</p> <ul style="list-style-type: none"> This function cannot be selected when the ON is selected to the MyScreen PASSWORD item in SECURITY menu (P.86).
SOURCE NAME	<p>Each input port for this projector can have a name applied to it.</p> <ol style="list-style-type: none"> Use the ▲/▼ buttons on the SCREEN menu to select SOURCE NAME and press the ► or ENTER button. The SOURCE NAME menu will be displayed. Use the ▲/▼ buttons on the SOURCE NAME menu to select the port to be named and press the ► button. The SOURCE NAME dialog will be displayed. Right side of the menu is blank until a name is specified.  Select an icon you would like to assign to the port in the SOURCE NAME dialog. The name assigned to the port will also be automatically switched according to your icon selection. Press the ENTER or ESC button to determine your icon selection.  Select a number you would like to assign to the port along with the icon. You can select the number either from blank (no number assigned), 1, 2, 3, or 4. Then press the ENTER or ESC button.  If you would like to modify the name assigned to the port, select CUSTOM NAME and press the ENTER or ESC button. 

(continued on next page)

Item	Description
<p>SOURCE NAME (continued)</p>	<p>(6) The current name will be displayed on the first line. Use the ▲/▼/◀/▶ buttons and the ENTER or ↵ button to select and enter characters. To erase 1 character at one time, press the RESET button or press the ◀ and ↵ button at the same time. Also if you move the cursor to DELETE or CLEAR ALL on screen and press the ENTER or ↵ button, 1 character or all characters will be erased. The name can be a maximum of 16 characters.</p> <p>(7) To change an already inserted character, press the ▲ button to move the cursor to the first line, and use the ◀/▶ buttons to move the cursor on the character to be changed. After pressing the ENTER or ↵ button, the character is selected. Then, follow the same procedure as described at the item (6) above.</p> <p>(8) To finish entering text, move the cursor to the OK on screen and press the ▶, ENTER or ↵ button. To revert to the previous name without saving changes, move the cursor to the CANCEL on screen and press the ◀, ENTER or ↵ button.</p> 
<p>TEMPLATE</p>	<p>Using the ▲/▼ cursor buttons switches the mode for the template screen. Press the ▶ cursor (or the ENTER) button to display the selected template, and press the ◀ cursor button to close the displayed screen.</p>

(continued on next page)

Item	Description
<p style="text-align: center;">C.C. (Closed Caption)</p>	<p>The C.C. is the function that displays a transcript or dialog of the audio portion of a video, files or other presentation or other relevant sounds. It is required to have NTSC format video or 480i@60 format component video source supporting C.C. feature to utilize this function.</p> <p>It may not work properly, depending on equipment or signal source. In this case, please turn off the Closed Caption.</p> <ul style="list-style-type: none"> • This function will be unavailable when the PJ internal Painter mode (🎨 102) is operating.
	<p>DISPLAY</p> <p>Select Closed Caption DISPLAY setting from the following options using the ▲/▼ buttons.</p> <p style="text-align: center;">AUTO ⇄ ON ⇄ OFF ↑—————↓</p> <p><u>AUTO</u> : Closed Caption automatically appears when the input signal (C.C. compatible) from the port with the mute icon set at AUDIO SOURCE is selected.</p> <p><u>ON</u> : Closed Caption is on.</p> <p><u>OFF</u> : Closed Caption is off.</p> <ul style="list-style-type: none"> • The caption is not displayed when the OSD menu is active. • The Closed Caption is the function to display the dialogue, narration, and / or sound effects of a television program or other video sources. The Closed Caption availability is depending upon broadcaster and/or content.
	<p>MODE</p> <p>Select Closed Caption MODE setting from the following options using the ▲/▼ buttons.</p> <p style="text-align: center;">CAPTIONS ⇄ TEXT</p> <p><u>CAPTIONS</u> : Display Closed Caption.</p> <p><u>TEXT</u> : Display Text data, which is for additional information such as news reports or a TV program guide. The information covers the entire screen. Not all of the C.C. program has Text information.</p>
	<p>CHANNEL</p> <p>Select Closed Caption CHANNEL from the following options using ▲/▼ buttons.</p> <p style="text-align: center;">1 ⇄ 2 ⇄ 3 ⇄ 4 ↑—————↓</p> <p><u>1</u>: Channel 1, primary channel / language <u>2</u>: Channel 2 <u>3</u>: Channel 3 <u>4</u>: Channel 4</p> <p>The channel data may vary, depending on the content. Some channel might be used for secondary language or empty.</p>





OPTION menu

From the OPTION menu, items shown in the table below can be performed.

Select an item using the ▲/▼ cursor buttons, and press the ► cursor button or **ENTER** button to execute the item. Then perform it according to the following table.





Item	Description
<p>SEARCH SKIP</p>	<p>The ports can be set to be ignored in searching by the AUTO SEARCH function (see below).</p>  <p>(1) Choose a picture input port using the ▲/▼ buttons. (2) Using the ◀/▶ buttons turns on/off the SEARCH SKIP function. NORMAL ⇔ SKIP The port that is set to SKIP will be ignored.</p> <ul style="list-style-type: none"> • It is not possible to set SKIP to all ports at the same time.
<p>AUTO SEARCH</p>	<p>Using the ▲/▼ buttons turns on/off the automatic signal search function. ON ⇔ OFF</p> <p>When the ON is selected, detecting no signal automatically cycles through input ports in the following order. The search is started from the current port. Then when an input is found, the projector will stop searching and display the image.</p> <p>  </p> <ul style="list-style-type: none"> • It may take several seconds to project the images from the USB TYPE B port.

(continued on next page)

Item	Description
<p>DIRECT POWER ON</p>	<p>Using the ▲/▼ buttons turns on/off the DIRECT POWER ON function.</p> <p>ON ⇔ OFF</p> <p>When set to the ON, the light source in projector will be automatically turned on without the usual procedure (p.25), only when the projector is supplied with the power after the power was cut while the light source was on.</p> <ul style="list-style-type: none"> • This function does not work as long as the power has been supplied to the projector while the light source is off. • After turning the light source on by the DIRECT POWER ON function, if neither input nor operation is detected for about 30 minutes, the projector is turned off, even if the AUTO POWER OFF function (p.71) is disabled. <p>⚠ WARNING ▶ Be sure to confirm that the projector has been installed and connected safely even if it is turned on automatically.</p>
<p>AUTO POWER ON</p>	<p>When the projector is in the standby mode and detects the video signal input from external device, this function starts up the projector to display the image automatically on the screen. This function can be enabled by selecting an input referring to the displayed list.</p> <ul style="list-style-type: none"> • This function is unavailable when STANDBY MODE is set to NETWORK(WOL) or SAVING. • This function may work unintentionally by connected external device. <p>⚠ WARNING ▶ When this function is enabled, the projector may turn on unintentionally by operating the device connected to it. Be sure not to put anything on or around the projector.</p> <p>▶ Be sure to confirm that the projector has been installed and connected safely even if it is turned on automatically.</p>

(continued on next page)

Item	Description
<p>AUTO POWER OFF</p>	<p>Using the ▲/▼ buttons adjusts the time to count down to automatically turn the projector off.</p> <p>Long (max. 99 minutes) ⇔ Short (min. 0 minute = DISABLE)</p> <div style="display: flex; justify-content: space-around; align-items: center;">   </div> <p>When the time is set to 0, the projector is not turned off automatically. When the time is set to 1 to 99, and when the passed time with no-signal or an unsuitable signal reaches at the set time, the light source will be turned off.</p> <p>If one of the projector's buttons or the remote control buttons is pressed or one of the commands (except get commands) is transmitted to the CONTROL port during the corresponding time, projector will not be turned off.</p> <p>Please refer to the section “Turning off the power” (26).</p>

(continued on next page)

Item	Description
<p>MY BUTTON</p>	<p>This item is to assign one of the following functions to MY BUTTON 1/2 on the remote control (📖 6).</p> <p>(1) Use the ▲/▼ buttons on the MY BUTTON menu to select a MY BUTTON - (1/2).</p> <p>(2) Then using the ◀/▶ buttons sets one of the following functions to the chosen button.</p> <ul style="list-style-type: none"> • COMPUTER IN1: Selects the input from COMPUTER IN1 port. • COMPUTER IN2: Selects the input from COMPUTER IN2 port. • LAN: Selects input from LAN port. • USB TYPE A: Selects input from USB TYPE A port. • USB TYPE B: Selects input from USB TYPE B port. • HDMI1: Selects input from HDMI 1 port. • HDMI2/MHL: Selects input from HDMI 2 / MHL port. • VIDEO: Selects the input from VIDEO port. • SLIDESHOW: Selects the input from USB TYPE A, and starts a Slideshow. • MY IMAGE: Displays the MY IMAGE menu. • MESSENGER: Turns the messenger text displayed on the screen on/off (Messenger Function in the Network Guide). <p>When there is no transferred text data to display, the message "NO MESSENGER DATA" appears.</p> <ul style="list-style-type: none"> • INFORMATION: Displays SYSTEM_INFORMATION, INPUT_INFORMATION (📖 83), WIRELESS INFORMATION, WIRED INFORMATION or nothing. • MY MEMORY: Loads one of adjustment data stored (📖 46). <p>When more than two data are saved, the adjustment changes every time the MY BUTTON is pressed.</p> <p>When no data is saved in memory, the dialog "No saved data" appears.</p> <p>When the current adjustment is not saved to memory, the dialog as shown in the right appears.</p>  <p>If you want to keep the current adjustment, please press the ▶ button to exit. Otherwise loading data will overwrite the current adjusted condition.</p> <ul style="list-style-type: none"> • PICTURE MODE: Changes the PICTURE MODE (📖 40). • FILTER RESET: Displays the filter time reset confirmation dialogue (📖 58). • TEMPLATE: Makes the template pattern selected to the TEMPLATE item (📖 67) appear or disappear. • AV MUTE: Turns the picture and audio on/off. <p>(continued on next page)</p>

(continued on next page)

Item	Description							
MY BUTTON (continued)	<ul style="list-style-type: none"> • RESOLUTION: Turns on/off the RESOLUTION dialog (📖 53). • LIGHT OUTPUT: Changes the LIGHT OUTPUT (📖 58). • HDCR: Turns on/off the HDCR dialog (📖 46). • ACCENTUALIZER: Turn on/off the ACCENTUALIZER dialog (📖 46). • MY BUTTON: Turn on/off the MY BUTTON dialog (📖 72). • SETUP MEMORY: Displays the SETUP MEMORY menu (📖 57). • FINGER TOUCH: Turns on/off the FINGER TOUCH dialog (📖 96) 							
SCHEDULE	<p>■ How to setup the item</p> <ol style="list-style-type: none"> 1. Use the ▲/▼/◀/▶ cursor buttons to select or adjust. 2. Select OK to finish the settings. <div style="border: 1px solid black; padding: 5px; margin-top: 10px;"> <p>NOTE • Please refer to the actual on-screen display(OSD) for appropriate operation.</p> </div>							
	<table border="1" style="width: 100%; border-collapse: collapse;"> <thead> <tr> <th style="width: 30%;">Item</th> <th>Description</th> </tr> </thead> <tbody> <tr> <td>DATE AND TIME</td> <td>Inputs the current date (year/month/day) and the time (24-hour clock) to set a reference time in the projector.</td> </tr> <tr> <td>SPECIFIC DATE</td> <td>Specifies the date (month/day) if you execute only one specific day. You can set 10 different schedules from SPECIFIC DATE-1 to SPECIFIC DATE-10.</td> </tr> <tr> <td>PROGRAM EDIT</td> <td>Sets what event to execute at what time of the day. One program can be set in one day, and up to 16 programs can be set. Up to 20 events can be set in one program.</td> </tr> </tbody> </table> <p>■ Setting procedure</p> <ol style="list-style-type: none"> ① Determine the current date/time as reference in DATE AND TIME. ② Make a schedule of what event to execute at what time of the day in PROGRAM EDIT. ③ Select the date (one specific day: SPECIFIC DATE or the days of the week: every week) to be scheduled, then select a program. <p>Switch the screen of the days of the week and SPECIFIC DATE by vertical scroll.</p> <p>(Page 1 of 2: Days of the week, Page 2 of 2: SPECIFIC DATE)</p>	Item	Description	DATE AND TIME	Inputs the current date (year/month/day) and the time (24-hour clock) to set a reference time in the projector.	SPECIFIC DATE	Specifies the date (month/day) if you execute only one specific day. You can set 10 different schedules from SPECIFIC DATE-1 to SPECIFIC DATE-10.	PROGRAM EDIT
Item	Description							
DATE AND TIME	Inputs the current date (year/month/day) and the time (24-hour clock) to set a reference time in the projector.							
SPECIFIC DATE	Specifies the date (month/day) if you execute only one specific day. You can set 10 different schedules from SPECIFIC DATE-1 to SPECIFIC DATE-10.							
PROGRAM EDIT	Sets what event to execute at what time of the day. One program can be set in one day, and up to 16 programs can be set. Up to 20 events can be set in one program.							

(continued on next page)

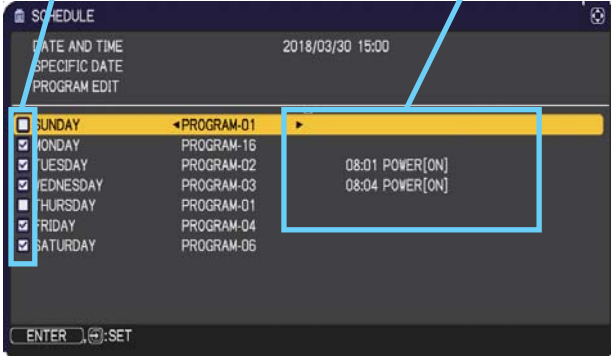

Item	Description
<p>SCHEDULE (continued)</p>	<p>■ How to activate(DATE AND TIME / SPECIFIC DATE) Place a check mark in the box.</p> <p>Check mark in the box</p> <p>Date and first setup info could be seen with the check mark.</p> 
	<p>1/2 page (Set the DATE(Year/Month/Date) and Time(24-hour scale).)</p> <p>Check mark in the box</p> <p>Date and first setup info could be seen with the check mark.</p>  <p>2/2 page (Set specific date from 1 to 10.)</p> <p>Press the ▼ cursor button to move from 1/2 page to 2/2 page with the state of selecting "SATURDAY".</p>

(continued on next page)

Item	Description
<p>SCHEDULE (continued)</p>	<p>■ PROGRAM EDIT The TIME and EVENT for Program 1 to 16 can be edited.</p> <ul style="list-style-type: none"> • RETURN Select this to go back to the top menu of the SCHEDULE. • SELECT Select from PROGRAM-01 to 16 to edit. Up to 20 events can be set in each program. • COPY TO The selected program (with the settings of TIME and EVENT) can be copied to other program. • APPLY Select this to apply and save all adjustments and settings. <p>⚠ WARNING ▶ Be sure to confirm that the projector has been installed and connected safely even if it is turned on automatically.</p>



(continued on next page)

Item	Description
<p>SCHEDULE (continued)</p>	<p>■ How to edit the selected PROGRAM</p> <ol style="list-style-type: none"> Select from 1 to 20 events. Use the ▲/▼ cursor buttons to select. Press the ► cursor button to set the TIME and EVENT. Use the ◀/▶ cursor buttons to select. Use the ▲/▼ cursor buttons to adjust.  <p>EVENT can be selected as listed below.</p> <ul style="list-style-type: none"> ◦ POWER – ON, STANDBY ◦ INPUT SOURCE – "input source" channel ◦ MY IMAGE – IMAGE-1 to 4, IMAGE OFF ◦ MESSENGER – TEXT-1 to 12, TEXT OFF ◦ LIGHT OUTPUT – NORMAL, LONG LIFE1, LONG LIFE2, WHISPER ◦ BLANK – ON, OFF ◦ SLIDESHOW - START, STOP  <ol style="list-style-type: none"> Press the ► cursor button to finish the settings. Select APPLY to save the settings. <div style="border: 1px solid black; padding: 10px; margin-top: 10px;"> <p>NOTE</p> <ul style="list-style-type: none"> • Please refer to the actual on-screen display(OSD) for appropriate operation. • When the STANDBY MODE is set to NETWORK(WOL) or SAVING, SCHEDULE function (Ex:POWER-ON) at STANDBY MODE will not be operated. </div>



(continued on next page)

Item	Description
SERVICE	<p>Selecting this item displays the SERVICE menu.</p> <p>Select an item using the ▲/▼ buttons, and press the ► button or the ENTER button on the remote control to execute the item.</p> 
	<p>ALTITUDE</p> <p>Using the ▲/▼ buttons switches the rotation speed of the cooling fans. If the projector is used at an altitude of about 1600 m or higher, select HIGH. Otherwise, select AUTO. Note that the projector is noisier when the HIGH is selected.</p> <p>HIGH ⇄ AUTO</p>
	<p>AUTO ADJUST</p> <p>Using the ▲/▼ buttons to select one of the mode. When the DISABLE is selected, the automatic adjustment feature is disabled.</p> <p>FINE ⇄ FAST ⇄ DISABLE</p> <p style="text-align: center;">↑—————↑</p> <p><u>FINE</u>: Finer tuning including H.SIZE adjustment. <u>FAST</u>: Faster tuning, setting H.SIZE to prearranged data for the input signal.</p> <ul style="list-style-type: none"> • Depending on conditions, such as input image, signal cable to the projector, environment around the projector, etc., the automatic adjustment may not work correctly. In such a case, please choose DISABLE to disable the automatic adjustment, and make adjustment manually.
	<p>GHOST</p> <p>Adjust the settings using the ▲/▼ buttons to eliminate ghosting.</p>
	<p>FLICKER REDUCTION</p> <p>ON ⇄ OFF</p> <p>When this function is enabled, flicker of vertical frequency 50Hz signals is reduced. The brightness of the light source is reduced.</p>

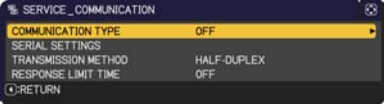
(continued on next page)

Item	Description
<p>SERVICE (continued)</p>	<p>KEY LOCK (1) Use the ▲/▼ buttons to select CONTROL PANEL or REMOTE CONTROL. (2) Use the ◀/▶ buttons to turn the key lock function on/off. When ON is selected, all buttons on the projector or remote control except the STANDBY/ON button are locked. • Please use this function to prevent tampering or accidental operation. • It is not possible to set both CONTROL PANEL and REMOTE CONTROL to ON.</p> <p>REMOTE FREQ. (1) Use the ▲/▼ button to change the projector's remote sensor frequency setting (📺22). 1:NORMAL ⇔ 2:HIGH (2) Use the ◀/▶ button to change the projector's remote sensor on or off. ON ⇔ OFF</p> <p>If the remote control does not function correctly, disable either of them. It is not possible to disable both options at the same time.</p> 
	<p>COMMUNICATION</p> <p>Selecting this item displays COMMUNICATION menu. In this menu, you can configure the serial communication settings of the projector using the CONTROL port.</p>  <ul style="list-style-type: none"> • Select an item using the cursor buttons ▲/▼. Then pressing the ▶ button opens the submenu for the setting item you selected. Or, pressing the ◀ button instead of the ▶ button makes the menu back to the previous one without changing the setup. Each submenu can be operated as described above. • For the function of serial communication, refer to the Network Guide.



(continued on next page)

Item	Description	
SERVICE (continued)	COMMUNICATION (continued)	<p>COMMUNICATION TYPE Select the communication type for transmission via the CONTROL port. <u>NETWORK BRIDGE</u>: Select this type, if it is required to control an external device as a network terminal, via this projector from the computer. The CONTROL port does not accept RS-232C commands ( Network Bridge Function in the Network Guide) <u>OFF</u>: Select this mode to receive RS-232C commands using the CONTROL port.</p> <ul style="list-style-type: none"> • OFF is selected as the default setting. • When you select the NETWORK BRIDGE, check the item, TRANSMISSTION METHOD ( <i>below</i>).
		<p>SERIAL SETTINGS Select the serial communication condition for the CONTROL port.</p> <p>BAUD RATE 4800bps ⇔ 9600bps ⇔ 19200bps ⇔ 38400bps ↑ ↑ ↑</p> <p>PARITY NONE ⇔ ODD ⇔ EVEN ↑ ↑</p>
		<p>TRANSMISSION METHOD Select the transmission method for communication by the NETWORK BRIDGE from the CONTROL port. HALF-DUPLEX ⇔ FULL-DUPLEX <u>HALF-DUPLEX</u>: This method lets the projector make two-way communication, but only one direction, either transmitting or receiving data, is allowed at a time. <u>FULL-DUPLEX</u>: This method lets the projector make two-way communication, transmitting and receiving data at the same time.</p> <ul style="list-style-type: none"> • HALF-DUPLEX is selected as the default setting. • If you select HALF-DUPLEX, check the setting of the item RESPONSE LIMIT TIME ( 80).

(continued on next page)

Item	Description	
<p>SERVICE (continued)</p>	<p>COMMUNICATION (continued)</p>	<p>RESPONSE LIMIT TIME Select the time period to wait for receiving response data from other device communicating by the NETWORK BRIDGE and the HALF-DUPLEX through the CONTROL port.</p> <p>OFF ⇔ 1s ⇔ 2s ⇔ 3s </p> <p>OFF: Select this mode if it is not required to check the responses from the device that the projector sends data to. In this mode, the projector can send out data from the computer continuously.</p> <p>1s /2s /3s: Select the time period to keep the projector waiting for response from the device that the projector sends data to. While waiting the response, the projector does not send out any data from the CONTROL port.</p> <ul style="list-style-type: none"> • This menu is available only when the NETWORK BRIDGE is selected for the COMMUNICATION TYPE and the HALF-DUPLEX is selected for the TRANSMISSION METHOD (79). • OFF is selected as the default setting.
	<p>CLONING</p>	<p>The settings of the projector can be copied via USB memory (118).</p> <p>SAVE: Saves each setting of the projector to USB memory.</p> <p>LOAD: Loads each setting of the projector from USB memory. Message will be displayed after loading, and power will turn off after five minutes or by pressing the ► button. (A message is displayed for a few seconds if loading fails.)</p> <p>After saving / loading, you can remove the USB storage device.</p>



(continued on next page)

Item	Description	
SERVICE (continued)	CLONING (continued)	<p>The following items are exempted.</p> <p>IWB: CALIBRATE SETUP SETUP: SETUP MEMORY, LIGHT SOURCE TIME, FILTER TIME OPTION: SCHEDULE_DATE AND TIME, SERVICE(GHOST) NETWORK: PROJECTOR NAME WIRELESS SETUP (SIMPLE ACCESS POINT), WIRELESS SETUP (INFRASTRUCTURE) AND WIRED SETUP (IP ADDRESS, SUBNET MASK) MY IMAGE, OTHER OPERATION</p> <p>SECURITY: MY TEXT DISPLAY</p> <ul style="list-style-type: none"> • Operation is not available if SECURITY_CLONING LOCK is ON. • The Screen_MyScreen can only be loaded. <p><u>CLONING load function on STANDBY MODE</u></p> <ul style="list-style-type: none"> • While the projector is in STANDBY MODE, press the  button of control panel together with the  button, and then press the  button to start operating the CLONING load function. • During loading process, POWER/STATUS1 indicator lights in orange and STATUS2 indicator lights in red. • After the loading process, POWER/STATUS1 indicator blinks 10 times and STATUS2 indicator is off. • If the loading fails (CLONING LOCK is ON), POWER/STATUS1 indicator blinks 10 times and STATUS2 indicator blinks 3 times. • If the loading fails (CLONING LOCK is OFF), POWER/STATUS1 indicator blinks 10 times and STATUS2 indicator blinks 2 times. • CLONING is invalid with the following conditions. <ul style="list-style-type: none"> - CLONING LOCK is ON. - If the STANDBY MODE is set to SAVING/NETWORK(WOL). - If there is no USB memory inserted into USB TYPE A port. - If PIN LOCK or lock of TRANSITION DETECTOR is not being released. - If a system error occurs.

(continued on next page)

Item	Description
<p style="text-align: center;">SERVICE (continued)</p>	<p style="text-align: center;">CLONING (continued)</p> <ul style="list-style-type: none"> • Please operate one of the following after loading. - Press the  button and ◀ button of the control panel at the same time. - Wait at least five minutes after loading. - Restart the projector after re-plugging the AC cable. <p><u>Load MyScreen data</u></p> <ul style="list-style-type: none"> • Please save the image data as "pj_logo.bmp" or "pj_logo.gif" into USB memory. • Please note that the only compatible formats are as follows. -File format <ul style="list-style-type: none"> <u>Windows BMP</u> bit/pixel: 4/8/16/24/32bit <u>Compression format</u> : Without compression/RLE/GIF -Image size: more than 36x36, less than 1280x800 • If two kinds of file format are saved, "pj_logo.bmp" will be registered into MyScreen data. • If MyScreen LOCK or MyScreen PASSWORD is ON, the data of MyScreen cannot be loaded. <p><u>Setting the data</u></p> <ul style="list-style-type: none"> • Operating the SAVE function under CLONING will name the file as "pj_data.bin" into the USB memory. Please do not attempt to change the file name or the folder structure. • If a file with the same name already exists, it will be overwritten by operating the SAVE function. <p><u>Loading function</u></p> <ul style="list-style-type: none"> • Please note that saved data from other model cannot be loaded. • Please note that, if any of the following functions: MyScreen PASSWORD, PIN LOCK, TRANSITION DETECTOR, MY TEXT PASSWORD under SECURITY menu or MyScreen Lock under SCREEN menu is ON, the respective saved data cannot be loaded. • Note that the saved setting of KEYSTONE and PERFECT FIT cannot be loaded when TRANSITION DETECTOR is ON.

(continued on next page)

Item	Description	
SERVICE (continued)	CLONING (continued)	<p><u>Loading function (continued)</u></p> <ul style="list-style-type: none"> • Please note that the saved data of START UP and MyScreen Lock under SCREEN menu cannot be loaded if MyScreen PASSWORD under SECURITY menu is ON. • Please note that the saved data of MY TEXT WRITING cannot be loaded if MY TEXT PASSWORD under SECURITY menu is ON.
	INFORMATION	<p>Selecting this item displays a dialog titled "INPUT_INFORMATION". It shows the information about the current input.</p> <div style="display: flex; justify-content: space-around; align-items: center;">    </div> <ul style="list-style-type: none"> • The "FRAME LOCK" message on the dialog means the frame lock function is working. • This item cannot be selected for no signal and sync out. • When the MY TEXT DISPLAY is set to ON, the MY TEXT is displayed together with the input information in the INPUT_INFORMATION box (📄 90).
		FACTORY RESET

NETWORK menu

See the **Network Guide** for details of NETWORK operation.

Remember that incorrect network settings on this projector may cause trouble on the network. Be sure to consult with your network administrator before connecting to an existing access point on your network.

SECURITY menu

This projector is equipped with security functions.

From the SECURITY menu, items shown in the table below can be performed.

To use SECURITY menu: User registration is required before using the security functions.

Enter to the SECURITY menu

1. Press the ► button. The ENTER PASSWORD box will be displayed.
2. Use the ▲/▼/◀/▶ buttons to enter the registered password. The factory default password is as follows.

8133WISS/8142WISS:1746

This password can be changed ([below](#)). Move the cursor to the right side of the ENTER PASSWORD box and press the ► button to display the SECURITY menu.

- It is strongly recommended the factory default password to be changed as soon as possible.
 - If an incorrect password is input, the ENTER PASSWORD box will be displayed again. If incorrect password is input 3 times, the projector will turn off. Afterwards the projector will turn off every time an incorrect password is input.
3. Items shown in the table below can be performed.



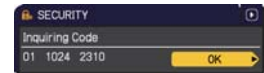
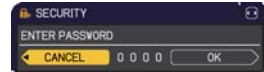

If you have forgotten your password

- (1) While the ENTER PASSWORD box is displayed, press and hold the **RESET** button on the remote control for about 3 seconds or press and hold the  button for 3 seconds while pressing the ► button on the projector.
 - (2) The 10 digit Inquiring Code will be displayed. Contact your dealer with the 10 digit Inquiring Code. Your password will be sent after your user registration information is confirmed.
- If there is no key input for about 55 seconds while the Inquiring Code is displayed, the menu will close. If necessary, repeat the process from (1).



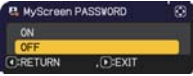

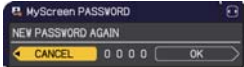
Item	Description
SECURITY PASSWORD CHANGE	<ol style="list-style-type: none"> (1) Use the ▲/▼ buttons on the SECURITY menu to select SECURITY PASSWORD CHANGE and press the ► button to display the ENTER NEW PASSWORD box.  (2) Use the ▲/▼/◀/▶ buttons to enter the new password. (3) Move the cursor to the right side of the ENTER NEW PASSWORD box and press the ► button to display the NEW PASSWORD AGAIN box, enter the same password again.  (4) Move the cursor to the right side of the NEW PASSWORD AGAIN box and press the ► button and the NOTE NEW PASSWORD box will be displayed for about 30 seconds, please make a note of the password during this time. Pressing the ENTER button on the remote control or ► button on the projector will close the NOTE NEW PASSWORD box.  <ul style="list-style-type: none"> • Please do not forget your password.





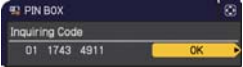

(continued on next page)

Item	Description
<p>MyScreen PASSWORD</p>	<p>The MyScreen PASSWORD function can be used to prohibit access to the MyScreen function and prevent the currently registered MyScreen image from being overwritten.</p> <p>1 Turning on the MyScreen PASSWORD</p> <p>1-1 Use the ▲/▼ buttons on the SECURITY menu to select MyScreen PASSWORD and press the ► button to display the MyScreen PASSWORD on/off menu.</p>  <p>1-2 Use the ▲/▼ buttons on the MyScreen PASSWORD on/off menu to select ON. The ENTER NEW PASSWORD box (small) will be displayed.</p>  <p>1-3 Use the ▲/▼/◀/▶ buttons to enter the password. Move the cursor to the right side of the ENTER NEW PASSWORD box (small) and press the ► button to display the NEW PASSWORD AGAIN box, enter the same PASSWORD again.</p>  <p>1-4 Move the cursor to the right side of the NEW PASSWORD AGAIN box and press the ► button to display the NOTE NEW PASSWORD box for about 30 seconds, please make a note of the password during this time.</p>  <p>Pressing the ENTER button on the remote control or the ► button on the projector will return to MyScreen PASSWORD on/off menu.</p> <p>When a password is set for MyScreen:</p> <ul style="list-style-type: none"> • The MyScreen registration function (and menu) will be unavailable. • The MyScreen Lock menu will be unavailable. • The START UP setting will be locked on MyScreen (and the menu will be unavailable). <p>Turning the MyScreen PASSWORD off will allow normal operation of these functions.</p> <ul style="list-style-type: none"> • Please do not forget your MyScreen PASSWORD. <p>2 Turning off the MyScreen PASSWORD</p> <p>2-1 Follow the procedure in 1-1 to display the MyScreen PASSWORD on/off menu.</p> <p>2-2 Select OFF to display the ENTER PASSWORD box (large). Enter the registered password and the screen will return to the MyScreen PASSWORD on/off menu.</p>  <p>If an incorrect PASSWORD is input, the menu will close. If necessary, repeat the process from 2-1.</p> <p>3 If you have forgotten your password</p> <p>3-1 Follow the procedure in 1-1 to display the MyScreen PASSWORD on/off menu.</p> <p>3-2 Select OFF to display the ENTER PASSWORD box (large). The 10 digit Inquiring Code will be displayed inside the box.</p> <p>3-3 Contact your dealer with the 10 digit Inquiring Code. Your password will be sent after your user registration information is confirmed.</p>

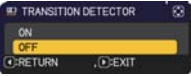

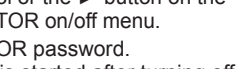

(continued on next page)

Item	Description
PIN LOCK	<p>PIN LOCK is a function which prevents the projector from being used unless a registered Code is input.</p> <p>1 Turning on the PIN LOCK</p> <p>1-1 Use the ▲/▼ buttons on the SECURITY menu to select PIN LOCK and press the ► button or the ENTER button to display the PIN LOCK on/off menu.</p>  <p>1-2 Use the ▲/▼ buttons on the PIN LOCK on/off menu to select ON and the Enter PIN Code box will be displayed.</p>  <p>1-3 Input a 4 part PIN code using the ▲/▼/◀/▶, INPUT or -> button. The PIN Code again box will appear. Reenter the same PIN code. This will complete the PIN code registration.</p>  <ul style="list-style-type: none"> • If there is no key input for about 55 seconds while the Enter PIN Code box or the PIN Code again box is displayed, the menu will close. If necessary, repeat the process from 1-1. <p>Afterwards, anytime the projector is restarted after AC power is turned off the Enter PIN Code box will be displayed. Enter the registered PIN code. The projector can be used after entering the registered PIN code. If an incorrect PIN code is input, the Enter PIN code box will be displayed again. If an incorrect PIN code is input 3 times, the projector will turn off. Afterwards the projector will turn off every time an incorrect PIN code is input. The projector will also turn off if there is no key input for about 5 minutes while the Enter PIN code box is displayed. This function will activate only when the projector is started after AC power is turned off.</p> <ul style="list-style-type: none"> • Please do not forget your PIN code. <p>2 Turning off the PIN LOCK</p> <p>2-1 Follow the procedure in 1-1 to display the PIN LOCK on/off menu.</p> <p>2-2 Use the ▲/▼ buttons to select OFF and the Enter PIN Code box will be displayed. Enter the registered PIN code to turn the PIN LOCK function off. If an incorrect PIN code is input 3 times, the projector will turn off.</p> <p>3 If you have forgotten your PIN code</p> <p>3-1 While the Enter PIN Code box is displayed, press and hold the RESET button for 3 seconds or press and hold the -> button for 3 seconds while pressing the ► button on the projector. The 10 digit Inquiring Code will be displayed.</p> <ul style="list-style-type: none"> • If there is no key input for about 5 minutes while the Inquiring Code is displayed, the projector will turn off.  <p>3-2 Contact your dealer with the 10 digit Inquiring Code. Your PIN code will be sent after your user registration information is confirmed.</p>



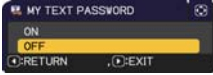



(continued on next page)

Item	Description
<p style="text-align: center;">TRANSITION DETECTOR</p>	<p>If this function is set to ON and the vertical angle of the projector is different from the previous recorded setting, the TRANSITION DETECTOR ON alarm will be displayed and the input signal will not be displayed.</p> <ul style="list-style-type: none"> • To display the signal again, set this function OFF. • After about 5 minutes of displaying the TRANSITION DETECTOR ON alarm, the light source will turn off. • KEYSTONE, PERFECT FIT and INSTALLATION functions have been prohibited as long as the TRANSITION DETECTOR function is on. <p>1 Turning on the TRANSITION DETECTOR</p> <p>1-1 Use the ▲/▼ buttons on the SECURITY menu to select TRANSITION DETECTOR and press the ► or the ENTER button to display the TRANSITION DETECTOR on/off menu.</p>  <p>1-2 Use the ▲/▼ buttons on the TRANSITION DETECTOR on/off menu to select ON. Selecting ON will save the setting of the current angle and the INSTALLATION setting. The ENTER NEW PASSWORD box (small) will be displayed.</p>  <p>1-3 Use the ▲/▼/◀/▶ buttons to enter a password. Move the cursor to the right side of the ENTER NEW PASSWORD box (small) and press the ► button to display the NEW PASSWORD AGAIN box, enter the same password again.</p>  <p>1-4 Move the cursor to the right side of the NEW PASSWORD AGAIN box and press the ► button to display the NOTE NEW PASSWORD box for about 30 seconds, please make a note of the password during this time. Pressing the ENTER button on the remote control or the ► button on the projector will return to the TRANSITION DETECTOR on/off menu.</p>   <ul style="list-style-type: none"> • Please do not forget your TRANSITION DETECTOR password. • This function will activate only when the projector is started after turning off the AC power. • This feature may not function properly if the projector is not in a stable position when ON is selected. <p>2 Turning off the TRANSITION DETECTOR</p> <p>2-1 Follow the procedure in 1-1 to display the TRANSITION DETECTOR on/off menu.</p> <p>2-2 Select OFF to display the ENTER PASSWORD box (large). Enter the registered password and the screen will return to the TRANSITION DETECTOR on/off menu.</p>  <p>If an incorrect password is input, the menu will close. If necessary, repeat the process from 2-1.</p> <p>3 If you have forgotten your password</p> <p>3-1 Follow the procedure in 1-1 to display the TRANSITION DETECTOR on/off menu.</p> <p>3-2 Select OFF to display the ENTER PASSWORD box (large). The 10 digit Inquiring Code will be displayed inside the box.</p>  <p>3-3 Contact your dealer with the 10 digit Inquiring Code. Your password will be sent after your user registration information is confirmed.</p>

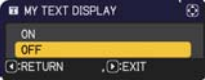
(continued on next page)

Item	Description
MY TEXT PASSWORD	<p>The MY TEXT PASSWORD function can prevent the MY TEXT from being overwritten. When the password is set for the MY TEXT;</p> <ul style="list-style-type: none"> • The MY TEXT DISPLAY menu will be unavailable, which can prohibit changing the DISPLAY setting. • The MY TEXT WRITING menu will be unavailable, which can prevent the MY TEXT from being overwritten. <p>1 Turning on the MY TEXT PASSWORD</p> <p>1-1 Use the ▲/▼ buttons on the SECURITY menu to select the MY TEXT PASSWORD and press the ► button to display the MY TEXT PASSWORD on/off menu.</p>  <p>1-2 Use the ▲/▼ buttons on the MY TEXT PASSWORD on/off menu to select ON. The ENTER NEW PASSWORD box (small) will be displayed.</p>  <p>1-3 Use the ▲/▼/◀/▶ buttons to enter the password. Move the cursor to the right side of the ENTER NEW PASSWORD box (small) and press the ► button to display the NEW PASSWORD AGAIN box, and then enter the same password again.</p>  <p>1-4 Move the cursor to the right side of the NEW PASSWORD AGAIN box and press the ► button to display the NOTE NEW PASSWORD box for about 30 seconds, then please make a note of the password during this time.</p>  <p>Pressing the ENTER button on the remote control or the ► button on the projector will return to the MY TEXT PASSWORD on/off menu.</p> <p>2 Turning off the MY TEXT PASSWORD</p> <p>2-1 Follow the procedure in 1-1 to display the MY TEXT PASSWORD on/off menu.</p> <p>2-2 Select OFF to display the ENTER PASSWORD box (large). Enter the registered password and the screen will return to the MY TEXT PASSWORD on/off menu.</p>  <p>If an incorrect password is input, the menu will close. If necessary, repeat the process from 2-1</p> <p>3 If you have forgotten your password</p> <p>3-1 Follow the procedure in 1-1 to display the MY TEXT PASSWORD on/off menu.</p> <p>3-2 Select OFF to display the ENTER PASSWORD box (large). The 10 digit inquiring code will be displayed inside the box.</p> <p>3-3 Contact your dealer with the 10 digit inquiring code. Your password will be sent after your user registration information is confirmed.</p>

(continued on next page)

Item	Description
<p>MY TEXT DISPLAY</p>	<p>(1) Use the ▲/▼ buttons on the SECURITY menu to select the MY TEXT DISPLAY and press the ► or ENTER button to display the MY TEXT DISPLAY on/off menu.</p>  <p>(2) Use the ▲/▼ buttons on the MY TEXT DISPLAY on/off menu to select on or off.</p> <p>ON ⇔ OFF</p> <p>When it is set ON, the MY TEXT will be displayed on the START UP screen and the INPUT_INFORMATION when the INFORMATION on the SERVICE menu is chosen.</p> <ul style="list-style-type: none"> • This function is available only when the MY TEXT PASSWORD function is set to the OFF.  
<p>MY TEXT WRITING</p>	<p>(1) Use the ▲/▼ buttons on the SECURITY menu to select the MY TEXT WRITING and press the ► button. The MY TEXT WRITING dialog will be displayed.</p>  <p>(2) The current MY TEXT will be displayed on the first 3 lines. If not yet written, the lines will be blank.</p> <p>Use the ▲/▼/◀/▶ buttons and the ENTER or ↻ button to select and enter characters. To erase 1 character at one time, press the RESET button or press the ◀ and ↻ button at the same time. Also if you move the cursor to DELETE or CLEAR ALL on screen and press the ENTER or ↻ button, 1 character or all characters will be erased. The MY TEXT can be input up to 24 characters on each line.</p>  <p>(3) To change an already inserted character, press the ▲/▼ button to move the cursor to one of the first 3 lines, and use the ◀/▶ buttons to move the cursor on the character to be changed.</p> <p>After pressing the ENTER or ↻ button, the character is selected. Then, follow the same procedure as described at the item (2) above.</p>  <p>(4) To finish entering text, move the cursor to the OK on screen and press the ►, ENTER or ↻ button. To revert to the previous MY TEXT without saving changes, move the cursor to the CANCEL on screen and press the ◀, ENTER or ↻ button.</p> <ul style="list-style-type: none"> • The MY TEXT WRITING function is available only when the MY TEXT PASSWORD function is set to OFF.
<p>CLONING LOCK</p>	<p>The CLONING operation under OPTION_SERVICE menu is not available if ON is selected.</p>

Presentation tools

The projector has the following convenient tools that enable on-screen presentations easily and quickly:

- Interactive Function ([book icon](#) *below*)
- PC-LESS Presentation ([book icon](#) 118)
- USB Display ([book icon](#) 127)

Interactive Function

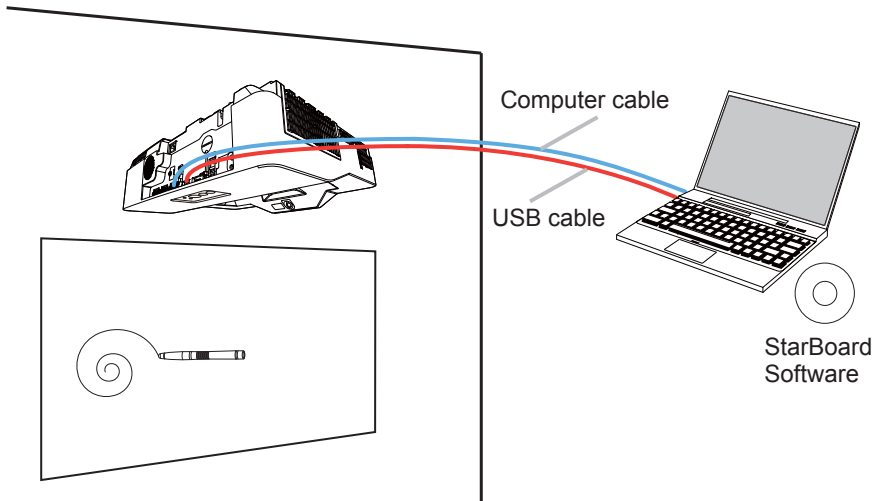

The Interactive Function enables interactive operation without a dedicated board such as the operation on the connected computer or writing on the display with the sensor equipped in the projector and bundled Interactive pen.

Interactive Function (continued)

Connection during use

Follow the procedure below to connect the computer to the projector.

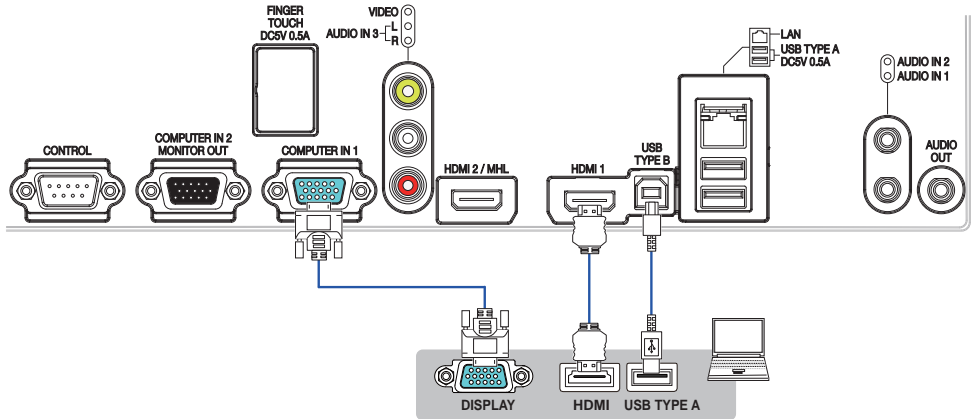

- (1) Connect the computer cable to the **COMPUTER IN** or **HDMI** port of the projector, and fasten using the screw.
- (2) Connect the opposite end of the computer cable in (1) to the **DISPLAY** port of the computer, and fasten using the screw.
- (3) Connect the USB TYPE B port of the projector to the USB type A port of the computer with a USB cable.

* When an operation of the computer is not necessary, you don't need to connect a **USB TYPE B**.

- (4) Connect the power supply of the projector and computer.

Interactive Function (continued)

NOTE • When the Interactive Function is in use, it is recommended that you make use of input signals from the **COMPUTER IN1**, **COMPUTER IN2**, **HDMI1/MHL** and **HDMI2** ports.

- Noise through the USB cable may trigger a malfunction depending on the computer and projector you are using. When this occurs, check to ensure that the power cables of the computer and projector are grounded. Malfunction may occur if the cables are not grounded.
- The pen sensor may be blocked if the projector is placed directly on the floor. It is recommended the projector be mounted on the wall or ceiling. The Interactive Function does not work during rear projection.
- Set the resolution to 1280 x 800 when connecting to a laptop computer. Otherwise, the Interactive Function may not operate properly.
- Holding out the hand in front of the camera lens causes malfunction.
- Don't make anything with magnetic force of a magnet approach in the camera unit. It'll be sometimes obstruction of the operation with the normal interactive function.

⚠ CAUTION ► Be careful of the wired cables. Tripping over the cables may result in injury or damage the projector or computer.

Interactive Function (continued)**USER SETTING**

The Interactive Function can be set in IWB CALIBRATE of the EASY MENU or IWB of the ADVANCED MENU.

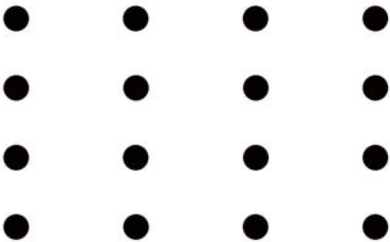
Item	Description
AUTO CALIBRATE	<p>Performs the initial setting of the Interactive Function automatically.</p> <ul style="list-style-type: none"> • The following pattern image is displayed while executing AUTO CALIBRATE. The pattern image disappears when AUTO CALIBRATE is completed. • Try adjusting by MANUAL CALIBRATE if the position of pen does not coincide with the drawn line after executing AUTO CALIBRATE. 

NOTE

- Accuracy of AUTO CALIBRATE might decrease if you execute AUTO CALIBRATE just after turning on the projector. Wait more than 2 minutes after turning on the projector to execute AUTO CALIBRATE.
- Stay away from the projector until AUTO CALIBRATE is completed.
- AUTO CALIBRATE may fail when interfering light falls on the image of the projector. Be sure not to let the light fall directly on the screen.
- AUTO CALIBRATE may fail depending on the installation environment. In this case, try adjusting by MANUAL CALIBRATE.
- AUTO CALIBRATE may fail with the board or screen of dark color.

(continued on next page)

Interactive Function (continued)

Item	Description
<p style="text-align: center;">MANUAL CALIBRATE</p>	<p>Using bundled pen performs the initial setting of the Interactive Function. Click on the center of the marker displayed in the image from the projector with a bundled pen. Every time you click with a bundled pen, the position of the marker changes. MANUAL CALIBRATE is completed when clicking 16 markers in total.</p>

NOTE • CALIBRATE is required again when installation situation of the projector is changed or display region of the image is changed by the functions such as D-ZOOM/D-SHIFT etc.

(continued on next page)

Interactive Function (continued)

Item	Description
IWB SETUP	Select this item and press the ► cursor button or ENTER button to display IWB SETUP menu. Select an item.
	IWB MODE Press the ► cursor button or ENTER button to set IWB MODE. (1) Select the input port to change setting. (2) Select IWB MODE. PC INTERACTIVE ⇔ PC LESS INTERACTIVE ⇔ OFF PC INTERACTIVE : PJ internal Painter mode, PJ operation mode, and PC operation mode of Interactive tool (📖 102) are available. PC LESS INTERACTIVE : PJ operation mode and PJ internal Painter mode of Interactive tool are available. OFF : Interactive tool is unavailable.
	FINGER TOUCH Select ON/OFF of FINGER TOUCH function. ON ⇔ OFF <ul style="list-style-type: none"> • Select ON if you use FINGER TOUCH UNIT(Optional parts : FT-01B) for interactive operation by finger. • Select OFF if you operate by bundled pen.

(continued on next page)

Interactive Function (continued)

Item	Description
IWB SETUP (continued)	<p>CAMERA VIEW Press the ► cursor button or ENTER button to display OSD menu of CAMERA VIEW. Camera image is displayed on the menu.</p> <ul style="list-style-type: none"> • This function is for the adjustment of FINGER TOUCH UNIT(Optional parts : FT-01B) . <p>For more information, refer to the manual of FINGER TOUCH UNIT.</p>
	<p>MOUSE TYPE Select MOUSE TYPE.</p> <p style="text-align: center;">MULTI ⇔ SINGLE</p> <ul style="list-style-type: none"> • When selecting MULTI, whether multi touch is supported or not by connected computer is judged automatically. <p>When using PC operation mode of Interactive tool (📖 102), you can use multi touch if your computer supports multi touch.</p> <ul style="list-style-type: none"> • When selecting SINGLE, you cannot use multi touch of PC operation mode. <p>NOTE</p> <ul style="list-style-type: none"> • Select SINGLE if mouse operating of PC operation mode does not work well with selecting MULTI.



(continued on next page)

Interactive Function (continued)

Item	Description
CALIBRATE SETUP	Select this item and press the ► cursor button or ENTER button to display CALIBRATE SETUP menu. Select an item.
	<p>SCREEN TYPE Select SCREEN TYPE.</p> <p style="text-align: center;">16:10 ⇄ 16:9 ⇄ 4:3 </p> <ul style="list-style-type: none"> • The area of screen is set according to the selected SCREEN TYPE(ratio of height and width). • The guide of setting area of screen is displayed. <p>NOTE</p> <ul style="list-style-type: none"> • When changing SCREEN TYPE, execute AUTO CALIBRATE (📖 94) or MANUAL CALIBRATE (📖 95). • After executing calibration, display calibration pattern and adjust according to SCREEN TYPE. • The position of pen is followed automatically if setting of resolution or aspect (📖 47) of input signal is changed. So you don't have to execute calibration again. • When a part of image is displayed going beyond the set area, the function does not work even if touching the point in the area by pen.

(continued on next page)

Interactive Function (continued)

Item	Description
CALIBRATE SETUP (continued)	<p>IWB AREA SETUP Press the ► cursor button or ENTER button to set IWB AREA SETUP. Select AUTO or MANUAL.</p> <p style="text-align: center;">AUTO ⇔ MANUAL</p> <ul style="list-style-type: none"> • When selecting AUTO, the area of mouse cursor with PC operation mode of Interactive tool (📖 103) is adjusted automatically . • When selecting MANUAL, Adjust the area of mouse cursor with PC operation mode by manual operation. <p>Adjusting the area of mouse cursor by manual operation</p> <ul style="list-style-type: none"> • Select MANUAL and press the ► cursor button or ENTER button to move mouse cursor on the screen. • Click the position of mouse cursor by the pen at the upper left and then click at the lower right similarly. <div style="display: flex; justify-content: space-around; align-items: center;"> <div style="text-align: center;"> <p>cursor</p>  </div> <div style="text-align: center;">  <p>cursor</p> </div> </div> <p>NOTE</p> <ul style="list-style-type: none"> • Adjusting by manual operation is unavailable if there is no signal. • Try again if adjusting by manual operation is failed. • When selecting AUTO, if following trouble happens depending on computer, select MANUAL. Though the position of pen coincides with the drawn line with PJ internal Painter mode of Interactive tool, the position of pen does not coincide with the cursor of mouse operating with PC operation mode.

(continued on next page)

Interactive Function (continued)

Item	Description
<p>MULTI DISPLAY</p>	<p>Select ON/OFF of MULTI DISPLAY.</p> <p>ON ⇔ OFF</p> <ul style="list-style-type: none"> • Select ON if using MULTI DISPLAY function. • Select OFF if not using MULTI DISPLAY function. <p>NOTE</p> <ul style="list-style-type: none"> • When selecting ON, IWB MODE (📖 96) is not able to be set. • When selecting ON, Interactive tool (📖 102) is unavailable.
<p>MEMORY ACCESS</p>	<p>Select MEMORY ACCESS setting.</p> <p>PROJECTOR ⇔ COMPUTER</p> <ul style="list-style-type: none"> • Select PROJECTOR to display template data which stored inside memory of projector on thumbnail of USB TYPE A. • Select COMPUTER to operate internal memory of projector as USB memory by the computer connected to USB TYPE B port. <p>NOTE</p> <ul style="list-style-type: none"> • Select PROJECTOR to use USB Display (📖 127).

(continued on next page)

Interactive Function (continued)

When selecting PC INTERACTIVE mode or PC LESS INTERACTIVE mode of the IWB MODE, you can use internal paint tool of the projector.

Main Functions

It offers effective features for making classroom and business presentations more fun and easier to understand.

Drawing on projected images

You can draw pictures or text on images projected by our projectors.

NOTE • The authorization by the copyright owner(s) is required pursuant to applicable laws for the use of works including visual images, if such works are copyrighted works.
• Drawing with the Interactive Function is not possible with some image signals.

Saving and displaying drawn images

You can save images with pictures or text drawn on them to a USB memory device and then call out the saved images and display them again later.

NOTE • A USB memory device is necessary to utilize this function.
• Copyright protected images cannot be saved.

Using as a simple mouse





The product can be used in place of the mouse of a computer connected to a projector.

NOTE • To use this function, a USB cable is required to connect the computer and the projector.

Interactive Function (continued)**Using Interactive tool.**

Touch the projected image using the bundled pen to display initial operation tool bar and use Interactive Function.



-  PC operation mode :
Shifts to PC operation mode.
-  PJ internal Painter mode :
Shifts to PJ internal Painter mode.
-  PJ operation mode :
Shifts to PJ operation mode.
-  Deletes tool bar and exits Interactive Function.
-  Minimizes tool bar display.
Touch minimized icon to return the tool bar display.

NOTE • When selecting ON of MULTI DISPLAY ( 100), this tool is unavailable.

- Tool bar disappears automatically if there is no operation for several seconds.
- Multi touch with PC operation mode and PJ internal Painter mode supports to 6 pens.

Interactive Function (continued)

PC operation mode

With PC operation mode, you can perform mouse click and drag operation by touching the projected image using the bundled pen.

PC operation tool bar like the figure below is displayed on the projector screen.



Performs the right click operation of mouse.



Finishes PC operation mode and displays initial operation tool bar.



Minimizes tool bar display.

Touch minimized icon to return the tool bar display.

NOTE • Select PC INTERACTIVE of IWB MODE (🖱️ 96).

- Connect **USB TYPE B** port of the projector and USB port (TYPE A) of computer by USB cable.
- Performs the right click operation of the mouse by push and hold any point on the screen for a few seconds with a pen.
- Tool bar is minimized automatically if there is no operation for several seconds. Tool bar disappears if it is already minimized.

Interactive Function (continued)**PJ internal Painter mode**

With PJ internal Painter mode, you can use projector internal Painter function.

PC LESS painter tool bar like the figure below is displayed on the projector screen. You can use following functions by touching the icon of the tool bar using the bundled pen. Touch the position except the icon with the pen and drag it to move tool bar.



NOTE • Images may be copyrighted, in which case, permission from the copyright holder is necessary for use, in accordance with the copyright act and other applicable laws.

1. Pen Selects the pen function.

Pen :

Dragging it draws a line of the specified pen color.



Laser Pen :

Dragging it draws a line of the specified pen color.





The previous drawing with a Laser Pen is deleted when you resume drawing after 3 or more seconds have passed.

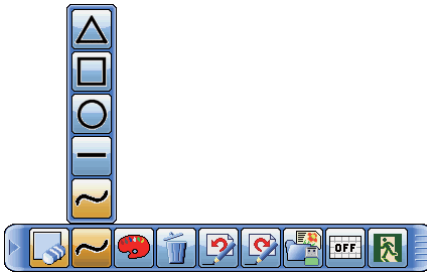

Eraser :

Drags it to erase previously drawn lines.

Interactive Function (continued)**2. Graphic drawing** Selecting graphics to be drawn with a pen / Laser Pen.

-  Freehand :
You can draw by freehand with a pen / Laser Pen.
-  Straight line drawing :
Draws a straight line from where starting dragging to where finishing dragging with a pen / Laser Pen.
-  Circle drawing :
Draws a circle from where starting dragging as the center to where finishing dragging as radius with a pen / Laser Pen.
-  Square drawing :
Draws a square from where starting dragging to where finishing dragging with a pen / Laser Pen.
-  Triangle drawing :
Draws a triangle from where starting dragging to where finishing dragging with a pen / Laser Pen.

Interactive Function (continued)

3. Pen color Selects the Color of the line drawn by the Pen.

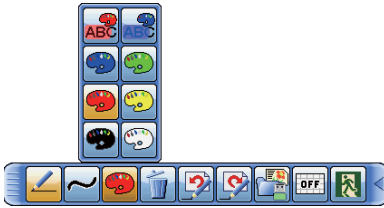

: Specifies each Color.

4. Editing operation You can Undo/Redo/Erase the drawing.

- Undo: Restores the drawing.
- Redo: Redoes the restored drawing.
- Erase: Erases all the lines drawn with the pen.

5. File Operation Clicking the icon on the thumbnail menu with an Interactive pen enables the operation of the thumbnail while internal paint tool of the projector is displayed.



- Saves the image on the projector screen, along with any text or pictures drawn, onto a USB memory device connected to the projector or projector internal memory.
- Saves in the USB memory connected to projector.
- Saves in the projector internal memory.

Interactive Function (continued)

5. File Operation (continued)

- Files are saved with the file name “Pxxx.jpg” (where xxx is a consecutive number) into a folder named “PJ_Capture” . If it does not already exist, a “PJ_Capture” folder is created automatically.
- Before removing a USB memory device with files saved to it from the projector, be sure to run the projector’ s “REMOVE USB” function. The time stamp of saved files are as per the date and time settings of the projector. If you do not run the “REMOVE USB” function and remove the USB memory device, the time stamp may not be recorded correctly.
- The tool bar is not saved.
- Copyright protected images cannot be saved.
- Nothing drawn using this function is saved to the projector’ s “MyScreen”.



Displays thumbnails of files recorded on a USB memory device. You can display an image onto the projector screen by touching its thumbnail.



Calls up and display the next file in the USB memory device from that currently selected. This function is available when the projector is displaying a file from a USB memory device.



Calls up and display the previous file in the USB memory device from that currently selected. This function is available when the projector is displaying a file from a USB memory device.

NOTE • Select PROJECTOR for MEMORY ACCESS ( 100) to perform the file operation of projector internal memory.

Interactive Function (continued)

6. Background Selects background display.



Displays each template.



Displays all black or white background.



Turns off background display and displays projected image. If there is no signal, displays start up screen.

7. Return Finishes PJ internal Painter mode and displays initial operation tool bar.



When exiting the drawing mode, all unsaved drawings are lost.

8. Minimize Minimizes the tool bar.



Touching the minimized tool bar icon displays the tool bar again.

9. Move Moves the tool bar.



Touch with the pen and drag it to move the tool bar.

Interactive Function (continued)

PJ operation mode

With PJ operation mode, PJ operation tool bar like the figure below is displayed on the projector screen. Perform operation of projector by touching the icon of the tool bar using the bundled pen.



•

•

•



Switches to the selected input port directly.



Temporarily blanks out the display.

Touching anywhere in the screen recovers the display, and displays initial operation tool bar.

- It can be used in the same way as the **AV MUTE** button on the projector's remote control.



Use the icon to adjust the volume.

Interactive Function (continued)**PJ operation mode (continued)**

Switches ON/OFF of MAGNIFY.



Touch screen after selecting the icon to magnify the touched point.



Select the icon to turn off the magnified display.



The projector will go into the FREEZE mode, which the picture is frozen.



Switches ON/OFF of FINGER TOUCH function.



Performs AUTO CALIBRATE.



Turns off the projector. Touch the icon for three seconds or so.

- If you turn the projector off while using the drawing function, any unsaved drawings will be lost.



Finishes PJ operation mode and displays initial operation tool bar.

Interactive Function (continued)

Preliminary preparation

To use the Interactive Function, a special pen is needed ( 7).

Insert battery into the pen before using ( 24).

The optional part Finger Touch Unit (FT-01B) enables Interactive operation by fingers.

Using the pen

To write or draw using the pen, press the tip of the pen against the screen surface and move the pen accordingly. Writing ends once the tip of the pen is moved away from the screen surface.

Pay attention to the two points below when using the pen.

- (1) When drawing using the pen, hold it perpendicularly to the screen as much as possible, and draw objects by pressing the tip of the pen against the screen to apply writing pressure.
- (2) If the characters or objects that you have written or drawn on the screen cannot be loaded correctly on the computer, check whether the problem can be resolved by changing the way you hold the pen.

⚠ CAUTION ▶ Do not drop the pen or mishandle it.

- Do not expose the pen to water or other fluids. If the pen is wet accidentally, wipe it dry immediately.
- If you do not intend to use the pen for a long time, remove the battery.

NOTE • The projector detects the pen coordinates by reading infrared emitted by the pen. Therefore, input may fail if transmission between the pen and the projector is blocked. Make sure that signal transmission is not obstructed.

Interactive Function (continued)

Basic pen operation

You can perform the following mouse operations using the button at the tip of the pen.

- **Click**
Press the tip of the pen against the screen surface with moderate force, and lift it quickly.
- **Double-click**
Perform the “click” operation twice quickly by pressing the tip of the pen against the screen surface with moderate force and lifting it.
Long press of Pen operates the same as clicking the right mouse button.
- **Drag**
Press the tip of the pen against the screen surface with moderate force, and move the pen without lifting it.

Interactive Function (continued)

Using "StarBoard Software"

If using StarBoard software it can be installed by following the instructions in the manual located on the DVD-ROM or by downloading it from the link on the Dukane AV web site for this product;

<http://www.dukane-av.com/service/ProductDownload.asp>

<http://www.dukane-av.com/service/ProductDownload.asp?model=8133WISS>

⚠ CAUTION ▶ Only use the DVD-ROM in a computer DVD drive. The DVDROM is designed for computer use only. NEVER INSERT THE DVD-ROM INTO A NON-COMPUTER DVD PLAYER! Inserting the DVD-ROM into an incompatible DVD drive may produce a loud noise, which in turn MAY RESULT IN EAR AND SPEAKER DAMAGE!

- After using DVD-ROM, please put it into DVD case and keep it. Please keep the DVD neither in direct sunlight nor in a high temperature and high humidity environment.

NOTE

- The information in the DVD-ROM is subject to change without notice.
- No responsibility is taken for any obstacle and defect to hardware and software of your computer as a result of the use of the DVD-ROM.
- The pen is referred to as "Electronic pen" in the "StarBoard Software".
- Notations in the "StarBoard Software" manual may differ from those in this manual.
- Please regards the word "StarBoard" found in StarBoard Software manual, online help, software message or any other related materials as the interactive whiteboard system using the Hitachi Interactive Projector, or the projector. ("StarboardSoftware" is not changed).
- The set of functions that are available for the combination of Hitachi Interactive Projector and Starboard Software is in conformity with the Starboard FX Portable Series.

Interactive Function (continued)

System requirements : StarBoard Software

The following specification is required to use Interactive Function.
(Windows® computer)

Computer : Install the dedicated application "StarBoard Software".
The following is the minimum hardware and operating system requirements to install "StarBoard Software".

CPU: Intel® Core™ Duo (1.8 GHz or higher)

HDD: 2 GB free space

Memory: 2 GB or more

Display: 32 Bit

OS: One of the following.

Windows® 7 (32/64 bit)

Windows® 8.1 (32/64 bit)

Windows® 10 (32/64 bit)

- The operation of StarBoard Software has been verified with the latest service pack at the time of release.

- StarBoard Software does not support Windows® Tablet PC Edition and Server Edition.

Application:

Internet Explorer® 11

Microsoft Word 2013 / 2016

Microsoft Excel® 2013 / 2016

Microsoft PowerPoint® 2013 / 2016

Adobe® Reader X/XI

Adobe® Acrobat® Reader® DC

Adobe® Flash® Player 18

DVD-ROM drive

Video cards supporting hardware overlay. (when using the video function)

(When using the Webcam function)

- DV (digital video devices, DV camera, D-VHS etc.)
- Capture Devices that supports DirectShow with WDM driver

(When hosting a remote conference)

CPU: Intel® Core™ i3 or higher

HDD: 2 GB or more

Memory: 2 GB or more

Others: TPC/IP Network of 54Mbps or greater

Interactive Function (continued)

(When i-learn: maths toolbox is used)

- Display : 1024 x 768 or more
- Application: Adobe® Reader
- Others: 32bit color 3D video card

The installation requirements are subject to change without notice due to software upgrades or the like. Please refer to the StarBoard Software manual in the bundled DVD-ROM for the latest installation requirements.

The following specification is required to use Interactive Function.

(Mac® computer)

Computer : Install the dedicated application "StarBoard Software".

The following is the minimum hardware and operating system requirements to install "StarBoard Software".

CPU: Intel® Core™ Duo (1.8 GHz or higher)

HDD: 2 GB free space

Memory: 2 GB or more

Display: High Color (16 bit) or more

OS: Mac OS X® 10.10 / 10.11 / 10.12 / 10.13

Application:

Apple QuickTime® 7.6 or later

Adobe® Flash® Player 18

DVD-ROM drive

(When hosting a remote conference)

CPU: Intel® Core™ i3 or higher

HDD: 2 GB or more

Memory: 2 GB or more

Others: TPC/IP Network of 54Mbps or greater

(When i-learn: maths toolbox is used)

• **Display:** 1024 x 768 or more

• **Application:** Adobe® Reader

• **Others:** 32bit color 3D video card

The following specification is recommended to ensure your comfortable use of Interactive Function.

CPU: Intel Core2 Duo 2.0 GHz or higher

Memory: 2 GB or more

The installation requirements are subject to change without notice due to software upgrades or the like. Please refer to the StarBoard Software manual in the bundled DVD-ROM for the latest installation requirements.

Interactive Function (continued)

- NOTE • Do not place the projector near equipment that may emit electromagnetic waves or radio waves, such as a radio transmitter, TV, copier, or air-conditioner.
- Avoid excessively dusty places, or places that are subject to extremely high or low temperature or humidity.
 - The pen makes use of infrared light to detect positions. Avoid using it at a place where the screen surface is directly exposed to sunlight. Also, note that the pen may not function properly if it is used near an equipment that emits infrared wavelengths (plasma display, motion sensor, or automatic lighting sensor, etc.).
 - The pen movement may be disrupted if the projector is used near an inverter fluorescent light, or when the light of an inverter fluorescent light falls directly on the screen.
 - The PEN sensor (Camera) may not work correctly if strong light (such as direct sunlight) or light from an extremely close range (such as from an inverter fluorescent lamp) falls on the PEN sensor (Camera) of the projector. Adjust the position of projector avoiding those lights.
 - Install and use at a position where the screen size is between 60"-100" when digital zoom is at the maximum (100%) and the KEYSTONE and PERFECT FIT functions are not used. If the KEYSTONE or PERFECT FIT function is used, the position of the pen may not be reflected correctly on the screen, or pen operation may not yield any response even on the 60"-100" sized screen.
 - StarBoard Software may not activate, if DirectX® function of the computer is turned off. In that case, turn on DirectX® function. Please inquire your computer or OS support hotline on how to confirm the settings of DirectX® function On/Off.

Interactive Function (continued)

PC-LESS Presentation

The PC-LESS Presentation reads image and audio data from the storage media inserted into the **USB TYPE A** port and displays the image in the following modes. The PC-LESS Presentation can be started by selecting the **USB TYPE A** port as the input source.

This feature allows you to make your presentations without using your computer.

- Thumbnail mode (📖 119)
- Full Screen mode (📖 123)
- Slideshow mode (📖 124)

[Supported storage media]

- USB memory (USB memory type, USB hard disk and USB card reader type)
- INTERNAL MEMORY (📖 122)

NOTE • USB readers (adapters) that have more than one USB slot may not work (if the adapter is acknowledged as multiple devices connected).
• USB devices with security software may not work.
• Be careful when inserting or removing a USB device. (📖 15, 121)

[Supported format]

- FAT12, FAT16 and FAT32

NOTE • NTFS or exFAT are not supported.

PC-LESS Presentation (continued)

[Supported file format and its extension]

- JPEG (.jpeg, .jpg) * Progressive is not supported.
- Bitmap (.bmp) * 16bit mode and compressed bitmap is not supported.
- PNG (.png) * Interlace PNG is not supported.
- GIF (.gif)

NOTE • Files with a resolution larger than the following are not supported.
1280 x 800 (Still)

(* Some computers may not support 1280 x 800.)

- Files with a resolution smaller than 36 x 36 are not supported.
- Files with a resolution smaller than 100 x 100 may not be displayed.
- Some supported files may not be displayed.
- Only a frame appears when the content of image data cannot be displayed in the Thumbnail mode.

Thumbnail mode

The Thumbnail mode displays the images stored in a USB storage device on the Thumbnail screen. Maximum 20 images are displayed in a screen.

If you wish, you can jump into the Full Screen mode or Slideshow mode, after you select some images in the Thumbnail mode.

The Thumbnail mode will be started as the primary function of the PC-LESS Presentation after selecting the **USB TYPE A** port as the input source.

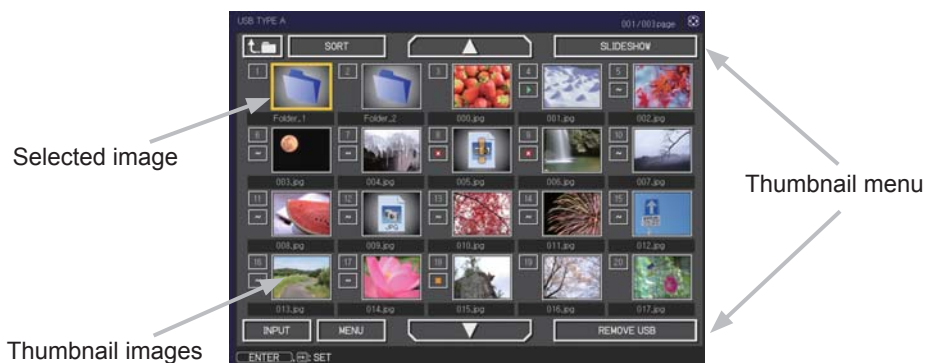

PC-LESS Presentation (continued)

Operating by buttons or keys

You can control the images on the Thumbnail screen with the remote control, control panel, Web Remote Control or pen. The following functions can be supported while the Thumbnail is displayed.

Button operation			Functions
The remote control	Control panel	Web Remote Control	
▲/▼/◀/▶	▲/▼/◀/▶	[▲]/[▼]/[◀]/[▶]	Moves cursor
PAGE UP PAGE DOWN	-	[PAGE UP] [PAGE DOWN]	Switches pages
ENTER	INPUT	[ENTER]	<ul style="list-style-type: none"> Displays the selected image on the Full Screen mode when a cursor is on a thumbnail image. Displays the setup menu (📖 below) for the selected image when a cursor is on a thumbnail image number.



The setup menu for the selected image

Use the ◀/▶ cursor buttons to switch each setting or use the ▶ cursor button to execute the functions as follows.

Item	Functions
RETURN	Press the ▶ cursor button or ENTER to return to the Thumbnail screen.
START	Switch to ON to set the selected image as the first image in the Slideshow. This setting information will be saved in the "playlist.txt" file (📖 126).
STOP	Switch to ON to set the selected image as the last image in the Slideshow. This setting information will be saved in the "playlist.txt" file (📖 126).
SKIP	Switch to ON to skip the selected image in the Slideshow. This setting information will be saved in the "playlist.txt" file (📖 126).
ROTATE	Press the ▶ cursor or ENTER button to rotate the selected still image 90 degrees clockwise. This setting information will be saved in the "playlist.txt" file (📖 126).
DELETE	Press the ▶ cursor or ENTER button to delete selected image. After executing delete, renew the image number displayed Thumbnail menu. If first or end image in the Slideshow is deleted, renew the setting of start/stop.

PC-LESS Presentation (continued)**Operating by the menu on the Thumbnail screen**

You can also control the images by using the menu on the Thumbnail screen.

Item	Functions
	Moves to an upper folder.
SORT	Allows you to sort files and folders as follows.
RETURN	Press the ► cursor button or ENTER to return to the Thumbnail screen.
NAME UP	Sorts in ascending order by file name.
NAME DOWN	Sorts in descending order by file name.
DATE UP	Sorts in ascending order by file date.
DATE DOWN	Sorts in descending order by file date.
▲/▼	Go to previous / next page.
SLIDESHOW	Configures and starts the Slideshow ( 124).
RETURN	Press the ► cursor button or ENTER to return to the Thumbnail screen.
PLAY	Press the ► cursor button or ENTER to start the Slideshow.
START	Sets the beginning number of the Slideshow.
STOP	Sets the end number of the Slideshow.
INTERVAL	Sets the interval time for displaying still images during the Slideshow.
PLAY MODE	Selects the Slideshow mode.
INPUT	The input source list is displayed.
MENU	Displays the menu.
REMOVE USB	Be sure to use this function before removing USB storage device from the projector. After that, the projector will not recognize a USB storage device until you insert it again into the USB TYPE A input port.

PC-LESS Presentation (continued)

- NOTE • These operations are not accessible while the projector OSD is displayed.
- The Thumbnail mode can display up to 20 files in one page.
 - It is not possible to change the input port by using the  button when the Thumbnail screen, Slideshow, or Full Screen is displayed.
 - Some error icons will be displayed in the Thumbnail.



————— This file seems to be broken or not supported format.

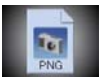
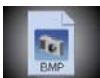

} A file that cannot be displayed on the thumbnail screen is indicated by a file format icon.

INTERNAL MEMORY

Multiple template data have been saved in INTERNAL MEMORY.

These images can be displayed in USB TYPE A.

Presentation can be conducted easily by using template data and pen.

INTERNAL MEMORY in the projector can be referred to on the PC when MEMORY ACCESS item of IWB menu is set to COMPUTER.

Image data can be saved in INTERNAL MEMORY in the projector from the PC.

A folder to save image data can be seen as removable disk named "PJ_ INTERNAL".

Image data can be played in USB TYPE A when MEMORY ACCESS item of IWB menu is set to PROJECTOR after saving image data and disconnecting removable disk.

- NOTE • INTERNAL MEMORY in the projector may be infected with a virus by connecting to a computer.

PC-LESS Presentation (continued)**Full Screen Mode**

The Full Screen mode shows a full display image. To display in Full Screen mode, select an image in the Thumbnail screen. Then press the **ENTER** button on the remote control, the **↵** button on the control panel or click **[ENTER]** on the Web Remote Control.



} Full screen display

Operations for still images

The following operations are enabled in the Full Screen mode while a still image is displayed.

Button operation			Functions
The remote control	Control panel	Web Remote Control	
▼ ▶ or PAGE DOWN	▼ or ▶	[▼] [▶] or [PAGE DOWN]	Shows the next file.
▲ ◀ or PAGE UP	▲ or ◀	[▲] [◀] or [PAGE UP]	Shows the previous file.
ENTER	INPUT	[ENTER]	Displays Thumbnail.

PC-LESS Presentation (continued)

Slideshow mode

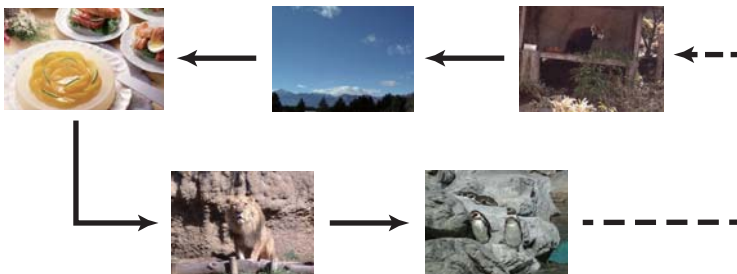

The Slideshow mode displays images in full screen and switches the images at intervals set in INTERVAL on the Thumbnail screen menu (📖 121).



You can start this function from the Slideshow menu. To display the Slideshow menu, select the SLIDESHOW button in the Thumbnail mode and press the **ENTER** button on the remote control,  button on the control panel, or click **[ENTER]** on the Web Remote Control.

While the Slideshow is displayed, the following button operations are enabled when still images are displayed, and the same button operations in the Full Screen mode are enabled when movies are displayed.

Button operation			Functions
The remote control	Control panel	Web Remote Control	
ENTER	INPUT	[ENTER]	Displays thumbnail

- NOTE** • These operations are not accessible while the projector OSD is displayed.
- It is not possible to change the input port by using the  button when the Thumbnail screen, Slideshow, or Full Screen is displayed.
 - When the Slideshow mode is set to ONE TIME and the last file is a still image, the last slide of the presentation will remain displayed until the **ENTER** button on the remote control or Web Remote Control, or the  button on the control panel is pressed.

PC-LESS Presentation (continued)

You can play the Slideshow at your desired configuration. Configure the Slideshow items in the Thumbnail.

- 1) RETURN : Returns to the thumbnail mode.
- 2) PLAY : Plays the Slideshow.
- 3) START : Sets the beginning number of the Slideshow.
- 4) STOP : Sets the end number of the Slideshow.
- 5) INTERVAL : Sets the interval time for displaying still images during the Slideshow.
It is not recommended to set the interval time very short like several seconds, because it may take more than several seconds to read and display an image file if it is stored in very deep layer directory or if so many files are stored in the same directory.
- 6) PLAY MODE : Selects the Slideshow mode.
ONE TIME : Plays the Slideshow one time.
ENDLESS : Plays the Slideshow endlessly.



NOTE • The settings of the Slideshow are saved to the “**playlist.txt**” file that is stored in the storage media. If the file is not existed, it is generated automatically.

- The settings for the START, STOP, INTERVAL, and PLAY MODE are saved to the Playlist.
- If the storage media is under the write protection or the “**playlist.txt**” is the read-only type file, it is impossible to change the settings of the Slideshow.

PC-LESS Presentation (continued)

Playlist

The Playlist is a DOS format text file, which decides the order of displayed still image files in the Thumbnail or Slideshow.

The playlist file name is "playlist.txt" and it can be edited on a computer.

It is created in the folder that contains the selected image files when the PC-LESS Presentation is started or the Slideshow is configured.

[Example of "playlist.txt" files]

START setting : STOP setting : INTERVAL setting : PLAY MODE setting :

img001.jpg: : : :

img002.jpg:600: : :

img003.jpg:700:rot1: :

img004.jpg: : :SKIP:

img005.jpg:1000:rot2:SKIP:

The "playlist.txt" file contains the following information.

Each piece of information requires to be separated by ":", and "." at the end of each line.

1st line: START, STOP, INTERVAL and PLAY MODE settings ( 125).

2nd line and after: file name, interval time, rotation setting and skip setting.

interval time: It can be set from 0 to 999900 (ms) with an increment of 100 (ms).

rotation setting: "rot1" means a rotation at 90 degrees clockwise; "rot2" and

"rot3" increase another 90 degrees in order.

skip setting: "SKIP" means that the image will not be displayed in the Slideshow.

NOTE • The maximum length in a line on the "playlist.txt" file is 255 characters including linefeed. If any line exceeds the limit, the "playlist.txt" file becomes invalid.

• Up to 999 files can be registered to the Playlist. However, if some folders exist in the same directory the limit number is decreased by the number of folders.

Any files over the limit will not be shown in the Slideshow.

• If the storage device is protected or does not have sufficient space, the "playlist.txt" file cannot be created.

• For the Slideshow settings, refer to the section **Slideshow mode** ( 124).

USB Display(Windows® computer)

The projector can display images transferred from a computer via a USB cable (📖 12).

Hardware and software requirement for computer

- **OS:** One of the following.
Windows® 7
Windows® 8.1
Windows® 10
- **CPU:** Pentium® 4 (2.8 GHz or higher)
- **Graphic card:** 16 bit, XGA or higher
- **Memory:** 512 MB or higher
- **Hard disk space:** 30 MB or higher
- **USB Port**
- **USB cable :** 1 piece

Starting USB Display

When you connect your computer to the **USB TYPE B** port on the projector using a USB cable, the projector will be recognized as a CD-ROM drive on your computer. Then, the software in the projector, “LiveViewerLiteForUSB.exe”, will run automatically and the application, “LiveViewer Lite for USB”, will be ready on your computer for the USB Display. The application, “LiveViewer Lite for USB”, will close automatically when the USB cable is unplugged. However, it may remain displayed at times.

NOTE • If the software does not start automatically (this is typical because CD-ROM autorun is disabled on your OS), follow the instructions below.

(1) Click on the [Start] button on the toolbar and select the “Run”

(2) Enter F:\LiveViewerLiteForUSB.exe and then press the [OK]

↑ — If your CD-ROM drive is not drive F on your computer, you will need to replace F with the correct drive letter assigned to your CD-ROM drive.

- CD-ROM autorun is disabled while the screen saver is running.
- The image transmission from the computer is suspended while the password-protected screen saver is running. To resume the transmission, exit the screen saver.
- If "Waiting for connection." remains displayed while the USB cable is connected, remove the USB cable and reconnect after a while.

(continued on next page)

USB Display(Windows® computer) (continued)

This application will appear in the Windows notification area once it starts. You can quit the application from your computer by selecting “Quit” on the menu.

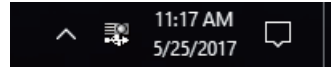

NOTE • “Live Viewer Lite for USB” cannot be used if MEMORY ACCESS item of IWB menu is set to COMPUTER.

• The “LiveViewer” (refer to the **Network**

Guide) and this application cannot be used at the same time. If you connect your computer to the projector by using a USB cable while the “LiveViewer” is running, the following message will be displayed.

- Depending on the software installed on your computer, images on your computer cannot be transferred using “LiveViewer Lite for USB”.
- If any application software having the firewall function is installed on your computer, make the firewall function invalid with following the user's manual.
- Some security software may block image transmission. Please change the security software setting to allow the use of “LiveViewer Lite for USB”.
- When the audio input from **USB TYPE B** is selected, if the sound level is still low even after raising the volume level in the projector to the maximum, check whether your computer outputs audio and raise the volume level accordingly.
- If the computer in use is equipped with **HDMI** port, the audio setting will be changed and sound interruption or noise may occur when the **HDMI** cable is connected or disconnected during USB Display. Restart USB Display for this case.
- Image distortion or sound interruption may occur when “LiveViewer” is connected to **LAN** (wireless or wired) during USB Display. The above decline in performance is noticeable especially when multiple computers are connected to “LiveViewer”.

LiveViewerLite for USB

Cannot start LiveViewerLite for USB while LiveViewer is running.

OK

USB Display(Windows® computer) (continued)

Right-Click menu

The menu shown in the right will be displayed when you right-click the application icon in the Windows notification area.

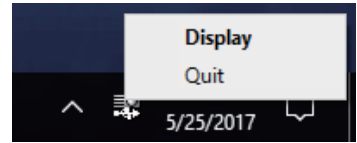

Display : The Floating menu is displayed, and the icon disappears from the Windows notification area.

Quit : The application is closed, and the icon disappears from the Windows notification area.

NOTE • If you wish to restart the application, you need to unplug the USB cable and plug it again.

Floating menu

If you select “Display” on the Right-Click menu, the Floating menu shown in the right will appear on your computer screen.

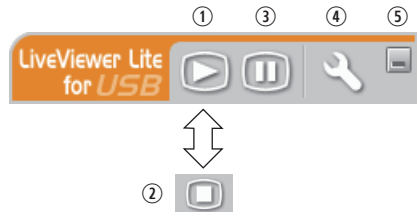

① Start capture button

The transmission to the projector is started and the images will be displayed.

② Stop button

The image transmission is stopped.

③ Hold button

The image on the projector’s screen is temporally frozen. The last image before the button is clicked is remained on the screen. You can revise the image data on your computer without showing it on the projector's screen.

④ Option button

The Options window is displayed.

⑤ Minimize button

The Floating menu is closed, and the icon reappears in the Windows notification area.

NOTE • If you click the Start capture button and/or Stop button repeatedly, images may not be displayed on the screen.

USB Display(Windows® computer) (continued)

Options window

If you select the Option button on the Floating menu, the Options window is displayed.

Optimize Performance

The “LiveViewer Lite for USB” captures screenshots in JPEG data and sends them to the projector. The “LiveViewer Lite for USB” has two options that have different compression rate of JPEG data.

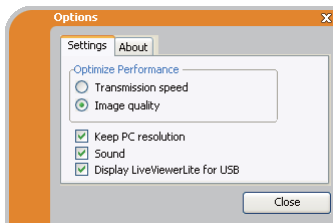
**Transmission speed**

Speed takes priority over Image quality.

It makes JPEG compression rate higher.

The screen on the projector is rewritten quicker because the transferred data is smaller, but the image quality is worse.

Image quality

Image quality takes priority over Speed.

It makes JPEG compression rate lower.

The screen on the projector is rewritten slower because the transferred data is larger, but the image quality is better.

Keep PC resolution

If you remove the check mark from the **[Keep PC resolution]** box, the screen resolution of your computer will be switched as follows, and the display speed may be faster.

8133WISS/8142WISS:1280 x 800 (WXGA)

If your computer does not support the display resolution specified above, a smaller resolution that is the largest among the resolutions that are supported by the computer will be selected.

Sound

Turns the sound on/off. The image quality may deteriorate when you play back audio data transferred together with the image data. To give priority to the image quality, turn off the sound by selecting the checkbox.



Display LiveViewer Lite for USB

If you want to display the "LiveViewer Lite for USB" application window on the screen, please check the box.

About

The version information of the “LiveViewer Lite for USB”.

NOTE • When the resolution is changed, the arrangement of icons on computer desktop screen may be changed.

• If one of the **AUDIO IN** ports is selected or  is selected for USB TYPE B in AUDIO SOURCE of the AUDIO menu ( 63), audio sound operation in the Options window will be disabled.

Maintenance

Cleaning and replacing the air filter

Please check and clean the air filter periodically. When the indicators or a message prompts you to clean the air filter, comply with it as soon as possible. In addition, the extra air filter is attached to inner side of the filter cover. If one of the filters is damaged or heavily soiled, replace whole filter set with a new one. Request for a filter set with the following type number from your dealer when purchasing a new one.

Type number : UX43251 (Filter set)

1. Turn the projector off, and unplug the power cord. Allow the projector to sufficiently cool down.
2. Use a vacuum cleaner on and around the filter cover.
3. Pick and pull up the filter cover knobs to take it off.
4. Press up slightly the bottom side knobs to unlock the bottom side of the filter unit. Take the filter unit off.
5. Use a vacuum cleaner for the filter vent of the projector and the outer side of the filter unit.
6. Use a vacuum cleaner for the inner side of each part of the filter unit to clean them up. If the filters are damaged or heavily soiled, replace them with the new ones.
7. Put the filter unit back in an upright state into the projector.
8. Put the filter cover back into the place.

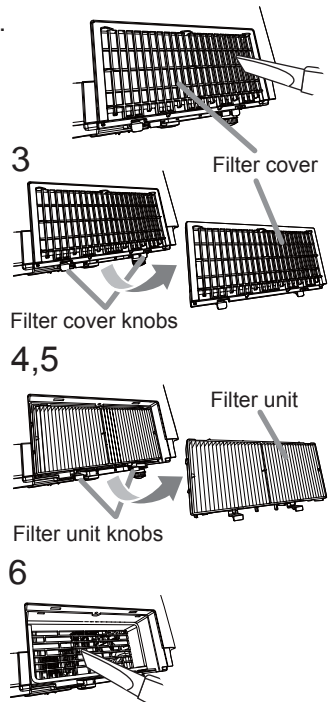

(continued on next page)

Cleaning and replacing the air filter (continued)

9. Turn the projector on and reset the filter time using the FILTER TIME item in the EASY MENU.
- (1) Press the **MENU** button to display a menu.
 - (2) Point at the FILTER TIME using the ▼/▲ button, then press the ► button. A dialog will appear.
 - (3) Press the ► button to select “OK” on the dialog. It performs resetting the filter time.

⚠ **WARNING** ► Before taking care of the air filter, make sure the power cord is not plugged in, then allow the projector to cool sufficiently. Taking care of the air filter in a high temperature state of the projector could cause an electric shock, a burn or malfunction to the projector.

► Use only the air filter of the specified type. Do not use the projector without the air filter or the filter cover. It could result in a fire or malfunction to the projector.

► Clean the air filter periodically. If the air filter becomes clogged by dust or the like, internal temperatures rise and could cause a fire, a burn or malfunction to the projector.

- NOTE**
- Please replace the air filter when it is damaged or heavily soiled.
 - Please reset the filter time only when you have cleaned or replaced the air filter, for a suitable indication about the air filter.
 - The projector may display the message such as “CHECK THE AIR FLOW” or turn off the projector, to prevent the internal heat level rising.

Replacing the internal clock battery

Installing the battery is required in some cases. (☐ "Event Scheduling" in the "Network Guide") A battery is not contained at the time of factory shipment. Please replace a battery according to the following procedure.

1. Turn the projector off, and unplug the power cord. Allow the projector to cool sufficiently.
2. Turn the battery cover fully counterclockwise using a coin or the like, and pick the cover up to remove it.
3. Pry up the battery using a flathead screwdriver or the like to take it out. Do not use any metal tools. While prying it up, put a finger lightly on the battery since it may pop out of the holder.
4. Replace the battery with a new MAXELL, Part No. **CR2032** or **CR2032H**. Slide the battery in under the plastic claw, and push it into the holder until it clicks.
5. Replace the battery cover in place, then turn it clockwise to fix by using a coin or the like.

Battery Cover

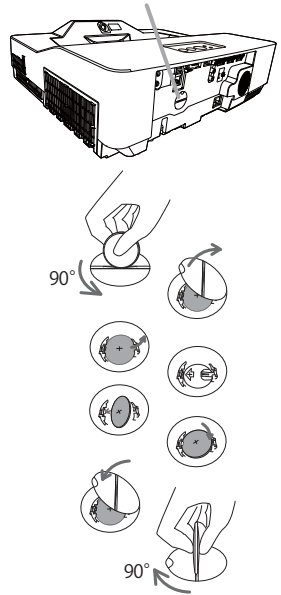

⚠WARNING ▶ Always handle the batteries with care and use them only as directed. Battery may explode if mistreated. Do not recharge, disassemble or dispose of in fire.

And also improper use may result in cracking or leakage, which could result in fire, injury and/or pollution of the surrounding environment.

- Be sure to use only the batteries specified.
- Make sure the plus and minus terminals are correctly aligned when loading a battery.
- Keep a battery away from children and pets. If swallowed, consult a physician immediately for emergency treatment.
- Do not short circuit or solder a battery.
- Do not allow a battery in a fire or water. Keep batteries in a dark, cool and dry place.
- If you observe battery leakage, wipe out the leakage and then replace a battery. If the leakage adheres to your body or clothes, rinse well with water immediately.
- Obey the local laws on disposing a battery.

NOTE • The internal battery is required to be replaced when the time is off soon after setting date and time.

Caring for the projection window and camera lens

If the projection window is flawed, soiled or fogged, it could cause deterioration of display quality. Please take care of the projection window, being cautious of handling.

1. Turn the projector off and unplug the power cord from the power outlet. And cool the projector down by leaving it for a while.
2. Use an air blower to blow away dust on the projection window and camera lens before wiping. Wipe softly the projection window and camera lens with a commercially available damped soft cleaning cloth for lens, being careful not to give any damage on the projection window and camera lens.

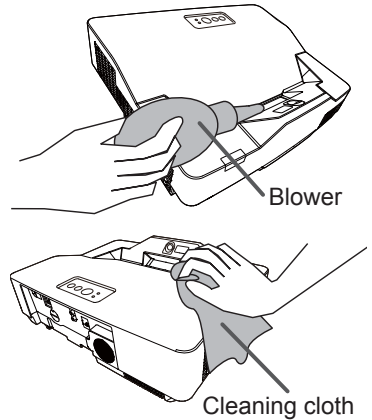

- Use commercially available lens tissue to clean the lens (used to clean cameras, eyeglasses, etc.).
- If the lens is heavily soiled, wipe it with a cloth moistened with little water.
- Never use polishing agents, detergents, chemicals, or solvents such as benzine or thinner.
- Excepting for lens, use a soft cloth to clean. When excessively soiled, dilute a neutral detergent in water, wet and wring out the soft cloth.

⚠ WARNING ▶ Before caring for the projection window and camera lens, turn the projector off and unplug the power cord, then cool the projector sufficiently.
 ▶ Do not use a vacuum cleaner to clean the projection window and camera lens, since it might give some damage.
 ▶ Do not use cleaners or chemicals other than those specified in this manual.
 Pay special attention to the projection window and camera lens as these materials could cause serious damage.

Other care

Inside of the projector

To ensure the safe use of your projector, please have it cleaned and inspected by your dealer about once a year.

Caring for the cabinet and remote control

Incorrect care could have adverse influence such as discoloration, peeling paint, etc.

1. Turn the projector off, and unplug the power cord. Allow the projector to cool sufficiently.
2. After making sure that the projector is cool adequately, wipe lightly with gauze or a soft cloth.
If the projector is extremely dirty, dip soft cloth in water or a neutral cleaner diluted in water, and wipe lightly after wringing well. Then, wipe lightly with a soft, dry cloth.

Maintenance of the pen

Wipe lightly with a soft, dry cloth.

△WARNING ▶ Before caring, make sure the power cord is not plugged in, and then allow the projector to cool sufficiently. The care in a high temperature state of the projector could cause a burn and/or malfunction to the projector.

▶ Never try to care for the inside of the projector personally. Doing it is so dangerous.

▶ Avoid wetting the projector or inserting liquids in the projector. It could result in a fire, an electric shock, and/or malfunction to the projector.

- Do not put anything containing water, cleaners or chemicals near the projector.
- Do not use aerosols or sprays.

△CAUTION ▶ Please take right care of the projector according to the following. Incorrect care could cause not only an injury but adverse influence such as discoloration, peeling paint, etc.

▶ Do not use cleaners or chemicals other than those specified in this manual.

▶ Do not polish or wipe with hard objects.

NOTICE ▶ Do not directly touch the projection window surface with hands.

Troubleshooting



If an abnormal operation should occur, stop using the projector immediately.

△WARNING ▶ Never use the projector if abnormal operations such as smoke, strange odor, excessive sound, damaged casing or elements or cables, penetration of liquids or foreign matter, etc. should occur. In such cases, immediately disconnect the power plug from the power outlet. After making sure that the smoke or odor has stopped, contact your dealer or service company.

Otherwise if a problem occurs with the projector, the following checks and measures are recommended before requesting repair.
If this does not resolve the problem, please contact your dealer or service company. They will tell you what warranty condition is applied.



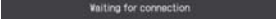



Related messages

When some message appears, check and cope with it according to the following table. Although these messages will be automatically disappeared around several minutes, it will be reappeared every time the power is turned on.

Message	Description
	<p>There is no input signal. Please confirm the signal input connection, and the status of the signal source.</p>
	<p>Projector is waiting for an image file. Check the hardware connection, settings on the projector and network-related settings. The computer-Projector network connection might be disconnected. Please re-connect using “Connect button” of the “LiveViewer”.</p>
	

(continued on next page)

Related messages (continued)

Message	Description
	<p>The horizontal or vertical frequency of the input signal is not within the specified range. Please confirm the specs for your projector or the signal source specs.</p>
	<p>An improper signal is input. Please confirm the specs for your projector or the signal source specs.</p>
	<p>The COMPUTER IN2/MONITOR OUT port is selected as the picture input source even though MONITOR OUT is selected for COMPUTER IN2 (p. 52). Select AUTO or SYNC ON G OFF in the dialog to project the picture input to the COMPUTER IN2/MONITOR OUT port. In this case, you cannot use the MONITOR OUT function. Otherwise select other port for picture input.</p>
	<p>The internal temperature is rising. Please turn the power off, and allow the projector to cool down at least 20 minutes. After having confirmed the following items, please turn the power ON again.</p> <ul style="list-style-type: none"> • Is there blockage of the air passage aperture? • Is the air filter dirty? • Does the peripheral temperature exceed 40°C?
	<p>A note of precaution when cleaning the air filter. Please immediately turn the power off, and clean or change the air filter referring to the “Cleaning and replacing the air filter” section of this manual. After you have cleaned or changed the air filter, please be sure to reset the filter time (p. 58, 132).</p>
	<p>The button operation is not available.</p>

Regarding the indicator lamps

When operation of the **POWER/STATUS1** and **STATUS2** indicators differs from usual, check and cope with it according to the following table.

POWER/STATUS1 indicator	STATUS2 indicator	Description
Lighting In Orange	Turned off	The projector is in a standby state. Please refer to the section "Power on/off".
<i>Blinking</i> In Green	Turned off	The projector is warming up. Please wait.
Lighting In Green	Turned off	The projector is in an on state. Ordinary operations may be performed.
<i>Blinking</i> In Orange	Turned off	The projector is cooling down. Please wait.
<i>Blinking</i> In Red 3 times	<i>Blinking</i> In Red 0 ~ 5 times	The light source does not light. There is a possibility that interior portion has become heated, or that the power supply is unstable. Please turn the power off, and allow the projector to cool down at least 20 minutes. After the projector has sufficiently cooled down, please make confirmation of the following items, and then turn the power on again. <ul style="list-style-type: none"> • Is there blockage of the air passage aperture? • Is the air filter dirty? • Does the peripheral temperature exceed 40°C?

(continued on next page)

Regarding the indicator lamps (continued)

POWER/STATUS1 indicator	STATUS2 indicator	Description
<i>Blinking In Red 7 times</i>	<i>Blinking In Red 1 ~ 6 times</i>	The cooling fan is not operating. Please turn the power off, and allow the projector to cool down at least 20 minutes. After the projector has sufficiently cooled down, please make confirmation that no foreign matter has become caught in the fan, etc., and then turn the power on again. If the same indication is displayed after the remedy, please contact your dealer or service company.
<i>Blinking In Red 2 times</i>	Turned off	The internal temperature is rising. Please turn the power off, and allow the projector to cool down at least 20 minutes. After having confirmed the following items, please turn the power on again. • Is there blockage of the air passage aperture? • Is the air filter dirty? • Does the peripheral temperature exceed 40°C?
<i>Blinking In Red 1 time</i>	Turned off	It is time to clean the air filter. Please immediately turn the power off, and clean or change the air filter referring to the section "Cleaning and replacing the air filter". After cleaning or changing the air filter, please be sure to reset the filter time. After the remedy, turn the power on.

(continued on next page)

Regarding the indicator lamps (continued)

POWER/STATUS1 indicator	STATUS2 indicator	Description
<i>Blinking In Red 9 times</i>	<i>Blinking In Red 1 ~ 7 times</i>	There is a possibility that the interior portion has become overcooled. Please use the unit within the usage temperature parameters (0°C to 40°C). After the treatment, turn the power on.
Normally lighting in Orange . Blinking In Green 2 times for approx. 3 seconds.	Turned off	STANDBY MODE is set to QUICK START. Refer to STANDBY MODE. (📖60)
<i>Blinking In Green for approx. 3 seconds.</i>	Turned off	At least 1 "Power ON" schedule is saved to the projector. Please refer to Schedule Settings section of User's Manual - Network Guide .
Lighting In Orange	Lighting In Red	Loading the saved data of CLONING on STANDBY MODE. Please refer to CLONING (📖80 ~ 83).
<i>Blinking In Red 10 times</i>	<i>Blinking In Red 3 times</i>	Loading the saved data of CLONING has failed on STANDBY MODE. (CLONING LOCK is ON) Please refer to CLONING (📖80 ~ 83).
<i>Blinking In Red 10 times</i>	<i>Blinking In Red 2 times</i>	Loading the saved data of CLONING has failed on STANDBY MODE. (CLONING LOCK is OFF) Please refer to CLONING (📖80 ~ 83).
<i>Blinking In Red 10 times</i>	Turned off	Loading the saved data of CLONING has succeeded on STANDBY MODE. Please refer to CLONING (📖80 ~ 83).

NOTE • When the interior portion has become overheated, for safety purposes, the projector is automatically shut down, and the indicator lamps may also be turned off. In such a case, disconnect the power cord, and wait at least 20 minutes. After the projector has sufficiently cooled down, turn the power on again.

Resetting all settings

When it is hard to correct some wrong settings, the **FACTORY RESET** function of **SERVICE** item in **OPTION** menu (p.83) can reset all settings (except settings such as **STANDBY MODE**, **AUTO BLANK**, **LANGUAGE**, **LIGHT SOURCE TIME**, **FILTER TIME**, **FILTER MESSAGE**, **SECURITY**, **SCHEDULE**, **COMMUNICATION** and **NETWORK**) to the factory default.

Phenomena that may be easy to be mistaken for machine defects

About the phenomenon confused with a machine defect, check and cope with it according to the following table.

Phenomenon	Cases not involving a machine defect	Reference page
Power does not come on.	The electrical power cord is not plugged in. Correctly connect the power cord.	19
	The main power source has been interrupted during operation such as by a power outage (blackout), etc. Please disconnect the power plug from the power outlet, and allow the projector to cool down at least 20 minutes, then turn the power on again.	19, 25
Operations other than power on/off are not available.	OSD MESSAGE is set to INHIBIT. Press the OSD MSG button on the remote control for more than 3 seconds to display the OSD MESSAGE dialog, then change the setting.	34
Neither sounds nor pictures are output.	The signal cables are not correctly connected. Connect the connection cables correctly.	11 ~ 16
	Signal source does not correctly work. Set up the signal source device correctly by referring to the manual of the source device.	—
	The input changeover settings are mismatched. Select the input signal, and correct the settings.	28
	The BLANK function for pictures and the MUTE function for sounds are working. AV MUTE may be active. Refer to the item “Sound does not come out” and “No pictures are displayed” on the next page to turn off the MUTE and BLANK functions.	27, 36

(continued on next page)

Phenomena that may be easy to be mistaken for machine defects (continued)

Phenomenon	Cases not involving a machine defect	Reference page
Sound does not come out.	<p>The signal cables are not correctly connected. Connect the audio cables correctly.</p>	11 ~ 16
	<p>The MUTE function is working. Restore the sound pressing the VOLUME +/- button on the remote control.</p>	27
	<p>The volume is adjusted to an extremely low level. Adjust the volume to a higher level using the menu function or the remote control.</p>	27, 63
	<p>The AUDIO SOURCE/SPEAKER setting is not correct. Set the AUDIO SOURCE/SPEAKER in AUDIO menu correctly.</p>	63
	<p>The Sound checkbox is unchecked. If you have selected USB TYPE B, put a check mark on the Sound checkbox in the Options window of “LiveViewer Lite for USB”. If you have selected LAN, put a check mark on the Sound checkbox in the Option menu of “LiveViewer”.</p>	130

(continued on next page)

Phenomena that may be easy to be mistaken for machine defects (continued)

Phenomenon	Cases not involving a machine defect	Reference page
No pictures are displayed.	<p>The signal cables are not correctly connected. Connect the connection cables correctly.</p>	11 ~ 16
	<p>The brightness is adjusted to an extremely low level. Adjust BRIGHTNESS to a higher level using the menu function.</p>	43
	<p>The computer cannot detect the projector as a plug-and-play monitor. Make sure that the computer can detect a plug-and-play monitor using another plug-and-play monitor.</p>	12
	<p>The BLANK screen is displayed. Press the BLANK button on the remote control.</p>	36
	<p>COMPUTER IN2 is set to MONITOR OUT. Set COMPUTER IN2 to AUTO or SYNC ON G OFF.</p>	52
	<p>The projector does not recognize the USB storage device inserted into USB TYPE A port. Before removing the USB storage device, be sure to use the REMOVE USB function on the thumbnail screen, which appears when the USB TYPE A port is selected as the input source.</p>	15
	<p>"Waiting for connection." remains displayed even though the USB TYPE B port is selected. Remove the USB cable and reconnect after a while.</p>	12
The remote control is not operating.	<p>The projector is not receiving a signal from the remote control. (frequency) See "REMOTE FREQ." under the SERVICE item in the OPTION menu and Changing the frequency of remote control signal. Set either of the following settings. 1. Set 1. NORMAL to ON and 2. HIGH to OFF. On the remote control, set the signal frequency mode to NORMAL. 2. Set 2. HIGH to ON and 1. NORMAL to OFF. On the remote control, set the signal frequency mode to HIGH.</p>	22, 78
MHL power feeding does not work with standby mode.	<p>MHL STANDBY PWR. function is not working. When the STANDBY MODE is set to SAVING/ NETWORK(WOL), MHL power feeding is unavailable with standby mode. Select NORMAL or QUICK START for STANDBY MODE item in the SETUP menu, then select ON for MHL STANDBY PWR. item in the INPUT menu.</p>	54, 60

(continued on next page)

Phenomena that may be easy to be mistaken for machine defects (continued)

Phenomenon	Cases not involving a machine defect	Reference page
Video screen display freezes.	The FREEZE function is working. Press the FREEZE button to restore the screen to normal.	36
Colors have a faded-out appearance, or Color tone is poor.	Color settings are not correctly adjusted. Perform picture adjustments by changing the COLOR TEMP , COLOR , TINT and/or COLOR SPACE settings, using the menu functions.	43, 45, 50
	COLOR SPACE setting is not suitable. Change the COLOR SPACE setting to AUTO , RGB , SMPTE240 , REC709 or REC601 .	50
Pictures appear dark.	The brightness and/or contrast are adjusted to an extremely low level. Adjust BRIGHTNESS and/or CONTRAST settings to a higher level using the menu function.	43
	The projector is operating in LONG LIFE mode or WHISPER mode. Set LIGHT OUTPUT in the LIGHT & FILTER menu to NORMAL(100) .	58
	The light source is approaching the end of its product lifetime. Contact your local dealer.	—
	When the internal temperature is high (even if the ambient temperature is lower than 35°C), the brightness of light source might be reduced automatically. Please clean or replace the air filter.	131
	When the vertical frequency of the input signal is low, light may become dark to reduce flicker. In that case, set FLICKER REDUCTION to OFF or input vertical frequency of more than 60Hz.	40, 77
Pictures appear blurry.	Either the focus and/or horizontal phase settings are not properly adjusted. Adjust the focus using the FOCUS button, and/or H PHASE using the menu function.	31, 48
	The projection window is dirty or misty. Clean the projection window referring to the section “Caring for the projection window”.	134

(continued on next page)

Phenomena that may be easy to be mistaken for machine defects (continued)

Phenomenon	Cases not involving a machine defect	Reference page
Some kind of image degradation such as flickering or stripes appear on screen.	When the projector is operating in LONG LIFE mode or WHISPER mode, flickering may appear on screen. Set LIGHT OUTPUT in the LIGHT & FILTER menu to NORMAL(100).	58
	The OVER SCAN ratio is too big. Adjust OVER SCAN in the IMAGE menu smaller.	47
	Excessive VIDEO NR. Change the setting of VIDEO NR in the INPUT menu.	50
	The FRAME LOCK function cannot work on the current input signal. Set FRAME LOCK in the INPUT menu to OFF.	52
The sound or image is unstable or is output intermittently.	When LAN or USB TYPE B port is selected, some ports of the output may be missing due to signal processing delay. Change the signal or use another port.	28, 63
The computer connected to the USB TYPE B port of the projector does not start up.	The computer cannot start up in the current hardware configuration. Disconnect the USB cable from the computer, then reconnect it after starting up the computer.	12
RS-232C does not work.	The SAVING/NETWORK(WOL) function is working. Select NORMAL or QUICK START for STANDBY MODE item in the SETUP menu.	60
	The COMMUNICATION TYPE for the CONTROL port is set to NETWORK BRIDGE. Select OFF for COMMUNICATION TYPE item in the OPTION - SERVICE - COMMUNICATION menu.	79
Network does not work.	The SAVING/NETWORK(WOL) function is working. Select NORMAL or QUICK START for STANDBY MODE item in the SETUP menu.	60
	The same network address is set for both wireless and wired LAN. Change the network address setting for wireless or wired LAN.	-
NETWORK BRIDGE function does not work.	The NETWORK BRIDGE function is turned off. Select NETWORK BRIDGE for COMMUNICATION TYPE item in the OPTION - SERVICE - COMMUNICATION menu.	79

(continued on next page)

Phenomena that may be easy to be mistaken for machine defects (continued)

Phenomenon	Cases not involving a machine defect	Reference page
Schedule function does not work.	<p>The SAVING/NETWORK(WOL) function is working. Select NORMAL or QUICK START for STANDBY MODE item in the SETUP menu.</p> <p>The internal clock has been reset. When you do not install the battery, once you turn off the projector in the SAVING/NETWORK(WOL) mode or the AC power, the current date and time setting is reset. Check the DATE AND TIME setting in OPTION-SCHEDULE.</p>	60
<p>When the projector is connected to wired LAN, it powers off and on as described below.</p> <p>Powers off ←</p> <p>↓</p> <p>POWER/STATUS1 indicator blinks in orange a few times</p> <p>↓</p> <p>Goes into standby mode</p>	<p>Disconnect the LAN cable and check that the projector is working properly.</p> <p>If this phenomenon occurs after connecting to the network, there may be a loop between two Ethernet switching hubs within the network, as explained below.</p> <ul style="list-style-type: none"> - There are two or more Ethernet switching hubs in a network. - Two of the hubs are doubly connected by LAN cables. - This double connection forms a loop between the two hubs. <p>Such a loop may have an adverse effect on the projector as well as the other network devices.</p> <p>Check the network connection and remove the loop by disconnecting the LAN cables such that there is only one connecting cable between two hubs.</p>	-
Unable to save the CLONING data.	<p>USB memory is out of memory.</p> <ul style="list-style-type: none"> • Please delete unnecessary files to free up memory. At least 1MB of memory is needed. • USB memory is write-protected. Unlock the USB memory. 	
Unable to load the CLONING saved data.	<p>Unable to find the saved data from USB memory.</p> <ul style="list-style-type: none"> • Execute SAVE then LOAD by going through the procedure. • File name of USB memory does not match. Please assign "pj_data.bin" for setting data, and for MyScreen "pj_logo.bmp" or "pj_logo.gif". • The SAVING/NETWORK(WOL) function is working. Switch the SAVING to NORMAL or QUICK START in STANDBY MODE under SETUP menu beforehand to load the CLONING data using control panel on the projector while the projector is in standby state. 	80 ~ 83

NOTE • Although bright spots or dark spots may appear on the screen, this is a unique characteristic of liquid crystal displays, and it does not constitute or imply a machine defect.

Phenomena that may be easy to be mistaken for machine defects (continued)

Phenomenon	Cases not involving a machine defect	Reference page
When using the interactive function PC INTERACTIVE mode, the projector can not be recognized.	Is the power of the projector turned on? Check to ensure that the POWER/STATUS1 indicator of the projector is lit in green.	138
	Is the USB cable connected correctly? Connect the USB cable to the computer.	92
	Has PC INTERACTIVE mode been activated? Press the INTERACTIVE button or set to PC INTERACTIVE from the menu.	96
	Has calibration been performed? Press the INTERACTIVE button or perform calibration from the menu.	29, 94, 95
The pen does not operate.	This may be due to poor contact of the battery. Remove the battery and load it again. Be sure to use only the batteries specified.	24
	Has the battery run out? Replace it with a new one.	24
	Is the projector positioned too close to the screen? Install and use at a position where the screen size is between 60"-100" when digital zoom is at the maximum (100%).	55
	Has calibration been performed? Press the INTERACTIVE button or perform calibration from the menu.	29, 94, 95
	Are the projector and screen used at the following places? - Place near an inverter fluorescent light. - Near infrared remote control or infrared microphone. - Place that is exposed to direct sunlight.	116
	Is ambient light falling on the screen? Darken illumination or close the curtain so that the light cannot fall on the screen as much as possible.	116

(continued on next page)

Phenomena that may be easy to be mistaken for machine defects (continued)

Phenomenon	Cases not involving a machine defect	Reference page
The pen does not operate.	<p>Is transmission between the pen and the projector obstructed? Make sure that the area between the sensor at the top surface of the projector and the screen is not obstructed (transparent and meshed objects are also not allowed). For example, the Interactive Function does not function if the projector is enclosed with only the lens exposed, such as when a casing for theft prevention is used.</p>	111
	<p>Is the camera lens dirty? If the camera lens is dirty, wipe it off with a lens cleaning cloth.</p>	134
	<p>Other than those above Remove and insert the USB cable.</p>	92
Pen action is unstable or pen stops operating.	<p>Is the power supply for the projector used at the same time for other electrical products that require a measurable amount of power? Use a separate power supply for other electrical products with a high power consumption.</p>	19
	<p>Has the battery run out? Replace it with a new one.</p>	24
	<p>Is FINGER TOUCH item of IWB SETUP menu set to ON ? Set to OFF except for using optional Finger Touch Unit (FT-01B).</p>	-
	<p>Other than those above</p> <ul style="list-style-type: none"> • Disconnect the power supply for the projector and connect again. • Restart Windows®. 	19
Lines cannot be drawn properly or are broken.	<p>Has the battery run out? Replace it with a new one.</p>	24
	<p>Is the tip of the pen worn out? Replace the tip of the pen with a new one.</p>	24

(continued on next page)

Phenomena that may be easy to be mistaken for machine defects (continued)

Phenomenon	Cases not involving a machine defect	Reference page
The tip of the pen does not coincide with the pen cursor.	<p>Has calibration been performed? Press the INTERACTIVE button or perform calibration from the menu.</p>	29, 94, 95
	<p>Is FINGER TOUCH item of IWB SETUP menu set to ON ? Set to OFF except for using optional Finger Touch Unit (FT-01B).</p>	-
	<p>Is the projector tilting? The projector does not operate properly when it is tilting largely. Install the projector horizontally and vertically correct before performing calibration.</p>	94, 95
	<p>Actual resolution may be different due to output image with a black frame depending on the type of laptop PC. In this case, perform the area setup, using IWB AREA SETUP item of CALIBRATE SETUP menu. Calibration may be necessary again when you use different PC.</p>	94, 95

(continued on next page)

Phenomena that may be easy to be mistaken for machine defects (continued)

Phenomenon	Cases not involving a machine defect	Reference page
Calibration of the pen position cannot be performed correctly.	<p>Is the projector correctly installed? Check the installed position of the projector.</p>	116
	<p>Is the computer image projected within the area of the screen? Install and use at a position where the screen size is between 60"-100". Do not set the KEYSTONE and PERFECT FIT functions to extreme settings.</p>	56
	<p>Is a part of the image enlarged using the Magnify function? Press the MAGNIFY OFF button on the remote control to restore the normal display.</p>	35
	<p>Is ASPECT set to NATIVE and the display resolution of the computer larger than 1280 x 800? Set ASPECT to NORMAL, or set the display resolution of the computer to lower than 1280 x 800.</p>	47
	<p>Is ambient light falling on the screen? Darken illumination or close the curtain so that the light cannot fall on the screen as much as possible.</p>	116
	<p>AUTO CALIBRATE may fail when the shadow of a person is reflected on the screen. Stay away from the screen when performing AUTO CALIBRATE.</p>	94
	<p>Perform MANUAL CALIBRATE when AUTO CALIBRATE failed many times or the position of pen does not coincide with the drawn line after executing AUTO CALIBRATE.</p>	95
The interactive pen or system does not work properly or intermittently works.	<p>This may be due to exhaustion of the battery of the pen. Replace the battery with new one. Use only the specified and perfect battery. When putting it in, be careful not to make a mistake in polarity.</p>	24
	<p>This may be due to poor contact of the battery in the pen. Remove the battery and load it again. Use only the specified and perfect battery. When putting it in, be careful not to make a mistake in polarity.</p>	24

(continued on next page)

Phenomena that may be easy to be mistaken for machine defects (continued)

Phenomenon	Cases not involving a machine defect	Reference page
<p>The interactive pen or system does not work properly or intermittently works.</p>	<p>There may be obstacles in between the interactive pen and sensors (Camera) on the projector. Remove all things between the pen and sensor (Camera).</p>	<p>111</p>
	<p>The way of you hold the pen or your position may affect the system. Hold the pen as perpendicular to the interactive surface as possible and be careful not to block the path from the pen to the sensor (Camera).</p>	
<p>The mouse cursor or drawing image does not match with the actual pen tip point.</p>	<p>Calibrate again to optimize the interactive system.</p>	<p>29, 94, 95</p>
<p>The LiveViewer Software and Starboard Software may work at the same time.</p>	<p>The LiveViewer may not display the annotations that are made by Starboard Software. Use the latest LiveViewer software to support Starboard software annotation. Meantime, please use Starboard software on COMPUTER IN or HDMI inputs.</p>	<p>92</p>
<p>AUTO/ MANUAL CALIBRATE fails.</p>	<p>Is ambient light falling on the screen? Darken illumination or close the curtain so that the light cannot fall on the screen as much as possible.</p>	<p>116</p>
	<p>Other than the above</p>	<p>94, 95</p>

(continued on next page)

Phenomena that may be easy to be mistaken for machine defects (continued)

Phenomenon	Cases not involving a machine defect	Reference page
The computer does not boot.	<p>In BIOS setting, don't you use USB area for BOOT? This product has USB memory area. While the projector and the computer are connected using USB cable, if the computer is powered on after the projector is powered on, the computer uses USB memory area for BOOT so that the computer might not starts up. As the countermeasure, try following.</p> <ul style="list-style-type: none"> • Disconnect USB cable and reboot the computer. • In BIOS setting, set USB area not to use for BOOT. 	—
	<p>Don't you use USB cable other than the one combined together with this product ? If you use a USB cable other than the one combined together with this product, the computer might not start up.</p>	—
	<p>Don't you use repeater cable? If you use repeater cable, the computer might not start up.</p>	—

Specifications

Please see the **Specifications** in the **User's Manual (concise)** which is a book.

End User License Agreement for the Product Software

- Software in the projector consists of the plural number of independent software modules and there exist our copyright and/or third party copyrights for each of such software modules.
- Be sure to read "End User License Agreement for the Product Software" which is separated document.

DUKANE CORP AV SERVICE DEPT
 2900 Dukane Drive
 St Charles, IL 60174
 800-676-2487 / 630-762-
 Fax 630-584-5156
 avservice@dukane.com
 www.dukaneav.com

Trademark acknowledgment

- Windows® and Internet Explorer® are registered trademarks of Microsoft Corporation in the U.S. and/or other countries.
- VESA and DDC are trademarks of the Video Electronics Standard Association.
- HDMI, the HDMI logo, and High-Definition Multimedia Interface are trademarks or registered trademarks of HDMI Licensing LLC in the United States and other countries.
- MHL®, the MHL logo, and Mobile High-Definition Link are trademarks or registered trademarks of MHL, LLC in the United States and other countries.
- Trademark PJLink is a trademark applied for trademark rights in Japan, the United States of America and other countries and areas. 
- Blu-ray Disc™ and Blu-ray™ are trademarks of Blu-ray Disc Association.
- DICOM® is the registered trademark of the National Electrical Manufacturers Association for its standards publications relating to digital communications of medical information.
- StarBoard® is a registered trademark of StarBoard Solution Ltd. in Japan and other countries.
- Adobe® and Acrobat®, Reader® are registered trademarks of Adobe Systems Incorporated.

All other trademarks are the properties of their respective owners.