

DYMO[®]

COLORPOP![™]



User Guide

Copyright

© 2018 Newell Rubbermaid Europe, LLC. All rights reserved. Rev. 12/18

No part of this document may be reproduced or transmitted in any form or by any means or translated into another language without the prior written consent of Newell Rubbermaid Europe, LLC.

Trademarks

DYMO and COLORPOP! are trademarks of Newell Rubbermaid Europe, LLC and Sanford, L.P. All other trademarks are the property of their respective holders.

FCC Statement

Caution: The user is cautioned that changes or modifications not expressly approved by the party responsible for compliance could void the user's authority to operate the equipment.

Note: This equipment has been tested and found to comply with the limits for a Class B digital device, pursuant to part 15 of the FCC Rules. These limits are designed to provide reasonable protection against harmful interference in a residential installation. This equipment generates, uses and can radiate radio frequency energy and, if not installed and used in accordance with the instructions, may cause harmful interference to radio communications. However, there is no guarantee that interference will not occur in a particular installation. If this equipment does cause harmful interference to radio or television reception, which can be determined by turning the equipment off and on, the user is encouraged to try to correct the interference by one or more of the following measures:

- Reorient or relocate the receiving antenna.
- Increase the separation between the equipment and receiver.
- Connect the equipment into an outlet on a circuit different from that to which the receiver is connected.
- Consult the dealer or an experienced radio/TV technician for help.

Contents

About Your New Printer	3
Registering Your Printer	3
General Safety Precautions	3
Getting Started	3
Connecting the Power	3
Inserting the Batteries	3
Connecting the Optional Power Adapter	3
Inserting and Removing the Label Cassette	3
Using the Printer for the First Time	4
Getting to Know the Printer	4
Power	4
LCD Display	5
Navigation Keys	5
Cancel	5
Backspace	5
Caps Mode	5
Settings	5
Adding Emojis, Punctuation, and Special Characters	5
Adding Emojis	5
Adding Symbols and Punctuation	5
Adding International Characters	5
Formatting Your Label	5
Changing the Font Size	5
Changing the Font Style	5
Adding Border and Underline Styles	6
Creating Vertical Labels	6
Creating Two-Line Labels	6
Emojis	7
Symbols and Punctuation	7
Environmental Information	9

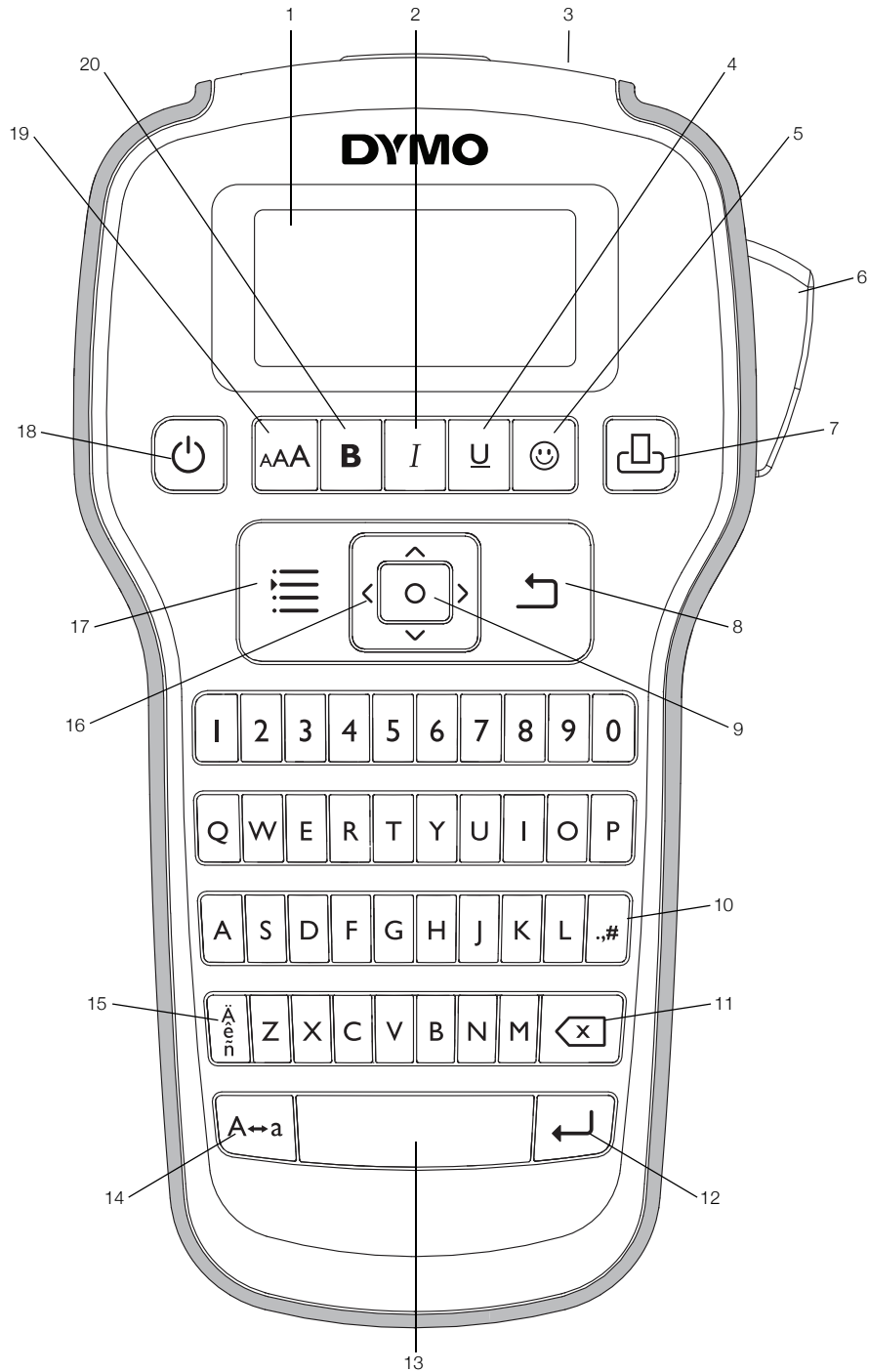

Figure 1 COLORPOP! Label Printer

- | | | |
|----------------------------|---------------------------------|-------------------------------|
| 1 LCD display | 8 Cancel | 15 Accented characters |
| 2 Italic | 9 OK | 16 Navigation |
| 3 Label exit slot | 10 Symbols – Punctuation | 17 Menu |
| 4 Underline/Borders | 11 Backspace | 18 On/Off |
| 5 Emojis | 12 Return | 19 Font size |
| 6 Cutter button | 13 Space bar | 20 Bold |
| 7 Print | 14 Caps | |

About Your New Printer

With the DYMO COLORPOP! printer, you can create a wide variety of high-quality, self-adhesive labels. You can customize your labels using many different font sizes, font styles, emojis, and symbols. The printer works best with DYMO COLORPOP! 1/2" (12 mm) label cassettes. Labels are available in a wide range of colors.

Visit www.dymo.com for information on obtaining labels and accessories for your printer.

Registering Your Printer

Visit www.dymo.com/register to register your printer online.

Register your printer to receive these benefits:

- Notification of availability of upgrades by email
- Special offers and new product announcements

During the registration process, you will need the serial number, which is located inside the back cover of the printer.

General Safety Precautions

Follow the guidelines in this section to use this product safely.

Batteries/Power Adapter

- Use only alkaline batteries.
- Do not mix different types or brands of batteries.
- Make sure the batteries have the same expiration dates.
- Use only DYMO-branded power adapter.
- Do not handle power adapter if your hands are wet.
- Do not cut, damage, alter, or place heavy objects on the power adapter.
- Do not use the power adapter if it is damaged.

Label Printer

- Do not insert objects into or block the label exit slot.
- Do not touch the cutter blade. Personal injury could result.
- Do not allow any liquids to come into contact with the printer.
- Do not disassemble the printer. For inspection, adjustment, or repair, contact DYMO Customer Support (<http://support.dymo.com>).

DYMO Label Cassettes

- Use only DYMO-branded label cassettes in this printer.
- Do not use any unauthorized accessories or supplies.
- Clean the surface before applying the adhesive label or the label may not adhere correctly and could peel off easily.
- Do not expose the labels to extreme heat or sunlight.

Getting Started

Follow the instructions in this section to print your first label.

Connecting the Power

The printer is powered by alkaline batteries or an optional AC power adapter. To save power, the printer automatically turns off after two minutes of inactivity.

Inserting the Batteries

The printer is powered by six AAA alkaline batteries.

To insert the batteries

- 1 Press the thumb latch on the back of the printer to remove the battery compartment cover.

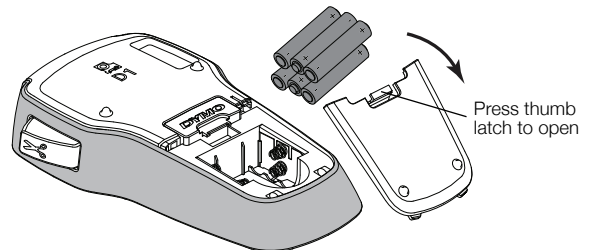

- 2 Insert the batteries following the polarity markings (+ and -).

- 3 Replace the battery compartment cover.

 Remove the batteries if the printer will not be used for a long period of time.

Connecting the Optional Power Adapter

An optional 9 Volt, 2 A power adapter can be used to power the printer. Connecting the power adapter to the printer disconnects the batteries as a power source.

To connect the optional power adapter

- 1 Plug the power adapter into the power connector on the top of the printer.
- 2 Plug the other end of the power adapter into a power outlet.

Inserting and Removing the Label Cassette

Your printer works best with DYMO COLORPOP! label cassettes. Visit www.dymo.com for information about purchasing additional label cassettes.

 Cutter blade is extremely sharp. While replacing the label cassette, keep fingers and other body parts away from cutter blade and do not press the cutter button.

To insert the label cassette

- 1 Lift the label cassette cover to open the label compartment.

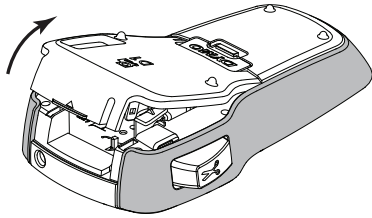

- 2 Make sure that the tape and ribbon are taut across the mouth of the cassette and that **the tape passes under the label guides**.

If necessary, turn the ribbon rewind spool clockwise to tighten the ribbon.

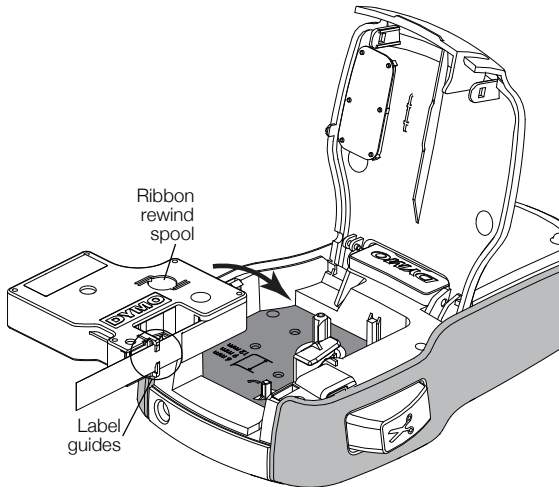

- 3 Insert the cassette and press firmly until the cassette clicks into place.

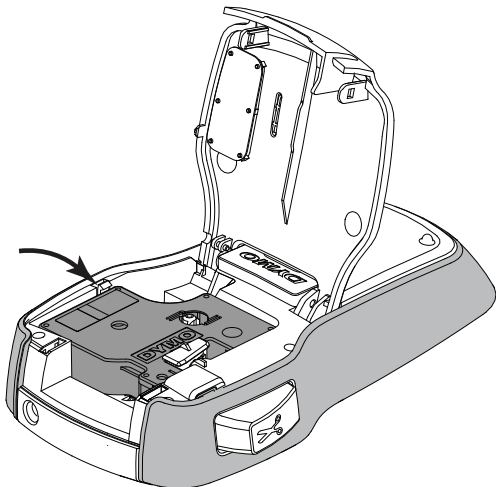

- 4 Close the label cassette cover.

 Each time you change the label cassette, you will be prompted to choose the label width.

To remove the label cassette

- 1 Lift the label cartridge door on the back of the printer.
- 2 Remove the label cassette.



- 3 Insert a new label cassette as described above.
- 4 Select the new label width when prompted by the printer.

Using the Printer for the First Time

The first time you turn on the power, you are asked to select the label width and language. If you are outside the United States, you may also be asked to set the units of measure. These selections remain set until you change them.

You can change these selections using the  key.

To set up the printer

- 1 Press  to turn on the printer.
- 2 Make your selections as prompted and press .

 Each time you change the label cassette, you will be prompted to choose the label width.

You are now ready to print your first label.

To print a label

- 1 Enter text and choose format options to create a custom message.
- 2 Press .
- 3 Press the cutter button to cut the label.
- 4 Remove the backing from the label to expose the adhesive, and then stick!

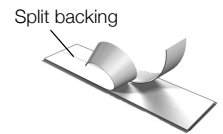

Congratulations! You printed your first label. Continue reading to learn more about the options available for creating labels.

Getting to Know the Printer

Become familiar with the location of the function keys on your printer. Refer to Figure 1 on page 2. The following sections describe each feature in detail.

Power

The  key turns the printer on and off. After two minutes of inactivity, the printer is switched off automatically.

When the printer is turned off, the current label text and formatting are remembered and will be displayed when power to the printer is turned back on.

When the batteries are removed and the optional power adapter is disconnected, the current label text and formatting are lost.

LCD Display

With DYMO's exclusive graphical display, most of the formatting you add is visible instantly.

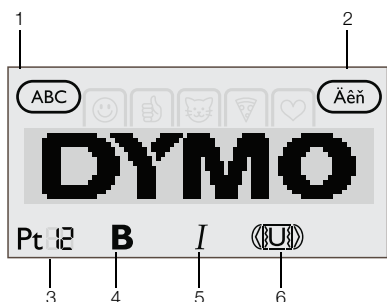

- | | |
|-----------------------|---------------------|
| 1 Uppercase | 4 Bold |
| 2 Accented characters | 5 Italic |
| 3 Font size | 6 Underline/Borders |

Feature indicators along the top and bottom of the LCD display appear black when a feature or setting is selected.

Navigation Keys

You can review and edit your label using the left and right navigation keys. You can move through menu selections using all four navigation keys, and then press  to make a selection.

Cancel

The  key exits from a menu without making a selection or cancels an action, such as printing.

Backspace

The  key deletes the character to the left of the cursor.

Pressing and holding the  key quickly deletes the characters to the left of the cursor.

Caps Mode

The  key toggles capitalization on or off. When CAPS mode is on, all the letters entered are in uppercase. When CAPS mode is off, all the letters entered are in lowercase. The default setting is CAPS mode on.

Settings

The  key displays the Settings menu where you can change the orientation, label width, units of measure (outside the United States), and language.

Adding Emojis, Punctuation, and Special Characters

You can add emojis, punctuation, and other special characters to your labels.

Adding Emojis

The printer includes the emojis shown on page 7.

To insert emojis

- 1 Press .
- 2 Use the navigation keys to select the category of emojis.



- 3 Use the navigation keys to select the desired emoji.

- 4 Press  to add the emoji to your label.

Adding Symbols and Punctuation

The printer supports the extended symbol and punctuation set shown on page 7.

To insert a symbol or punctuation

- 1 Press .
- 2 Use the navigation keys to select the desired symbol or punctuation.
- 3 Press  to add the symbol or punctuation to your label.



Adding International Characters

The printer supports the extended Latin character set.

Pressing  followed by a letter displays all of the available variations of that letter.

For example, if you press  and then the letter **a**, you will see **à á â ã ä** and so on through all the variations available.

To add accented characters

- 1 Press  and then press an alpha character.
The accent variations for that alpha character are displayed.
- 2 Use the navigation keys to select the character you want and press .

 You can also access the accent variations for a letter by pressing and briefly holding the corresponding alpha key.

Formatting Your Label

You can choose from several format options to enhance the appearance of your labels.

Changing the Font Size

Several font sizes are available for your labels: 8, 10, 12, 16, 20, and 24 point. The font size applies to all characters on a label. For two-line labels, the maximum font size is 12 point.

To change the font size

- ▶ Press  until the desired font size is displayed.

Changing the Font Style

Two font styles are available: bold and italic. These styles can be combined.

 Font styles are applied to all symbols and alphanumeric characters. However, font styles are not applied to emojis.

To change the font style

- ▶ Press **B** to add or remove bold.
- ▶ Press **I** to add or remove italic.

The style is instantly visible in the display.

Adding Border and Underline Styles

You can highlight the text by adding a border or underline style.

Five styles are available:

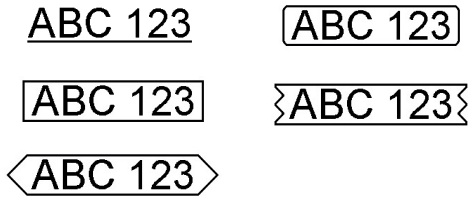

To add a border or underline

- ▶ Press  until the desired border or underline style is displayed.

A label can be underlined or enclosed within a border but not both together.





When adding an underline on a two-line label, each line is underlined. When adding a border on a two-line label, both lines are enclosed in a single border.

Creating Vertical Labels

You can print labels with the text oriented vertically.

When printing two-line vertical labels, the label will print with the second line of text after the first line.

To create a vertical label



- 1 Press .
- 2 Press  to select **Orientation**.
- 3 Use the navigation keys to select  vertical orientation.
- 4 Press .

 The underline style will not print on a vertical label.

Creating Two-Line Labels

You can print a maximum of two lines on a label.

To create a two-line label

- 1 Enter text for the first line and press .
The  symbol appears. This symbol is not printed.
- 2 Enter text for the second line.
- 3 Press  to print.

Caring for Your Printer

Your printer is designed to give you long and trouble-free service, while requiring very little maintenance. Clean your printer regularly to keep it working properly. Clean the cutter blade each time you replace the label cassette.

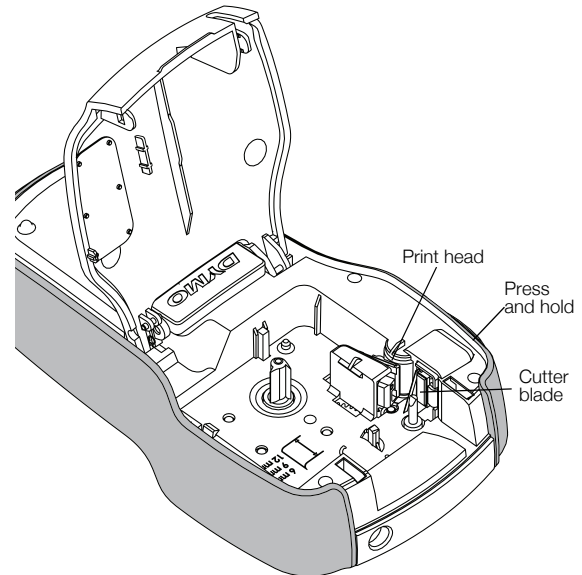

 The cutter blade is extremely sharp. Avoid direct contact with the cutter blade while cleaning the blade.

To clean the cutter blade

- 1 Remove the label cassette.
- 2 Press and hold the cutter button to expose the cutter blade.
- 3 Use a cotton swab and alcohol to clean both sides of the blade.

 The print head can become very hot. Use caution when working near the print head.



Emojis

Symbols and Punctuation

'	"	,	.	;
!	?	i	¿	—
'	:	/	\	
§	•	¶	°	∞
€	\$	¢	£	¥
@	&	#	%	‰
+	-	*	÷	√
^	~	≈	=	≠
±	<	>	≤	≥
[]	½	¼	¾
()	{	}	⅓
0	1	2	3	4
5	6	7	8	9
°	1	2	3	4
5	6	7	8	9
α	β	γ	δ	ε
ζ	η	θ	ι	κ
λ	μ	ν	ξ	ο
π	ρ	σ	τ	υ
φ	χ	ψ	ω	
A	B	Γ	Δ	E
Z	H	Θ	I	K
Λ	M	N	Ξ	O
Π	P	Σ	T	Υ
Φ	Χ	Ψ	Ω	

Troubleshooting

Review the following possible solutions if you encounter a problem while using your printer.

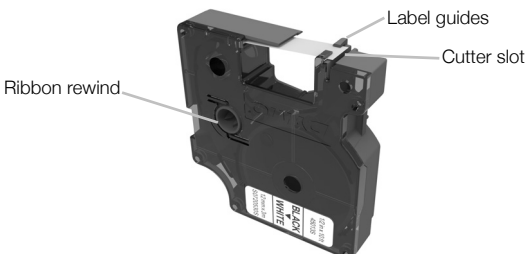
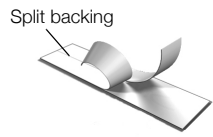
Problem/Error Message	Solution
No display	<ul style="list-style-type: none"> Ensure the printer is turned on. Replace batteries or connect the optional power adapter.
Poor print quality	<ul style="list-style-type: none"> Replace batteries or connect the optional power adapter. Ensure label cassette is installed properly. Replace the label cassette. Clean the print head. Contact Customer Support for instructions.
Poor cutter performance	Clean the cutter blade.
Printing...	No action required. Message disappears when printing is finished.
Too many characters! Exceeded maximum number of characters in buffer	Additional characters cannot be added.
Too many lines! Exceeded maximum number of lines	<ul style="list-style-type: none"> Delete a line to fit text within the label width. Insert a wider label cassette. <p>Up to two lines of text are allowed on 1/2" (12 mm) labels.</p>
 Battery low	Replace batteries or connect the optional power adapter.
Insert cassette! No label cassette is inserted.	Insert a label cassette. See "Inserting and Removing the Label Cassette" .
Label jam! Motor is stalled due to label jam.	<ol style="list-style-type: none"> Remove the label cassette. Make sure the tape and ribbon are taut across the top of the cassette and that the tape passes under the label guides. If necessary, turn the ribbon rewind spool clockwise to tighten the ribbon.
	<div style="display: flex; justify-content: space-around; align-items: center;"> <div style="text-align: center;"> <p>Correct</p>  </div> <div style="text-align: center;"> <p>Incorrect</p>  </div> </div> <div style="text-align: center; margin-top: 20px;">  </div>
	<ol style="list-style-type: none"> Make sure the tape extends at least 1/8" past the label guides and is not caught under the guides.
How do I remove the backing from the label?	<p>DYMO labels have an easy-to-peel split back.</p> <ol style="list-style-type: none"> Locate the split on the label backing. Gently pinch the label length-wise, folding toward the printed side of the label. The label backing will separate. Carefully peel away the backing from the label.
	

If you need further assistance, visit the DYMO Web site at www.dymo.com.

Documentation Feedback

We are constantly working to produce the highest quality documentation for our products. We welcome your feedback. Send us your comments or suggestions about our user guides. Please include the following information with your feedback:

- Product name, model number, and User Guide page number
- Brief description of instructions that are inaccurate or unclear, areas where more detail is needed, and so on

We also welcome your suggestions about additional topics you would like to see covered in the documentation.

Send email messages to: dymo.docfeedback@newellco.com

Keep in mind that this email address is **only for documentation feedback**. If you have a technical question, contact Customer Support.

Environmental Information

The equipment that you have bought requires the extraction and use of natural resources for its production. It may contain substances that are hazardous to health and the environment.

In order to avoid the dissemination of those substances in our environment, and to diminish the pressure on natural resources, we encourage you to use the appropriate take-back systems. These systems will reuse or recycle most of the materials of your end-of-life equipment in an environmentally sound way.

The crossed-bin symbol marked on your device indicates you should use these systems.



If you need more information on the collection, reuse, and recycling of this product, please contact your local or regional waste administration.

You can also contact DYMO for more information on the environmental performance of our products.