

Operating Guide

PS 9000 2U

DC Laboratory Power Supply



Attention! This document is only valid for devices color display and with firmware "KE: 3.07" (standard models) or "KE: 2.11" (GPIB models) and "HMI: 2.03" or higher. For availability of updates for your device check our website or contact us.



TABLE OF CONTENTS

1 GENERAL

1.1	About this document	5
1.1.1	Retention and use	5
1.1.2	Copyright	5
1.1.3	Validity	5
1.1.4	Explanation of symbols	5
1.2	Warranty	5
1.3	Limitation of liability	5
1.4	Disposal of equipment	6
1.5	Product key	6
1.6	Intended usage	6
1.7	Safety	7
1.7.1	Safety notices	7
1.7.2	Responsibility of the user	8
1.7.3	Responsibility of the operator	8
1.7.4	User requirements	8
1.7.5	Alarm signals	9
1.8	Technical data	9
1.8.1	Approved operating conditions	9
1.8.2	General technical data	9
1.8.3	Specific technical data	10
1.8.4	Views	22
1.8.5	Control elements	25
1.9	Construction and function	26
1.9.1	General description	26
1.9.2	Block diagram	26
1.9.3	Scope of delivery	27
1.9.4	Options	27
1.9.5	The control panel (HMI)	28
1.9.6	USB port	30
1.9.7	Ethernet port	30
1.9.8	Analog interface	30
1.9.9	Share Bus-Connection	31
1.9.10	Sense connector (remote sensing)	31
1.9.11	GPIO port (optional)	31

2 INSTALLATION & COMMISSIONING

2.1	Transport and storage	32
2.1.1	Transport	32
2.1.2	Packaging	32
2.1.3	Storage	32
2.2	Unpacking and visual check	32
2.3	Installation	32
2.3.1	Safety procedures before installation and use	32
2.3.2	Preparation	33
2.3.3	Installing the device	33
2.3.4	Connection to AC supply	34
2.3.5	Connection to DC loads	34
2.3.6	Grounding of the DC output	35
2.3.7	Connection of remote sensing	36

2.3.8	Connecting the "Share" bus	36
2.3.9	Connecting the analog interface	37
2.3.10	Connecting the USB port	37
2.3.11	Initial commission	37
2.3.12	Commission after a firmware update or a long period of non-use	37
2.3.13	Initial network setup	38

3 OPERATION AND APPLICATION

3.1	Personal safety	39
3.2	Operating modes	39
3.2.1	Voltage regulation / Constant voltage	39
3.2.2	Current regulation / constant current / current limiting	40
3.2.3	Power regulation / constant power / power limiting	40
3.3	Alarm conditions	41
3.3.1	Power Fail	41
3.3.2	Overtemperature	41
3.3.3	Overvoltage	41
3.3.4	Overcurrent	41
3.3.5	Overpower	41
3.4	Manual operation	42
3.4.1	Switching on the device	42
3.4.2	Switching off the device	42
3.4.3	Configuration in the setup menu	42
3.4.4	Adjustment limits	47
3.4.5	Manual adjustment of set values	48
3.4.6	Switching the main screen view	48
3.5	Remote control	49
3.5.1	General	49
3.5.2	Control locations	49
3.5.3	Remote control via a digital interface	49
3.5.4	Remote control via the analog interface	50
3.6	Alarms and monitoring	54
3.6.1	Definition of terms	54
3.6.2	Device alarm handling	54
3.7	Control panel (HMI) lock	55
3.8	Loading and saving a user profile	56
3.9	Other applications	57
3.9.1	Parallel operation in Share Bus mode	57
3.9.2	Series connection	58
3.9.3	Operation as battery charger	58
3.9.4	Two quadrants operation (2QO)	59

4 SERVICE AND MAINTENANCE

4.1	Maintenance / cleaning	61
4.2	Fault finding / diagnosis / repair	61
4.2.1	Replacing a defect mains fuse	61
4.2.2	Firmware update	61

4.3	Calibration (readjustment)	62
4.3.1	Preface	62
4.3.2	Preparation.....	62
4.3.3	Calibration procedure	62

5 CONTACT AND SUPPORT

5.1	Repairs	64
5.2	Contact options	64

1. General

1.1 About this document

1.1.1 Retention and use

This document is to be kept in the vicinity of the equipment for future reference and explanation of the operation of the device. This document is to be delivered and kept with the equipment in case of change of location and/or user.

1.1.2 Copyright

Reprinting, copying, also partially, usage for other purposes as foreseen of this manual are forbidden and breach may lead to legal process.

1.1.3 Validity

This manual is valid for the following equipment with TFT color display:



Model	Article nr..
PS 9040-40 2U	06230219
PS 9080-40 2U	06230204
PS 9200-15 2U	06230205
PS 9360-10 2U	06230206
PS 9500-06 2U	06230207
PS 9750-04 2U	06230208

Model	Article nr..
PS 9040-60 2U	06230220
PS 9080-60 2U	06230209
PS 9200-25 2U	06230210
PS 9360-15 2U	06230211
PS 9500-10 2U	06230212
PS 9750-06 2U	06230213

Model	Article nr..
PS 9040-120 2U	06230221
PS 9080-120 2U	06230214
PS 9200-50 2U	06230215
PS 9360-30 2U	06230216
PS 9500-20 2U	06230217
PS 9750-12 2U	06230218

1.1.4 Explanation of symbols

Warning and safety notices as well as general notices in this document are shown in a box with a symbol as follows:

	Symbol for a life threatening danger
	Symbol for general safety notices (instructions and damage protection bans) or important information for operation
	<i>Symbol for general notices</i>

1.2 Warranty

EA Elektro-Automatik guarantees the functional competence of the applied technology and the stated performance parameters. The warranty period begins with the delivery of free from defects equipment.

Terms of guarantee are included in the general terms and conditions (TOS) of EA Elektro-Automatik.

1.3 Limitation of liability

All statements and instructions in this manual are based on current norms and regulations, up-to-date technology and our long term knowledge and experience. The manufacturer accepts no liability for losses due to:

- Usage for purposes other than designed
- Use by untrained personnel
- Rebuilding by the customer
- Technical changes
- Use of not authorized spare parts

The actual delivered device(s) may differ from the explanations and diagrams given here due to latest technical changes or due to customized models with the inclusion of additionally ordered options.

1.4 Disposal of equipment

A piece of equipment which is intended for disposal must, according to European laws and regulations (ElektroG, WEEE) be returned to the manufacturer for scrapping, unless the person operating the piece of equipment or another, delegated person is conducting the disposal. Our equipment falls under these regulations and is accordingly marked with the following symbol:



1.5 Product key

Decoding of the product description on the label, using an example:

PS 9 080 - 40 2U zzz

										Field for identification of installed options and/or special models S01...S0x = Special models 3W = Option 3W installed (GPIB port instead of Ethernet port)
										Construction (not always given) 2U = 19" frame with 2U
										Maximum current of the device in Ampere
										Maximum voltage of the device in Volt
										Series : 9 = Series 9000
										Type identification: PS = Power Supply, usually programmable

1.6 Intended usage

The equipment is intended to be used, if a power supply or battery charger, only as a variable voltage and current source, or, if an electronic load, only as a variable current sink.

Typical application for a power supply is DC supply to any relevant user, for a battery charger the charging of various battery types and for electronic loads the replacement of an ohmic resistor by an adjustable DC current sink in order to load relevant voltage and current sources of any type.



- Claims of any sort due to damage caused by non-intended usage will not be accepted.
- All damage caused by non-intended usage is solely the responsibility of the operator.

1.7 Safety

1.7.1 Safety notices

Mortal danger - Hazardous voltage



- **Electrical equipment operation means that some parts can be under dangerous voltage. Therefore all parts under voltage must be covered! This basically applies to all models, though 40 V models according to SELV can not generate hazardous DC voltage!**
- **All work on connections must be carried out under zero voltage (output not connected to load) and may only be performed by qualified and informed persons. Improper actions can cause fatal injury as well as serious material damage!**
- **Never touch cables or connectors directly after unplugging from mains supply as the danger of electric shock remains!**
- **Never touch the contacts on DC output terminal directly after switching off the DC output, because there still can dangerous voltage present, sinking more or less slowly depending on the load! There also can be dangerous potential between negative DC output to PE or positive DC output to PE due to charged X capacitors.**
- **Always follow 5 safety rules when working with electric devices:**
 - **Disconnect completely**
 - **Secure against reconnection**
 - **Verify that the system is dead**
 - **Carry out earthing and short-circuiting**
 - **Provide protection from adjacent live parts**



- The equipment must only be used as intended
- The equipment is only approved for use within the connection limits stated on the product label.
- Do not insert any object, particularly metallic, through the ventilator slots
- Avoid any use of liquids near the equipment. Protect the device from wet, damp and condensation.
- For power supplies: do not connect consumers while the DC output is switched on; sparking may occur which can cause burns on the hands and also damage the material.
- For electronic loads: do not connect power sources to equipment under power, sparking may occur which can cause burns as well as damage to the equipment and to the source.
- ESD regulations must be applied when plugging interface cards or modules into the relative slot
- Interface cards or modules may only be attached or removed after the device is switched off. It isn't necessary to open the device.
- Do not connect external power sources with reversed polarity to DC input or outputs! The equipment will be damaged.
- For power supply devices: avoid where possible connecting external power sources to the DC output, and never those that can generate a higher voltage than the nominal voltage of the device.
- For electronic loads: do not connect a power source to the DC input which can generate a voltage more than 120% of the nominal input voltage of the load. The equipment isn't protected against over voltage and may be irreparably damaged.
- Never insert a network cable which is connected to Ethernet or its components into the master-slave socket on the back side of the device!
- Always configure the various protecting features against overvoltage overpower etc. for sensitive loads to what the currently used application requires

1.7.2 Responsibility of the user

The equipment is in industrial operation. Therefore the operators are governed by the legal safety regulations. Alongside the warning and safety notices in this manual the relevant safety, accident prevention and environmental regulations must also be applied. In particular the users of the equipment:

- must be informed of the relevant job safety requirements
- must work to the defined responsibilities for operation, maintenance and cleaning of the equipment
- before starting work must have read and understood the operating manual
- must use the designated and recommended safety equipment.

Furthermore, anyone working with the equipment is responsible for ensuring that the device is at all times technically fit for use.

1.7.3 Responsibility of the operator

Operator is any natural or legal person who uses the equipment or delegates the usage to a third party, and is responsible during its usage for the safety of the user, other personnel or third parties.

The equipment is in industrial operation. Therefore the operators are governed by the legal safety regulations. Alongside the warning and safety notices in this manual the relevant safety, accident prevention and environmental regulations must also be applied. In particular the operator has to

- be acquainted with the relevant job safety requirements
- identify other possible dangers arising from the specific usage conditions at the work station via a risk assessment
- introduce the necessary steps in the operating procedures for the local conditions
- regularly control that the operating procedures are current
- update the operating procedures where necessary to reflect changes in regulation, standards or operating conditions.
- define clearly and unambiguously the responsibilities for operation, maintenance and cleaning of the equipment.
- ensure that all employees who use the equipment have read and understood the manual. Furthermore the users are to be regularly schooled in working with the equipment and the possible dangers.
- provide all personnel who work with the equipment with the designated and recommended safety equipment

Furthermore, the operator is responsible for ensuring that the device is at all times technically fit for use.

1.7.4 User requirements

Any activity with equipment of this type may only be performed by persons who are able to work correctly and reliably and satisfy the requirements of the job.

- Persons whose reaction capability is negatively influenced by e.g. drugs, alcohol or medication may not operate the equipment.
- Age or job related regulations valid at the operating site must always be applied.



Danger for unqualified users

Improper operation can cause person or object damage. Only persons who have the necessary training, knowledge and experience may use the equipment.

Delegated persons are those who have been properly and demonstrably instructed in their tasks and the attendant dangers.

Qualified persons are those who are able through training, knowledge and experience as well as knowledge of the specific details to carry out all the required tasks, identify dangers and avoid personal and other risks.

1.7.5 Alarm signals

The equipment offers various possibilities for signaling alarm conditions, however, not for danger situations. The signals may be optical (on the display as text), acoustic (piezo buzzer) or electronic (pin/status output of an analog interface). All alarms will cause the device to permanently or temporarily switch off the DC output.

The meaning of the signals is as follows:

Signal OT (OverTemperature)	<ul style="list-style-type: none"> • Overheating of the device • DC output will be switched off temporarily • Non-critical
Signal OVP (OverVoltage)	<ul style="list-style-type: none"> • Overvoltage shutdown of the DC output due to high voltage entering the device or generated by the device itself due to a defect • Critical! The device and/or the load could be damaged
Signal OCP (OverCurrent)	<ul style="list-style-type: none"> • Shutdown of the DC output due to excess of the preset limit • Non-critical, protects the load from excessive current consumption
Signal OPP (OverPower)	<ul style="list-style-type: none"> • Shutdown of the DC output due to excess of the preset limit • Non-critical, protects the load from excessive power consumption
Signal PF (Power Fail)	<ul style="list-style-type: none"> • DC output shutdown due to AC undervoltage or defect of the AC input circuit • Critical on overvoltage! AC input circuit could be damaged

1.8 Technical data

1.8.1 Approved operating conditions

- Use only inside dry buildings
- Ambient temperature 0-50 °C (32-122 °F)
- Operational altitude: max. 2000 m (6562 ft) above sea level
- Max 80% relative humidity, not condensing

1.8.2 General technical data

Display: Color TFT, 480pt x 128pt

Controls: 2 rotary knobs with pushbutton function, 5 pushbuttons

The nominal values for the device determine the maximum adjustable ranges.

1.8.3 Specific technical data

1000 W	Model 2U		
	PS 9040-40	PS 9080-40	PS 9200-15
AC Input			
Input voltage & frequency	90...264 V AC, 50/60 Hz		
Input connection	1ph (L, N, PE)		
Input fuse (internal)	T16 A		
Leak current	< 3.5 mA		
Power factor	≈ 0.99		
DC Output			
Max. output voltage U_{Max}	40 V	80 V	200 V
Max. output current I_{Max}	40 A	40 A	15 A
Max. output power P_{Max}	1000 W	1000 W	1000 W
Oversvoltage protection range	0...44 V	0...88 V	0...220 V
Overcurrent protection range	0...44 A	0...44 A	0...16.5 A
Overpower protection range	0...1100 W	0...1100 W	0...1100 W
Temperature coefficient for set values Δ/K	Voltage / current: 100 ppm		
Output capacitance	≈5440 μ F	≈5440 μ F	≈800 μ F
Voltage regulation			
Adjustment range	0...40.8 V	0...81.6 V	0...204 V
Accuracy ⁽¹⁾ (at 23±5 °C / 73±9 °F)	< 0.1% U_{Nom}	< 0.1% U_{Nom}	< 0.1% U_{Nom}
Line regulation at ±10% ΔU_{AC}	< 0.02% U_{Nom}	< 0.02% U_{Nom}	< 0.02% U_{Nom}
Load regulation at 0...100% load	< 0.05% U_{Nom}	< 0.05% U_{Nom}	< 0.05% U_{Nom}
Rise time 10...90% ΔU	Max. 30 ms	Max. 30 ms	Max. 30 ms
Display: Resolution	See section „1.9.5.4. Resolution of the displayed values“		
Display: Accuracy ⁽⁴⁾	≤ 0.2% U_{Nom}	≤ 0.2% U_{Nom}	≤ 0.2% U_{Nom}
Ripple ⁽²⁾	< 114 mV _{PP} < 8 mV _{RMS}	< 114 mV _{PP} < 8 mV _{RMS}	< 164 mV _{PP} < 34 mV _{RMS}
Remote sensing compensation	Max. 5% U_{Nom}	Max. 5% U_{Nom}	Max. 5% U_{Nom}
Output voltage fall time (at no load) after switching DC output off	-	-	Down from 100% to <60 V: less than 10 s
Current regulation			
Adjustment range	0...40.8 A	0...40.8 A	0...15.5 A
Accuracy ⁽¹⁾ (at 23±5 °C / 73±9 °F)	< 0.2% I_{Nom}	< 0.2% I_{Nom}	< 0.2% I_{Nom}
Line regulation at ±10% ΔU_{AC}	< 0.05% I_{Nom}	< 0.05% I_{Nom}	< 0.05% I_{Nom}
Load regulation at 0...100% ΔU_{OUT}	< 0.15% I_{Nom}	< 0.15% I_{Nom}	< 0.15% I_{Nom}
Ripple ⁽²⁾	< 3.7 mA _{RMS}	< 3.7 mA _{RMS}	< 2.2 mA _{RMS}
Display: Resolution	See section „1.9.5.4. Resolution of the displayed values“		
Display: Accuracy ⁽⁴⁾	≤ 0.2% I_{Nom}	≤ 0.2% I_{Nom}	≤ 0.2% I_{Nom}
Transient time after load step	< 1.5 ms	< 1.5 ms	< 1.5 ms
Power regulation			
Adjustment range	0...1020 W	0...1020 W	0...1020 W
Accuracy ⁽¹⁾ (at 23±5 °C / 73±9 °F)	< 1% P_{Nom}	< 1% P_{Nom}	< 1% P_{Nom}
Line regulation at ±10% ΔU_{AC}	< 0.05% P_{Nom}	< 0.05% P_{Nom}	< 0.05% P_{Nom}
Load regulation at 10-90% ΔU_{OUT} * ΔI_{OUT}	< 0.75% P_{Nom}	< 0.75% P_{Nom}	< 0.75% P_{Nom}
Display: Resolution	See section „1.9.5.4. Resolution of the displayed values“		
Display: Accuracy ⁽⁴⁾	≤ 0.8% P_{Nom}	≤ 0.8% P_{Nom}	≤ 0.8% P_{Nom}
Efficiency ⁽³⁾	≈ 92%	≈ 92%	≈ 93%

(1) Related to the nominal values, the accuracy defines the maximum deviation between an adjusted values and the true (actual) value.

Example: a 80 V model has min. 0.1% voltage accuracy, that is 80 mV. When adjusting the voltage to 5 V, the actual value is allowed to differ max. 80 mV, which means it might be between 4.92 V and 5.08 V.

(2) RMS value: LF 0...300 kHz, PP value: HF 0...20 MHz

(3) Typical value at 100% output voltage and 100% power

(4) The display error adds to the error of the related actual value on the DC output.

1000 W	Model 2U		
	PS 9040-40	PS 9080-40	PS 9200-15
Analog interface ⁽¹⁾			
Set value inputs	U, I, P		
Actual value output	U, I		
Control signals	DC on/off, remote control on/off		
Status signals	CV, OVP, OCP, OPP, OT, PF, DC on/off		
Galvanic isolation to the device	Max. 400 V DC		
Sample rate of inputs	500 Hz		
Insulation			
Allowed float (potential shift) on the DC output:			
Negative terminal to PE	Max. ±400 V DC	±400 V DC	±400 V DC
Positive terminal to PE	Max. +440 V DC	+480 V DC	+600 V DC
Miscellaneous			
Cooling	Temperature controlled fans, front inlet, rear exhaust		
Ambient temperature	0..50 °C (32...122 °F)		
Storage temperature	-20...70 °C (-4...158 °F)		
Humidity	< 80%, not condensing		
Standards	EN 60950:2006 + A11:2009 + A1:2010 + A12:2011 + AC:2011 + A2:2013 EN 61326-1:2013-07		
Overvoltage category	2		
Protection class	1		
Pollution degree	2		
Operational altitude	< 2000 m (6562 ft)		
Digital interfaces			
Featured	1x USB-B, 1x Ethernet ⁽²⁾ , 1x GPIB (optional with option 3W)		
Galvanic isolation from device	Max. 400 V DC		
USB specification	USB 2.0, socket type B, VCOM driver		
USB response time	SCPI: max. 5 ms, ModBus RTU: max. 5 ms		
Ethernet specification ⁽²⁾	RJ45, 10/100 Mbit, TCP/IP, ICMP, HTTP, DHCP		
Ethernet response time	SCPI: max. 7 ms, ModBus RTU: 9-17 ms		
GPIB specification (optional)	24 pin Centronics socket acc. IEEE-488, for standard GPIB cables		
Terminals			
Rear side	Share Bus, DC output, AC input, remote sensing, analog interface, USB-B, Ethernet		
Dimensions			
Enclosure (WxHxD)	19" x 2U x 463 mm (18.2")		
Total (WxHxD)	483 x 88 x min. 535 mm (21") (depending on DC out terminal type)		
Weight	≈ 12 kg (26.4 lb)	≈ 12 kg (26.4 lb)	≈ 12 kg (26.4 lb)
Article number ⁽³⁾	06230219	06230204	06230205

(1 For technical specifications of the analog interface see „3.5.4.4 Analog interface specification“ on page 52

(2 Only in the standard version

(3 Article number of the base version, devices with further options will have a different number

1000 W	<i>Model 2U</i>		
	<i>PS 9360-10</i>	<i>PS 9500-06</i>	<i>PS 9750-04</i>
AC Input			
Input voltage & frequency	90...264 V AC, 50/60 Hz		
Input connection	1ph (L, N, PE)		
Input fuse (internal)	T16 A		
Leak current	< 3.5 mA		
Power factor	≈ 0.99		
DC Output			
Max. output voltage U_{Max}	360 V	500 V	750 V
Max. output current I_{Max}	10 A	6 A	4 A
Max. output power P_{Max}	1000 W	1000 W	1000 W
Overvoltage protection range	0...396 V	0...550 V	0...825 V
Overcurrent protection range	0...11 A	0...6.6 A	0...4.4 A
Overpower protection range	0...1100 W	0...1100 W	0...1100 W
Temperature coefficient for set values Δ/K	Voltage / current: 100 ppm		
Output capacitance	≈330 μ F	≈120 μ F	≈35 μ F
Voltage regulation			
Adjustment range	0...360 V	0...500 V	0...750 V
Accuracy ⁽¹⁾ (at 23±5 °C / 73±9 °F)	< 0.1% U_{Nom}	< 0.1% U_{Nom}	< 0.1% U_{Nom}
Line regulation at ±10% ΔU_{AC}	< 0.02% U_{Nom}	< 0.02% U_{Nom}	< 0.02% U_{Nom}
Load regulation at 0...100% load	< 0.05% U_{Nom}	< 0.05% U_{Nom}	< 0.05% U_{Nom}
Rise time 10...90% ΔU	Max. 30 ms	Max. 30 ms	Max. 30 ms
Display: Resolution	See section „1.9.5.4. Resolution of the displayed values“		
Display: Accuracy ⁽⁴⁾	≤ 0.2% U_{Nom}	≤ 0.2% U_{Nom}	≤ 0.2% U_{Nom}
Ripple ⁽²⁾	< 210 mV _{PP} < 59 mV _{RMS}	< 190 mV _{PP} < 48 mV _{RMS}	< 212 mV _{PP} < 60 mV _{RMS}
Remote sensing compensation	Max. 5% U_{Nom}	Max. 5% U_{Nom}	Max. 5% U_{Nom}
Output voltage fall time (at no load) after switching DC output off	Down from 100% to <60 V: less than 10 s		
Current regulation			
Adjustment range	0...10.2 A	0...6.12 A	0...4.08 A
Accuracy ⁽¹⁾ (at 23±5 °C / 73±9 °F)	< 0.2% I_{Nom}	< 0.2% I_{Nom}	< 0.2% I_{Nom}
Line regulation at ±10% ΔU_{AC}	< 0.05% I_{Nom}	< 0.05% I_{Nom}	< 0.05% I_{Nom}
Load regulation at 0...100% ΔU_{OUT}	< 0.15% I_{Nom}	< 0.15% I_{Nom}	< 0.15% I_{Nom}
Ripple ⁽²⁾	< 1.6 mA _{RMS}	< 0.5 mA _{RMS}	< 0.3 mA _{RMS}
Display: Resolution	See section „1.9.5.4. Resolution of the displayed values“		
Display: Accuracy ⁽⁴⁾	≤ 0.2% I_{Nom}	≤ 0.2% I_{Nom}	≤ 0.2% I_{Nom}
Transient time after load step	< 1.5 ms	< 1.5 ms	< 1.5 ms
Power regulation			
Adjustment range	0...1020 W	0...1020 W	0...1020 W
Accuracy ⁽¹⁾ (at 23±5 °C / 73±9 °F)	< 1% P_{Nom}	< 1% P_{Nom}	< 1% P_{Nom}
Line regulation at ±10% ΔU_{AC}	< 0.05% P_{Nom}	< 0.05% P_{Nom}	< 0.05% P_{Nom}
Load regulation at 10-90% ΔU_{OUT} * ΔI_{OUT}	< 0.75% P_{Nom}	< 0.75% P_{Nom}	< 0.75% P_{Nom}
Display: Resolution	See section „1.9.5.4. Resolution of the displayed values“		
Display: Accuracy ⁽⁴⁾	≤ 0.8% P_{Nom}	≤ 0.8% P_{Nom}	≤ 0.8% P_{Nom}
Efficiency ⁽³⁾	≈ 93%	≈ 93%	≈ 93%

(1) Related to the nominal values, the accuracy defines the maximum deviation between an adjusted values and the true (actual) value.
Example: a 80 V model has min. 0.1% voltage accuracy, that is 80 mV. When adjusting the voltage to 5 V, the actual value is allowed to differ max. 80 mV, which means it might be between 4.92 V and 5.08 V.
(2) RMS value: LF 0...300 kHz, PP value: HF 0...20 MHz
(3) Typical value at 100% output voltage and 100% power
(4) The display error adds to the error of the related actual value on the DC output.

1000 W	Model 2U		
	PS 9360-10	PS 9500-06	PS 9750-04
Analog interface ⁽¹⁾			
Set value inputs	U, I, P		
Actual value output	U, I		
Control signals	DC on/off, remote control on/off		
Status signals	CV, OVP, OCP, OPP, OT, PF, DC on/off		
Galvanic isolation to the device	Max. 400 V DC		
Sample rate of inputs	500 Hz		
Insulation			
Allowed float (potential shift) on the DC output:			
Negative terminal to PE	Max. ±400 V DC	±400 V DC	±400 V DC
Positive terminal to PE	Max. +760 V DC	+900 V DC	+1150 V DC
Miscellaneous			
Cooling	Temperature controlled fans, front inlet, rear exhaust		
Ambient temperature	0..50 °C (32...122 °F)		
Storage temperature	-20...70 °C (-4...158 °F)		
Humidity	< 80%, not condensing		
Standards	EN 60950:2006 + A11:2009 + A1:2010 + A12:2011 + AC:2011 + A2:2013 EN 61326-1:2013-07		
Overvoltage category	2		
Protection class	1		
Pollution degree	2		
Operational altitude	< 2000 m (6562 ft)		
Digital interfaces			
Featured	1x USB-B, 1x Ethernet ⁽²⁾ , 1x GPIB (optional with option 3W)		
Galvanic isolation from device	Max. 400 V DC		
USB specification	USB 2.0, socket type B, VCOM driver		
USB response time	SCPI: max. 5 ms, ModBus RTU: max. 5 ms		
Ethernet specification ⁽²⁾	RJ45, 10/100 Mbit, TCP/IP, ICMP, HTTP, DHCP		
Ethernet response time	SCPI: max. 7 ms, ModBus RTU: 9-17 ms		
GPIB specification (optional)	24 pin Centronics socket acc. IEEE-488, for standard GPIB cables		
Terminals			
Rear side	Share Bus, DC output, AC input, remote sensing, analog interface, USB-B, Ethernet		
Dimensions			
Enclosure (WxHxD)	19" x 2U x 463 mm (18.2")		
Total (WxHxD)	483 x 88 x min. 535 mm (21") (depending on DC out terminal type)		
Weight	≈ 12 kg (26.4 lb)	≈ 12 kg (26.4 lb)	≈ 12 kg (26.4 lb)
Article number ⁽³⁾	06230206	06230207	06230208

(1 For technical specifications of the analog interface see „3.5.4.4 Analog interface specification“ on page 52

(2 Only in the standard version

(3 Article number of the base version, devices with further options will have a different number

1500 W	Model 2U		
	PS 9040-60	PS 9080-60	PS 9200-25
AC Input			
Input voltage	90...264 V AC, 50/60 Hz		
- with additional derating	90...150 V AC		
Input connection	1ph (L, N, PE)		
Input fuse (internal)	T16 A		
Leak current	< 3.5 mA		
Power factor	≈ 0.99		
DC Output			
Max. output voltage U_{Max}	40 V	80 V	200 V
Max. output current I_{Max}	60 A	60 A	25 A
Max. output power P_{Max}	1500 W	1500 W	1500 W
Max. output power P_{Max} with derating	1000 W	1000 W	1000 W
Overvoltage protection range	0...44 V	0...88 V	0...220 V
Overcurrent protection range	0...66 A	0...66 A	0...27.5 A
Overpower protection range	0...1650 W	0...1650 W	0...1650 W
Temperature coefficient for set values Δ/K	Voltage / current: 100 ppm		
Output capacitance	≈5440 μ F	≈5440 μ F	≈800 μ F
Voltage regulation			
Adjustment range	0...40.8 V	0...81.6 V	0...204 V
Accuracy ⁽¹⁾ (at 23±5 °C / 73±9 °F)	< 0.1% U_{Nom}	< 0.1% U_{Nom}	< 0.1% U_{Nom}
Line regulation at ±10% ΔU_{AC}	< 0.02% U_{Nom}	< 0.02% U_{Nom}	< 0.02% U_{Nom}
Load regulation at 0...100% load	< 0.05% U_{Nom}	< 0.05% U_{Nom}	< 0.05% U_{Nom}
Rise time 10...90% ΔU	Max. 30 ms	Max. 30 ms	Max. 30 ms
Display: Resolution	See section „1.9.5.4. Resolution of the displayed values“		
Display: Accuracy ⁽⁴⁾	≤ 0.2% U_{Nom}	≤ 0.2% U_{Nom}	≤ 0.2% U_{Nom}
Ripple ⁽²⁾	< 114 mV _{PP} < 8 mV _{RMS}	< 114 mV _{PP} < 8 mV _{RMS}	< 164 mV _{PP} < 34 mV _{RMS}
Remote sensing compensation	Max. 5% U_{Nom}	Max. 5% U_{Nom}	Max. 5% U_{Nom}
Output voltage fall time (at no load) after switching DC output off	-	-	Down from 100% to <60 V: less than 10 s
Current regulation			
Adjustment range	0...61.2 A	0...61.2 A	0...25.5 A
Accuracy ⁽¹⁾ (at 23±5 °C / 73±9 °F)	< 0.2% I_{Nom}	< 0.2% I_{Nom}	< 0.2% I_{Nom}
Line regulation at ±10% ΔU_{AC}	< 0.05% I_{Nom}	< 0.05% I_{Nom}	< 0.05% I_{Nom}
Load regulation at 0...100% ΔU_{OUT}	< 0.15% I_{Nom}	< 0.15% I_{Nom}	< 0.15% I_{Nom}
Ripple ⁽²⁾	< 5.6 mA _{RMS}	< 5.6 mA _{RMS}	< 3.3 mA _{RMS}
Display: Resolution	See section „1.9.5.4. Resolution of the displayed values“		
Display: Accuracy ⁽⁴⁾	≤ 0.2% I_{Nom}	≤ 0.2% I_{Nom}	≤ 0.2% I_{Nom}
Transient time after load step	< 1.5 ms	< 1.5 ms	< 1.5 ms
Power regulation			
Adjustment range	0...1530 W	0...1530 W	0...1530 W
Accuracy ⁽¹⁾ (at 23±5 °C / 73±9 °F)	< 1% P_{Nom}	< 1% P_{Nom}	< 1% P_{Nom}
Line regulation at ±10% ΔU_{AC}	< 0.05% P_{Nom}	< 0.05% P_{Nom}	< 0.05% P_{Nom}
Load regulation at 10-90% ΔU_{OUT} * ΔI_{OUT}	< 0.75% P_{Nom}	< 0.75% P_{Nom}	< 0.75% P_{Nom}
Display: Resolution	See section „1.9.5.4. Resolution of the displayed values“		
Display: Accuracy ⁽⁴⁾	≤ 0.8% P_{Nom}	≤ 0.8% P_{Nom}	≤ 0.7% P_{Nom}
Efficiency ⁽³⁾	≈ 92%	≈ 92%	≈ 93%

(1) Related to the nominal values, the accuracy defines the maximum deviation between an adjusted values and the true (actual) value.

Example: a 80 V model has min. 0.1% voltage accuracy, that is 80 mV. When adjusting the voltage to 5 V, the actual value is allowed to differ max. 80 mV, which means it might be between 4.92 V and 5.08 V.

(2) RMS value: LF 0...300 kHz, PP value: HF 0...20 MHz

(3) Typical value at 100% output voltage and 100% power

(4) The display error adds to the error of the related actual value on the DC output.

1500 W	Model 2U		
	PS 9040-60	PS 9080-60	PS 9200-25
Analog interface ⁽¹⁾			
Set value inputs	U, I, P		
Actual value output	U, I		
Control signals	DC on/off, remote control on/off		
Status signals	CV, OVP, OCP, OPP, OT, PF, DC on/off		
Galvanic isolation to the device	Max. 400 V DC		
Sample rate of inputs	500 Hz		
Insulation			
Allowed float (potential shift) on the DC output:			
Negative terminal to PE	Max. ±400 V DC	±400 V DC	±400 V DC
Positive terminal to PE	Max. +440 V DC	+480 V DC	+600 V DC
Miscellaneous			
Cooling	Temperature controlled fans, front inlet, rear exhaust		
Ambient temperature	0..50 °C (32...122 °F)		
Storage temperature	-20...70 °C (-4...158 °F)		
Humidity	< 80%, not condensing		
Standards	EN 60950:2006 + A11:2009 + A1:2010 + A12:2011 + AC:2011 + A2:2013 EN 61326-1:2013-07		
Overvoltage category	2		
Protection class	1		
Pollution degree	2		
Operational altitude	< 2000 m (6562 ft)		
Digital interfaces			
Featured	1x USB-B, 1x Ethernet ⁽²⁾ , 1x GPIB (optional with option 3W)		
Galvanic isolation from device	Max. 400 V DC		
USB specification	USB 2.0, socket type B, VCOM driver		
USB response time	SCPI: max. 5 ms, ModBus RTU: max. 5 ms		
Ethernet specification ⁽²⁾	RJ45, 10/100 Mbit, TCP/IP, ICMP, HTTP, DHCP		
Ethernet response time	SCPI: max. 7 ms, ModBus RTU: 9-17 ms		
GPIB specification (optional)	24 pin Centronics socket acc. IEEE-488, for standard GPIB cables		
Terminals			
Rear side	Share Bus, DC output, AC input, remote sensing, analog interface, USB-B, Ethernet		
Dimensions			
Enclosure (WxHxD)	19" x 2U x 463 mm (18.2")		
Total (WxHxD)	483 x 88 x min. 535 mm (21") (depending on DC out terminal type)		
Weight	≈ 12 kg (26.4 lb)	≈ 12 kg (26.4 lb)	≈ 12 kg (26.4 lb)
Article number ⁽³⁾	06230220	06230209	06230210

(1 For technical specifications of the analog interface see „3.5.4.4 Analog interface specification“ on page 52

(2 Only in the standard version

(3 Article number of the base version, devices with further options will have a different number

1500 W	<i>Model 2U</i>		
	<i>PS 9360-15</i>	<i>PS 9500-10</i>	<i>PS 9750-06</i>
AC Input			
Input voltage	90...264 V AC, 50/60 Hz		
- with additional derating	90...150 V AC		
Input connection	1ph (L, N, PE)		
Input fuse (internal)	T16 A		
Leak current	< 3.5 mA		
Power factor	≈ 0.99		
DC Output			
Max. output voltage U_{Max}	360 V	500 V	750 V
Max. output current I_{Max}	15 A	10 A	6 A
Max. output power P_{Max}	1500 W	1500 W	1500 W
Max. output power P_{Max} with derating	1000 W	1000 W	1000 W
Overvoltage protection range	0...396 V	0...550 V	0...825 V
Overcurrent protection range	0...16.5 A	0...11 A	0...6.6 A
Overpower protection range	0...1650 W	0...1650 W	0...1650 W
Temperature coefficient for set values Δ/K	Voltage / current: 100 ppm		
Output capacitance	≈330 μ F	≈120 μ F	≈35 μ F
Voltage regulation			
Adjustment range	0...367.2 V	0...510 V	0...765 V
Accuracy ⁽¹⁾ (at 23±5 °C / 73±9 °F)	< 0.1% U_{Nom}	< 0.1% U_{Nom}	< 0.1% U_{Nom}
Line regulation at ±10% ΔU_{AC}	< 0.02% U_{Nom}	< 0.02% U_{Nom}	< 0.02% U_{Nom}
Load regulation at 0...100% load	< 0.05% U_{Nom}	< 0.05% U_{Nom}	< 0.05% U_{Nom}
Rise time 10...90% ΔU	Max. 30 ms	Max. 30 ms	Max. 30 ms
Display: Resolution	See section „1.9.5.4. Resolution of the displayed values“		
Display: Accuracy ⁽⁴⁾	≤ 0.2% U_{Nom}	≤ 0.2% U_{Nom}	≤ 0.2% U_{Nom}
Ripple ⁽²⁾	< 210 mV _{PP} < 59 mV _{RMS}	< 190 mV _{PP} < 48 mV _{RMS}	< 212 mV _{PP} < 60 mV _{RMS}
Remote sensing compensation	Max. 5% U_{Nom}	Max. 5% U_{Nom}	Max. 5% U_{Nom}
Output voltage fall time (at no load)after switching DC output off	Down from 100% to <60 V: less than 10 s		
Current regulation			
Adjustment range	0...15.3 A	0...10.2 A	0...6.12 A
Accuracy ⁽¹⁾ (at 23±5 °C / 73±9 °F)	< 0.2% I_{Nom}	< 0.2% I_{Nom}	< 0.2% I_{Nom}
Line regulation at ±10% ΔU_{AC}	< 0.05% I_{Nom}	< 0.05% I_{Nom}	< 0.05% I_{Nom}
Load regulation at 0...100% ΔU_{OUT}	< 0.15% I_{Nom}	< 0.15% I_{Nom}	< 0.15% I_{Nom}
Ripple ⁽²⁾	< 2.4 mA _{RMS}	< 0.7 mA _{RMS}	< 0.5 mA _{RMS}
Display: Resolution	See section „1.9.5.4. Resolution of the displayed values“		
Display: Accuracy ⁽⁴⁾	≤ 0.2% I_{Nom}	≤ 0.2% I_{Nom}	≤ 0.2% I_{Nom}
Transient time after load step	< 1.5 ms	< 1.5 ms	< 1.5 ms
Power regulation			
Adjustment range	0...1530 W	0...1530 W	0...1530 W
Accuracy ⁽¹⁾ (at 23±5 °C / 73±9 °F)	< 1% P_{Nom}	< 1% P_{Nom}	< 1% P_{Nom}
Line regulation at ±10% ΔU_{AC}	< 0.05% P_{Nom}	< 0.05% P_{Nom}	< 0.05% P_{Nom}
Load regulation at 10-90% ΔU_{OUT} * ΔI_{OUT}	< 0.75% P_{Nom}	< 0.75% P_{Nom}	< 0.75% P_{Nom}
Display: Resolution	See section „1.9.5.4. Resolution of the displayed values“		
Display: Accuracy ⁽⁴⁾	≤ 0.7% P_{Nom}	≤ 0.8% P_{Nom}	≤ 0.85% P_{Nom}
Efficiency ⁽³⁾	≈ 93%	≈ 93%	≈ 93%

(1) Related to the nominal values, the accuracy defines the maximum deviation between an adjusted values and the true (actual) value.
Example: a 80 V model has min. 0.1% voltage accuracy, that is 80 mV. When adjusting the voltage to 5 V, the actual value is allowed to differ max. 80 mV, which means it might be between 4.92 V and 5.08 V.
(2) RMS value: LF 0...300 kHz, PP value: HF 0...20 MHz
(3) Typical value at 100% output voltage and 100% power
(4) The display error adds to the error of the related actual value on the DC output.

1500 W	Model 2U		
	PS 9360-15	PS 9500-10	PS 9750-06
Analog interface ⁽¹⁾			
Set value inputs	U, I, P		
Actual value output	U, I		
Control signals	DC on/off, remote control on/off		
Status signals	CV, OVP, OCP, OPP, OT, PF, DC on/off		
Galvanic isolation to the device	Max. 400 V DC		
Sample rate of inputs	500 Hz		
Insulation			
Allowed float (potential shift) on the DC output:			
Negative terminal to PE	Max. ±400 V DC	±400 V DC	±400 V DC
Positive terminal to PE	Max. +760 V DC	+900 V DC	+1150 V DC
Miscellaneous			
Cooling	Temperature controlled fans, front inlet, rear exhaust		
Ambient temperature	0..50 °C (32...122 °F)		
Storage temperature	-20...70 °C (-4...158 °F)		
Humidity	< 80%, not condensing		
Standards	EN 60950:2006 + A11:2009 + A1:2010 + A12:2011 + AC:2011 + A2:2013 EN 61326-1:2013-07		
Overvoltage category	2		
Protection class	1		
Pollution degree	2		
Operational altitude	< 2000 m (6562 ft)		
Digital interfaces			
Featured	1x USB-B, 1x Ethernet ⁽²⁾ , 1x GPIB (optional with option 3W)		
Galvanic isolation from device	Max. 400 V DC		
USB specification	USB 2.0, socket type B, VCOM driver		
USB response time	SCPI: max. 5 ms, ModBus RTU: max. 5 ms		
Ethernet specification ⁽²⁾	RJ45, 10/100 Mbit, TCP/IP, ICMP, HTTP, DHCP		
Ethernet response time	SCPI: max. 7 ms, ModBus RTU: 9-17 ms		
GPIB specification (optional)	24 pin Centronics socket acc. IEEE-488, for standard GPIB cables		
Terminals			
Rear side	Share Bus, DC output, AC input, remote sensing, analog interface, USB-B, Ethernet		
Dimensions			
Enclosure (WxHxD)	19" x 2U x 463 mm (18.2")		
Total (WxHxD)	483 x 88 x min. 535 mm (21") (depending on DC out terminal type)		
Weight	≈ 12 kg (26.4 lb)	≈ 12 kg (26.4 lb)	≈ 12 kg (26.4 lb)
Article number ⁽³⁾	06230211	06230212	06230213

(1 For technical specifications of the analog interface see „3.5.4.4 Analog interface specification“ on page 52

(2 Only in the standard version

(3 Article number of the base version, devices with further options will have a different number

3000 W	<i>Model 2U</i>		
	<i>PS 9040-120</i>	<i>PS 9080-120</i>	<i>PS 9200-50</i>
AC Input			
Input voltage	180...264 V AC, 50/60 Hz		
- with additional derating	180...207 V AC		
Input connection	1ph (L, N, PE)		
Input fuse (internal)	T16 A		
Leak current	< 3.5 mA		
Power factor	≈ 0.99		
DC Output			
Max. output voltage U_{Max}	40 V	80 V	200 V
Max. output current I_{Max}	120 A	120 A	50 A
Max. output power P_{Max}	3000 W	3000 W	3000 W
Max. output power P_{Max} with derating	2500 W	2500 W	2500 W
Overvoltage protection range	0...44 V	0...88 V	0...220 V
Overcurrent protection range	0...132 A	0...132 A	0...55 A
Overpower protection range	0...3300 W	0...3300 W	0...3300 W
Temperature coefficient for set values Δ/K	Voltage / current: 100 ppm		
Output capacitance	≈10880 μ F	≈10880 μ F	≈1600 μ F
Voltage regulation			
Adjustment range	0...40.8 V	0...81.6 V	0...204 V
Accuracy ⁽¹⁾ (at 23±5 °C / 73±9 °F)	< 0.1% U_{Nom}	< 0.1% U_{Nom}	< 0.1% U_{Nom}
Line regulation at ±10% ΔU_{AC}	< 0.02% U_{Nom}	< 0.02% U_{Nom}	< 0.02% U_{Nom}
Load regulation at 0...100% load	< 0.05% U_{Nom}	< 0.05% U_{Nom}	< 0.05% U_{Nom}
Rise time 10...90% ΔU	Max. 30 ms	Max. 30 ms	Max. 30 ms
Display: Resolution	See section „1.9.5.4. Resolution of the displayed values“		
Display: Accuracy ⁽⁴⁾	≤ 0.2% U_{Nom}	≤ 0.2% U_{Nom}	≤ 0.2% U_{Nom}
Ripple ⁽²⁾	< 114 mV _{PP} < 8 mV _{RMS}	< 114 mV _{PP} < 8 mV _{RMS}	< 164 mV _{PP} < 34 mV _{RMS}
Remote sensing compensation	Max. 5% U_{Nom}	Max. 5% U_{Nom}	Max. 5% U_{Nom}
Output voltage fall time (at no load)after switching DC output off	-	-	Down from 100% to <60 V: less than 10 s
Current regulation			
Adjustment range	0...122.4 A	0...122.4 A	0...51 A
Accuracy ⁽¹⁾ (at 23±5 °C / 73±9 °F)	< 0.2% I_{Nom}	< 0.2% I_{Nom}	< 0.2% I_{Nom}
Line regulation at ±10% ΔU_{AC}	< 0.05% I_{Nom}	< 0.05% I_{Nom}	< 0.05% I_{Nom}
Load regulation at 0...100% ΔU_{OUT}	< 0.15% I_{Nom}	< 0.15% I_{Nom}	< 0.15% I_{Nom}
Ripple ⁽²⁾	< 11 mA _{RMS}	< 11 mA _{RMS}	< 6.5 mA _{RMS}
Display: Resolution	See section „1.9.5.4. Resolution of the displayed values“		
Display: Accuracy ⁽⁴⁾	≤ 0.2% I_{Nom}	≤ 0.2% I_{Nom}	≤ 0.2% I_{Nom}
Transient time after load step	< 1.5 ms	< 1.5 ms	< 1.5 ms
Power regulation			
Adjustment range	0...3060 W	0...3060 W	0...3060 W
Accuracy ⁽¹⁾ (at 23±5 °C / 73±9 °F)	< 1% P_{Nom}	< 1% P_{Nom}	< 1% P_{Nom}
Line regulation at ±10% ΔU_{AC}	< 0.05% P_{Nom}	< 0.05% P_{Nom}	< 0.05% P_{Nom}
Load regulation at 10-90% ΔU_{OUT} * ΔI_{OUT}	< 0.75% P_{Nom}	< 0.75% P_{Nom}	< 0.75% P_{Nom}
Display: Resolution	See section „1.9.5.4. Resolution of the displayed values“		
Display: Accuracy ⁽⁴⁾	≤ 0.8% P_{Nom}	≤ 0.8% P_{Nom}	≤ 0.85% P_{Nom}
Efficiency ⁽³⁾	≈ 92%	≈ 92%	≈ 93%

(1) Related to the nominal values, the accuracy defines the maximum deviation between an adjusted values and the true (actual) value.
Example: a 80 V model has min. 0.1% voltage accuracy, that is 80 mV. When adjusting the voltage to 5 V, the actual value is allowed to differ max. 80 mV, which means it might be between 4.92 V and 5.08 V.
(2) RMS value: LF 0...300 kHz, PP value: HF 0...20 MHz
(3) Typical value at 100% output voltage and 100% power
(4) The display error adds to the error of the related actual value on the DC output.

3000 W	Model 2U		
	PS 9040-120	PS 9080-120	PS 9200-50
Analog interface ⁽¹⁾			
Set value inputs	U, I, P		
Actual value output	U, I		
Control signals	DC on/off, remote control on/off		
Status signals	CV, OVP, OCP, OPP, OT, PF, DC on/off		
Galvanic isolation to the device	Max. 400 V DC		
Sample rate of inputs	500 Hz		
Insulation			
Allowed float (potential shift) on the DC output:			
Negative terminal to PE	Max. ±400 V DC	±400 V DC	±400 V DC
Positive terminal to PE	Max. +440 V DC	+480 V DC	+600 V DC
Miscellaneous			
Cooling	Temperature controlled fans, front inlet, rear exhaust		
Ambient temperature	0..50 °C (32...122 °F)		
Storage temperature	-20...70 °C (-4...158 °F)		
Humidity	< 80%, not condensing		
Standards	EN 60950:2006 + A11:2009 + A1:2010 + A12:2011 + AC:2011 + A2:2013 EN 61326-1:2013-07		
Overvoltage category	2		
Protection class	1		
Pollution degree	2		
Operational altitude	< 2000 m (6562 ft)		
Digital interfaces			
Featured	1x USB-B, 1x Ethernet ⁽²⁾ , 1x GPIB (optional with option 3W)		
Galvanic isolation from device	Max. 400 V DC		
USB specification	USB 2.0, socket type B, VCOM driver		
USB response time	SCPI: max. 5 ms, ModBus RTU: max. 5 ms		
Ethernet specification ⁽²⁾	RJ45, 10/100 Mbit, TCP/IP, ICMP, HTTP, DHCP		
Ethernet response time	SCPI: max. 7 ms, ModBus RTU: 9-17 ms		
GPIB specification (optional)	24 pin Centronics socket acc. IEEE-488, for standard GPIB cables		
Terminals			
Rear side	Share Bus, DC output, AC input, remote sensing, analog interface, USB-B, Ethernet		
Dimensions			
Enclosure (WxHxD)	19" x 2U x 463 mm (18.2")		
Total (WxHxD)	483 x 88 x min. 535 mm (21") (depending on DC out terminal type)		
Weight	≈ 15 kg (33 lb)	≈ 15 kg (33 lb)	≈ 15 kg (33 lb)
Article number ⁽³⁾	06230221	06230214	06230215

(1 For technical specifications of the analog interface see „3.5.4.4 Analog interface specification“ on page 52

(2 Only in the standard version

(3 Article number of the base version, devices with further options will have a different number

3000 W	Model 2U		
	PS 9360-30	PS 9500-20	PS 9750-12
AC Input			
Input voltage	180...264 V AC, 50/60 Hz		
- with additional derating	180...207 V AC		
Input connection	1ph (L, N, PE)		
Input fuse (internal)	T16 A		
Leak current	< 3.5 mA		
Power factor	≈ 0.99		
DC Output			
Max. output voltage U_{Max}	360 V	500 V	750 V
Max. output current I_{Max}	30 A	20 A	12 A
Max. output power P_{Max}	3000 W	3000 W	3000 W
Max. output power P_{Max} with derating	2500 W	2500 W	2500 W
Overvoltage protection range	0...396 V	0...550 V	0...825 V
Overcurrent protection range	0...33 A	0...22 A	0...13.2 A
Overpower protection range	0...3300 W	0...3300 W	0...3300 W
Temperature coefficient for set values Δ/K	Voltage / current: 100 ppm		
Output capacitance	≈660 μ F	≈240 μ F	≈70 μ F
Voltage regulation			
Adjustment range	0...367.2 V	0...510 V	0...765 V
Accuracy ⁽¹⁾ (at 23±5 °C / 73±9 °F)	< 0.1% U_{Nom}	< 0.1% U_{Nom}	< 0.1% U_{Nom}
Line regulation at ±10% ΔU_{AC}	< 0.02% U_{Nom}	< 0.02% U_{Nom}	< 0.02% U_{Nom}
Load regulation at 0...100% load	< 0.05% U_{Nom}	< 0.05% U_{Nom}	< 0.05% U_{Nom}
Rise time 10...90% ΔU	Max. 30 ms	Max. 30 ms	Max. 30 ms
Display: Resolution	See section „1.9.5.4. Resolution of the displayed values“		
Display: Accuracy ⁽⁴⁾	≤ 0.2% U_{Nom}	≤ 0.2% U_{Nom}	≤ 0.2% U_{Nom}
Ripple ⁽²⁾	< 210 mV _{PP} < 59 mV _{RMS}	< 190 mV _{PP} < 48 mV _{RMS}	< 212 mV _{PP} < 60 mV _{RMS}
Remote sensing compensation	Max. 5% U_{Nom}	Max. 5% U_{Nom}	Max. 5% U_{Nom}
Output voltage fall time (at no load)after switching DC output off	Down from 100% to <60 V: less than 10 s		
Current regulation			
Adjustment range	0...30.6 A	0...20.4 A	0...12.24 A
Accuracy ⁽¹⁾ (at 23±5 °C / 73±9 °F)	< 0.2% I_{Nom}	< 0.2% I_{Nom}	< 0.2% I_{Nom}
Line regulation at ±10% ΔU_{AC}	< 0.05% I_{Nom}	< 0.05% I_{Nom}	< 0.05% I_{Nom}
Load regulation at 0...100% ΔU_{OUT}	< 0.15% I_{Nom}	< 0.15% I_{Nom}	< 0.15% I_{Nom}
Ripple ⁽²⁾	< 5 mA _{RMS}	< 1.5 mA _{RMS}	< 0.9 mA _{RMS}
Display: Resolution	See section „1.9.5.4. Resolution of the displayed values“		
Display: Accuracy ⁽⁴⁾	≤ 0.2% I_{Nom}	≤ 0.2% I_{Nom}	≤ 0.2% I_{Nom}
Transient time after load step	< 1.5 ms	< 1.5 ms	< 1.5 ms
Power regulation			
Adjustment range	0...3060 W	0...3060 W	0...3060 W
Accuracy ⁽¹⁾ (at 23±5 °C / 73±9 °F)	< 1% P_{Nom}	< 1% P_{Nom}	< 1% P_{Nom}
Line regulation at ±10% ΔU_{AC}	< 0.05% P_{Nom}	< 0.05% P_{Nom}	< 0.05% P_{Nom}
Load regulation at 10-90% ΔU_{OUT} * ΔI_{OUT}	< 0.75% P_{Nom}	< 0.75% P_{Nom}	< 0.75% P_{Nom}
Display: Resolution	See section „1.9.5.4. Resolution of the displayed values“		
Display: Accuracy ⁽⁴⁾	≤ 0.85% P_{Nom}	≤ 0.85% P_{Nom}	≤ 0.8% P_{Nom}
Efficiency ⁽³⁾	≈ 93%	≈ 93%	≈ 93%

(1) Related to the nominal values, the accuracy defines the maximum deviation between an adjusted values and the true (actual) value.

Example: a 80 V model has min. 0.1% voltage accuracy, that is 80 mV. When adjusting the voltage to 5 V, the actual value is allowed to differ max. 80 mV, which means it might be between 4.92 V and 5.08 V.

(2) RMS value: LF 0...300 kHz, PP value: HF 0...20 MHz

(3) Typical value at 100% output voltage and 100% power

(4) The display error adds to the error of the related actual value on the DC output.

3000 W	Model 2U		
	PS 9360-30	PS 9500-20	PS 9750-12
Analog interface ⁽¹⁾			
Set value inputs	U, I, P		
Actual value output	U, I		
Control signals	DC on/off, remote control on/off		
Status signals	CV, OVP, OCP, OPP, OT, PF, DC on/off		
Galvanic isolation to the device	Max. 400 V DC		
Sample rate of inputs	500 Hz		
Insulation			
Allowed float (potential shift) on the DC output:			
Negative terminal to PE	Max. ±400 V DC	±400 V DC	±400 V DC
Positive terminal to PE	Max. +760 V DC	+900 V DC	+1150 V DC
Miscellaneous			
Cooling	Temperature controlled fans, front inlet, rear exhaust		
Ambient temperature	0..50 °C (32...122 °F)		
Storage temperature	-20...70 °C (-4...158 °F)		
Humidity	< 80%, not condensing		
Standards	EN 60950:2006 + A11:2009 + A1:2010 + A12:2011 + AC:2011 + A2:2013 EN 61326-1:2013-07		
Overvoltage category	2		
Protection class	1		
Pollution degree	2		
Operational altitude	< 2000 m (6562 ft)		
Digital interfaces			
Featured	1x USB-B, 1x Ethernet ⁽²⁾ , 1x GPIB (optional with option 3W)		
Galvanic isolation from device	Max. 400 V DC		
USB specification	USB 2.0, socket type B, VCOM driver		
USB response time	SCPI: max. 5 ms, ModBus RTU: max. 5 ms		
Ethernet specification ⁽²⁾	RJ45, 10/100 Mbit, TCP/IP, ICMP, HTTP, DHCP		
Ethernet response time	SCPI: max. 7 ms, ModBus RTU: 9-17 ms		
GPIB specification (optional)	24 pin Centronics socket acc. IEEE-488, for standard GPIB cables		
Terminals			
Rear side	Share Bus, DC output, AC input, remote sensing, analog interface, USB-B, Ethernet		
Dimensions			
Enclosure (WxHxD)	19" x 2U x 463 mm (18.2")		
Total (WxHxD)	483 x 88 x min. 535 mm (21") (depending on DC out terminal type)		
Weight	≈ 15 kg (33 lb)	≈ 15 kg (33 lb)	≈ 15 kg (33 lb)
Article number ⁽³⁾	06230216	06230217	06230218

(1 For technical specifications of the analog interface see „3.5.4.4 Analog interface specification“ on page 52

(2 Only in the standard version

(3 Article number of the base version, devices with further options will have a different number

1.8.4 Views

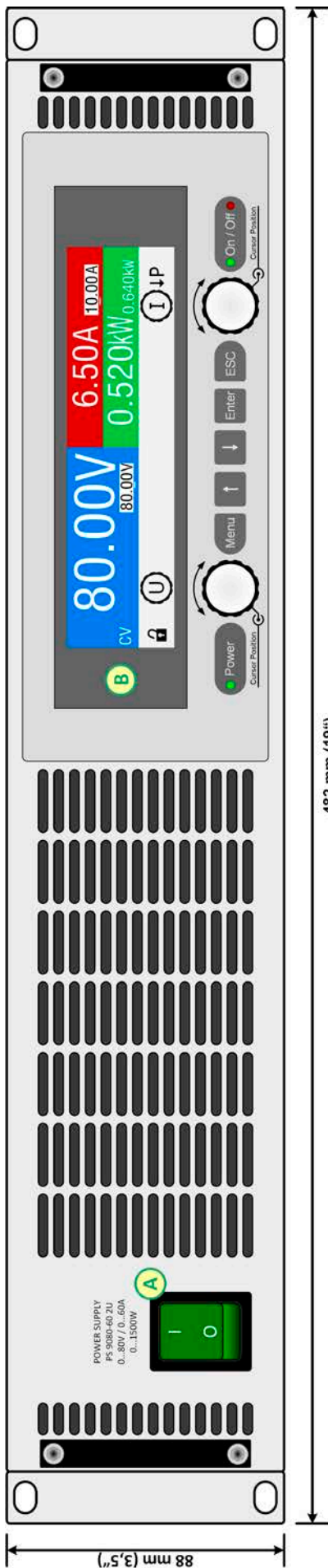

Figure 1 - Front side

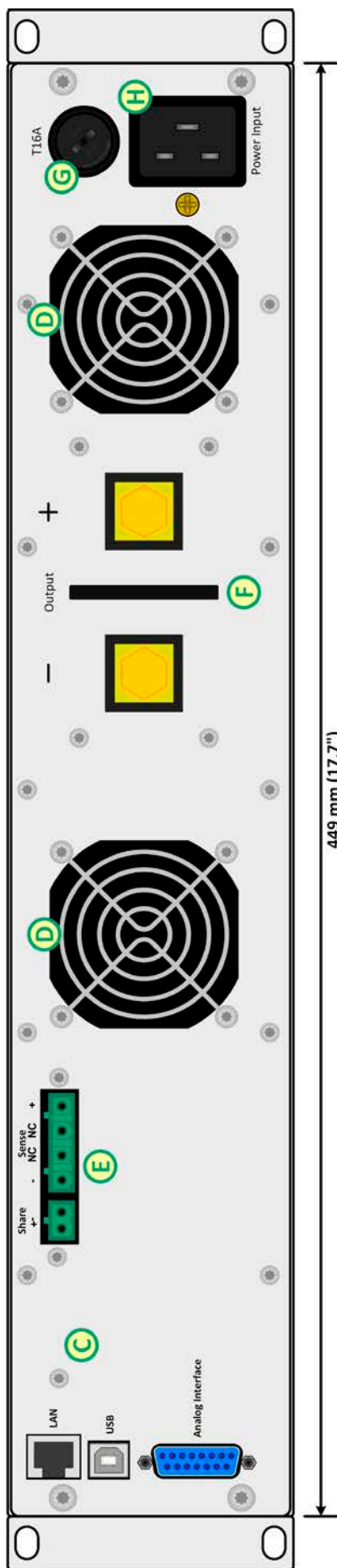



Figure 2 - Rear side (standard version)

 Do not loosen the grounding point (brass screw next to AC inlet) in order to connect PE cables! The device is supposed to be grounded via the AC cord, while the grounding point is used to connect the enclosure to PE.

- A - Power switch
- B - Control panel
- C - Control interfaces (digital, analog)
- D - Exhausts
- E - Share Bus and remote sensing connectors
- F - DC output (terminal type 1)
- G - AC input fuse
- H - AC input connector

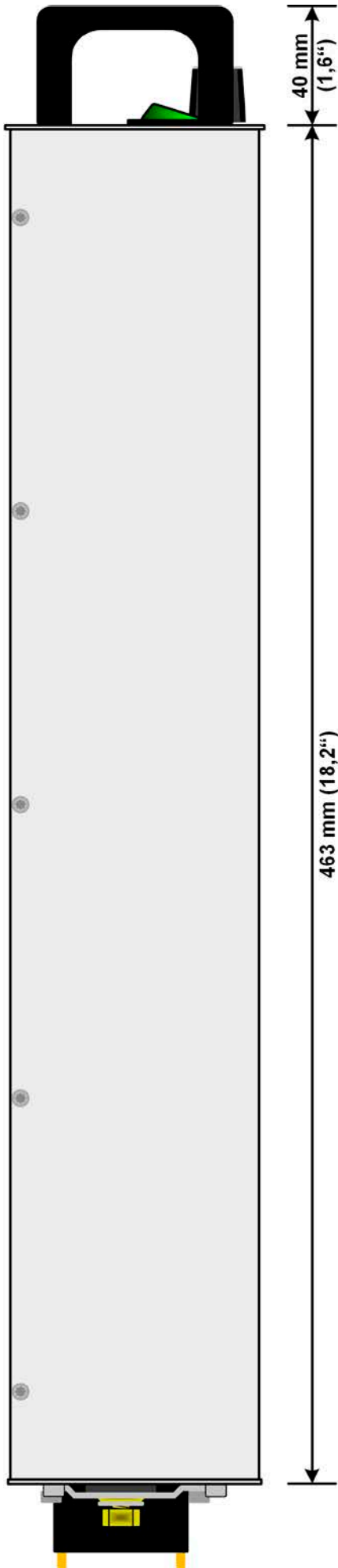

Figure 3 - Left hand side view, DC terminal type 1

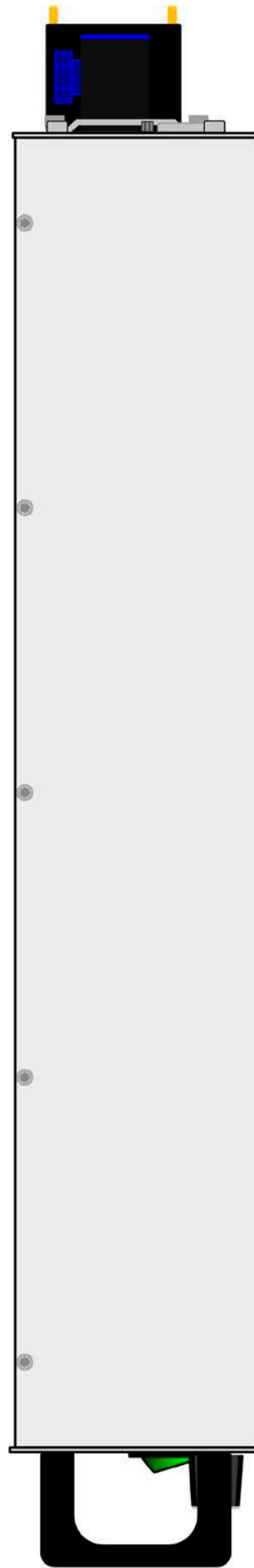

Figure 4 - Right hand side view, DC terminal type 2

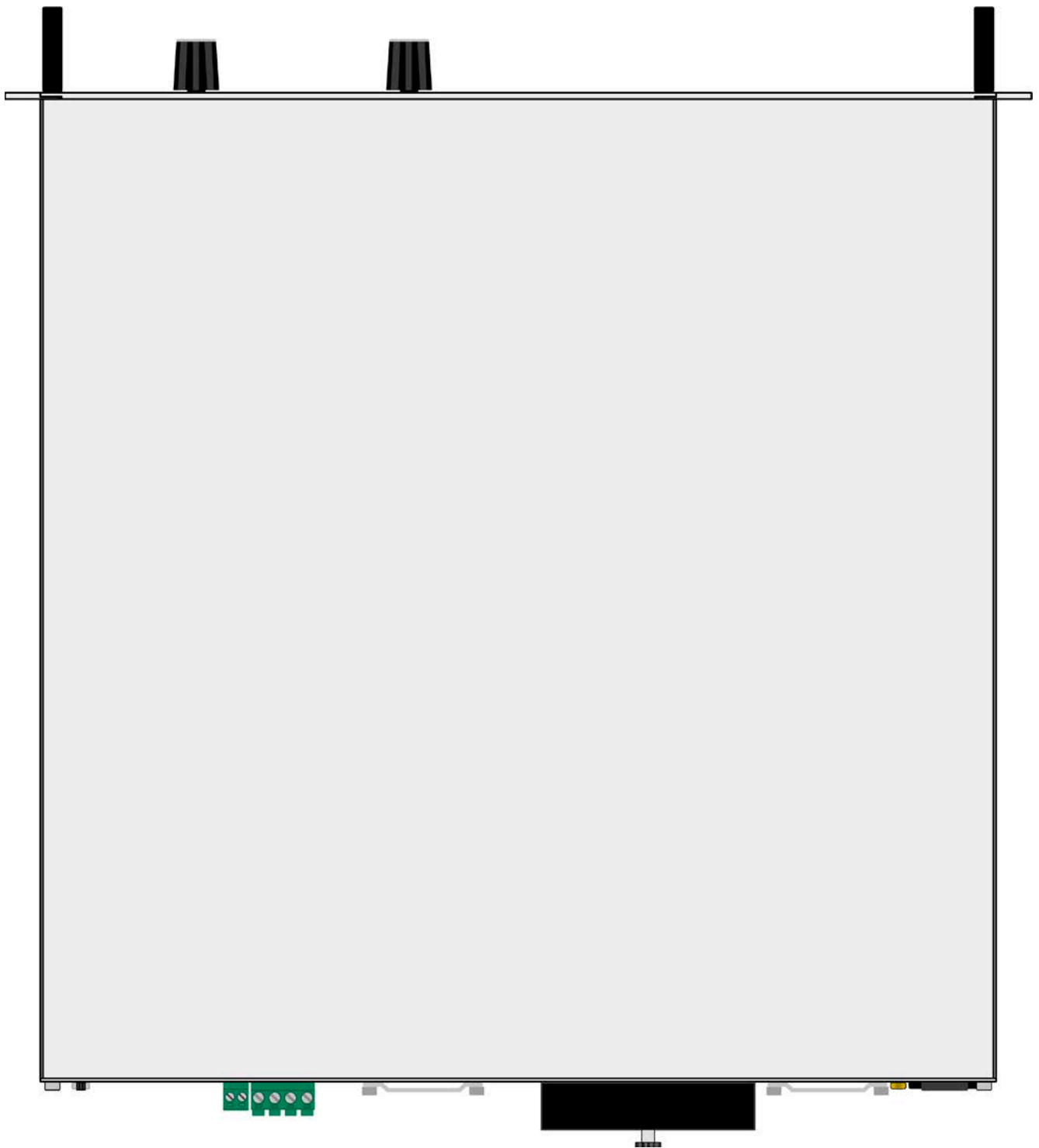

Figure 5 - View from above, with DC cover (terminal type 1)

1.8.5 Control elements

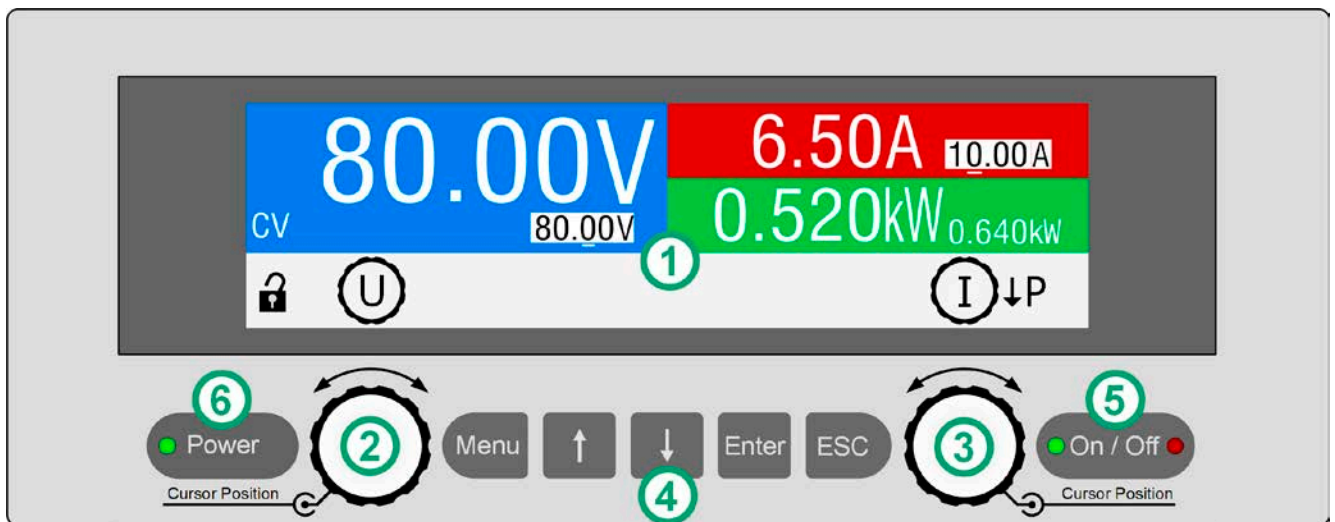





Figure 6- Control Panel

Overview of the elements on the control panel

For a detailed description see section „1.9.5. The control panel (HMI)“.

(1)	Display Used for indication of set values, menus, conditions, actual values and status.
(2)	Left hand rotary knob, with button function Turn: adjusts various set values which are related to the DC output voltage , also adjusts parameters in the setup menu Push: selects the decimal position of a value to be changed (cursor)
(3)	Right hand rotary knob, with button function Turn: adjusts various set values which are related to the DC output current, the DC output power, also adjusts parameters in the setup menu Push: selects the decimal position of a value to be changed (cursor)
(4)	Pushbuttons
	 Is used to access the device menu (while the DC output is off) or to quickly access the HMI lock feature (while the DC output is on)
	 Are used to navigate in the sub menus of the device menu and to switch between parameters and values, as well as to switch the knob assignment in the main screen
	 Is used to access sub menus in the device menu, to submit changes of settings and values, as well as to unlock the HMI
(5)	On/Off Button for DC output  Used to toggle the DC output between on and off, also used to acknowledge alarms. The LEDs “On” and “Off” indicate the state of the DC output, no matter if the device is manually controlled or remotely.
(6)	LED “Power” Indicates different colors during the start of the device and once ready for operation, it turns green and remains for the period of operation.

1.9 Construction and function

1.9.1 General description

The electronic high performance power supplies of the PS 9000 2U series are especially suitable for test systems and industrial controls due to their compact construction in a 19" enclosure with 2 height units (2U).

For remote control using a PC or PLC the devices are provided as standard with a USB slot and an Ethernet port on the back side as well as a galvanically isolated analog interface. All interfaces are galvanically isolated up to 1500 V DC.

In addition, the devices offer as standard the possibility for parallel connection in Share bus operation for constant current sharing. Operating in this way allows up to 16 units to be combined to a single system with a total power of up to 48 kW.

All models are controlled by microprocessors. These enable an exact and fast measurement and display of actual values.

1.9.2 Block diagram

The block diagram illustrates the main components inside the device and their relationships.

There are digital, microprocessor controlled components (KE, DR, HMI), which can be target of firmware updates.

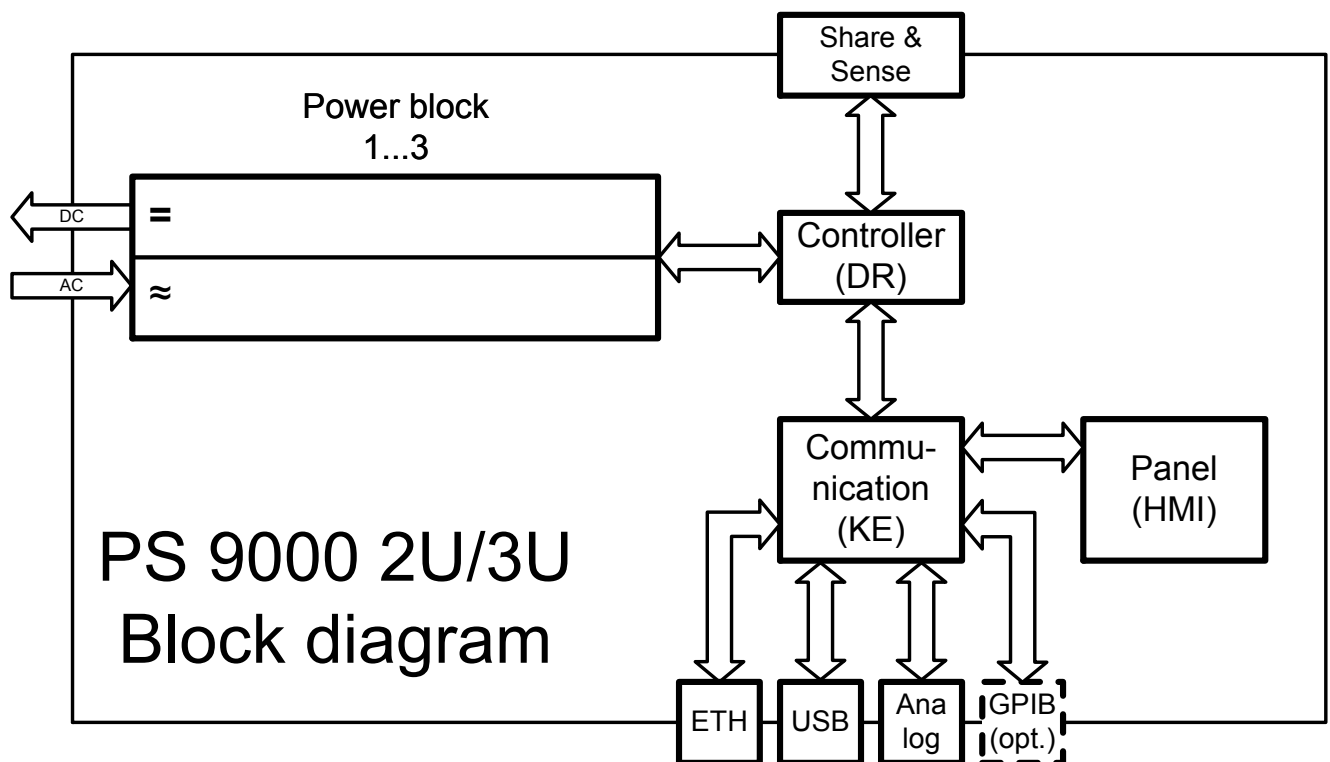

1.9.3 Scope of delivery

1 x Power supply device

1 x AC cord (IEC type plug 250 V / 16 A or 13 A UK plug or 16 A Commando plug, depending on shipping destination and power rating)

1 x Share Bus plug

1 x Remote sensing plug

1 x 1.8 m (6 ft) USB cable

1 x USB stick with documentation and software

1 x Set of metal strip for reconfiguration of desktop <-> 19"

1.9.4 Options

These options are usually ordered along with the order of a new unit, because they are permanently built-in during the manufacturing process. Retrofitting upon request.

3W GPIB interface	Replaces the standard Ethernet port by a permanently installed GPIB port. The device will keep the USB and analog interfaces. Via the GPIB port, it can only support SCPI commands.
-----------------------------	---

1.9.5 The control panel (HMI)

The HMI (Human Machine Interface) consists of a color TFT display, two rotary knobs with button function, one LED and six pushbuttons.

1.9.5.1 Display

The display is divided into a number of areas:

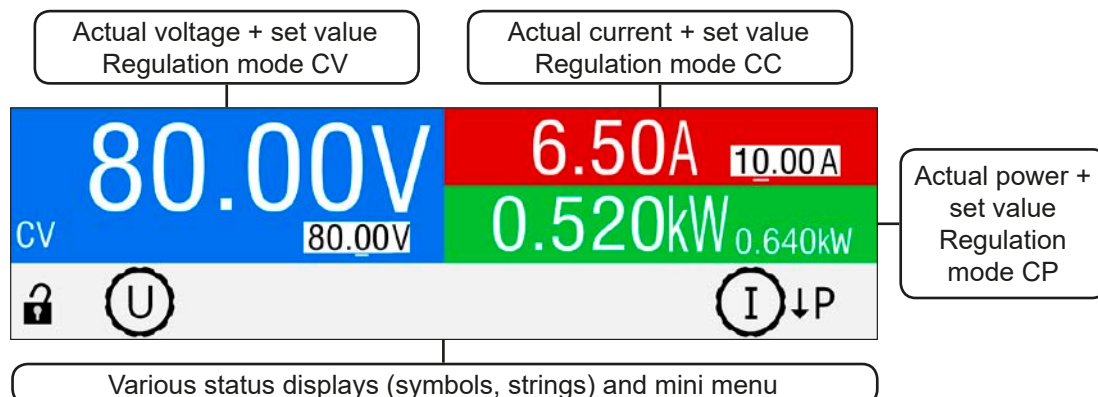

• Actual values and set values area (upper half)

In normal operation the DC output values (large numbers) and set values (small numbers) for voltage, current and power.

While the DC output is switched on, the actual regulation mode **CV**, **CC** or **CP** is displayed in the corresponding colored areas, as shown in the figure above with example “CV”.

The set values can be adjusted by rotating the knobs below the display, whereas pushing the knobs are used to select the digit to be changed. Logically, the values are increased by clockwise turning and decreased by anti-clockwise turning. The current assignment of set a value to a knob is indicated by the corresponding set value being displayed in inverted form and also by the knob depiction in the status area showing the physical sign (U, I,P). In case these are not shown, the values can't be adjusted manually, like in HMI lock or remote control.

General display and settings ranges:

Display	Unit	Range	Description
Actual voltage	V	0-125% U_{Nom}	Actual values of DC output voltage
Set value voltage	V	0-102% U_{Nom}	Set value for limiting the DC output voltage
Actual current	A	0.2-125% I_{Nom}	Actual value of DC output current
Set value current	A	0-102% I_{Nom}	Set value for limiting the DC output current
Actual power	kW	0-125% P_{Nom}	Actual value of output power, $P = U * I$
Set value power	kW	0-102% P_{Nom}	Set value for limiting DC output power
Adjustment limits	A, V, kW	0-102% Nominal val.	U-max, I-min etc., related to the physical units
Protection settings	A, V, kW	0-110% Nominal val.	OVP, OCP etc., related to the physical units

• Status display (lower part)

This area displays various status texts and symbols:

Display	Description
	The HMI is locked
	The HMI is unlocked
Remote:	The device is under remote control from....
Analogthe built-in analog interface
USBthe built-in USB port
Ethernetthe built-in Ethernet port
Local	The device has been locked by the user explicitly against remote control
Alarm:	Alarm condition which has not been acknowledged or still exists.

1.9.5.2 Rotary knobs



As long as the device is in manual operation, the two rotary knobs are used to adjust set values, as well as setting the parameters in the settings menu. For a detailed description of the individual functions see section „3.4 Manual operation“ on page 42. Both rotary knobs have an additional pushbutton function to select the decimal position of the value to be set. In this way the set current value of a device with, for example, nominal 120 A can be adjusted in increments of 10 A or 0.1 A (see 1.9.5.4 for minimum step width).

1.9.5.3 Button function of the rotary knobs

The rotary knobs also have a pushbutton function which is used in all menu options for value adjustment to move the cursor by rotation as shown:



1.9.5.4 Resolution of the displayed values

In the display, set values can be adjusted in certain increments. The number of decimal places depends on the device model. The values have 4 or 5 digits, while actual and set values related to the same physical unit always have the same number of digits.

Adjustment resolution and number of digits of set values in the display:

Voltage, OVP, U-min, U-max			Current, OCP, I-min, I-max			Power, OPP, P-max		
Nominal	Digits	Minimum increment	Nominal	Digits	Minimum increment	Nominal	Digits	Minimum increment
40 V / 80 V	4	0.01 V	4 A / 6 A	4	0.001 A	all	4	0.001 kW
200 V	5	0.01 V	10 A / 12 A	5	0.001 A			
360 V	4	0.1 V	15 A / 20 A	5	0.001 A			
500 V	4	0.1 V	25 A	5	0.001 A			
750 V	4	0.1 V	30 A / 40 A	4	0.01 A			
			50 A / 60 A	4	0.01 A			
			120 A	4	0.1 A			



In manual operation every set value can be set in the increments given above. In this case the actual output values set by the device will lie within percentage tolerances as shown in the technical data sheets. These will influence the actual values.

1.9.6 USB port

The USB-B port on the back side of the device is provided for communication with the device and for firmware updates. The included USB cable can be used to connect the device to a PC (USB 2.0, USB 3.0). The driver is delivered on the included USB stick or is available as download and installs a virtual COM port. Details for remote control can be found in external documentation, a general programming guide, on the web site of the manufacturer or on the included USB stick.

The device can be addressed via the USB port either using the international standard ModBus RTU protocol or by SCPI language. The device recognizes the message protocol used automatically.

If remote control is in operation the USB port has no priority over either the analog interface or the Ethernet interface and can, therefore, only be used alternatively to these. However, monitoring is always available.

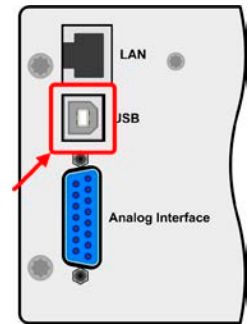

1.9.7 Ethernet port

The Ethernet port on the back side of the device (standard version of device only) is provided for communication with the device in terms of remote control or monitoring. The user has basically two options of access:

1. A website (HTTP, port 80) which is accessible in a standard browser under the IP or the host name given for the device. This website offers to configuration page for network parameters, as well as a input box for SCPI commands.
2. TCP/IP access via a freely selectable port (except 80 and other reserved ports). The standard port for this device is 5025. Via TCP/IP and this port, communication to the device can be established in most of the common programming languages.

Using the Ethernet port, the device can either be controlled by commands from SCPI or ModBus RTU protocol, while automatically detecting the type of message.

The network setup can be done manually or by DHCP. The transmission speed is set to "Auto negotiation" and means it can use 10 MBit/s or 100 MBit/s. 1 GBit/s isn't supported. Duplex mode is always full duplex.

If remote control is in operation the Ethernet port has no priority over either the analog interface or the USB interface and can, therefore, only be used alternatively to these. However, monitoring is always available.

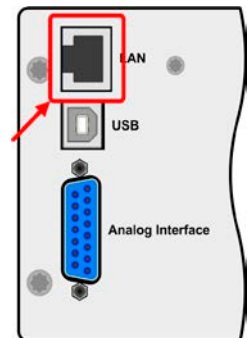

1.9.8 Analog interface

This 15 pole Sub-D socket on the back side of the device is provided for remote control of the device via analog signals or switching conditions.

If remote control is in operation this analog interface can only be used alternately to the digital interface. However, monitoring is always available.

The input voltage range of the set values and the output voltage range of the monitor values, as well as reference voltage level can be switched in the settings menu of the device between 0-5 V and 0-10 V, in each case for 0-100%.

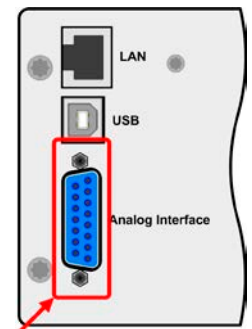

1.9.9 Share Bus-Connection

The 2 pole Phoenix socket ("Share") on the back side of the device is provided for connection to equally named sockets on compatible power supplies series to achieve a balanced load current distribution during parallel connection of up to 16 units. Following power supply series are compatible:

- PSI 9000 2U
- PSI 9000 3U / PSI 9000 WR
- ELR 9000 / ELR 9000 HP
- EL 9000 B
- PSE 9000
- PS 9000 1U *
- PS 9000 2U *
- PS 9000 3U *

* From hardware revision 2, see type label (in case it does not show "Revision" on type label, it is revision 1)

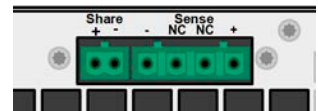

1.9.10 Sense connector (remote sensing)

If the output voltage has to be dependent on the consumer location rather than the DC output of the power supply, then the input "Sense" can be connected to the consumer where the DC connection is made. This compensates, up to a certain limit, the voltage difference between the power supply output and the consumer, which is caused by the high current through the load cables. The maximum possible compensation is given in the technical data.

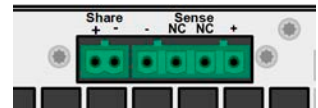

1.9.11 GPIB port (optional)

The optional GPIB connector, which is available with option 3W, will replace the Ethernet connector of standard version devices. Option 3W then offers a different three-way interface with GPIB, USB and analog interfaces.

The connection to a PC or other GPIB port is done with standard GPIB cables from stock, which can have straight or 90 ° connectors.

When using cable with 90 ° connectors, the USB port will be inaccessible.

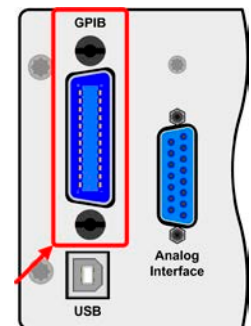

2. Installation & commissioning

2.1 Transport and storage

2.1.1 Transport



- The handles on the front side of the device are **not** for carrying!
- Because of its weight, transport by hand should be avoided where possible. If unavoidable then only the housing should be held and not on the exterior parts (handles, DC output terminal, rotary knobs).
- Do not transport when switched on or connected!
- When relocating the equipment use of the original packing is recommended
- The device should always be carried and mounted horizontally
- Use suitable safety clothing, especially safety shoes, when carrying the equipment, as due to its weight a fall can have serious consequences.

2.1.2 Packaging

It is recommended to keep the complete transport packaging for the lifetime of the device for relocation or return to the manufacturer for repair. Otherwise the packaging should be disposed of in an environmentally friendly way.

2.1.3 Storage

In case of long term storage of the equipment it is recommended to use the original packaging or similar. Storage must be in dry rooms, if possible in sealed packaging, to avoid corrosion, especially internal, through humidity.

2.2 Unpacking and visual check

After every transport, with or without packaging, or before commissioning, the equipment should be visually inspected for damage and completeness using the delivery note and/or parts list (see section „1.9.3. *Scope of delivery*“). An obviously damaged device (e.g. loose parts inside, damage outside) must under no circumstances be put in operation.

2.3 Installation

2.3.1 Safety procedures before installation and use



- The device may, according to model, have a considerable weight. Therefore the proposed location of the equipment (table, cabinet, shelf, 19" rack) must be able to support the weight without restriction.
- When using a 19" rack, rails suitable for the width of the housing and the weight of the device are to be used. (see „1.8.3. *Specific technical data*“)
- Before connecting to the mains ensure that the connection is as shown on the product label. Overvoltage on the AC supply can cause equipment damage.

2.3.2 Preparation

Mains connection for a PS 9000 2U series device is done via the included 2 meters long 3 pole mains cord. In case a different AC wiring is required, make sure that the other cable has at least a cross section of 2.5 mm² (AWG 12) is used.

Dimensioning of the DC wiring to the load/consumer has to reflect the following:



- The cable cross section should always be specified for at least the maximum current of the device.
- Continuous operation at the approved limit generates heat which must be removed, as well as voltage loss which depends on cable length and heating. To compensate for these the cable cross section should be increased and the cable length reduced.

2.3.3 Installing the device



- Select the location for the device so that the connection to the load is as short as possible.
- Leave sufficient space behind the equipment, minimum 30 cm (1 ft), for ventilation.

A device in a 19" housing will usually be mounted on suitable rails and installed in 19" racks or cabinets. The depth of the device and its weight must be taken into account. The handles on the front are for sliding in and out of the cabinet. Slots on the front plate are provided for fixing the device (fixing screws not included).

Acceptable and unacceptable installation positions:

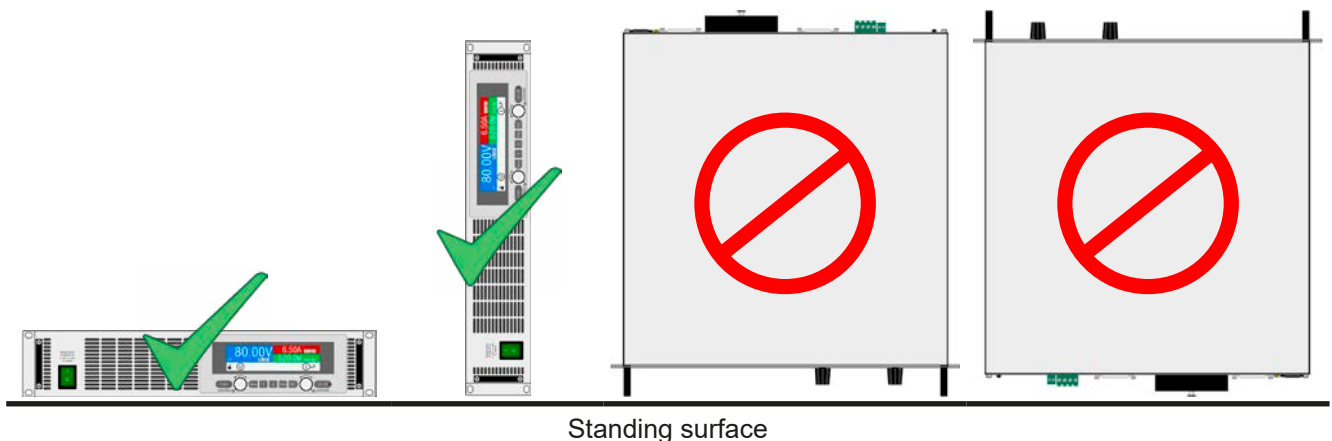

Standing surface

2.3.4 Connection to AC supply



- The device can be connected to any wall socket or multi-socket outlet, as long as those feature a safety contact (PE) and are capable for 16 A.
- When connecting the device to a multi-socket outlet, along with other electric devices, it is important to consider the total power consumption of all devices on the outlet, so that the maximum current (power ÷ minimum voltage) does not exceed the definition for the wall socket, the multi-socket outlet and/or main distribution
- Before plugging in the input plug ensure that the device is switched off by its mains switch!
- The brass screw next to the AC socket must not be untightened!

The device is delivered with a 3 pole mains cord. If the device is going to be connected to a standard 2-phase or 3-phase supply, following leads and phases are required:

Nominal power	Phases	Supply type
1 kW - 3 kW	L1 or L2 or L3, N, PE	Wall socket

The default input values of all models in this series are: 230 V, 16 A, 50 Hz. It is fused with 16A. The maximum input current depends on the higher current intake at low AC voltage (for minimum input voltage see technical specs). Custom made cables thus require to have a cross section of 1.5 mm² (AWG16) minimum per lead, recommend is 2.5 mm² (AWG12).

2.3.5 Connection to DC loads



- In the case of a device with a high nominal current and hence a thick and heavy DC connection cable it is necessary to take account of the weight of the cable and the strain imposed on the DC connection. Especially when mounted in a 19" cabinet or similar, where the cable hangs on the DC output, a strain reliever should be used.
- Connection to and operation with transformerless DC-AC inverters (for example solar inverters) is restricted, because the inverter can shift the potential of negative output (DC-) against PE (ground), which is generally limited to max. 400 V DC.
- Connection to and operation with transformerless DC-AC inverters can lead to an increased leakage current due to those inverters often coupling DC to AC, which could cause RCDs to trigger earlier

The DC load output is on the rear side of the device and **is not** protected by a fuse. The cross section of the connection cable is determined by the current consumption, cable length and ambient temperature.

For cables **up to 1.5 m** (5 ft) and average ambient temperature up to 50 °C (122 °F), we recommend:

up to 10 A :	0,75 mm ² (AWG18)	up to 15 A :	1,5 mm ² (AWG14)
up to 30 A :	4 mm ² (AWG10)	up to 40 A :	6 mm ² (AWG8)
up to 60 A :	16 mm ² (AWG4)	up to 120 A :	35 mm ² (AWG1)

per lead (multi-conductor, insulated, openly suspended). Single cables of, for example, 70 mm² may be replaced by e.g. 2x35 mm² etc. If the cables are long then the cross section must be increased to avoid voltage loss and overheating.

2.3.5.1 DC terminal types

The table below shows an overview of the various DC terminals. It is recommended that connection of load cables always utilizes flexible cables with ring lugs.

Type 1: Models up to 80 V output voltage	Type 2: Models from 200 V output voltage
M8 (8 mm) bolt on a brass block Recommendation: M8 ring lug with a 8.4 mm hole	Screw clamp connection M6, on copper rail Recommendation: M6 ring lug with a 6.5 mm hole

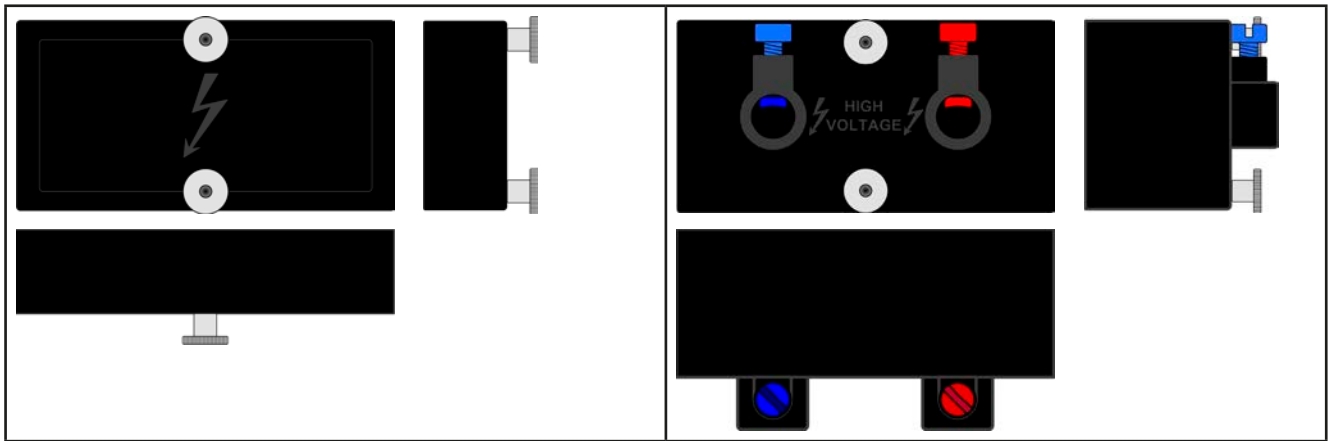

2.3.5.2 Cable lead and plastic cover

A plastic cover for contact protection is included for the DC terminal. It should always be installed. Both cover type are fixed to the DC terminal, by knurled nuts. Furthermore the cover for type 1 has break outs so that the supply cable can be laid in various directions.



The connection angle and the required bending radius for the DC cable must be taken into account when planning the depth of the complete device, especially when installing in a 19" cabinet or similar. For type 2 connectors only a horizontal lead can be used to allow for installation of the cover.

Examples:

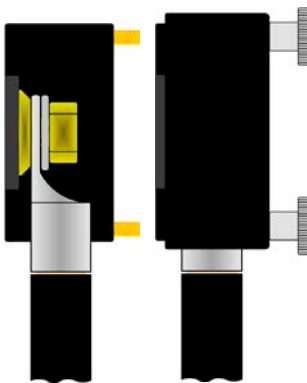

- Type 1, up or down
- Space saving in depth
- No bending radius

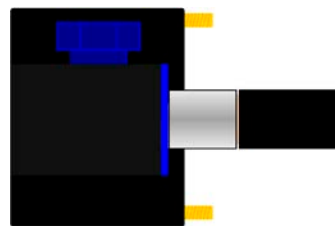

- Type 2, horizontal lead
- Space saving in height
- Large bending radius

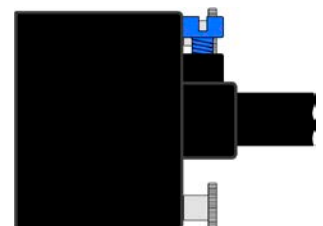

2.3.6 Grounding of the DC output

Grounding one of the DC output poles is allowed. Doing so results in a potential shift of the other pole against PE. Because of insulation, there is a max. allowed potential shift of the DC output poles, which also depends on the device model. Refer to „1.8.3. Specific technical data“ for details.

2.3.7 Connection of remote sensing

In order to compensate, to a certain degree, the voltage loss in a DC cable, the device provides the possibility to connect the remote sensing input "Sense" to the load. The device recognizes the remote sensing mode automatically and regulates the output voltage (only in CV operation) at the load rather than at its own DC output.

In the technical specifications (see section „1.8.3. *Specific technical data*“) the level of maximum possible compensation is given. If that is insufficient, the cable cross section must be increased.



Both pins „NC“ of the Sense connector must not be wired!



- The cross section of the sense cables is noncritical. However, it should be increased with increasing cable length. Recommendation: for cables up to 5 m (16 ft) use at least 0.5 mm²
- Sense cables should be twisted and laid close to the DC cables to damp oscillation. If necessary, an additional capacitor should be installed at the load/consumer to eliminate oscillation
- The sense cables must be connected + to + and - to - at the load, otherwise both systems may be damaged

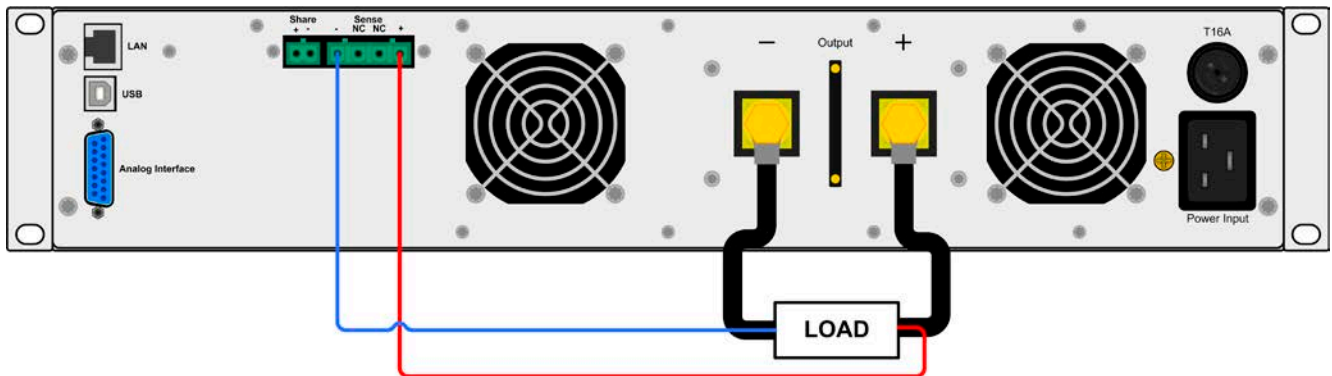

Figure 7 - Example for remote sensing wiring

2.3.8 Connecting the "Share" bus

The "Share" connector on the back side is intended to balance the current of multiple units in parallel operation by balancing the output voltage in CV operation. Thus it's recommended to use the Share bus in this operation mode. For further information about this mode of operation can be found in section „3.9.1. *Parallel operation in Share Bus mode*“.

The Share bus furthermore can be used to connect the power supply to a compatible electronic load (see section „3.9.4. *Two quadrants operation (2QO)*“), in order to achieve a correct switchover between sink and source in the so-called two-quadrants operation.

For the connection of the share bus the following must be paid attention to:



- Connection is only permitted between compatible devices (see „1.9.9. *Share Bus-Connection*“ for details) and between a max. of 16 units
- When switching off one or multiple units of a parallel system, because less power is required for an application, it's recommended to remove the Share bus plug from the inactive units, because their Share bus port's impedance could have a negative impact on the Share bus
- If a two-quadrants operation system has to be set up where multiple power supplies are connected to one electronic load unit or a group of electronic loads, all units should be connected via Share bus.
- The Share bus is referenced to DC minus. When building a series connection (where allowed, depending on model), the DC minus will shift its potential and so will the Share bus

2.3.9 Connecting the analog interface

The 15 pole connector (Type: Sub-D, D-Sub) on the rear side is an analog interface. To connect this to a controlling hardware (PC, electronic circuit), a standard plug is necessary (not included in the scope of delivery). It is generally advisable to switch the device completely off before connecting or disconnecting this connector, but at least the DC output.



The analog interface is galvanically isolated from the device. Therefore do not connect any ground of the analog interface (AGND) to the DC minus output as this will cancel the galvanic isolation.

2.3.10 Connecting the USB port

In order to remotely control the device via this port, connect the device with a PC using the included USB cable and switch the device on.

2.3.10.1 Driver installation (Windows)

On the initial connection with a PC the operating system will identify the device as new hardware and will try to install a driver. The required driver is for a Communications Device Class (CDC) device and is usually integrated in current operating systems such as Windows 7 or 10. But it is strongly recommended to use the included driver installer (on USB stick) to gain maximum compatibility of the device to our softwares.

2.3.10.2 Driver installation (Linux, MacOS)

We can't provide drivers or installation instructions for these operating systems. Whether a suitable driver is available is best carried out by searching the Internet.

2.3.10.3 Alternative drivers

In case the CDC drivers described above are not available on your system, or for some reason do not function correctly, commercial suppliers can help. Search the Internet for suppliers using the keywords "cdc driver windows" or "cdc driver linux" or "cdc driver macos".

2.3.11 Initial commission

For the first start-up after purchasing and installing the device, the following procedures have to be executed:

- Confirm that the connection cables to be used are of a satisfactory cross section
- Check that the default settings for set values, safety and monitoring functions and communication are suitable for your application and change them where necessary, as described in the manual
- In case of remote control via PC, read the additional documentation for interfaces and software
- In case of remote control via the analog interface, read the section in this manual concerning analog interfaces and, where needed, other appropriate documentation especially concerning the use of such interfaces

2.3.12 Commission after a firmware update or a long period of non-use

In case of a firmware update, return of the equipment following repair or a location or configuration change, similar measures should be taken to those of initial start up. Refer to „2.3.11. Initial commission“.

Only after successful checking of the device as listed may it be operated as usual.

2.3.13 Initial network setup

The device is delivered with default network parameters (see „3.4.3.6. Menu “Communication”“). The Ethernet/ LAN port is immediately ready for use after the initial commission.

For wiring, i.e. the hardware connection to a network, contact and ask your IT manager or any similar responsible person. Network cable of common type (CAT5 or better) can be used.

In order to set up the network parameter to your needs, you have two options: the setup menu or the device's website. For the configuration in the setup menu please refer to „3.4.3.6. Menu “Communication”“.

For the configuration via the device's website, you need the device to be connected to a network or directly to a PC which can access the default IP 192.168.0.2.

► How to do the network setup on the device website

1. In case the device display is in any kind of menu, have menu to main display.
2. Open the device website in a browser by entering the default IP (<http://192.168.0.2>) or the default host name (<http://Client>, only possible if there is a running DNS in the network) into the URL box.
3. After the website has been completely loaded, check the status field item “**Access**” to show the status “**free**”. In case it shows different, the device is either already in remote control (**rem**) or blocked from remote control (**local**). If it shows “**local**”, first remove the block. Refer to section „3.5.2. Control locations“ to do that.
4. If it says “**rem**” in the “**Access**” item, skip to step 5. Else enter command **syst:lock on** (attention! space before **on**) into the **SCPI command** box and send with return key. Check if item “**Access**” in status field changes to “**rem-eth**” (means: remote Ethernet).
5. Switch to page **CONFIGURATION** (upper left corner) and set up the network parameters as well as the port here resp. activate DHCP and submit the change with **SUBMIT** button.
6. Wait a few seconds before testing the new IP by entering it in the browser's URL box. Opening the website again by using the host name is only possible after the device has restarted, because only then the new IP is reported to the DNS.

3. Operation and application

3.1 Personal safety



- In order to guarantee safety when using the device, it is essential that only persons operate the device who are fully acquainted and trained in the required safety measures to be taken when working with dangerous electrical voltages
- For models which can generate a hazardous voltages or are connected to such, all cables with lugs must use insulated ones. If necessary, install additional measures to protect against physical contact, such as a cover
- Whenever the load and DC output are being re-configured, the device should be switched off completely, not only the DC output!

3.2 Operating modes

A power supply is internally controlled by different control circuits, which shall regulate voltage, current and power to the adjusted values and hold them constant, if possible. These circuits follow typical laws of control systems engineering, resulting in different operating modes. Each operating mode has its own characteristics which are explained below in short form.



- *Unloaded operation isn't considered as a normal operation mode and can thus lead to false measurements, for example when calibrating the device*
- *The optimal working point of the device is between 50% and 100% voltage and current*
- *It's recommended to not run the device below 10% voltage and current, in order to meet technical values like ripple or transient times*

3.2.1 Voltage regulation / Constant voltage

Voltage regulation is also called constant voltage operation (CV).

The DC output voltage of a power supply is held constant on the adjusted value, unless the output current or the output power according to $P = U_{OUT} \cdot I_{OUT}$ reaches the adjusted current or power limit. In both cases the device will automatically change to constant current or constant power operation, whatever occurs first. Then the output voltage can not be held constant anymore and will sink to a value resulting from Ohm's law.

While the DC output is switched on and constant voltage mode is active, the condition "CV mode active" will be indicated on the graphic display by the abbreviation CV and also passed as a signal to the analog interface, as well stored as status which can be read via digital interface.

3.2.1.1 Transient time after load step

For constant voltage mode (CV), the technical date "Transient time after load step" (see 1.8.3) defines a time that is required by the internal voltage regulator of the device to settle the output voltage after a load step. Negative load steps, i. e. high load to lower load, will cause the output voltage to overshoot for a short time until compensated by the voltage regulator. The same occurs with a positive load step, i. e. low load to high load. There the output collapses for a moment. The amplitude of the overshoot resp. collapse depends on the device model, the currently adjusted output voltage and the capacity on the DC output and can isn't stated as a specific technical value.

Depictions:

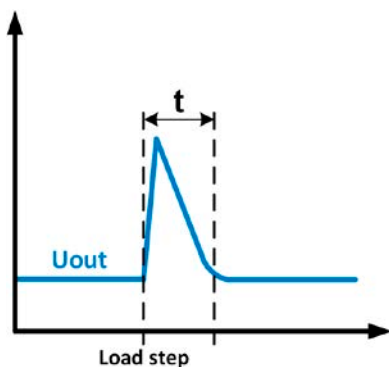

Example for neg. load step: the DC output will rise above the adjusted value for a short time. t = transient time to settle the output voltage.

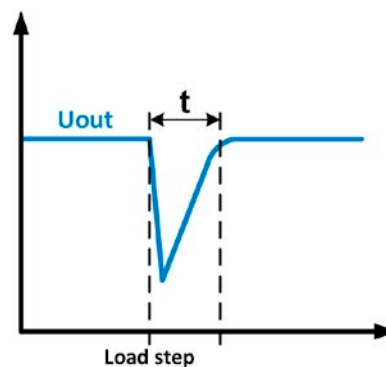

Example for pos. load step: the DC output will collapse below the adjusted value for a short time. t = transient time to settle the output voltage.

3.2.2 Current regulation / constant current / current limiting

Current regulation is also known as current limitation or constant current mode (CC).

The DC output current is held constant by the power supply, once the output current to the load reaches the adjusted limit. Then the power supply automatically switches. The current flowing from the power supply is determined by the output voltage and the load's true resistance. As long as the output current is lower than the adjusted current limit, the device will be either in constant voltage or constant power mode. If, however, the power consumption reaches the set maximum power value, the device will switch automatically to power limiting and sets the output current according to $I_{MAX} = P_{SET} / U_{IN}$, even if the maximum current value is higher. The current set value, as determined by the user, is always an upper limit only.

While the DC output is switched on and constant current mode is active, the condition "CC mode active" will be indicated on the graphic display by the abbreviation CC and also passed as signal "no CV" to the analog interface, as well stored as status which can be read via digital interface.

3.2.3 Power regulation / constant power / power limiting

Power regulation, also known as power limiting or constant power (CP), keeps the DC output power of a power supply constant if the current flowing to the load in relation to the output voltage and the resistance of the load reaches the adjusted power value according to $P = U \cdot I$ resp. $P = U^2 / R$. The power limitation then regulates the output current according to $I = \sqrt{P / R}$, where R is the load's resistance.

Power limiting operates according to the auto-range principle such that at lower output voltages higher current flows and vice versa in order to maintain constant power within the range P_N (see diagram to the right).

Constant power operation primarily impacts the output current. This means, the adjusted maximum output current can not be achieved if the maximum power value limits the output current according to $I = P / U$. The adjustable set value of current, as indicated in the display, is always only an upper limit.

While the DC output is switched on and constant power mode is active, then the condition "CP mode active" will be shown on the display by the abbreviation **CP** and can also be read as a status message via digital interface.

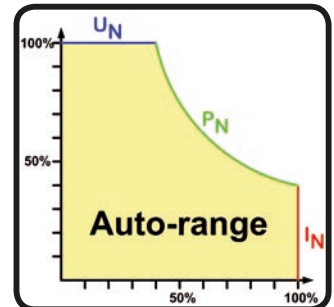

In remote sensing operation, i. e. when the Sense input is connected to the load, the additional voltage output and thus power output isn't included in the actual power value, because the device then measures and regulates the voltage on the Sense input.

3.2.3.1 Power derating

Due to European standard fusing of wall sockets (16 A) and the extended input voltage range, power supply models as from 1500 W have a fixed derating, which becomes active below a certain input voltage level (for value see „1.8.3. Specific technical data“) and will derate the maximum available output power for a 1500 W model down to 1000 W and for a 3000 W model down to 2500 W. The derating only affects the available output power, thus the full range for power set value adjustment remains, though the device will switch earlier to constant power operation. This situation of constant power can't be indicated by status "CP". Active derating can then only be detected by reading the actual values of voltage and current and by calculating the power.



There is no status "CP" available if the power set value is bigger than the derated actual output power of the device. It means, power derating isn't indicated.

3.3 Alarm conditions



This section only gives an overview about device alarms. What to do in case your device indicates an alarm condition is described in section „3.6. Alarms and monitoring“.

As a basic principle, all alarm conditions are signaled optically (Text + message in the display), acoustically (if activated) and as a readable status via the digital interface. With any alarm occurring, the DC output of the device is switched off. In addition, the alarms OT and OVP are reported as signals on the analogue interface.

3.3.1 Power Fail

Power Fail (PF) indicates an alarm condition which may have various causes:

- AC input voltage too high (mains overvoltage)
- AC input voltage too low (mains undervoltage, mains failure)
- Defect in the input circuit (PFC)



Switching off the device by the mains switch can not be distinguished from a mains blackout and thus the device will signal a PF alarm every time the device is switched off. This can be ignored.

3.3.2 Overtemperature

An overtemperature alarm (OT) can occur if an excess temperature inside the device causes it to switch off the DC output. This alarm condition is shown as message “Alarm: OT” in the display. In addition, the condition will be passed as a signal to the analog interface, as well as alarm status and counter which both can be read via digital interface.

3.3.3 Overvoltage

An overvoltage alarm (OVP) will switch off the DC output and can occur if:

- the power supply itself, as a voltage source, generates an output voltage higher than set for the overvoltage alarm limit (OVP, 0...110% U_{Nom}) or the connected load somehow returns voltage higher than set for the overvoltage alarm limit
- the OV threshold has been adjusted too close above the output voltage. If the device is in CC mode and if it then experiences a negative load step, it will make the voltage rise quickly, resulting in a voltage overshoot for a short moment which can already trigger the OVP

This function serves to warn the user of the power supply acoustically or optically that the device probably has generated an excessive voltage which could damage the connected load application.



The device isn't fitted with protection from external overvoltage.

3.3.4 Overcurrent

An overcurrent alarm (OCP) will switch off the DC output and can occur if:

- The output current in the DC output reaches the adjusted OCP limit.

This function serves to protect the connected load application so that this isn't overloaded and possibly damaged due to an excessive current.

3.3.5 Overpower

An overpower alarm (OPP) will switch off the DC output and can occur if:

- the product of the output voltage and output current in the DC output reaches the adjusted OPP limit.

This function serves to protect the connected load application so that this isn't overloaded and possibly damaged due to an excessive power consumption.

3.4 Manual operation

3.4.1 Switching on the device

The device should, as far as possible, always be switched on using the rotary switch on the front of the device. Alternatively this can take place using an external cutout (contactor, circuit breaker) of suitable current capacity.

After switching on, the display will show the manufacturers logo for a few seconds, plus some information like device model, firmware version(s), serial number and item number and will then be ready for use. In setup (see section „3.4.3. Configuration in the setup menu“) in the second level menu **“General settings”** is an option **“Output after power ON”** in which the user can determine the condition of the DC output after power-up. Factory setting here is **“OFF”**, meaning that the DC output on power-up is always switched off. Selection **“Restore”** means that the last condition of the DC output will be restored, either on or off. All set values are always saved and restored.



For the time of the start phase the analog interface can signal undefined statuses on the output pins such as OT or OVP. Those signals must be ignored until the device has finished booting and is ready to work.

3.4.2 Switching off the device

On switch-off the last output condition and the most recent set values are saved. Furthermore, a PF alarm (power failure) will be reported, but can be ignored.

The DC output is immediately switched off and after a short while fans will shut down and after another few seconds the device will be completely powered off.

3.4.3 Configuration in the setup menu

The setup menu serves to configure all operating parameters which are not constantly required. It can be entered by pushing **Menu**, but only while the DC output is switched off. See figures below.

If the DC output is switched on the settings menu will not be shown, but the quick menu and some status information.

Menu navigation is done with the pushbuttons ,  and **Enter**. Parameters (values, settings) are set using the rotary knobs.

The assignments of the rotary knobs, if multiple values can be set in a particular menu, is always the same: parameters on the left-hand side -> left-hand knob, parameters on the right-hand side -> right-hand knob



Some setting parameters are self-explanatory, others are not. The latter will be explained on the pages following.

3.4.3.1 Menu "General Settings"

Element	Description
Allow remote control	Selection "NO" means that the device can't be remotely controlled over any of the digital or analog interfaces. If remote control isn't allowed, the status will be shown as " Local " in the status area on the main display. Also see section 1.9.5.1
Analog interface range	Selects the voltage range for the analog set input values, actual output values and reference voltage output of the analog interface on the rear. <ul style="list-style-type: none"> • 0...5 V = Range is 0...100% set /actual values, reference voltage 5 V • 0...10 V = Range is 0...100% set /actual values, reference voltage 10 V See also section „3.5.4. Remote control via the analog interface“
Analog interface Rem-SB	Determines with "normal" (default), that the function and levels of input REM-SB are as described in „3.5.4.4. Analog interface specification“. With selection "inverted", the described function is logically inverted. Also see example a) in „3.5.4.7. Application examples“.
Analog interface pin 6	Pin 6 of the analog interface (see section 3.5.4.4) is by default assigned to only signal the device alarms OT and PF. This parameter allows to also enable signaling only one of both (3 possible combinations): <p>OT = Enable/disable signaling of alarm OT on pin 6</p> <p>PF = Enable/disable signaling of alarm PF on pin 6</p>
Analog interface pin 14	Pin 14 of the analog interface (see section 3.5.4.4) is by default assigned to only signal the device alarm OVP. This parameter allows to also enable signaling further device alarms (7 possible combinations): <p>OVP = Enable/disable signaling of alarm OVP on pin 14</p> <p>OCP = Enable/disable signaling of alarm OCP on pin 14</p> <p>OPP = Enable/disable signaling of alarm OPP on pin 14</p>
Analog interface pin 15	Pin 15 of the analog interface (see section 3.5.4.4) is by default assigned to only signal the regulation mode CV. This parameter allows to enable signaling a different device status (2 options): <p>Regulation mode = Enable/disable signaling of CV reg mode on pin 15</p> <p>DC status = Enable/disable signaling of DC output status on pin 15</p>
Analog Rem-SB action	Pin REM-SB of the analog interface can be used to control the DC output of the device even without remote control via analog interface being activated. This setting determines the type of action: <ul style="list-style-type: none"> • DC OFF = Toggling the pin only switches the DC output off • DC ON/OFF = If the DC output has been switched on before from elsewhere, toggling the pin can switch the output off and on again
DC output after power ON	Determines the condition of the DC output after power-up. <ul style="list-style-type: none"> • OFF = DC output is always off after switching on the device. • Restore = DC output condition will be restored to the condition prior to switch off.
DC output after PF alarm	Determines how the DC output shall react after a power fail (PF) alarm has occurred: <ul style="list-style-type: none"> • OFF = DC output will be switched off and remain until user action • AUTO = DC output will switch on again after the PF alarm cause is gone and if it was switched on before the alarm occurred
DC output after remote	Determines the condition of the DC output after leaving remote control either manually or by command. <ul style="list-style-type: none"> • OFF = DC output will be always off when switching from remote to manual • AUTO = DC output will keep the last condition

Element	Description
DC output after OT alarm	Determines how the DC output shall react after an overtemperature alarm has occurred: <ul style="list-style-type: none"> • OFF = DC output will be switched off and remain until user action • AUTO = DC output will switch on again after the device has cooled down and if the output has been switched on before the alarm occurred
Share Bus mode	Default setting: Slave For parallel operation of multiple units, where using the Share bus connection is recommended. In parallel operation, every unit could be Master or Slave , but only one must be Master .

3.4.3.2 Menu “Calibrate Device”

From within this menu, a calibration and readjustment procedure for output voltage and current can be started. For further details refer to „4.3. Calibration (readjustment)“.

Element	Description
Voltage calibration	Starts the calibration procedure for output voltage U (set/actual value)
Sense volt. calibration	Starts the calibration procedure for remote sensing input „Sense“
Current calibration	Starts the calibration procedure for output current I (set/actual value)
Set calibration date	Here you can enter the date of the most recent calibration (year, month, day)
Save and exit	This menu item saves and leaves the setup menu to main display

3.4.3.3 Menu “Reset Device”

Entering this menu item will prompt for acknowledgment to reset the device completely to default settings and set values. Selection “**No**” will cancel the reset procedure, while selection “**Yes**”, submitted by  button, will instantly reset the device.

3.4.3.4 Menu “Profiles”

See „3.8 Loading and saving a user profile“ on page 57.

3.4.3.5 Menu “Overview” and “About HW, SW,...”

This menu pages display an overview of the set values (U, I, P) and related protection settings (OVP, OCP, OPP) as well as limits settings and an alarm history (counter) of alarms that might have occurred since the last time the unit was switched on. Furthermore they show device relevant data such as serial number, article number etc.

3.4.3.6 Menu “Communication”

Here settings for the Ethernet port (on rear side of device) are made. The USB port there doesn't require any settings. When delivered or after a complete reset, the Ethernet port has following **default settings** assigned:

- DHCP: off
- IP: 192.168.0.2
- Subnet mask: 255.255.255.0
- Gateway: 192.168.0.1
- Port: 5025
- DNS: 0.0.0.0
- Host name: Client
- Domain: Workgroup

Those settings can be changed anytime at will, in the setup menu or via the device website, which you can open from the current IP or host name.

Submenu "IP Settings 1"

Element	Description
Get IP address	Manual (default): uses the default (after delivery or reset) or the last set network parameters. Those parameters are not overwritten by selection " DHCP " and remain when switching back from " DHCP " to " Manual " DHCP : after switching to DHCP and submitting the change with button  , the device will instantly try to get network parameters (IP, subnet mask, gateway, DNS) assigned from a DHCP server. If the attempt fails, the device will use the settings from " Manual " again.
IP address	Only available with setting " Get IP address = Manual ". Default value: 192.168.0.2 Permanent manual setting of the device's IP address in standard IP format
Subnet mask	Only available with setting " Get IP address = Manual ". Default value: 255.255.255.0 Permanent manual setting of the subnet mask in standard IP format
Gateway	Only available with setting " Get IP address = Manual ". Default value: 192.168.0.1 Permanent manual setting of the gateway address in standard IP format

Submenu "IP Settings 2"

Element	Description
Port	Default value: 5025 Adjust the socket port here, which belongs to the IP address and serves for TCP/P access when controlling the device remotely via Ethernet
DNS address	Default value: 0.0.0.0 Permanent manual setting of the network address of a domain name server (short: DNS) which has to be present in order to translate the host name to the device's IP, so the device could alternatively access by the host name
Enable TCP keep-alive	Default setting: No Activates/deactivates the so-called "keep-alive" functionality of Ethernet connections

Submenu "Communication Protocols"

Element	Description
Enabled	Enables or disables SCPI or ModBus communication protocols for the device. The change is immediately effective after submitting it with ENTER button. Only one of both can be disabled.

Submenu "Communication Timeout"

Element	Description
Timeout USB (ms)	Default value: 5, Range: 5...65535 USB/RS232 communication timeout in milliseconds. Defines the max. time between two subsequent bytes or blocks of a transferred message. For more information about the timeout refer to the external programming documentation "Programming ModBus & SCPI".
Timeout ETH (s)	Default value: 5, Range: 5...65535 Defines a timeout after which the device would close the socket connection if there was no communication between the controlling unit (PC, PLC etc.) and the device for the adjusted time. The timeout is ineffective as long as option "TCP Keep-alive" (see above) is enabled and the keep-alive functionality of the network is active.

Submenu "Node address" (only displayed for devices with GPIB interface)

Element	Description
Node address	Default value: 1 Adjusts the primary GPIB address for the GPIB port which is available with installed option 3W. Address range: 1...30. The secondary address isn't used.

Screen “View settings”

This screen lists an overview of all active network and Ethernet port related settings and parameters, the status of DHCP, the MAC address and also the domain and host name, which can not be set in the device’s setup menu.

3.4.3.7 Menu “HMI Setup”

These settings refer exclusively to the control panel (HMI) and the display. The table lists all available settings for the HMI, no matter in which sub menu they can be found.

Element	Description
Language	Selection of the display language between German, English, Russian or Chinese. Default setting: English
Backlight	The choice here is whether the backlight remains permanently on or if it should be switched off when no input via push buttons or rotary knob is done for 60 s. As soon as input is done, the backlight returns automatically. Furthermore the backlight intensity can be adjusted here. Default settings: 100, Always on
Status page	Switches to a different main screen layout. The user can select between two layouts which are depicted by small graphics as a preview. Also see section „3.4.6. Switching the main screen view“. Default setting: Layout 1
Key Sound	Activates or deactivates sounds when pushing a button on the HMI. It can usefully signal that the action has been accepted. Default setting: off
Alarm Sound	Activates or deactivates the additional acoustic signal of an alarm. See also „3.6. Alarms and monitoring“. Default setting: off
HMI Lock	Activates the HMI lock. See „3.7. Control panel (HMI) lock“ for details Default settings: Lock all, No

3.4.4 Adjustment limits

By default, all set values (U, I, P) are freely adjustable from 0 to 102% of rated value. This may be obstructive in some cases, especially for protection of applications against overcurrent. Therefore upper and lower limits for current and voltage can be set which limit the range of the adjustable set values.

Limit Settings			
U-min=	10.00V	U-max=	75.00V
I-min=	005.0A	I-max=	100.0A
		P-max=	1.50kW

For power only an upper value limit can be set.

These limits apply to every kind setting a value. That also includes remote control via analog or digital interface. In remote control, the global range of 0...100% (digital) resp. 0...5 V / 0...10 V remains, only narrowed by the limits defined here.

An example: you would define the limits for a model with 80 V, 120 A and 3 kW as depicted in the screen above, with U-min = 10 V and U-max = 75 V. In analog remote control, the active control voltage range for mode 0...10 V results as 1.25 V...9.375 V. As soon as the device is switched to analog remote control, it would put out minimum 10 V, even there is nothing connected to voltage control input VSEL.

Beyond those limits, values given by digital commands are not accepted and will return an error (when using SCPI). Values given from analog control voltages are ignored (clipping).

► How to configure the adjustment limits

1. Switch off the DC output and push button **Menu** to call the setup menu.
2. Push button **Enter** to call sub menu "**Settings**". In the sub menu navigate to "**Limit Settings**" and push **Enter** again.
3. In the screen you can now adjust the settings **I-min**, **I-max**, **U-min**, **U-max** and **P-max** with the rotary knobs. Switching between values is done with the arrow buttons **↑** and **↓**.
4. Accept the settings with **Enter** or discard them with **ESC**.



The adjustment limits are coupled to the set values. It means, that the upper limit (-max) may not be set lower than the corresponding set value. Example: If you wish to set the limit for the current set value I-max to 100 A while the currently adjusted current set value is 120 A, then the set value first would have to be reduced to 100 A or less. The same applies vice versa when adjusting I-min.

3.4.5 Manual adjustment of set values

The set values for voltage, current and power are the fundamental operating possibilities of a power supply and hence the two rotary knobs on the front of the device are usually assigned two of the three values in manual operation. Default assignment is voltage and current.

The set values can only be adjusted with the **rotary knobs**.





Entering a value changes it at any time, no matter if the output is switched on or off.



When adjusting the set values, upper or lower limits may come into effect. See section „3.4.4. Adjustment limits“. Once a limit is reached, the display will show a note like “Limit: U-max” etc. or “[i]” for 1.5 seconds next to the adjusted value

► How to adjust values U, I or P with the rotary knobs

1. First check whether the value to be changed is assigned to one of the rotary knobs. The assignment can be changed by switching the assignment of the right-hand rotary knob with the arrow buttons.
2. With mode **UI** selected and as long as the main display is active, turn the left-hand knob to adjust output voltage and the right-hand knob to adjust the output current. In mode **UP**, turn the right-hand knob to adjust the output power. The arrow buttons   can be used to toggle between adjustment of current and power set value.

3. Any set values can be adjusted with the adjustment limits. For switching the digit to adjust, push the rotary knob that you are currently using to adjust the value. Every push moves the cursor under the digit in clockwise order:

 →  → 

3.4.6 Switching the main screen view

The main screen, also called status page, with its set values, actual values and device status can be switched from the standard view mode with three values to a simpler mode which only shows two physical values.

The advantage of the alternative view mode is that both actual values are displayed with **bigger numbers**, so they read be read from a larger distance. Refer to „3.4.3.7. Menu “HMI Setup”“ to see where to switch the view mode in the MENU. Comparison:

Layout 1 (standard)



Layout 2 (alternative)



Differences of layout 2:



- The hidden value is shown when switching the knob assignment, which also changes the upper right half of the display
- The actual regulation mode is displayed no matter what pair of physical values is currently shown, as the example in the upper figure on the right side depicts with CV

3.4.7 The quick menu

The quick menu offer access to some feature which are also accessible from the regular menu, but here they can be used which DC output is switched on.

The quick menu is shown when pressing the  button and looks like this:



Navigation in the menu is also done with arrow buttons  /  and .

For example, in this menu it's possible to preset the output values and to submit with button  which allows for set value steps which would not be possible when rotating a knob. Furthermore, the HMI lock can be activated here in a shorter way.

3.4.8 Switching the DC output on or off

The DC output of the device can be manually or remotely switched on and off. This can be restricted in manual operation by the control panel being locked.



Switching the DC output on during manual operation or digital remote control can be disabled by pin REM-SB of the built-in analog interface. For more information refer to 3.4.3.1 and example a) in 3.5.4.7.

► How to manually switch the DC output on or off

1. As long as the control panel (HMI) isn't fully locked press the button ON/OFF. Otherwise you are asked to disable the HMI lock first.
2. This button toggles between on and off, as long as a change isn't restricted by an alarm or the device is locked in "remote".

► How to remotely switch the DC output on or off via the analog interface

1. See section „3.5.4 Remote control via the analog interface“ on page 51.

► How to remotely switch the DC output on or off via the digital interface

1. See the external documentation "Programming Guide ModBus & SCPI" if you are using custom software, or refer to the external documentation of LabView VIs or other software provided by the manufacturer.

3.5 Remote control

3.5.1 General

Remote control is principally possible via any of the built-in interface ports USB, Ethernet/LAN, analog or optional GPIB. Important here is that only the analog or any digital interface can be in control. It means that if, for example, an attempt were to be made to switch to remote control via the digital interface whilst analog remote control is active (pin REMOTE = LOW and “**Remote: Analog**” on display) the device would report an error at the digital interface. In the opposite direction a switch-over via pin REMOTE would be ignored. In both cases, however, status monitoring and reading of values are always possible.

3.5.2 Control locations

Control locations are those locations from where the device can be controlled. Essentially there are two: at the device (manual operation) and outside (remote control). The following locations are defined:

Displayed location	Description
-	If neither of the other locations is displayed then manual control is active and access from the analog or digital interfaces is allowed. This location isn't explicitly displayed
Remote	Remote control via any interface is active
Local	Remote control is locked, only manual operation is allowed.

Remote control may be allowed or inhibited using the setting “**Allow remote control**” (see „3.4.3.1. Menu “General Settings”“). In *inhibited* condition the status “**Local**” will be displayed in the status area (lower half, middle) of the display. Activating the inhibit can be useful if the device is remotely controlled by software or some electronic device, but it is required to make adjustments at the device or deal with emergency, which would not be possible remotely.

Activating condition “**Local**” causes the following:

- If remote control via the digital interface is active (“**Remote**”), then remote control is immediately terminated and must be reactivated at the PC once “**Local**” is no longer active
- If remote control is via the analog interface is active (“**Remote**”), then remote operation is only interrupted until remote control is allowed again, because pin REMOTE continues to signal “remote control = on”. Exception: if the level of pin REMOTE is changed to HIGH during the “**Local**” phase

3.5.3 Remote control via a digital interface

3.5.3.1 Selecting an interface

The device only supports the built-in digital interfaces USB and Ethernet (standard models) resp. GPIB (optional). For USB, a standard USB cable is included in the delivery, as well as a driver for Windows on USB stick. The USB interface requires no setup.

The Ethernet interface typically requires network setup (manual or DHCP), but can also be used with its default parameters right from the start.

The GPIB interface requires you to select a unique address in case it is connected to other GPIB bus members.

3.5.3.2 General

For the network port installation refer to „1.9.7. Ethernet port“.

The digital interface require little or no setup for operation and can be directly used with their default configuration. All specific settings will be permanently stored, but could also be reset to defaults with the setup menu item “**Reset Device**”.

Via the digital interface primarily the set values (voltage, current, power) and device conditions can be set and monitored. Furthermore, various other functions are supported as described in separate programming documentation.

Changing to remote control will retain the last set values for the device until these are changed. Thus a simple voltage control by setting a target value is possible without changing any other values.

3.5.3.3 Programming

Programming details for the interfaces, the communication protocols etc. are to be found in the documentation “Programming Guide ModBus & SCPI” which is supplied on the included USB stick or which is available as download from the manufacturer's website.

3.5.4 Remote control via the analog interface

3.5.4.1 General

The built-in, galvanically separated, 15-pole analog interface (short: AI) is on the rear side of the device offers the following possibilities:

- Remote control of current, voltage and power
- Remote status monitoring (CV, DC output on/off)
- Remote alarm monitoring (OT, OVP, PF, OCP, OPP)
- Remote monitoring of actual values
- Remote on/off switching of the DC output

Setting the **three** set values via the analog interface always takes place concurrently. It means, that for example the voltage can not be given via the AI and current and power set by the rotary knobs, or vice versa.

The OVP set value and other supervision (events) and alarm thresholds can't be set via the AI and therefore must be adapted to the given situation before the AI is put in operation. Analog set values can be fed in by an external voltage or generated by the reference voltage on pin 3. As soon as remote control via the analog interface is activated, the values displayed will be those provided by the interface.

The AI can be operated in the common voltage ranges 0...5 V and 0...10 V in each case 0...100% of the nominal value. The selection of the voltage range can be done in the device setup. See section „3.4.3. Configuration in the setup menu“ for details.

The reference voltage sent out from pin 3 (VREF) will be adapted accordingly and is then:

0-5 V: Reference voltage = 5 V, 0...5 V set values (VSEL, CSEL, PSEL) correspond to 0...100% nominal values, 0...100% actual values correspond to 0...5 V at the actual value outputs (CMON, VMON).

0-10 V: Reference voltage = 10 V, 0...10 V set values (VSEL, CSEL, PSEL) correspond to 0...100% nominal values, 0...100% actual values correspond to 0...10 V at the actual value outputs (CMON, VMON).

Input of excess set values (e.g. >5 V in selected 5 V range or >10 V in the 10 V range) are clipped by setting the set value at 100%.

Before you begin, please read these important notes for use of the interface:



After powering the device and during the start phase the AI signals undefined statuses on the output pins such as ALARMS1. Those must be ignored until is ready to work.

- Analog remote control of the device must be activated by switching pin REMOTE (5) first. Only exception is pin REM-SB, which can be used independently since KE firmware version 2.02
- Before the hardware is connected that will control the analog interface, it shall be checked that it can't provide voltage to the pins higher than specified
- Set value input, such as VSEL, CSEL and PSEL, must not be left unconnected (i.e. floating)
- It is always required to provide all three set values at once. In case any of the set values isn't used for adjustment, it can be tied to a defined level or connected to pin VREF (solder bridge or different), so it gives 100%

3.5.4.2 Acknowledging device alarms

In case of a device alarm occurring during remote control via analog interface, the DC input will be switched off the same way as in manual control. Alarms are signaled either on pin ALARMS 1 or ALARMS 2, as configured in the **Menu** (see section „3.4.3. Configuration in the setup menu“). In case several alarms occur at once, the particular ones can only read from the unit in the display (alarm counter in **Menu**) or via digital interface.

Device alarms have to be acknowledged, i. e. deleted, also in analog remote control. Also see „3.6.2. Device alarm handling“. Acknowledgment is done with pin REM-SB switching the DC output off and on again, specifically with a HIGH-LOW-HIGH edge (min. 50ms for LOW), when using the default level setting for this pin, else it would be LOW-HIGH-LOW.

3.5.4.3 Resolution and sample rate

The analog interface is internally sampled and processed by a digital micro-controller. This causes a limited resolution of analog steps. The resolution is the same for set values (VSEL etc.) and actual values (VMON/CMON) and is 26214. Due to tolerances, the truly achievable resolution can be slightly lower.

There is furthermore a max. sample rate of 500 Hz. It means, the device can acquire analog set values and states on digital pins 500 times per second.

3.5.4.4 Analog interface specification

Pin	Name	Type*	Description	Levels	Electrical specification
1	VSEL	AI	Set voltage value	0...10 V or 0...5 V correspond to 0..100% of U_{Nom}	Accuracy 0-5 V range: < 0.4% ***** Accuracy 0-10 V range: < 0.2% ***** Input impedance $R_i > 40\text{ k} \dots 100\text{ k}$
2	CSEL	AI	Set current value	0...10 V or 0...5 V correspond to 0..100% of I_{Nom}	
3	VREF	AO	Reference voltage	10 V or 5 V	Tolerance < 0.2% at $I_{max} = +5\text{ mA}$ Short-circuit-proof against AGND
4	DGND	POT	Ground for all digital signals		For control and status signals
5	REMOTE	DI	Switching internal / remote control	Remote = LOW, $U_{Low} < 1\text{ V}$ Internal = HIGH, $U_{High} > 4\text{ V}$ Internal = Open	Voltage range = 0...30 V $I_{Max} = -1\text{ mA}$ bei 5 V $U_{LOW\text{ to HIGH typ.}} = 3\text{ V}$ Rec'd sender: Open collector against DGND
6	ALARMS 1	DO	Overheating or power fail alarm	Alarm= HIGH, $U_{High} > 4\text{ V}$ No alarm= LOW, $U_{Low} < 1\text{ V}$	Quasi open collector with pull-up against Vcc ** With 5 V on the pin max. flow +1 mA $I_{Max} = -10\text{ mA}$ at $U_{CE} = 0,3\text{ V}$ $U_{Max} = 30\text{ V}$ Short-circuit-proof against DGND
7	-	-	-	-	
8	PSEL	AI	Set power value	0...10 V or 0...5 V correspond to 0..100% of P_{Nom}	Accuracy 0-5 V range: < 0.4% ***** Accuracy 0-10 V range: < 0.2% ***** Input impedance $R_i > 40\text{ k} \dots 100\text{ k}$
9	VMON	AO	Actual voltage	0...10 V or 0...5 V correspond to 0..100% of U_{Nom}	Accuracy 0-5 V range: < 0.4% ***** Accuracy 0-10 V range: < 0.2% ***** at $I_{Max} = +2\text{ mA}$ Short-circuit-proof against AGND
10	CMON	AO	Actual current	0...10 V or 0...5 V correspond to 0..100% of I_{Nom}	
11	AGND	POT	Ground for all analog signals		For -SEL, -MON, VREF signals
12	-	-	-	-	
13	REM-SB	DI	DC output OFF (DC output ON) (ACK alarms ****)	Off = LOW, $U_{Low} < 1\text{ V}$ On= HIGH, $U_{High} > 4\text{ V}$ On = Open	Voltage range = 0...30 V $I_{Max} = +1\text{ mA}$ at 5 V Rec'd sender: Open collector against DGND
14	ALARMS 2	DO	Overvoltage alarm Overcurrent alarm Overpower alarm	Alarm = HIGH, $U_{High} > 4\text{ V}$ No alarm = LOW, $U_{Low} < 1\text{ V}$	Quasi open collector with pull-up against Vcc ** With 5 V on the pin max. flow +1 mA $I_{Max} = -10\text{ mA}$ at $U_{CE} = 0,3\text{ V}$, $U_{Max} = 30\text{ V}$ Short-circuit-proof against DGND
15	STATUS***	DO	Constant voltage regulation active DC output	CV = LOW, $U_{Low} < 1\text{ V}$ CC/CP = HIGH, $U_{High} > 4\text{ V}$ On = LOW, $U_{Low} < 1\text{ V}$ Off = HIGH, $U_{High} > 4\text{ V}$	

* AI = Analog Input, AO = Analog Output, DI = Digital Input, DO = Digital Output, POT = Potential

** Internal Vcc approx. 14.3 V

*** Only one of both signals possible, see section 3.4.3.1

**** Only during remote control

***** The error of a set value input adds to the general error of the related value on the DC output of the device

3.5.4.5 Overview of the Sub-D socket

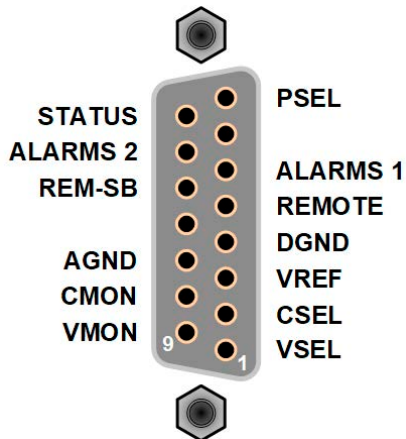

3.5.4.6 Simplified diagram of the pins

	<p>Digital Input (DI)</p> <p>The DI is internally pulled up and thus it requires to use a contact with low resistance (relay, switch, contactor etc.) in order to clearly pull the signal down to DGND.</p>		<p>Analog Input (AI)</p> <p>High resistance input (impedance >40 kΩ...100 kΩ) for an operational amplifier circuit.</p>
	<p>Digital Output (DO)</p> <p>A quasi open collector, realized as high resistance pull-up against the internal supply. The design doesn't allow the pin to be loaded, but to switch signals by sinking current.</p>		<p>Analog Output (AO)</p> <p>Output from an operational amplifier circuit, with low impedance. See specifications table above.</p>

3.5.4.7 Application examples

a) Switching off the DC output via the pin REM-SB

A digital output, e.g. from a PLC, may be unable to cleanly pull down the pin as it may not be of low enough resistance. Check the specification of the controlling application. Also see pin diagrams above.

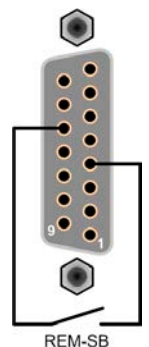

In remote control, pin REM-SB is used to switch the DC output of the device on and off. This function is also available without remote control being active and can on one hand block the DC terminal from being switched on in manual or digital remote control and on the other hand the pin can switch the DC output on or off, but not standalone. See below at "Remote control has not been activated".

It is recommended that a low resistance contact such as a switch, relay or transistor is used to switch the pin to ground (DGND).

Following situations can occur:

- **Remote control has been activated**

During remote control via analog interface, only pin REM-SB determines the states of the DC output, according to the levels definitions in 3.5.4.4. The logical function and the default levels can be inverted by a parameter in the setup menu of the device. See 3.4.3.1.

If the pin is unconnected or the connected contact is open, the pin will be HIGH. With parameter "Analog interface Rem-SB" being set to "Normal", it requests "DC output on". So when activating remote control, the DC output will instantly switch on.

• **Remote control isn't active**

In this mode of operation pin REM-SB can serve as lock, preventing the DC output from being switched on by any means. This results in following possible situations:

DC-output	+	Level on pin REM-SB	+	Parameter „Analog interface Rem-SB“	→ Behavior
is off	+	HIGH	+	Normal	→ DC output not locked. It can be switched on by pushbutton “On/Off” (front panel) or via command from digital interface.
		LOW	+	Inverted	
	+	HIGH	+	Inverted	→ DC output locked. It can not be switched on by pushbutton “On/Off” (front panel) or via command from digital interface. When trying to switch on, a pop-up in the display resp. an error message will be generated.
		LOW	+	Normal	

In case the DC output is already switched on, toggling the pin will switch the DC output off, similar to what it does in analog remote control:

DC-output	+	Level on pin REM-SB	+	Parameter „Analog interface Rem-SB“	→ Behavior
is on	+	HIGH	+	Normal	→ DC output remains on, nothing is locked. It can be switched on or off by pushbutton or digital command.
		LOW	+	Inverted	
	+	HIGH	+	Inverted	→ DC output will be switched off and locked. Later it can be switched on again by toggling the pin. During lock, pushbutton or digital command can delete the request to switch on by pin.
		LOW	+	Normal	

b) Remote control of current and power

Requires remote control to be activated (Pin REMOTE = LOW)

The set values PSEL and CSEL are generated from, for example, the reference voltage VREF using potentiometers for each. Hence the power supply can selectively work in current limiting or power limiting mode. According to the specification of max. 5 mA for the VREF output, potentiometers of at least 10 kΩ must be used.

The voltage set value VSEL is to VREF and will thus be permanently 100%.

If the control voltage is fed in from an external source it is necessary to consider the input voltage ranges for set values (0...5 V oder 0...10 V).

Use of the input voltage range 0...5 V for 0...100% set value halves the effective resolution.

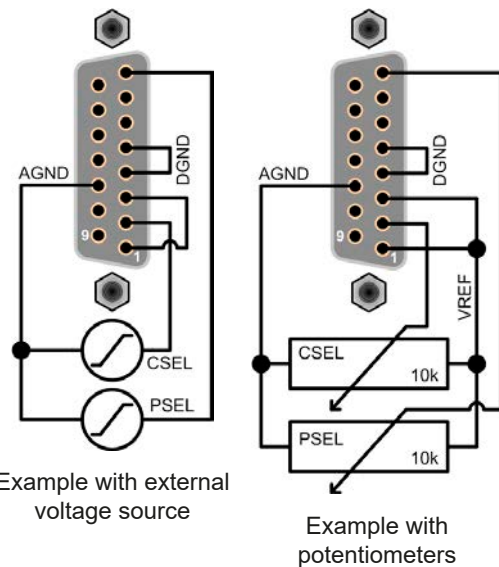

c) Reading actual values

Via the AI the output values for current and voltage can be monitored. These can be read using a standard multimeter or similar.

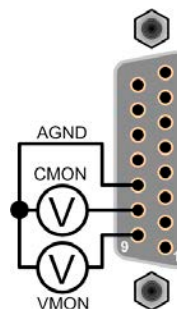

3.6 Alarms and monitoring

3.6.1 Definition of terms

Device alarms (see „3.3. Alarm conditions“) are defined as conditions like overvoltage or overtemperature, signaled in any form to the user of the device in order to take notice.

Those alarms are always indicated in the front display as readable abbreviated text, as well as status readable via digital interface when controlling or just monitoring remotely and, if activated, emitted as audible signal (buzzer). Furthermore, the most important alarms are also signaled by output pins on the analog interface.

From HMI firmware 2.03 on, an alarm history is available in the sub menu “Overview”. It counts alarms that occurred since the last time the unit was switched on, for statistics and later check.

3.6.2 Device alarm handling

A device alarm incident will usually lead to DC output switch-off. Some alarms must be acknowledged (see below), which can only happen if the cause of the alarm isn’t persistent anymore. Other alarms acknowledge themselves if the cause has vanished, like the OT and the PF alarm.

► **How to acknowledge an alarm in the display (during manual control)**

1. Push button  or  once.

► **How to acknowledge an alarm on the analog interface (during analog remote control)**

1. Switch off the DC output by pulling pin REM-SB to the level that corresponds to “DC output off”, then switch it on again. See section „3.5.4.7. Application examples“ for levels and logic.

► **How to acknowledge an alarm in the alarm buffer/status (during manual control)**

1. Read the error buffer (SCPI protocol) or send a specific command to acknowledge, i.e. reset alarms (Mod-Bus RTU).





Some device alarms are configurable by adjusting a threshold:

Alarm	Meaning	Description	Range	Indication
OVP	OverVoltage Protection	Triggers an alarm if the DC output voltage reaches the defined threshold. This can be caused by the device being faulty or by an external source. The DC output will be switched off.	0 V...1.1*U _{Nom}	Display, analog IF, digital IF
OCP	OverCurrent Protection	Triggers an alarm if the DC output current reaches the defined threshold. The DC output will be switched off.	0 A...1.1*I _{Nom}	
OPP	OverPower Protection	Triggers an alarm if the DC output power reaches the defined threshold. The DC output will be switched off.	0 W...1.1*P _{Nom}	

These device alarms can’t be configured and are based on hardware:

Alarm	Meaning	Description	Indication
PF	Power Fail	AC supply over- or undervoltage. Triggers an alarm if the AC supply is out of specification or when the device is cut from supply, for example when switching it off with the power switch. The DC output will be switched off which could be only temporarily, depending on the situation and setting “DC output after PF alarm” (see 3.4.3.1).	Display, analog IF, digital IF
OT	OverTemperature	Triggers an alarm if the internal temperature reaches a certain limit. The DC output will be switched off which could be only temporarily, depending on the setting “DC output after OT alarm” (see 3.4.3.1).	





► How to configure the device alarms OVP, OCP and OPP

1. Switch off the DC output and push button  to call the setup menu.
2. In the menu navigate to “**Settings**” and push . Then in the sub menu navigate to “**Protection Settings**” and push  again.
3. Set the limits for the equipment alarm relevant to your application if the default value of 110% of nominal is unsuitable.
4. Accept the settings with  or discard them with .



Those thresholds are reset to defaults when using the function “Reset Device” in setup menu.





► How to configure the alarm sound

1. Switch off the DC output and push button  to call the setup menu.
2. In the menu navigate to “**HMI Setup**” and push . Then in the sub menu navigate to “**Alarm Sound**” and push  again.
3. In the following screen set parameter “**Alarm Sound**” to either **OFF** or **ON**.
4. Accept the settings with  or discard them with .

3.7 Control panel (HMI) lock

In order to avoid the accidental alteration of a value during manual operation the rotary knobs or the key strip of the control panel (HMI) can be locked so that no alteration will be accepted without prior unlocking.

► How to lock the HMI

1. Switch off the DC output and push button  to call the setup menu.
2. In the menu navigate to “**HMI Setup**” and push . Then in the sub menu navigate to “**HMI Lock**” and push  again.
3. Make your selection for parameter “**HMI Lock:**”. With selection “**Lock all**” everything on the HMI is locked and you can’t even switch on the DC output. In order to be able to do at least that, use “**ON/OFF possible**”.
4. The lock is activated as soon as you confirm your selection with . The device will automatically exit the menu and jump back to normal display with status “**Locked**” now being indicated.

If an attempt is made to alter something whilst the HMI is locked, a requester appears in the display asking if the lock should be disabled.

► How to unlock the HMI

1. Rotate any knob or push any button except ON/OFF.

2. This request pop-up will appear:

HMI locked!
Press „Enter” to unlock.

3. Unlock the HMI by pushing  within 5 seconds, otherwise the pop-up will disappear and the HMI remains locked.





3.8 Loading and saving a user profile

The menu **"Profiles"** serves to select between a default profile and up to 5 user profiles. A profile is a collection of all settings and set values. Upon delivery, or after a reset, all 6 profiles have the same settings and all set values are 0. If the user changes settings or sets target values then these create a work profile which can be saved to one of the 5 user profiles. These profiles or the default one can then be switched. The default profile is read-only. Loading the default profile is equivalent to a reset.

The purpose of a profile is to load a set of set values, settings limits and monitoring thresholds quickly without having to readjust these. As all HMI settings are saved in the profile, including language, a profile change can also be accompanied by a change in HMI language.





On calling up the menu page and selecting a profile the most important settings can be seen, but not changed.

► How to save the current values and settings (work profile) as a user profile

1. Switch off the DC output and push button  to call the setup menu.
2. In the menu navigate to **"Profiles"** and push .
3. In the sub menu (see figure to the right) select a user profile (1-5) to save to and push  again.
4. From the selection on screen chose **"Save settings into Profile n"** and overwrite that profile with the current settings and values by confirming with .



► How to load a user profile

1. Switch off the DC output and push button  to call the setup menu.
2. In the menu navigate to **"Profiles"** and push .
3. In the sub menu (see figure to the right) select a user profile (1-5) to load and push  again.
4. In the screen you can now select **"View Profile n"** in order to check the stored settings and to decide, whether this profile is going to be loaded or not. Navigate to **"Load Profile n"** and confirm with  to finally load the profile into the work profile.



3.9 Other applications

3.9.1 Parallel operation in Share Bus mode

Multiple devices of same kind and model can be connected in parallel in order to create a system with higher total current and hence higher power. To achieve that, the units have to be connected on their DC outputs and their Share Bus. The Share Bus will balance the units in their internal voltage regulation and thus current regulation, which will result in a balanced load distribution. It means that the Share bus is only effective in constant voltage operation.

In the parallel operation, a specific unit, a “Share Bus master”, has to be picked as leading unit which drives the “Share Bus slaves”. The master unit will remain fully controllable, also via analog or digital interface. The slaves, however, are restricted regarding set value adjustment. Their set values are just limits for the units while it is controlled via the Share Bus. A slave unit still can be controlled remotely, but not like a master unit. All slaves can be monitored (actual values, status), no matter via analog or digital interface.



The Share Bus only control the process variable U (voltage). It means, the DC outputs of slave units have to be switched on or off either manually or remotely, which is very easy in analog remote control, because the related pins REM-SB could simply be connected in parallel, too. Furthermore, the Share Bus makes the set values of current and power ineffective on the slave units, so it is recommended to carefully set the protection thresholds OCP and OPP.

3.9.1.1 Wiring the DC outputs

The DC output of every unit in the parallel operation is simply connected to the next unit using cables with cross section according to the maximum current and with short as possible length.

3.9.1.2 Wiring the Share bus

The Share bus is wired from unit to unit with an ideally twisted pair of cables with non-critical cross section. We recommend to use 0.5 mm² to 1.0 mm².



- The Share bus is poled. Take care for correct polarity of the wiring!
- Share bus operation can become critical when worked dynamically and with high voltages or with potential shifts. It's thus recommended to connect the negative DC pole of the devices with short as possible cables or, ideally, copper bars. The device should be as close as possible to each other, also blocks of power supply and electronic load units in two-quadrant operation.



A max. of 16 units can be connected via Share bus.







3.9.1.3 Configuring units for Share Bus operation

For correct Share Bus operation in parallel connection, the unit picked as master has to be configured as “Share Bus master”. By default, these power supplies are set as “Share Bus slaves”, so that this configuration step could be skipped for slave units.



Only one unit in the Share Bus connection must be configured as Share Bus master, else the Share Bus won't work.

► How to configure a device as Share Bus master

1. Switch off the DC output and push button  to call the setup menu. Push  again to enter sub menu “Settings”.
2. In the sub menu navigate to “General Settings” and push  once again.
3. Use arrow button  to navigate to item “Share Bus mode” on the 2nd page and switch to setting “Master” by using the right-hand rotary knob.
4. Accept the settings with  or discard them with .

3.9.1.4 Operating the Share Bus system

After successful configuration and initialization of the master and slave units, it is recommended to check all set values and protection settings of all slaves and possibly adjust to identical values.

The slaves can be controlled manually as usual or remotely via the analog or via digital interfaces, but they don't react to voltage set values changes the same way as the master. They can, if needed, be monitored by reading actual values and status.

The master unit isn't restricted and can be used like a stand-alone unit.

3.9.1.5 Alarms and other problem situations

Parallel operation, due to the connection of multiple units and their interaction, can cause additional problem situations which do not occur when operating individual units. For such occurrences the following regulations have been defined:

- If one or more slave units are switched off on the AC side (power switch, supply undervoltage) and come back later, they're automatically included again in the system. The remaining units will continue to work without interruption, but the entire system will provide less power
- If the DC output of the master unit is switched off due to a defect or overheating, then the total parallel system can provide no output power
- If accidentally multiple or no units are defined as master the Share Bus parallel system can't be initialized

In situations where one or multiple units generate a device alarm like OV, PF or OT following applies:

- Any alarm of a slave is indicated on the slave's display only

3.9.2 Series connection

Series connection of two or multiple devices is basically possible. But for reasons of safety and isolation, some restrictions apply:



- Both, negative (DC-) and positive (DC+) output poles, are coupled to PE via type X capacitors, limiting the max. allowed potential shift (see technical specs for values)
- The Share Bus must not be wired and used!
- Remote sensing must not be used!
- Series connection is only allowed with devices of the same kind and model, i.e. power supply with power supply, like for example PS/PSI 9080-120 2U with PSI 9080-120 2U or PS 9080-120 2U

Series connection isn't supported by the software and hardware of the device. It means, all units have to be controlled separately regarding set values and DC output status, whether it is manual control or digital remote control. In remote control, an almost synchronous control can be achieved by using the Ethernet ports and sending messages as broadcast, so they address multiple units at once.

The figure below depicts the exemplary series connection of three identical devices with 200 V nominal output voltage and the maximum potential shift of any DC- output against PE:

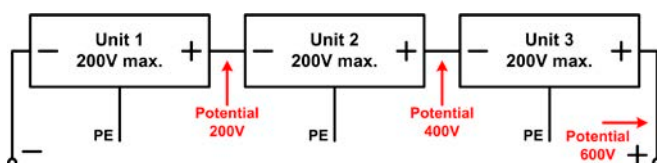

3.9.3 Operation as battery charger

A power supply can be used as a battery charger, but with some restrictions, because it misses a battery supervision and a physical separation from the load in form of a relay or contactor, which is featured with some real battery chargers as a protection.

Following has to be considered:

- No false polarity protection inside! Connecting a battery with false polarity will damage the power supply severely, even if it isn't powered.
- All models feature an internal base load (resistor), which could discharge the battery more or less slowly, even when the device is not powered. It's thus recommended to disconnect the battery as long it isn't supposed to be charged.

3.9.4 Two quadrants operation (2QO)

3.9.4.1 Introduction

This way of operating refers to the use of a source, in this case a power supply of series PS 9000 2U, and a sink, in this case an electronic load of a compatible series (see „1.9.9. Share Bus-Connection“). The source and the sink function alternately in order to test a device, such as a battery, by deliberately charging and discharging it as part of a functional or final test.

The user can decide whether the system is operated manually or the power supply only as the dominant unit or both devices should be controlled by PC. We recommend to focus on the power supply, which is intended to control the load via the Share Bus connection. The two quadrants operation is only suitable for constant voltage operation (CV).

Clarification:

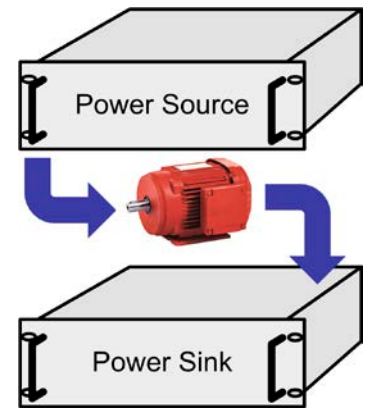
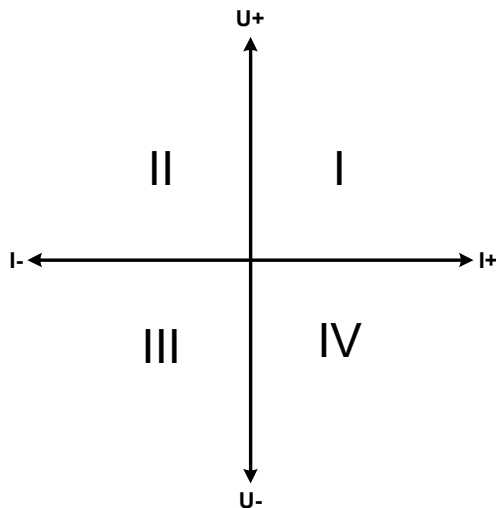

A combination of source and sink can only map the quadrants I + II. This means that only positive voltages are possible. The positive current is generated by the source or application and the negative current flows into the load..

The maximum approved limits for the application should be set in the power supply. This can be done via the interface. The electronic load should preferably be in operating mode CV. The load will then, using the Share Bus, control the output voltage of the power supply.

Typical applications:

- Fuel cells
- Capacitor tests
- Motor driven applications
- Electronic tests where a high dynamic discharge is required.

3.9.4.2 Connecting devices to a 2QO

There are a number of possibilities to connect source(s) and sink(s) to make a 2QO:

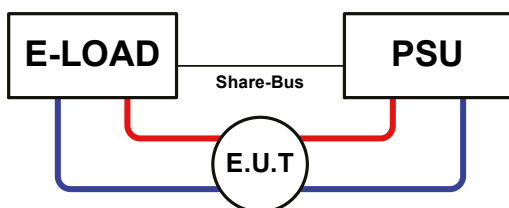

Configuration A:

1 e-load and 1 power supply, plus 1 test object (E.U.T).

This is the most common configuration for 2QO. The nominal values for U, I and P of the two devices should match as close as possible, for instance EL 9080-170 B and PS 9080-120 2U. The system is controlled by the power supply, which has to be set to "Master" for parameter "Share bus mode" in the setup menu.

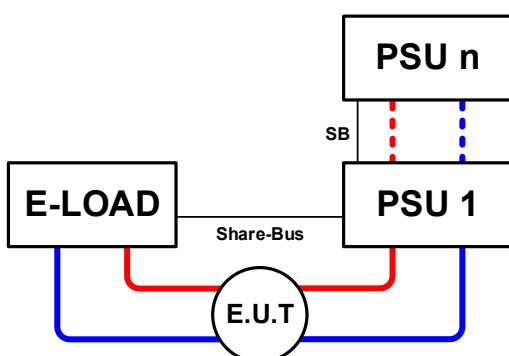

Configuration B:

1 e-load and multiple power supplies, plus 1 test object (E.U.T).

For adapting the total power of the power supply device to the possibly higher input power of the load, the power supplies are connected via Master-Slave and the load's current is shared across the power supplies when wiring the Share bus to gain a balanced load distribution.

One PSU, preferably PSU 1, has to be set to Master for the Share bus connection.

3.9.4.3 Settings on the devices

The master-slave settings in the MENU of the load device(s) also affect the Share bus. For correct 2QO operation, all involved load units must be slaves on the Share bus. This is achieved by setting the master-slave mode to OFF or SLAVE, depending on if there is digital master-slave in use or not. For the one load that is master (setting: MASTER) in the master-slave system the additional parameter "PSI/ELR system" resp. "PSI/EL system" has to be activated.

On any of the power supplies, you need set parameter "Share bus mode" to MASTER. Also see 3.4.3.1.

For safety of the connected E.U.T / D.U.T and to prevent damage, we recommend to adjust supervision thresholds like OVP, OCP or OPP on all units to the desired levels, which will then switch off the DC output resp. the DC input in case of excess.

3.9.4.4 Restrictions

After all electronic load slaves have been connected to the Share bus with one power supply as master, they can't limit their input voltage anymore to what you adjust as "U set" on the device. The correct voltage level comes from the master unit and has to be adjusted there.

If the applications requires to use the remote sensing feature in order to achieve a higher voltage accuracy on the E.U.T. only the master must be wired its Sense connector.



Using the Sense input must be considered with caution, because it could increase the tendency of oscillation.

3.9.4.5 Application example

Charging and discharging a battery with 24 V/100 Ah, using configuration A from above.

- Power supply PS 9080-120 2U with: $I_{Set} = 10$ A (charging current, 1/10 of rated capacity), $P_{Set} = 3000$ W
- Electronic load EL 9080-170 B set to: $I_{Set} = \text{max. discharging current of the battery (eg. 50 A)}$, $P_{Set} = 2400$ W, plus probably UVD = 20 V with event type "Alarm" to stop discharging at a certain low voltage threshold
- Assumption: battery has a voltage of 26 V at test start
- DC input(s) and DC output(s) of all units switched off



In this combination of devices it is recommended to always switch on the DC output of the source first and then the DC input of the sink.

1. Discharge of the battery to 24 V

Setup: Voltage on the power supply set to 24 V, DC output of power supply and DC input of load activated

Reaction: the e-load will load the battery with a maximum current of 50 A in order to discharge it to 24 V. The power supply delivers no current at this moment, because the battery voltage is still higher than what is adjusted on the power supply. The load will gradually reduce the input current in order to maintain the battery voltage at 24 V. Once the battery voltage has reached 24 V with a discharge current of approx. 0 A, the voltage will be maintained at this level by charging from the power supply.



The power supply determines the voltage setting of the load via the Share bus. In order to avoid deep discharge of the battery due to accidentally setting the voltage on the power to a very low value, it is recommended to configure the undervoltage detection feature (UVD) of the load, so it will switch off the DC input when reaching minimum allowed discharge voltage. The settings of the load, as given via the Share bus, can't be read from the load's display.

2. Charging the battery to 27 V

Setup: Voltage on the power supply set to 27 V

Reaction: the power supply will charge the battery with a maximum current of 10 A, which will gradually reduce with increasing voltage as a reaction to the changing internal resistance of the battery. The load absorbs no current at this charging phase, because it is controlled via the Share bus and set to a certain voltage, which is still higher than the actual battery voltage and the actual output voltage of the power supply. When reaching 27 V, the power supply will deliver only the current needed to maintain the battery voltage.

4. Service and maintenance

4.1 Maintenance / cleaning

The device needs no maintenance. Cleaning may be needed for the internal fans, the frequency of cleanse is depending on the ambient conditions. The fans serve to cool the components which are heated by the inherent power loss. Heavily dirt filled fans can lead to insufficient airflow and therefore the DC output would switch off too early due to overheating or possibly lead to defects.

Cleaning the internal fans can be performed with a vacuum cleaner or similar. For this the device needs to be opened.

4.2 Fault finding / diagnosis / repair

If the equipment suddenly performs in an unexpected way, which indicates a fault, or it has an obvious defect, this can not and must not be repaired by the user. Contact the supplier in case of suspicion and elicit the steps to be taken.

It will then usually be necessary to return the device to the supplier (with or without guarantee). If a return for checking or repair is to be carried out, ensure that:

- the supplier has been contacted and it is clarified how and where the equipment should be sent.
- the device is in fully assembled state and in suitable transport packaging, ideally the original packaging.
- a fault description in as much detail as possible is attached.
- if shipping destination is abroad, the necessary customs papers are attached.

4.2.1 Replacing a defect mains fuse

The device is protected by one 5x20 mm fuse (T16 A, 250 V) which is located on the rear of the device, inside a fuse holder. To replace the fuse, the device isn't required to be opened. Just remove the power cord and unscrew the fuse holder with a flat screw driver. The replacement fuse must be of same value and type.

4.2.2 Firmware update



Firmware updates should only be installed when they can eliminate existing bugs in the firmware in the device or contain new features.

The firmware of the control panel (HMI), of the communication unit (KE) and the digital controller (DR), if necessary, is updated via the rear side USB port. For this the software "EA Power Control" is needed which is included with the device or available as download from our website together with the firmware update, or upon request.

However, be advised not to install updates promptly. Every update includes the risk of an inoperable device or system. We recommend to install updates only if...

- an imminent problem with your device can directly be solved, especially if we suggested to install an update during a support case
- a new feature has been added which you definitely want to use. In this case, the full responsibility is transferred to you.

Following also applies in connection with firmware updates:

- Simple changes in firmwares can have crucial effects on the application the devices are use in. We thus recommend to study the list of changes in the firmware history very thoroughly.
- Newly implemented features may require an updated documentation (user manual and/or programming guide, as well as LabView VIs), which is often delivered only later, sometimes significantly later

4.3 Calibration (readjustment)

4.3.1 Preface

The devices of series PS 9000 feature a function to re-adjust the most important DC output related values, which can help in case these values are out of tolerance. The procedure is limited to compensate small differences of up to 1% or 2% of the ratings. There are several reasons which could make it necessary to readjust a unit: component aging, component deterioration, extreme ambient conditions, high frequent use.

In order to determine if a value is out of tolerance, the parameter must be verified first with measurement tools of high accuracy and with at least half the error of the PS device. Only then a comparison between values displayed on the PS device and true DC output values is possible.

For example, if you want to verify and possibly readjust the output current of model PS 9080-120 2U which has 120 A maximum current, stated with a max. error of 0.2%, you can only do that by using a high current shunt with max. 0.1% error or less. Also, when measuring such high currents, it is recommended to keep the process short, in order to avoid the shunt heating up too much. It is furthermore recommended to use a shunt with at least 25% reserve.

When measuring the current with a shunt, the measurement error of the multimeter on the shunt adds to the error of the shunt and the sum of both must not exceed the max. error of the device under calibration.

4.3.2 Preparation

For a successful calibration and readjustment, a few tools and certain ambient conditions are required:

- A measurement device (multimeter) for voltage, with a max. error of half the PS's voltage error. That measurement device can also be used to measure the shunt voltage when readjusting the current
- If the current is also going to be calibrated: a suitable DC current shunt, ideally specified for at least 1.25 times the max. output current of the PS and with a max. error that is half or less than the max. current error of the PS device
- Normal ambient temperature of approx. 20-25 °C (68-77 °F)
- Warmed up PS unit, which has been run for at least 10 minutes under 50% power
- An adjustable load, such as an electronic load, which is capable of consuming at least 102% of the max. voltage and current of the PS device

Before you can start calibrating, a few measures have to be taken:

- Let the PS device warm up in connection with the voltage / current source
- In case the remote sensing input is going to be calibrated, prepare a cable for the remote sensing connector to DC output, but leave it yet unconnected
- Abort any form of remote control, deactivate master-slave mode, set device to **U/I** mode
- Install the shunt between PS device and load and make sure the shunt is cooled somehow
- Connect external measurement device to the DC output or to the shunt, depending on whether the voltage is going to be calibrated first or the current

4.3.3 Calibration procedure

After the preparation, the device is ready to be calibrated. From now on, a certain sequence of parameter calibration is important. Generally, you don't need to calibrate all three parameters, but it is recommended to do so.

Important:



When calibrating the output voltage, the remote input "Sense" on the rear of the device has to be disconnected.

The calibration procedure, as explained below, is an example with model PS 9080-120 2U. Other models are treated the same way, with values according to the particular PS model and the required load.

4.3.3.1 Calibrating the set values

► How to calibrate the voltage

1. Connect a multimeter to the DC output. Connect a load and set it to approx. 5% of the nominal current of the power supply as load current, in this example let's use 5 A.
2. In the display enter the setup menu with **Menu**, then push button **Enter**. In the sub menu navigate to "**Calibrate Device**".
3. In the next screen select "**Voltage calibration**" + **Enter**, then "**Calibrate output value**" + 2x **Enter**. The power supply will switch the DC output on, set a certain output voltage and start to measure it (**U-mon**).
4. The next screen requests you to enter the measured output voltage from the multimeter at **Measured data=**. Enter it using the right-hand rotary knob, just like would adjust a set value. Assure yourself the value is correct and submit with **Enter**.
5. Repeat point 4. for the next three steps (total of four steps).



► How to calibrate the current

1. Set the load to approx. 102% nominal current of the PS device, for the sample model with 120 A this would be 122.4 A, rounded to 123 A.
2. In the display enter the setup menu with **Menu**, then push button **Enter**. In the sub menu navigate to "**Calibrate Device**". Push **Enter** again.
3. In the next screen select "**Current calibration**" + **Enter**, then "**Calibrate output value**" + 2x **Enter**. The device will switch on the DC output, set a certain current limit while loaded by the load or sink and start to measure the output current (**I-mon**).
4. The next screen requests you to enter the output current **Measured data=** measured with the shunt. Enter it using the right-hand rotary knob, just like would adjust a set value. Assure yourself the value is correct and submit with **Enter**.
5. Repeat point 4. for the next three steps (total of four steps).

4.3.3.2 Calibrating the remote sensing

In case you are generally using the remote sensing feature, no matter if in sink or source mode, it is recommended to also calibrate it for best results. The procedure is identical to the calibration of voltage, except for it requires to have the sensing connector (Sense) on the rear to be plugged and connected with correct polarity to the DC output of the PS.

► How to calibrate the DC output voltage for remote sensing

1. Connect a load and set it to approx. 3% of the nominal current of the power supply as load current, in this example let's set 4 A. Connect the remote sensing input (Sense) to the load with correct polarity.
2. Connect an external multimeter to the DC terminal of the load.
3. In the display enter the setup menu with **Menu**, then push button **Enter**. In the sub menu navigate to "**Calibrate Device**". Push **Enter** again.
4. In the next screen select "**Sense volt. calibration**" + **Enter**, then "**Calibrate output value**" + 2x **Enter**.
5. The next screen requests you to enter the measured sensing voltage at **Measured data=**. Enter it using the right-hand rotary knob, just like would adjust a set value. Assure yourself the value is correct and submit with **Enter**.
6. Repeat point 5. for the next three steps (total of four steps).

4.3.3.3 Actual values

Actual values of output voltage (with and without remote sensing) and output current are calibrated almost the same way as the set values, but here you don't need to enter anything, just confirm the displayed values. Please proceed the above steps and instead of "Calibrate output value" select "Calibrate actual value" in the submenus. After the device shows measured values on display, wait at 2 s for measured value to settle and then simply confirm with , until you are through all steps.

4.3.3.4 Saving calibration data

After calibration you may furthermore enter the current date. To do so, navigate to menu item "Set calibration date" and enter the date in format YYYY / MM / DD and submit with .

Last but not least save the calibration data permanently confirming menu item "Save and exit" with .



Leaving the calibration selection menu without saving via "Save and exit" will discard calibration data and the procedure would have to be repeated!

5. Contact and support

5.1 Repairs

Repairs, if not otherwise arranged between supplier and customer, will be carried out by the manufacturer. For this the device usually are returned to the manufacturer. No RMA number is needed. It is sufficient to package the equipment adequately and send it, together with a detailed description of the fault and, if still under guarantee, a copy of the invoice, to the below address.

5.2 Contact options

Questions or problems with operation of the device, use of optional components, with the documentation or software, can be addressed to technical support either by telephone or e-Mail.

Address	e-Mail	Telephone
EA Elektro-Automatik GmbH Helmholtzstr. 31-37 41747 Viersen Germany	Technical support: support@elektroautomatik.com All other topics: ea1974@elektroautomatik.com	Switchboard: +49 2162 / 37850 Support: +49 2162 / 378566



Elektro-Automatik

EA Elektro-Automatik GmbH & Co. KG
Development - Production - Sales

Helmholtzstraße 31-37
41747 Viersen
Germany

Fon: 02162 / 37 85-0
Mail: ea1974@elektroautomatik.de
Web: www.elektroautomatik.com