

### Internal Threaded Heater Hot Air Tools and Stations

Part No.	Description
971HA	SMT Hot Air Station
1036	Self-Contained SMT Hot Air Station (with FAO69 Hot Air Tool)

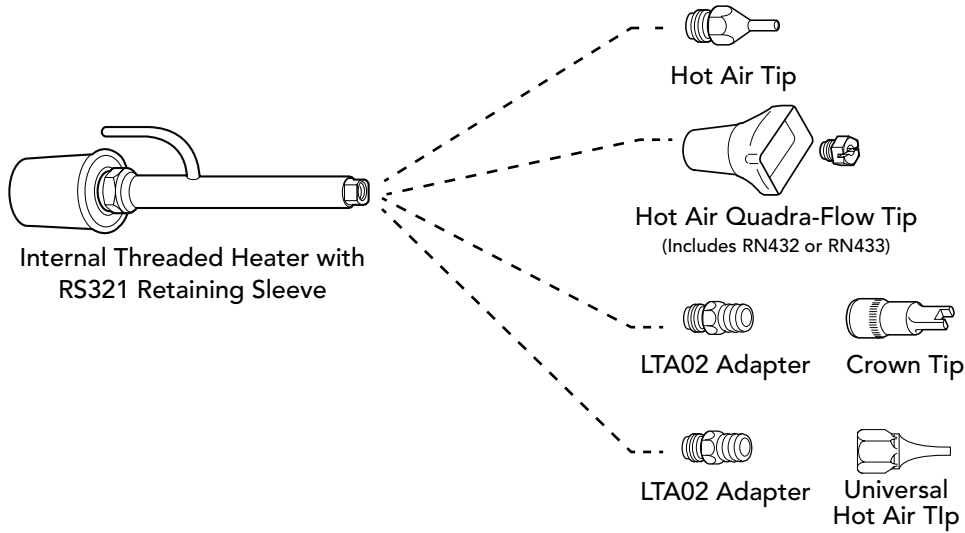

### Internal Threaded Heater Hot Air Tools and Stations

Part No.	Description
1036DX	Self-Contained SMT Deluxe Hot Air Station

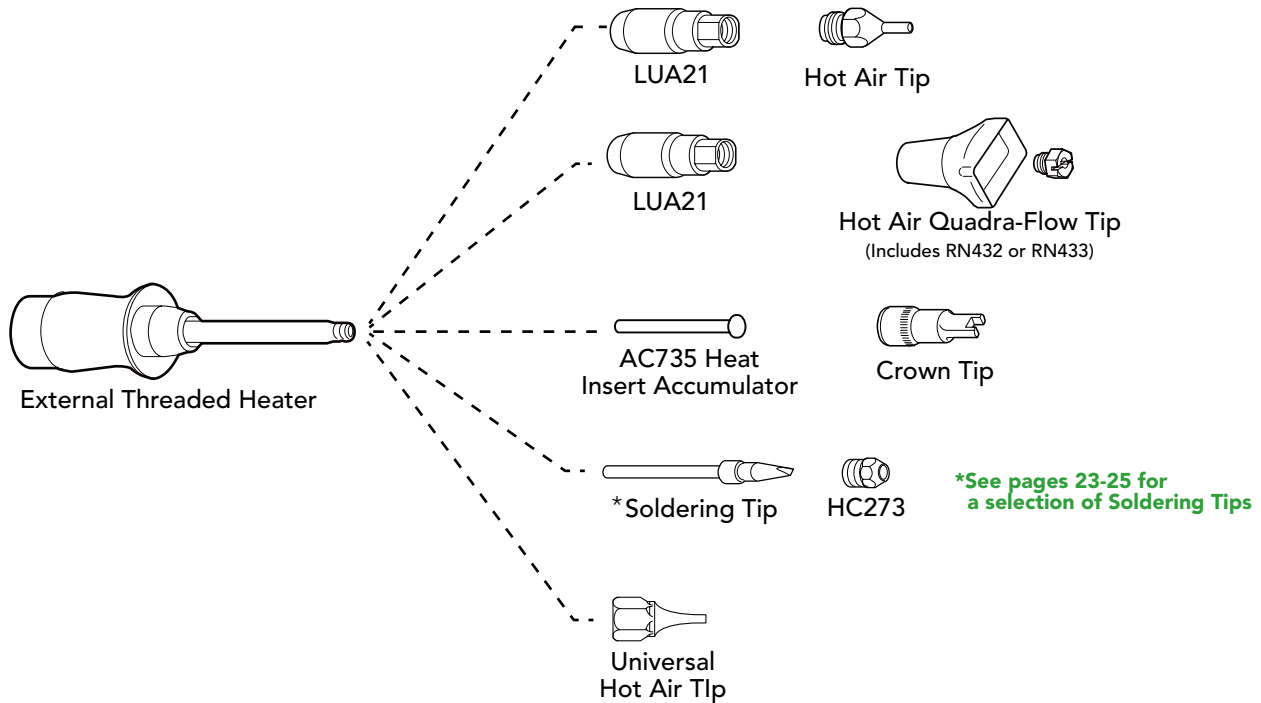



Single Nozzle Tips

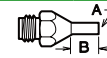

Part No.	Tip Image	Hole Dia. A	Length B
LT427		.02" (0.5mm)	.38" (95mm)
LT428		.06" (1.5mm)	.25" (6.4mm)
LT432		.04" (1.0mm)	.06" (1.5mm)
LT514		.10" (2.5mm)	.25" (6.4mm)

Fan Tips

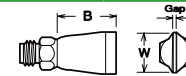

Part No.	Tip Image	Gap	Width W	Length B
LT426		.02" (0.5mm)	.30" (7.6mm)	.17" (4.3mm)
LT434		.02" (0.5mm)	.46" (11.7mm)	.23" (5.8mm)
LT435		.02" (0.5mm)	.59" (15.0mm)	.35" (8.9mm)
LT436		.02" (0.5mm)	.65" (16.5mm)	.43" (10.9mm)

Dual Flow Tips

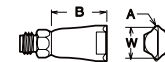

Part No.	Tip Image	Hole Dia. A	Width W	Length B
LT526		.03" (0.8mm)	.12" (3.0mm)	.30" (7.6mm)
LT534		.05" (1.3mm)	.20" (5.1mm)	.46" (11.7mm)
LT535		.05" (1.3mm)	.28" (7.1mm)	.59" (15.0mm)
LT536		.05" (1.3mm)	.35" (8.9mm)	.65" (16.5mm)
LT537		.05" (1.3mm)	.44" (11.2mm)	.80" (20.4mm)





Curl/Bent Tips

Part No.	Tip Image	Hole Dia.	Nozzle Length
LT510		.02" (0.5mm)	.65" (16.5mm)
LT511		.06" (1.5mm)	.65" (16.5mm)
LT512		.07" (1.8mm)	.90" (22.9mm)
LT513		.10" (2.5mm)	.90" (22.9mm)
LT571		.04" (1.0mm)	1.10" (27.9mm)
LT572		.04" (1.0mm)	MAX. GAP WIDTH 1.25" (31.8mm)

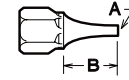





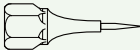
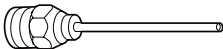
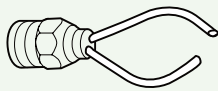

Universal Hot Air Tips

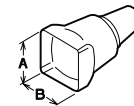

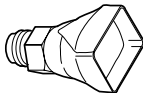
Part No.	Tip Image	Hole Dia A	Length B
LU25		.03" (6.4mm)	.25" (6.4mm)
LU26		.04" (6.4mm)	.25" (6.4mm)
LU27		.06" (6.4mm)	.25" (6.4mm)
LU28		.09" (6.4mm)	.25" (6.4mm)
LU29		.05" (7.5mm)	.29" (7.5mm)
LU30		.05" (17.8mm)	.70" (17.8mm)
LU571		.04" (27.9mm)	1.10" (27.9mm)
LU572		.04" (1.0mm)	MAX. GAP WIDTH 1.25" (31.8mm)

SMD Quadra Flow Hot Air Tips



Part No.	Package	Tip Image	Width A	Length B
LT447	SO-8		.16" (4.0mm)	.20" (5.1mm)
LT448	SO-14		.21" (5.3mm)	.35" (8.9mm)
LT449	SO-16		.26" (6.6mm)	.41" (10.4mm)
LT450	SO-16L		.42" (10.7mm)	.43" (10.9mm)
LT451	SO-18L		.44" (11.2mm)	.48" (12.2mm)
LT452	SO-20L		.38" (9.5mm)	.52" (13.2mm)
LT454	SO-28L		.43" (10.9mm)	.73" (18.6mm)
LT455	PLCC-20		.40" (10.2mm)	.40" (10.2mm)
LT456	PLCC-28		.50" (12.7mm)	.50" (12.7mm)
LT458	PLCC-44 LCCC-44		.70" (17.8mm)	.70" (17.8mm)