



205 Westwood Ave, Long Branch, NJ 07740
Phone: 866-94 BOARDS (26273) / (732)-222-1511
Fax: (732)-222-7088 | E-mail: sales@touchboards.com

L-12 / TT-12

Document Camera

INSTRUCTION MANUAL

Please read this instruction manual carefully before using this product and keep it for future reference.

BUNDLED
ITEMS

BASIC
OPERATIONS

ADVANCED
OPERATIONS

TROUBLE
SHOOTING

SPECIFICA-
TIONS



IMPORTANT SAFEGUARDS

■ Read Instructions

All the safety and operating instructions should be read before the appliance is operated.

■ Retain Instructions

The safety and operating instructions should be retained for future reference.

■ Heed Warnings

All warnings on the product and in the operating instructions should be adhered to.

■ Follow Instructions

All operating and use instructions should be followed.

■ Cleaning

Unplug this product from the wall outlet before cleaning. Do not use liquid cleaners or aerosol cleaners. Use a damp cloth for cleaning.

■ Attachments

Do not use attachments not recommended by the product manufacturer as they may cause hazards.

■ Water and Moisture

Do not use this product near water - for example, near a bath tub, wash bowl, kitchen sink, or laundry tub, in a wet basement, or near a swimming pool, and the like.

■ Placement

Do not place this product on an unstable cart, stand, tripod, bracket, or table. The product may fall, causing serious injury to a child or adult, and serious damage to the product. Use only with a cart, stand, tripod, bracket, or table recommended by the manufacturer, or sold with the product. Any mounting of the product should follow the manufacturer's instructions, and should use a mounting accessory recommended by the manufacturer.

■ Ventilation

Slots and openings in the cabinet are provided for ventilation and to ensure reliable operation of the product and to protect it from overheating, and these openings must not be blocked or covered. The openings should never be blocked by placing the product on a bed, sofa, rug, or other similar surface. This product should not be placed in a built-in installation such as a bookcase or rack unless proper ventilation is provided or the manufacturer's instructions have been adhered to.

■ Power Sources

This product should be operated only from the type of power source indicated on the marking label. If you are not sure of the type of power supply to your home consult your appliance dealer or local power company. For products intended to operate from battery power, or other sources, refer to the operating instructions.

■ Grounding or Polarization

This product may be equipped with either a polarized 2-wire AC line plug (a plug having one blade wider than the other) or a 3-wire grounding type plug, a plug having a third (grounding) pin. The 2-wire polarized plug will outlet, try reversing the plug. If the plug still fails to fit, contact your electrician to replace your obsolete outlet. Do not defeat the safety purpose of the polarized plug. The 3-wire grounding type plug will fit into a grounding type power outlet. This is a safety feature. If you are unable to insert the plug into the outlet, contact your electrician to replace your obsolete outlet. Do not defeat the safety purpose of the grounding type plug.

■ Power-Cord Protection

Power-supply cords should be routed so that they are not likely to be walked on or pinched by items placed upon or against them, paying particular attention to cords at plugs, convenience receptacles, and the point where they exit from the product.

■ Lightning

For added protection for this product during a lightning storm, or when it is left unattended and unused for long periods of time, unplug it from the wall outlet and disconnect the antenna or cable system. This will prevent damage to the product due to lightning and power-line surges.

■ Overloading

Do not overload wall outlets, extension cords, or integral convenience receptacles as this can result in a risk of fire or electric shock.

- A product and cart combination should be moved with care. Quick stops, excessive force, and uneven surfaces may cause the product and cart combination to overturn.**

**■ Object and Liquid Entry**

Never push objects of any kind into this product through openings as they may touch dangerous voltage points or short-out parts that could result in a fire or electric shock. Never spill liquid of any kind on the product.

■ Servicing

Do not attempt to service this product yourself as opening or removing covers may expose you to dangerous voltage or other hazards. Refer all servicing to qualified service personnel.

■ Damage Requiring Service

Unplug this product from the wall outlet and refer servicing to qualified service personnel under the following conditions:

- When the power-supply cord or plug is damaged.
- If liquid has been spilled, or objects have fallen into the product.
- If the product has been exposed to rain or water.
- If the product does not operate normally by following the operating instructions. Adjust only those controls that are covered by the operating instructions as an improper adjustment of other controls may result in damage and will often require extensive work by a qualified technician to restore the product to its normal operation.
- If the product has been dropped or damaged in any way.
- When the product exhibits a distinct change in performance - this indicates a need for service.

■ Replacement Parts

When replacement parts are required, be sure the service technician has used replacement parts specified by the manufacturer or have the same characteristics as the original part. Unauthorized substitutions may result in fire, electric shock or other hazards.

■ Safety Check

Upon completion of any service or repairs to this product, ask the service technician to perform safety checks to determine that the product is in proper operating condition.

■ Heat

The product should be situated away from heat sources such as radiators, heat registers, stoves, or other products (including amplifiers) that produce heat.

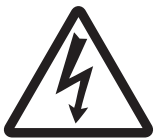
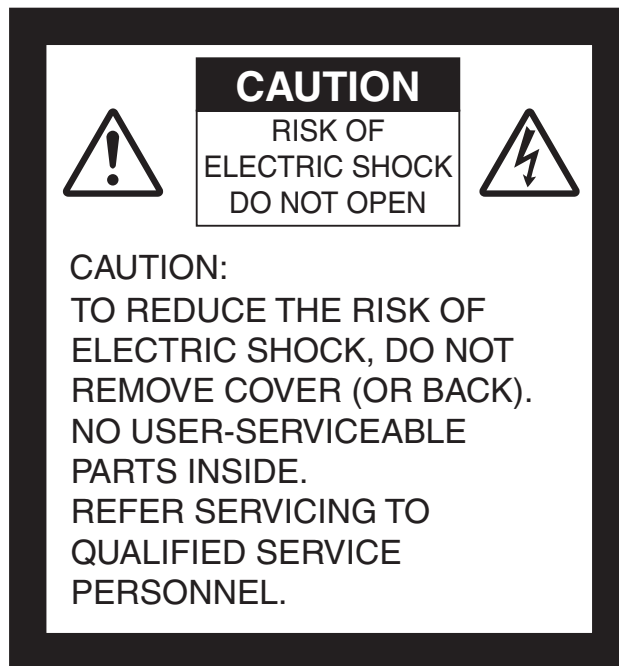

SA 1965

The lightning flash with arrowhead symbol, within an equilateral triangle, is intended to alert the user to the presence of uninsulated “dangerous voltage” within the product’s enclosure that may be of sufficient magnitude to constitute a risk of electric shock to persons.



SA 1966

The exclamation point within an equilateral triangle is intended to alert the user to the presence of important operating and maintenance (servicing) instructions in the literature accompanying the product.



This symbol [crossed-out wheeled bin WEEE Annex IV] indicates separate collection of waste electrical and electronic equipment in the EU countries. Please do not throw the equipment into the domestic refuse. Please use the return and collection systems available in your country for the disposal of this product.



This symbol [crossed-out wheeled bin Directive 2006/66/EC Annex II] indicates separate collection of waste batteries in the EU countries. Please do not throw the batteries into the domestic refuse. Please use the return and collection systems available in your country for the disposal of the waste batteries.

WARNING:**TO REDUCE THE RISK OF FIRE OR ELECTRIC SHOCK, DO NOT EXPOSE THIS PRODUCT TO RAIN OR MOISTURE.**

The connection of a non-shielded equipment interface cable to this equipment will invalidate the FCC Certification or Declaration of this device and may cause interference levels which exceed the limits established by the FCC for this equipment. It is the responsibility of the user to obtain and use a shielded equipment interface cable with this device. If this equipment has more than one interface connector, do not leave cables connected to unused interfaces. Changes or modifications not expressly approved by the manufacturer could void the user's authority to operate the equipment.

**FOR UNITED STATES USERS:
INFORMATION**

This equipment has been tested and found to comply with the limits for a Class A digital device, pursuant to part 15 of the FCC Rules. These limits are designed to provide reasonable protection against harmful interference when the equipment is operated in a commercial environment. This equipment generates, uses, and can radiate radio frequency energy and, if not installed and used in accordance with the instruction manual, may cause harmful interference to radio communications. Operation of this equipment in a residential area is likely to cause harmful interference in which case the user will be required to correct the interference at his own expense.

This device complies with part 15 of the FCC Rules. Operation is subject to the following two conditions: (1) This device may not cause harmful interference, and (2) this device must accept any interference received, including interference that may cause undesired operation.

FCC CAUTION

Changes or modifications not expressly approved by the party responsible for compliance could void the user's authority to operate the equipment.

This Class A digital apparatus complies with Canadian ICES-003.

Cet appareil numérique de la classe A est conforme à la norme NMB-003 du Canada.

THIS IS A CLASS A PRODUCT. IN A DOMESTIC ENVIRONMENT THIS PRODUCT MAY CAUSE RADIO INTERFERENCE IN WHICH CASE THE USER MAY BE REQUIRED TO TAKE ADEQUATE MEASURES.**WARNING:**

Handling the cord on this product or cords associated with accessories sold with this product, will expose you to lead, a chemical known to the State of California to cause birth defects or other reproductive harm.

Wash hands after handling.

CR Coin Lithium Battery contains Perchlorate Material – special handling may apply.
See www.dtsc.ca.gov/hazardouswaste/perchlorate

BEFORE YOU USE

- When using this device, be sure to use the supplied power cord and AC adapter.
- The power cord and AC adapter that come with this product are for this product only. Do not use them with another product.
- Be sure to use the power cord applicable to your local power specifications.
- When storing the product, do not leave it under direct sunlight or by heaters. It may become discolored, deformed, or damaged.
- Do not place this product in any humid, dusty, salt bearing wind, or vibrating locations.
Only use it under the following environmental conditions:
Temperature: 0°C - 40°C (32°F - 104°F)
Humidity: 30% - 85% (No condensation)
- Use a soft, dry cloth for cleaning.
Do not use any volatile solvent such as thinner or benzene.
- Do not point the camera lens directly at the sun. It may be damaged and you may not be able to take pictures.
- Luminescent and Black Spots
There may be some pixels that do not properly operate due to the use of CMOS Area Image Sensors made-up of many pixels.
Though luminescent or black spots may be found on the screen, it is a phenomenon peculiar to the CMOS Area Image Sensors and is not a malfunction.
- Follow the guidelines below to prevent the unit from dropping or overturning.
 - Use the product on a stable base, desk, or table. Do not place the product on an unstable base or slanted surface.
 - Place or wire the unit to prevent the AC adapter cord or video cable from pulling.
- Carry the product by holding the lower part of the main unit in both hands. Never hold the product by the column or the camera head.
- Pay careful attention when using (including setting-up and storing) or transferring the product to prevent the camera head from receiving any shocks.
- Do not look directly into the LED light. If you look directly into it at point-blank range, your eyes may be injured.
- Some type of SD card/USB flash drive can be used.
- Transfer the data from the SD card onto a device such as a PC to save a backup copy. Malfunction of the product or repairs to it may cause the data saved in the SD card to be deleted.
- If this product is used for longer than the warranty period, its performance and quality may deteriorate due to the lifetime of its parts. To purchase replacement parts, consult the dealer from whom you purchased this product or our branch/office near your location.
- Battery precautions:
 - If this product is not going to be used for an extended time, remove the batteries from the remote.
 - Do not use rechargeable batteries.
 - Do not try to recharge or short-circuit the batteries.
 - When disposing of used batteries, follow the instructions of your local government.
 - Insert from one side and pay particular attention to the polarity (+/- directions).
 - Be sure to use CR2025 batteries.

■ If any liquid from a battery leaks onto your skin or clothes, flush the area with clean water immediately. If it gets into your eye, flush immediately with clean water and then contact a doctor.

■ Do not keep the batteries in the reach of children because there may be a choking hazard.

If a battery is swallowed, consult a physician immediately as this could result in asphyxiation or the battery may become lodged in the stomach or esophagus.

■ About using microphones

Connecting microphones other than electret condenser microphones (microphones for PCs and so on) could cause a malfunction to occur. If you are concerned about this product's operating noise when using the built-in microphone, we recommend using an external microphone.

■ About the audio input port

Do not connect any audio line-output devices such as a CD/MP3 player to the audio input port when the Audio Selector is set to "Mic-in." Audio input is a dual purpose port (microphone/line-in) which supplies power when "Mic-in" is selected, adding external output devices (CD/MP3) may damage them.

■ Menu

Some functions may not be set or operated depending on the mode or the menu settings being used.

■ Record/Play

- Before recording an important scene, make sure to do a test recording to confirm that the camera is working properly.
- The maximum file size of the continuous recording is 2GB. (The maximum recording length varies depending on other factors such as resolution and recording quality.)
- Movie files that are recorded with this camera or converted by the proprietary software can only be played with this camera.

■ Copyright

Do not commercially use or transfer movies or audio files recorded with the camera without the permission of the copyright holder except for personal use.

Do not use the camera in locations where recording movies or audio files are prohibited.



CONTENTS

IMPORTANT SAFEGUARDS	i
BEFORE YOU USE	vi
Contents	2
1. BUNDLED ITEMS	4
2. BASIC OPERATIONS	5
2-1 Document Camera.....	5
Part Names	5
Operating panel.....	6
Rear panel and cable connection	7
Side panel.....	10
Moving Parts of the Document Camera.....	11
2-2 Supplied Accessories.....	12
Remote Control	12
Preparation of Remote Control.....	12
Operation of the remote control	12
Receiving signal from the remote control	13
Bundled software/Instruction manual CD-ROM.....	13
2-3 Shooting Images.....	14
Setting up the main unit.....	14
Connecting the AC cord	14
Connecting the video cable.....	15
Turning the power ON/OFF.....	15
Adjusting the size	16
Adjusting the brightness.....	17
Automatic brightness adjustment	17
Manual brightness adjustment.....	18
Turning the illumination ON/OFF.....	19
Image selection	20
Pausing the image	20
2-4 Setting Changes	21
Changing a Setting.....	21
List of the Menus.....	21
Descriptions of Each Menu.....	22
Main Unit.....	22
Camera Controls [Second Layer]	22
Preferences [Second Layer].....	24
Support Function.....	25
Support Function Setting	26
Details of Each Function.....	28
Highlight Function.....	28
Mask Function.....	30
Scroll Function	31
Compare Picture Function	32
Picture in Picture Function	33
Mosaic Function.....	35

Marker Mask Function.....	36
3. ADVANCED OPERATIONS	37
3-1 Using an SD card/USB flash drive.....	37
Saving images	38
Picture.....	38
Movie.....	39
Displaying the stored data.....	41
Thumbnail display (list of pictures/movies).....	41
Displaying a picture full-screen	45
Playing a movie full-screen	50
3-2 Saving data stored on an SD card to PC via USB cable	53
3-3 Using this device by connecting to a PC with an USB cable.....	55
3-4 Using this device with a wireless pen tablet or a portable IWB (both sold separately)	57
Connection with the wireless pen tablet.....	57
Basic operations of the pen tablet.....	58
Selecting how to use the pen tablet from the tablet menu	60
Connection with the portable IWB	61
Basic operations of the portable IWB.....	62
Using the pen tablet or portable IWB to draw on the camera image	65
Menu descriptions	65
Using the pen tablet or portable IWB as a whiteboard	70
Menu descriptions	70
Using the pen tablet or portable IWB and an SD card.....	73
Menu descriptions	74
3-5 Displaying enlarged images using a microscope	80
Procedure	80
Exiting the Microscope mode	82
4. TROUBLE SHOOTING.....	83
4-1 Symptoms and Confirmation	83
5. SPECIFICATIONS.....	86
5-1 General	86
5-2 Main Camera	87
5-3 Illumination Device.....	88
5-4 Trademarks · License.....	89

1 BUNDLED ITEMS

The items below are included with this product. If any item is missing, contact the dealer from whom you purchased this product.

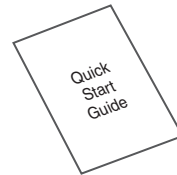
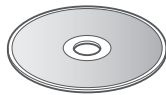
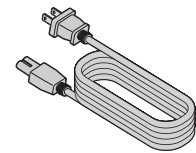
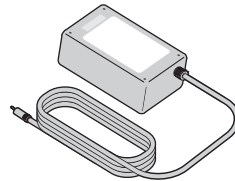
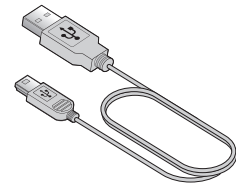
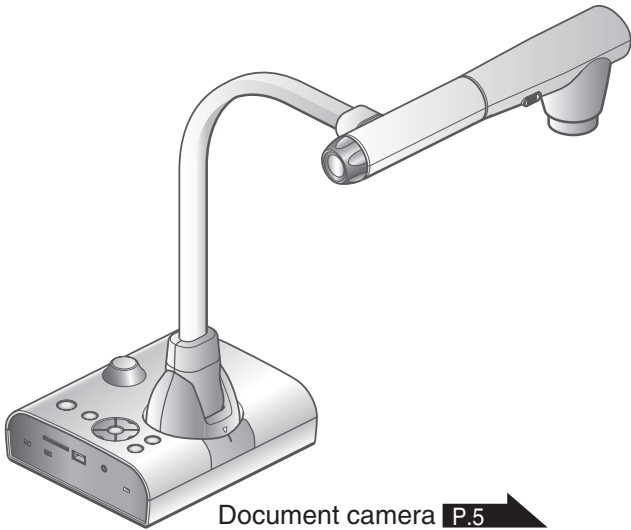

CR2025 battery P.12
(for the remote control) ※¹

Bundled software/
Instruction Manual
CD-ROM P.13

Quick Start Guide

Operation Assistance
Label ※²



Warranty ※², ※³

3S Service Registration
Form ※²

3S Service Registration
Statement ※²

3S Assurance Guarantee
Label ※²

※¹ According to overseas area
※² Japan only
※³ N. America only

2 BASIC OPERATIONS

2-1 Document Camera

Part Names

Operation of the main unit: **P.11**

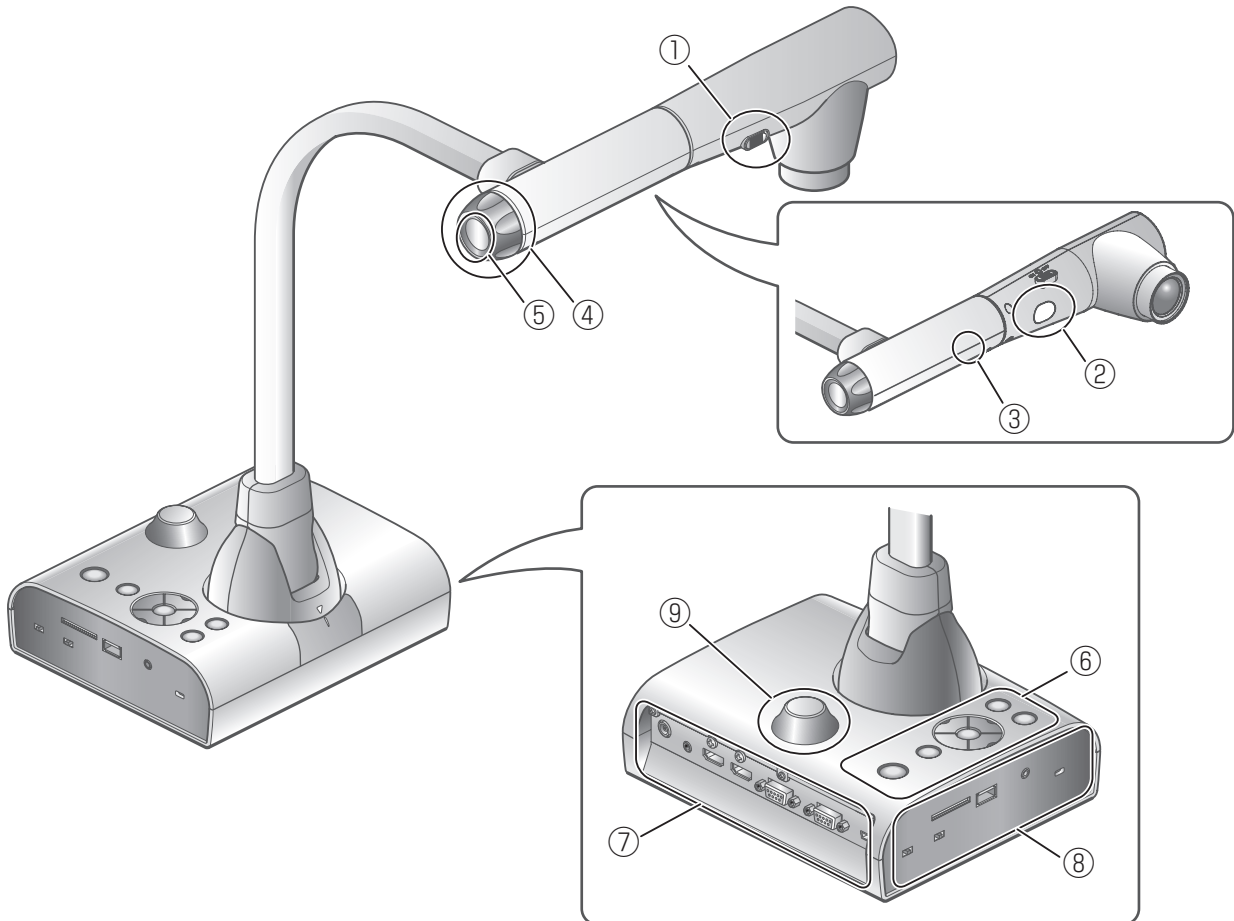







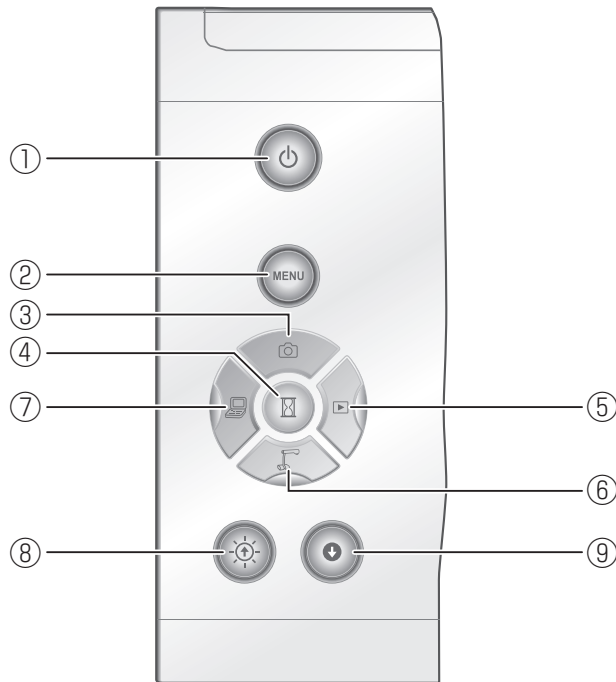



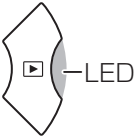

No	Name	
①	Illumination switch	P.19
②	Illumination	P.19
③	Built-in mic	
④	Zoom dial	P.16
⑤	AF button	
⑥	Operating panel	P.6
⑦	Rear panel	P.7
⑧	Side panel	P.10
⑨	Remote control sensor	P.13

Operating panel









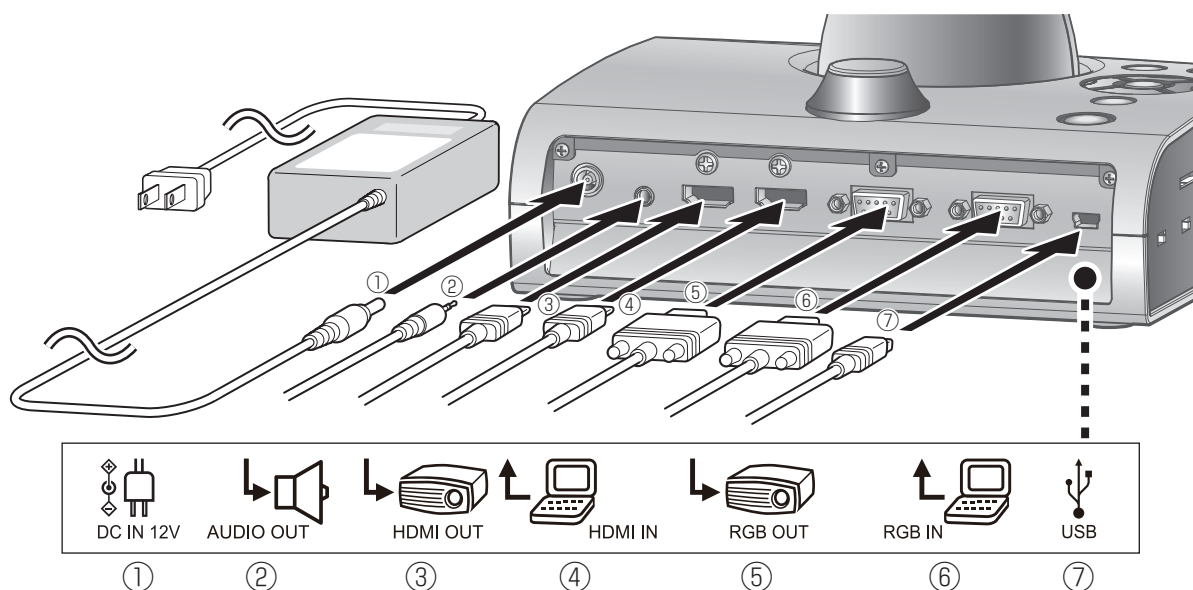



BASIC OPERATIONS



Mark		Function
①	 LED	To turn the power ON/OFF. Power ON: Blue light Power OFF (standby status): Red light <div style="border: 1px solid black; padding: 5px; margin-top: 5px;">Note • Press and hold for more than 2 seconds to turn the power OFF.</div>
②		To show/hide the menu on screen. ▶ P.21
③		To save the still image on the SD card/USB flash drive. ▶ P.38
④		To pause the camera image. Press this button again to restart.
⑤	Image select  LED	To switch the screen to images stored on the SD card/USB flash drive. The LED is lit when the [] button is selected. ▶ P.20
⑥	 LED	To switch the screen to camera image. The LED is lit when the [] button is selected. ▶ P.20
⑦	LED 	To switch the screen to the image input to RGB IN and HDMI IN. The LED is lit when the [] button is selected. ▶ P.20
⑧	Brightness Adjust 	To brighten the camera image. ▶ P.17
⑨		To darken the camera image. ▶ P.17

■ Rear panel and cable connection



	Mark	Function
①	 DC IN 12V	Plug-in for the AC adapter. (A cable is included.)
②	 AUDIO OUT	To output audio line . (AUDIO cable is not included.)
③	 HDMI OUT	To output digital images. (HDMI cable is not included.)
④	 HDMI IN	When the [] button is selected in Image Select, the image input to [] terminal can be output from the [] terminal. (HDMI cable is not included.)
⑤	 RGB OUT	To output analog RGB images. (RGB cable is not included.)
⑥	 RGB IN	When the [] button is selected in Image Select, the image input to [] terminal can be output from the [] terminal. (RGB cable is not included.)
⑦	 USB	To connect to a PC. (USB cable is included.)

① To connect the AC adapter.

Before inserting the AC adapter in an outlet, connect the DC plug of the supplied AC adapter to the [] terminal on the rear panel.

② To connect the unit to a device (speaker with amplifier etc) with an audio line input terminal.

Connect a commercially available audio cable to the [] terminal on the rear panel.

③ To connect the unit to a device with an HDMI input terminal.

Connect a commercially available HDMI cable to the [] terminal on the rear panel.

**Note**

- Please use the monitor corresponding to the input of the image (resolution) or 720p or more.
It doesn't operate with the cable that doesn't conform to the HDMI standard.
- Elmo does not guarantee operation for all HDMI-compatible monitors.

④ To connect the unit to a device with an HDMI output terminal.

Connect the HDMI cable to the [] terminal on the rear panel.

HDMI cable is not included.

⑤ To connect the unit to a device with an analog RGB input terminal.

Connect the RGB cable to the [] terminal on the rear panel.

⑥ To connect the unit to a device with an analog RGB output terminal.

Connect the RGB cable to the [] terminal on the rear panel.

■ Specifications of the [] terminal

Signal allocation

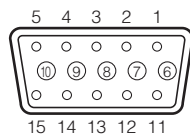

Video signal

Horizontal synchronized signal

Vertical synchronized signal

Analog 0.7V (p-p) 75Ω terminated

TTL level (Positive/negative polarity)

TTL level (Positive/negative polarity)

DSUB 15P shrink terminal (Female)

Pin assignment

Pin No.	Name	Pin No.	Name	Pin No.	Name
1	Video signal (Red)	6	GND (Red)	11	GND
2	Video signal (Green)	7	GND (Green)	12	N.C
3	Video signal (Blue)	8	GND (Blue)	13	Horizontal synchronized signal
4	N.C	9	N.C	14	Vertical synchronized signal
5	GND	10	GND	15	N.C

⑦ To connect a PC with the USB cable.

Connect the supplied USB cable to the [] terminal on the rear panel.

**Note**

- If the displayed image is off-center, adjustment of the horizontal and vertical position should be made from the connected device.
- In some cases, vertical stripes may appear on the display device. This can be reduced by adjusting the “clock phase” function of the connected device.
- When using a PC with an external output mode, set the PC to the external output mode after pressing the [] button on the operating panel.
- We recommend using a USB 2.0 compliant USB cable.
- If you plug into the USB cable with the power on, the PC may not recognize the device.
- Depending on the PC's USB environment or the peripheral equipment using the USB 2.0 compliant cable, image transfer may be disrupted.
- Operation is not guaranteed for all environments.

Side panel

Note

- Move the switch in ① according to the specification of the display device.

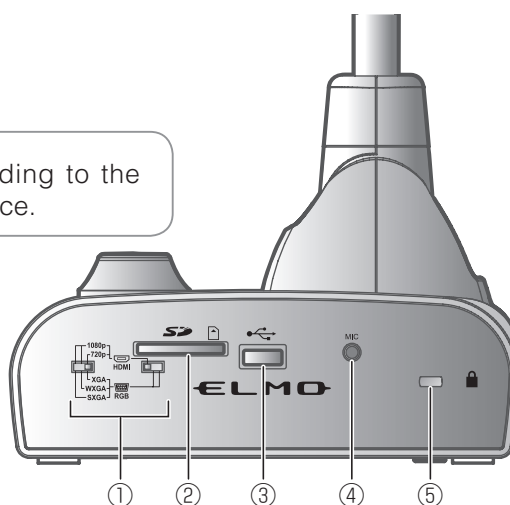

Mark	Function																					
①	<p>To switch the output image type. Left switch : To switch the output terminal. Right switch : To switch the resolution.</p> <table border="1"> <thead> <tr> <th>Resolution</th> <th>Left switch</th> <th>Right switch</th> <th>Output image</th> </tr> </thead> <tbody> <tr> <td>1080 P (1920 × 1080)</td> <td></td> <td></td> <td rowspan="2">HDMI OUT</td> </tr> <tr> <td>720P (1280 × 720)</td> <td></td> <td></td> </tr> <tr> <td>SXGA (1280 × 1024)</td> <td></td> <td></td> <td rowspan="3">RGB OUT</td> </tr> <tr> <td>WXGA (1280 × 800)</td> <td></td> <td></td> </tr> <tr> <td>XGA (1024 × 768)</td> <td></td> <td></td> </tr> </tbody> </table>	Resolution	Left switch	Right switch	Output image	1080 P (1920 × 1080)			HDMI OUT	720P (1280 × 720)			SXGA (1280 × 1024)			RGB OUT	WXGA (1280 × 800)			XGA (1024 × 768)		
Resolution	Left switch	Right switch	Output image																			
1080 P (1920 × 1080)			HDMI OUT																			
720P (1280 × 720)																						
SXGA (1280 × 1024)			RGB OUT																			
WXGA (1280 × 800)																						
XGA (1024 × 768)																						
②	<p>To insert an SD card (commercially available). Push the card again to remove the SD card.</p>																					
③	<p>To connect a wireless pen Tablet (commercially available) P.57 or a USB flash drive (commercially available) P.37.</p>																					
④	<p>MIC</p> <p>Plug-in for an mic and line input. (A mic cable is not supplied with this product.) (The mic is only for the electret capacitor mic.)</p>																					
⑤	<p>Security slot.</p>																					

Note

- When the image of the main unit is output, the same image is output to [RGB OUT] and [HDMI OUT].
- When the HDMI monitor is connected, the output image (resolution) is automatically changed based on information from the connected monitor. Even if [RGB OUT] is selected, it is not reflected.
- We recommend that you change the output image (resolution) with the power supply turned off (standby status).
In case you wish to change the output image (resolution) by looking at the output image with the power supply turned on, make sure to set the output image to camera image and hide all menus beforehand. We do not guarantee proper operation when the output image (resolution) was changed in any other condition than specified above.
- Connecting microphones other than electret condenser microphones (microphones for PCs and so on) could cause a malfunction to occur.

■ Moving Parts of the Document Camera

This unit can be moved as shown below.

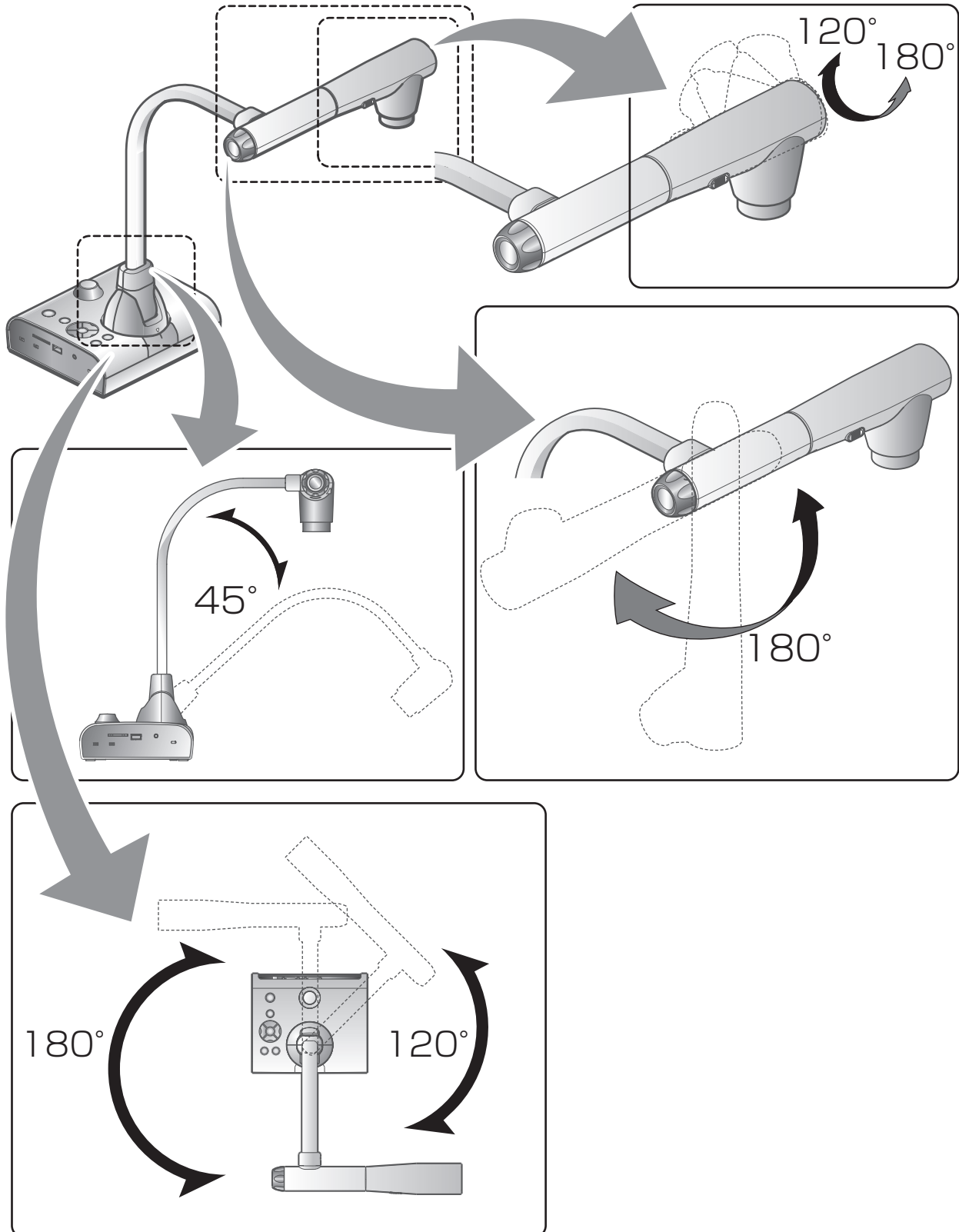

2-2 Supplied Accessories

Remote Control

Preparation of Remote Control

① While pressing the claw in the direction of the arrow, ② pull out the battery case.

Place a new button battery on the battery case with the "+" side facing up. ③ Insert the battery case to the remote control.

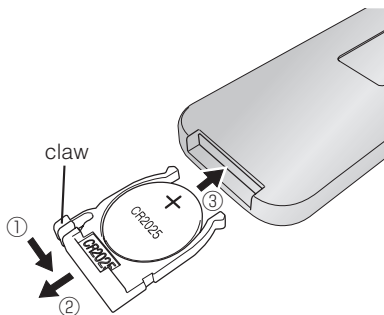

WARNING

Children may ingest small batteries; always keep batteries safe and out of reach.

If a battery is swallowed, consult a doctor immediately as this could result in asphyxiation or be an obstacle to digestion, etc.

Operation of the remote control

When a camera image is displayed

P.14

When data in an SD card/USB flash drive is displayed

P.37

Note

- Use the button battery type CR2025 for the remote control.



Receiving signal from the remote control

Point the infrared light lens of the remote control at the infrared sensor, and press the button of the desired function.

Receivable range

Distance: Within approx. 7m from the front of the infrared sensor

Angle: Within 30° up, down, left, and right of the infrared sensor



- The receivable range may be reduced when the main unit is placed in direct sunlight, near an inverter fluorescent light or in any other unfavorable conditions. Depending on the light source conditions, the sensor may fail to receive any infrared light. In such cases, relocate the main unit or shield the light source.

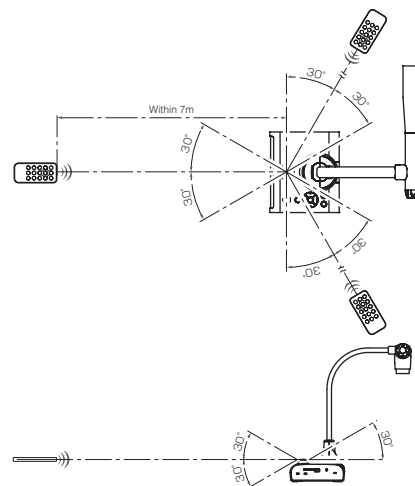

■ Bundled software/Instruction manual CD-ROM

The CD-ROM contains the software for connecting to a PC and the Instruction Manual. For software installation, follow the instructions in the bundled software's Installation Manual.

2-3 Shooting Images

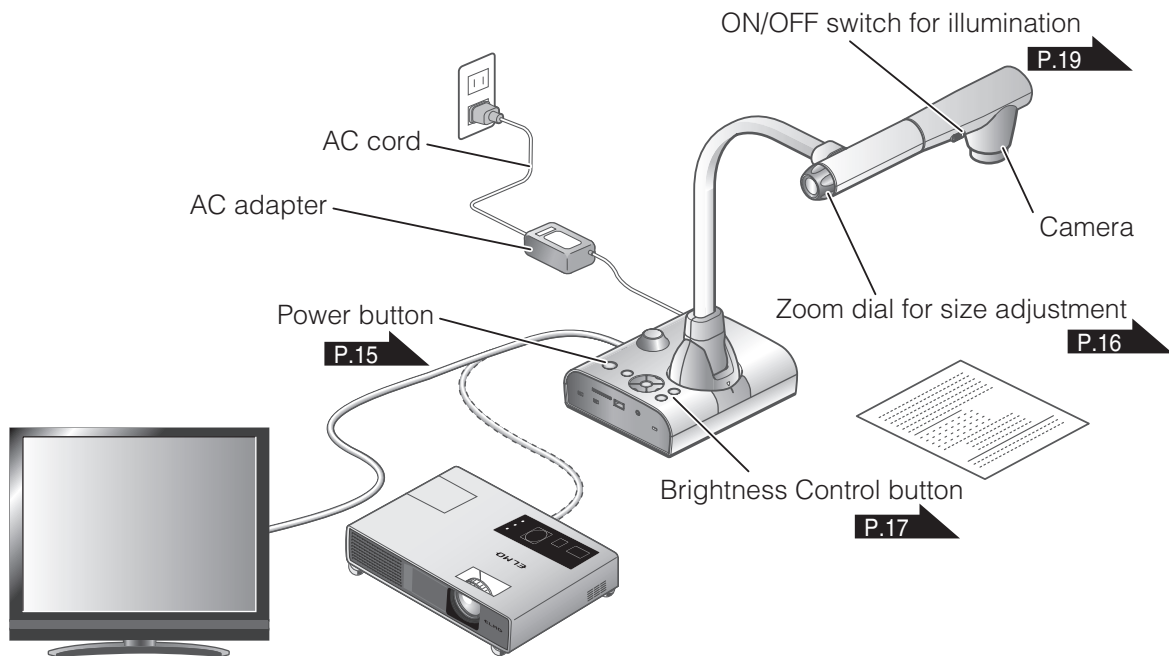

■ Setting up the main unit

Set up the main unit as shown in the figure above. Then connect the main unit to a projector or a PC monitor, and turn on the power of the main unit. P.15

Connecting the AC cord

Connect the AC cord and the AC adapter. Then connect the AC adapter to the [] terminal at the rear panel of the document camera, and insert the AC cord into an outlet.

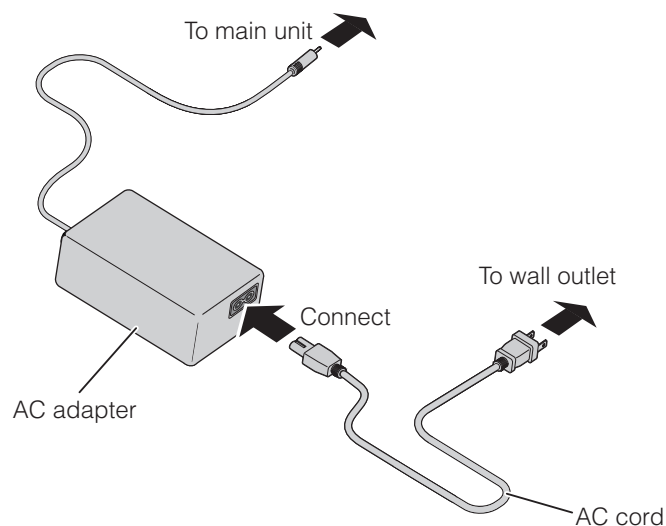

Connecting the video cable

- 1 Move the switch on the side panel according to the specification of the display device. **P.10**



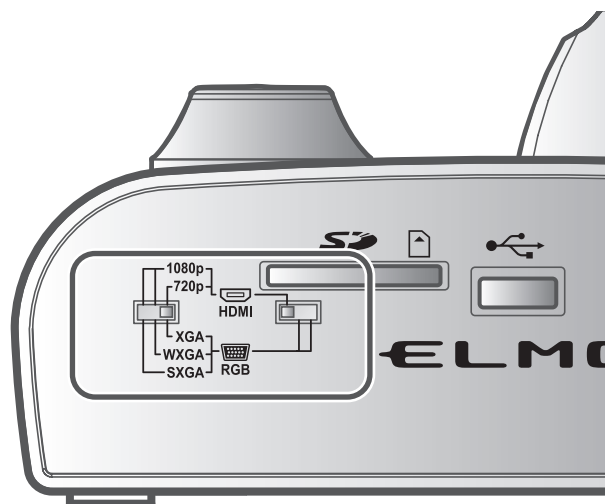



- 2 Use the cable corresponding to the switch position specified in ① to connect the document camera to the display device.



CAUTION

Before connecting the main unit to other devices, be sure to turn OFF the power for all of the devices.

Turning the power ON/OFF

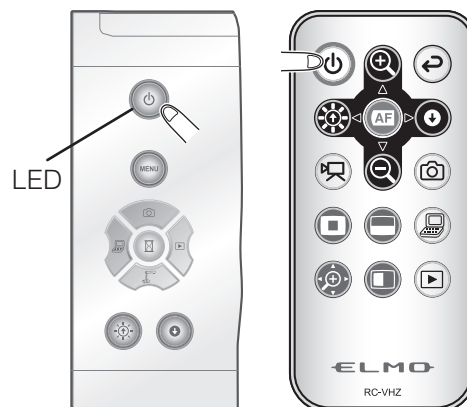

- Press the [] on the operating panel or the [] button on the remote control to turn the power ON.
(After the [] Button flashes blue, it is illuminated a few seconds later.)
- Press the [] button on the operating panel or the [] button on the remote control to turn the power OFF. You need to hold down the button for two seconds or more for the button on the operating panel.
(The LED of the [] button is illuminated in red.)





Note

- Do not operate this device while it is flashing.

■ Adjusting the size

The display range of the document can be adjusted by rotating the zoom dial on the main unit or by pressing the [ / ] buttons on the remote control.



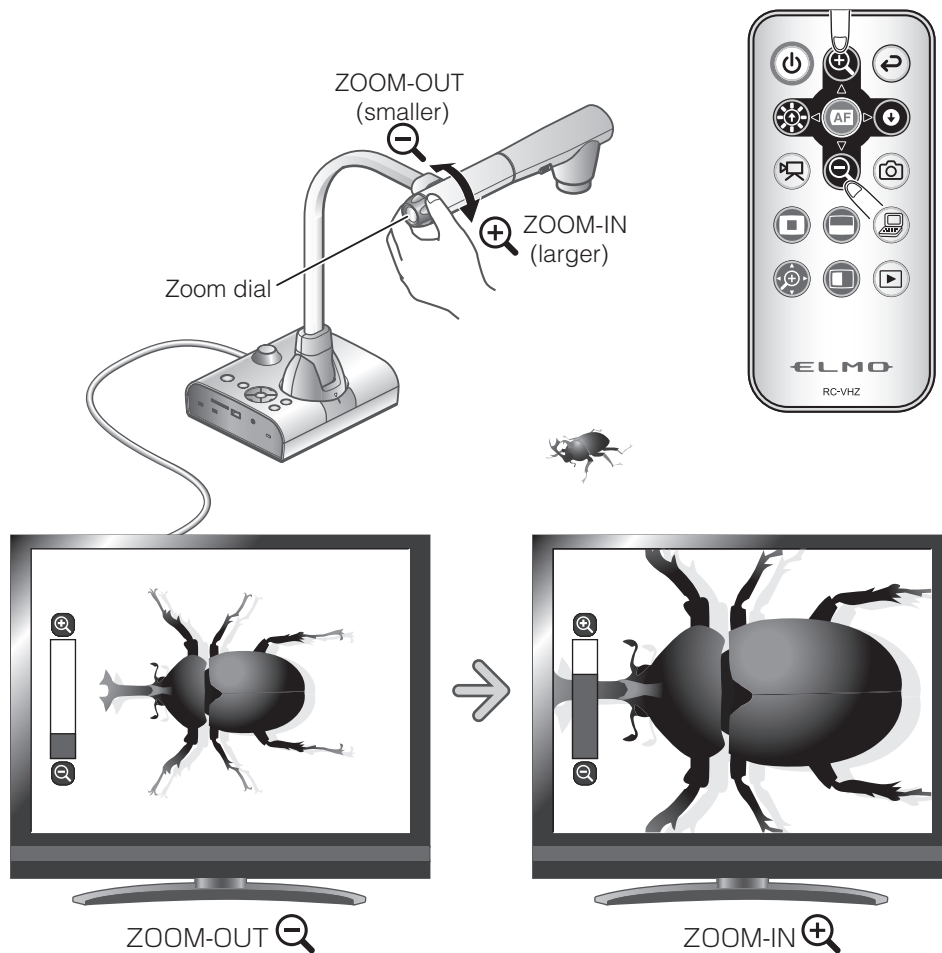

- ZOOM-IN  : The object can be shown in large size.
- ZOOM-OUT  : The object can be shown in small size.



Note

- Zoom ratio: Optical 12x, Digital 8x
- When the optical zoom reaches 12x, it automatically shifts to digital zoom.
- Within the digital zoom range, the image quality is degraded.
- ON/OFF of the digital zoom can be set from the setting menu.



■ Adjusting the brightness





Press the [ / ] button on the operating panel or the [ / ] buttons on the remote control to adjust the image brightness.

The following two adjustment modes can be set by selecting [Brightness] from the menu on the screen.



Automatic brightness adjustment

([] → [] → [] → [Auto])

To ensure a constant degree of brightness, the brightness of the image changes automatically according to the brightness of the shooting environment. Use the [ / ] button on the operating panel or the [ / ] buttons on the remote control to change the automatic brightness adjustment.

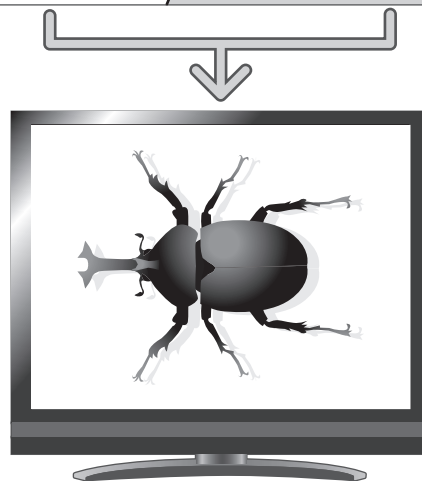
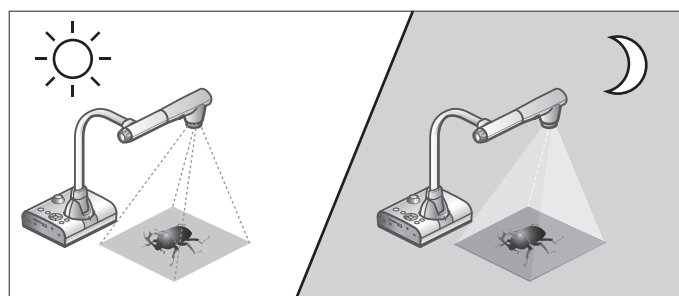
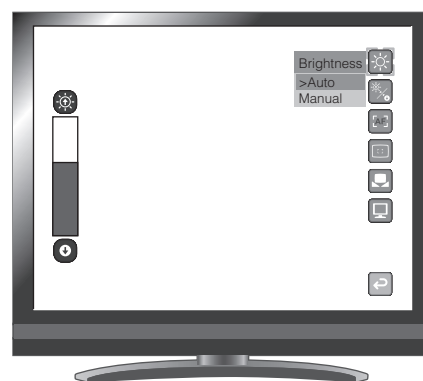

Brightness of the screen is the same

Manual brightness adjustment

([MENU] → [] → [] → [Manual])

Use the [] / [] buttons on the operating panel or the [] / [] buttons on the remote control to change the level of brightness. The brightness of the image will not change automatically in response to the brightness of the shooting environment.

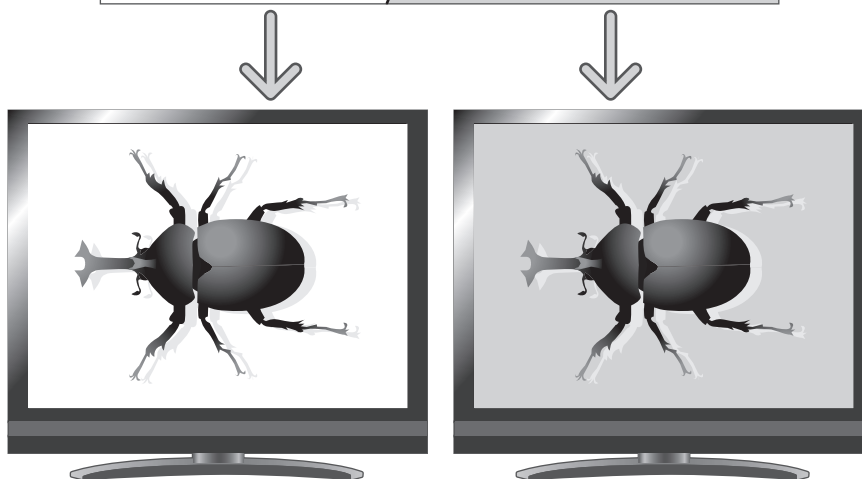
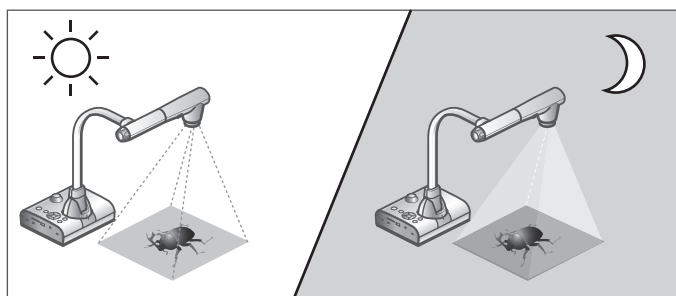
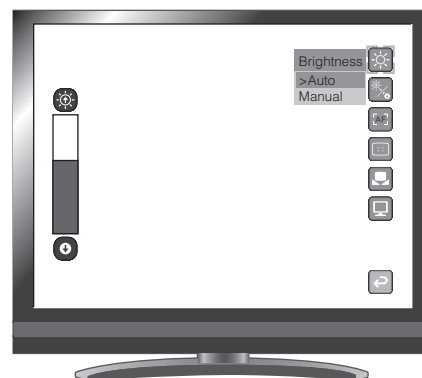

Brightness of the screen is different



Note

- Factory setting is set to [Auto].
- By setting [MENU] → [] → [On], the setting details are displayed on the screen.
- To return to the factory settings, press the [] / [] buttons on the operating panel at the same time, or select [Rst Brightness] from the menu.
- In places where the object is exposed to bright sunlight (e.g. near a window), or extremely bright lights, the brightness of the screen may not dim sufficiently, even when the [] button on the operating panel or the [] button on the remote control is pressed.
In such cases, to adjust the amount of light, close the curtains or move the object away from the light.

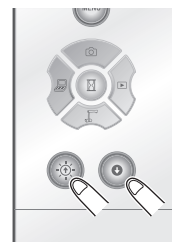

■ Turning the illumination ON/OFF

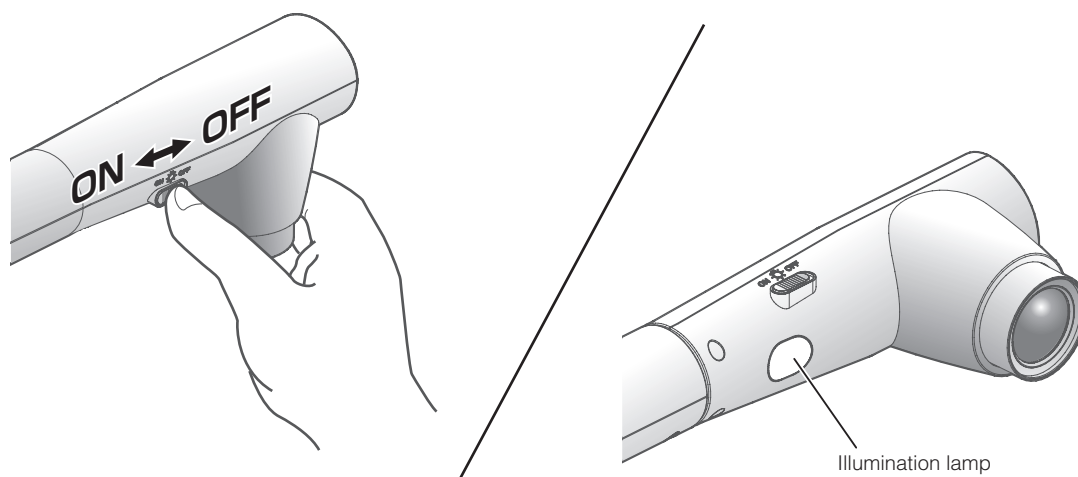

The illumination light can be turned ON/OFF by sliding the illumination light switch.

- [ON] : The illumination light turns on.
- [OFF] : The illumination light turns off.

CAUTION

- To take shots of people, turn the illumination light switch to OFF.
- Make sure that the light from the illumination light does not shine directly into your eyes.
- This product is equipped with a high-brightness LED light. You can safely use the light to light up objects, however its brightness will gradually diminish with long-term use. This is not a malfunction of the light, but a feature of LED performance.
- Do not touch the illumination light while it is on as it may become very hot.

Image selection

Select the image as described below.

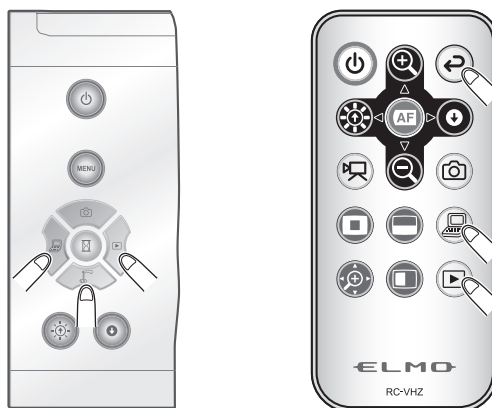

Camera image:



[] button on the operating panel or
 [] button on the remote control.

Image input to the [] [] terminal:













[] button on the operating panel or
 [] button on the remote control.

Image stored on the SD card/USB flash drive:

[] button on the operating panel or
 [] button on the remote control.

Note

- When using a PC with an external output mode, set the PC to the external output mode after pressing the [] button on the operating panel or the [] button on the remote control.
- When you press the [] button on the operating panel or the [] button on the remote control, the image input to the [] terminal is only output from the [] terminal and the image input to the [] terminal is only output from the [] terminal.

Pausing the image

Press the [] button on the operating panel to pause the camera image. Press the button again to cancel the pause.

2-4 Setting Changes

Various settings for this unit are changed through the menu (characters and icons) displayed on the screen.

Changing a Setting

- 1 Press the [MENU] button on the operating panel to display the menu on the screen, and then use the

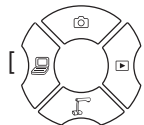

[] buttons to move the cursor to the icon you want to operate or set.

- 2 Press the [] button to select the function to be changed.

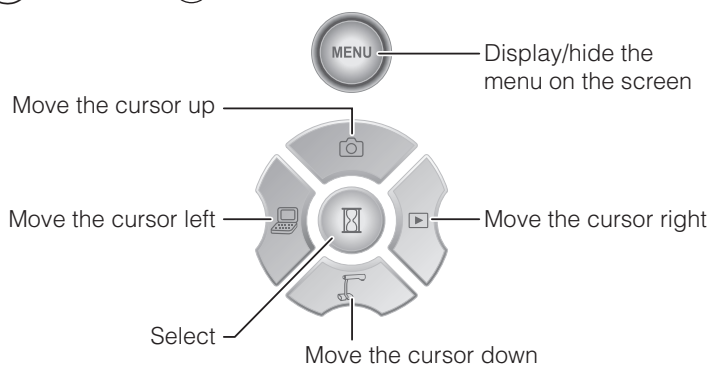

Front operating panel



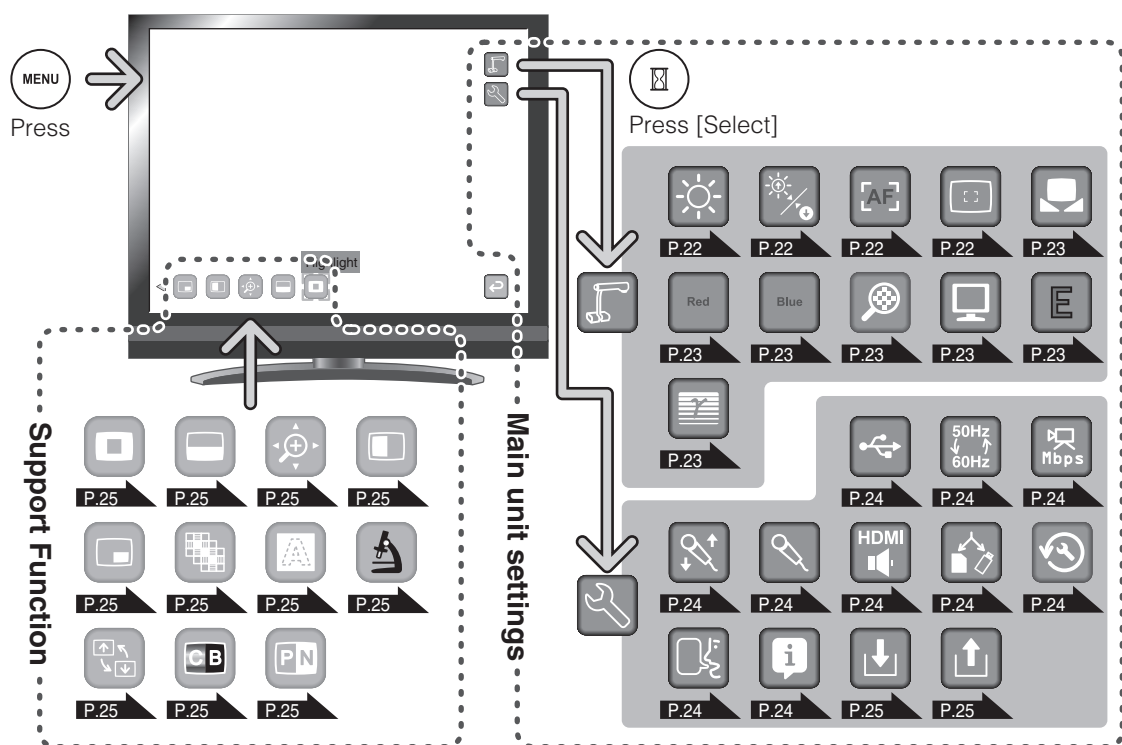

List of the Menus







※ To go back a layer or to hide the menu, select [] and press the [] button.







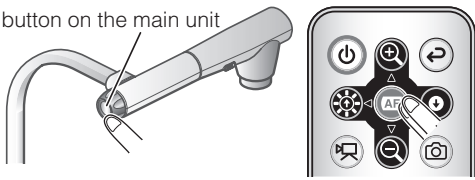



■ Descriptions of Each Menu

Main Unit

Icon	Name	Function
	Camera Controls	To display the setting menu for camera image.
	Preferences	To display the preference menu for various functions.
	Exit	To hide the menu.

Camera Controls [Second Layer]



Icon	Name	Selection Item	Factory Setting	Function
	Brightness	Auto	✓	To maintain constant brightness of the image, the brightness of the image changes automatically according to the brightness of the shooting environment. Press the [☀/☉] buttons on the operating panel or the [☀/☉] buttons on the remote control to change the brightness. P.17
		Manual		Press the [☀/☉] buttons on the operating panel or the [☀/☉] buttons on the remote control to change the level of brightness. The brightness of the image will not change automatically in response to the brightness of the shooting environment.
	Rst Brightness	Reset	/	To reset the brightness setting.
		Exit		To go back one layer in the menu.
	AF Mode	Auto		To constantly auto focus. You do not need to press the AF button on the main unit or the [AF] button on the remote control. The focus changes automatically as the object changes.
		Manual	✓	To auto focus only once when the AF button on the main unit or the [AF] button on the remote control is pressed. 
		Zoom Sync		To auto focus only once after zooming.
	Focus	Near	/	To focus manually.
		Far		
		Exit		To go back one layer in the menu.

Icon	Name	Selection Item	Factory Setting	Function
	White Balance ★What is White Balance? A function to adjust any area of white color and ensure it is projected accurately as white. This allows colors to be seen naturally according to the characteristics of the object.	Auto	✓	To constantly adjust the white balance. The white balance is adjusted automatically to ensure a more natural color according to the characteristics of the object.
		One-Push		To automatically adjust the white balance only once when this setting is selected.
		Manual		To manually adjust the [R-Gain] and the [B-Gain].
	R-Gain	Up	/	To adjust the R-Gain of the camera image when the white balance is set to Manual. Use [Up] or [Down] to increase or decrease the red color.
		Down		
		Exit		To go back one layer in the menu.
	B-Gain	Up	/	To adjust the B-Gain of the camera image when the white balance is set to Manual. Use [Up] or [Down] to increase or decrease the blue color.
		Down		
		Exit		To go back one layer in the menu.
	Digital Zoom	Valid	✓	To set the digital zoom to Valid/Invalid.
		Invalid		
	Image Mode ★What is Image Mode? A special effect to project a clear image.	Text 1	✓	To clearly reproduce black & white documents including such features as characters and lines. The effect intensifies as the number increases.
		Text 2		
		Text 3		
		Graphic 1		To clearly reproduce photographs and color documents.
		Graphic 2		The image could be improved if used with a DLP projector. (The effect depends on the projector used.)
	Edge Effect	Low	✓	To emphasize the outline of images.
		Medium		Enabled only when [Graphic1] is selected for the Image Mode ().
		High		
	Gamma ★What is Gamma? An image characteristic unique to image I/O devices.	Low		To change the characteristics of the image. Enabled only when [Graphic1] is selected for the Image Mode (). The setting can be changed according to user preference.
		Medium	✓	
		High		
	Exit	/	/	To go back one layer in the menu.













Preferences [Second Layer]

Icon	Name	Selection Item	Factory Setting	Function
	USB Mode ★What is USB Mode? Functions described on the right can be used by connecting the document camera to a PC with the USB cable.	Mass Storage		To send the data on the SD card loaded in the device to the PC.
		Application		To control this device from a PC using special software.
		UVC (USB Video Class)	✓	To use this device as a UVC camera in a video conferencing system, for example, without the use of a special software program.
	Flickerless	60Hz	Japan/ U.S.	To reduce fluorescent light flickering due to the power supply frequency. Select the same value as used for the power supply frequency.
		50Hz	Others	
	Movie Quality	Low		To set the quality of the movie to record.
		Medium		
		High	✓	
	Volume	Up	/	To set the volume of the audio line output and the HDMI output.
		Down		To go back to the previous layer of the menu.
		Exit		
	Audio Selector	Built-in mic	✓	To select the source of the audio input.
		Mic-in		
		Line-in		
	HDMI Audio	ON		Audio from built-in microphone, external microphone or external line input will be output from the HDMI OUT terminal.
		OFF	✓	Audio from built-in microphone, external microphone or external line input will not be output from the HDMI OUT terminal. ※ Audio will be always output from the Audio Line OUT terminal on rear panel irrespective of this setting. ※ When this setting is OFF, audio will be recorded but will not be output from the HDMI OUT terminal.
	Select Memory	SD Card	✓	To select where to save still images/movies, when both SD card and USB flash drive are inserted.
		USB Flash Drive		
	Reset All	Yes	/	To reset various settings to factory settings.
		No		
	Language	Japanese or others	Japan	To display the menu in Japanese or other language. (The choice of languages depends on your region.)
		English	Others	To display the menu in English.
	Guide	ON	✓	The device's operating status and an explanation of the icons is displayed on the screen.
		OFF		The device's operating status and an explanation of the icons is not displayed on the screen.













Icon	Name	Selection Item	Factory Setting	Function
	Save Presets ★Saved Items Zoom Brightness Mode Brightness Level White Balance R-Gain B-Gain Image Mode Edge Effect Gamma	1		To save the current setting as the preset setting of the selected number.
		2		
		3		
		Exit		To go back one layer in the menu.
	Load Presets	1		To call the setting saved for the selected number.
		2		
		3		
		Exit		To go back one layer in the menu.
	Exit			To go back one layer in the menu.

Support Function

Icon	Name	Function
	Highlight	To highlight and draw attention to a particular section of the image. P.28
	Mask	To mask a section of the image. P.30
	Scroll	To expand to a set size and allow scrolling of the enlarged section. P.31
	Compare Picture	To display a still image and live image together. The still image is displayed on the left side of the screen, and the camera image on the right. P.32
	PIP (Picture in Picture)	To display either a still image or a Camera image while displaying the other. The image is displayed at the bottom right of the Screen. P.33
	Mosaic	To apply a mosaic effect to the image. P.35
	Marker Mask	A filter to blacken a color section of the image. For instance, this can be used to temporarily hide colored text, so students can be questioned about the hidden text. P.36
	Microscope	For use with a microscope. P.80
	Image Rotation	To rotate the image by 180°.
	Color/B&W	To display an image in color.
		To display an image in black & white.
	Posi/Nega	To output a positive image.
		To output a negative image.

Support Function Setting





Highlight

Icon	Name	Selection Item	Function
	Darkness	 Darken	To set the darkness of a dark section. The dark section becomes darker when [] is selected, and becomes more visible when [] is selected.
		 Lighten	
		 Exit	
	Size	 Lengthen Height (stretch)	To change the size of the highlighted display area.
		 Shorten Height	
		 Lengthen Width (stretch)	
		 Shorten Width	
		 Exit	
	Exit		



Mask

Icon	Name	Function
	Exit	





Scroll

Icon	Name	Function
	x2	To set the digital zoom magnification to 2x when the Scroll icon is selected.
	x3	To set the digital zoom magnification to 3x when the Scroll icon is selected.
	x4	To set the digital zoom magnification to 4x when the Scroll icon is selected.
	Exit	



Compare Picture

Icon	Name	Function
	Prev Picture	To show the previous picture.
	Next Picture	To show the next picture.
	Exit	

 PIP

Icon	Name	Function
	Prev Picture	To show the previous picture.
	Next Picture	To show the next picture.
	Change Window	To switch the sub screen and the main screen.
	Exit	

 Mosaic

Icon	Name	Function
	Coarse	To make the mosaic pattern coarser.
	Fine	To make the mosaic pattern finer.
	Exit	

 Marker Mask

Icon	Name	Function
	Exit	

 Microscope

Icon	Name	Function
	Exit	



■ Details of Each Function

Highlight Function



This is a function to highlight a particular section of the image.

Use this function to draw attention to a section.

Highlight operations

When you press the [] button on the remote control or [] on the menu while a camera image or a Play mode is displayed, the highlight function uses the darkness and size set previously.

You can move the highlighted area using the [] buttons on the remote control.

The highlight display is cleared when you press the [] button on the remote control or [] on the menu again.

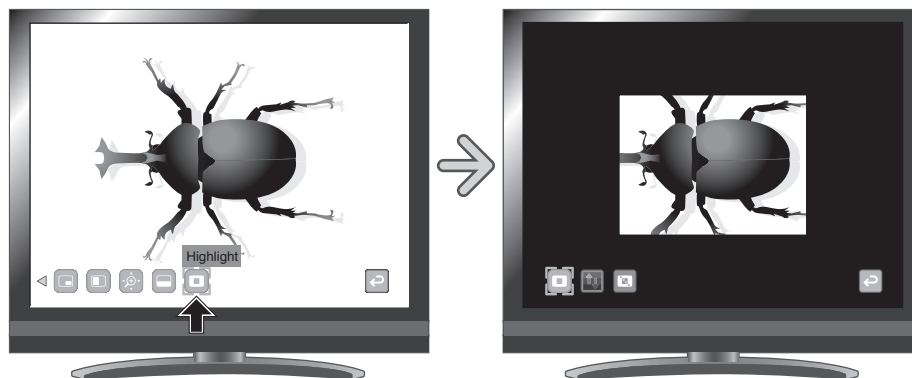
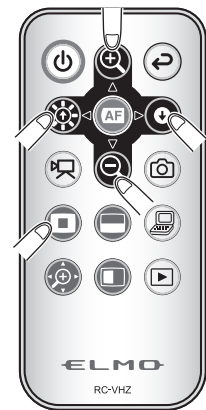



Note

- The Highlight function cannot be used when the [] button is selected in the Image Selection.
- Highlighted image cannot be saved.

Setting operations

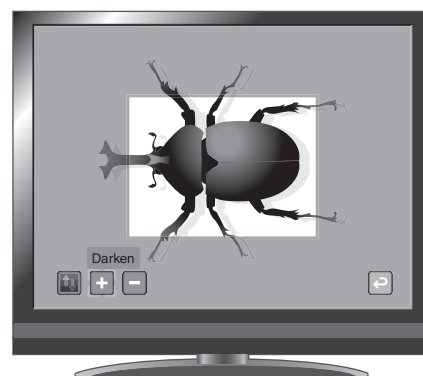
You can change the darkness of a particular section by changing the setting of [] on the menu while the section is highlighted.





You can also change the size of the highlighted display area by changing the setting of [] on the menu.





Mask Function

This is a function to mask a section of an image.

Mask operations

When you press the [] button on the remote control or [] on the menu while a camera image or a Play mode is displayed, the mask effect is applied with the darkness set previously.

You can move the masked area using the [] buttons on the remote control.

The mask display is cleared when you press the [] button on the remote control or [] on the menu again.

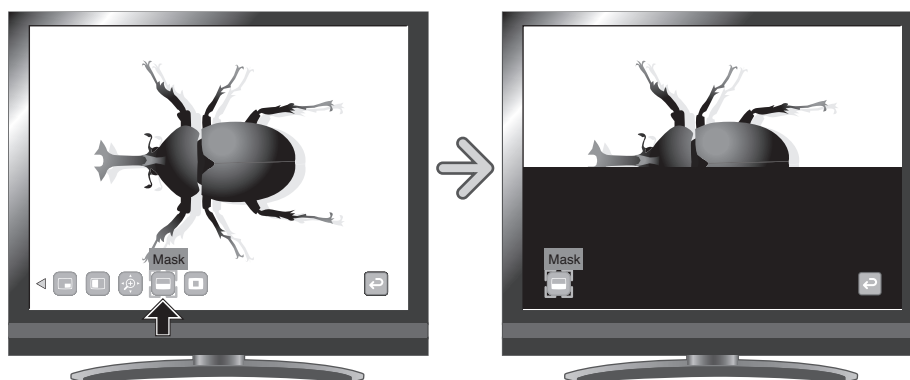
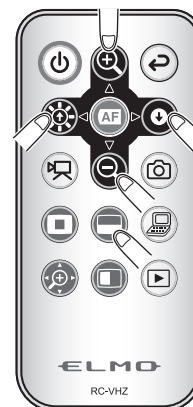



Note

- The Mask function cannot be used when the [] button is selected in the Image Selection.
- Masked image cannot be saved.



Scroll Function

The image expands to the digital zoom set previously, and the enlarged screen can be scrolled.

Scroll operations

When you press the [] button on the remote control or [] on the menu while a camera image or a Play mode is displayed, the image expands to the digital zoom set previously.

You can scroll the enlarged image by using the [] buttons on the remote control.

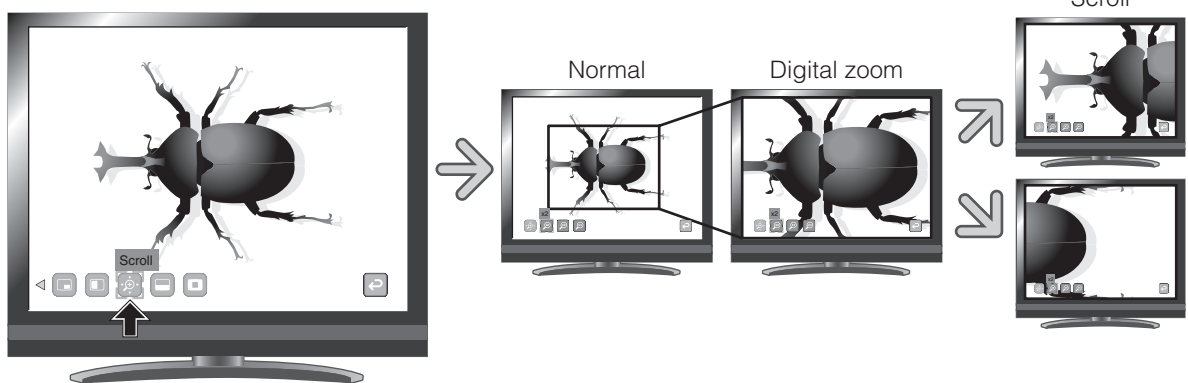
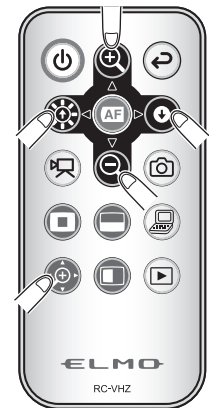

Digital zoom is canceled when you press the [] button on the remote control or [] on the menu again.



Note

- The Scroll function cannot be used when the [] button is selected in the Image Selection.
- When digital zoom has already been performed from the zoom dial on the main unit or the zoom buttons on the remote control, digital zoom is released and the scroll function works at the magnification ratio currently set.
- Cannot use zoom while scrolling.
- Within the digital zoom range, the image quality deteriorates.

Digital zoom setting operations



You can change the digital zoom ratio to either x2, x3, or x4 by selecting [], [], or [] on the onscreen menu while the scroll function is working.





Compare Picture Function

To display the camera image and the picture stored on the SD card/USB flash drive together.



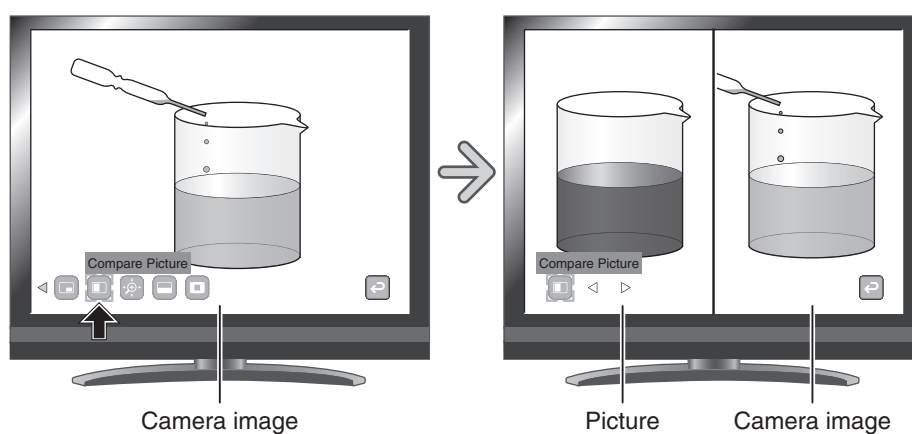

Compare Picture operations

When you press the [] button on the remote control or [] on the menu, while a camera image or a play mode is displayed, the camera image is displayed at the right side of the screen and the picture stored on the SD card/USB flash drive is displayed at the left side of the screen.

The Compare Picture function is cleared when you press the [] button on the remote control or [] on the menu again.



Changing the still Picture

You can change the picture displayed on the screen to another picture stored on the SD card/USB flash drive by selecting [] or [] on the menu or the [] / [] buttons on the remote control, while the compare picture function is working.

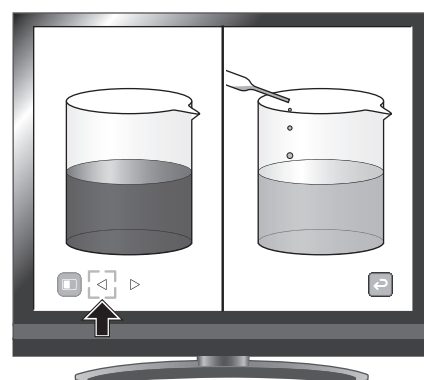

Note

- The Compare Picture Function cannot be used when the [] button is selected in the Image Selection.
- When using the Compare Picture Function, the image cannot be saved.

Picture in Picture Function

To display either a picture stored on the SD card/USB flash drive or a camera image at the bottom right of the screen.

Picture in Picture Operations



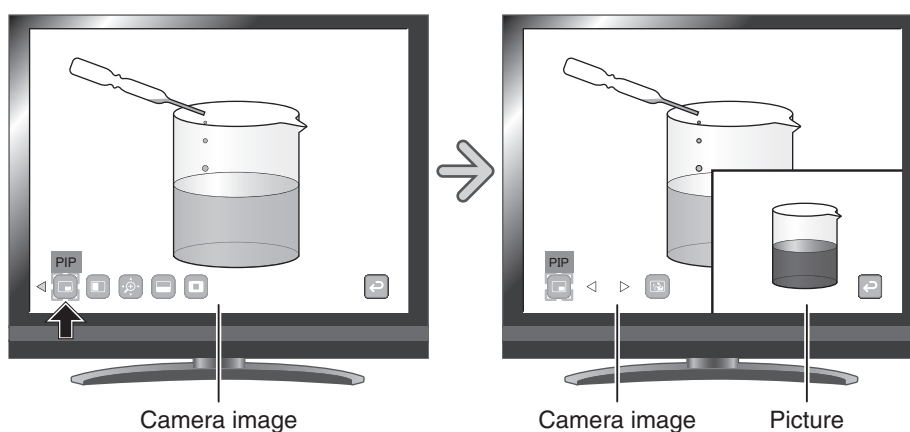

When you press the [] on the menu, while a camera image is displayed, the picture stored on the SD card/USB flash drive is displayed at the bottom right of the screen.

When you press the [] on the menu, while the picture stored on the SD card/USB flash drive is displayed, a camera image is displayed at the bottom right of the screen.

The Picture in Picture effect is cleared when you press the [] on the menu again.



Changing the still picture

You can change the picture displayed on the screen to another picture stored on the SD card/USB flash drive by selecting [] or [] on the menu or the [ / ] buttons on the remote control, while the picture in picture function is working.

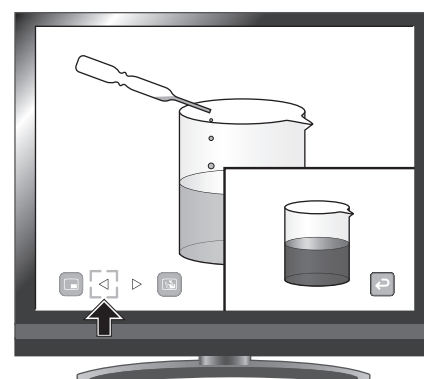

Switching the subscreen and the main screen.

You can switch the subscreen and the main screen by selecting [] on the menu. While the Picture in Picture function is working.

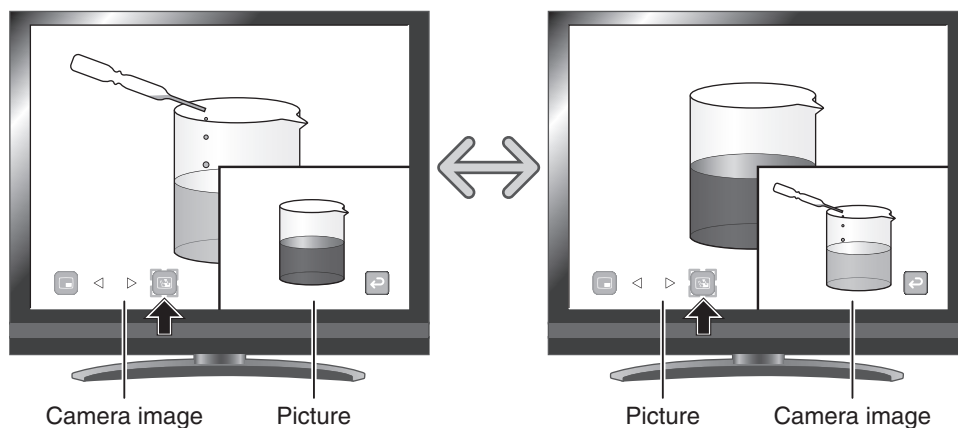



Note

- The Picture in Picture function cannot be used when the [] button is selected in the image selection.
- When using the Picture in Picture function, the image cannot be captured.
- When digital zoom is used, the still screen is displayed only at 12x optical zoom magnification.
- When using the Picture in Picture function, the image cannot be saved.

Mosaic Function



To apply a mosaic effect to the image. You can change the extent of mosaic.

Mosaic Operations

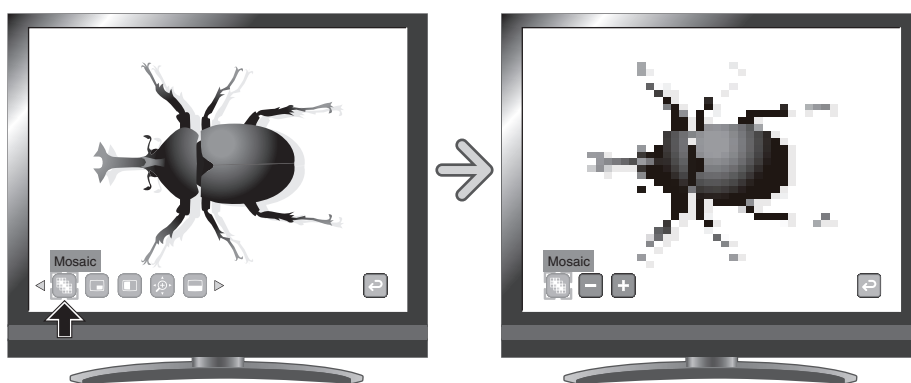
When you press the [] on the menu, while a camera image or a Play mode is displayed, the mosaic effect is applied. The mosaic effect is cleared when you press the [] on the menu again.



Mosaic setting Operations

You can change the extent of mosaic by selecting [] or [] on the menu.

While the mosaic function is working.

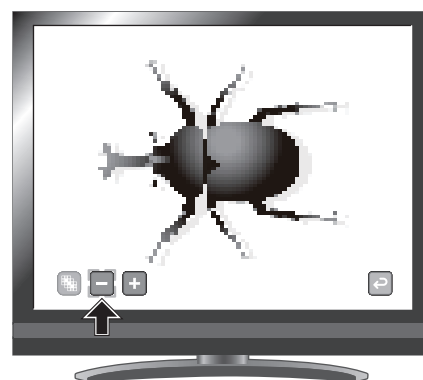

Note

- The Mosaic function cannot be used when the [] button is selected in the image selection.
- When using the Mosaic function, the image cannot be saved.

Marker Mask Function

This is a filter to blacken the color section of an image.



For instance, this can be used to temporarily hide colored text, so students can be questioned about the hidden text.

Marker Mask operations

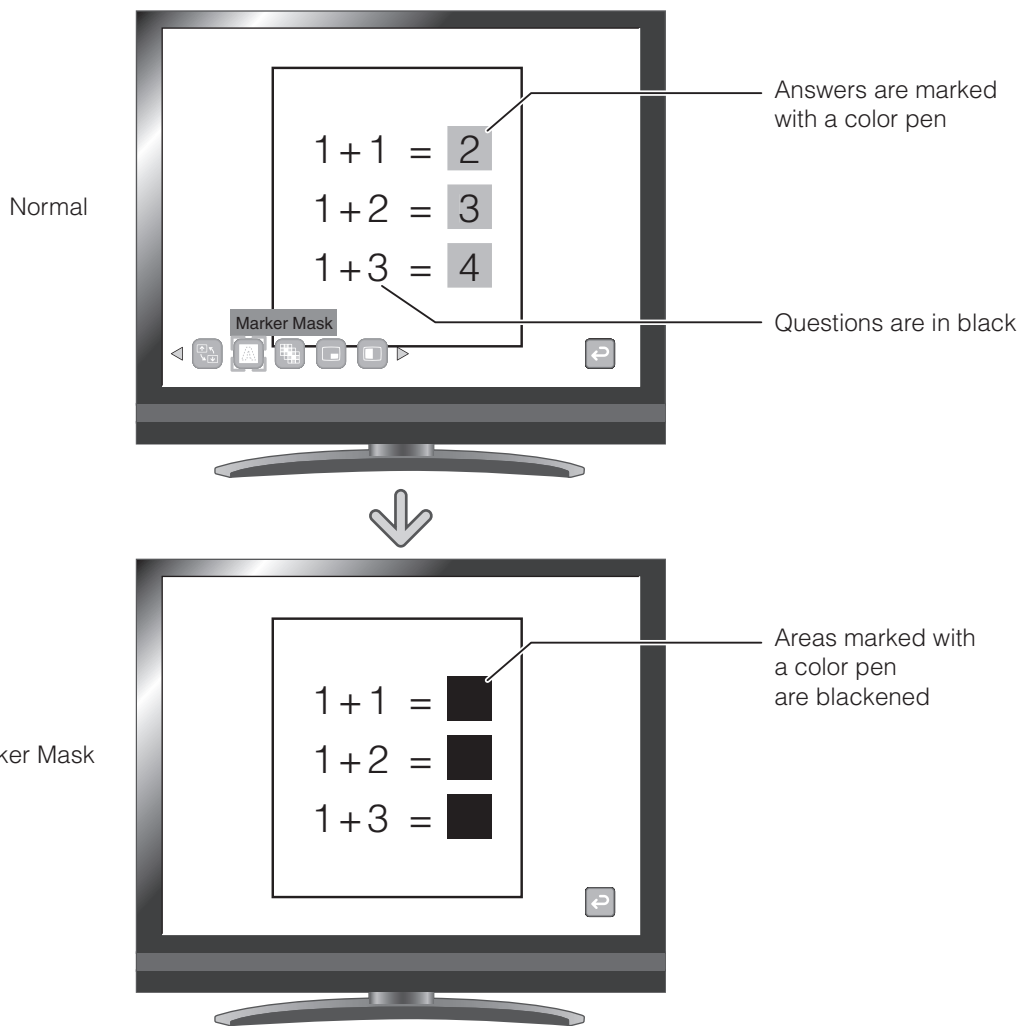
Press [] on the menu to blacken the color section in the image.



Note

- The Marker Mask function can be used only when a still image is selected using the [] button and [] button.
- When using the Marker Mask function, the image cannot be saved.
- The proper effect of this function may not be obtained depending on the material used.

3 ADVANCED OPERATIONS

3-1 Using an SD card/USB flash drive

With this equipment, you can save a camera image as a picture or movie on an SD card or USB flash drive. You can also display the data stored on the SD card or USB flash drive on the screen.

Before you begin, insert a commercially available SD card or USB flash drive into the corresponding slot on the side panel.

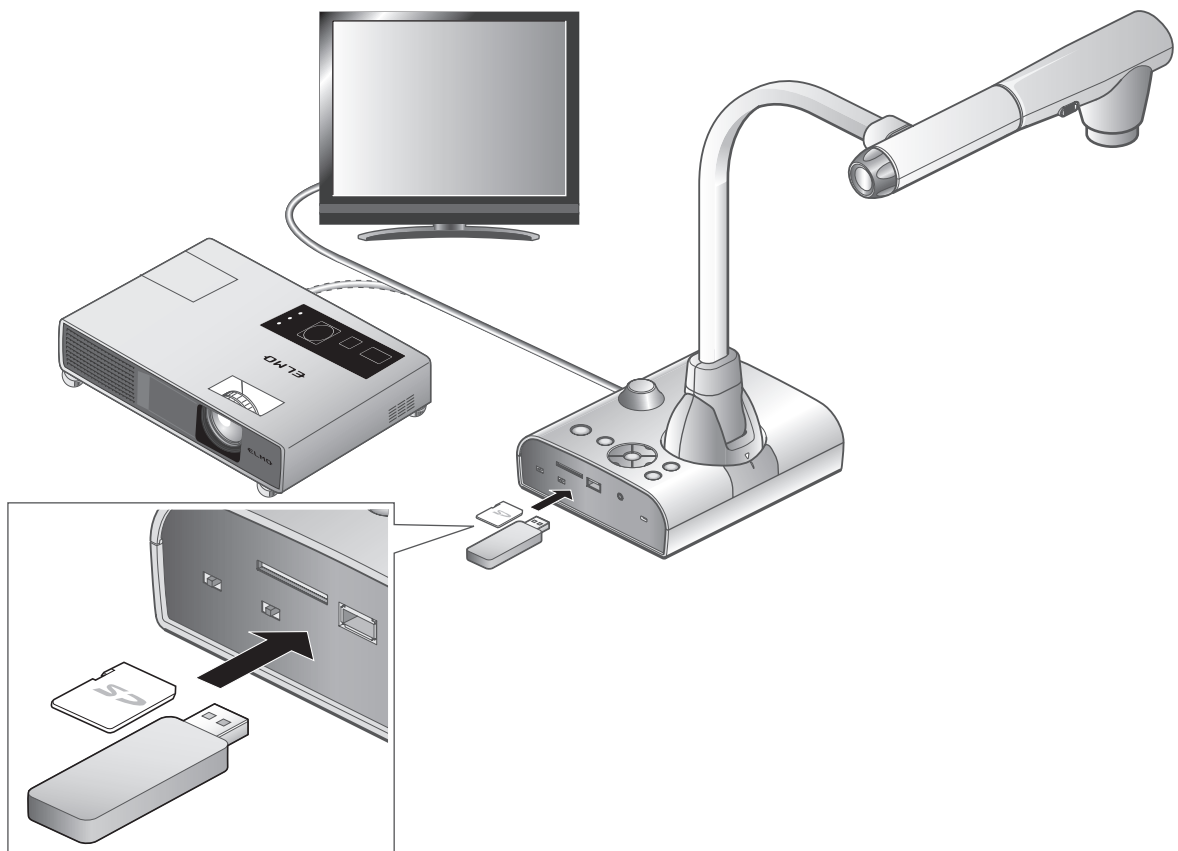







Note

- SD card
 - The SDXC card cannot be used.
 - Formatting the SD card with this product before you use is recommended.
 - Using the SD card to record movies is recommended.
 - Using the SD card class 6 or higher is recommended.
- USB flash drive
 - Supports the USB flash drive up to 32GB.
 - Formatting the USB flash drive with this product before you use is recommended.
- It may take some time to recognize the memory card after inserting it or to save images to the memory card.
- Please do not remove the memory card while recording, playing or using education support function when the main unit is accessing the memory card.

**Note**

- Formatting the SD card/USB flash drive.



When you need to format the SD card/USB flash drive, insert it into this product and execute formatting.

- ① Press the [] button on the operating panel or [] button on the remote control to switch the output image to Play mode.
- ② Press the [] button on the operating panel to display the menu.
- ③ From the menu, select [] to switch the menu.
- ④ Select [] from the menu.
- ⑤ Select [] to start formatting. If you do not want to format, select [].



■ Saving images

Picture

Basic operations

- ① Press the [] button on the operating panel or the [] button on the remote control.



- ② Make sure that the menu is not displayed on the screen and press the [] button on the operating panel or the [] button on the remote control.

If the menu is displayed on the screen, do the above - operation after hiding the menu by pressing the [] on the operating panel.





- ③ Saving begins when [] appears on the screen.



- Saving -

Movie



Basic operations

- ① Press the [] button on the operating panel or the [] button on the remote control.



- ② Press the [] button on the remote control.



- ③ Recording begins when [] appears at the top left of the screen. When you press the [] button again on the remote control, recording stops and [] disappears.



- Recording -

**Note**

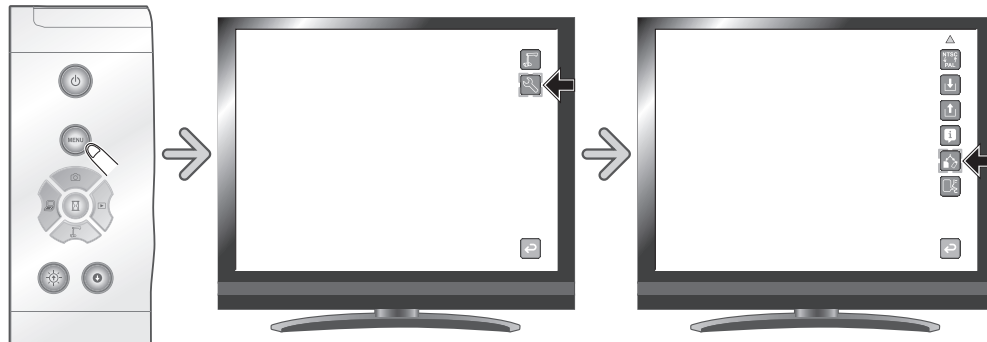

- Even if the output image is set to HDMI and the resolution is set to 1080p, it is recorded with 720p.
- Use a memory card with a faster read/write speeds (in case of SD card: Class 6 or better), or the image quality may deteriorates.
- **How to select the destination to save when both SD card and USB flash drive are inserted.**
While the camera image is displayed on the screen, select [SD Card] or [USB Flash Drive] in the [MENU] button → [] → [].



■ Displaying the stored data

Thumbnail display (list of pictures/movies)

Basic operations



- ① Press the [] button on the operating panel or the [] button on the remote control to display the thumbnails (list of pictures/movies).

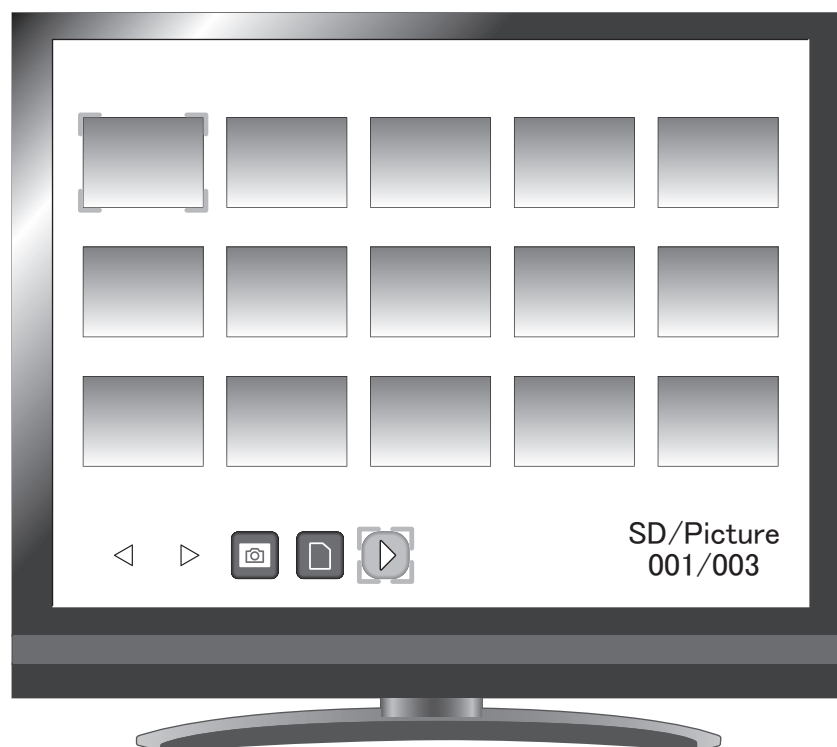

ADVANCED
OPERATIONS





② How to move the cursor

- (1) You can move the cursor using the [] or [] button on the operating panel or the



[] button on the remote control.



- (2) You can display the selected picture/movie full-screen by pressing the [] button on the operating panel or the [] button on the remote control.

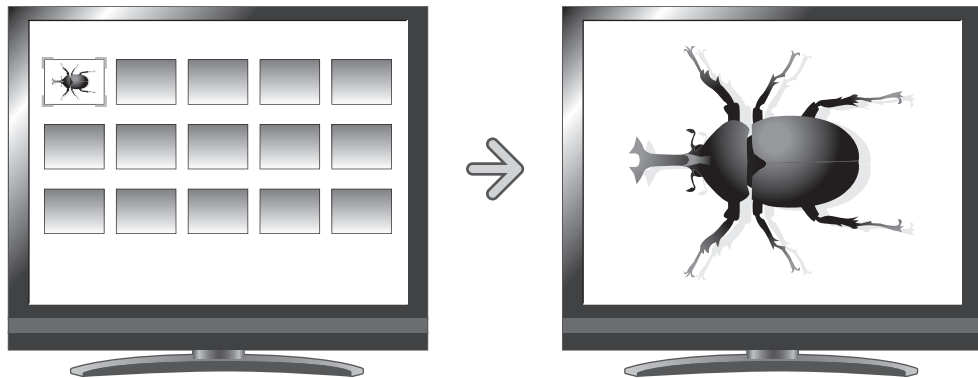

Changing settings

You can display the Thumbnail Menu by pressing the [MENU] button on the operating panel while the thumbnails are displayed on the screen.

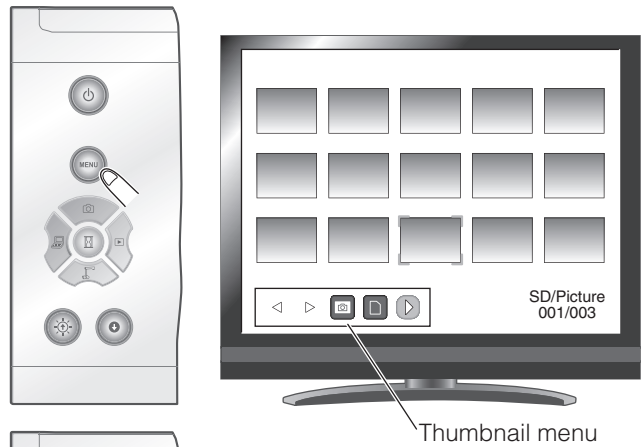

- Move the cursor using the [] or [] button on the operating panel.



[] button: Moves the cursor left

[] button: Moves the cursor right



- Press the [] button on the operating panel to select the menu item.

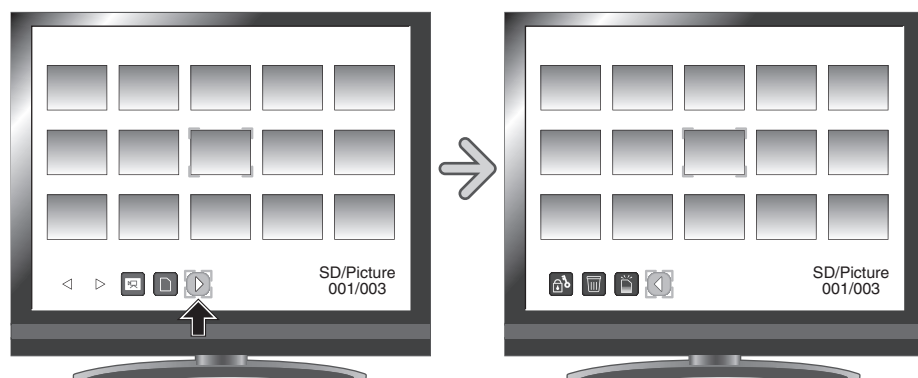

If you press [] , the next set of menu icons appears.



























CAUTION

Pressing the [] or [] button on the operating panel while the menu icons are hidden allows you to navigate among the images.

You can not operate the menu from the remote control.

Menu descriptions**Thumbnail display**

Icon	Name	Selection Item	Function
	Prev Page		To move to the previous thumbnail page.
	Next Page		To move to the next thumbnail page.
	SD Card		To switch between the memory from which images are displayed. It can be switched with the [] button on the remote control too.
	USB Flash Drive		
	Movie		To switch the data displayed as thumbnails between movies and pictures. It can be switched with the [] button on the remote control too.
	Picture		
	Next Menu		To move to the next menu page.
	Memory Lock	 Lock/Unlock	To lock (set as protected) or unlock (set as unprotected) the selected image. It can be switched with the [] button on the remote control too.
		 Lock All	To lock (set as protected) all thumbnail images.
		 Unlock All	To unlock (set as unprotected) all thumbnail images.
		 Exit	To go back to the previous layer of the menu.
	Delete	 Yes	To delete the selected image.
		 No	To cancel deletion.
		 Exit	To go back to the previous layer of the menu.
	Format	 Yes	To format the USB flash drive or SD card.
		 No	To cancel formatting.
		 Exit	To go back to the previous layer of the menu.
	Prev Menu		To move to the previous menu page.

Displaying a picture full-screen

You can display a picture you selected from the thumbnails (list of pictures/movies) full-screen.

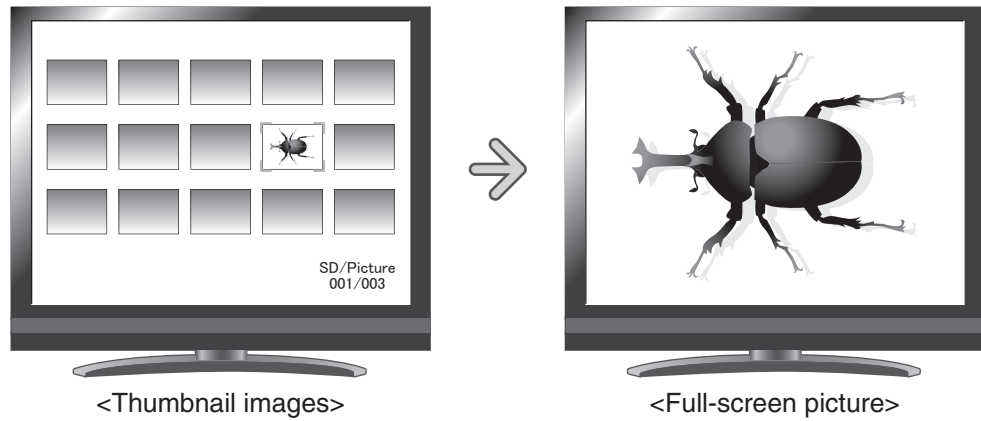







Basic operations

- 1 Show in the Thumbnail Menu the icon for displaying the list of pictures.

Press the [MENU] button on the operating panel to display the Thumbnail Menu.



Then, the current status of the selection is displayed at the button right of the screen.

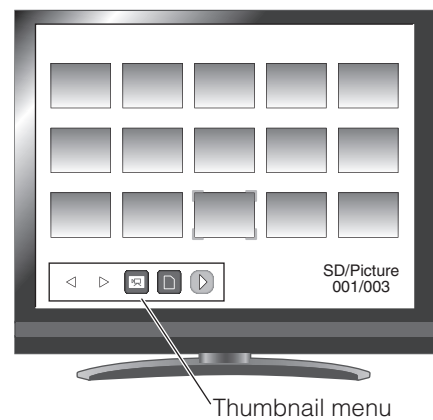

- (1) If you see [] in the menu, the list of pictures has already been displayed.
- (2) If you see [] in the menu, press the [] or [] button on the operating panel to move the cursor to [] and then press the [] button. You can display the list of pictures. Or a list of images can be displayed with the [] button on the remote control.
- (3) Press the [MENU] button again to hide the Thumbnail Menu.



- ② Select the picture you want to display full-screen.



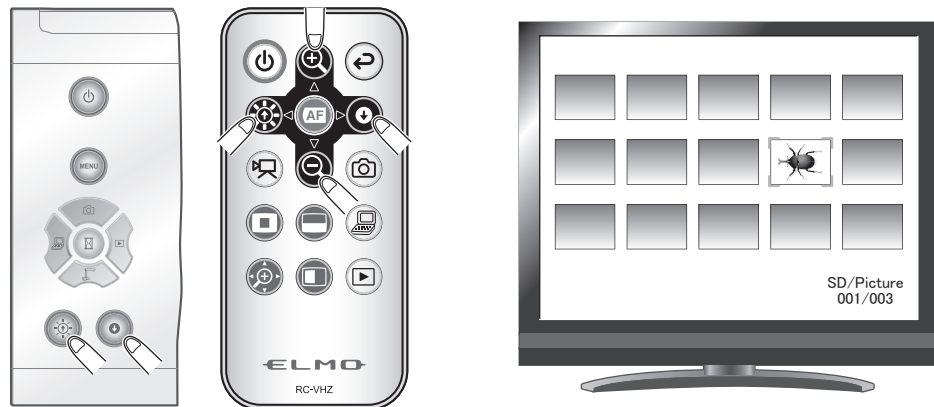

Press the [] or [] button on the operating panel or the [] button on the remote control to move the cursor.





- ③ Select the picture you want to display full-screen.

Press the [] button on the operating panel or the [] button on the remote control.



In this status, press the [] / [] button on the control panel or the [] / [] button on the remote control to display another image in the thumbnail list.

- ④ To return to the thumbnail display, press the [] button on the operating panel or the [] button on the remote control.



Changing settings

While a picture is displayed full-screen, you can display the Picture Menu and Support Function Menu by pressing the [MENU] button on the operating panel.

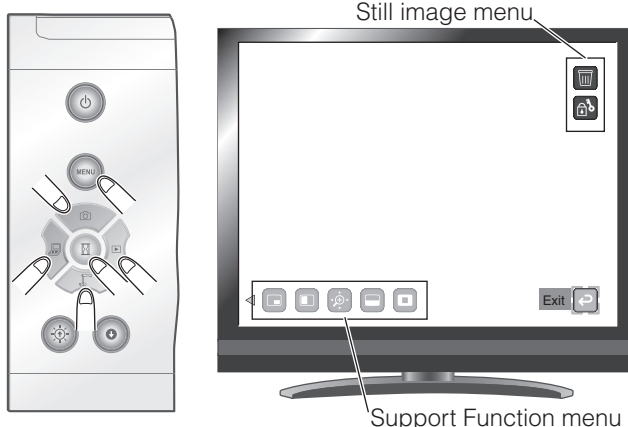

Move the cursor using the [] button on the operating panel and select a menu item with the [] button.

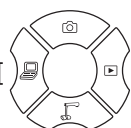



Menu descriptions

Picture Display Menu













Icon	Name	Selection Item	Function
	Delete	YES Yes	To delete the image displayed on the screen (You can not delete the image if it is protected).
		NO No	To cancel deletion.
			Exit
	Memory Lock		To lock (set as protected) or unlock (set as unprotected) the selected image.
	Exit		To return to the previous level of menu.

Support Function

Icon	Name	Function
	Highlight	To highlight part of the image you want to emphasize. P.28
	Mask	To mask part of the image. P.30
	Scroll	To enlarge the image to the size you specify, allowing you to move within the enlarged area. P.31
	Compare Picture	To display the still image captured when this icon is selected on the left, and display the camera image on the right. P.32
	PIP (Picture in Picture)	To display a Camera image while displaying a still image saved in the memory card. The Camera image is displayed at the bottom right of the screen. P.33
	Mosaic	To apply the mosaic effect to the image. P.35

Icon	Name	Function
	Marker Mask	To apply a filter to a colored area to cover it with the black marker. This function allows you to temporarily hide selected color characters and question the students. P.36
	Image Rotation	To rotate a still image saved in the memory card by 90°.





 Highlight

Icon	Name	Selection Item	Function
	Darkness	 Darken	To set the darkness of the darkened (not highlighted) area. [] makes the dark area less transparent and harder to see through, and [] makes the area more transparent and easier to see through.
		 Lighten	
		 Exit	
	Size	 Lengthen Height (stretch)	To change the size of the highlighted area.
		 Shorten Height	
		 Lengthen Width (stretch)	
		 Shorten Width	
		 Exit	
	Exit		



 Mask

Icon	Name	Function
	Exit	





 Scroll

Icon	Name	Function
	x2	To set the digital zoom magnification to x2 when the Scroll icon is selected.
	x3	To set the digital zoom magnification to x3 when the Scroll icon is selected.
	x4	To set the digital zoom magnification to x4 when the Scroll icon is selected.
	Exit	



 Compare Picture

Icon	Name	Function
	Prev Picture	To show the previous picture.
	Next Picture	To show the next picture.
	Exit	

 PIP

Icon	Name	Function
	Prev Picture	To show the previous picture.
	Next Picture	To show the next picture.
	Change Window	To switch the sub screen and the main screen.
	Exit	

 Mosaic

Icon	Name	Function
	Coarse	To make the mosaic pattern coarser.
	Fine	To make the mosaic pattern finer.
	Exit	

 Marker Mask

Icon	Name	Function
	Exit	

Playing a movie full-screen

You can play a selected movie from the thumbnails (list of pictures/movies) full-screen.

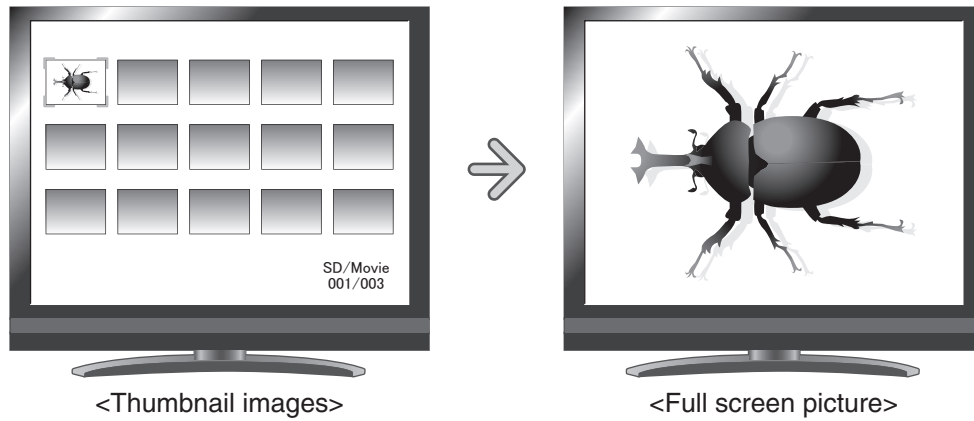









Basic operations

- ① Show in the Thumbnail Menu the icon for displaying the list of movies.

Press the [] button on the operating panel to display the Thumbnail Menu.



Then, the current status of the selection is displayed at the button right of the screen.

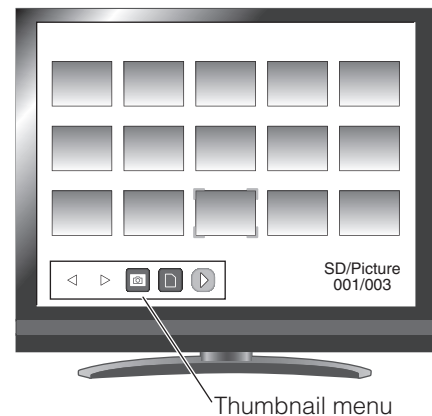

- (1) If you see [] in the menu, the list of movies has already been displayed.
- (2) If you see [] in the menu, press the [] or [] button on the operating panel to move the cursor to [] and then press the [] button. You can display the list of movies.
Or a list of images can be displayed with the [] button on the remote control.
- (3) Press the [] button again to hide the Thumbnail Menu.



- ② Select the movie you want to display full-screen.

Press the [] or [] button on the operating panel or the [] button on the remote control to move the cursor.





- ③ Select the movie you want to display full-screen.

Press the [] button on the operating panel or the [] button on the remote control.

The movie automatically starts to play.





- ④ To return to the thumbnail display, press the [] button on the operating panel or the [] button on the remote control.



Changing settings

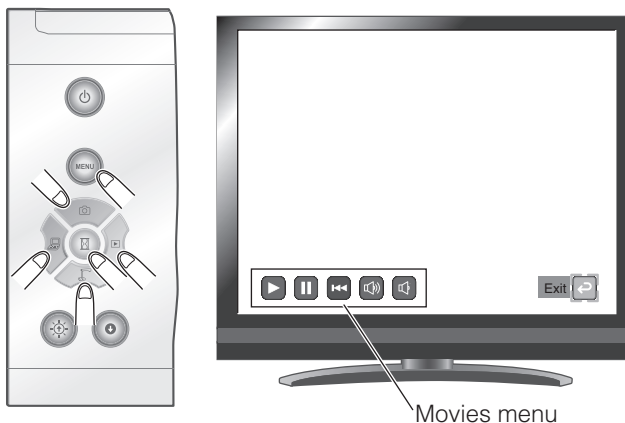





You can display the Movie Menu by pressing the [] button on the operating panel while a movie is displayed full-screen.



Move the cursor using the [] button on the operating panel and select a menu item with the [] button.

Menu descriptions

Movie Play Menu

Icon	Name	Function
	Play	To play/stop/cueing the movie.
	Pause	
	Cueing	
	Up	To set the output audio volume.
	Down	
	Repeat On	To play the movie on loop.
	Repeat Off	



Note

- You cannot display pictures other than DCF system compliant files and file structures.
- Movie files other than those recorded on this product (MVI_****.MP4, * represents file identification numbers) cannot be played on.
- Many, but not all Images taken by other digital cameras can be displayed (viewed) on this product (examples of images that cannot be displayed: images larger than 4092 X 4092 pixels in size, 4:1:1 image file formats, etc.).

3-2 Saving data stored on an SD card to PC via USB cable

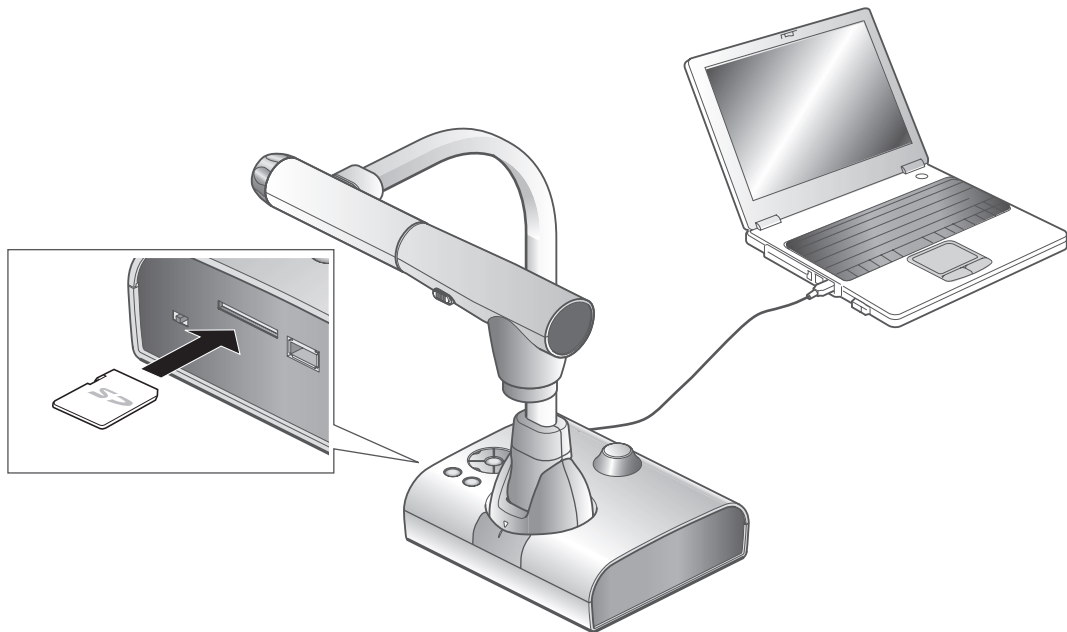

CAUTION

- Set [] (USB Mode) to [Mass Storage] from the Preferences menu on the screen. P.24
- Insert the SD card with the label facing up. Forcing it into the slot with the wrong side up may cause a malfunction.

By connecting this equipment to a PC via USB, you can save the image data stored on the SD card to the PC.

The operating system (OS) for the connected PC should be Microsoft Windows XP SP3, Windows Vista SP2, Windows 7 SP1, Windows 8 or Windows 8.1.

- ① Turn on the equipment and the PC.
- ② Connect the equipment to the PC with the supplied USB cable.

Note

- When you connect the equipment to the PC for the first time, the required drivers are installed automatically using the plug-and-play function of Windows. From the second time and thereafter, the drivers are not installed again.

- ③ The equipment is recognized as a removable disk. You can view the image data on the SD card with the viewer software of the PC.

- The image data is stored as JPEG files in the following folders:

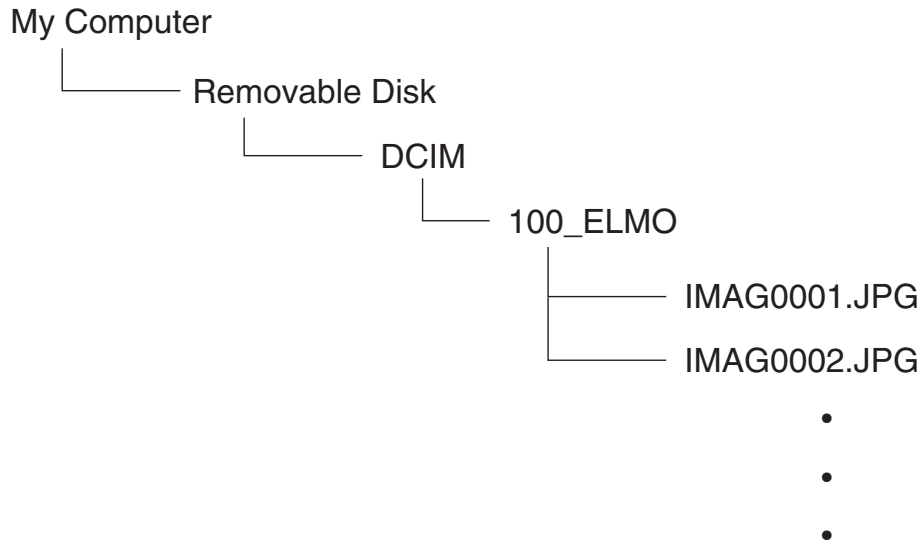

CAUTION

- You can not save, delete, lock, unlock, or format the images from the PC.
- The image files are not stored with the correct date and time.
- Do not connect/disconnect the USB cable while operating the equipment using the operating panel or remote control. This may cause a malfunction.
- While the equipment is in the USB-connection mode, do not switch [] (USB Mode) to another mode from the Preferences menu on the screen.
- We recommend using a USB 2.0-compliant USB cable.



Note

- Depending on the USB environment used by the PC or any peripheral devices, image transfer may be disrupted.
- Operation is not guaranteed for all environments.
- If [USB Mode] has been set to [Mass Storage] and the equipment is connected to the PC, you can not save, delete, lock or unlock the pictures and movies in the SD card or format the SD card using the equipment. (You can do above operations to the files in the USB flash drive).
- Make sure to disconnect the USB cable before switching [USB Mode] from the OSD menu.

3-3 Using this device by connecting to a PC with a USB cable

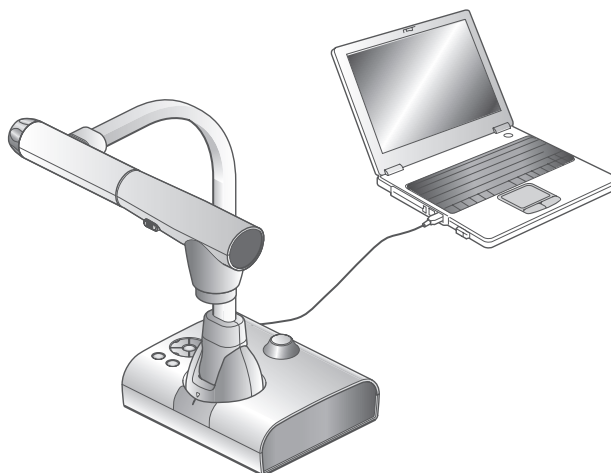

Note

- Set the [USB Mode] to [UVC] using the Preferences menu on the screen.
- The device will restart when the setting is changed. Please wait until the restart is completed.

This device supports the UVC (USB Video Class) standard. You do not need to install driver software. The video conferencing system and various applications can be used just by connecting the device to the USB port on your PC.

(Operation is not guaranteed for all applications.)

You can also use the bundled software and perform the operations described below.

- Capturing, recording (including audio), and drawing on the PC
- Controlling (zoom/focus) this device from the PC

For information on the operating requirements for the connected PC, OS types and the software guides, see the bundled software's installation manual.

If the refresh rate of the image in the bundled software appears to be slow, set the [USB Mode] to [Application]. Only the image data is sent in this mode, but the image refresh rate may be better than [UVC].

CAUTION

- Do not connect/disconnect the USB cable while operating the equipment using the operating panel or remote control. Doing so may cause a malfunction.
- We recommend using a USB 2.0-compliant USB cable.
- When the [USB Mode] is set to [Application], you can only use the device with the bundled software.
- The device restarts when the USB mode is changed. Do not turn off the power while the device is restarting.
- When you display a UVC image, it may take awhile before the image is displayed. Be sure not to turn off the power of the device or disconnect the USB cable until the image is displayed.
- When you change the resolution for UVC, it may take awhile before the image is displayed. Be sure not to turn off the power to the device or disconnect the USB cable until the image is displayed.
- The image displayed using USB only supports MJPEG. Depending on the software you are using, you may not be able to display an image.
- Some buttons on the remote control and operation panel cannot be used when the resolution for UVC is set to VGA (640×480).
- You cannot record a document camera image, display a thumbnail, or play back a still image or video, when you are displaying an image through USB.
- The image may stop for a moment if there is an abrupt change in the subject.
Setting the [Brightness] to [Manual] using the Preferences menu on the screen may solve this problem to some degree.



Note

- The USB environment used by the PC or peripheral equipment may disrupt the image transfer in some cases.
- Operation is not guaranteed for all environments.
- When the device is started, be sure to disconnect the cable before switching the USB mode using the menu.

3-4 Using this device with a wireless pen tablet or a portable IWB (both sold separately)

By using a separately sold wireless pen tablet or a portable IWB with this device, you can draw on camera images directly and record the result.

You can also directly perform such operations as zooming in/out with the device.

■ Connection with the wireless pen tablet

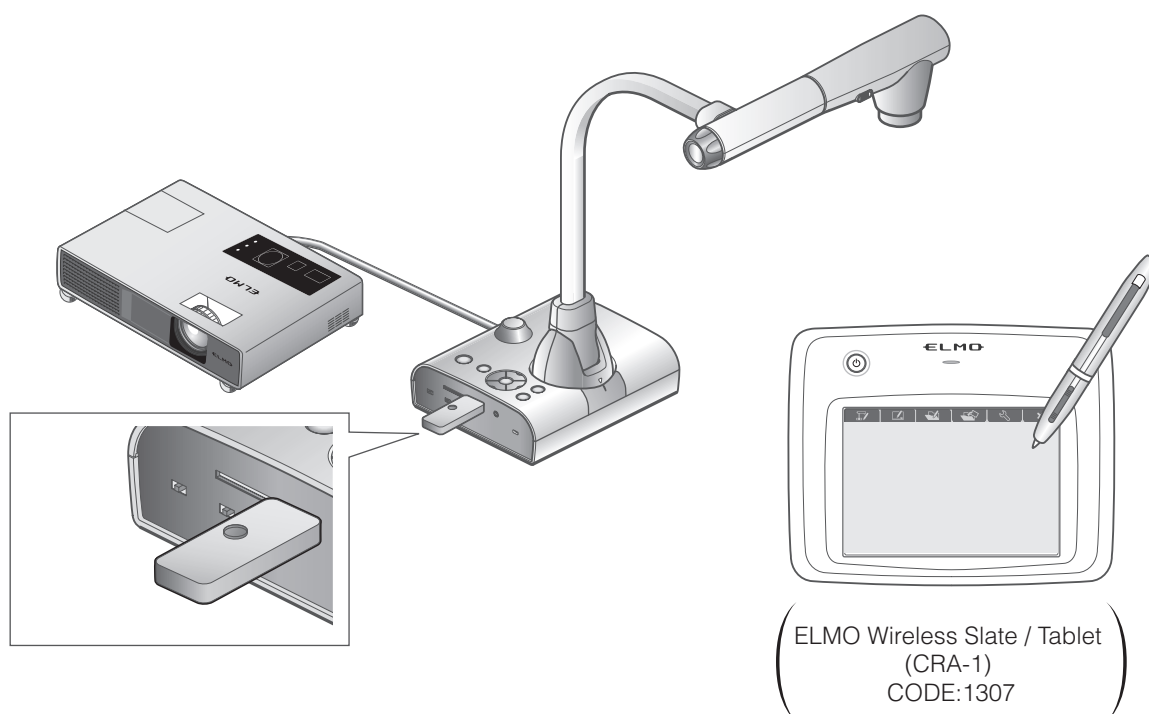

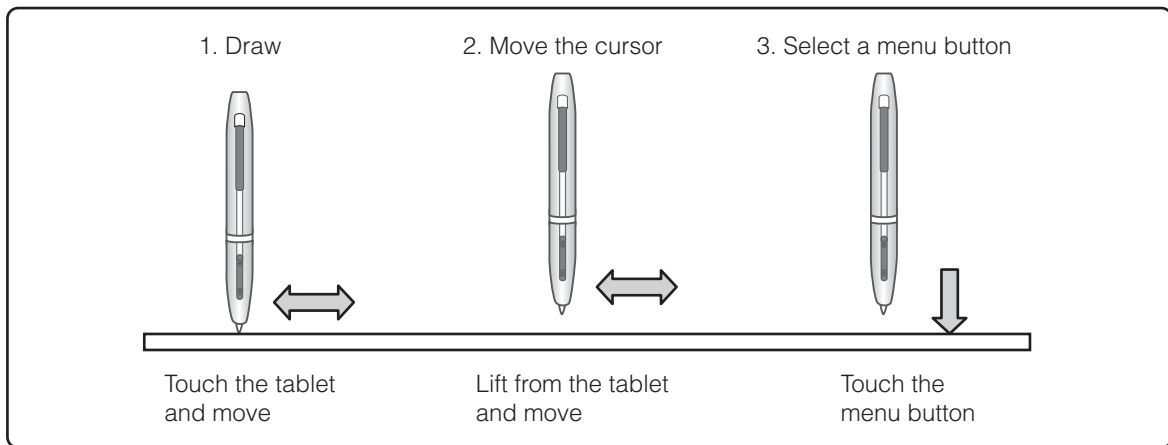

- ① Set up the device as shown in the figure above and connect to the projector, and then turn on the power.
- ② Connect the special wireless adapter (supplied with the pen tablet) to the device.
- ③ Turn on the power of the pen tablet.

Basic operations of the pen tablet



● Drawing lines

Touch the tip of the pen to the surface of the tablet and move the pen.

If [] or [] has been selected, the pen will draw a line. Use this function to draw/erase lines.

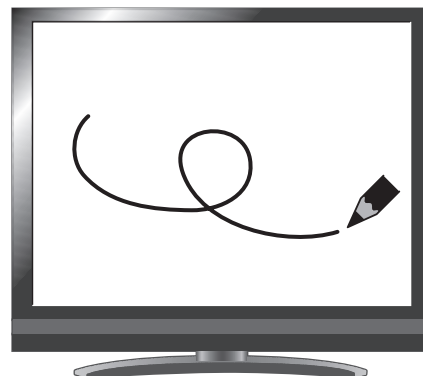

● Moving the cursor

Move the pen slightly above the surface of the tablet.

The cursor on the screen moves as the pen moves. Use this function to move the cursor.

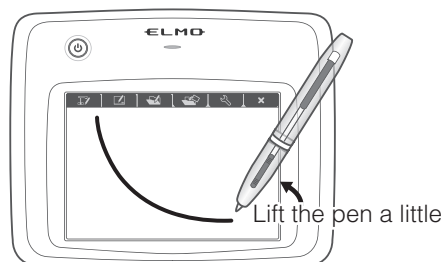

● Selecting a menu button

Move the pen slightly above the surface of the tablet to move the cursor and then touch the pen within the working area on the tablet.

Use this function to select a menu button.



CAUTION

Press the tablet lightly with the pen; do not press hard.



Note

- Hold the pen as upright as possible; holding the pen at an angle may result in a failure of the tablet to recognize the pen.
- If the pen is not used for a while, the power saving mode is activated. Touch the tip to reactivate the pen before you use it again.

The working area on the tablet corresponds to the whole screen.

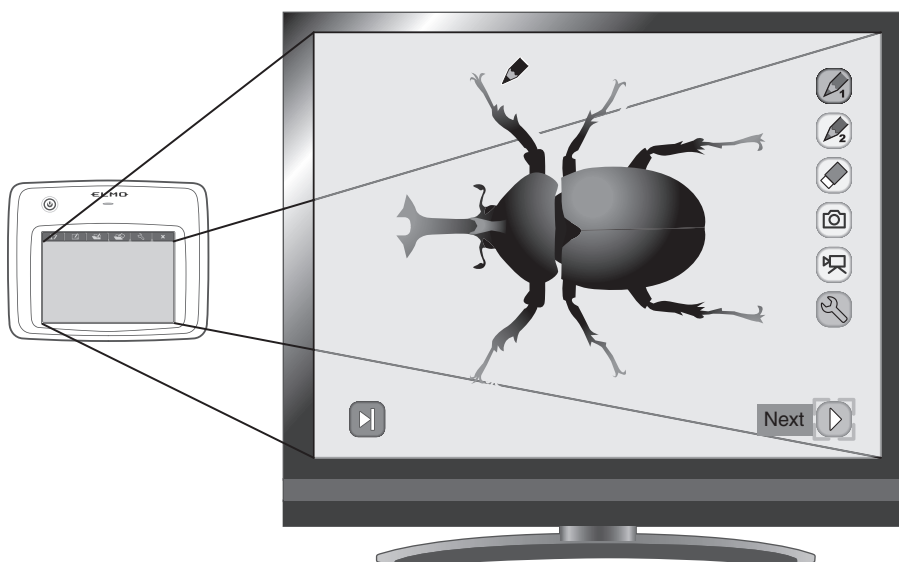

■ Selecting how to use the pen tablet from the tablet menu

To use the pen tablet, touch a function key at the top of the tablet and select a mode according to the situation described in the table below:



Icon	Name	Function
	Write to/work with camera images (Camera Mode)	Display an image on the document camera as a background, and draw on it with the pen tablet. P.65
	Write on a white screen (WB Mode)	Display a white image as a background, and draw on it using the pen tablet. P.70
	Work with/write to stored data (Play Mode)	Display images stored on the SD card. You can draw on the displayed image only when it is a still picture. You can not draw on a movie with the pen tablet. P.73
	Setting	Specify settings for the pen tablet (the settings are common to all modes).
		Change OSD menu show/hide.

■ Connection with the portable IWB

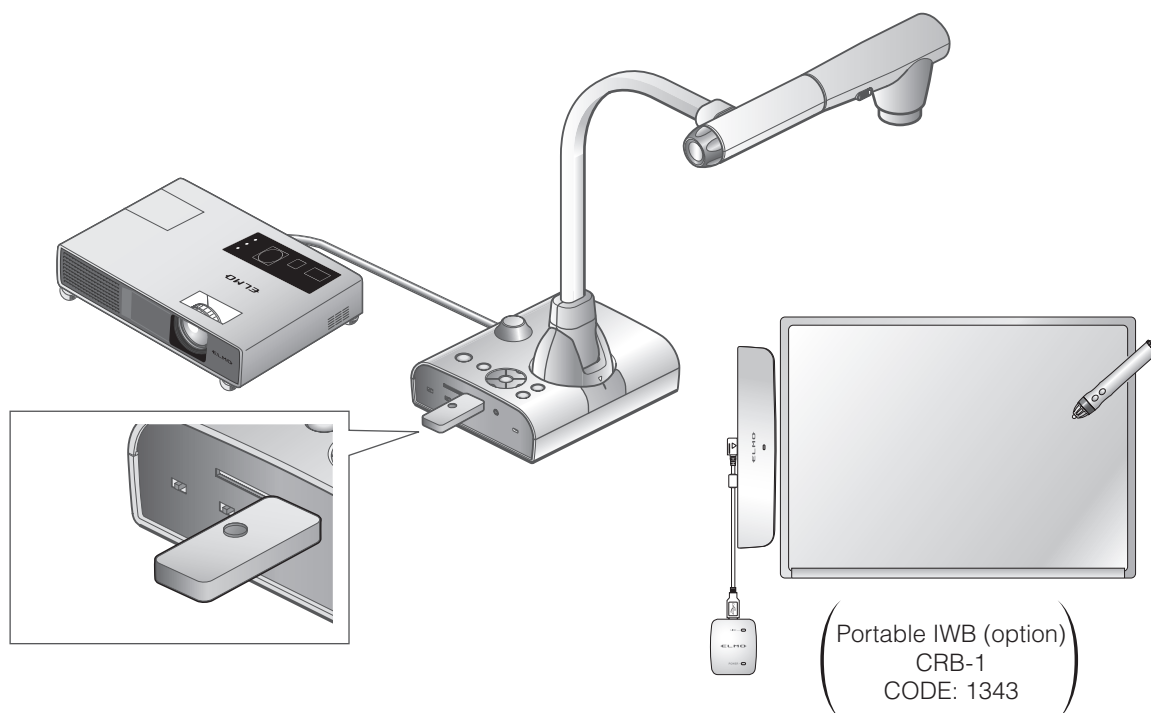

- ① Set up the device as shown in the figure above and connect to the projector, and then turn on the power.
- ② Connect the portable IWB or special wireless adapter (supplied with the IWB) to the device. For information on how to install the portable IWB, refer to the portable IWB's instruction manual.

Basic operations of the portable IWB

◆ About the Pen

- Do not cover A with your hand when holding the pen. Doing so will hinder detection of information about the pen's position.
- Write with the pen **perpendicular to the screen**. Problems occur when the pen is tilted too much.
- If "Pen Tip", "Pen Button 1" or "Pen Button 2" are pressed for 2 minutes and 30 seconds, the power to the pen will automatically turn off. You cannot write continuously for more than 2 minutes and 30 seconds.
- Do not use **rechargeable batteries** in the pen.

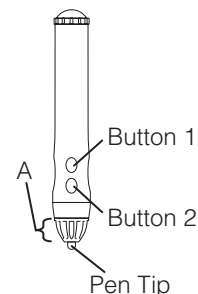

Pen Tip: Left mouse button
 Button 1: Right mouse button
 Button 2: Middle mouse button (wheel)

● Recognition of the write range (calibration)

Hold down Button 1 on the pen (three seconds or more) at the center of the portable IWB receiver (within a 2 cm radius).

You are in the Calibration mode when you hear a long beep.

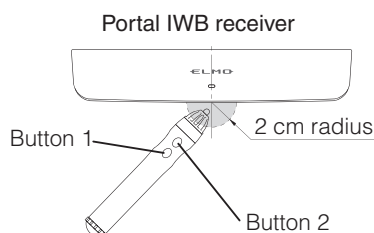

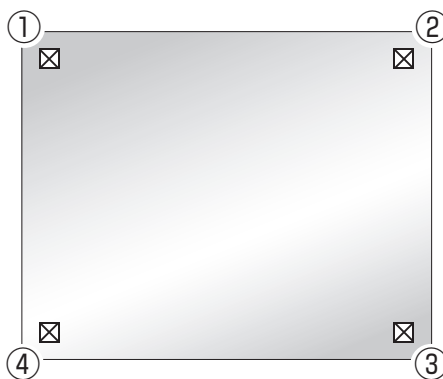

A symbol appears at the top left of the screen (① in figure below) when you enter the Calibration mode. You will hear a short beep when you touch the symbol with the tip of the pen. The symbol appears in the ① , ② , ③ , and ④ positions in this order. There will be three short beeps when you touch the last symbol, which means the calibration is completed.





- Be sure the pen is perpendicular to the screen when clicking.
- If you clicked the wrong place in relation to the cursor, hold down Button 2 on the pen (for two seconds or more), and then calibrate again.
- During the calibration, the Calibration mode is canceled automatically with two short beeps if there is no pen operation for more than 30 seconds.
- The calibration cannot be performed when the resolution is set to VGA (640 x 480).

● Drawing

Touch the pen to the portable IWB-installed whiteboard and move it. When []/[] is selected, a line is drawn along with the movement of the pen.

Use this function to draw or erase lines.

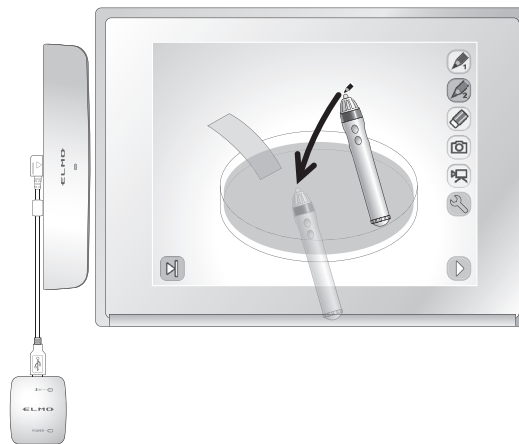

● Moving the cursor

Hold the pen slightly away from the portable IWB-installed whiteboard, and move the pen while the sound is coming out. The cursor moves on the screen along with the movement of the pen.

Use this function to move the cursor.



● Selecting a menu button

Move the cursor and touch the menu button that you want to select.

Use this function to select a menu button.

**CAUTION**

Touch the whiteboard lightly with the pen. Do not press hard on the whiteboard.

**Note**

- Holding the pen at an extreme angle may result in a failure of the whiteboard to recognize the position of the pen.
Hold the pen perpendicular to the whiteboard if possible.
- When using the portable IWB, you can select the mode to be used from Main Menu 2.
- When the resolution is set to VGA (640 x 480), you cannot see the menu or draw lines with a pen.

■ Using the pen tablet or portable IWB to draw on the camera image

You can draw on camera images.

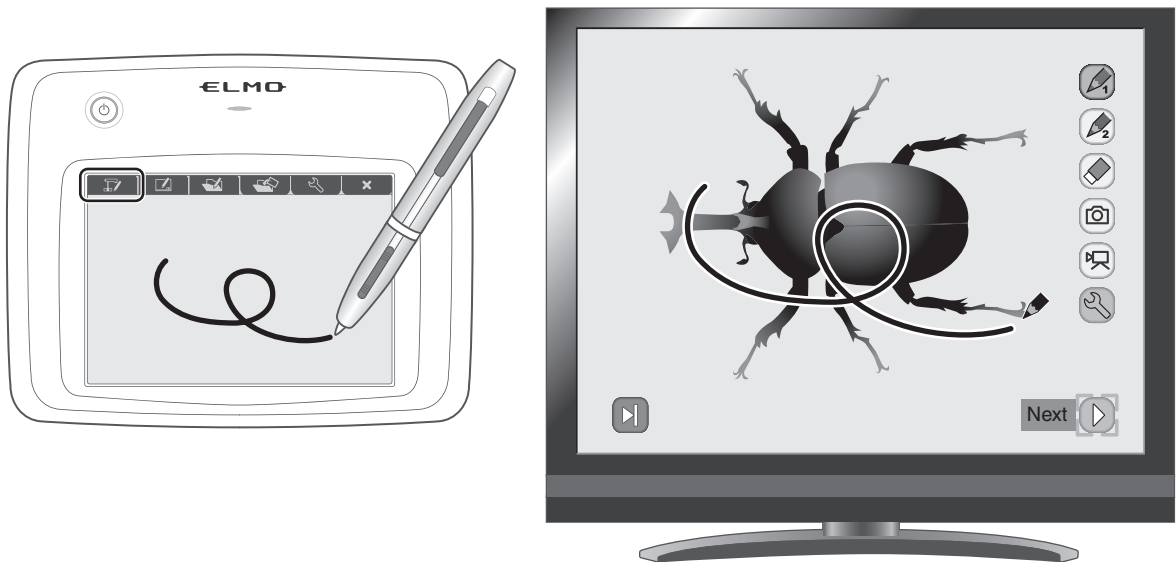





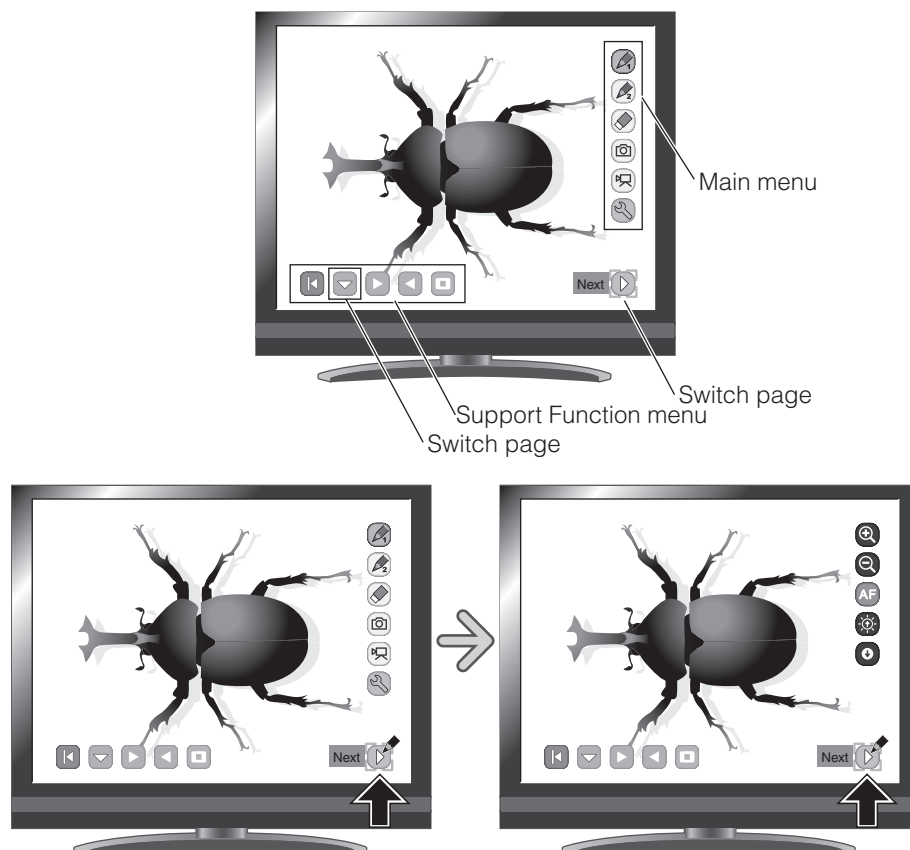

ADVANCED
OPERATIONS

Menu descriptions





Pressing [▶] or [◀] switches the menu pages.









· Main Menu 1

Icon	Name	Function
	Pen1	To select Pen1. The initial color setting is Red. You can change the settings for the pen in the Setting menu.
	Pen2	To select Pen2. The initial color setting is Black. You can change the settings for the pen in the Setting menu.
	Clear Screen	To erase anything drawn on the screen. If you need to erase a part of a drawing, move the cursor to the section to be erased, and touch the section with the pen while pressing the pen Erase button.
	Capture	To capture the image currently displayed on the screen as a picture and save it on the SD card. This feature captures only the displayed camera image and your comments/drawings; the cursor and menu icons are not captured.
	Rec	To record the image currently displayed on the screen as a movie and save it on the SD card. This does not record the lines drawn with the tablet, the menu icons, or the cursor.
	Setting	To specify the settings for Pen and Eraser.
	Next	To go to Main Menu 2.

· Main Menu 2

Icon	Name	Function
	Camera Mode	To display an image on the document camera as a background and draw on it with the pen tablet or the portable IWB. P.65
	WB Mode	To display a white image as a background and draw on it with the pen tablet or the portable IWB. P.70
	Play Mode	To display images stored on the SD card. You can draw on the displayed image with the pen tablet or the portable IWB, only when it is a still image. You cannot draw on a movie with the pen tablet or the portable IWB. P.73
	Hide	To hide the menu. (Only Main Menu 4 is displayed)
	Next	To go to Main Menu 3.













• Main Menu 3



Icon	Name	Function
	Zoom In	To enlarge the size of the camera image.
	Zoom Out	To reduce the size of the camera image.
	AF	To enable autofocus operation.
	Brighten	To brighten the camera image.
	Darken	To darken the camera image.
	Next	To go to Main Menu 1.

• Main Menu 4

























Icon	Name	Function
	Show	To show the menu.

 Setting Menu

Icon	Name	Selection Item	Default	Function
	Pen1 Color	 Red	✓	To set the pen color to red.
		 Blue		To set the pen color to blue.
		 Black		To set the pen color to black.
	Pen1 Thickness	 Thin		To decrease the pen thickness.
		 Medium	✓	To set the pen thickness to medium width.
		 Thick		To increase the pen thickness.
	Pen2 Color	 Red		To set the pen color to red.
		 Blue		To set the pen color to blue.
		 Black	✓	To set the pen color to black.

Icon	Name	Selection Item	Default	Function
	Pen2 Thickness	<input type="radio"/> Thin		To decrease the pen thickness.
		<input checked="" type="radio"/> Medium	✓	To set the pen thickness to medium width.
		<input type="radio"/> Thick		To increase the pen thickness.
	Erase Area	<input type="radio"/> Narrow		To decrease the area of partial erasure.
		<input checked="" type="radio"/> Medium	✓	To set the area of partial erasure to the medium range.
		<input type="radio"/> Wide		To increase the area of partial erasure.
	Exit			To return to the previous level of menu.

Support Function Menu

Icon	Name	Function
	Show	To show/hide the Support Function Menu.
	Hide	
	Menu	To change Support Function Menu.
	Next Picture	To move to the next picture page.
	Prev Picture	To move to the prev picture page.
	Highlight	To highlight part of the image you want to emphasize. 
	Mask	To mask part of the image. 
	Scroll	To enlarge the image to the size you specify, allowing you to move within the enlarged area. 
	Compare Picture	To display the still image captured when this icon is selected on the left, and display the camera image on the right. 
	PIP (Picture in Picture)	In Camera mode, a still image saved in the SD card is displayed at the bottom right of the screen. In Playback mode, a Camera image is displayed at the bottom right of the screen while a still image saved in the SD card is displayed. 
	Mosaic	To apply the mosaic effect to the image. 
	Marker Mask	To apply a filter to a colored area to cover it with the black marker. You can use this to temporarily hide color characters and question the students about the contents. 
	Microscope	You can use it to view images using a microscope. 
	Image Rotation	To rotate a Camera image by 180° in Camera mode. To rotate a still image saved in the SD card by 90° in Playback mode.
	Color/B&W	To output color camera images.* To output black and white camera images.*
	Posi/Nega	To output positive camera images.* To output negative camera images.*

* : Camera mode only.





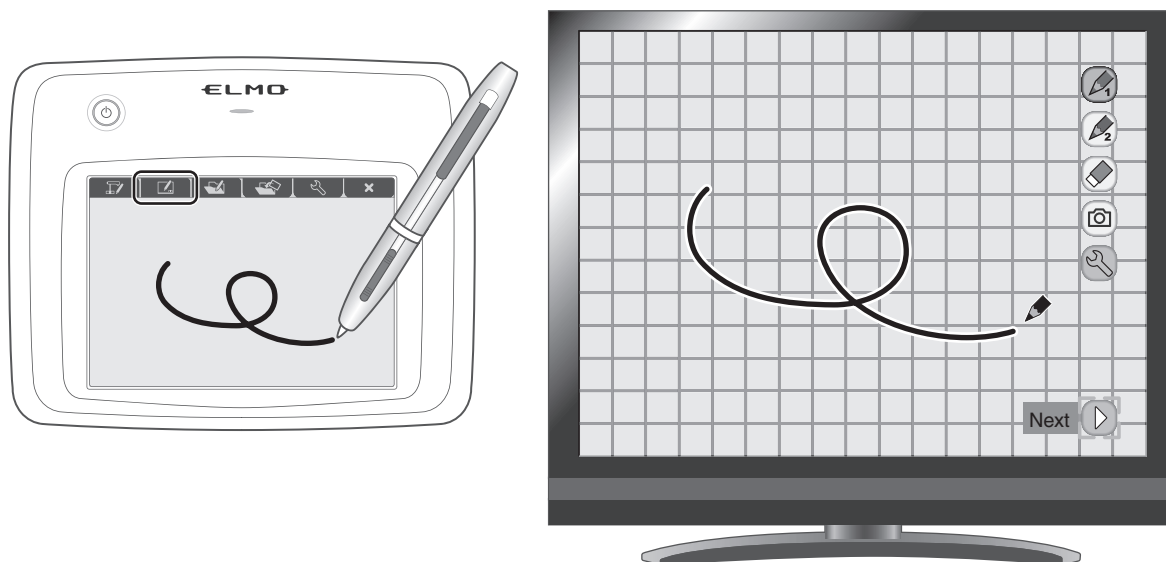

■ Using the pen tablet or portable IWB as a whiteboard

You can draw on any blank white images or areas used as a background.







Menu descriptions

Main Menu 1

Icon	Name	Function
	Pen 1	To select Pen 1. The initial color setting is Red. You can change the settings for the pen in the Setting menu.
	Pen 2	To select Pen 2. The initial color setting is Black. You can change the settings for the pen in the Setting menu.
	Clear Screen	To clear all lines drawn on the screen. To clear just a part of the screen, move the cursor to the target area, and touch that area with the pen while pressing the pen Erase button.
	Capture	To save the image currently displayed on the screen to the SD card as a still image. The camera image and the lines drawn are saved, but the menu and cursor are not saved.
	Setting	To specify the settings for Pen and Eraser.
	Next	To go to Main Menu 2.















Main Menu 2



Icon	Name	Function
	Camera Mode	To display an image on the document camera as a background and draw on it with the pen tablet or portable IWB. P.65
	WB Mode	To display a white image as a background and draw on it with the pen tablet or portable IWB. P.70
	Play Mode	To display images stored on the SD card. You can draw on the displayed image with the pen tablet or portable IWB, only when it is a still image. You cannot draw on a movie with the pen tablet or portable IWB. P.73
	Hide	To hide the menu. (Only Main Menu 3 is displayed)
	Next	To go to Main Menu 1.

Main Menu 3

Icon	Name	Function
	Show	To show the menu.

 Setting Menu

Icon	Name	Selection Item	Default	Function
	Pen 1 Color	 Red	✓	To set the pen color to red.
		 Blue		To set the pen color to blue.
		 Black		To set the pen color to black.
	Pen 1 Thickness	 Thin		To decrease the pen thickness.
		 Medium	✓	To set the pen thickness to medium width.
		 Thick		To increase the pen thickness.
	Pen 2 Color	 Red		To set the pen color to red.
		 Blue		To set the pen color to blue.
		 Black	✓	To set the pen color to black.
	Pen 2 Thickness	 Thin		To decrease the pen thickness.
		 Medium	✓	To set the pen thickness to medium width.
		 Thick		To increase the pen thickness.

Icon	Name	Selection Item	Default	Function
	Erase Area	<input type="radio"/> Narrow		To make the area of partial erasure smaller.
		<input checked="" type="radio"/> Middle	✓	To set the area of partial erasure to the medium range.
		<input type="radio"/> Wide		To increase the area of partial erasure.
	Exit			To return to the previous level of menu.

■ Using the pen tablet or portable IWB and an SD card

You can display a picture or movie stored on the SD card and use the pen tablet or portable IWB to draw or write on it.

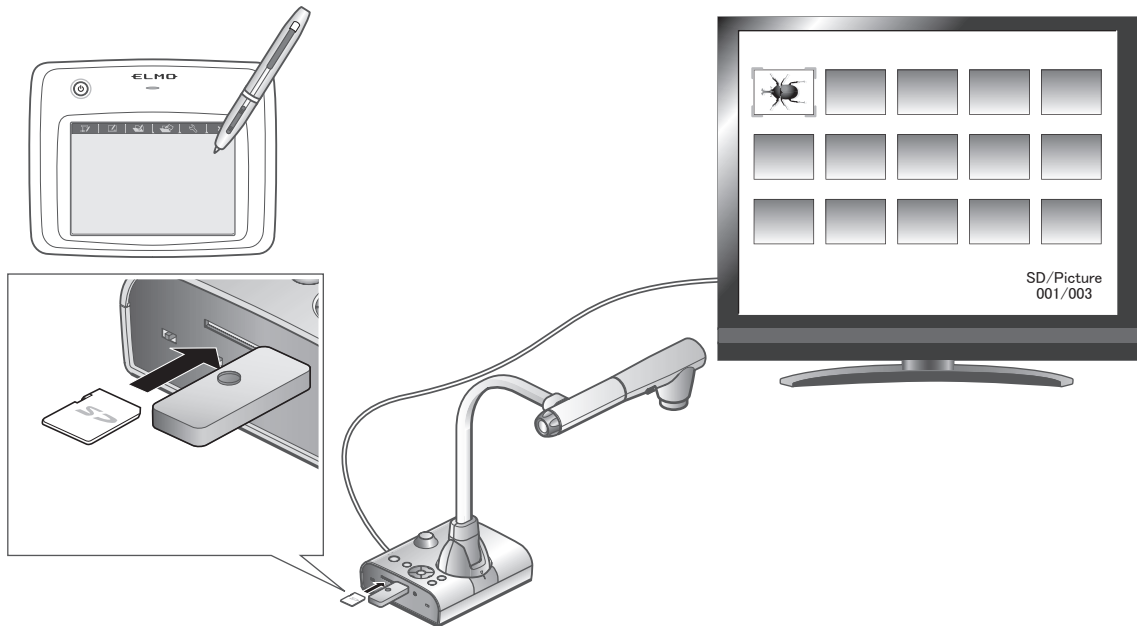



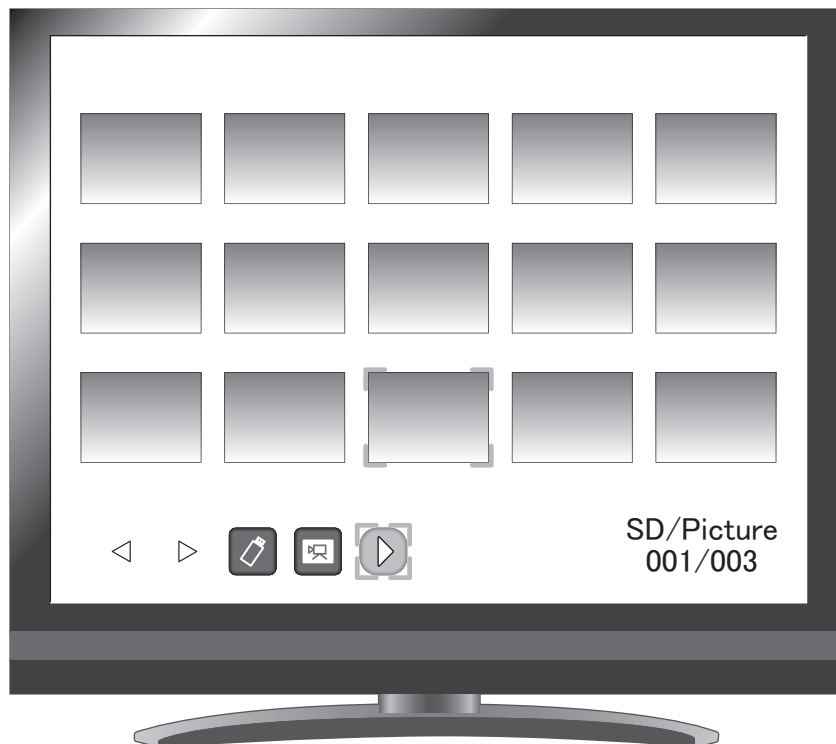



- Thumbnail display











When you select an image from the thumbnails, the selected image is displayed on the screen.

Menu descriptions

















Thumbnail Mode Menu 1

Icon	Name	Selection Item	Function
	Prev Page		To move the thumbnail to the previous page.
	Next Page		To move the thumbnail to the next page.
	USB Flash Drive		
	Movie		To switch the data displayed as thumbnails between movies and pictures.
	Picture		
	Next Menu		To go to Thumbnail Mode Menu 2.

Thumbnail Mode Menu 2

Icon	Name	Selection Item	Function
	Prev Page		To move the thumbnail to the previous page.
	Next Page		To move the thumbnail to the next page.
	Camera Mode		To display an image on the document camera as a background and draw on it with the pen tablet or portable IWB. 
	WB Mode		To display a white image as a background and draw on it with the pen tablet or portable IWB. 
	Hide		To hide the menu. (Only Thumbnail Mode Menu 4 is displayed)
	Next Menu		To go to Thumbnail Mode Menu 3.

Thumbnail Mode Menu 3







Icon	Name	Selection Item	Function
	Prev Page		To move the thumbnail to the previous page.
	Next Page		To move the thumbnail to the next page.
	Memory Lock	 Lock/Unlock	To lock (set as protected) or unlock (set as unprotected) the selected image.
		 Lock All	To lock (set as protected) all thumbnail images.
		 Unlock All	To unlock (set as unprotected) all thumbnail images.
		 Exit	To go back one layer in the menu.
	Delete	 Yes	To delete the selected image.
		 No	To cancel deletion.
		 Exit	To go back one layer in the menu.
	Format	 Yes	To format the SD card.
		 No	To cancel formatting.
		 Exit	To go back one layer in the menu.
	Next Menu		To go to Thumbnail Mode Menu 1.

Thumbnail Mode Menu 4





Icon	Name	Selection Item	Function
	Show		To show the menu.

Picture Display Menu







• Main Menu 1

Icon	Name	Function
	Pen 1	To select Pen 1. The initial color setting is Red. You can change the settings for the pen in the Setting menu.
	Pen 2	To select Pen 2. The initial color setting is Black. You can change the settings for the pen in the Setting menu.
	Clear Screen	To clear all lines drawn on the screen. To clear just a part of the screen, move the cursor to the target area, and touch that area with the pen while pressing the pen Erase button.
	Capture	To save the image currently displayed on the screen to the SD card as a still image. The camera image and the lines drawn are saved, but the menu and cursor are not saved.
	Setting	To specify the settings for Pen and Eraser.
	Next	To go to Main Menu 2.

• Main Menu 2

Icon	Name	Function
	Camera Mode	To display an image on the document camera as a background and draw on it with the pen tablet or portable IWB. P.65
	WB Mode	To display a white image as a background and draw on it with the pen tablet or portable IWB. P.70
	Play Mode	To display images stored on the SD card. You can draw on the displayed image with the pen tablet or portable IWB, only when it is a still image. You cannot draw on a movie with the pen tablet or portable IWB. P.73
	Hide	To hide the menu. (Only Main Menu 4 is displayed)
	Next	To go to Main Menu 3.

















• Main Menu 3



Icon	Name	Selection Item	Function
	Delete	 Yes	To delete the displayed image. (You cannot delete locked images.)
		 No	To cancel deletion.
		 Exit	To go back one layer in the menu.
	Memory Lock		To lock (set as protected) or unlock (set as unprotected) the selected image.
	Next Menu		To go to Main Menu 1.

• Main Menu 4

Icon	Name	Function
	Show	To show the menu.







 Setting Menu (when Setting Menu is selected)

Icon	Name	Selection Item	Default	Function
	Pen 1 Color	 Red	✓	To set the pen color to red.
		 Blue		To set the pen color to blue.
		 Black		To set the pen color to black.
	Pen 1 Thickness	 Thin		To decrease the pen thickness.
		 Medium	✓	To set the pen thickness to medium width.
		 Thick		To increase the pen thickness.
	Pen 2 Color	 Red		To set the pen color to red.
		 Blue		To set the pen color to blue.
		 Black	✓	To set the pen color to black.
	Pen 2 Thickness	 Thin		To decrease the pen thickness.
		 Medium	✓	To set the pen thickness to medium width.
		 Thick		To increase the pen thickness.







Icon	Name	Selection Item	Default	Function
	Erase Area	<input type="radio"/> Narrow		To decrease the area of partial erasure.
		<input checked="" type="radio"/> Medium	✓	To set the area of partial erasure to the medium range.
		<input type="radio"/> Wide		To increase the area of partial erasure.
	Exit			To return to the previous level of menu.

Movie Play Menu







• Movie Play Menu 1

Icon	Name	Function
	Show	To show or hide Movie Play Menu 1.
	Hide	
	Menu	To go to Movie Play Menu 2.
	Play	To play, pause, or cue the movie.
	Pause	
	Cueing	

• Movie Play Menu 2

Icon	Name	Function
	Show	To show or hide Movie Play Menu 2.
	Hide	
	Menu	To go to Movie Play Menu 3.
	Camera Mode	To display an image on the document camera as a background and draw on it with the pen tablet or portable IWB. P.65
	WB Mode	To display a white image as a background and draw on it with the pen tablet or portable IWB. P.70
	Play Mode	To display images stored on the SD card. You can draw on the displayed image with the pen tablet or portable IWB, only when it is a still image. You cannot draw on a movie with the pen tablet or portable IWB. P.73

• Movie Play Menu 3

Icon	Name	Function
	Show	To show or hide Movie Play Menu 3.
	Hide	
	Menu	To go to Movie Play Menu 1.
	Up	To set the audio output volume.
	Down	
	Repeat On	To repeat the playback of movies.
	Repeat Off	

3-5 Displaying enlarged images using a microscope

By attaching the separately sold microscope attachment lens to a microscope, you can display the enlarged image through the document camera lens.

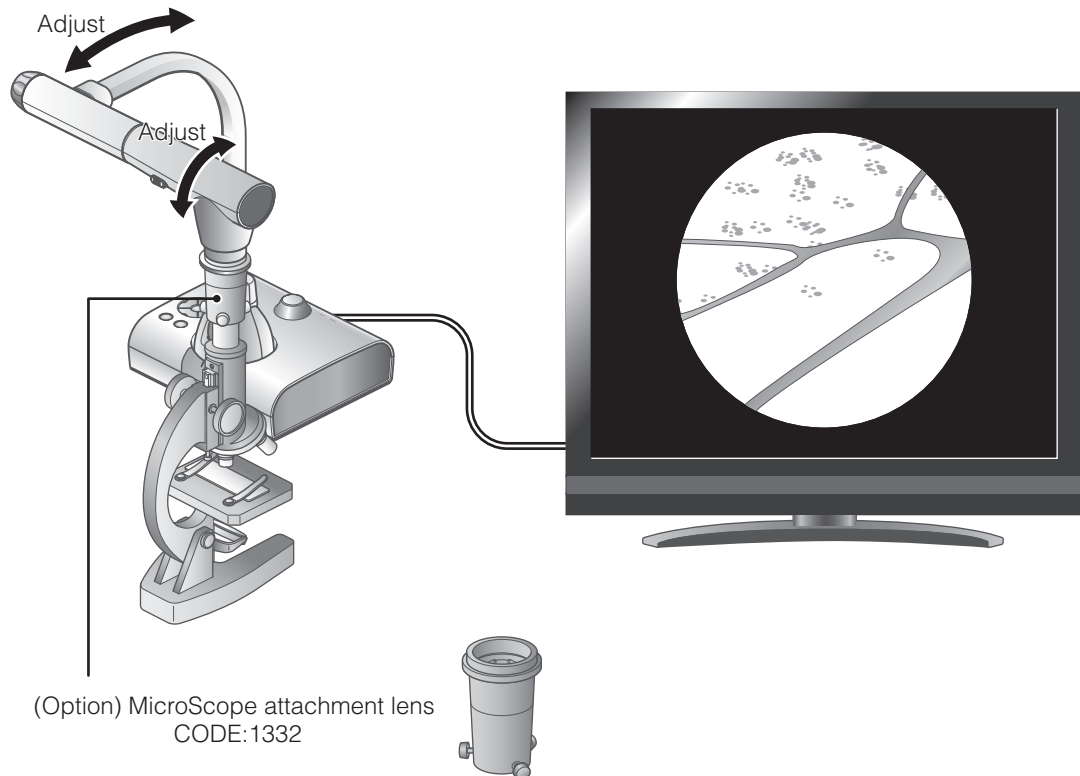

Procedure

- 1 Change the setting of this equipment for using a microscope.

Press the [] button.



Press [].

- 2 Set the microscope.

Place the object you want to view, such as a prepared slide, on the microscope and then look into the microscope to adjust the focus and brightness.

③ Attach the microscope attachment lens.

- Attach the guide ring to the microscope attachment lens and cover the eyepiece with it.

Set the microscope attachment lens

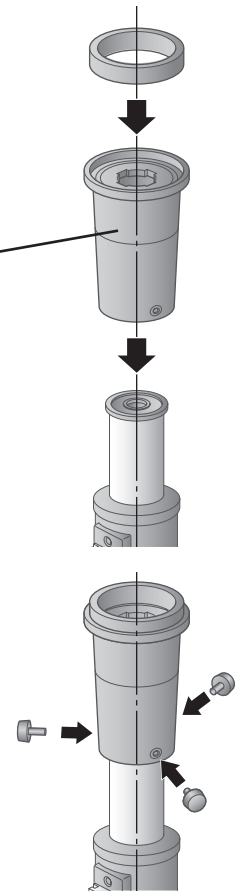

- Match the centers of the microscope attachment lens and eyepiece, and use the three screws to evenly tighten the lenses against each other.

CAUTION

If the screws are screwed too tightly, the microscope eyepiece or tube may be damaged.

The screws may leave scratches where they come in contact with the microscope.

Taping the microscope before attaching it may alleviate this problem.

④ Adjust the angle of the microscope and the equipment to fit each other.

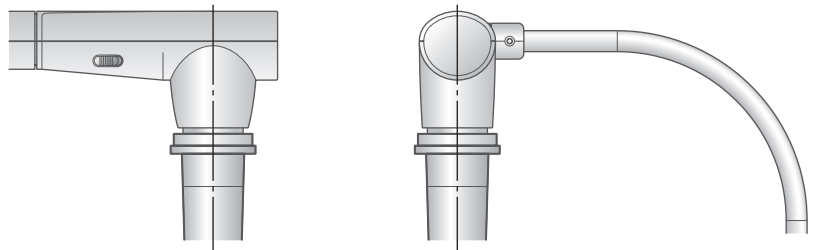

⑤ Adjust the brightness.

Adjust the brightness with the mirror or the light on the microscope.

⑥ Adjust the display range.



Adjust the display range.

⑦ Focus a camera.

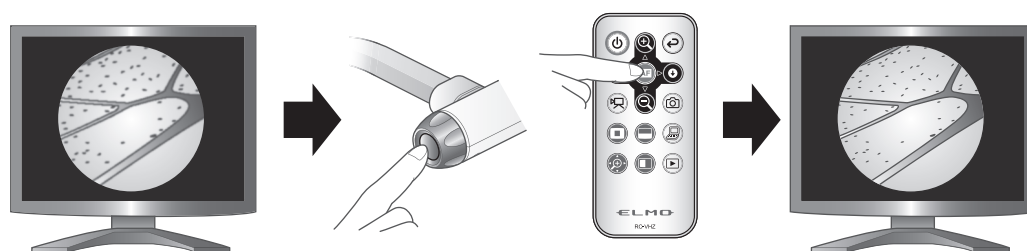

Focus a camera.

■ Exiting the Microscope mode

Change the setting of the equipment.

Press the [MENU] button.



Press [].



Note



- Depending on the type of eyepiece, you may not be able to view the object clearly even after adjusting the zoom.
- We recommend using a WF type eyepiece. If you do not use a WF type, we recommend using an eyepiece of 10x or less.
- Adjust the focus manually when it is hard to focus automatically. P.82
- You can use the microscope attachment lens when the external diameter of the eyepiece is 20 to 28mm.
- Use the thinner guide ring for Microscope Lens Attachment. There are two types of rings included in the package; the thicker one is not used here.

4

TROUBLE SHOOTING

4-1 Symptoms and Confirmation

Check the following items. If any abnormality is found, consult the dealer from whom you purchased this product or our nearest branch/office.

Symptom	Possible cause/remedy
No image is displayed.	<ul style="list-style-type: none"> • The cable is not correctly connected. • The AC adapter is disconnected from the wall outlet. • The AC adapter is disconnected from the power supply socket of the unit. • The power is not ON. (Blue light) • Zoom is set at the TELE side, displaying only the white/black part of the document. • If you turn the power ON immediately after turning it OFF, the unit may not start. Wait for several seconds after turning the power OFF, and then turn it back ON. • The slide switch is not set to the correct image output (RGB or HDMI). Set the "RGB/HDMI Switch" correctly. <p>P.10</p> <ul style="list-style-type: none"> • Reconnect the AC adapter.
The output image (resolution) changes automatically.	<ul style="list-style-type: none"> • When the HDMI monitor is connected, the output image (resolution) is automatically changed based on information from the connected monitor.
No image is displayed from the USB.	<ul style="list-style-type: none"> • No image is output from USB, when USB mode is set to mass Storage or in Play mode or in Recording mode or when using the Compare Picture Function or the PIP Function. Switch the USB mode from Mass Storage to Application by referring to the "Function Setting Menu". When using Play mode, change the output image to Camera image.
The image is out of focus.	<ul style="list-style-type: none"> • The document (object) is too close to the lens. Move the document (object) slightly away from the lens. • Auto focus may have difficulty in adjusting correctly. Focus on an image manually by referring to "Manual focus".
The image is too dark.	<ul style="list-style-type: none"> • The intensity of the lighting is insufficient. Press the [] button on the operating panel or the [] button on the remote control to adjust the brightness.

Symptom	Possible cause/remedy
The image is striped.	<ul style="list-style-type: none"> • This may be interference fringes between dots of printed matter and TV scanning lines or CMOS pixels. Changing the shooting range may help the problem. • Vertical stripes may appear on an LCD projector image. Manually adjusting the dot clock at the projector side may help the problem.
Images on the SD card/USB flash drive are not displayed.	<ul style="list-style-type: none"> • Remove the SD card/USB flash drive, wait a few seconds and reinsert.
The image does not move.	<ul style="list-style-type: none"> • Camera image is set to [Pause]. Press the Pause button on the operating panel again to restart.
The remote control does not work.	<ul style="list-style-type: none"> • Battery power is low. Replace the batteries with new ones. • The incorrect remote control is being used. Use the supplied remote control.
After inserting the SD card/USB flash drive, operations cannot be performed.	<ul style="list-style-type: none"> • The SD card/USB flash drive is not being read correctly. Use the SD card/USB flash drive after formatting it twice as described below. First, format the card using a computer. Second, format the card using the main unit.
Drawing speed of the tablet is too slow.	<ul style="list-style-type: none"> • Drawing speed may become slow depending on the resolution setting of the unit. This is not a malfunction.
UVC image is upside down	<ul style="list-style-type: none"> • Check that the graphics driver and other device drivers on your PC are updated. The latest device drivers are available from the PC manufacturer.
The displayed UVC image contains images other than the camera image	<ul style="list-style-type: none"> • The software and OS you are using or the connection status may be causing images other than the camera image to break through while displaying the camera image. This problem can be solved by reconnecting the device or restarting the software.
A software error message appears and the UVC image is not displayed	<ul style="list-style-type: none"> • If it is taking too much time for the preparation of the image output, the software may determine this to be an error. Restart the device, reconnect it to the PC, and then start the software.
The UVC image/audio fails to be output	<ul style="list-style-type: none"> • Disconnect the USB cable, restart the software, and then connect the USB cable again. • If UVC image/audio still fails to be output after restarting, contact the software vendor and ask if the software you are using supports MJPEG.

Symptom	Possible cause/remedy
Some buttons on the remote control and operation panel cannot be used in the USB mode (UVC)	<ul style="list-style-type: none"> Some buttons on the remote control and operation panel cannot be used when the USB mode is set to UVC and the resolution is set to VGA (640×480). Also, you cannot record a camera image, display a thumbnail, or play back a still image/video while there is a UVC image/audio output.
The UVC image stops for a moment	<ul style="list-style-type: none"> The image may stop for a moment if there is an abrupt change in the subject. If the [Brightness] in the Preferences menu on the screen is set to [Auto], change the setting to [Manual]. Doing so may solve the problem to some degree.
Operation is disabled during calibration	<ul style="list-style-type: none"> The image switches to the camera image when you disconnect the wireless adapter. Start the calibration again after the image switches to the camera image.
When the portable IWB and the device are connected: <ul style="list-style-type: none"> Lines cannot be drawn The menu cannot be displayed The symbols are not displayed on the screen after the calibration 	<ul style="list-style-type: none"> If you performed the calibration with the resolution set to VGA (640 x 480), then the symbols for the calibration mode are not displayed. Also, you cannot see the menu or draw lines with a pen. If this is the case, do not perform any operation for a while or disconnect the special wireless adapter (supplied with the portable IWB) that is connected to this device. The calibration will be canceled, allowing you to perform an operation. When using this device as a portable IWB, set the device resolution to XGA (1024 x 768), WXGA (1280 x 800), SXGA (1280 x 1024), 720P (1280 x 720), or 1080P (1920×1080).

About the light (LED lighting)

- The brightness of the light will diminish with long-term use. If its brightness has significantly diminished, consult the dealer from whom you purchased this product or our nearest branch/office for replacement.

About long-term usage of this product

- Due to the lifetime of its parts, if this product is used for longer than the warranty period, its performance and quality may deteriorate. In this case, we will replace the parts for a charge. Consult the dealer from whom you purchased this product or our nearest branch/office.

5 SPECIFICATIONS

5-1 General

Item	Specifications
Power source	12VDC (AC adapter AC100 - 240V)
Power consumption	16.2W
Outside dimensions	W355 x D373.5 x H426.5mm (W14.0 x D14.7 x H16.8 in) (When setup)
	W195 x D294 x H469mm (W7.7 x D11.6 x H18.5 in) (When folded)
Weight	Approx. 3kg (6.6 lbs) (Main body only)
Input selection	Main/External x 2
Output terminal	RGB output Mini Dsub 15P connector, female x 1
	HDMI output terminal x 1
	Line Out terminal ϕ 3.5mm stereo minijack x 1
Input terminal	RGB input Mini Dsub 15P connector, female x 1
	HDMI input terminal x 1
	Mic In/Line Out terminal (shared) ϕ 3.5mm stereo minijack x 1
Ext. control terminal	USB device (2.0 compliant) Mini-B receptacle x 1
Memory	SD card slot x 1
Interface	USB host (2.0 compliant) Type A receptacle x 1

• Line input

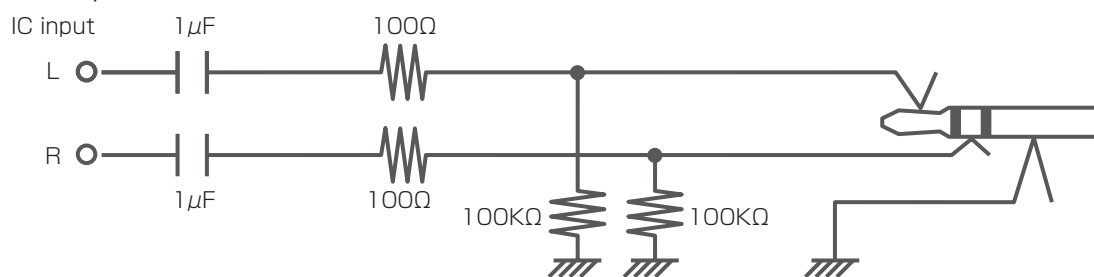

• External mike input

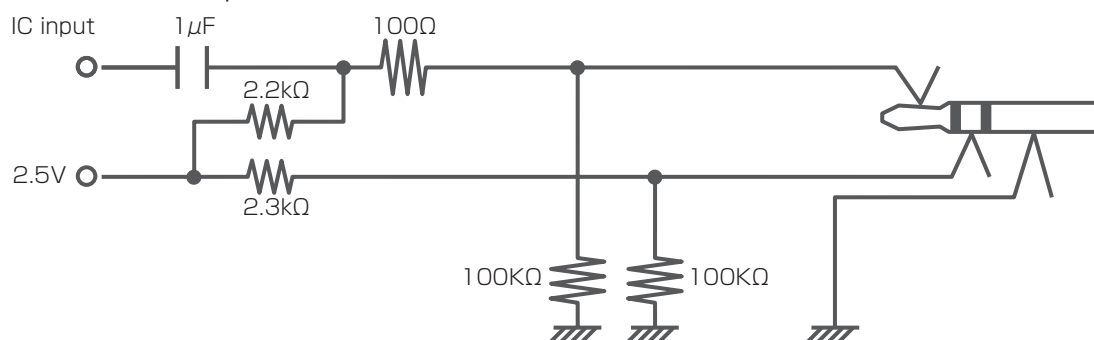

5-2 Main Camera

Item	Specifications				
Lens	f = 4.0mm – 48.0mm (12x zoom) F3.2 – 3.6				
Frame rate	30fps				
Shooting area		Max.		Min.	
	1080p	420mm	x 233mm	48.5mm	x 27.5mm
	720p	420mm	x 233mm	48.5mm	x 27.5mm
	SXGA	420mm	x 334mm	48.5mm	x 38.5mm
	WXGA	420mm	x 259mm	48.5mm	x 30.5mm
XGA	420mm	x 313mm	48.5mm	x 36.5mm	
Limit of focus adjustment	From lens surface: 50mm (2.0 in) – ∞ (f=4.0mm – 23.4mm) 200mm (7.9 in x) – ∞ (f=23.4mm and higher)				
Optical zoom	12X				
Digital zoom	8X				
Focus	Auto/Manual/Zoom Sync				
Image pick-up element	1/2.8" CMOS				
Total pixels	Horizontal 2144, Vertical 1588				
Effective pixels	Horizontal 1920, Vertical 1536				
Synchronized signal	Internal				
Resolution	Analog RGB Horizontal 800TV lines or more Vertical 800TV lines or more				
Analog RGB output	Analog RGB output 0.7 V (p-p) 75 Ω unbalanced Synchronized signal		SXGA: 1280x1024@60Hz Horizontal frequency: 63.981kHz Vertical frequency: 60.020Hz WXGA: 1280x800@60Hz Horizontal frequency: 49.306kHz Vertical frequency: 59.910Hz XGA: 1024x768@60Hz Horizontal frequency: 48.363kHz Vertical frequency: 60.004Hz 1080p: 1920x1080@60Hz Horizontal frequency: 67.50kHz Vertical frequency: 60.00Hz 720p: 1280x720@60Hz Horizontal frequency: 45.00kHz Vertical frequency: 60.00Hz		

Item	Specifications
HDMI output	Image output 1080p 720p
	Audio output PCM 44.1kHz sampling frequency
White Balance	Auto/One-Push/Manual
Brightness Control	Auto (W/Level adjustment)/Manual
Posi/Nega conversion	Provided
Color/B&W selection	Provided
Image rotation	Provided (0°/180°)
Image Mode	Text1/Text2/Text3/ Graphics1/Graphics2
Gamma setting	Provided (Only for graphic mode 1)
Edge Effect	Provided (Only for graphic mode 1)
Pause	Provided
Still Image storage	Provided
Movie storage	Provided
Flicker connection	60Hz/50Hz

5-3 Illumination Device

Item	Specifications
Illumination light	White LED

5-4 Trademarks · License

ELMO is a registered trademark of ELMO Co., Ltd.

SD, **SD** are the registered trademarks of SD-3C, LLC respectively.

HDMI, High-Definition Multimedia Interface are the registered trademarks of HDMI Licensing LLC.

This product is based on the work of the Independent JPEG Group.

All other company/product names described in this manual are trademarks or registered trademarks of their respective companies.

This product is licensed under the AVC Visual Patent Portfolio License (AVC Video), for the personal and a non-commercial use of a consumer to

- (i) Play AVC Video that was recorded by a consumer engaged in a personal and a non-commercial activity and/or,
- (ii) Play AVC Video that was obtained from a video provider licensed from MPEG-LA and LLC

and it admitted to use only in personal and a non-commercial purpose.

- When you play AVC Video recorded by the personal and non-commercial purpose.
- When you play AVC Video offered by the provider licensed from MPEG-LA, LLC to provide AVC Video.

Additional information including that relating to promotional and commercial uses may be obtained from MPEG-LA, LLC.

WARNING

Unauthorized recording of copyrighted slide films, materials, photographs, etc. may infringe on the rights of copyright owners and be contrary to copyright laws.

Document Camera Controller Software Image Mate Installation Manual

The content of this manual is subject to change without prior notice.
This manual does not grant any license to use industrial property right or warrant any other rights.
Any reproduction or duplication of the content of this manual without ELMO's consent is expressly prohibited.

Caution

- When the image select of the device is set to SD Mode, Image Mate cannot be used to control the device.
 - When USB Mode of the device is set to Mass Storage, Image Mate cannot be used to control the device.
- For more details, see the manual supplied with the device.

Notes when using the CD

- Make sure JavaScript is on.
 - Install Adobe Flash Player and Adobe Acrobat Reader.
- If the operational environment is not appropriate, some functions may not operate properly or some pages may not display correctly.

Installation for Windows OS

■System Requirements

The following requirements must be met by your computer to use Image Mate.

Document Camera	L-12iD/TT-12iD, L-12i/TT-12i, L-12/TT-12, L-1ex/TT-02RX, MO-1/MO-1w, P100HD, P30HD, P10
OS	Windows 8.1, Windows 8, Windows 7, Windows Vista, Windows XP SP3 64-bit versions supported (excluding Windows XP 64-bit version)
CPU	Intel Core 2 Duo or equivalent or better
Memory	Main memory 2GB or more
Hard Disk	1GB or more
Display Resolution	1024 x 768 pixels or more Approximately 16.7 million colors
USB	Built-in USB port (Hi-Speed recommended)

Caution  If a sound device cannot be used, some of the functions may not operate.

■Installing Image Mate

1. Login as an administrator, and then insert the CD-ROM into the computer.
2. Launcher menu is displayed.
(If the installation program does not start, double click the file " Win/startup.exe " on the CD-ROM.)
3. Select the appropriate language, run Image Mate install, and then follow the instructions on the screen to install the program.

■Uninstalling Image Mate

1. Login as an administrator.
2. From the Start menu, select ELMO, Image Mate, and then click Uninstall.
3. The uninstallation program is launched. Follow the instructions on the screen to uninstall Image Mate.

Caution  A driver needs to be installed when using Image Mate with the following models :
P10

※For L-12i/TT-12i, no driver installation is needed.

Run "Document Camera Driver Install" from the launcher menu and follow the instructions on the screen to install the driver for above models.

Installation for Mac OS X

■System Requirements

The following requirements must be met by your computer to use Image Mate.

Document Camera	L-12iD/TT-12iD, L-12i/TT-12i, L-12/TT-12, L-1ex/TT-02RX, MO-1/MO-1w, P100HD, P30HD, P10
OS	Mac OS X 10.6.8 – 10.9.x
CPU	Intel Core 2 Duo or equivalent or better
Memory	Memory 1GB or more
Hard Disk	1GB or more
Display Resolution	1024 x 768 pixels or more Approximately 16.7 million colors
USB	Built-in USB port (Hi-Speed recommended)
Software	QuickTime Player 10.0

Caution  If a sound device cannot be used, some of the functions may not operate.

■Installing Image Mate

1. Login as an administrator, and then insert the CD-ROM into the computer.
2. From the Mac folder in the root folder of the CD-ROM, double click the file "ImageMate.pkg".
3. The installation program is launched. Follow the instructions on the screen to install the program.

Disclaimer

- The content of this manual, and Image Mate are subject to change without prior notice.
- Our software may not function as intended due to compatibility issues with the hardware and existing software.
- ELMO CO., LTD. cannot be held responsible for either direct or indirect damages suffered by users while using our software.