

ELMO

Touchboards

205 Westwood Ave, Long Branch, NJ 07740

Phone: 866-94 BOARDS (26273) / (732)-222-1511

Fax: (732)-222-7088 | E-mail: sales@touchboards.com

BOXi T-200
MOBILE PROJECTOR

Instruction Manual

English

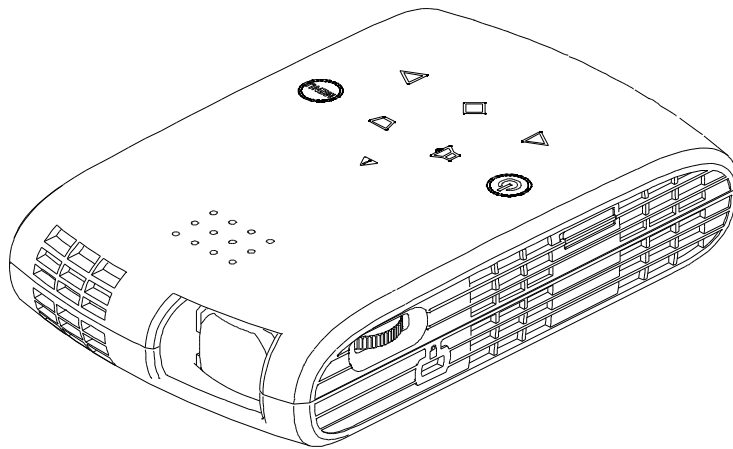

- Read the separate “IMPORTANT SAFEGUARD” carefully before using the projector.
- Keep this guide in a safe place for future reference.

IMPORTANT SAFEGUARDS

■ Read Instructions

All the safety and operating instructions should be read before the appliance is operated.

■ Retain Instructions

The safety and operating instructions should be retained for future reference.

■ Heed Warnings

All warnings on the product and in the operating instructions should be adhered to.

■ Follow Instructions

All operating and use instructions should be followed.

■ Cleaning

Unplug this product from the power source before cleaning. Do not use liquid cleaners or aerosol cleaners. Use a damp cloth for cleaning.

■ Attachments

Do not use attachments not recommended by the product manufacturer as they may cause hazards.

■ Water and Moisture

Do not use this product near water - for example, near a bath tub, wash bowl, kitchen sink, or laundry tub, in a wet basement, or near a swimming pool, and the like.

■ Placement

Do not place this product on an unstable cart, stand, tripod, bracket, or table. The product may fall, causing serious injury to a child or adult, and serious damage to the product. Use only with a cart, stand, tripod, bracket, or table recommended by the manufacturer, or sold with the product.

Any mounting of the product should follow the manufacturer's instructions, and should use a mounting accessory recommended by the manufacturer.

■ Ventilation

Slots and openings in the cabinet are provided for ventilation and to ensure reliable operation of the product and to protect it from overheating, and these openings must not be blocked or covered.

The openings should never be blocked by placing the product on a bed, sofa, rug, or other similar surface. This product should not be placed in a built-in installation such as a bookcase or rack unless proper ventilation is provided or the manufacturer's instructions have been adhered to.

■ Power Sources

This product should be operated only from the type of power source indicated on the marking label. If you are not sure of the type of power supply to your home consult your appliance dealer or local power company. For products intended to operate from battery power, or other sources, refer to the operating instructions.

■ Grounding or Polarization

This product may be equipped with either a polarized 2-wire AC line plug (a plug having one blade wider than the other) or a 3-wire grounding type plug, a plug having a third (grounding) pin.

If the 2-wire polarized plug fails to fit in the outlet socket, try reversing the plug". If the plug still fails to fit, contact your electrician to replace your obsolete outlet. For safety reasons do not force the polarized plug into the outlet socket. The 3-wire grounding type plug will fit into a grounding type power outlet socket. This is a safety feature. If you are unable to insert the plug into the outlet socket, contact your electrician to replace your obsolete outlet socket. For safety reasons do not force the grounding type plug into the outlet socket.

■ Power-Cord Protection

Power-supply cords should be routed so that they are not walked on or pinched by items placed upon or against them. Pay particular attention to cords and plugs, convenience receptacles, and the point where they exit from the product.

■ Lightning

For added protection for this product during a lightning storm, or when it is left unattended and unused for long periods of time, unplug it from the wall outlet and disconnect the antenna or cable system. This will prevent damage to the product due to lightning and power-line surges.

■ Overloading

Do not overload wall outlets, extension cords, or integral convenience receptacles as this can result in a risk of fire or electric shock.

■ A product and cart combination should be moved with care.

Quick stops, excessive force, and uneven surfaces may cause the product and cart combination to overturn.



■ Object and Liquid Entry

Never push objects of any kind into this product through openings as they may touch dangerous voltage points or short-out parts that could result in a fire or electric shock. Never spill liquid of any kind on the product.

■ Servicing

Do not attempt to service this product yourself as opening or removing covers may expose you to dangerous voltage or other hazards. Refer all servicing to qualified service personnel.

■ Damage Requiring Service

Unplug this product from the wall outlet and refer servicing to qualified service personnel under the following conditions:

- When the power-supply cord or plug is damaged.
- If liquid has been spilled, or objects have fallen into the product.
- If the product has been exposed to rain or water.
- If the product does not operate normally by following the operating instructions. Adjust only those controls that are covered by the operating instructions as improper adjustment of other controls may result in damage and may require extensive work by a qualified technician to restore the product to its normal operation.
- If the product has been dropped or damaged in any way.
- When the product exhibits a distinct change in performance - this indicates a need for service.

■ Replacement Parts

When replacement parts are required, be sure the service technician has used replacement parts specified by the manufacturer or have the same characteristics as the original part. Unauthorized substitutions may result in fire, electric shock or other hazards.

■ Safety Check

Upon completion of any service or repairs to this product, ask the service technician to perform safety checks to determine that the product is in proper operating condition.

■ Heat

The product should be situated away from heat sources such as radiators, heat registers, stoves, or other products (including amplifiers) that produce heat.



CAUTION

**RISK OF
ELECTRIC SHOCK
DO NOT OPEN**



**CAUTION:
TO REDUCE THE RISK OF
ELECTRIC SHOCK, DO NOT
REMOVE COVER (OR BACK).
NO USER-SERVICEABLE
PARTS INSIDE.
REFER SERVICING TO
QUALIFIED SERVICE
PERSONNEL.**



SA 1965

The lightning flash with arrowhead symbol, within an equilateral triangle, is intended to alert the user to the presence of uninsulated “dangerous voltage” within the product’s enclosure that may be of sufficient magnitude to constitute a risk of electric shock to persons.



SA 1966

The exclamation mark within an equilateral triangle is intended to alert the user to the presence of important operating and maintenance (servicing) instructions in the literature accompanying the product.

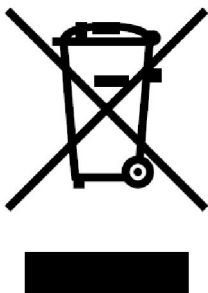

This symbol [crossed-out wheeled bin WEEE Annex IV] indicates separate collection of waste electrical and electronic equipment in the EU countries.
Please do not throw the equipment into the domestic refuse.
Please use the return and collection systems available in your country for the disposal of this product.



This symbol [crossed-out wheeled bin Directive 2006/66/EC Annex II] indicates separate collection of waste batteries in the EU countries.
Please do not throw the batteries into the domestic refuse. Please use the return and collection systems available in your country for the disposal of the waste batteries.

BEFORE YOU USE

- To use this product, please be sure to use the supplied power cord and AC adapter.
- The supplied power cord and AC adapter are designed for exclusive use with this product. Do not use them with other equipment.
- Be sure to use the power cord applicable to your local power specifications. If the product was sold in Japan, use the AC adapter sold with the product with 100VAC and 50 or 60 Hz.
- Do not knot or coil the power cord or AC adapter cord or wrap them around the AC adapter. Doing so may damage the cords, causing fire or electric shock.
- Carry this product by holding the lower part of the main unit in both hands. Do not apply excessive vibration or shock to the product. Doing so may damage parts causing malfunction.
- Do not apply vibration or shock during projection. Do not use this product in a car or ship where vibration or shock is applied to the product. Vibration or shock may damage parts causing malfunction.
- Do not use this product near high-voltage power lines or power source. The product may receive harmful interference.
- Do not use this product in locations subject to humidity, dust, smoke, oil smoke or steam. Dirt may attach to the optical parts, such as the lens, causing reduced image quality.
- Do not use this product in locations exposed to extreme temperature or locations where the temperature changes too quickly.

Use this product under the following environmental conditions:

Temperature: 5°C ~ 35°C Humidity: less than 85% (No condensation)

- When the product is suddenly brought into a warm place from a cold place or when the room temperature is quickly raised, condensation may occur to the surface of the lens causing reduced image quality. Wait until the condensation is completely gone and the image becomes clear.
- Do not touch the lens. It may leave fingerprint marks which can result in a blurred image.
- Important notes when connecting an HDMI cable.
 - Use a HIGH SPEED HDMI cable with the HDMI logo.
HDMI cables that are not compliant with HDMI standards should not be used.
 - Do not apply excessive force to the HDMI terminal while the cable is connected as it could damage the HDMI terminal, leading to a malfunction.
- Follow the guidelines below to prevent the product from dropping or overturning.
 - Use the product on a stable base, desk, or table. Do not place the product on an unstable base or sloping location.
 - Secure and tidy all cables to prevent accidentally pulling the projector off any surface.

■ Luminescent spot and black spot

There may be some pixels that do not operate properly due to the use of an image pick-up device made-up of many pixels. Though luminescent or black spots may be found on the screen, it is a phenomenon peculiar to the image pick-up device and is not a malfunction.

■ There may be some flickering on the screen when shooting a pattern image with gradual changes in brightness. It is a phenomenon peculiar to the image pick-up device and is not a malfunction. This product is not designed to display such kind of images.

■ There may be some image distortion for a moment when the output resolution of the connected device is changed while the image is projected. This is because the product automatically adjusts the projection settings according to the input signal. It is not a malfunction.

■ Lifetime of the parts

Avoid using the projector in severe conditions such as high temperature, dusty or smoky environments as well as long-continuous use in excess of eight hours.

Doing so may shorten the life of critical components such as the optical engine and cooling fan which may lead to degraded image quality. Please note, warranty repair may not apply if the unit is deemed to be subjected to such abuse. Regarding paid component replacement, please contact the distributor the product was purchased from or our service office.

CONTENTS

IMPORTANT SAFEGUARDS	2
BEFORE YOU USE	6
CONTENTS.....	8
1 GETTING STARTED.....	11
CHECKING THE PACKAGE CONTENTS	11
PART NAMES AND FUNCTIONS	12
Projector.....	12
LED BACKLIGHT INDICATION	14
Side panel	15
Remote control.....	16
Operating range for the remote control.....	19
INSTALLING THE PROJECTOR	20
Throw distance and screen size	20
Raising the projected image	21
Using a tripod for a camera	22
CONNECTING TO THE DEVICES	23
Connecting the power (AC adapter and power cord)	23
Connecting to HDMI terminal	24
Output audio through the AUDIO terminal.....	25
Supplying the power from USB port	26
2 BASIC OPERATION	27
TURNING THE POWER ON/OFF.....	27
Powering on	27
Powering off	28
ADJUSTING THE FOCUS	29
CORRECTING THE KEYSTONE DISTORTION	30
Correcting the keystone distortion manually with the remote control.....	30
SELECTING THE DISPLAY MODE (remote control).....	31
CONTROLLING THE VOLUME (remote control).....	32
Turning up the volume	32
Turning down the volume	32
Controlling the volume with control panel.....	33
TURNING OFF THE SOUND	34
HIDING THE IMAGE.....	35
ADJUSTING THE BRIGHTNESS (remote control)	36
ADJUSTING THE CONTRAST (remote control).....	37
SETTING THE ECO MODE (remote control).....	38

3 MENU OPERATION	39
DISPLAYING THE MENU AND BASIC OPERATION	39
Displaying the main menu	39
Operating the menus	39
MAIN MENU	41
CORRECTING TH KEYSTONE DISTORTION	43
SELECTING THE DISPLAY MODE	44
Setting up User mode	46
ADJUSTING THE BRIGHTNESS	49
ADJUSTING THE CONTRAST	50
CONTROLLING THE VOLUME	51
Volume setting	51
Turning off the sound (MUTE)	51
SETTING THE LANGUAGE	52
DETAIL SETTINGS	53
Displaying the detail settings	53
Checking various information	55
Setting the ECO mode	55
Selecting the aspect ratio	56
Setting the auto power off	57
Selecting the projection mode	58
Selecting the installation mode	59
Setting the CEC mode	60
Selecting the Backlight Brightness mode	61
Returning to the factory settings	62
4 MAINTENANCE	63
CLEANING THE LENS, THE CABINET AND THE REMOTE CONTROL	63
Cleaning the lens	63
Cleaning the cabinet and the remote control	63
CLEANING THE INSIDE OF THE PROJECTOR	64
5 TROUBLESHOOTING	65
INDICATOR ICONS	65
TEMPERATURE & WARNING INDICATOR DISPLAY	67
COMMON PROBLEMS AND CHECK ITEMS	68
6 SPECIFICATIONS	70
SPECIFICATIONS	70
Remote control	71
Supplied accessories	71
LIST OF COMPATIBLE SIGNALS	72
TRADEMARKS	74



7 WARRANTY AND AFTER SALES SERVICE 75

1 GETTING STARTED

CHECKING THE PACKAGE CONTENTS

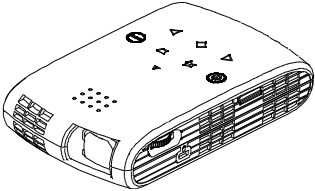
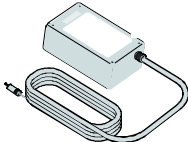
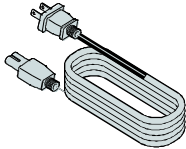
The items below are included with this product. If any item is missing, contact the dealer from whom you purchased this product.

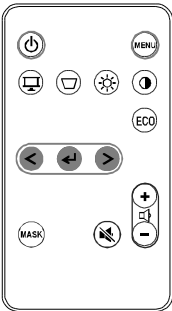
Projector	AC adapter	Power cord
		

Remote control	IMPORTANT SAFEGUARD QUICK START GUIDE	WARRANTY CARD
 <p>*Battery included</p>		

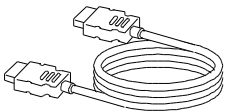
HDMI cable

PART NAMES AND FUNCTIONS

Projector

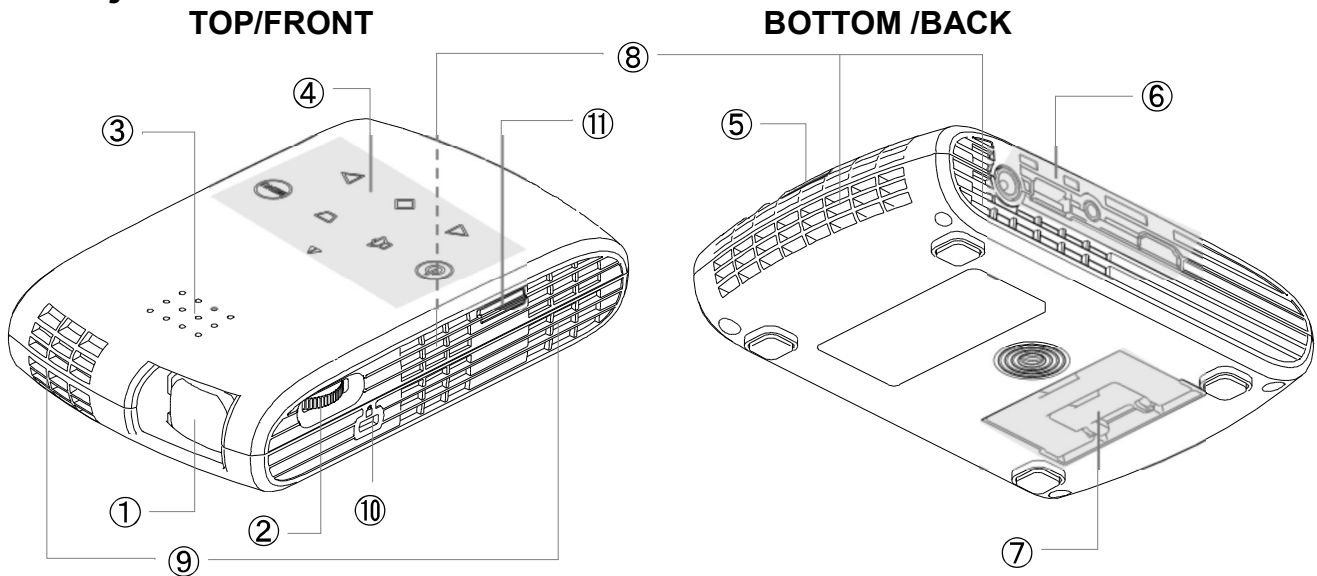

Number	Name	Function	Related Page
①	Lens	Project an image.	→P.20
②	Focus dial	To focus the projected image.	→P.29
③	Speaker	Built-in speaker.	-
④	Control panel	To control the projector.	→P.13
⑤	Remote sensor	To receive IR signal from the remote control.	→P.19
⑥	Side panel	Terminal panel to connect other devices.	→P.15
⑦	Tilt stand	Adjust the projection angle.	→P.21
⑧	Intake vent	Air ventilator inlet to cool down the inside of the projector.	-
⑨	Exhaust vent	Air ventilator outlet to exhaust the air inside of the projector.	-
⑩	 Anti-theft security slot. To connect a security cable.		-
⑪	MAINTENANCE	This port is for maintenance only.	-

CAUTION

- Do not look into the lens during the projection. The strong light emitted from the lens may cause damage to your eyes. Pay attention especially when you use the projector in an environment where there are children.
- Do not touch around the exhaust vent during or immediately after the projection. The area around the exhaust vent may become very hot and could result in burn.
- Hot air may be emitted from the exhaust vent. Do not place any objects, which are easily affected by heat, in front of the exhaust vent.

Control panel

* Touch switch

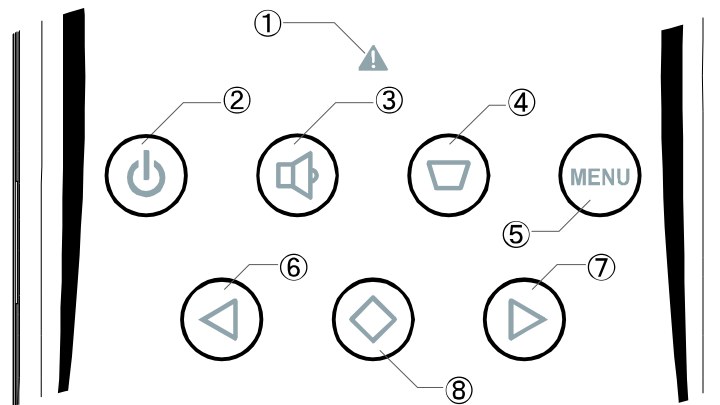

Number	Mark	Name	Function	Related Page
①		Warning indicator	The red LED flashes when there is something wrong with the projector.	→P.14,67
②		Power button	To turn the projector on/off.	→P.27,28
③		Volume button	The “Volume control” screen appears.	→P.33
④		DOWN button	The “Keystone correction” screen appears.	→P.30
⑤	MENU	Menu button	To display/hide the menu. To return to the previous menu without executing the selected item while operating the menu.	→P.39
⑥		LEFT button	To move the selected item to the left.	-
⑦		RIGHT button	To move the selected item to the right.	-
⑧		Enter button	To execute the selected item.	-

LED BACKLIGHT INDICATION

There is an LED indicator behind each button on the control panel (7pcs in total) and the warning indicator. These LEDs will light up according to the status of the projector.

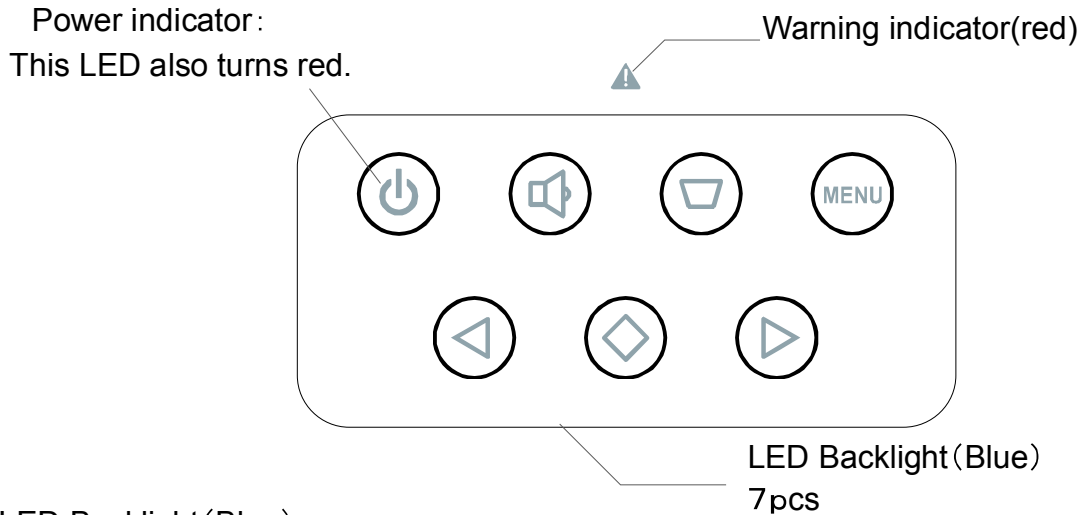

LED Backlight (Blue)

There is a blue LED indicator behind each button on the control panel (7pcs in total). These LEDs will light up when the power is on.

The brightness of the LED has three levels which can be set from the menu. You can also set the LED to always ON.

Unless it is set to OFF from the menu, the LED will light up at the brightest level while the menu is displayed.

The power button LED also works as a start indicator.

The LED will flash at its brightest level at 2 seconds intervals (light on for 1 second and light off for 1 second) until the start-up is complete and the power is on.

LED Backlight (Red)

There is a red LED indicator behind the power button on the control panel, which will light up dimly when the power is off.

The LED will flash at 0.5 seconds intervals (light on for 0.25 seconds and light off for 0.25 seconds) when the projector is in "abnormal temperature (warning)" status and flash in 2 seconds intervals (light on for 1 second and light off for 1 second) when the projector is in "abnormal temperature (stop)" status.

When the temperature of the projector becomes too high, while the power is off, the red LED will light dimly and will flash.

Warning indicator(red)

The LED will flash at 0.5 seconds intervals (light on for 0.25 seconds and light off for 0.25 seconds) when there is something wrong with the fan and flash at 2 seconds intervals (light on for 1 second and light off for 1 second) when the brightness level of the LED decreases.

Side panel

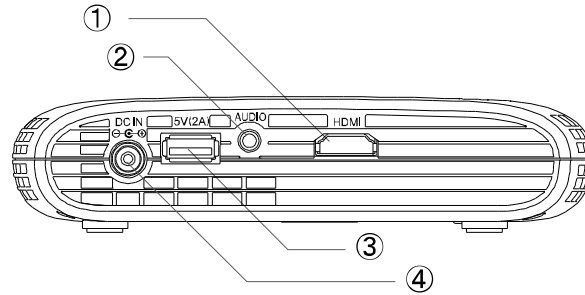

Number	Name	Function	Related Page
①	HDMI	HDMI input terminal. To connect an HDMI output device.	→P.24
②	AUDIO	Head Phone output Terminal.	→P.25
③	USB	To supply 5V power up to 2A.	→P.26
④	DC IN	To connect the supplied AC adapter.	→P.23







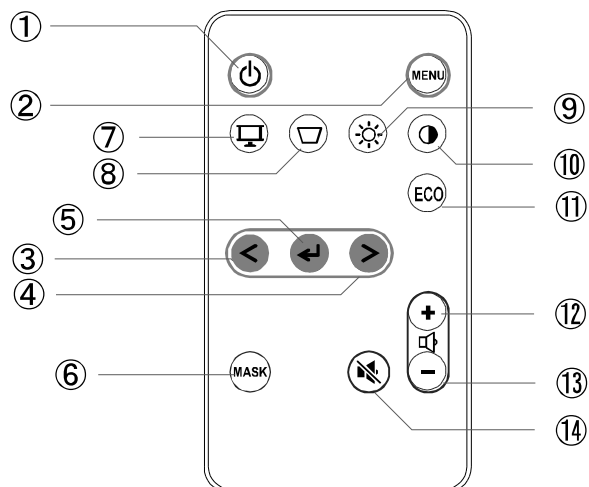

CAUTION

- Use the HIGH SPEED HDMI cable with HDMI logo.
HDMI cable that is not compliant with HDMI standard may not be used.
- Do not apply excessive force to the HDMI terminal while an HDMI output device is connected. It could damage the HDMI terminal, leading to a malfunction.

Remote control



Number	Mark	Name	Function	Related Page
①		Power button	To turn the projector on/off.	→P.27,28
②	MENU	Menu button	To display/hide the menu. To return to the previous menu without executing the selected item while operating the menu.	→P.39
③	<	LEFT button	To move the selected item to the left.	-
④	>	RIGHT button	To move the selected item to the right.	-
⑤		ENTER button	To execute the selected item.	-
⑥		Blank screen button	To toggle between the projected image and a blank screen. You can temporarily hide the projected image.	→P.35
⑦		Display mode button	To set the display mode.	→P.31
⑧		Keystone button	To correct the vertical keystone distortion in increments of one degree.	→P.30
⑨		Brightness button	To adjust the brightness of the projector.	→P.36

Number	Mark	Name	Function	Related Page
⑩		Contrast Button	To adjust the contrast of the projector.	→P.37
⑪		ECO button	To set the ECO mode.	→P.38
⑫		Volume+ button	To increase the volume of the built-in speaker.	→P.32
⑬		Volume- button	To decrease the volume of the built-in speaker.	→P.32
⑭		MUTE button	To temporarily mute the sound.	→P.34

Preparing the remote control

When purchased

1. A battery is pre-installed in the remote control at the time of shipment (with insulation sheet).

Remove the insulation sheet before using the remote control for the first time.

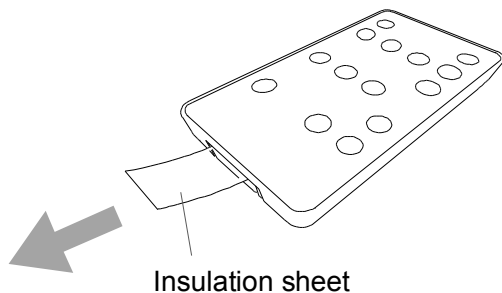

How to change the battery

1. Pull out the battery case.
2. Take out the old button battery and put the new button battery in the battery case with the "+" side facing up.
3. Insert the battery case to the remote control.

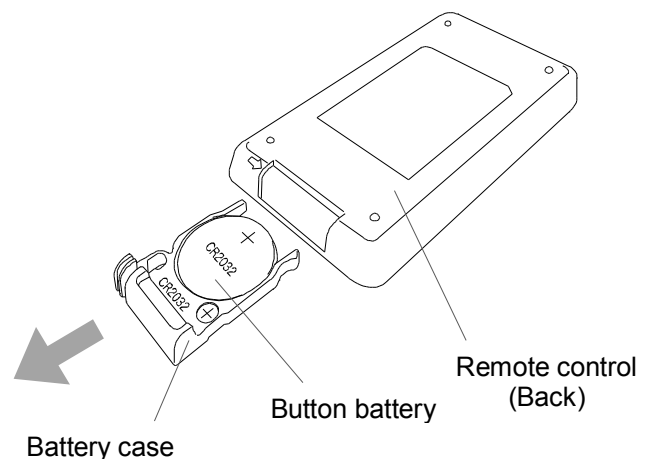

Note

- Use the button battery type CR2032 for the remote control.



CAUTION

- Improper use of the battery may lead to electrolyte leakage or bursting and may cause fire, injury or corrosion to the remote control. Observe the following precautions for safety use of the product.
 - Do not use any battery other than specified.
 - If the battery leaks, wipe off the leaked electrolyte with a cloth and install a new battery. If the leaked electrolyte contacts your skin, immediately wash it away with running water.
 - When the time to replace the battery comes, immediately remove the battery.
 - Remove the battery from the remote control when you do not use the remote control for a long period of time.
 - Do not heat the battery or throw into fire.
 - Do not reverse the positive (+) and negative (-) terminals.
 - When disposing the battery, follow the recycling or disposal regulations in your community.
- Keep the battery removed from the remote control out of reach of children.
The battery could choke children if swallowed.

Operating range for the remote control

Aim the IR transmitter of the remote control at the IR receiver on the back of the projector to control the projector.

Use the remote control within its operating range as described below.

Operating

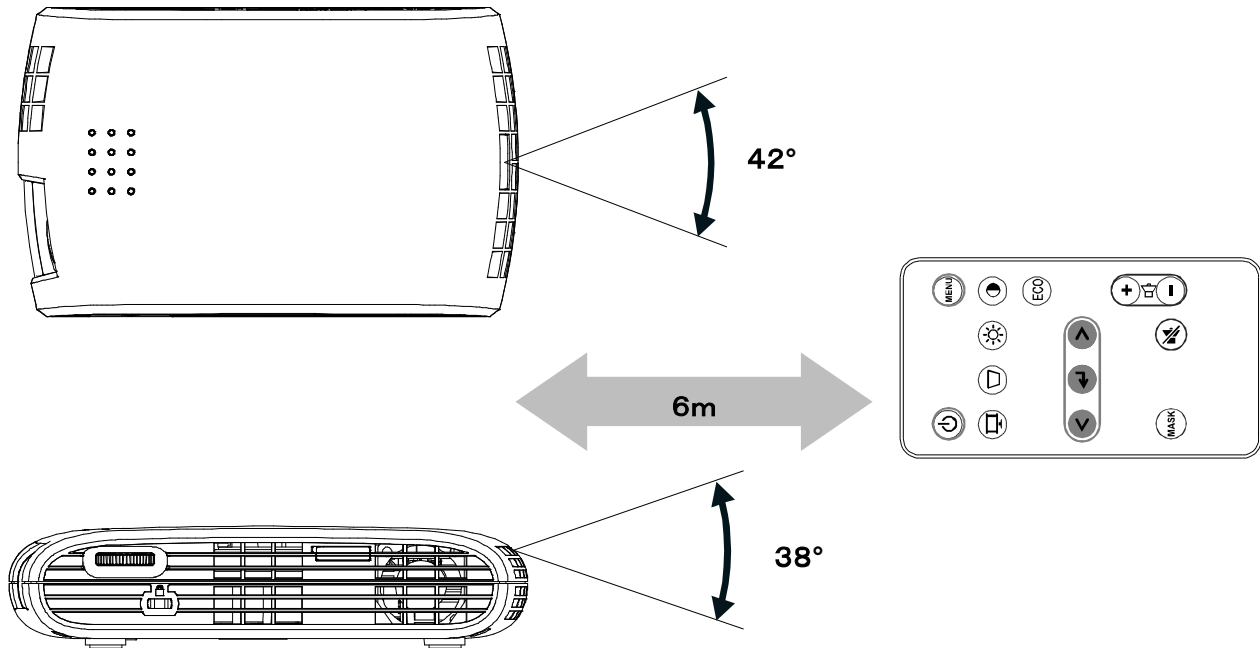

Note

- Do not place any objects between the remote control and the IR receiver. The remote control transmits IR signals and the projector will not respond if there are objects between the remote control and the IR receiver.
- The remote control may not work correctly if strong light (such as direct sun light) or light from an extremely close range (such as from an inverter fluorescent lamp) shines on the IR receiver of the projector. Keep such light sources away from the projector.

INSTALLING THE PROJECTOR

Throw distance and screen size

Decide on the position to place the projector.

The distance between the projector and the screen should be between 48cm (screen size: 25 inch) and 133 cm (screen size: 68 inch).

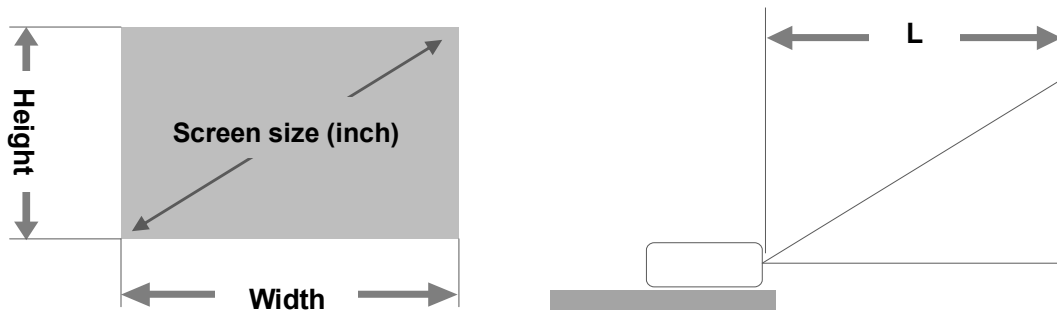

Screen size			Projection distance L(cm)
Inch	Width (cm)	Height (cm)	
25	53.8	33.7	48
30	64.6	40.4	58
35	75.4	48.0	68
40	86.1	53.8	78
45	96.9	60.6	88
50	107.7	67.3	98
55	118.5	74.0	108
60	129.2	80.8	118
65	140.0	87.5	128
68	146.5	91.5	133



Note

- The values in the table are design values and may vary. Use them as an indication only.
- The aspect ratio of the projected image in full screen is 16: 10. When the aspect ratio of the input signal is different from 16: 10 (such as 16: 9 or 4: 3), top and bottom or left and right of the image will not be displayed and the screen size becomes smaller than those specified in the above table.

Raising the projected image

Projected image can be raised up when using the built-in tilt stand underneath the projector.

Bottom of the projector

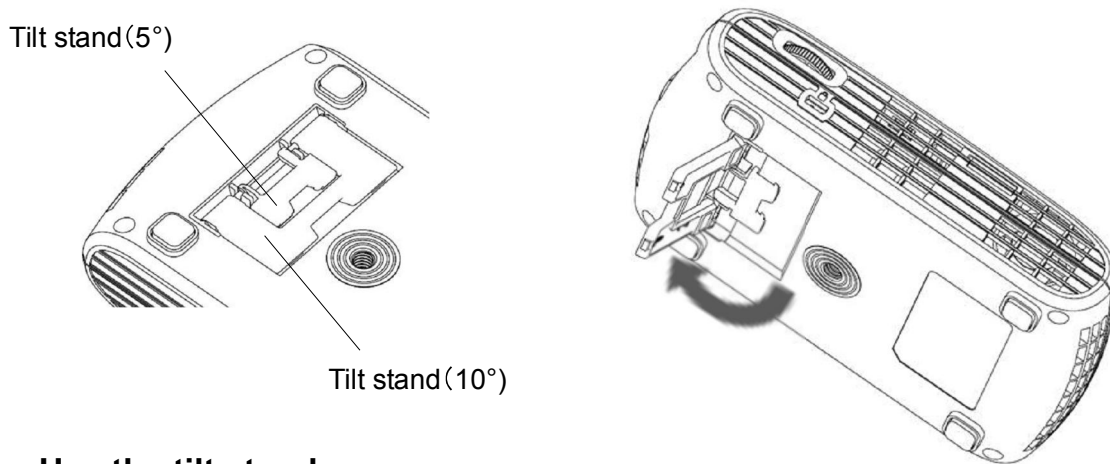

1. Use the tilt stand

Setting up the tilt stand allows you to raise the projected image.

The two position tilt stand allows you to set up the projection angle to either 5° or 10°.

The greater the angle, the higher the image is projected.

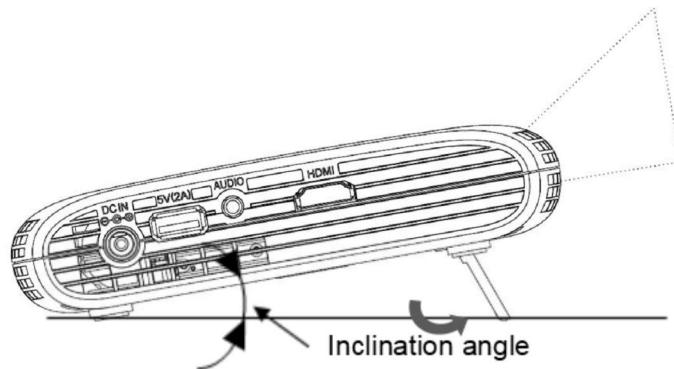

2. Reset the position of the projected image.

The projector will project horizontally when the tilt stand is folded to the first position.



Note

- Keystone distortion can occur when using the tilt stand. Adjust keystone settings to correct keystone distortion. Refer to “CORRECTING THE KEYSTONE DISTORTION” (Page 30, 43) for details.

Using a tripod for a camera

The projector is equipped with a tripod receptacle on the bottom of the projector. You can mount the projector on a tripod for a camera.

●Bottom of the projector

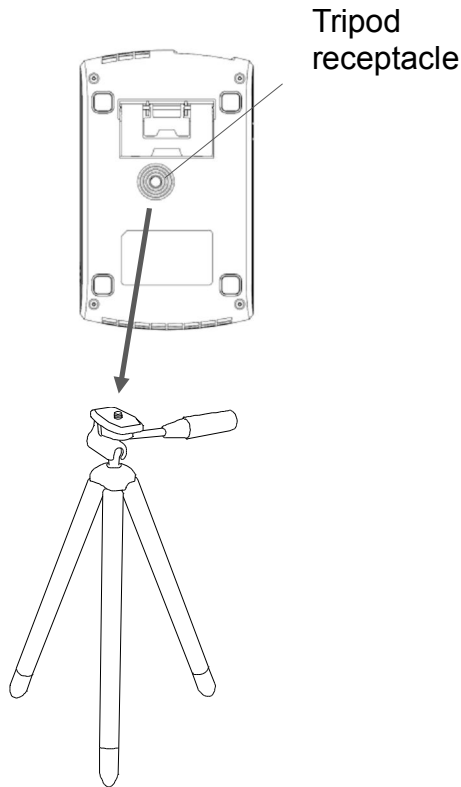

●When mounted on a tripod

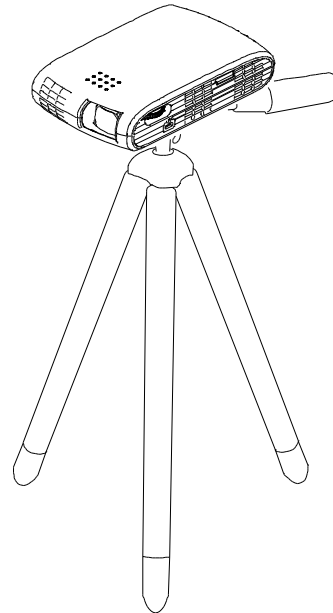

 **Note**

- Use a tripod that can support 500g or more.
- Fully spread the legs of the tripod. In case of using a tripod with an elevating column, do not extend the column when mounting the projector.

 **CAUTION**

- Refer to the instruction manual of the tripod for instructions on the use of the tripod. Place the tripod in stable condition. Otherwise, it may tip over, causing injury.
- When connecting the cables (such as the power cord, HDMI cable), make sure that nobody can trip over the cables. Otherwise, the projector may fall or tip over, causing injury.

CONNECTING TO THE DEVICES

Connecting the power (AC adapter and power cord)

Connect the supplied AC adapter and the power cord, and then firmly connect to the DC IN of the projector.

Then insert the other plug of the power cord securely into the wall outlet.

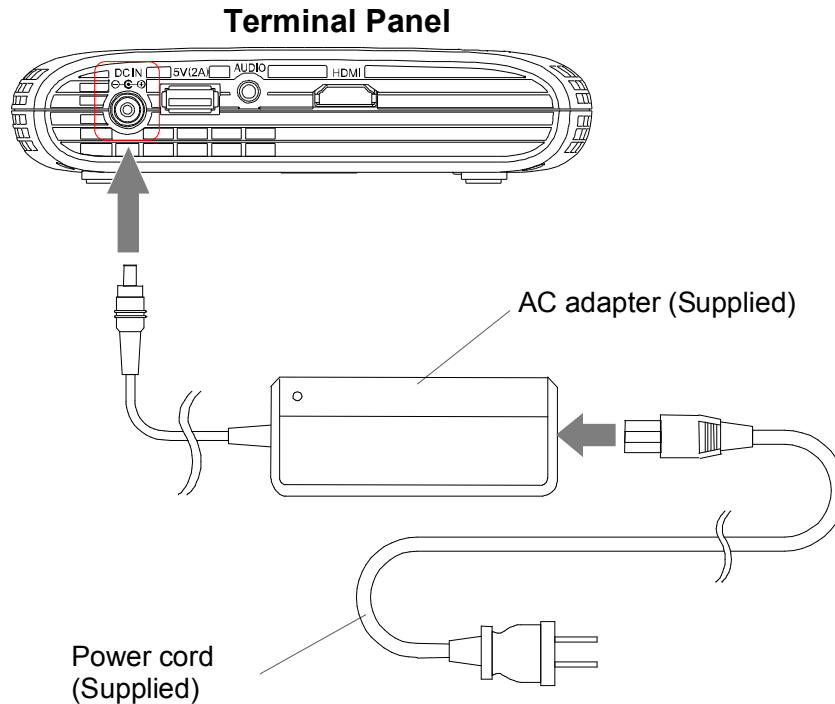

CAUTION

- The supplied AC adapter and power cord are for use with the projector only. Do not use with other devices.
- Do not place the projector on carpet, cushions or bedding and do not cover the projector with a cloth or tablecloth. Doing so will increase the temperature of the projector and may cause fire or malfunction.
- The supplied AC adapter may become hot during normal operation. This is normal. Do not continue to touch the adapter for a long period.

Connecting to HDMI terminal

1. **Connect the projector to a device such as a DVD-player using HDMI cable.**

Connect the HDMI output terminal of your device such as a DVD-player and computer to the HDMI terminal of the projector using an HDMI cable (Supplied) as shown in the below picture. Firmly insert the cable into the connector.

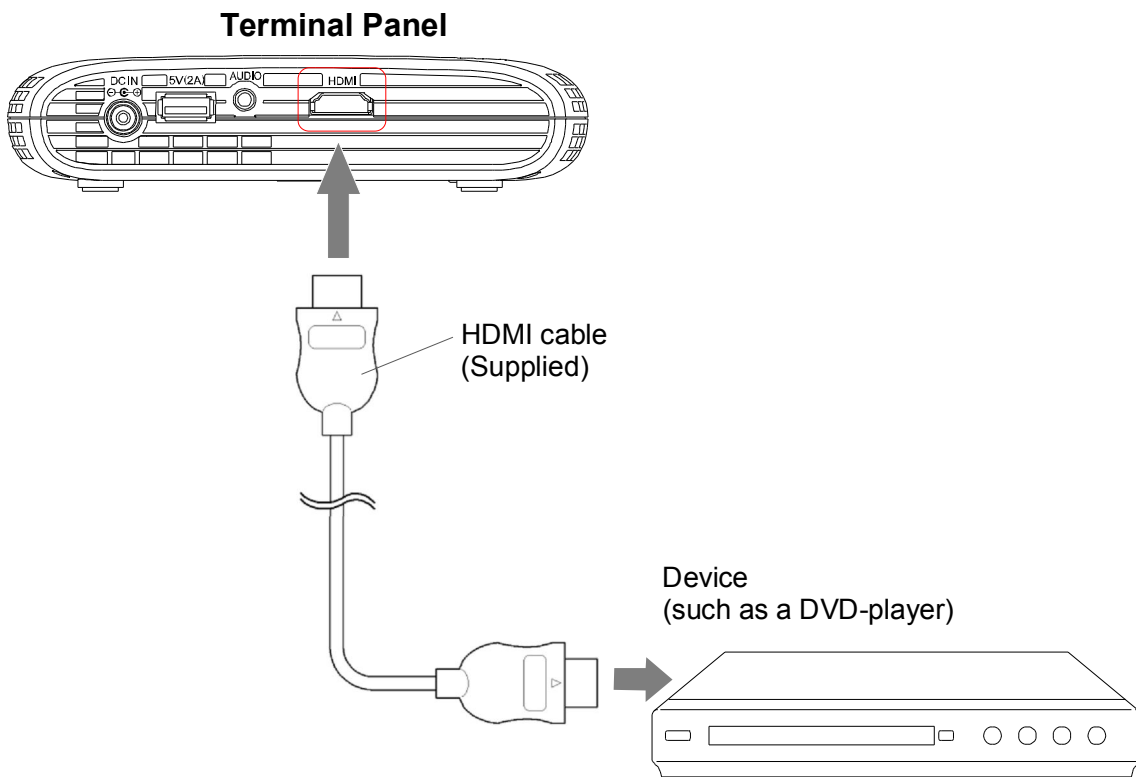

CAUTION

- Use the HIGH SPEED HDMI cable with HDMI logo. HDMI cable that is not compliant with HDMI standard may not be used.
- This projector complies with HDMI standard. However, we do not guarantee the operation with all the output devices.
- Do not apply excessive force to the HDMI terminal while an HDMI output device is connected. It could damage the HDMI terminal, leading to a malfunction.

Output audio through the AUDIO terminal

1. Connect headphones or an external speaker to the projector

Plug in headphones(sold separately) or an external speaker(sold separately) to the AUDIO output port of the projector.

Built-in speaker output will be stopped and audio will be output through headphones or an external speaker.

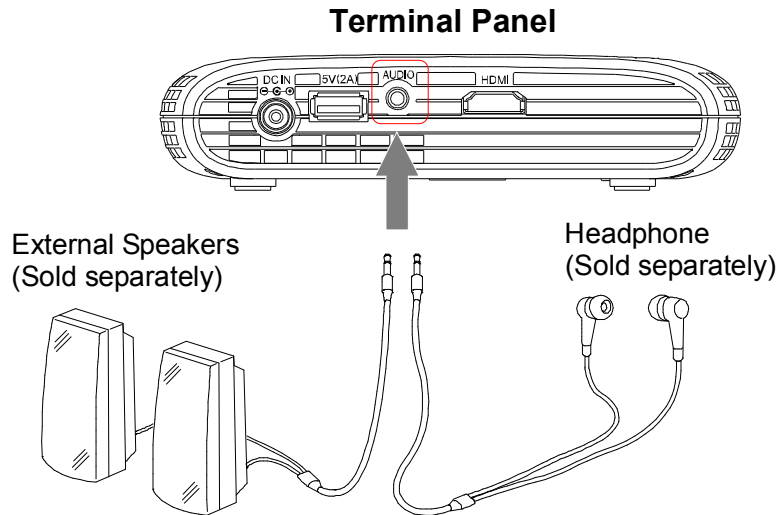

Note

- Please read this instructional manual before connecting headphones or an external speaker before connecting to the projector.
- Please lower the audio volume of the external speaker before turning on.

2. Adjust audio volume of the headphone

Audio volume of headphone can be adjusted by volume settings shown after pressing MENU button on the front panel or the remote control while the headphone is inserted to the AUDIO output terminal of the projector.

Refer to “CONTROLLING THE VOLUME” (Page51) for details.

The volume of the headphone can be adjusted by pressing the volume buttons on the remote control.

Refer to “CONTROLLING THE VOLUME (remote control)” (Page32) for details.

CAUTION

- Please be careful of volume level when using headphones. Continuous usage of the headphone at very high volume may cause hearing loss. In order to protect hearing, please do not turn up the volume level too high. Please increase volume gradually as sudden increases may harm hearing.
- Please do not add extra force to the projector when inserting headphones as this may cause damage.

Supplying the power from USB port

1. connect other USB apparatuses to this plane

connect other USB apparatuses to this plane

The USB port can supply 5V power up to 2A. This USB port is for power supply only and has no communication function.

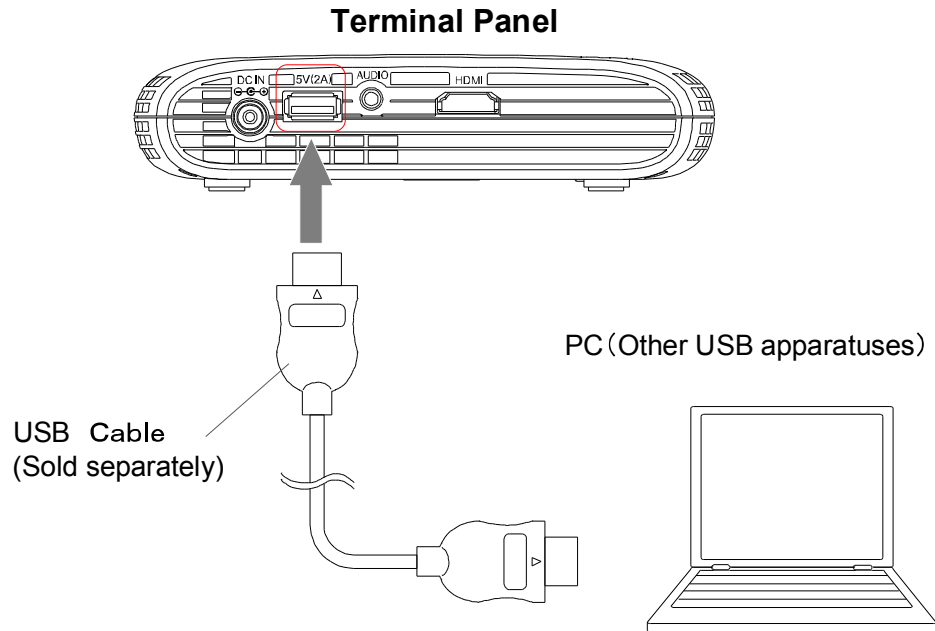



Note

- The USB power supply is activated when the AC adapter is connected to the projector even if the power is on or off.

2 BASIC OPERATION

TURNING THE POWER ON/OFF

Powering on

1. Make sure that the power and all necessary cables are connected properly.
2. Touch  button on the control panel.
(Press  button on the remote control.)

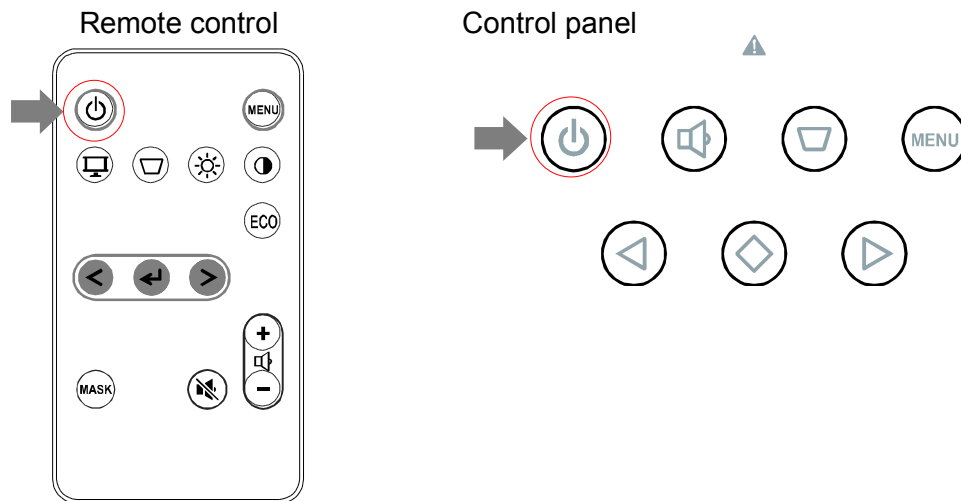

Power indicator  will turn green

The “Input source standby” screen will be displayed.



Note

- It will take some time before you can operate the projector after the power is on.

Powering off

1. Touch  button on the control panel.
(Press  button on the remote control.)

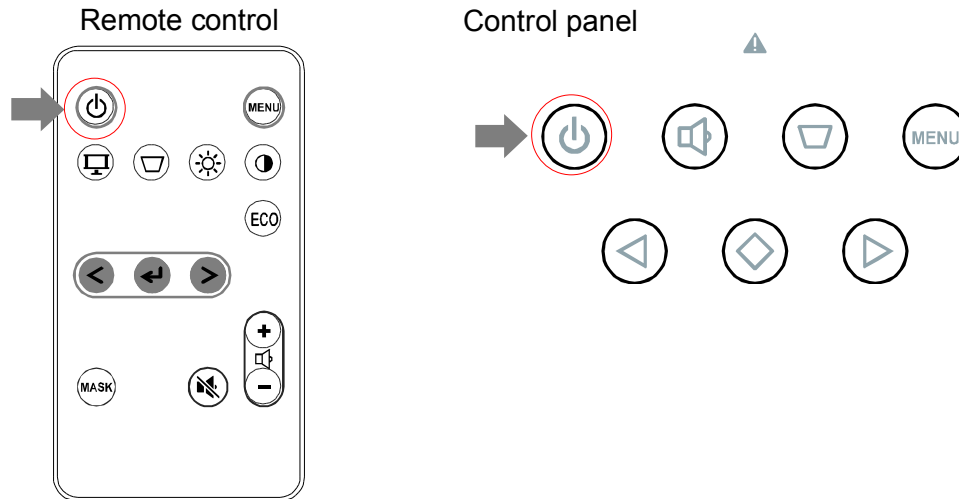

2. A message will be displayed. Press the  button again.

Press the Power button on the control panel of the projector or on the remote control while the message in the right figure is displayed to turn off the power.



Press Power button again to turn off the projector.

The Power indicator  will turn off.

The cooling fan will operate for a while. Disconnect the power cord after the fan stops.



Note

- The “Power off confirmation” message will disappear after 5 seconds of no operation.



CAUTION

When the warning indicator is lit or flashing, it indicates that a malfunction has occurred to the projector.

Refer to “Warning indicator ” (Page67) for details.

ADJUSTING THE FOCUS

Turn the focus ring to adjust the focus.

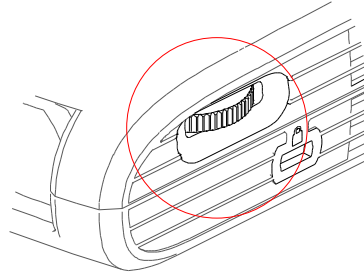

Note

- The focus adjustment can be performed when the throw distance is between 48cm and 133cm.
- Refer to “Throw distance and screen size” (Page20) for details on the screen size.
- Sometimes, you may notice fine streaks on projected images. This is due to interference with the screen surface. Replace the screen or displace the focus a little.



CAUTION

- Do not look into the lens during the projection. The strong light emitted from the lens may cause damage to your eyes. Pay attention especially when you use the projector in an environment where there are children.
- Do not touch the lens. If the lens becomes dirty from fingerprints or anything else, the projected images may become blurry. In such cases, wipe the lens with commercial lens-cleaning paper. Make sure to turn off the projector, disconnect the power cord and then allow the cabinet to cool before cleaning the lens.
- When the projector is moved from a cold place to a warm place or when the room temperature is suddenly increased, condensation on the lens may occur, resulting in blurred image. In such cases, let the projector warm up to room temperature before using it.

CORRECTING THE KEYSTONE DISTORTION



Correcting the keystone distortion manually with the remote control

1. Press the the  button.

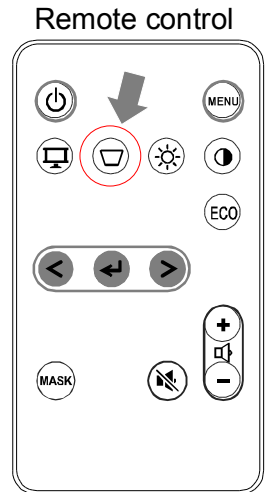
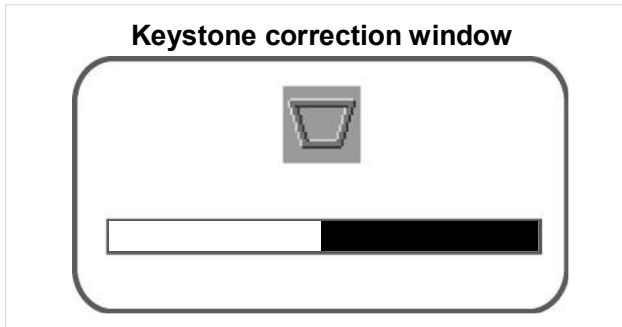
The following “Keystone correction” window will be displayed.

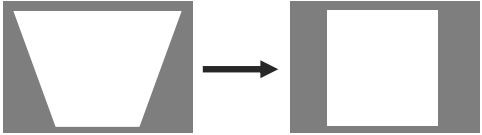

2. Press the “< >” buttons.

<p>Press the “>” button. (Press when the projection angle is increased.)</p>	
<p>Press the “<” button. (Press when the projection angle is decreased.)</p>	

Correcting the keystone distortion manually with control panel

1. Press the “” button on the control panel.

The following “Keystone correction” window will be displayed.

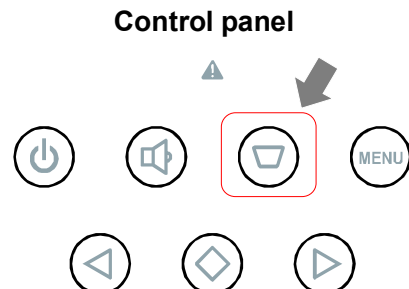
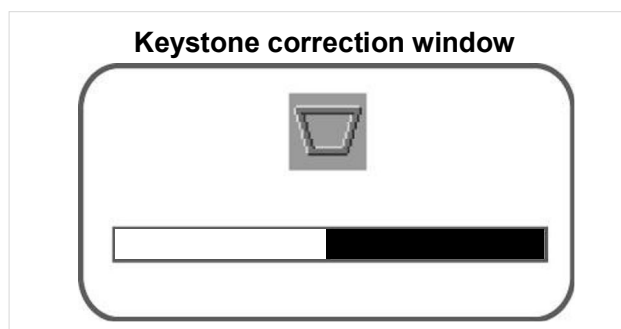

2. Press the “< >” buttons on the control panel to correct the keystone distortion.

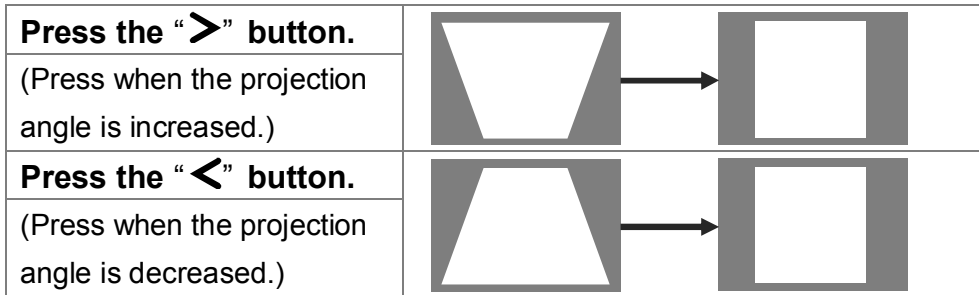

Note

- The “Keystone correction” window will be automatically closed after 3 seconds of no operation.
- The keystone correction can cause an image to be slightly degraded because the correction is made electronically.
- The keystone distortion can be corrected to 40° of the angle of tilt.
- The keystone correction can also be performed from the menu.
Refer to “CORRECTING THE KEYSTONE DISTORTION” (Page3043) for details.

SELECTING THE DISPLAY MODE (remote control)

1. Press the button on the remote control.

“Display mode select” menu will be displayed.

Display mode select menu

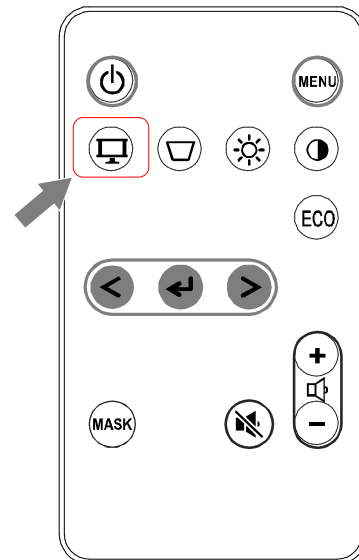
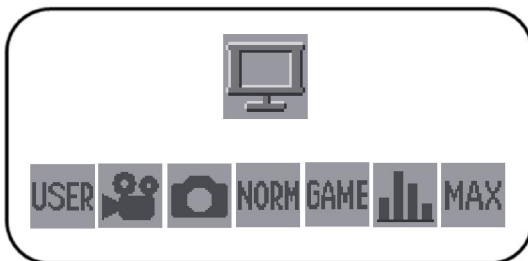

2. Press the “< >” buttons of remote control.

Select the display mode with the < > buttons on the remote control.
Press the button to execute the selection.

Note

- The “Display mode select” menu will be automatically closed after 3 seconds of no operation.
- Selecting the display mode can also be performed from the menu.
Refer to “SELECTING THE DISPLAY MODE” (Page44) for details.

CONTROLLING THE VOLUME (remote control)

Turning up the volume

1. Press the “+” button near the  mark on the remote control.

The following “Volume control” window will be displayed and the volume will be turned up.

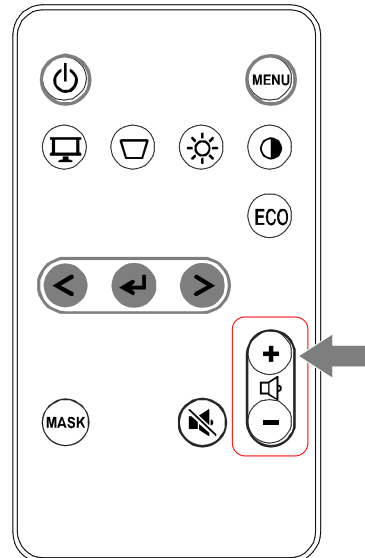
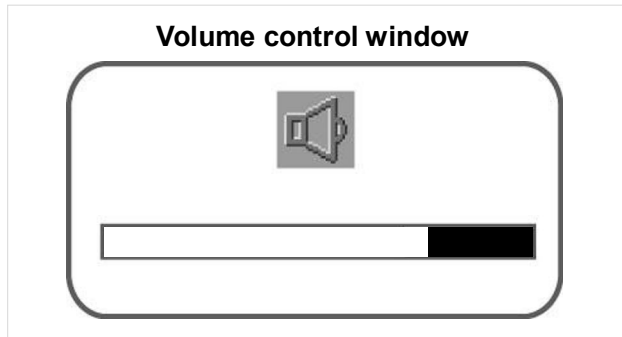

Turning down the volume

1. Press the “-” button near the  mark on the remote control.

The following “Volume control” window will be displayed and the volume will be turned down.

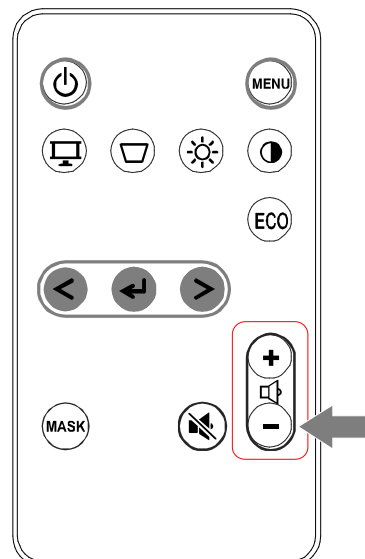
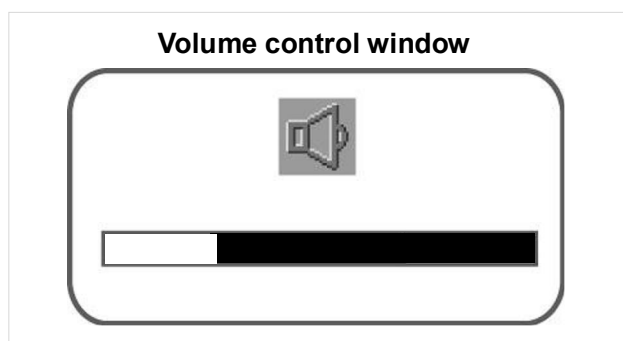

Note

- The “Volume control” window will be automatically closed after 3 seconds of no operation.
- The volume control can also be performed from the menu. Refer to “CONTROLLING THE VOLUME” (Page51) for details.

Controlling the volume with control panel

1. Press the “” button on the control panel.

The following “Volume control” window will be displayed.

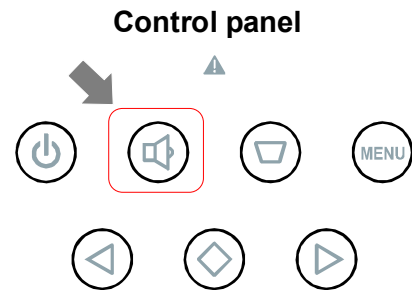
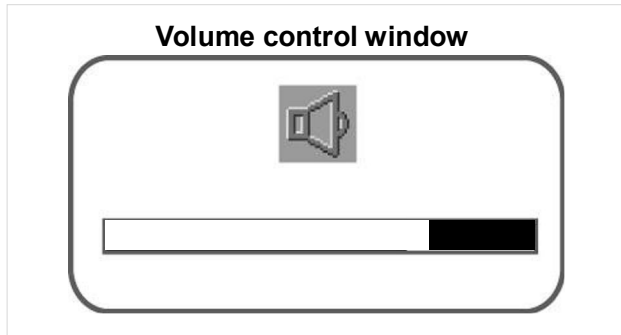

2. Press the “< >” buttons on the control panel **to controlling the volume.**

Press the  buttons : Turning up the volume

Press the  buttons : Turning down the volume.



Note

- The “Volume control” window will be automatically closed after 3 seconds of no operation.
- The volume control can also be performed from the menu. Refer to “CONTROLLING THE VOLUME” (Page51) for details.

TURNING OFF THE SOUND

You can temporarily mute the sound from the built-in speaker.

1. **Press the  button to mute the sound.**
Press the  button again to cancel the mute.

When the “+” button near the  mark on the remote control is pressed while in mute, the mute will be released and the volume will be increased by 1 level.

When the “-” button near the  mark on the remote control is pressed while in mute, the mute will be released and the volume will be decreased by 1 level.

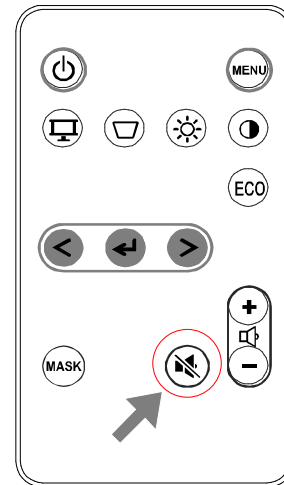

 **Note**

When an external speaker is connected to the projector, the internal speaker will also become mute.

Touchboards

205 Westwood Ave, Long Branch, NJ 07740

Phone: 866-94 BOARDS (26273) / (732)-222-1511

Fax: (732)-222-7088 | E-mail: sales@touchboards.com

HIDING THE IMAGE

You can temporarily hide the projected image with the “Blank screen” function.

1. Press the MASK button on the remote control.

The blank screen will be displayed to hide the projected image.

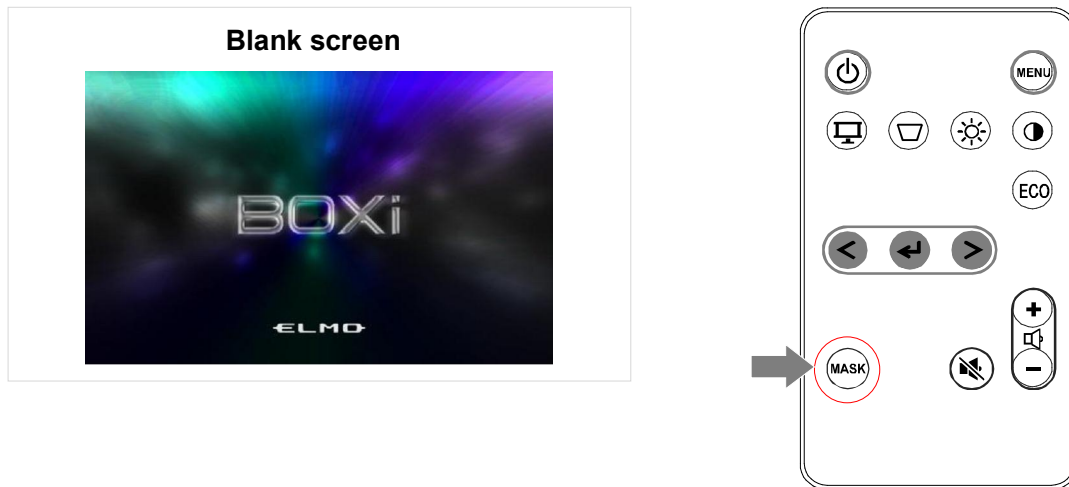

Press the MASK button again to return to the input signal screen.



Note

- You can also exit the blank screen by pressing any button on the control panel or on the remote control, except the MASK button on the remote control.
- The sound will not be muted when the blank screen is displayed.
- While in “Black Screen” mode no signal will be recognized. To initialize the projector “Black Screen” mode must be turned off by pressing the button.

ADJUSTING THE BRIGHTNESS (remote control)

Adjust the brightness on the remote control.

1. Press the  button on the remote control.

The “Brightness adjustment” window will be displayed.

Brightness adjustment window

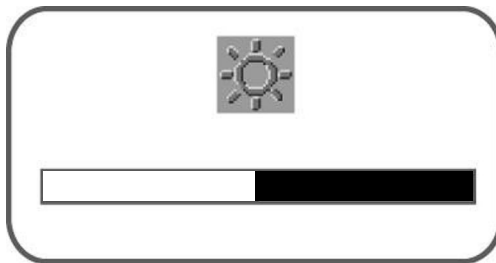

< Darken Lighten >

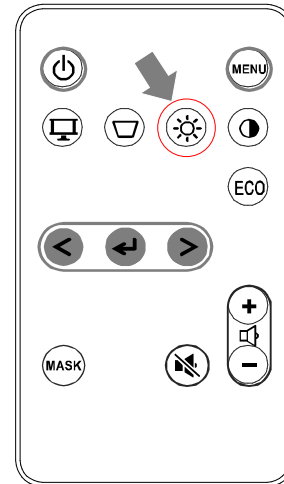

2. Press the “< >” buttons of remote control.

Adjust the brightness with the < > buttons.

Note

- The “Brightness adjustment” window will be automatically closed after 3 seconds of no operation.
- The brightness adjustment cannot be done from the “Input source standby” screen.
- The brightness adjustment can also be performed from the menu. Refer to “ADJUSTING THE BRIGHTNESS” Page49 for details.

ADJUSTING THE CONTRAST (remote control)

Adjust the contrast on the remote control.

1. Press the button on the remote control.

The “Contrast adjustment” window will be displayed.

Contrast adjustment window

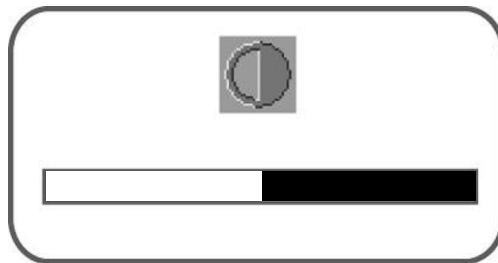

< Weaken Sharpen >

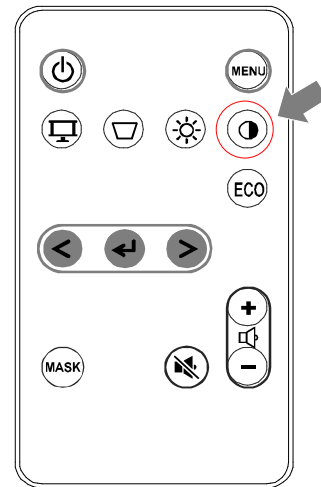

2. Press the “< >” buttons of remote control.

Adjust the contrast with the “< >” buttons.



Note

- The “Contrast adjustment” window will be automatically closed after 3 seconds of no operation.
- The contrast adjustment cannot be done from the “Input source standby” screen.
- The contrast adjustment can also be performed from the menu. Refer to “ADJUSTING THE CONTRAST” Page50 for details.

SETTING THE ECO MODE (remote control)

Setting the ECO mode on the remote control.

1. Press the ECO button on the remote control.

The “ECO mode setting” menu will be displayed.

ECO mode setting menu

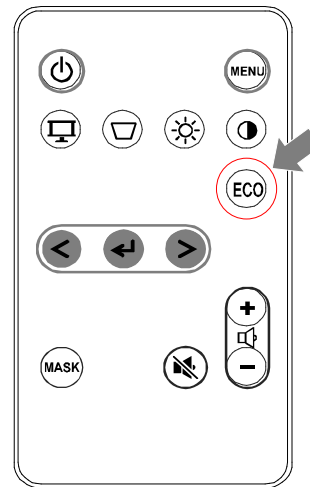
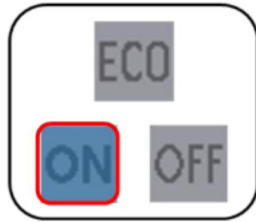

2. Press the “< >” buttons of remote control.

Select “ON” or “OFF” with the < > buttons on the remote control.

Setting	Description
ON	To activate the ECO mode.
OFF	To cancel the ECO mode.

Press the ↵ button to execute the selection.

 **Note**

- The “ECO mode setting” menu will be automatically closed after 3 seconds of no operation.
- Setting the ECO mode can also be performed from the menu. Refer to “SETTING THE ECO MODE” (Page55) for details

3 MENU OPERATION

Various configurations and adjustments to the projected image can be done from the menu.

DISPLAYING THE MENU AND BASIC OPERATION

Displaying the main menu

1. Press the MENU button.

Press the MENU button on the remote control or on the control panel.

Remote control

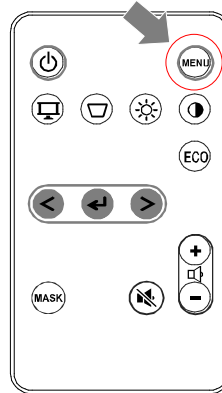

Control panel

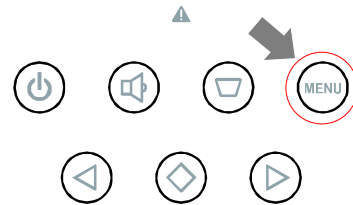

The menu will be closed if the MENU button is pressed again.
The menu will also be closed automatically after 30 seconds of no operation.

Operating the menus

Main menu

The selected item will be marked in blue.

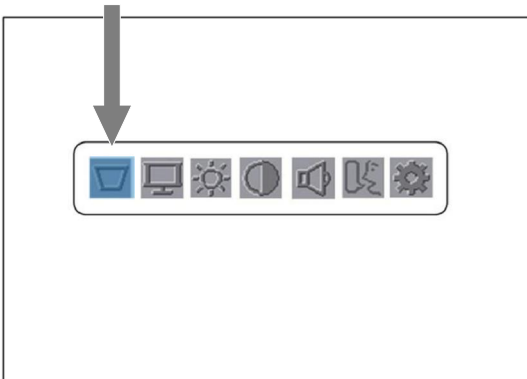

Sub menu

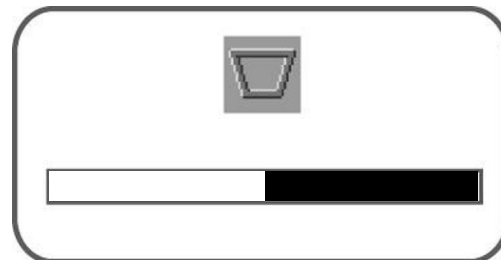

The selected item in the main menu will be marked in blue.

If you open the selected item, a sub menu will be displayed and you can configure the details.

The items that cannot be selected will be marked in dark grey.

The non selectable items will be marked in dark grey. →



Button	Function
↩ button	Configure the setting of the selected icon.
🔊 button	The “Volume control” screen appears.
▭ button	The “Keystone correction” screen appears.
< button	Move the selected item left. Adjust the setting value of the adjustment bar*.
> button	Move the selected item right. Adjust the setting value of the adjustment bar.
MENU button	Return to the previous menu without changing the settings. When the main menu is displayed, the main menu will be closed.

*Adjustment bar: To be used to adjust the setting values.
(For example: Volume adjustment bar)

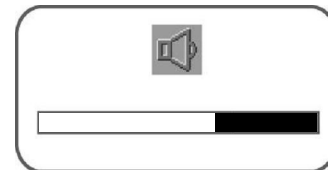

 **Note**

- The value set with of the adjustment bar using the < > buttons cannot be returned to the previous value before setting by pressing the MENU button.
- The menu will be automatically closed after 30 seconds of no operation. Press the MENU button again to display the menu.
- The setting screen for Keystone/Volume button on this product and the setting screen for display mode/keystone/brightness/contrast/eco/volume button of the remote control will be automatically closed after 3 seconds of no operation.

MAIN MENU



The following items can be configured from the main menu:

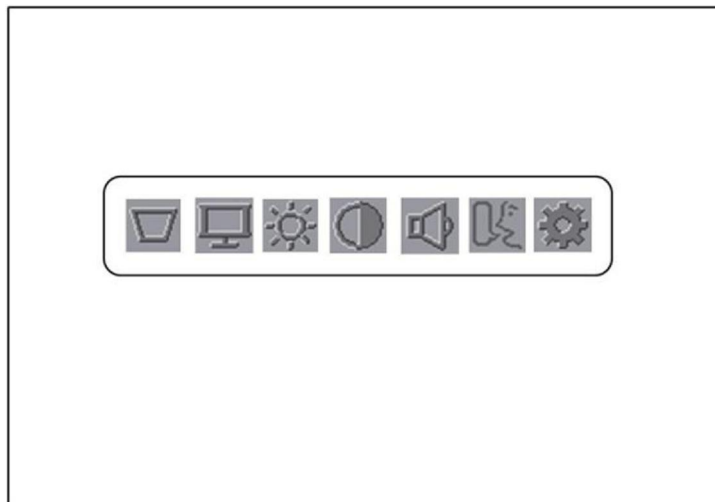

Keystone adjustment/ Display mode selection/ Brightness adjustment/ Contrast adjustment/ Volume adjustment/ Language/ Detail settings

If you select the item, a sub menu will be displayed.

Refer to “Displaying the main menu” (Page39) for details on displaying the main menu.

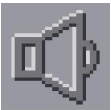

Icon	Name	Options/ Adjustable range	Description
	Keystone adjustment →P.43	- 40 ~ + 40 Default setting: 0	Correct the vertical keystone distortion. The correction can be made in increments of one degree.
	Display mode selection →P.44	User Cinema Photo Normal <input checked="" type="checkbox"/> Default Game Presentation Bright (Max)	Set an appropriate image mode according to the scene.
	Brightness adjustment →P.49	1 ~ 100 Default setting: 50	Adjust the brightness of the image. The adjustment can be made in increments of one unit.

Icon	Name	Options/ Adjustable range	Description
	Contrast adjustment →P.50	1 ~ 100 Default setting: 50	Adjust the contrast of the image. The adjustment can be made in increments of one unit.
	Volume adjustment →P.51	1 ~ 10 Default setting: 7	Adjust the volume of the image. The adjustment can be made in increments of one unit.
	Language →P.52	English French German Spanish Italian Swedish Dutch Portuguese Russian Japanese Simplified Chinese	Set the language for the menus and messages.
	Detail settings →P.53	The following items can be configured: ECO mode Aspect ratio Auto power off Projection mode Installation mode CEC mode Factory settings	Default setting: OFF Default setting: AUTO(Fixed) Default setting: 180 Default setting: Front Default setting: Desktop Default setting: OFF



Note

- The main menu will be automatically closed after 30 seconds of no operation or when the MENU button is pressed again.

CORRECTING TH KEYSTONE DISTORTION

1. Display the “Main” menu.

Refer to “Displaying the main menu” (Page39).

Press the MENU button on the remote control or on the control panel.

The main menu will be displayed.

2. Select the icon with the < > buttons on the remote control or on the control panel.

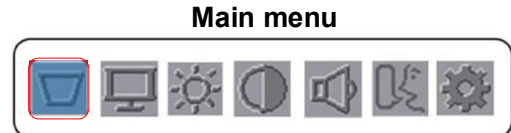



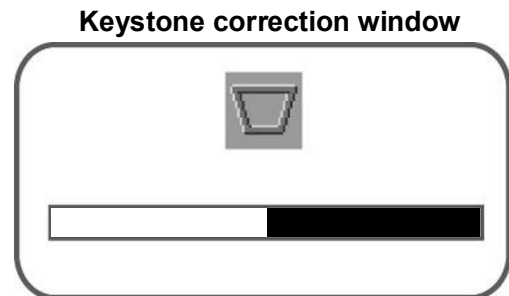

Press the  button to execute the selection.

The “Keystone correction” window will be displayed.

3. Correct the keystone distortion with the < > buttons on the remote control or on the control panel.

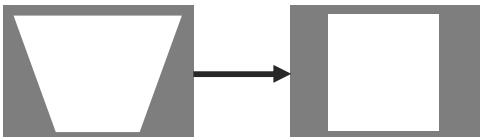

Press the  button to execute the correction and return to the main menu.

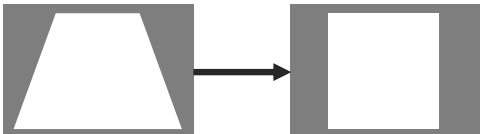
Remote control or control panel	
Press the  button. (Press when the projection angle is increased.)	
Press the  button. (Press when the projection angle is decreased.)	

Note

- The keystone correction can cause an image to be slightly degraded because the correction is made electronically.
- The keystone distortion can be corrected to 40° of the angle of tilt.

SELECTING THE DISPLAY MODE

1. Display the “Main” menu.

Refer to “Displaying the main menu” (Page39).

Press the MENU button on the remote control or on the control panel.

The main menu will be displayed.

2. Select the icon  with the < > buttons on the remote control or on the control panel.

Press the  button to execute the selection.

The “Display mode select” menu will be displayed.

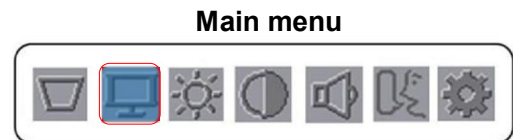

3. Select the display mode with the < > buttons on the remote control or on the control panel.

Selected screen mode is shown by pressing  button.



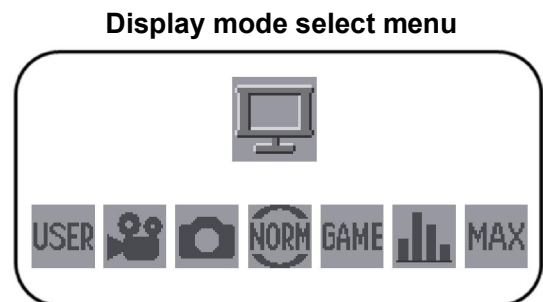



Press MENU button to return to the main menu. Turn off the main menu by pressing the MENU button again.



To set up user mode, please refer to "Setting up User Mode."(Page46)

Press the **MENU** button to cancel the selection.

The following display mode can be selected:



Icon	Mode	Description
	User	A Mode that can be adjusted to users' preferences. "(Page46)
	Cinema	A mode suitable for films.
	Photo	A mode suited for showing still images, such as photos, for exact color reproduction.
	Normal <input type="checkbox"/> Default	A normal mode for standard shades of color and brightness.
	Game	A mode suited for images of games or animations.
	Presentation	An Advanced chromogenic mode for vivid projection of documents such as charts in computers or catalogs.
	Bright (Max)	A mode for brighter projection.

**Note**

- Color in the presentation mode may differ from original. Please use the photo mode for true color reproduction.

Setting up User mode

User mode allows the color balance to be adjusted by setting color temperature, color gamut and gamma of the image.

Icon	Name	Options/ Adjustable range	Description
	Color temperature	Lo: 5,000K, Mid: 6,000K Hi: 9,300K	Lower color temperature projects warm color. Higher color temperature projects cold color.
	Color gamut	Std : sRGB Standard color gamut for Windows environment. Wide : AdobeRGB Color gamut with wider G coverage that can express vibrant green color.	Color gamut allows you to set up recognizable color coverage for sRGB or AdobeRGB.
	Gamma	Gamma Y=1.9, Y=2.2, Y=2.4	Gray scale brightness. Lower value projects a brighter image.

1. Select the User mode

Select the icon  with the < > buttons on the remote control or on the control panel.

Press the  button to execute the selection. The “User setting” menu will be displayed.

User setting menu

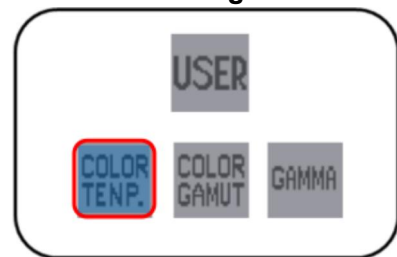

2. Set the Color temperature

Select the icon  with the < > buttons.

Press the  button to execute the selection. The “Color temperature setting” menu will be displayed.

Select the color temperature with the < > buttons.

Lo:5,000K, Mid:6,500K, Hi:9,300K

Color temperature setting menu

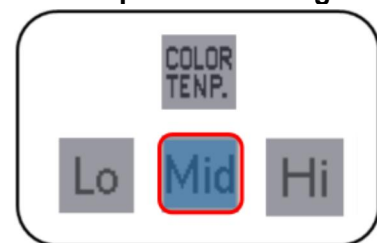

Press the  button to execute the correction.

Press the MENU button to return to the User setting menu.

3. Set the Color gamut

Select the icon  with the < > buttons on the remote control or on the control panel. The “Color gamut Setting” menu will be displayed.

Select the color gamut with the < > buttons.

Std: sRGB, Wide: Adobe RGB equivalent

Press the  button to execute the correction.

Press the MENU button to return to the User setting menu.

Color gamut Setting menu



4. Set the Gamma

Select the icon  with the < > buttons on the remote control or on the control panel. The “Gamma Setting” menu will be displayed.

Select the gamma with the < > buttons.

Gamma: $\gamma=1.9$, $\gamma=2.2$, $\gamma=2.4$

Press the  button to execute the correction.

Press the MENU button to return to the User setting menu.

Gamma Setting menu

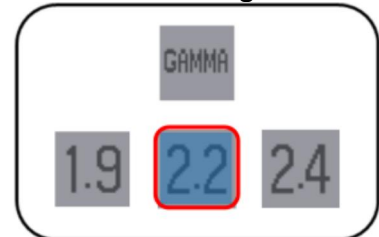

5. Close the menu

After setting up the user set up menu, press the MENU button in the control panel or remote control to go back to the display mode menu.

Press the MENU button in the display mode menu to return to the main menu. Press the MENU button again to close the main menu.

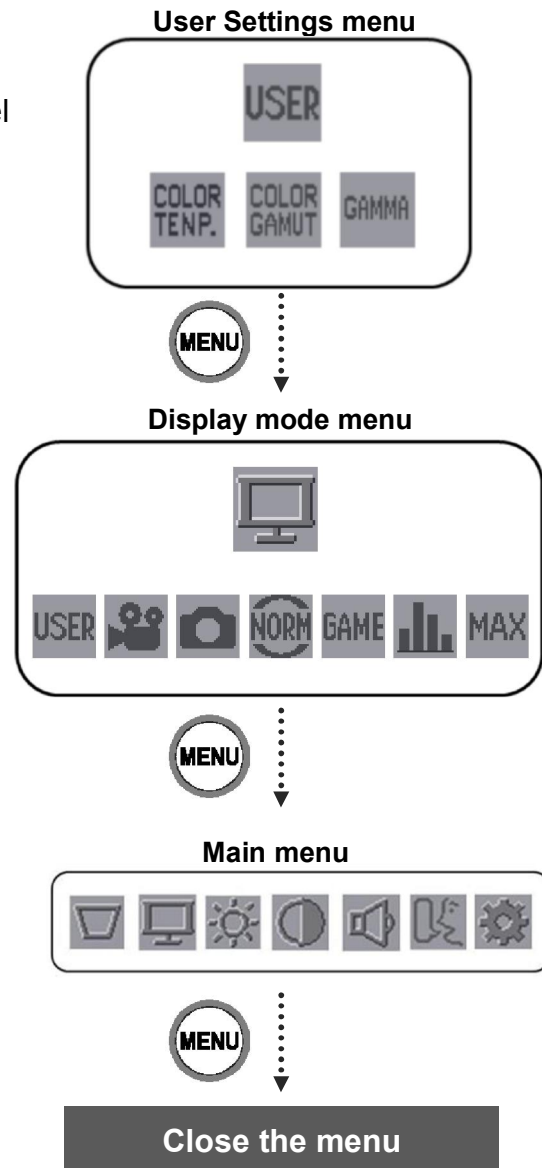

Note

- Display mode is in effect when showing input images. Image input is necessary to change settings. Settings cannot be changed without image input.
- The menu will be automatically closed after 30 seconds of no operation. Press the MENU button again to display the menu.

ADJUSTING THE BRIGHTNESS

1. Display the “Main” menu.

Refer to “Displaying the main menu” (Page39).

Press the MENU button on the remote control or on the control panel.

The main menu will be displayed.

- ### 2. Select the icon with the < > buttons on the remote control or on the control panel.





Press the  button to execute the selection.

The “Brightness adjustment” window will be displayed.

- ### 3. Adjust the brightness with the < > buttons on the remote control or on the control panel.

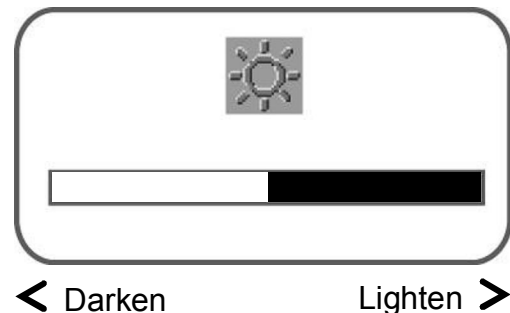
Brightness adjustment window



Press the  button to execute the adjustment and return to the main menu.



Note

- The brightness adjustment cannot be done from the “Input source standby” screen.

ADJUSTING THE CONTRAST

1. Display the “Main” menu.

Refer to “Displaying the main menu” (Page39).

Press the MENU button on the remote control or on the control panel.

The main menu will be displayed.

2. Select the icon with the < > buttons on the remote control or on the control panel.

Press the  button to execute the selection.

The “Contrast adjustment” window will be displayed.

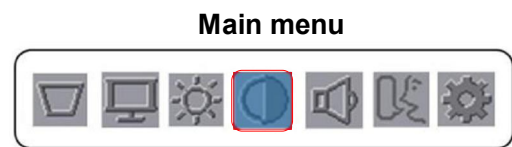

3. Adjust the contrast with the < > buttons on the remote control or on the control panel.

Press the  button to execute the adjustment and return to the main menu.

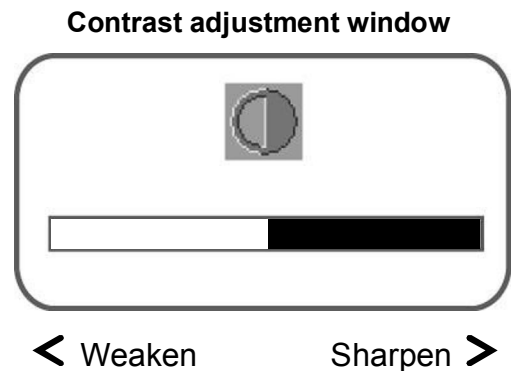

Note

- The contrast adjustment cannot be done from the “Input source standby” screen.

CONTROLLING THE VOLUME

Volume setting

1. Display the “Main” menu.

Refer to “Displaying the main menu” (Page39).

Press the MENU button on the remote control or on the control panel.

The main menu will be displayed.

2. Select the icon  with the < > buttons on the remote control or on the control panel.

Press the  button to execute the selection.

The “Volume setting” window will be displayed.



3. Adjust the volume with the < > buttons on the remote control or on the control panel.

Press the  button to execute the adjustment and return to the main menu.

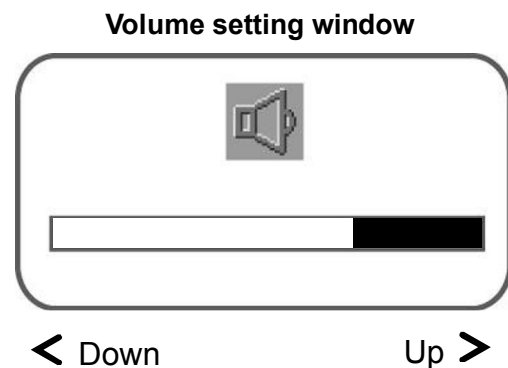

Turning off the sound (MUTE)

You can temporarily mute the sound with the MUTE button on the remote control.

Refer to “Turning off the sound” (Page34)

SETTING THE LANGUAGE

Set the language to be used for the menus.

1. Display the “Main” menu.

Refer to “Displaying the main menu” (Page39).

Press the MENU button on the remote control or on the control panel.

The main menu will be displayed.

2. Select the icon  with the < > buttons on the remote control or on the control panel.

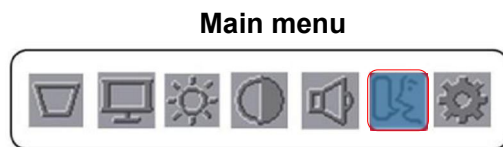

Press the  button to execute the selection.

The “Language” menu will be displayed.

3. Select the language with the < > buttons on the remote control or on the control panel.

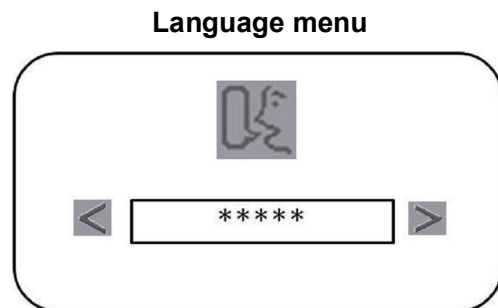

Press the  button to execute the selection and return to the main menu.

The following language can be selected.

Language	English	French
	German	Spanish
	Italian	Swedish
	Dutch	Portuguese
	Russian	Japanese
	Simplified Chinese	

DETAIL SETTINGS

The following items can be configured:

ECO mode/ Aspect ratio setting / Auto power off/ Projection mode/ Installation mode/
CEC mode/Factory settings

Various information can be obtained from this screen.
Refer to “Checking various information” (Page55).

Displaying the detail settings

1. Display the “Main” menu.

Refer to “Displaying the main menu” (Page39).

Press the MENU button on the remote control or on the control panel.

The main menu will be displayed.

2. Select the icon  with the < > buttons on the remote control or on the control panel.

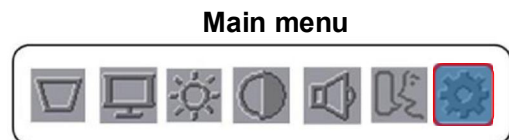

Press the  button to execute the selection.





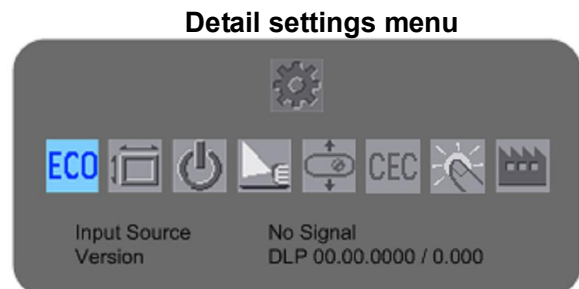

The “Detail settings” menu will be displayed.

3. Select the item to be configured with the < > buttons on the remote control or on the control panel.



Press the  button to display the setting menu of the selected item.

Press the MENU button to return to the main menu.

Icon	Name	Options	Description
	ECO mode setting →P.55	On	Set the ECO mode. When the projector is in the ECO mode, the LED brightness and fan noise will decrease.
		Off <input type="checkbox"/> Default	
	Aspect ratio setting →P.56	Auto <input type="checkbox"/> Default	Set the horizontal to vertical ratio of the input signal.
		4:3	
		16:9	
	Auto power off setting →P.57	Off	Automatically turn off the projector after a certain period of no operation.
		1 ~ 180 <input type="checkbox"/> Default 180	
	Projection mode setting →P.58	Front <input type="checkbox"/> Default	Set whether to project images from the front of the screen or from the rear of the screen.
		Rear	
	Installation mode setting →P.59	Desktop <input type="checkbox"/> Default	Set how to install the projector.
		Ceiling	
	CEC mode setting →P.60	ON	Set the CEC mode. Setting up CEC mode allows you to operate the projector in conjunction with a CEC compatible HDMI device.
		OFF <input type="checkbox"/> Default	
	Factory settings →P.62	Yes	Return all settings to factory default.
		No	

Checking various information

1. Display the “Detail settings” menu.

The following information can be viewed.

Detail settings menu

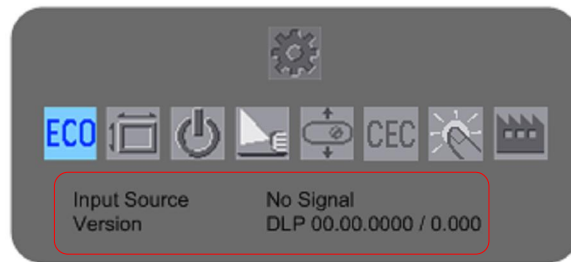

Information	Description
Input Source	The current input source will be displayed.
Version	The firmware version of the projector will be displayed.

Setting the ECO mode

1. Display the “Detail settings” menu.

Detail settings menu



2. Select the icon  with the **< >** buttons on the remote control or on the control panel.

Press the  button to execute the selection.

The “ECO mode setting” menu will be displayed.

3. Select “ON” or “OFF” with the **< >** buttons on the remote control or on the control panel.

ECO mode setting menu

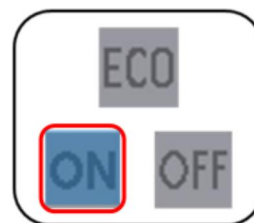

Setting	Description
ON	To activate the ECO mode.
OFF	To cancel the ECO mode. <u>Default</u>

Press the  button to execute the selection and return to the “Detail settings” menu.

Selecting the aspect ratio

1. Display the “Detail settings” menu.

Detail settings menu



2. Select the icon  with the < > buttons on the remote control or on the control panel.

Press the  button to execute the selection.



The “Aspect ratio setting” menu will be displayed.

3. Select the aspect ratio with the < > buttons on the remote control or on the control panel.

Aspect ratio setting menu



The following aspect ratio can be selected.

Icon	Description
	Display the input signal in its original aspect ratio. Default
	Display the input signal in 4:3 aspect ratio.
	Display the input signal in 16:9 aspect ratio

Press the  button to execute the selection and return to the “Detail settings” menu.



Note

- The aspect ratio setting will not be saved. It will be reset to “AUTO” when the projector is restarted.

Setting the auto power off

1. Display the “Detail settings” menu.

Detail settings menu



2. Select the icon  with the < > buttons on the remote control or on the control panel.

Press the  button to execute the selection.

The “Auto power off setting” menu will be displayed.

3. Select the auto power off time with the < > buttons on the remote control or on the control panel.

Auto power off setting menu

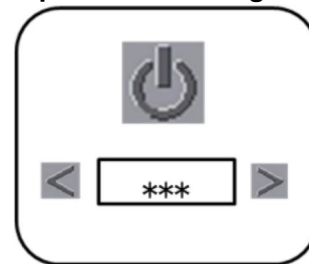

The following auto power off time can be selected.

Auto power off time	Off (Disable the auto power off function)
	1 minute
	3 minutes
	5 minutes
	10 minutes
	20 minutes
	30 minutes
	60 minutes
	120 minutes
	180 minutes Default

Press the  button to execute the selection and return to the “Detail settings” menu.

When the auto power off function is enabled, the projector will be turned off automatically after no operation is performed, either from the control panel or from the remote control, for a preset amount of time.

The message as shown in the right picture will be displayed 30 seconds before the projector is turned off automatically.

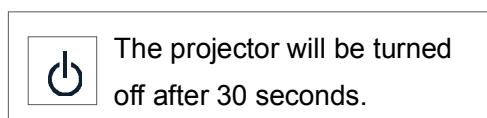

Selecting the projection mode

1. Display the “Detail settings” menu.

Detail settings menu



2. Select the icon  with the < > buttons on the remote control or on the control panel.



Press the  button to execute the selection.

The “Projection mode setting” menu will be displayed.

3. Select “Front” or “Rear” with the < > buttons on the remote control or on the control panel.

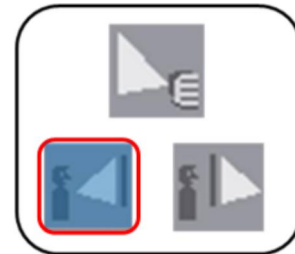
Projection mode setting menu



Icon	Mode	Description
	Front	To be used when the projector is placed in front of a screen. <u>Default</u>
	Rear	To be used when the projector is placed behind a screen.

Press the  button to execute the selection and return to the “Detail settings” menu.

Selecting the installation mode

1. Display the “Detail settings” menu.

Detail settings menu





2. Select the icon  with the < > buttons on the remote control or on the control panel.

Press the  button to execute the selection.

The “Installation mode setting” menu will be displayed.

3. Select “Desktop” or “Ceiling” with the < > buttons on the remote control or on the control panel.

Installation mode setting menu

Icon	Mode	Description
	Desktop	To be used when the projector is installed in the desktop mount position. <u>Default</u>
	Ceiling	To be used when the projector is installed to the ceiling.



Press the  button to execute the selection and return to the “Detail settings” menu.

CAUTION

- Do not place the projector on an unstable cart, stand, or table. Doing so may cause the projector to fall down or tip over.
- Installation work (such as ceiling suspension) should only be carried out by a qualified technician. If installation is not carried out correctly, the projector may fall, causing injury or accident. Contact a qualified technician or your dealer for installation.

Setting the CEC mode

1. Display the “Detail settings” menu.

Detail settings menu



2. Select the icon **CEC** with the **< >** buttons on the remote control or on the control panel.

Press the **↵** button to execute the selection.

The “CEC mode setting” menu will be displayed.

3. Select “ON” or “OFF” with the **< >** buttons on the remote control or on the control panel.

CEC mode setting menu

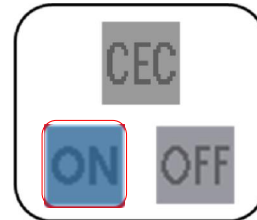

Setting	Description
ON	To activate the CEC mode.
OFF	To cancel the CEC mode. Default

Press the **↵** button to execute the selection and return to the “Detail settings” menu.



Note

- Setting up CEC mode allows you to operate the projector in conjunction with a connected CEC compatible HDMI device.
Turn on the CEC mode and start the CEC compatible HDMI device this will power on the projector.
Powering off the projector will turn off the power off the HDMI device as well.

Selecting the Backlight Brightness mode

1. Display the “Detail settings” menu.

Detail settings menu



2. Select the icon  with the < > buttons on the remote control or on the control panel.

Press the  button to execute the selection.

The “Backlight Brightness mode setting” menu will be displayed

3. Select “ON” or “OFF” with the < > buttons on the remote control or on the control panel.

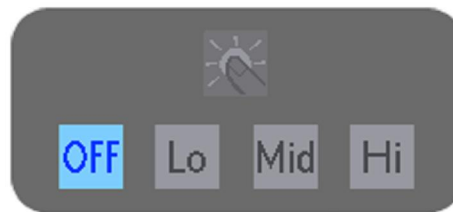

	Setting	Item	Description
1	OFF	OFF	Always turn the LED off.
2	Lo	Lo	Turn the LED to its lowest brightness level.
3	Mid	Mid	Turn the LED to its medium brightness level.
4	Hi	Hi	Turn the LED to its highest brightness level.

Press the  button to execute the selection and return to the “Detail settings” menu.

Returning to the factory settings

1. Display the “Detail settings” menu.

Detail settings menu





2. Select the icon  with the < > buttons on the remote control or on the control panel.

Press the  button to execute the selection.

The “Factory settings” menu will be displayed.

3. Select “Yes” or “No” with the < > buttons on the remote control or on the control panel.

Icon	Description
	Return to the factory settings.
	Do not return to the factory settings.

Factory settings menu

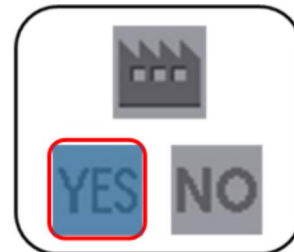

Press the  button to execute the selection.

Select "YES" to return to factory default settings.

When configuration is completed, the screen returns to start menu.

Select "NO" and press the  button returns to the "Detail settings" menu.

Refer to “MAIN MENU” (Page41) for the default values for each setting item.

4 MAINTENANCE

This section describes the simple maintenance procedures you should follow to clean the lens, the cabinet and the remote control.

CLEANING THE LENS, THE CABINET AND THE REMOTE CONTROL

Cleaning the lens

1. Before starting the cleaning, turn off the projector, disconnect the power cord and then allow the cabinet to cool.
2. Wipe the lens with commercial lens-cleaning paper.

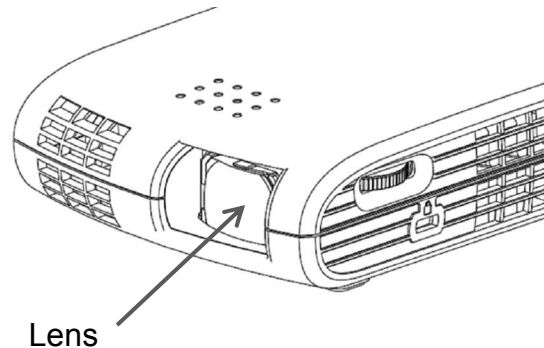

CAUTION

- Do not look into the lens during the projection. The strong light emitted from the lens may cause damage to your eyes.
- The lens surface is easily damaged. Do not rub the lens with a hard material or hit it.

Cleaning the cabinet and the remote control

<Cleaning the cabinet>

1. Before starting the cleaning, turn off the projector, disconnect the power cord and then allow the cabinet to cool.
2. Gently wipe the cabinet with a soft cloth like gauze. If the cabinet is particularly dirty, soak the soft cloth in water with a small amount of neutral detergent in it, squeeze the cloth very well, and then wipe the cabinet. After cleaning, gently wipe the cabinet with a dry cloth.

<Cleaning the remote control>

Wipe the dirt off the remote control with a dry soft cloth.



CAUTION

- Do not use solvents such as alcohol, benzene or thinner as they may mar the finish of the case, causing electric shock.
- Do not apply volatile materials such as insecticide on the cabinet. Do not leave a rubber, sticky tape or vinyl product in prolonged contact with it. Otherwise, the surface finish will be deteriorated or the coating may be stripped off.
- The surface of the cabinet is easily scratched. Do not rub the cabinet with a hard material or hit it.

CLEANING THE INSIDE OF THE PROJECTOR

Continued use with dust inside may result in fire, electric shock, malfunction or deteriorated image. For the safe use of the projector, have it cleaned and inspected by your dealer at least once a year. Ask your dealer for the maintenance fee.



CAUTION

- Do not clean the inside of the projector by yourself. There are high-voltage components inside and you could injure yourself or damage the projector.

5 TROUBLESHOOTING



INDICATOR ICONS

During use of the projector, the following icons may appear at the bottom right of the screen to warn you or indicate errors. When the icon appears, follow the instructions described in the table below.

If the same icon still appears after following the above instructions, contact your dealer.

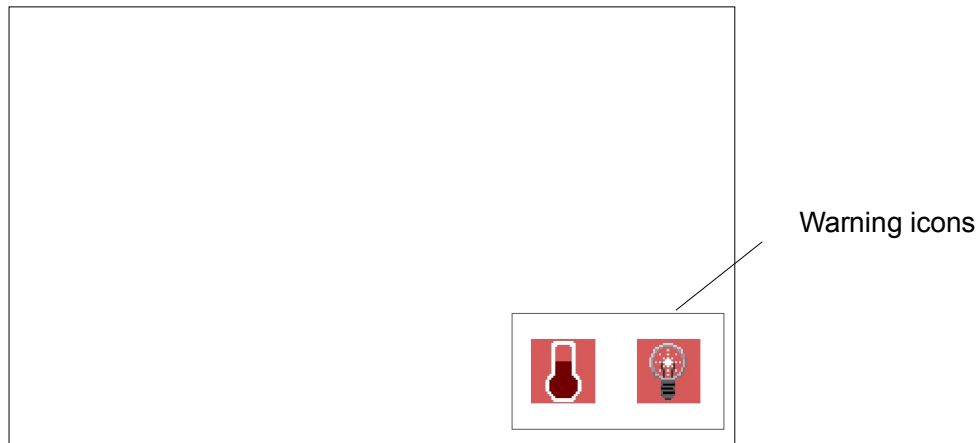

Example of the warning indication

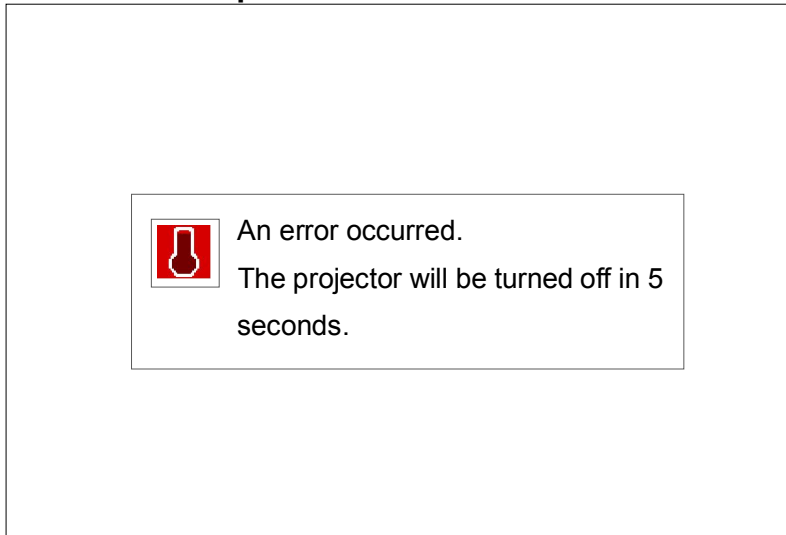

Icon	Description	Solution
<p>Temperature warning</p> 	<p>The internal temperature has been increased.</p> <p>This icon will be displayed for 10 seconds every 5 minutes.</p>	<p>Turn off the projector immediately and allow the projector to cool down for at least 30 minutes. Make sure of the following and turn on the projector:</p> <ul style="list-style-type: none"> - The ventilator is not blocked by objects or in any way obstructed. - The ventilator is not covered with dust. - The peripheral temperature is not exceeding 35°C.
<p>LED brightness degradation</p> 	<p>The brightness of the LED is decreased. It is the time to replace the LED lamp. If you continue to use the projector without replacing the lamp, the brightness will decrease continuously.</p> <p>This icon will be displayed once after the projector is turned on.</p>	<p>Contact your dealer for repair.</p>

Example of the error indication



Icon	Description	Solution
<p>Temperature error</p> 	<p>The internal temperature has been increased. The projector will be turned off in 5 seconds.</p>	<p>Turn off the projector immediately and allow the projector to cool down for at least 30 minutes. Make sure of the following and turn on the projector:</p> <ul style="list-style-type: none"> - The ventilator is not blocked by objects or in any way obstructed. - The ventilator is not covered with dust. - The peripheral temperature is not exceeding 35°C.
<p>FAN error</p> 	<p>There is a problem with the internal fan. The projector will be turned off in 5 seconds.</p>	<p>Turn off the projector immediately and allow the projector to cool down for at least 30 minutes. Make sure of the following and turn on the projector:</p> <ul style="list-style-type: none"> - No foreign objects are inserted between the rotating fan blades. - There are no magnetic objects near the projector.



CAUTION



- Using the projector in places where the temperature is high or where there is a lot of dust or smoke, or using it continuously for long hours for business purposes may deteriorate the performance or the quality of the projector after less than 1 year of use depending on the life of the components.
- In such cases, contact your dealer for chargeable repair.

TEMPERATURE & WARNING INDICATOR DISPLAY

The warning indicators indicate the status of the internal temperature and the internal fan, by flashing or by lighting.

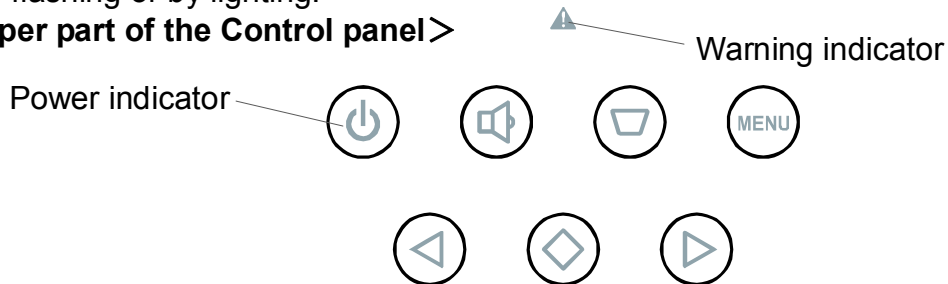
< Upper part of the Control panel >



Temperature indicator (Red)		Solution
	On	An abnormal temperature inside the projector is detected. Turn off the projector immediately and allow the projector to cool down for at least 30 minutes. Make sure of the following and turn on the projector: - The ventilator is not blocked by objects or in any way obstructed. - The ventilator is not covered with dust. - The peripheral temperature is not exceeding 35°C.
	Flashing *Flashing every 0.25 seconds.	Either an abnormal rise of temperature inside the projector is detected. The internal temperature is in a rise. Follow the instructions described in "INDICATOR ICONS" (Page65).
	Off	-
 Warning indicator (Red)		Solution
	Flashing *Flashing every 0.25 seconds.	There is something wrong with the internal fan. Turn off the projector immediately and allow the projector to cool down for at least 30 minutes. Make sure of the following and turn on the projector: - No foreign objects are inserted between the rotating fan blades. - There are no magnetic objects near the projector.
	Flashing *Flashing every second.	Either an abnormal the brightness of the LED is decreased. The state to which the light volume of LED fell. Follow the instructions described in "INDICATOR ICONS" (Page65).
	Off	-

COMMON PROBLEMS AND CHECK ITEMS

The following problems may not be caused by malfunction of the projector. Check the items in the table below before requesting a repair service.

If the problem still persists, contact your dealer.

Problem	Check item	Related Page
No power.	<ul style="list-style-type: none"> ➔ Is the power cord connected to the outlet correctly? ➔ Is there electricity to the outlet? ➔ Is the AC adapter connected correctly? ➔ Is the power cord damaged? ➔ Is the temperature of the projector too high? ➔ If the temperature of the projector is too high, the projector does not turn on for protection. 	→P.23 →P.23 →P.23 →P.23 →P.65,67 →P.65,67
Power turns off automatically.	<ul style="list-style-type: none"> ➔ Is the warning icon displayed before the projector is turned off? ➔ Is the indicator flashing? ➔ Is the auto power off function enabled? (Default setting : 180 minutes) 	→P.65 →P.67 →P.57
No image.	<ul style="list-style-type: none"> ➔ Is the projector in the blank screen mode? ➔ Is the cable connected to the input terminal correctly? ➔ Is the video signal output from the connected video source? ➔ Is the contrast setting set to minimum? ➔ Is the input signal supported by the projector? 	→P.35 →P.24 →P.37,50 →P.72
Image is dark.	<ul style="list-style-type: none"> ➔ Is the brightness adjusted correctly? ➔ Is the projector in the ECO mode? ➔ Is the LED lamp approaching to the end of its life time? 	→P.36,49 →P.38,55 →P.65,67
Image is distorted.	<ul style="list-style-type: none"> ➔ Is the projector installed correctly? ➔ If there is keystone distortion, perform the keystone correction. 	→P.20 →P.30,43

Problem	Check item	Related Page
Image is blurred.	<ul style="list-style-type: none"> ➔ Is the lens correctly adjusted? ➔ Is the projector placed correctly to the screen? ➔ Is the lens dirty? ➔ Is there condensation on the lens? ➔ Is the distance between the projector and the screen within the adjustable range of the focus? 	<ul style="list-style-type: none"> →P.29 →P.20 →P.63 →P.63 →P.29
Image is unstable.	<ul style="list-style-type: none"> ➔ Is the video cable connected correctly? ➔ Is the video cable damaged? 	<ul style="list-style-type: none"> →P.24 →P.24
Bright dots or black dots in the image.	<ul style="list-style-type: none"> ➔ This is a common problem peculiar to the display device. This is not a malfunction. 	
Vertical stripes in the image.	<ul style="list-style-type: none"> ➔ This is due to the interference with the screen. This is not a malfunction. 	
Color is uneven.	<ul style="list-style-type: none"> ➔ This is due to the diffraction of light which is peculiar to the projector. This is not a malfunction. 	
No sound.	<ul style="list-style-type: none"> ➔ Is the volume set to mute? ➔ Is the volume adjusted to low? ➔ Is the sound output from the connected video source? 	<ul style="list-style-type: none"> →P.34 →P.32
Remote control cannot be operated.	<ul style="list-style-type: none"> ➔ Is there enough remaining battery for the remote control? ➔ Is the polarity of the battery set correctly? ➔ Is there any obstacle between the IR transmitter of the remote control and the IR receiver of the projector? ➔ Is the remote control used within its operating range? ➔ Is the IR transmitter aimed at the IR receiver? ➔ Is the remote control receiving influence from the fluorescent light? 	<ul style="list-style-type: none"> →P.17 →P.17 →P.19 →P.19 →P.19 →P.19
Indicator flashes.	<ul style="list-style-type: none"> ➔ Refer to the list of indicators. 	→P.67

6 SPECIFICATIONS

SPECIFICATIONS

MODEL		T-200
Display technology		Single-chip DLP
Display device	Size	0.45 type
	Resolution	1,280×800 (WXGA)
	Aspect ratio	16:10
Lens	Focus adjustment	Manual
	Focal length	f = 9.05mm
	F number	F 2.04
Lamp		3 LED (R,G,B)
Screen size (projection distance)		25 ~ 68 inches (0.48 ~ 1.33 m)
Projection method (can be selected from the menu)		Front/ Rear/ Desktop/ Ceiling
Brightness		150 lm
Contrast ratio (full white/ full black)		1,000:1 (JIS X 6911) (10,000:1 According to our company's measurement standard.)*
Color reproduction		Full color 16,770,000 colors
Audio output		1W monaural speaker
Audio output terminal		Head Phone output Terminal (min16Ω)
In/out terminals	HDMI	HDMI Type A×1 (HDCP compliant)
Operation environment	Temperature	5°C ~ 35 °C
	Humidity	85% (max.)
	Storage temperature	-20°C~ +60°C
	Storage humidity	90% (max.) (no condensation)
Input voltage		DC12V~19V
Power (Supplied)	AC adapter	Input:AC90~264V、50~60Hz Output:DC12V
	Power consumption	36W(DC12V, 3.0A) (ECO MODE OFF / Bright(MAX) / with USB power supply 2A) 25W(DC12V, 2.1A) (ECO MODE OFF / Bright(MAX) / without USB power supply 2A)
	USB power supply(DC)	Output Voltage 5V 5% Output Current 2A(Max.)
External dimensions		95 mm (W) x 153 mm (D) x 36 mm (H* including the rubber foot)
Weight		300g

* The contrast ratio between the maximum white luminance and the minimum black luminance for the projection system.

Remote control

Power	DC 3V (Button battery: CR2032)
Operating range	6m
External dimensions	50 mm x 90 mm x 10 mm
Weight	28.5g (including battery)

Supplied accessories

- Remote control *with a battery inserted 1pce
- Power cord 1pce
- AC adapter 1pce
- HDMI Cable 1pce
- Important safeguard& Quick start guide 1pce
- Warranty card 1pce

LIST OF COMPATIBLE SIGNALS

The following system modes are available with the projector.

The projector will detect the input signal and select the appropriate system mode automatically.

Computer signal input format (for HDMI)

Signal mode	Resolution (H x V)	Horizontal frequency (kHz)	Vertical frequency (Hz)
640 × 350	640 × 350	31.5	70.1
TEXT (70Hz)	720 × 400	37.9	70.0
TEXT (85Hz)	720 × 400	37.9	85.0
VGA (60Hz)	640 × 480	31.5	59.9
640 × 480 (67Hz)	640 × 480	35.0	66.7
VGA (72Hz)	640 × 480	37.9	72.8
VGA (75Hz)	640 × 480	37.5	75.0
VGA (85Hz)	640 × 480	43.3	85.0
SVGA (56Hz)	800 × 600	35.2	56.3
SVGA (60Hz)	800 × 600	37.9	60.3
SVGA (72Hz)	800 × 600	48.1	72.2
SVGA (75Hz)	800 × 600	46.9	75.0
SVGA (85Hz)	800 × 600	53.7	85.1
832 × 624 (75Hz)	832 × 624	49.7	74.5
XGA (60Hz)	1024 × 768	48.4	60.0
XGA (70Hz)	1024 × 768	56.5	70.1
XGA (75Hz)	1024 × 768	60.0	75.0
XGA (85Hz)	1024 × 768	68.7	85.0
1152 × 864 (75Hz)	1152 × 864	67.5	75.0
1152 × 870 (75Hz)	1152 × 870	68.7	75.1
W-XGA(60Hz)	1280 × 768	47.7	60.0
1280×800 (60Hz)	1280 × 800	49.7	60.0
1280×800 (75Hz)	1280 × 800	62.8	74.9
1280×800 (85Hz)	1280 × 800	71.6	84.8
1280×960 (60Hz)	1280 × 960	60.0	60.0
1280×960 (85Hz)	1280 × 960	85.9	85.0
SXGA (60Hz)	1280 × 1024	64.0	60.0
SXGA (75Hz)	1280 × 1024	80.0	75.0

Signal mode	Resolution (H x V)	Horizontal frequency (kHz)	Vertical frequency (Hz)
1360×768(60Hz)	1360 × 768	47.7	60.0
SXGA+ (60Hz)	1400 × 1050	65.3	60.0
WXGA+(60Hz)	1440 × 900	55.9	59.9
WXGA+(75Hz)	1440 × 900	70.6	75.0
WSXGA+(60Hz)	1680 × 1050	65.3	60.0

Video signal input format (for HDMI)

Signal mode	Resolution (H x V)	Horizontal frequency (kHz)	Vertical frequency (Hz)
480i	720 × 480	15.73	59.94
480i	720 × 480	15.75	60.00
480p	720 × 480	31.47	59.94
480p	720 × 480	31.50	60.00
576i	720 × 575	15.63	50.00
576p	720 × 575	31.26	50.00
720p	1280 × 720	37.50	50.00
720p	1280 × 720	44.95	59.94
720p	1280 × 720	45.00	60.00
1080i	1920 × 1080	28.13	50.00
1080i	1920 × 1080	33.71	59.94
1080i	1920 × 1080	33.75	60.00
1080p	1920 × 1080	26.97	23.98
1080p	1920 × 1080	27.00	24.00
1080p	1920 × 1080	56.25	50.00
1080p	1920 × 1080	67.43	59.94
1080p	1920 × 1080	67.50	60.00
1080p	1920 × 1080	67.5	60.0



Note

- An image with higher resolution will be compressed and displayed
- When the image is compressed, the thickness of the characters or lines may not be uniform or the color may be blurred.
- Depending on the computer used, some adjustments may be needed. Refer to “DETAIL SETTINGS” (Page53) for details.

TRADEMARKS

- **ELMO** is a registered trademark of ELMO Co., Ltd.
- DLP(Digital Light Processing) is a trademark of Texas Instruments.
- VGA, XGA, and SXGA are trademarks or registered trademarks of International Business Machines Corp.
- iPhone and iPad are trademarks or registered trademarks of Apple Inc. in the U.S. and other countries.
- iOS is a trademark or registered trademark of Cisco Systems Inc. in the U.S. and other countries.
- HDMI, **HDMI**™ logo and High-Definition Multimedia interface are trademarks or registered trademarks of HDMI Licensing LLC.
- Microsoft, Windows, Word, Excel and PowerPoint are trademarks or registered trademarks of Microsoft Corporation in the U.S. and other countries.
- Adobe PDF is a trademark or registered trademark of Adobe Systems Incorporated in the U.S. and other countries.
- All other company/ product names described in this manual are trademarks or registered trademarks of their respective companies.

7 WARRANTY AND AFTER SALES SERVICE

[LIMITED WARRANTY AND REPAIR]

■ WARRANTY PERIOD

We offer you a 1 year limited warranty on our product, from the date of the original purchase (“Warranty Period”).

Keep the warranty card included in the product package in a safe place.

Faults reported outside of the Warranty Period are subject to a chargeable repair.

■ WARRANTY COVERAGE

This warranty shall apply only when the projector is used under the conditions and in the manner intended by ELMO as specified in the instruction manual during the Warranty Period.

■ EXCLUSIONS AND LIMITATIONS

This warranty does not cover the following:

(1) Failure or damage caused by misuse, improper application, wrong operation other than specified in the instruction manual;

(2) Failure or damage resulting from repair, modification or cleaning by disassembling by someone other than authorized service center;

(3) Failure or damage caused by mud, sand, water, dropping or impact;

(4) Failure or damage caused by fire, salt, gas, earthquake, wind, flood, environmental pollution, lightning, electrical surges or other natural disasters;

(5) Failure or damage that occurs in shipment or during transportation after the purchase or the failure or damage caused by dropping or improper storage after the purchase;

(6) When the warranty card is lost; and

(7) If the information such as the name of the shop and the date of purchase is altered.

■ REPAIR CONDITIONS

(1) The warranty repair is available only for products manufactured by ELMO.

(2) We do not provide on-site repair service. Faulty units have to be brought to our customer service or to be sent to our customer service at customer’s expenses.

(3) Contact our customer service (described below) when you need repair service.

■ **[OTHER CUSTOMER SERVICE]**

■ **Customer service**

You can inquire the following inquiries about the projector to our customer service;

- (1) About repair service
- (2) About instruction of use, sale or other issues

Touchboards

205 Westwood Ave, Long Branch, NJ 07740

Phone: 866-94 BOARDS (26273) / (732)-222-1511

Fax: (732)-222-7088 | E-mail: sales@touchboards.com

