

ELMO

VISUAL PRESENTER

MX-P2

INSTRUCTION MANUAL

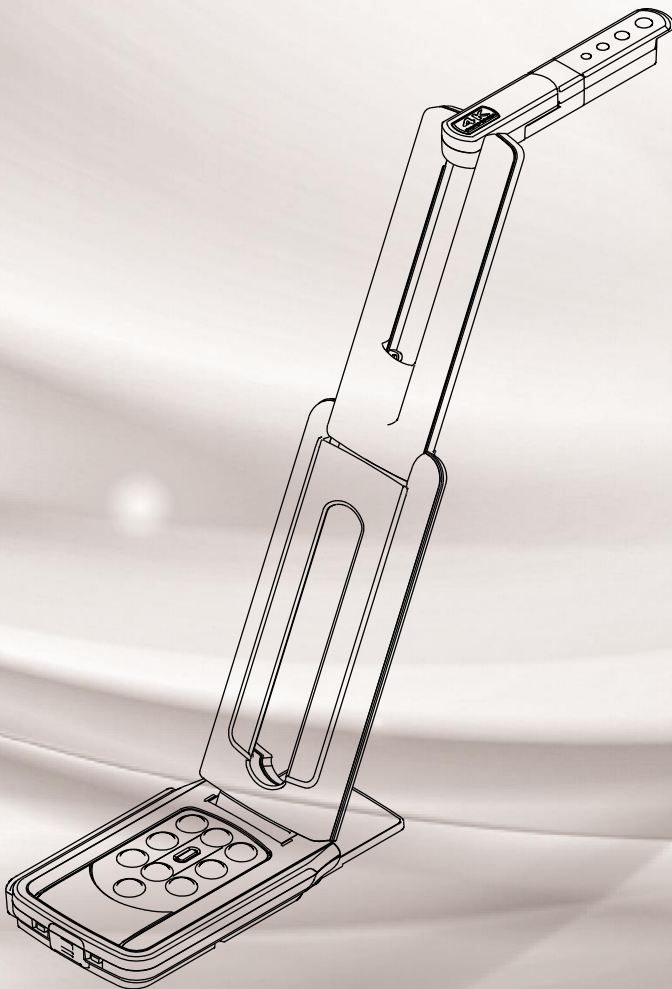

4K
Ultra High Definition

■ IMPORTANT SAFEGUARDS

■ Read Instructions

All the safety and operating instructions should be read before the appliance is operated.

■ Retain Instructions

The safety and operating instructions should be retained for future reference.

■ Heed Warnings

All warnings on the product and in the operating instructions should be adhered to.

■ Follow Instructions

All operating and use instructions should be followed.

■ Cleaning

Unplug this product from the wall outlet before cleaning. Do not use liquid cleaners or aerosol cleaners. Use a damp cloth for cleaning.

■ Attachments

Do not use attachments not recommended by the product manufacturer as they may cause hazards.

■ Water and Moisture

Do not use this product near water -for example, near a bath tub, wash bowl, kitchen sink, or laundry tub, in a wet basement, or near a swimming pool, and the like.

■ Placement

Do not place this product on an unstable cart, stand, tripod, bracket, or table. The product may fall, causing serious injury to a child or adult, and serious damage to the product. Use only with a cart, stand, tripod, bracket, or table recommended by the manufacturer, or sold with the product. Any mounting of the product should follow the manufacturer's instructions, and should use a mounting accessory recommended by the manufacturer.

■ Ventilation

Slots and openings in the cabinet are provided for ventilation and to ensure reliable operation of the product and to protect it from overheating, and these openings must not be blocked or covered. The openings should never be blocked by placing the product on a bed, sofa, rug, or other similar surface. This product should not be placed in a built-in installation such as a bookcase or rack unless proper ventilation is provided or the manufacturer's instructions have been adhered to.

■ Power Sources

This product should be operated only from the type of power source indicated on the marking label. If you are not sure of the type of power supply to your home consult your appliance dealer or local power company. For products intended to operate from battery power, or other sources, refer to the operating instructions.

■ Grounding or Polarization

This product may be equipped with either a polarized 2-wire AC line plug (a plug having one blade wider than the other) or a 3-wire grounding type plug, a plug having a third (grounding) pin. If the 2-Wire polarized plug will not fit in the outlet, try reversing the plug. If the plug still fails to fit, contact your electrician to replace your obsolete outlet. Do not defeat the safety purpose of the polarized plug. The 3-wire grounding type plug will fit into a grounding type power outlet.

This is a safety feature. If you are unable to insert the plug into the outlet, contact your electrician to replace your obsolete outlet. Do not defeat the safety purpose of the grounding type plug.

■ Power-Cord Protection

Power-supply cords should be routed so that they are not likely to be walked on or pinched by items placed upon or against them, paying particular attention to cords at plugs, convenience receptacles, and the point where they exit from the product.

■ Lightning

For added protection for this product during a lightning storm, or when it is left unattended and unused for long periods of time, unplug it from the wall outlet and disconnect the antenna or cable system. This will prevent damage to the product due to lightning and power-line surges.

■ Overloading

Do not overload wall outlets, extension cords, or integral convenience receptacles as this can result in a risk of fire or electric shock.

■ A product and cart combination should be moved with care.

Quick stops, excessive force, and uneven surfaces may cause the product and cart combination to overturn.



■ Object and Liquid Entry

Never push objects of any kind into this product through openings as they may touch dangerous voltage points or short-out parts that could result in a fire or electric shock. Never spill liquid of any kind on the product.

■ Servicing

Do not attempt to service this product yourself as opening or removing covers may expose you to dangerous voltage or other hazards. Refer all servicing to qualified service personnel.

■ Damage Requiring Service

Unplug this product from the wall outlet and refer servicing to qualified service personnel under the following conditions:

- When the power-supply cord or plug is damaged.
- If liquid has been spilled, or objects have fallen into the product.
- If the product has been exposed to rain or water.
- If the product does not operate normally by following the operating instructions. Adjust only those controls that are covered by the operating instructions as an improper adjustment of other controls may result in damage and will often require extensive work by a qualified technician to restore the product to its normal operation.
- If the product has been dropped or damaged in any way.
- When the product exhibits a distinct change in performance -this indicates a need for service.

■ Replacement Parts

When replacement parts are required, be sure the service technician has used replacement parts specified by the manufacturer or have the same characteristics as the original part. Unauthorized substitutions may result in fire, electric shock or other hazards.

■ Safety Check

Upon completion of any service or repairs to this product, ask the service technician to perform safety checks to determine that the product is in proper operating condition.

■ Heat

The product should be situated away from heat sources such as radiators, heat registers, stoves, or other products (including amplifiers) that produce heat.



SA 1965

The lightning flash with arrowhead symbol, within an equilateral triangle, is intended to alert the user to the presence of uninsulated “dangerous voltage” within the product’s enclosure that may be of sufficient magnitude to constitute a risk of electric shock to persons.



SA 1966

The exclamation point within an equilateral triangle is intended to alert the user to the presence of important operating and maintenance (servicing) instructions in the literature accompanying the product.

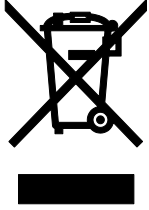

This symbol [crossed-out wheeled bin WEEE Annex IV] indicates separate collection of waste electrical and electronic equipment in the EU countries.
Please do not throw the equipment into the domestic refuse.
Please use the return and collection systems available in your country for the disposal of this product.

WARNING

TO REDUCE THE RISK OF FIRE OR ELECTRIC SHOCK, DO NOT EXPOSE THIS PRODUCT TO RAIN OR MOISTURE.

The connection of a non-shielded equipment interface cable to this equipment will invalidate the FCC Certification or Declaration of this device and may cause interference levels which exceed the limits established by the FCC for this equipment. It is the responsibility of the user to obtain and use a shielded equipment interface cable with this device. If this equipment has more than one interface connector, do not leave cables connected to unused interfaces. Changes or modifications not expressly approved by the manufacturer could void the user's authority to operate the equipment.

FOR UNITED STATES USERS: INFORMATION

This equipment has been tested and found to comply with the limits for a Class A digital device, pursuant to Part 15 of the FCC Rules. These limits are designed to provide reasonable protection against harmful interference when the equipment is operated in a commercial environment.

This equipment generates, uses, and can radiate radio frequency energy and, if not installed and used in accordance with the instruction manual, may cause harmful interference to radio communications. Operation of this equipment in a residential area is likely to cause harmful interference in which case the user will be required to correct the interference at his own expense.

USER-INSTALLER

CAUTION:

Your authority to operate this FCC verified equipment could be voided if you make changes or modifications not expressly approved by the party responsible for compliance to Part 15 of the FCC rules.

USAGE PRECAUTIONS

- Be sure to use the AC adapter.
- The supplied AC adapter is designed for exclusive use with this product. Do not use it with other products.
- Do not press the touchscreen strongly by finger or sharp objects. This can cause damage or malfunction.
- Be careful not to pinch your finger when you move the arm or touchscreen.
- A protective sheet is attached to the surface of the touchscreen. Remove it before you use the product.
- The AC adapter appropriate for the country where it is used is supplied with the product. If the product was sold in Japan, use the AC adapter sold with the product with 100 VAC and 50 or 60 Hz.
- When storing the product, do not leave it under direct sunlight or by heaters. It may be discolored, deformed, or damaged.
- Do not place the product in any humid, dusty, salt bearing wind, or vibrating locations.
- Use it under the following environmental conditions:
Temperature : 0°C~ 40°C Humidity : 30%~ 85%(No condensation)
- Do not use the product in an environment where the temperature of the product becomes too hot, such as under direct sunlight or by heaters. The product will automatically stop the operation to protect the battery when the internal temperature reaches 65°C.
- Use a soft, dry cloth for cleaning. Do not use any volatile solvent such as thinner or benzene.
- Luminescent and Black Spots
There may be some pixels that do not properly operate due to the use of CMOS Area Image Sensors made-up of many pixels.
Though luminescent or black spots may be found on the screen, it is a phenomenon peculiar to the CMOS Area Image Sensors and is not a malfunction.
- Follow the guidelines below to prevent the product from dropping or overturning.
 - Use the product on a stable base, desk, or table. Do not place the product on an unstable base or slanted location.
 - Place or wire the product so as to prevent the cables from being pulled or drawn.
- Do not point the lens directly to the sun. It could degrade the imaging capability.
- Do not look directly into the LED light. If you look directly into it at pointblank range, your eyes may be injured.
- Some type of SD card/USB flash drive can be used.
- Transfer the data saved in the recording media (such as the internal storage, SD card and USB flash drive) to a device such as a PC to save a backup copy. Malfunction of the product or repairs to it may cause the data to be deleted.
- ELMO is not liable for any damage caused by the loss or damage of the data in the recording media.
- Disposal of battery
This product uses Lithium Ion rechargeable and recyclable battery.
When disposing of the battery, contact the dealer from whom you purchased the product. Do not try to remove the battery by yourself.
- If the product is used for longer than the warranty period, its performance and quality may deteriorate due to the lifetime of its parts. For parts replacement (on chargeable basis), consult the dealer from whom you purchased this product or our branch/office near your location.
- The built-in lithium-ion battery has its own life span. Along with the temperature, frequency of use, time of use and the time passed, battery capacity decreases gradually.

If operation time becomes substantially short at normal temperature (between 10°C and 30°C), the battery life seems to have come near its end. Replace it with a new battery. Contact your dealer or ELMO Customer Service for battery replacement (fee applies).

■ Copyright

Unless used for personal use, it is prohibited strictly under copyright law to use any photo files without the prior consent of the copyright holder. Even if using for personal use, be careful that there could be a situation where video or audio recording is restricted or illegal.

■ About WiFi (Wireless LAN)

- This product and the wireless device in this product have been certified under the Radio Law for 2.4GHz and 5GHz band. Using this product in countries other than the country where you purchased it may infringe the radio wave laws of the country where it is used.
- In case of communication problem change location. Depending on the using environment (e.g., there are many obstacles) the wireless communication may be adversely affected. Especially the wireless communication is not available under the following conditions.
 - There are metal and/or concrete between the product and monitor.
- Do not use this product under the following conditions.
 - Near industrial, scientific, and medical devices, such as a pacemaker
 - Near in-plant radio station for mobile equipment identifier (license required and being used in factory line; etc.)
 - Near low power wireless base station (license not required)
- There are conditions to be met before using 5GHz wireless LAN outdoor.

■ Precautions for using the product in 2.4GHz band

This product shares a frequency band with a wide range of equipment (e.g. industrial, scientific, and medical equipment such as microwave ovens), in-plant radio station for mobile equipment identifier (radio stations requiring licenses), and specified low-power radio stations (radio stations not requiring licenses) used for factory production lines as well as amateur radio stations (radio stations requiring licenses).

- Before use, confirm that no in-plant radio station for mobile equipment identifier and specified low-power radio stations or amateur radio stations operate in your vicinity.
- In the event that this equipment causes harmful interference to any in-plant radio station for mobile equipment identifier, immediately change frequencies or halt radio wave emission and contact the dealer from whom you purchased the product for consultation on interference avoidance measures (e.g., partition installation).
- Please contact the dealer from whom you purchased the product if this equipment causes harmful interference to any specified low-power radio stations or amateur radio stations, or if other problems arise.

■ Connectivity with all wireless LAN (WiFi) compatible devices is not guaranteed.

■ The contents of this document are subject to change without notice. The latest version is available from the following official websites:

<https://www.elmoussa.com> <https://www.elmoeurope.com>

■ It is prohibited under copyright law to use or copy any part or the whole of this document without our prior written consent.

■ ELMO shall not be liable for any claim for damage or loss of earnings or any claim raised by a third person due to the use, malfunction or repair of the product.

HANDLING PRECAUTIONS

The followings are special precautions against mishandling of the product. Pay close attention to them.

① Installation

Do not place the product on an unstable place.

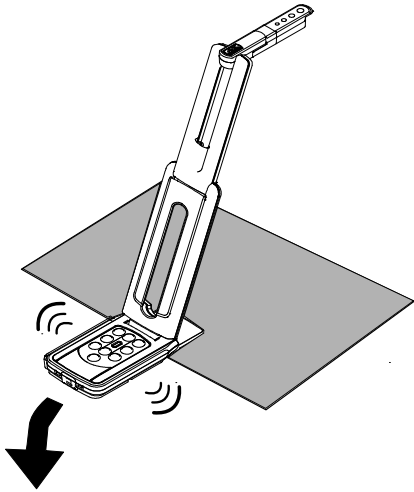

② Setting up

When setting up the product, hold the body around the operating panel. Be careful not to pinch your fingers.

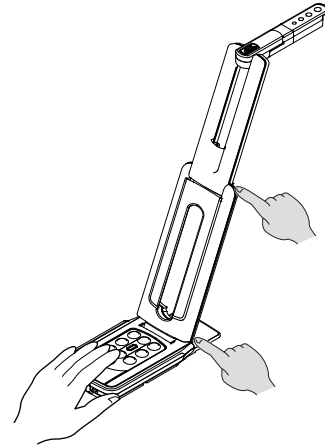

③ Carrying the product

Carry the product by folding the arm so as not to damage the camera. Do not carry by holding the arm or camera head.

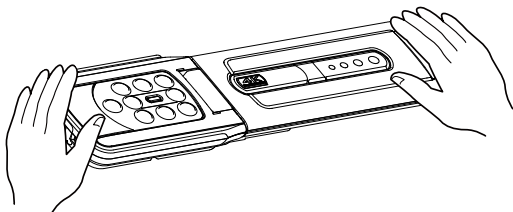

④ Stage

There is a magnet in the bottom of the product. Do not let the product go near objects that can be affected by magnetic fields, such as computers, monitors and magnetic cards. If the product is installed to the wall or place which is not level with the magnet, it may fall. Be sure to confirm that the product is installed securely before use.

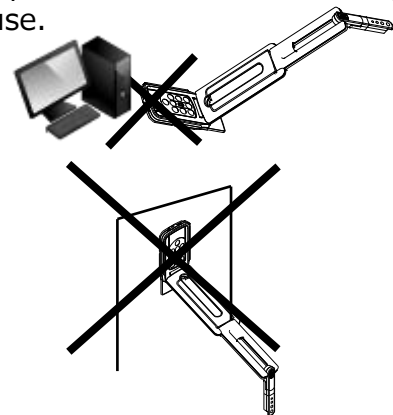

■ TABLE OF CONTENTS

■ IMPORTANT SAFEGUARDS	2
USAGE PRECAUTIONS	5
HANDLING PRECAUTIONS	7
■ TABLE OF CONTENTS	8
① PREPARATION	9
◆ PACKAGE CONTENTS	9
② BASIC OPERATIONS	10
◆ THE NAME OF EACH PART	10
◆ OPERATING PANEL	11
◆ STATUS LED	12
◆ CABLE CONNECTION	12
◆ SETTING SWITCHES	13
◆ RESOLUTION / FRAME RATE (WHEN DISPLAYING ON A COMPUTER VIA USB)	13
◆ SIZE OF IMAGES BEING OUTPUT	14
◆ Anti theft lock hole	14
③ PREPARATION AND CONNECTION	15
◆ SETTING UP	15
◆ MOVING PARTS OF THE PRODUCT	16
◆ CONNECTING TO A PROJECTOR OR MONITOR	17
◆ CONNECTING TO A COMPUTER	17
◆ Connecting to a projector or monitor and a computer	18
④ USING THE PRODUCT	19
◆ ADJUSTING THE SIZE	19
◆ ADJUSTING THE BRIGHTNESS	19
◆ ADJUSTING THE FOCUS	19
◆ PAUSING THE IMAGE	19
◆ ROTATING THE IMAGE	19
◆ TURNING THE LED LIGHTING ON/OFF	19
◆ SETTING THE CAMERA TO STANDBY STATUS (ONLY AVAILABLE WHEN USING DC POWER CORD)	19
⑤ ABOUT VIEWER SOFTWARE	20
◆ INSTALLING THE SOFTWARE	21
⑥ TROUBLE SHOOTING	22
◆ SYMPTOMS AND CONFIRMATION	22
⑦ SPECIFICATION	24
■ MAIN CAMERA	24
■ FUNCTIONAL SPECIFICATION	24
■ ILLUMINATION DEVICE	25
■ OTHER FUNCTIONS	25
■ TRADEMARKS AND LICENSES	26

1 PREPARATION

◆ PACKAGE CONTENTS

The items below are included with this product. If any item is missing, contact the dealer from whom you purchased this product.

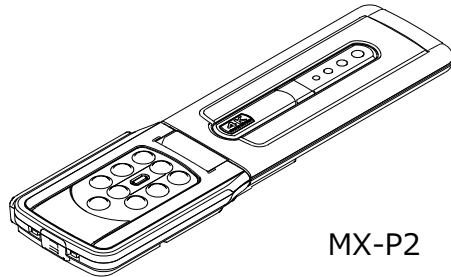

MX-P2

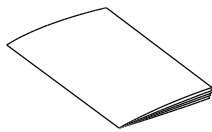

Quick Start Guide



Warranty Card
(For Japan/ North America only)

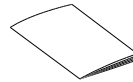

IMPORTANT SAFEGUARDS

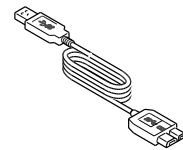

USB3.0 cable

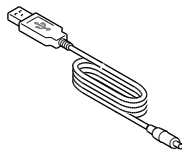

DC power cord

(For Japan/ North America)

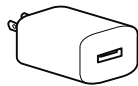

(For Europe)

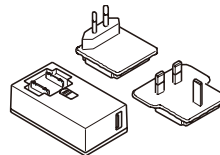

(For Australia)

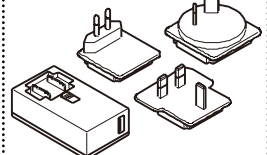

AC adapter

●AC adapter (for customers in Europe and Australia)
Press and slide the plug into the groove of the AC adapter as shown in the drawing.

※Slide it until it clicks.

※Choose the correct plug according to the outlet.

When removing the plug from the AC adapter, slide and pull the plug in the opposite direction while pressing the lock button.

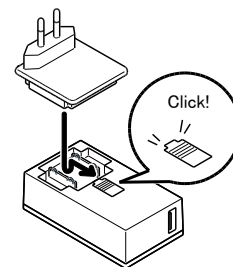

CAUTION

- Do not wrap the power cable tightly around the AC adapter while the power cable is connected to the AC adapter. The cable could be damaged (disconnected) or the inside of the cable could be exposed and result in an accident.

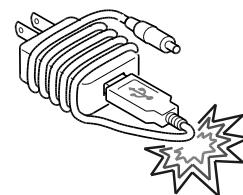

② BASIC OPERATIONS

◆ THE NAME OF EACH PART

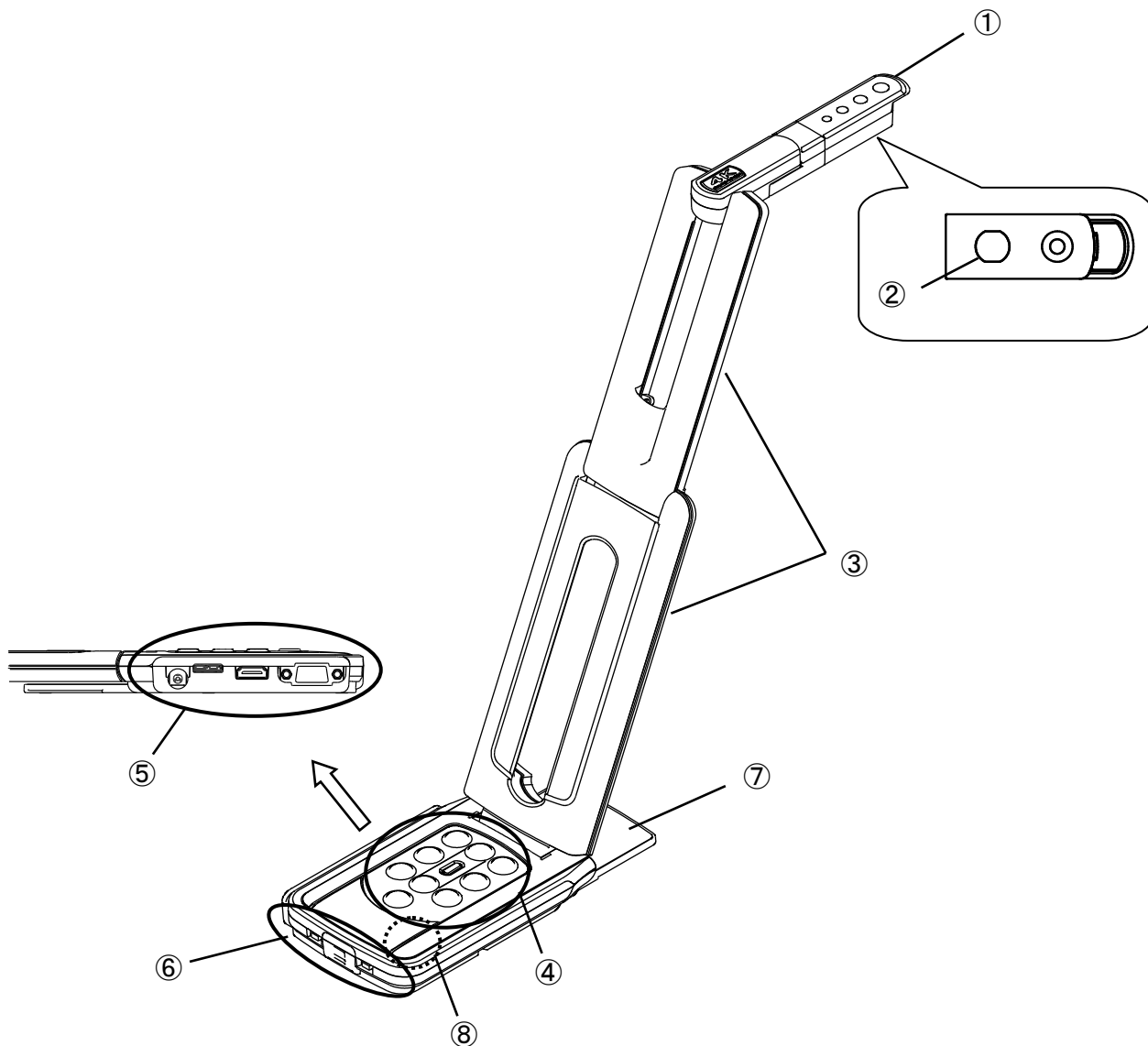

	Name
①	Camera head
②	LED lighting
③	Arm
④	Operating panel
⑤	Connection ports
⑥	Setting switches / Anti theft lock hole
⑦	Stage
⑧	Mic

◆ OPERATING PANEL

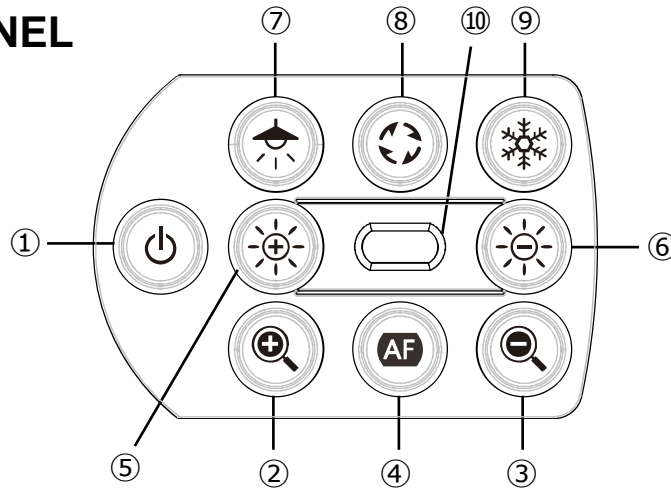

	Function	Description
①	Power	<p>Power ON The product enters the standby status in 5 – 10 seconds after the DC power cord is connected to the product. (LED : Red) To turn on the product, press the Power button. The LED turns blue and the product starts to output images from HDMI port or RGB port.</p> <p>Power OFF To turn off the product, press the Power button again. The LED turns red and the product returns to the standby status.</p> <p>※The Power button is disabled when the power is supplied through the USB cable only. Power supply via USB2.0 = LED : Green Power supply via USB3.0 = LED : Blue</p>
②	ZOOM-IN	To enlarge the image.
③	ZOOM-OUT	To shrink the image.
④	One-push AF	To focus automatically.
⑤	Brightness+	To brighten the image.
⑥	Brightness-	To darken the image.
⑤+⑥	Initialization of the brightness	To initialize the brightness level by pressing ⑤ and ⑥ together.
⑦	LED lighting	To on or off the LED lighting.
⑧	Image rotation	To rotate the image. (0°/180°)
⑨	Freeze	To pause or restart the image.
⑩	Status LED	To indicate the status of the product. For details, refer to “◆ Status LED”(⇒P.12).
③+⑥	Audio ON/OFF	To turn on or off the audio by pressing ③ and ⑥ together for 3 seconds. ※Available only during UVC output.
⑦+⑨	Initialize	To initialize the product settings by pressing ⑦ and ⑨ together while supplying the power through the USB cable. (The DC power cord is not connected.) The Status LED starts to flash blue. Then disconnect the USB cable and the product returns to factory default.

◆ STATUS LED



The connection status of the AC adapter, USB 3.0 cable or USB 2.0 cable, power supply status, or image output status can be checked with the Status LED.

Status LED		Power supply			Power Button	Image output		
Freeze OFF	Freeze ON	AC adapter	USB	Power supply		USB	HDMI	RGB
Off	Off	Off	Off	Off	Disabled	×	×	×
Blue	Flash Yellow	Off	On(USB3.0)	USB	Disabled	○	×	×
Green	Flash Yellow	Off	On(USB2.0)	USB	Disabled	○	×	×
Red	Off	On	Off	AC adapter	OFF	×	×	×
Blue	Flash Yellow	On	Off	AC adapter	ON	×	○	○
Red	Flash Yellow	On	On(USB3.0)	AC adapter	OFF	○	×	×
Blue	Flash Yellow	On	On(USB3.0)	AC adapter	ON	○	○	○
Red	Flash Yellow	On	On(USB2.0)	AC adapter	OFF	○	×	×
Green	Flash Yellow	On	On(USB2.0)	AC adapter	ON	○	○	○

※The Status LED stays off until the product starts up after the power is on.

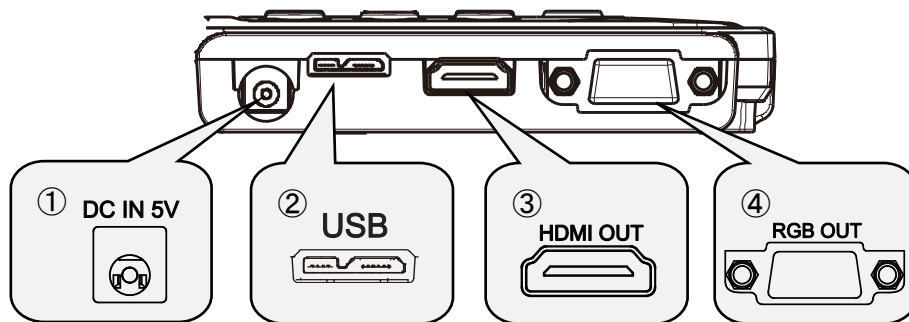
◆ CABLE CONNECTION

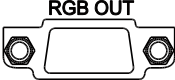

	Mark	Description
①	DC IN 5V 	To connect the supplied DC power cord.
②	USB 	To connect a computer and the product to save images. (USB3.0 cable is included in the package.) Max. resolution 4 : 3 = 4160×3120 16 : 9 = 3840×2160
③	HDMI OUT 	To output digital images by connecting to a monitor via the HDMI cable. (The HDMI cable is not included.)
④	RGB OUT 	To output RGB images by connecting to a monitor via the RGB cable. (The RGB cable is not included.)

◆ SETTING SWITCHES

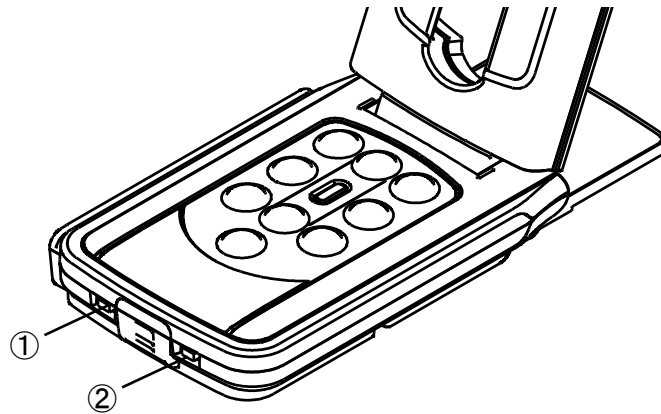

	Mark	Description
①	1080p ← → XGA NORMAL FULL	To change the resolution and output mode. When connecting RGB only : XGA⇔1080p When connecting HDMI : Full⇔Normal (For details about changing the aspect ratio, refer to P.14.) ※This function is disabled when outputting USB and HDMI/RGB simultaneously.
②	60 ← → 50	To correct flickers. Select the same value as used for the power supply frequency. (50Hz / 60Hz)

※To reflect the setting change with the setting switch, the power must be turned on again.

◆ RESOLUTION / FRAME RATE (WHEN DISPLAYING ON A COMPUTER VIA USB)

The following table shows the output resolution and frame rate when connecting with USB3.0 and USB2.0.

In the following case, the actual frame rate may be slower than what is specified in the table.

•A low-spec computer is used.

Resolution	USB3.0		USB2.0	
	MJPEG[fps]	YUY2[fps]	MJPEG[fps]	YUY2[fps]
4160x3120	21	-	-	-
3840x2160	30	-	-	-
2048x1536	30	-	18	-
1920x1080	60/30	30	30	5
1280x960	30	30	30	10
1280x720	60/30	30	30	10
1024x768	30	30	30	15
640x480	30	30	30	30

◆ SIZE OF IMAGES BEING OUTPUT

The output resolution is different according to the setting of the Resolution/Output mode selection.

The product can capture aspect ratio ① . Pay attention to the shooting conditions.

RGB output and HDMI output

•When HDMI output is possible, both RGB output and HDMI output are output in the same resolution.

Setting switches	NORMAL / 1080p		XGA / FULL	
HDMI connection	Yes	No	Yes	No
RGB output	1080p or 720p	1080 p	1080p or 720p	XGA
HDMI output				

Aspect ratio

① FULL(4 : 3)

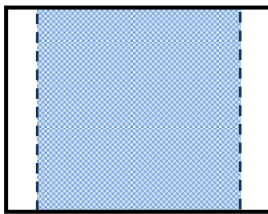

② NORMAL(16 : 9)



	Aspect ratio	
	NORMAL / 1080p	XGA / FULL
HDMI	②	①
RGB	②	①
HDMI+RGB	②	①
HDMI+USB	②	
RGB+USB	②	
HDMI+RGB+USB	②	

※Set the USB output resolution to 1080p/30fps or 720p/30fps.

※The Resolution/Output mode selection switch works as the Full/Normal selection switch when outputting HDMI.

※Depending on the condition of the arm, the maximum angle of view capture will change.

※The aspect ratio of the output image is 16:9 when the switch is set to Normal. Depending on the monitor used, you will see black bars on the top and bottom of the image.

◆ Anti theft lock hole

Connect a security cable to this hole to prevent theft.
(hole size : 7×3mm)

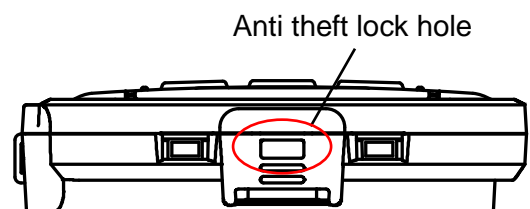

③ PREPARATION AND CONNECTION

◆ SETTING UP

STEP1. Raise the body while holding the operating panel.

STEP2. Raise the arm as indicated by an arrow.

STEP3. Raise the camera head. Set it horizontally.

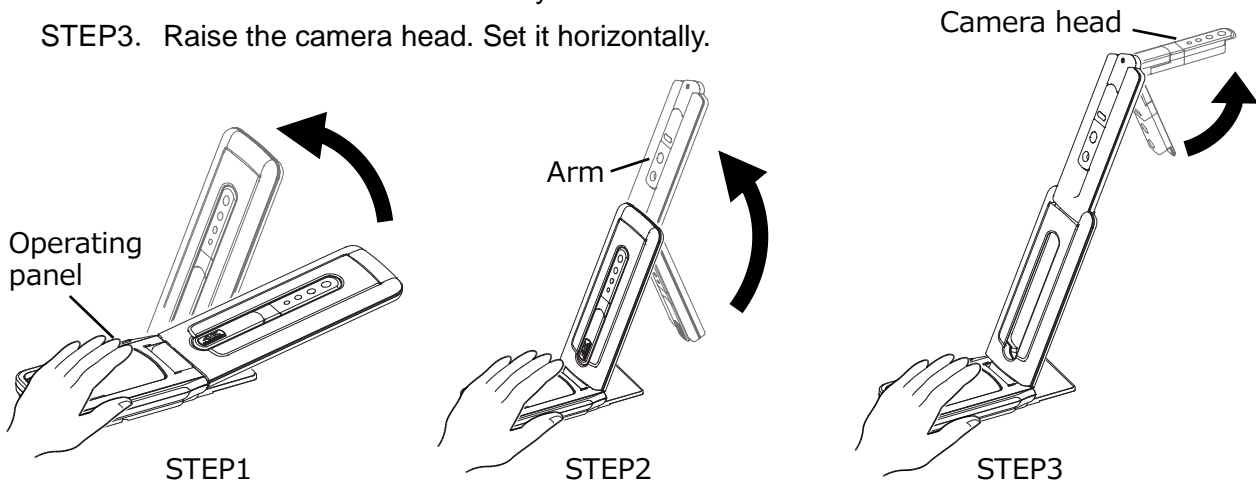

CAUTION

- Be careful not to pinch your fingers when moving the arm.
- Do not hold the arm or camera head when carrying the product.
- Be careful not to give an impact to the camera head.

STEP4. Rotate the camera head according to the shooting direction.

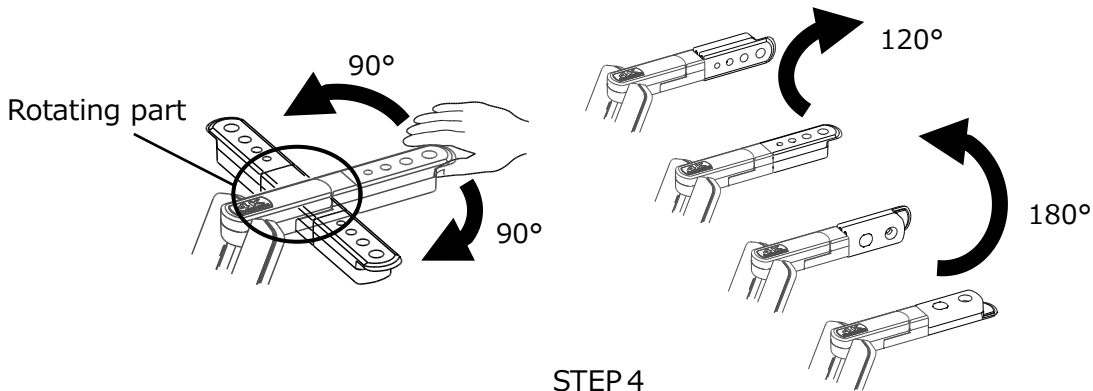

CAUTION

This product uses static electricity sensitive components.
In order to avoid malfunction from static electricity, hold the edge of the camera head to rotate the camera head.
Do not touch the rotating part.

About the magnet

There is a magnet in the bottom of the product. Using the magnet, you can install the product to various places with metallic surface easily.

CAUTION

If the product is installed to the wall or place which is not level with the magnet, it may fall. Be sure to confirm that the product is installed securely before use.

◆ MOVING PARTS OF THE PRODUCT

The product can be moved as shown below.

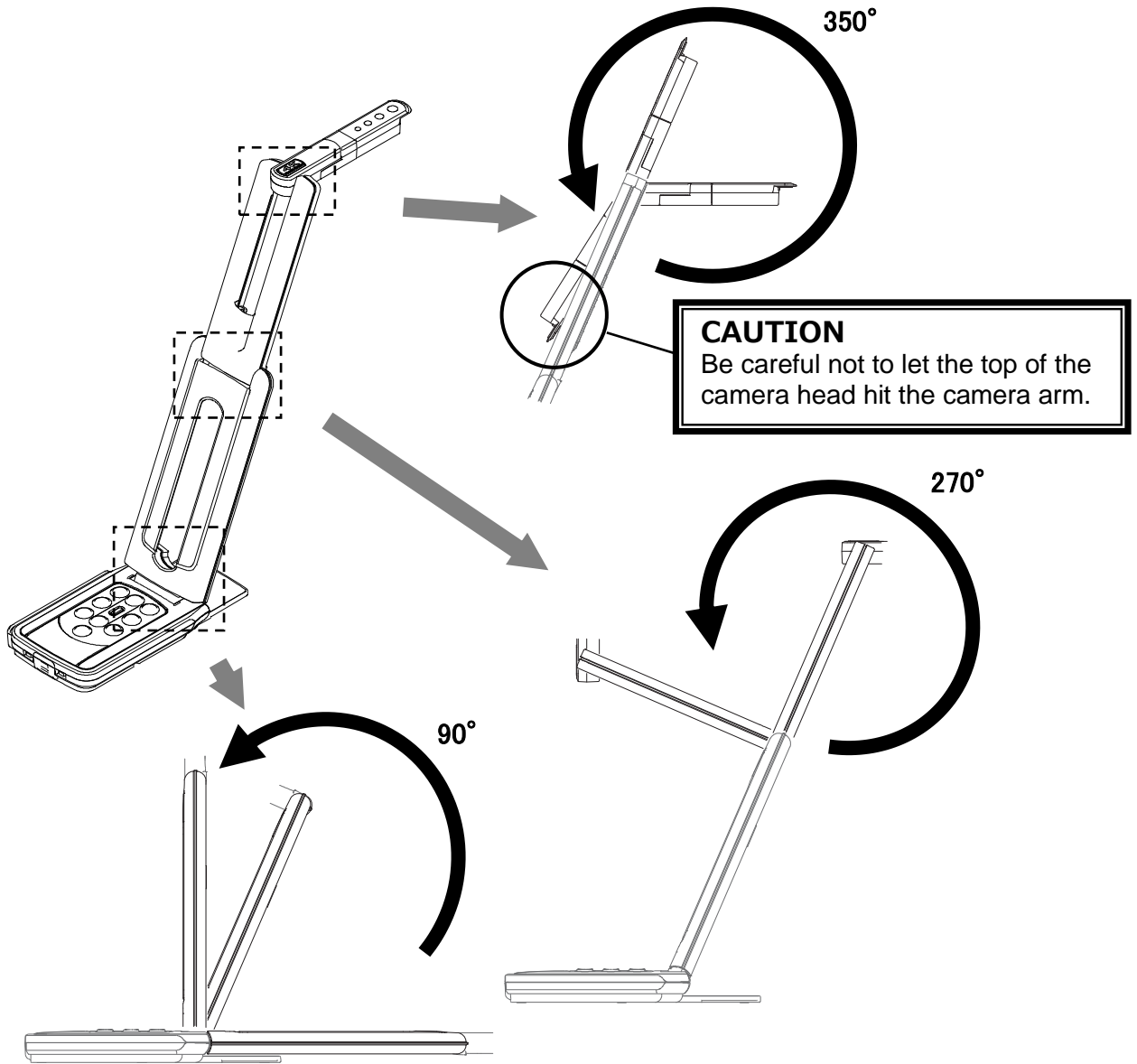

Camera head

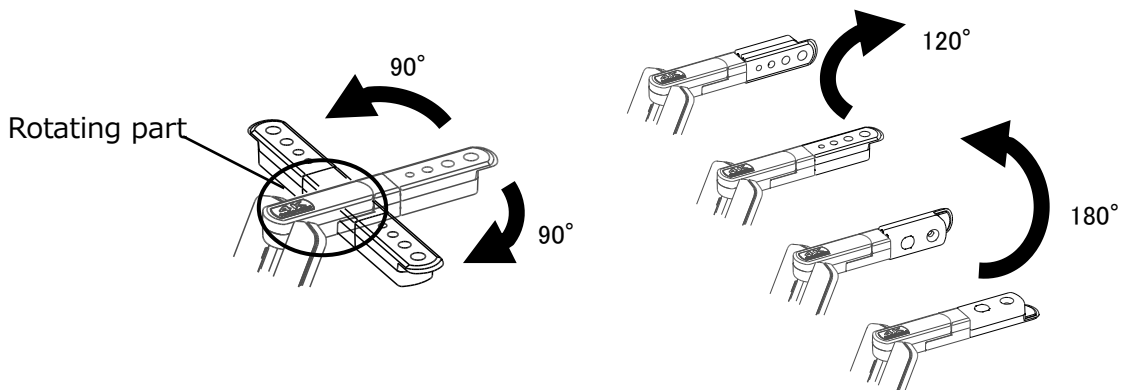

◆CONNECTING TO A PROJECTOR OR MONITOR

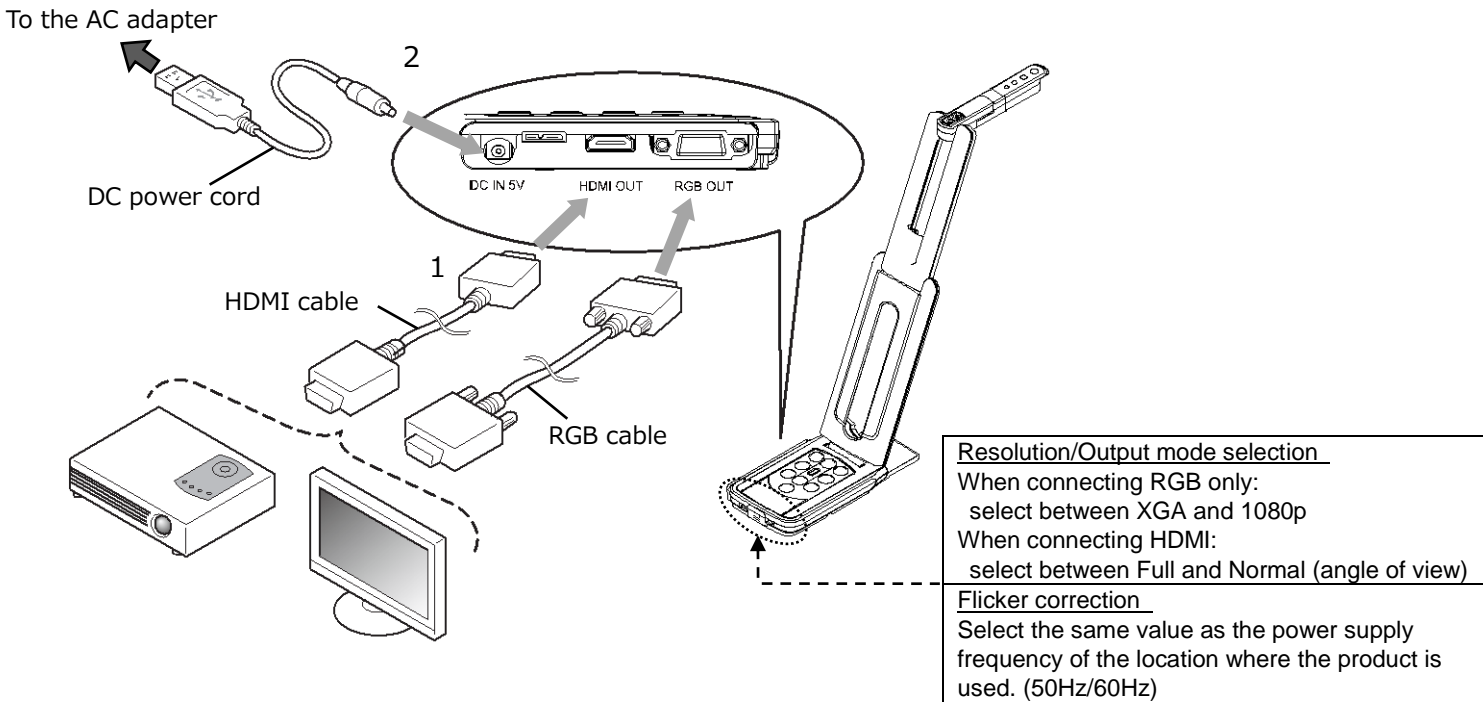

1. Connect the product to a projector or monitor with the HDMI cable or RGB cable.
2. Connect the supplied DC power cord to []. Connect the USB plug to the supplied AC adapter. Then connect it to a wall outlet.
3. The product enters the standby status. (Status LED: Red)
4. Press the Power button to turn on the product. The image output will start.

◆CONNECTING TO A COMPUTER

The product is compliant to UVC (video class) standard. You can transfer the image via USB by connecting the product to a computer using the USB3.0 cable (bus power).

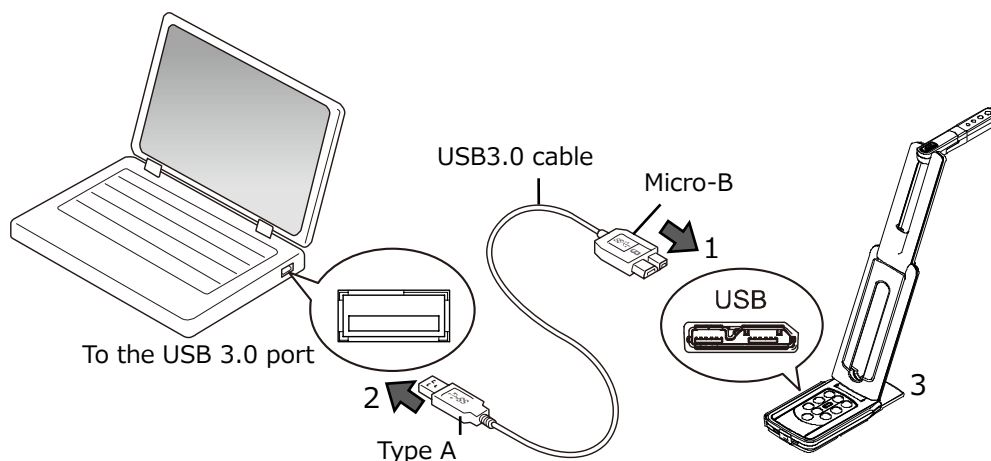



1. Connect the microB connector terminal of the USB3.0 cable to [] connector in the side of the product.
2. Connect the typeA terminal of the USB3.0 cable to the USB port of your running computer.
3. Set the resolution according to the description in P.13 using the UVC app.

CAUTION

- When connecting to the USB2.0 port (Status LED : green), the frame rate may be decreased depending on the output resolution.
- The frame rate may be decreased depending on the computer used.
- The performance may be unstable depending on the power supply of the computer. In that case, use the AC adapter to supply the power to the product.

◆Connecting to a projector or monitor and a computer



1. Connect the product to a projector or monitor with the HDMI cable or RGB cable.
2. Connect the supplied DC power cord to []. Connect the USB plug to the supplied AC adapter. Then connect it to a wall outlet.
3. Connect the microB connector terminal of the USB3.0 cable to [] connector in the side of the product.
4. Connect the typeA terminal of the USB3.0 cable to the USB port of your running computer.
5. The product power is in standby mode, and you can check the image on the PC UVC application.
(Status LED: Red)
6. Set the resolution on the UVC app to 1080p / 30fps or 720p / 30fps.
7. Press the power button to turn on the product. Image output to HDMI / RGB starts.
(Status LED: Blue)

CAUTION

- When connecting to the USB2.0 port (Status LED : green), the frame rate may be decreased depending on the output resolution.
- The frame rate may be decreased depending on the computer used.

4 USING THE PRODUCT

◆ ADJUSTING THE SIZE



The size of the image can be adjusted using [ / ] buttons on the operating panel

NOTE

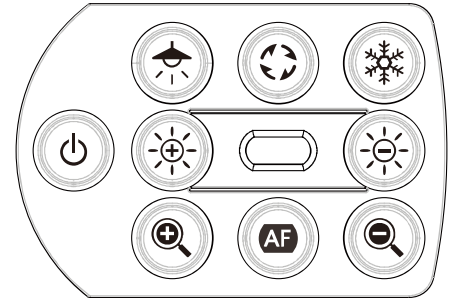
The maximum zoom ration is 16x (digital zoom).
The image quality will be degraded when using the digital zoom.



◆ ADJUSTING THE BRIGHTNESS

The brightness of the image can be adjusted using [ / ] buttons on the operating panel. To initialize the brightness level, press these buttons at the same time.

◆ ADJUSTING THE FOCUS

Press [] on the operating panel to automatically focus on the subject.

◆ PAUSING THE IMAGE

Press [] on the operating panel to pause the camera image.
Press the button again to restart.
※The Status LED flashes yellow.

◆ ROTATING THE IMAGE

Press [] on the operating panel to rotate the image by 180°.

◆ TURNING THE LED LIGHTING ON/OFF

Press [] on the operating panel to ON/OFF the LED lighting.

CAUTION

- To take shots of people, turn the LED lighting OFF.
- Make sure that the light from the LED lighting does not shine directly into your eyes.
- This product is equipped with a high-brightness LED. You can safely use it to light up the object. The brightness will gradually decrease with long-term use. This is not a malfunction but a characteristic of the LED.
- Do not touch the LED lighting while it is on as it may become very hot.

◆ SETTING THE CAMERA TO STANDBY STATUS (ONLY AVAILABLE WHEN USING DC POWER CORD)

Press the [] button on the operating panel to enter the standby status.
During the standby status, no image will be output from the HDMI OUT or RGB OUT.
※The image will be output regardless of the status (ON/OFF) of the Power button when the product is connected to a computer via UVC.

5 ABOUT VIEWER SOFTWARE

●Image Mate +C

The following operations can be performed by accessing the WEB app “Image Mate +C” on the internet after connecting the product to a computer via the USB cable:

- Save live video streaming or still images to a computer
- Draw on the image
- Operate the product from a computer (such as zoom, freeze and image rotation)

For details about how to access the “Image Mate +C”, visit the following website.

<https://www.elmoussa.com/imagematecloud/>

●Image Mate 4

The following operations can be performed by connecting the product to a computer with Image Mate 4 installed via the USB cable:

- Save live video streaming or still images to a computer
- Operate the product from a computer, etc.

※If Image Mate 4 is already installed in your computer, update the version of Image Mate 4.

※You can view the camera image with a commercially available software. With Image Mate 4, you can also use other functions such as zoom and freeze.

For details of the control software Image Mate4 and its instruction manual, visit the following website.

<https://www.elmoeurope.com/index.php/en/products/software-choice/elmo-image-mate-4>

●EIT

The following operations can be performed by connecting the product to a computer with our touchscreen electronic blackboard software “EIT (ELMO Interactive Toolbox)” installed via the USB cable and by connecting the computer to a large monitor or tablet computer:

- Operate the product or enlarge the computer screen
- Draw on the image
- Save live video streaming or still images to a computer

For details of the EIT (ELMO Interactive Toolbox), visit the following website

<https://www.elmoussa.com/software/>

<https://www.elmoeurope.com/index.php/en/products/software-choice/elmo-interactive-toolbox>

NOTE

If your computer does not meet the recommended requirements or depending on the performance of your computer, the recording frame rate may be decreased.

◆ INSTALLING THE SOFTWARE

You need to install the software to your computer to use “Image Mate 4” or “EIT (ELMO Interactive Toolbox)”.

Access the respective website described above.

※If the software is already installed in your computer, update the version of the existing software.

Caution

- Do not connect/disconnect the USB cable while operating the product . It may cause malfunction.
- We recommend using the supplied USB cable.
- It may take some time to display the image after the resolution is changed via UVC (with the USB cable). Do not turn off the power of the product or disconnect the USB cable before the image is displayed.
- The displayed image may pause for a brief second when the object moves quickly. This is not a malfunction.
- The displayed image may be distorted depending on the object being displayed.
The image distortion may be improved by the following measures:
 - Reduce the resolution
 - Reduce the frame rate
 - Changing image format to MJPEG
 - Reducing sharpness or brightness in the camera setting





NOTE

- Depending on the computer’s USB environment or the peripheral equipment, image transfer may be disrupted.
- We do not guarantee the operation of all types of devices with the product.
- When using the USB3.0 cable, the audio performance may become unstable. In that case, use the USB2.0 cable.

⑥ TROUBLE SHOOTING

◆ SYMPTOMS AND CONFIRMATION

Check the following items. If any abnormality is found, consult the dealer from whom you purchased this product or our nearest branch/office.

Symptom	Possible cause / remedy
No image is displayed.	<ul style="list-style-type: none"> • The cable is not correctly connected. • The DC power cord is disconnected from the power supply socket of the unit. • The AC adapter is disconnected from the outlet. • Zoom is set at the TELE side, displaying only the white or black part of the document. • If you turn the power ON immediately after turning it OFF, the unit may not start. Wait for several seconds after turning the power OFF, and then turn it back ON. • The USB cable is disconnected. • The output setting does not match the cable connected to the unit. Set the correct output setting. • Reconnect the AC adapter and the power cord. • The monitor is not turned on. • The input source of the monitor is not set correctly. • The viewer software is not started correctly. Restart the software and try to connect again. • The product is not selected in the setting of the viewer software.
The output image (resolution) changes automatically.	<ul style="list-style-type: none"> • When the HDMI monitor is connected to the product, the output image (resolution) is automatically changed based on information from the connected monitor.
The image is out of focus.	<ul style="list-style-type: none"> • The document (object) is too close to the lens. Move the document (object) slightly away from the lens. • Press the One-push AF button [] on the operating panel.
The image is too dark.	<ul style="list-style-type: none"> • The intensity of the lighting is insufficient. Press the button [] on the operating panel to adjust the brightness. Or press the button [] to turn on the LED lighting.
The image does not move.	<ul style="list-style-type: none"> • Camera image is paused by pressing the [] button on the operating panel. Press the [] button again to restart the image. • Camera image is paused by selecting Freeze function in the viewer software. Check the software and release the freeze. • Reconnect all the cables.
The image is striped.	<ul style="list-style-type: none"> • This may be interference fringes between dots of printed matter and TV scanning lines or CMOS pixels. Changing the shooting range may help the problem. • Vertical stripes may appear on an LCD projector image. Manually adjusting the dot clock at the projector side may help the problem.

The UVC video stream is upside down.	<ul style="list-style-type: none"> Check that the graphics driver and other device drivers on your computer are updated. The latest device drivers are available from the computer manufacturer.
The displayed UVC image contains images other than the camera image	<ul style="list-style-type: none"> The software and OS you are using or the connection status may be causing images other than the camera image to breakthrough while displaying the camera image. This problem can be solved by reconnecting the device or restarting the software.
A software error message appears and the UVC image is not displayed	<ul style="list-style-type: none"> If it is taking too much time for the preparation of the image output, the software may determine this to be an error. Restart the product, reconnect it to the computer, and then start the software.
The UVC image fails to be output.	<ul style="list-style-type: none"> Disconnect the USB cable, restart the software, and then connect the USB cable again. If UVC image still fails to be output after restarting, contact the software vendor and ask if the software you are using supports MJPEG.
The UVC video stream sometimes freezes.	<ul style="list-style-type: none"> The displayed image may pause for a brief second when the object moves quickly. In that case, adjusting the brightness manually may improve the problem.
There is a distortion of the UVC image.	<ul style="list-style-type: none"> Use a high-spec computer. Also, reducing the resolution or frame rate may improve the distortion of the image.
4K image cannot be displayed.	<p>The system requirements to display 4K image are as follows:</p> <p>CPU : Intel® Core™ i7 3GHz or higher</p> <p>Memory : 16GB or higher</p> <p>Graphic board : GeForce GTX750 or higher</p>

About the light (LED lighting)

The brightness of the LED lighting will diminish with long-term use. If its brightness has significantly diminished, consult the dealer from whom you purchased this product or our nearest branch/office for replacement (subject to charge).

About long-term usage of this product

Due to the lifetime of its parts, if this product is used for longer than the warranty period, its performance and quality may deteriorate. In this case, we will replace the parts for a charge. Consult the dealer from whom you purchased this product or our nearest branch/office.

7 SPECIFICATION

■MAIN CAMERA

Item	Specifications
Power source	DC5V
Power consumption	4.0W (when connecting USB) 6.0W (when connecting HDMI/RGB)
Outside dimensions	W : 343mm D : 82mm H : 302mm(When setup)
	W : 290mm D : 82mm H : 22mm(When folded)
Weight	Approx. 500g (Main body only)
Ext. control terminal	USB3.0 type microB × 1
Lens	F=2.0
Frame rate	60fps (in high frame rate mode at 1080P)
Focus working range	From lens surface: 100mm ~ ∞
Focus	Auto (One-push)
Exposure	Auto (Possible to adjust exposure level)
Image pick-up element	1/3.1 inch CMOS 13,000,000 pixels
Effective pixels	H: 4160, V: 3120
Resolution	H: 1300TVlines or more V: 1300TVlines or more
Digital zoom	Max. 16x
Shooting area	374mm×281mm (Height: 286mm) 4:3
Simultaneous output	Possible from each port (USB/HDMI OUT/RGB OUT) ※For details about the conditions for the simultaneous output, refer to "Status LED"(⇒P.12).

■FUNCTIONAL SPECIFICATION

Item	Specifications	Operating panel	IM+C	IM4	EIT
Brightness	Possible(Set value 7 levels) Default value: 8	✓	-	✓	✓
Image rotation	0°/180°Default setting: 0° (The image rotation function is not available when the image freeze function is used.)		✓		
LED lighting	ON/OFF Default setting: OFF	✓	-	-	-
AF (focus)	Manual (One-push)	✓	-	-	-
Zoom	Possible (from x1 to x16) Default setting: x1		✓		
Image pause	Possible		✓		

Resolution	Manual	-	-	✓	✓
Flicker	60Hz / 50Hz (Default setting: 60Hz)	✓	-	✓	✓
Contrast	Possible (Set value 0~20) Default value: 14	-	-	✓	✓
Hue	Possible (Set value -180~180) Default value: 0	-	-	✓	✓
Saturation	Possible (Set value 0~31) Default value: 26	-	-	✓	✓
Definition	Possible (Set value 1~15) Default value: 5	-	-	✓	✓
Gamma	Possible (Set value 100~200) Default value: 120	-	-	✓	✓
White balance	Auto/Manual (Set value 2000~8000) Default setting: Auto 6500	-	-	✓	✓
Backlight compensation	ON/OFF Default setting: OFF	-	-	✓	✓
Low-light compensation	ON/OFF Default setting: OFF	-	-	✓	✓
Factory setting	Possible	✓※1	-	✓	✓

※1 The product will be reset to factory default when the power is turned on while the LED lighting button and the Freeze button are pressed at the same time.
(Items to be reset: Brightness, Image rotation, Contrast, Hue, Saturation, Definition, Gamma, White balance, Backlight compensation, Focus, Exposure)

■ILLUMINATION DEVICE

Item	Specifications
LED lighting	White LED

■OTHER FUNCTIONS

Item	Specifications
USB	USB 2.0 compliant / USB 3.0 compliant
Transfer speed	USB3.0 Super Speed (5Gbps) USB2.0 High Speed (480Mbps) ※The actual transfer speed may vary depending on the performance of your computer and the status of the USB bus.
Audio	Built-in microphone Sensitivity -36dB±3dB Frequency characteristics 100Hz~10KHz
Operating temperature	0°C~+40°C
Humidity	30%~85% (No condensation)

■ TRADEMARKS AND LICENSES

ELMO, Image Mate, and ELMO Interactive Toolbox are the registered trademarks of ELMO Co., Ltd.

Windows and/or other Microsoft products referenced herein are either registered trademarks or trademarks of Microsoft Corporation in the United States and/or other countries.

Intel is a trademark or registered trademark of Intel Corporation or its subsidiaries in the U.S. and/or other countries.

GeForce is a trademark or registered trademark of NVIDIA Corporation.

All other company/product names described in this manual are trademarks or registered trademarks of their respective companies.

This product is licensed under the AVC Visual Patent Portfolio License (AVC Video) for the personal and non-commercial use of a consumer to (i) play AVC Video that was recorded by a consumer engaged in a personal and a non-commercial activity and/or, (ii) play AVC Video that was obtained from a video provider licensed from MPEG-LA, LLC. Additional information including that relating to promotional and commercial uses may be obtained from MPEG-LA, LLC.

ATTENTION

- Unless used for personal use, it is prohibited by copyright law to record slides, books and photos without the prior consent of copyright holder.
- This product is designed to be used in industrial environment. If it is used in a residential area or in an adjacent area thereto, harmful interference to radio or television reception may occur.
- Repair parts
Repair parts are the items which are needed to maintain product functionality. The holding period of such repair parts is 5 years after the product discontinuation, which is equal to the repair period we will accept.
- Any image, which is obtained by this product, and which can be identified, is considered to be private information. Be forewarned that the person who makes use of such images shall be liable for disclosing of such images.

株式会社エルモ社

〒457-0078
名古屋市南区塩屋町一丁目3番地4
Web : <https://www.elmo.co.jp>

製品のお問い合わせは、下記営業所へ

- 東日本営業所
 - 札幌オフィス
〒001-0021 札幌市北区北21条西8丁目3番8号 バックスビル
TEL. 011-738-5811
 - 仙台オフィス
〒980-0802 仙台市青葉区二日町13番18号
ステーションプラザビル6階
TEL.022-266-3255
 - 首都圏営業所
〒108-0073 東京都港区三田3丁目12番16号 山光ビル4階
TEL.03-3453-6471
 - 中日本営業所
 - 名古屋オフィス
〒457-0078 名古屋市南区塩屋町一丁目3番地4
TEL.052-811-5261
 - 京都オフィス
〒604-8101 京都市中京区柳馬場御池下る柳八幡町65
京都朝日ビル10階
TEL.075-744-1360
 - 大阪オフィス
〒550-0002 大阪市西区江戸堀1丁目9番6号
肥後橋ユニオンビル10階
TEL.06-6443-6001
 - 神戸オフィス
〒550-0002 大阪市西区江戸堀1丁目9番6号
肥後橋ユニオンビル10階
TEL.06-6443-6001
 - 西日本営業所
 - 福岡オフィス
〒812-0039 福岡市博多区冷泉町2番8号 朝日プラザ祇園2階
TEL.092-281-4131
 - 広島オフィス
〒730-0012 広島県広島市中区上八丁堀4-1
アーバンビューグランドタワー1104号室
TEL.082-221-2801
 - 熊本オフィス
〒861-2104 熊本市東区秋津3丁目11-7
TEL.096-282-8338

OVERSEAS SUBSIDIARY COMPANIES

ELMO USA CORP.

□Headquarters
6851 Jericho Turnpike
Suite 145
Syosset, NY 11791
Tel. (516) 501-1400
Fax.(516) 501-0429
E-mail : elmo@elmousa.com
Web : <https://www.elmousa.com/>

ELMO Europe SAS

□Headquarters
12 place de la Défense
Maison de la Défense
92974 Paris la Défense Cedex FRANCE
Tel. +33 (0) 1 73 02 67 06
Fax. +33 (0) 1 73 02 67 10
E-mail : info@elmoeurope.com
Web : <https://www.elmoeurope.com/>

□German Branch

Hansaallee 201, Haus 1
40549 Düsseldorf Germany
Tel. +49 (0) 211 544756 40
Fax. +49 (0) 211 544756 60
E-mail : info@elmo-germany.de
Web : <https://www.elmo-germany.de/>

□Middle East Branch

5WA-129, Dubai Airport Free Zone,
P.O Box 371556, Dubai,
United Arab Emirates
Tel. +971-(0)4-260-2390
Fax. +971-(0)4-260-2392
Web : <https://www.elmoeurope.com>

ELMO CO., LTD.

1-3-4, Shioya-cho, Minami-ku
Nagoya, 457-0078, Japan