



# **INSTRUCTION MANUAL**

## **xSync Board / ELMO Board**

---

**EL55R2/EL65R2/EL75R2/EL86R2**

**Ver.01**

Read this manual carefully before using the product.

Store this manual in a safe place in case you need it again.

# Table of contents

<b>1</b>	<b>Before Use.....</b>	<b>7</b>			
1.1	Package Contents.....	7		◆ Page Operation Menu .....	32
1.2	Part Names and Functions.....	8		◆ Add Page Menu .....	32
1	Front.....	8		◆ Functions Available When Selecting an Object.....	33
2	Side and Bottom.....	9		◆ Menu Operations .....	34
3	Touch pen and Eraser .....	10		◆ Split Screen Mode.....	35
4	Remote Control .....	11		◆ Saving Images .....	36
	◆ Preparation .....	12	3.2	<b>Using Overlay Function .....</b>	<b>37</b>
1.3	<b>Installation .....</b>	<b>13</b>		◆ Startup .....	37
1	Installation Conditions .....	13		◆ Toolbar Description .....	37
	◆ Attachment of the Display Monitor to the Stand .....	14	3.3	<b>Using Camera Roll Function.....</b>	<b>38</b>
1.4	<b>Turning On or Off the Power.....</b>	<b>15</b>		◆ Startup .....	38
1	Connecting the Power Cord .....	15		◆ Screen Description .....	38
2	Turning On the Power .....	15		◆ Comparing Images and Videos .....	39
	◆ Initial Startup .....	16		◆ Pasting to ELMO Note (whiteboard).....	39
3	Turning Off the Power .....	17	3.4	<b>Using a USB Camera .....</b>	<b>40</b>
4	Standby Mode .....	18		◆ Startup .....	40
				◆ Screen Description .....	40
				◆ USB Camera Settings Screen.....	41
<b>2</b>	<b>Basic Operations .....</b>	<b>19</b>	3.5	<b>Viewing Web Page (E Browser) ....</b>	<b>42</b>
2.1	Touch Operations .....	19		◆ Startup .....	42
2.2	Basic Screen Operations .....	20		◆ Screen Description .....	42
	◆ Home Screen .....	20		◆ Popup Display Settings.....	44
	◆ Shortcuts of Apps.....	21	3.6	<b>Using ELMO Timer Function.....</b>	<b>45</b>
	◆ Uninstallation of Apps .....	22		◆ Startup .....	45
	◆ Connection Status Icons on the Home Screen .....	23		◆ Basic Operations (Timer) .....	45
	◆ Displaying the Side Menu Bar.....	24		◆ Basic Operations (Stopwatch) .....	45
				◆ Creating Tasks using Timer.....	46
<b>3</b>	<b>Using Apps .....</b>	<b>25</b>		◆ Timer List Screen.....	48
3.1	<b>Using ELMO Note (Whiteboard)....</b>	<b>25</b>		◆ Task List Screen .....	49
	◆ Startup .....	25		◆ Timer Settings Screen .....	49
	◆ Initial Startup .....	25		◆ Minimizing the Screen .....	50
	◆ Basic Operations .....	26		◆ Stopwatch Screen.....	50
	◆ Screen Description .....	27	3.7	<b>Using Wireless Casting Function (Transcreen) .....</b>	<b>51</b>
	◆ Pen Menu.....	28		◆ Preparation .....	51
	◆ Eraser menu .....	29		◆ Using on Windows OS .....	52
	◆ Selection Menu .....	29		◆ Using on iOS or MacOS.....	52
	◆ Shapes Menu .....	30		◆ Using on Chrome OS .....	53
	◆ Functions Available in the Operation Mode .....	30		◆ Using on Android OS .....	53
	◆ Background Menu.....	31		◆ Mirroring Screen .....	53
	◆ Background Image Menu .....	31			

3.8	<b>Using Anti-Virus Function (Avira Security)</b>	<b>54</b>		
	◆ Startup	54		
	◆ Initial Startup	54		
	◆ Basic Operations	54		
3.9	<b>Using ELMO Play</b>	<b>55</b>		
	◆ Startup	55		
3.10	<b>Using File Manger Function</b>	<b>56</b>		
	◆ Startup	56		
	◆ Screen Description	56		
	◆ Cloud Account Settings	58		
	◆ Uploading Files to Cloud	60		
3.11	<b>Using Utilities Function</b>	<b>61</b>		
	◆ Startup	61		
	◆ Screen Description	61		
<b>4</b>	<b>Using with External Devices</b>	<b>62</b>		
4.1	<b>Connecting Devices</b>	<b>62</b>		
	◆ Displaying the Computer Screen (Video and Audio)	62		
	◆ Controlling the Product from a Computer (Serial Control)	65		
	◆ Displaying the Screen of the Connected Device (Video and Audio)	66		
	◆ Playing the Audio of the Product through Other Devices	66		
	◆ Operation	67		
	◆ Configuring the Source Settings	68		
<b>5</b>	<b>Configuring the Settings</b>	<b>70</b>		
	◆ Startup	70		
	◆ Before Configuring the Settings	70		
	◆ Network and Connection	70		
	◆ System Settings	75		
<b>6</b>	<b>Optional Item</b>	<b>80</b>		
6.1	<b>Easy Controller</b>	<b>80</b>		
	◆ Easy Controller Buttons	81		
<b>7</b>	<b>Troubleshooting and Maintenance</b>	<b>82</b>		
7.1	<b>Troubleshooting</b>	<b>82</b>		
	◆ The product does not operate properly.	82		
	◆ The image of the input source cannot be output correctly.	82		
	◆ No audio is output from the speaker.	83		
	◆ Touch operations do not work properly.	83		
	◆ Cannot connect to the network.	83		
7.2	<b>Maintenance</b>	<b>84</b>		
	◆ Cleaning of the LCD display	84		
<b>8</b>	<b>Specifications</b>	<b>85</b>		
8.1	<b>Product Specifications</b>	<b>85</b>		
<b>9</b>	<b>After-Sales Service</b>	<b>87</b>		
9.1	<b>Product Warranty</b>	<b>87</b>		
9.2	<b>Repair Procedure</b>	<b>87</b>		

## SAFETY INSTRUCTIONS

Make sure to read the "SAFETY INSTRUCTIONS" in this guide before using this product.

### WARNING

- Failure to follow the installation instructions included with the display could result in injury and product damage which may not be covered by the warranty.
- Do not open or disassemble the display.  
You risk electrical shock from the high voltage inside the casing. Opening the casing also voids the warranty.
- Do not stand (or allow children to stand) on a chair to touch the surface of the display.  
Rather, mount the product at the appropriate height.
- To reduce the risk of fire or electric shock, do not expose the display to rain or moisture.
- If the display requires replacement parts, make sure the service technician uses replacement parts specified by ELMO or parts with the same characteristics as the original.
- Ensure that any cables that cross the floor to the display are properly bundled and marked to avoid a trip hazard.
- Do not insert objects inside the cabinet ventilation holes, because they could touch dangerous voltage points and cause electric shock, fire or product damage which may not be covered by the warranty.
- Do not place heavy objects on the power cable. Damage to the cable could cause shock, fire or product damage which may not be covered by the warranty.
- Use only extension cords and outlets that can fully accommodate the display's polarized plug.
- Use the power cable provided with the display. If a power cable is not supplied, contact your supplier.  
Use only power cables that match the AC voltage of the power outlet and that comply with your country's safety standards.
- If the glass is broken, do not touch the liquid crystal.  
To prevent injury, handle glass fragments with care when disposing of them.
- Do not move or mount the display by connecting rope or wire to its handles.  
The display is heavy, and failure of the rope, wire or handle could lead to injury.
- Use only VESA®-approved mounts if using a mount other than the one supplied with the display.
- Disconnect all of the display's power cables from the wall outlet and seek assistance from qualified service personnel if any of the following occur:
  - \* The power cable or plug is damaged.
  - \* Liquid is spilled into the display.
  - \* Objects fall into the display.
  - \* The display is dropped.
  - \* Structural damage, such as cracking, occurs
  - \* The display behaves unexpectedly when you follow operating instructions

### CAUTION

- Turn off the display before cleaning its screen.  
Otherwise, you may scramble the desktop icons or inadvertently activate applications when you wipe the screen.
- Avoid setting up and using the display in an area with excessive levels of dust, humidity, and smoke.
- Make sure an electrical socket is near the display and remains easily accessible during use.
- The display should be used only with European TN and TT power distribution systems.  
It is not suitable for older, IT-type power distribution systems found in some European countries.  
This system (IT-type) is widely used isolated from earth, in some installations in France, with impedance to earth, at 230/400V, and in Norway, with voltage limiter, neutral not distributed, at 230V line-to-line.  
Contact qualified personnel if you're uncertain of the type of power system available where you're installing the display.
- You must connect the USB cable that came with the display to a computer that has a USB compliant interface and that bears the USB logo.  
In addition, the USB source computer must be compliant with IEC 60950-1 and/or IEC 62368-1.  
The source computer must be CE marked and carry safety certification marks for Canada and USA.  
This is for operating safety and to avoid damage to the display.
- Read Instructions - All the safety and operating instructions should be read before the appliance is operated.
- Retain Instructions - The safety and operating instructions should be retained for future reference.
- Heed Warnings - All warnings on the product and in the operating instructions should be adhered to.
- Follow Instructions - All operating and use instructions should be followed.
- Cleaning - Unplug this product from the wall outlet before cleaning. Do not use liquid cleaners or aerosol cleaners.  
Use a damp cloth for cleaning.
- Attachments - Do not use attachments not recommended by the product manufacturer as they may cause hazards.
- Water and Moisture - Do not use this product near water - for example, near a bath tub, wash bowl, kitchen sink, or laundry tub, in a wet basement, or near a swimming pool, and the like.
- Placement - Do not place this product on an unstable cart, stand, tripod, bracket, or table.  
The product may fall, causing serious injury to a child or adult, and serious damage to the product.  
Use only with a cart, stand, tripod, bracket, or table recommended by the manufacturer, or sold with the product. Any mounting of the product should follow the manufacturer's instructions, and should use a mounting accessory recommended by the manufacturer.
- Ventilation - Slots and openings in the cabinet are provided for ventilation and to ensure reliable operation of the product and to protect it from overheating, and these openings must not be blocked or covered.  
The openings should never be blocked by placing the product on a bed, sofa, rug, or other similar surface.  
This product should not be placed in a built-in installation such as a bookcase or rack unless proper ventilation is provided or the manufacturer's instructions have been adhered to.
- Lightning - For added protection for this product during a lightning storm, or when it is left unattended and unused for long periods of time, unplug it from the wall outlet and disconnect the antenna or cable system. This will prevent damage to the product due to lightning and power-line surges.
- Overloading - Do not overload wall outlets, extension cords, or integral convenience receptacles as this can result in a risk of fire or electric shock.

- **A product and cart combination should be moved with care. Quick stops, excessive force, and uneven surfaces may cause the product and cart combination to overturn.**



- Servicing - Do not attempt to service this product yourself as opening or removing covers may expose you to dangerous voltage or other hazards. Refer all servicing to qualified service personnel.
- Safety Check - Upon completion of any service or repairs to this product, ask the service technician to perform safety checks to determine that The product is in proper operating condition.
- Heat - The product should be situated away from heat sources such as radiators, heat registers, stoves, or other products (including amplifiers) that produce heat.

## IMPORTANT

The following are the normal operating requirements for the display (not including OPS):

MODEL	Power requirements
EL55R2	AC100V~240V 300W max
EL65R2	AC100V~240V 300W max
EL75R2	AC100V~240V 330W max
EL86R2	AC100V~240V 450W max

For additional requirements and other information, refer to the display's specifications.

### Federal Communication Commission interference statement

FCC

Suppliers Declaration of Conformity

47 CFR § 2.1077 Compliance Information

Unique Identifier: EL55R2, EL65R2, EL75R2, EL86R2

Responsible Party – U.S. Contact Information

ELMO USA CORP.

6851 Jericho Turnpike, Suite 145

Syosset, NY 11791

This device complies with Part 15 of the FCC Rules. Operation is subject to the following two conditions:

1. This device may not cause harmful interference, and
2. This device must accept any interference received, including interference that may cause undesired operation.

### NOTE

This equipment has been tested and found to comply with the limits for a Class B digital device, pursuant to part 15 of the FCC Rules. These limits are designed to provide reasonable protection against harmful interference when the equipment is operated in a commercial environment. This equipment generates, uses, and can radiate radio frequency energy and, if not installed and used in accordance with the instruction manual, may cause harmful interference to radio communications. Operation of this equipment in a residential area is likely to cause harmful interference in which case the user will be required to correct the interference at his own expense.

### CAUTION

Any changes or modifications not expressly approved by the party responsible for compliance could void the user's authority to operate this equipment.

### Restriction

Operations in the 5.15-5.25GHz band are restricted to indoor usage only.

IEEE 802.11b or 802.11g operation of this product in the USA is firmware limited to channels 1 through 13.

### CAUTION

- i. the device for operation in the band 5150-5250 MHz is only for indoor use to reduce the potential for harmful interference to co-channel mobile satellite systems;
- ii. the maximum antenna gain permitted for devices in the bands 5250-5350 MHz and 5470-5725 MHz shall comply with the e.i.r.p. limit; and
- iii. the maximum antenna gain permitted for devices in the band 5725-5825 MHz shall comply with the e.i.r.p. limits specified for point-to-point and non point-to-point operation as appropriate.
- iv. Users should also be advised that high-power radars are allocated as primary users (i.e., priority users) of the bands 5250-5350 MHz and 5650-5850 MHz and that these radars could cause interference and/or damage to LE-LAN devices.

### Radiation exposure statement

This equipment complies with FCC radiation exposure limits set forth for an uncontrolled environment.

This equipment should be installed and operated with minimum distance of 20 cm between the antenna of this device and all nearby persons.

This transmitter must not be co-located or operated in conjunction with any other antenna or transmitter.

### EU declaration of conformity

Hereby TECHNO HORIZON CO., LTD. declares that the radio equipment type Interactive displays model EL55R2, EL65R2, EL75R2, EL86R2 are in compliance with directive 2014/53/EU.

### WARNING

Operation of this equipment in a residential environment this equipment may could cause radio interference.

The frequency band and the maximum transmitted power in EU are listed below:

Transmitting Band (MHz)	2402-2483.5	5150-5350	5470-5725
Maximum Transmit Power EIRP (dBm)	19	23	23

## Restrictions in

AT/BE/BG/CZ/DK/EE/FR/DE/IS/IE/IT/EL/ES/CY/LV/LI/LT/LU/HU/MTNL/NO/PL/PT/RO/SI/SK/TR/FI/SE/CH/UK/HR—5150M Hz-5350MHZ is for indoor use only

### CAUTION: EXPOSURE TO RADIO FREQUENCY RADIATION

This equipment complies with EU radiation exposure limits set forth for an uncontrolled environment.  
This equipment should be installed and operated with minimum distance 20 cm between the radiator and your body.

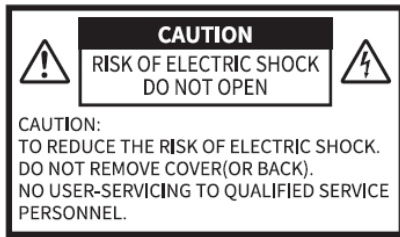

The lightning flash with arrowhead symbol, within an equilateral triangle, is intended to alert the user to the presence of uninsulated “dangerous voltage” within the product’s enclosure that may be of sufficient magnitude to constitute a risk of electric shock to persons.

The exclamation point within an equilateral triangle is intended to alert the user to the presence of important operating and maintenance (servicing) instructions in the literature accompanying the product.



This symbol [crossed-out wheeled bin WEEE Annex IV] indicates separate collection of waste electrical and electronic equipment in the EU countries. Please do not throw the equipment into the domestic refuse. Please use the return and collection systems available in your country for the disposal of this product.

## WARNING

### TO REDUCE THE RISK OF FIRE OR ELECTRIC SHOCK, DO NOT EXPOSE THIS PRODUCT TO RAIN OR MOISTURE.

The connection of a non-shielded equipment interface cable to this equipment will invalidate the FCC Certification or Declaration of this device and may cause interference levels which exceed the limits established by the FCC for this equipment. It is the responsibility of the user to obtain and use a shielded equipment interface cable with this device. If this equipment has more than one interface connector, do not leave cables connected to unused interfaces. Changes or modifications not expressly approved by the manufacturer could void the user’s authority to operate the equipment.

## USER-INSTALLER

### CAUTION:

Your authority to operate this FCC verified equipment could be voided if you make changes or modifications not expressly approved by the party responsible for compliance to Part 15 of the FCC rules.

## BEFORE YOU USE

- Be sure to use the cable supplied with the product.
- The supplied power cord are designed for exclusive use with this product.  
Do not use them with other products.
- Do not strongly press the touchscreen or press it with sharp objects.  
This may result in damage or malfunction to the touchscreen.
- Be sure to use the power cord applicable to your local power specifications. It may be discolored, deformed, or damaged.
- Do not place this product in any humid, dusty, salt bearing wind, or vibrating locations.  
Use it under the following environmental conditions:  
Temperature : 0°C ~ 40°C  
Humidity : 30% ~ 85% (No condensation)
- Use a soft, dry cloth for cleaning. Do not use any volatile solvent such as thinner or benzene.
- If this product is used for longer than the warranty period, its performance and quality may deteriorate due to the lifetime of its parts. For parts replacement (on chargeable basis), consult the dealer from whom you purchased this product or our branch/office near your location.
- Copyright  
Unless used for personal use, it is prohibited strictly under copyright law to use any photo files without the prior consent of the copyright holder.
- It is prohibited under copyright law to use or copy any part or the whole of this document without our prior written consent.
- ELMO shall not be liable for any claim for damage or loss of earnings or any claim raised by a third person due to the use, malfunction or repair of this product.

**ELMO** is registered trademarks of TECHONO HORIZON CO., LTD.

All other company/product names described in this manual are trademarks or registered trademarks of their respective companies.

# 1 Before Use

## 1.1 Package Contents

The items below are included with this product. If any item is missing, contact the dealer from whom you purchased this product.



Display monitor

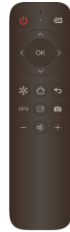

Remote control

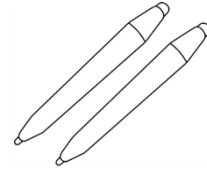

Touch pen x2

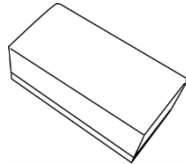

Eraser



Power cord x3 (3m)  
(TypeA/TypeC/TypeBF)

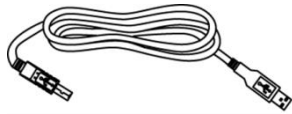

USB cable  
※TypeB-TypeA (3m)

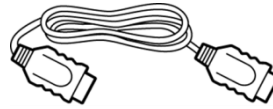

HDMI cable (3m)

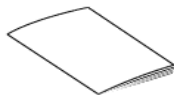

Quick Start Guide

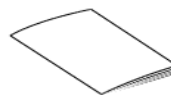

Important Safeguards

# 1.2 Part Names and Functions

## 1 Front

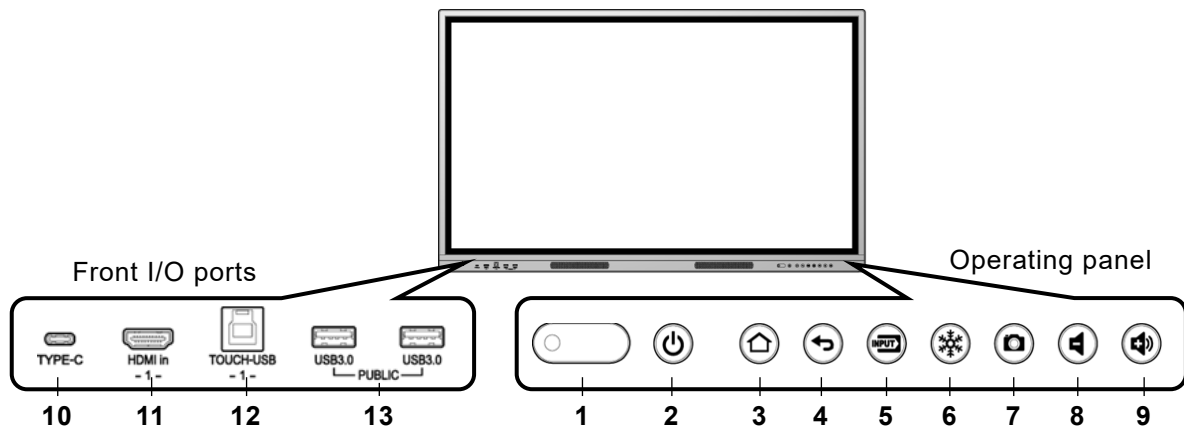

### Operating panel

No.	Mark	Name	Function
1		IR receiver	IR receiver for the remote control.
		Power LED	To indicate the power status. On: Green Off: Red
2		Power	Long press: To turn on or off the power. Short press: To enter or cancel the standby mode.
3		Home	To display the Home screen. (⇒P.20)
4		Return	To go back to the previous screen.
5		Input select	To display the Source Settings screen. (⇒P.67)
6		Freeze	To pause the input video (HDMI / Display Port / USB Type-C / VGA). Press this button again to restart.
7		Screenshot	To capture the currently displayed screen and save it. The captured image will be saved in the CameraRoll folder.
8		Volume down	To decrease the volume.
9		Volume up	To increase the volume.

### Front I/O ports

No.	Name	Function
10	Type-C (USB Type-C)	To connect to a USB Type-C device to input video and audio into the product. It is possible to charge some devices. When connected to a computer, you can control the computer from the product by touching the screen of the display monitor.
11	HDMI in (HDMI Type-A)	To connect the supplied HDMI cable to input video and audio into the product.
12	TOUCH-USB (USB Type-B)	To connect the supplied USB cable to control the computer from the product by touching the screen of the display monitor.
13	USB3.0 (USB Type-A)	To connect a device (such as a USB flash drive, USB mouse, USB keyboard, or USB camera) that supports USB3.0 and USB2.0.



## 2 Side and Bottom

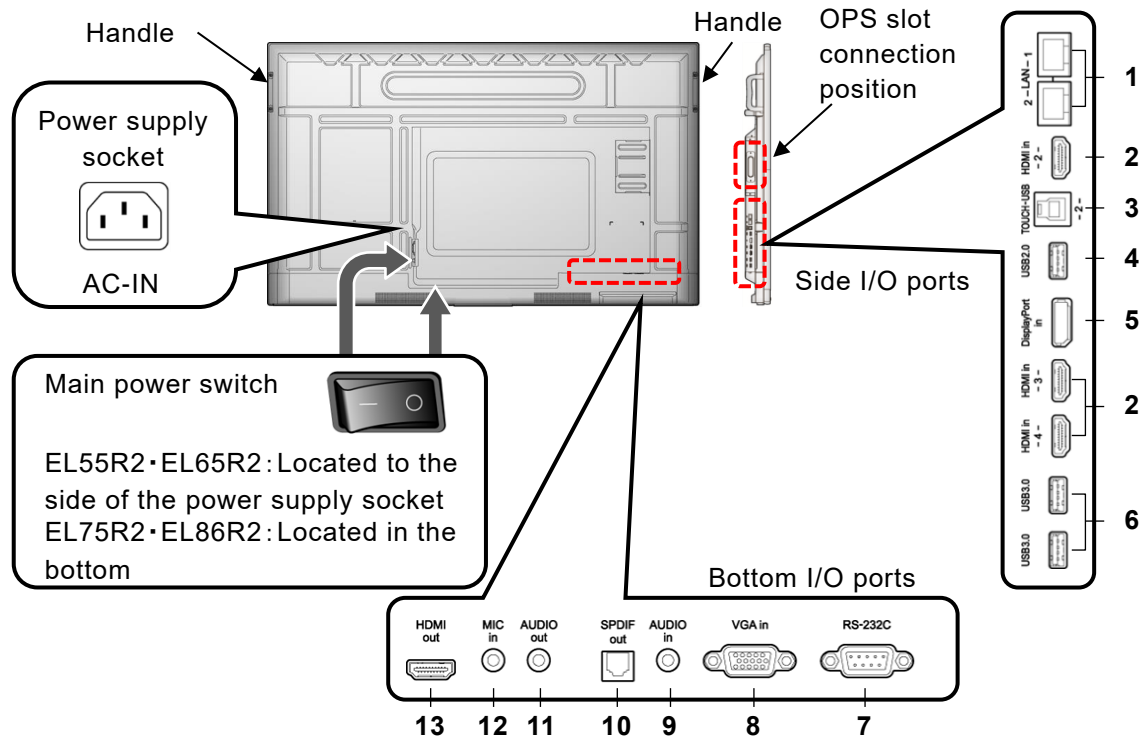

### Side I/O ports

No.	Name	Function
1	LAN (RJ-45)	To connect to the network using a LAN cable.
2	HDMI in (HDMI Type-A)	To connect the supplied HDMI cable to input video and audio into the product.
3	TOUCH-USB (USB Type-B)	To connect the supplied USB cable to perform touch operation for the connected computer on the display monitor of the product.
4	USB2.0 (Type-A)	To connect a USB device (such as a USB flash drive, USB mouse, USB keyboard, or USB camera) that supports USB2.0.
5	Display Port in	To input video and audio into the product.
6	USB3.0 (USB Type-A)	To connect a device (such as a USB flash drive, USB mouse, USB keyboard, or USB camera) that supports USB3.0 and USB2.0.

### Bottom I/O ports

No.	Name	Function
7	RS-232C	To control the product from a computer via RS-232C.
8	VGA in	To connect a video source device using a VGA cable to input video into the product.
9	AUDIO in	To connect an audio source device to input audio into the product. [ $\phi$ 3.5mm jack (monaural)]
10	SPDIF out	To connect an optical digital cable to output audio of the product.
11	AUDIO out	To connect an audio output device such as a headphone or active speaker to output audio of the product. [ $\phi$ 3.5mm jack (monaural)]
12	MIC in	To connect an external microphone to input audio into the product. [ $\phi$ 3.5mm jack (monaural)]
13	HDMI out	To connect the supplied HDMI cable to output video and audio of the product.

※ KL55R2 (HOL), KL65R2 (HOL), KL75 (HOL), KL86 (HOL) is a model without HDMI-out.

### 3 Touch pen and Eraser

---

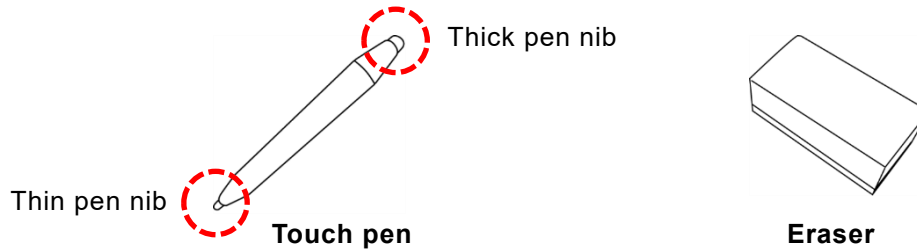

You can perform touch operations using the supplied Touch pen.

With ELMO Note, it is possible to make different settings for the thick pen nib and the thin pen nib and draw different lines. Drawn lines can be deleted with the Eraser. (⇒P.28)

The Touch pen and the Eraser are equipped with magnets and can be attached to the attachment surface under the display monitor.

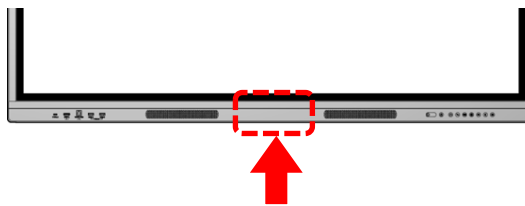

---

#### Note

- If you place your finger near the nib of the Touch pen, it may malfunction.
  - If you use the thick pen nib away from the touchscreen, it may be recognized as a thin pen nib.
  - Do not press the pen nib anywhere other than the screen. It may not work properly.
  - When using multiple Touch pens, touch positions and pen information may be swapped, and line breaks may occur.
  - If the pen nib becomes worn or damaged, replace the Touch pen.  
For purchasing a Touch pen, contact the dealer where you purchased the product.
  - Do not attach anything other than the supplied Touch pen to the attachment surface.
  - There are two attachment surfaces for EL65R2, EL75R2, and EL86R2, and one for EL55R2. Not all included Touch pens or Erasers can be attached.
  - The supplied Touch pen has a built-in magnet. Keep the pen away from watches and magnetic cards.
-

## 4 Remote Control

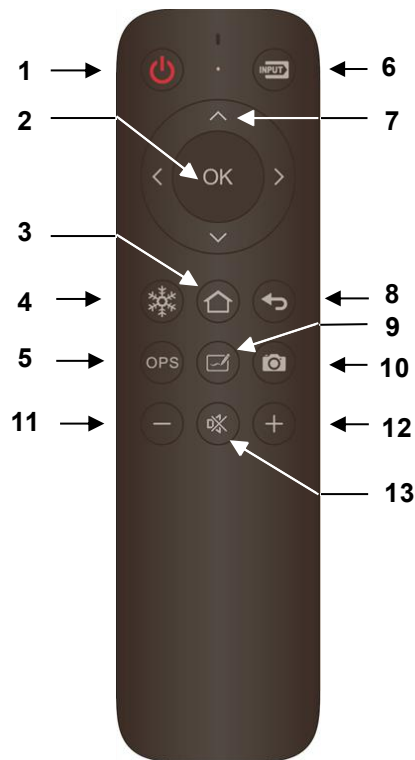

No.	Name	Function
1	Power button	Long press: To turn on or off the power. Short press: To enter or cancel the standby mode.
2	Enter button	To decide the selection in a dialog box.
3	Home button	To display the Home screen. (⇒P.20)
4	Freeze button	To pause the input video (HDMI / Display Port / USB Type-C / VGA). Press this button again to restart.
5	OPS button	To display the screen of the PC unit (Windows). ※Optional
6	Input select button	To display the Source Settings screen. (⇒P.67)
7	Direction buttons	To move the selection item up, down, left, and right.
8	Return button	To go back to the previous screen.
9	Whiteboard button	To start the whiteboard app (ELMO Note). (⇒P.25)
10	Screenshot button	To capture the currently displayed screen and save it.
11	Volume down button	To decrease the volume.
12	Volume up button	To increase the volume.
13	Mute button	To mute the audio output. Press this button again to release the mute.

**Note** Save destination of the image captured by the Screenshot button:  
Local > CameraRoll

## ◆ Preparation

### ■ Inserting batteries

1. Slide and open the cover in the back of the remote control.
2. Insert 2pcs of AAA batteries.  
Pay attention to the polarity, which is printed inside the remote control.
3. Firmly close the cover.

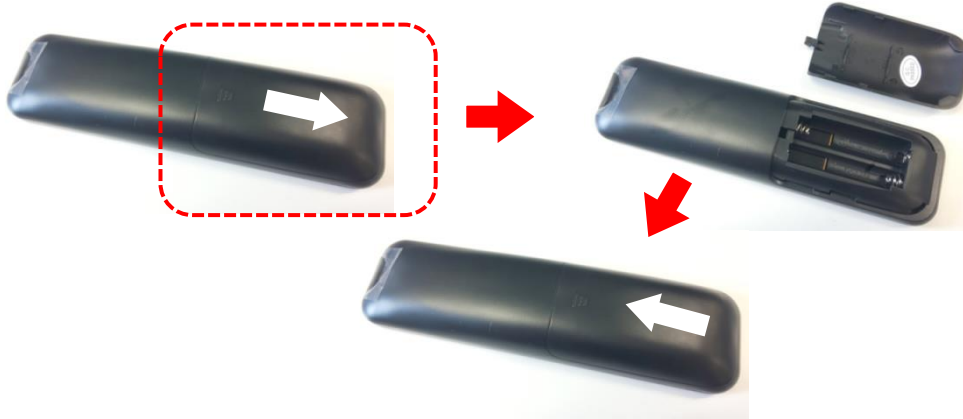

#### Note

- Use manganese AAA batteries for the batteries.
- When battery power becomes low, replace them with new batteries as soon as possible.
- If you do not use the remote control for a long time, remove the batteries from the remote control.

### ■ Operable Range of the Remote Control

If there is no obstruction between the IR receiver of the display monitor and the remote control, the operable range of the remote control is as follows:

Distance: within 5m

Angle: within 30° up, down, left, and right

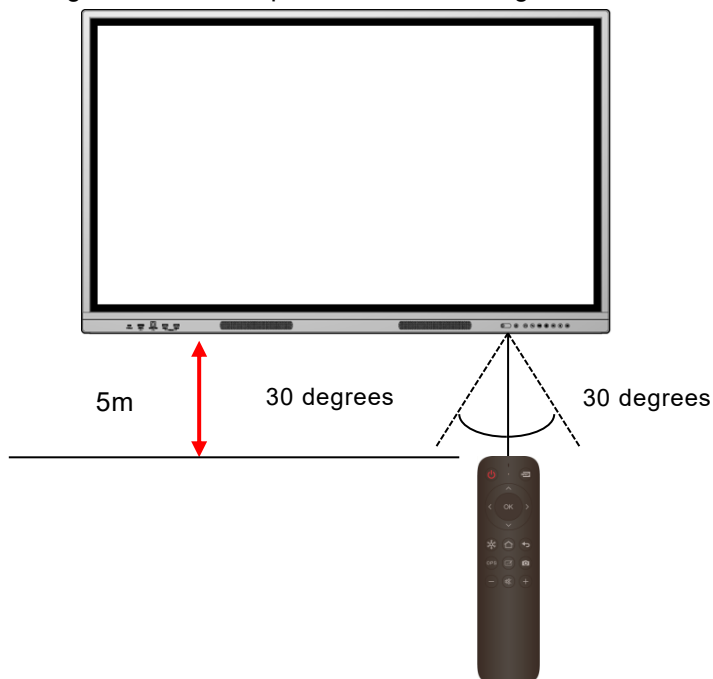

## 1.3 Installation

### 1 Installation Conditions

• Use the product in the following conditions.

Temperature	0~40°C
Humidity	20~80%

• To prevent internal heat buildup, install the display monitor in a well-ventilated place, keeping the distance as specified in the following figure from the surrounding area.

Use the following screws to attach the VESA brackets.

For EL65R2•EL75R2•EL86R2: M8 screws with a length of 20 mm

For EL55R2: M6 screws with a length of 20 mm

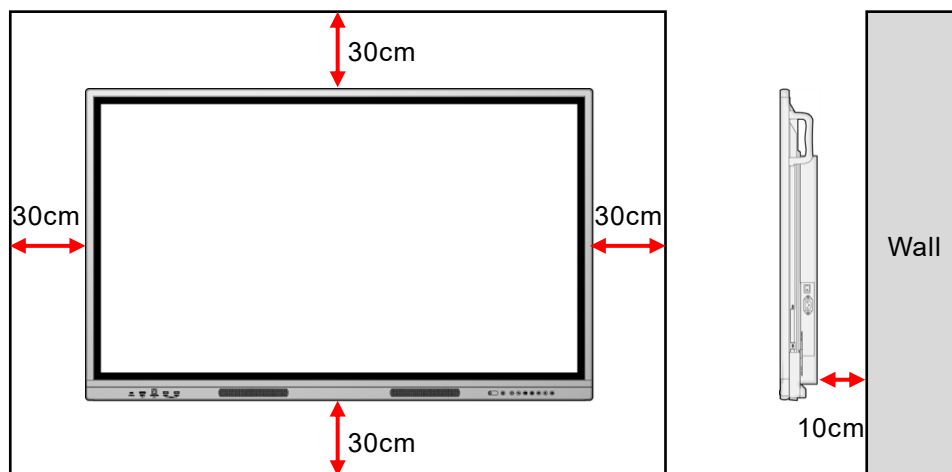

#### Caution

- Since the display monitor is heavy, consult the dealer from whom you purchased this product when installing, removing or moving it.
- Installation must be done by professional service engineers. Otherwise, injury may occur by improper installation.
- If you want to mount the display monitor on a wall or suspend it from the ceiling, ask a specialist for installation work.  
ELMO is not responsible for any accident or damage caused by improper installation.
- If you need to move the display monitor after it is attached to the stand, always move the product with 2 or more people.
- Be careful not to block the ventilation holes when installing. The heat will be trapped inside and may cause a malfunction or a fire.
- Do not install the display monitor in a place where it may be exposed to rain or spray, or in a place with high humidity.
- Do not install the display monitor near the air outlet of the air conditioner.  
Condensation may form due to sudden temperature changes, which may corrode the inside and cause a malfunction.

## ◆ Attachment of the Display Monitor to the Stand

You can attach the display monitor to the stand.

The positions of the screw holes are as shown in the following figure.

For the assembly of the stand, refer to the instruction manual of the stand.

55 inch: VESA 400x400  
65 inch: VESA 600x400  
75 inch: VESA 800x400  
86 inch: VESA 800x600

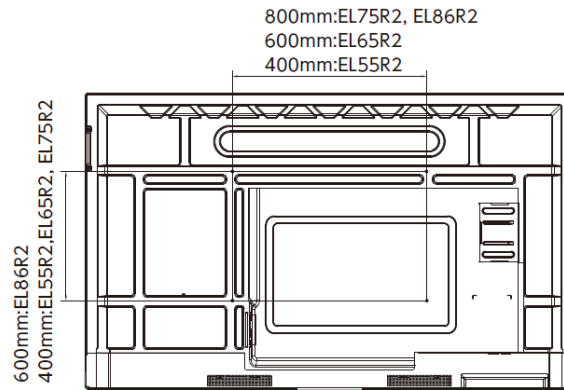

# 1.4 Turning On or Off the Power

## 1 Connecting the Power Cord

Connect the supplied power cord to the power supply socket on the side and plug the power plug into an outlet.

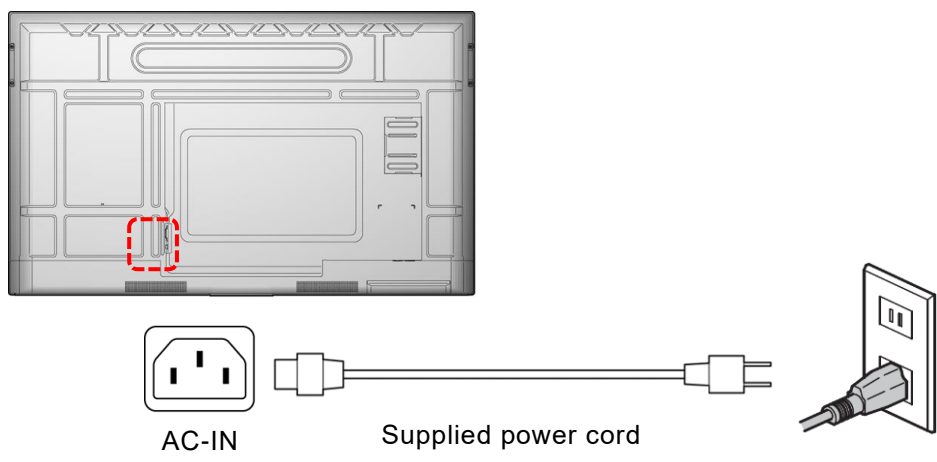

### Caution

- Always use the supplied power cord.
- Use the power cord usable in your country.

## 2 Turning On the Power

### 1 Press “-“ on the Main power switch on the bottom.

Location of the Main power switch:

For EL55R2 and EL65R2: Side

For EL75R2 and EL86R2: Bottom

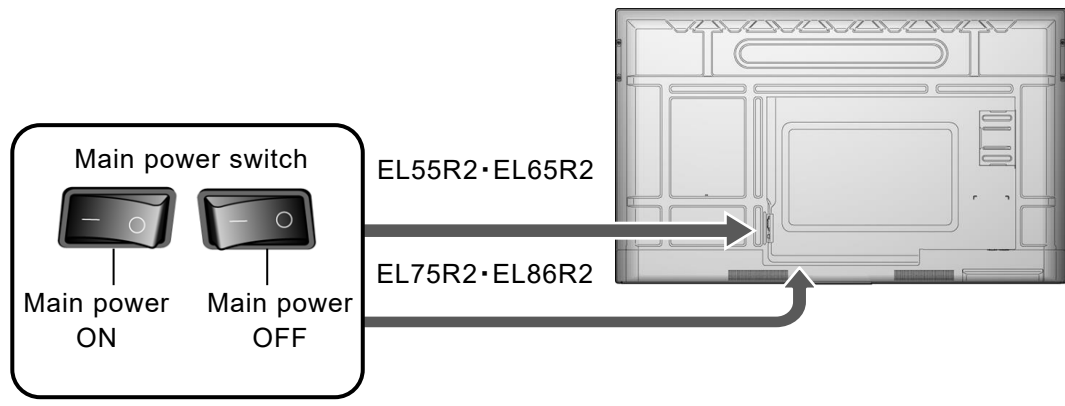

### 2 Long-press the Power button on the front.

The power can also be turned on by long-pressing the Power button on the remote control.

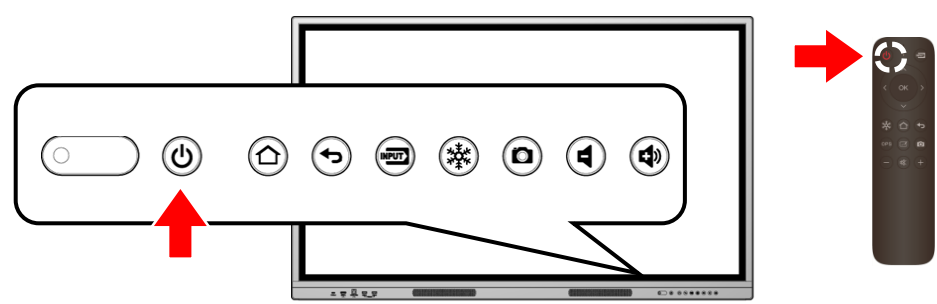



## ◆ Initial Startup

At initial startup, the Settings screen will appear in the order of "Language setting", "Date and time setting", and "Network setting".

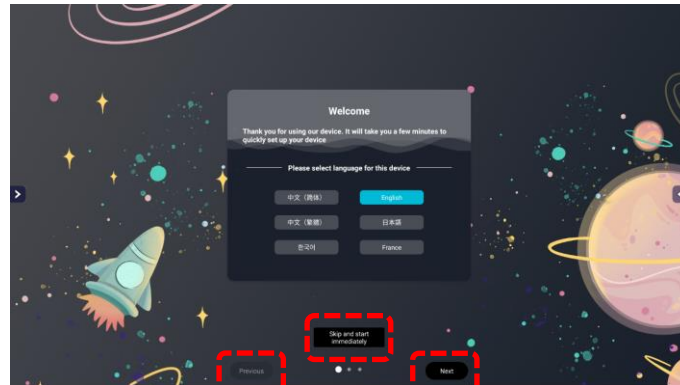
Settings after "Language setting" can be skipped by tapping "Skip and start immediately" or "Next".



To go back to the previous screen    To go to the next page

To skip all subsequent steps and complete the settings

### 1 Language setting



Tap the language 

### 2 Date and Time setting

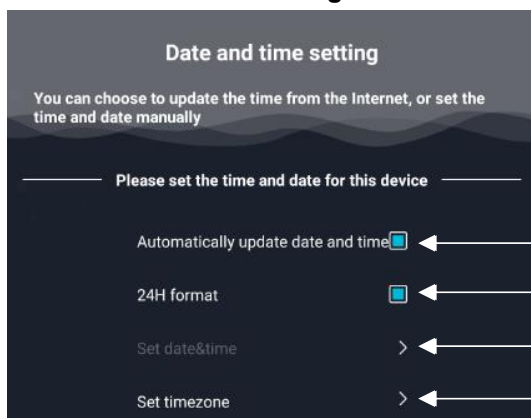

The date and time are automatically set according to the time zone.

ON: To display the time in 24-hour format  
OFF: To display the time in 12-hour format

To configure the date and time setting manually when "Automatically update date and time" setting is OFF

To set the time zone



### 3 Network setting

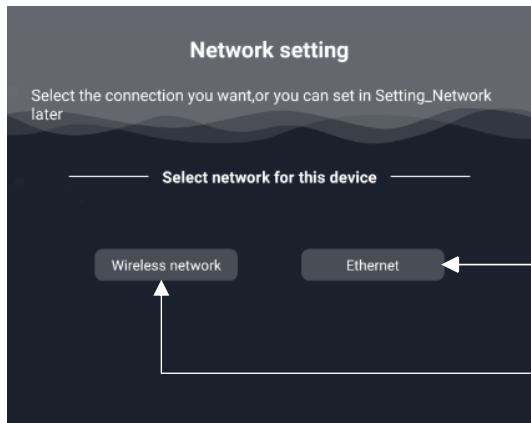

To configure the wired network settings

To configure the wireless network (wireless LAN) settings

#### Note

- For the Network setting, set either Wireless network or Ethernet.
- If you want to set the proxy in the Wireless network settings, or if you want to connect to a stealth access point, set them after displaying the Home screen. It is not possible to set them from the initial startup screen. (⇒P.70)
- Language setting, Date and time setting, and Network setting can be reset.

### 4 Home screen

The Home screen will appear after completing all the settings.



## 3 Turning Off the Power

### 1 Long-press the Power button on the front

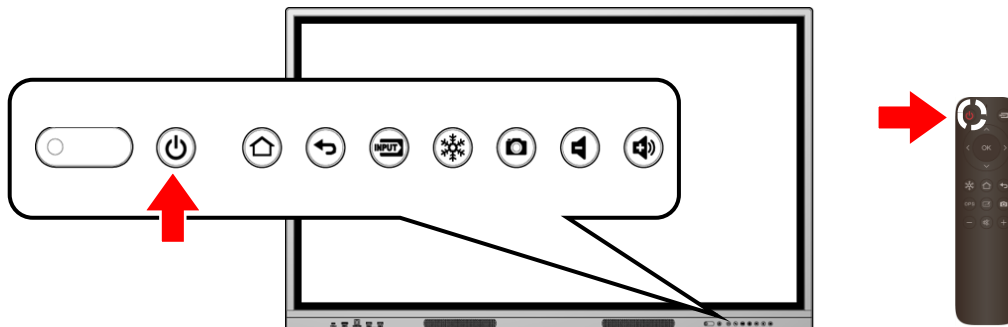

The power can also be turned off by long-pressing the Power button on the remote control.

## 2 Select “Sure” in the Shutdown confirmation dialog.

Select “Cancel” if you want to cancel the shutdown.

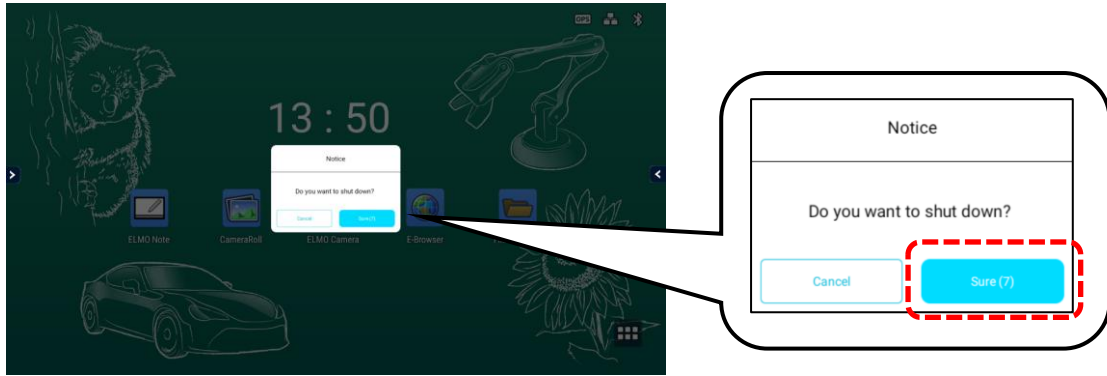

## 3 Press “O” on the Main power switch on the bottom.

### Note

- If there is no operation after the Shutdown confirmation dialog is displayed and the countdown timer reaches zero, the product will automatically shut down.
- Do not press “O” on the Main power switch on the back before shutting down the product. By doing so may cause a malfunction.
- If you do not use the product, shut it down.
- If the product freezes or is unstable, try shutting it down.

## 4 Standby Mode

Press the Power button on the front while the product is turned on to enter the Standby mode. To cancel the Standby mode, press the Power button again.

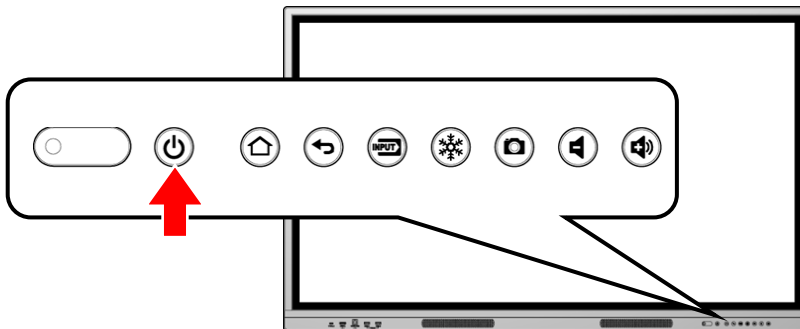

### Note

- The Power LED turns green in the Standby mode.
- The Power LED turns red when the product is shutdown.

## 2 Basic Operations

### 2.1 Touch Operations

You can perform touch operations with your finger or the supplied Touch pen.  
For details on Windows touch operations, refer to Windows Help.

Name	Function	Finger movements
Single tap (Tap)	Touch once briefly. <ul style="list-style-type: none"> <li>Works as the left click of a mouse.</li> </ul>	
Double tap	Touch same place twice quickly. <ul style="list-style-type: none"> <li>Works as the double click of a mouse.</li> </ul>	
Long-press	Touch and hold. <ul style="list-style-type: none"> <li>Works as the right click of a mouse.</li> </ul>	
Drag and drop	Touch and hold the icon or slide and move it. Then release the finger at the specified position. <ul style="list-style-type: none"> <li>Works as the drag and drop of a mouse.</li> </ul>	
Swipe / Flick	Swipe: Move the finger while touching the screen. Flick: Touch the screen and brush the finger quickly across the screen.	
2-finger press	Touch and hold with two fingers. The distance between two points should be 2-5 cm.	
Zoom in (Enlarge)	Touch two points at the same time and move fingers away from each other. <ul style="list-style-type: none"> <li>To be used in the screen where zooming operation is possible.</li> </ul>	
Zoom out (Shrink)	Touch two points at the same time and move fingers closer to each other. <ul style="list-style-type: none"> <li>To be used in the screen where zooming operation is possible.</li> </ul>	

## 2.2 Basic Screen Operations

### ◆ Home Screen

The Home screen will appear when the power is turned on.

Tap the List of apps icon at the bottom right of the screen to display a list apps installed on the product.

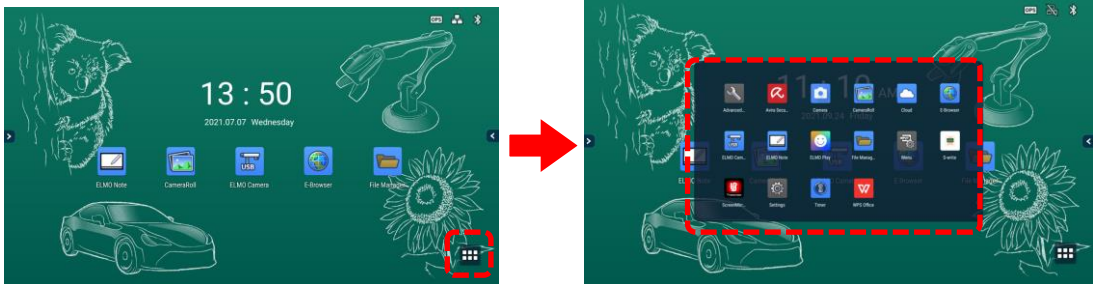

### Main Apps

Icon	Name	Function
	ELMO Note	To start ELMO Note (whiteboard). (⇒P.25)
	Camera Roll	To start Camera Roll. (⇒P.38)
	ELMO Camera	To start a USB camera. (⇒P.40)
	E-Browser	To start E Browser. (⇒P.42)
	File Manager	To start File Manager. (⇒P.56)
	Timer	To start ELMO timer. (⇒P.45)
	Screen Mirror (Transcreen)	To share the screen of other device such as a tablet. (⇒P.51)
	Avira Security	To perform a virus scan or cleanup of internal memory. (⇒P.54)
	ELMO Play	To start ELMO Play. (⇒P.55)
	Menu	To configure the Source Settings. (⇒P.67)
	Settings	To configure the settings of the product. (⇒P.70)
	Advanced Setting	To set the proxy settings or connection settings to the stealth access point when connecting to the wireless network. (⇒P.71)
	WPS Office	To create/view/edit/save Office documents or browse PDF files.
	Cloud	To start Cloud. You can select between “Google Drive” and “One Drive”.

## ◆ Shortcuts of Apps

You can add, delete, or change the position of app icons (app shortcuts) on the Home screen.

**Note** You need to set “Allow home screen editing” in the Security Settings to ON before editing the app icons.

Settings  > Security Settings > Allow home screen editing (⇒P.76)

### 〈Adding an App Shortcut〉

- 1 Display a list of apps.
- 2 Long-press the app icon that you want to add to the Home screen.
- 3 Drag and drop the app icon to a desired position on the Home screen.

A new app shortcut will be added on the Home screen.

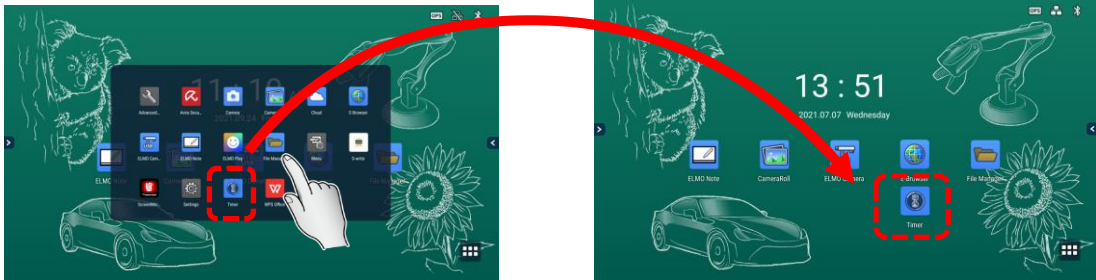

### 〈Moving an App Shortcut〉

- 1 Long-press the app icon that you want to move on the Home screen.
- 2 Drag and drop the app icon to a desired position.

The app icon will be moved to the dropped position. If the icon is dragged to the right edge of the screen, a new page will be added to the right.

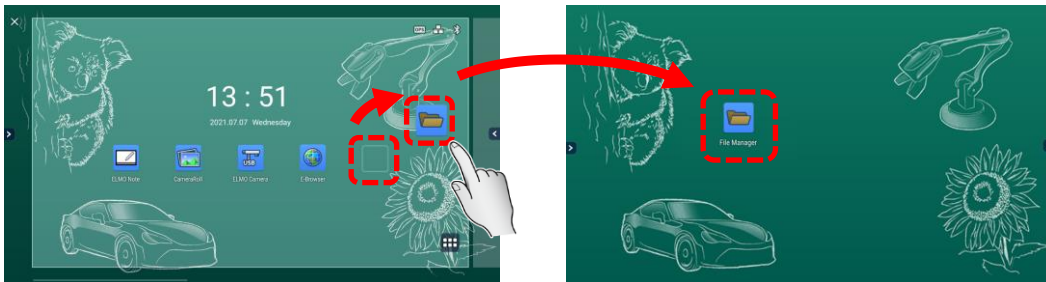

### 〈Removing an App Shortcut〉

- 1 Long-press the app icon that you want to remove from the Home screen.
- 2 Drag and drop the app icon to the “X” mark at the top left of the Home screen.

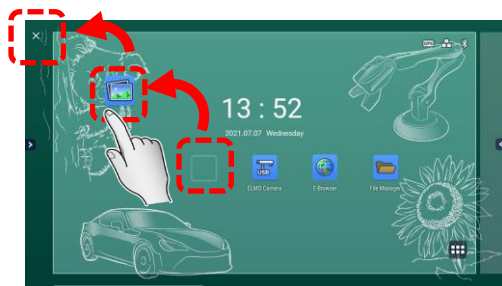

## ◆ Uninstallation of Apps



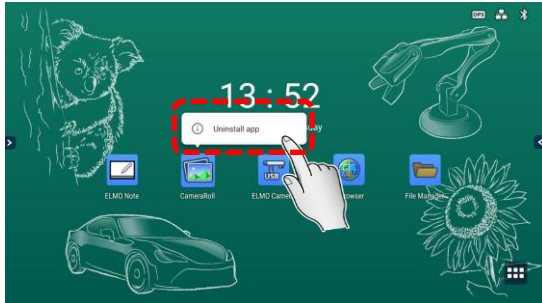



- 1 Long-press the app icon that you want to uninstall on the Home screen.**  
A popup of “Uninstall app” will appear.
- 2 Tap “Uninstall app”.**  
A confirmation dialog box will appear.
- 3 Tap “OK”.**  
The app will be uninstalled from the product.

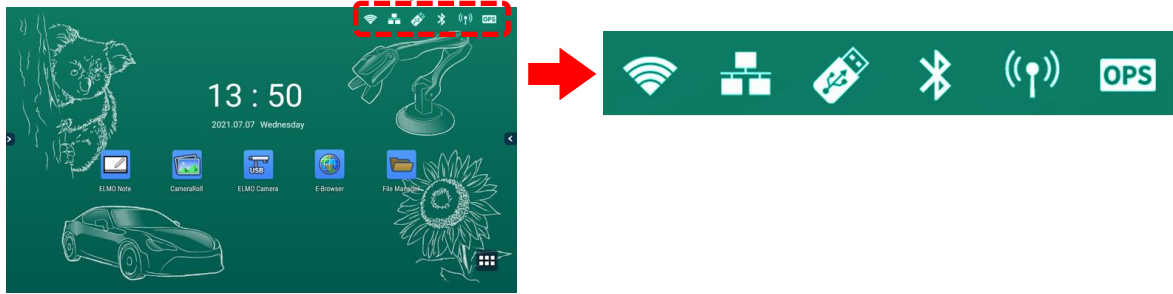



## ◆ Connection Status Icons on the Home Screen

The icons displayed at the top right of the Home screen provide information about the status of the network connection of the product.









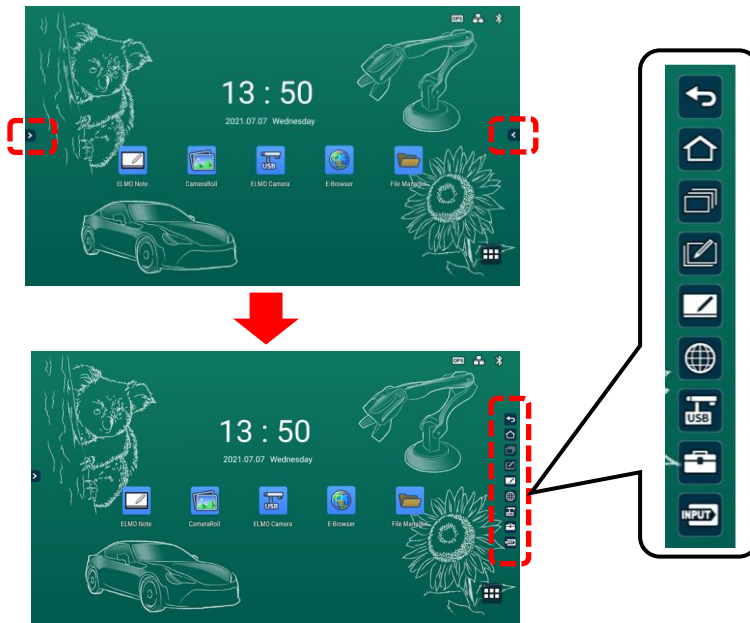





Icon	Name	Function
	OPS	This icon appears when the product is connected with OPS (sold separately).
	Hotspot	This icon appears when the Hotspot setting is on.
	Bluetooth	This icon appears when the product is connected with a Bluetooth device.
	USB flash drive	This icon appears when the product is connected with a USB flash drive.
	Ethernet	This icon appears when the wired network setting is on. A diagonal line appears over the icon when the product is not connected to the Internet.
	Wireless	This icon appears when the wireless network (Wi-Fi) setting is on. The number of bars indicates the strength of the wireless signal. (Max. 4 bars) A diagonal line appears over the icon when the product is not connected to the Internet.

## ◆ Displaying the Side Menu Bar

Touch  or  on either edge of the Home screen to display the side menu bar.



**Note** The position of [][] icons can be changed by swiping them up and down.

Icon	Name	Function
	Return	To go back to the previous screen.
	Home	To display the Home screen. (⇒P.20)
	Task view	To display a thumbnail list of the running apps. <ul style="list-style-type: none"> <li>● Press “X” at the top right corner of the task to close the task.</li> <li>● Press “CLEAR ALL” to close all the tasks.</li> </ul> 
	Overlay	To start the Overlay app. (⇒P.37)
	ELMO Note	To start ELMO Note (whiteboard). (⇒P25)
	E-Browser	To start E Browser. (⇒P.42)
	ELMO Camera	To start a USB camera. (⇒P.40)
	Utilities	To start pre-installed utilities. (⇒P.61)
	Menu	To display the Source Settings screen. (⇒P67)



# 3 Using Apps

## 3.1 Using ELMO Note (Whiteboard)

You can use the screen like a whiteboard or blackboard.  
You can draw lines and diagrams, and place images and videos.

### ◆ Startup

Tap the ELMO Note icon in the list of apps or the side menu bar.



### ◆ Initial Startup

When you start ELMO Note or Overlay app for the first time, the initial settings screen will appear. Enable "Accessibility Permission" and "Storage Permission" settings before start. They may have been set depending on the version you are using.

#### 1 Configuring the Accessibility Permission Setting

Tap "SETTING" in the Setting screen.

Tap "ELMO Note" and set the "Use service" setting to ON .

Press the Return button on the Operating panel to go back to the Setting screen.

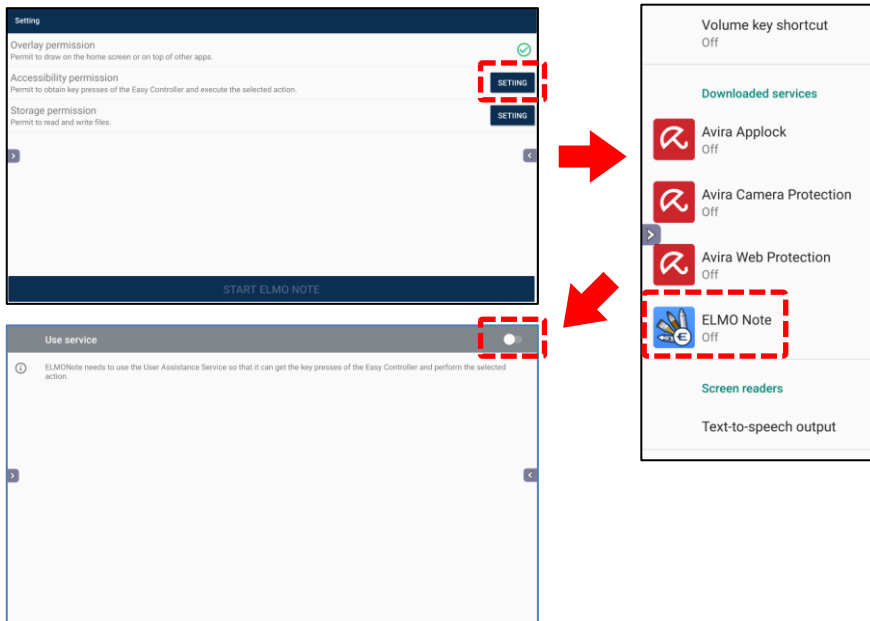

#### 2 Configuring the Storage Permission Setting

Tap "SETTING" in the Setting screen. Then tap "Allow" to allow ELMO Note to access the storage.

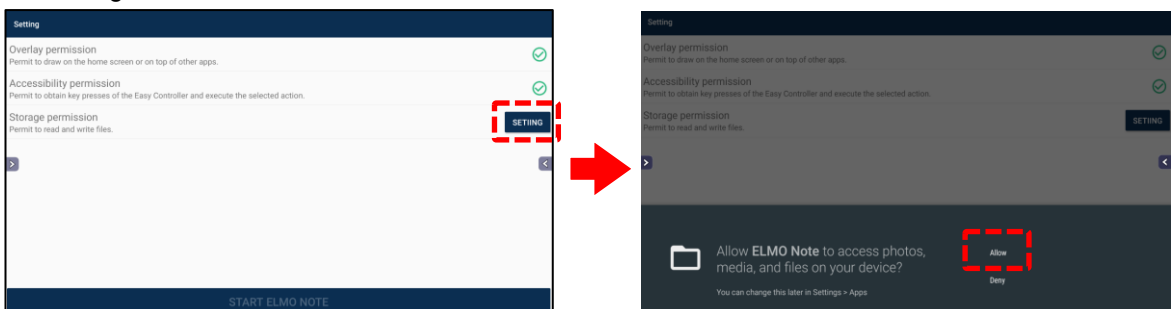

### 3 Tap “START ELMO NOTE” after completing all the settings.

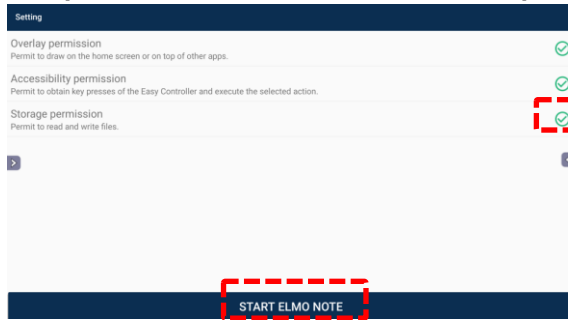

## ◆ Basic Operations

### Drawing lines and shapes

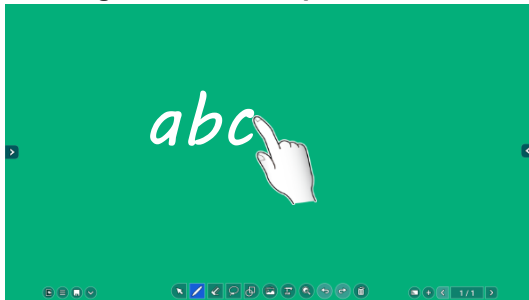

Tap the Pen icon and trace on the screen with your finger or Touch pen.



When the Pen icon is double-tapped, you can change the line color and thickness. (⇒ P.28)

### Deleting the lines

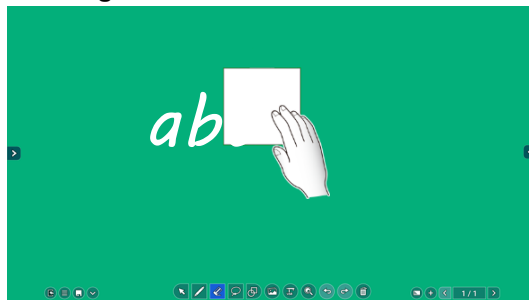

Tap the Eraser icon and rub the screen to delete the lines.

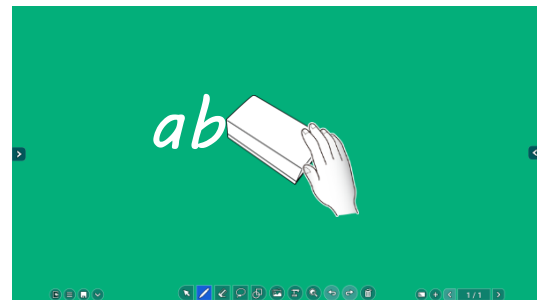

You can also delete the lines using the supplied Eraser.

### Editing the lines

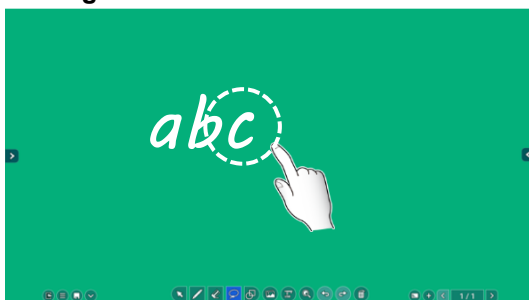

Tap the Select icon and circle the line that you want to edit.

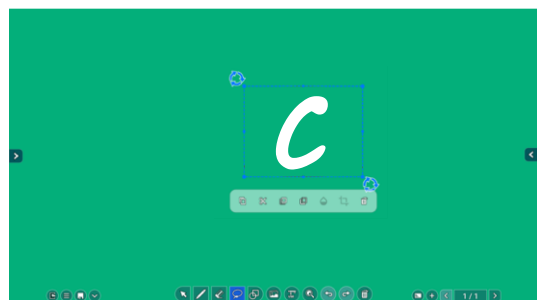

The selected object can be copied, deleted, and moved by dragging. (⇒P.33)

## ◆ Screen Description

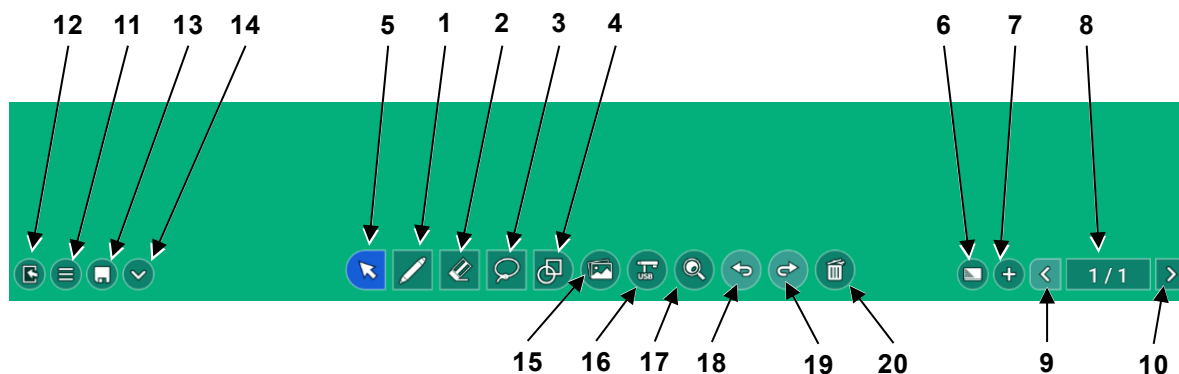

No.	Name	Function
1	Pen	To draw free-hand lines. (⇒P.28)
2	Eraser	To delete the lines and objects. (⇒P.29) If you tap this icon while an object is selected, the selected object will be deleted.
3	Select	To select the lines and objects on the screen. (⇒P.29)
4	Shapes	To draw various shapes. (⇒P.30)
5	Operation	To pan and zoom the whole area. (⇒P.30)
6	Background	To change the background of the whiteboard. Various colors, patterns, and designs can be selected. (⇒P.31)
7	Add page	To add a new page to the next page of the currently displayed page. (Max. 30 pages can be added.) The same background as the selected page will be applied to the added page. (⇒P.32)
8	Page operation	To display thumbnails of each page. Tap the thumbnail to move to the page of the tapped thumbnail. Tap the Page back button and Page forward button to move between pages. (⇒P.32)
9	Page back	To move to the previous page.
10	Page forward	To move to the next page.
11	Menu	To open the menu. (⇒P.34)
12	Exit	To end ELMO Note.
13	Save	To display the Save dialog box. (⇒P.36)
14	Hide toolbar	To hide the toolbar. Tap this icon again to show the toolbar.
15	Camera Roll	To start the Camera Roll app. Images and videos can be attached to ELMO Note. (⇒P.38)
16	USB camera	To start the ELMO Camera app. (⇒P.40)
17	Enlarge	To enlarge the area selected by dragging operation. Using icons “+” and “-”, you can change the magnification ratio between 100% and 2400%. In the Operation mode, you can change the magnification ratio between 50% and 2400%.
18	Undo	To undo the last operation.
19	Redo	To cancel the undo operation.
20	Clear all	To delete all the drawings and shapes. The background will not be deleted.

## ◆ Pen Menu

The Pen menu will appear when the Pen icon in the toolbar is tapped again in the Pen mode.

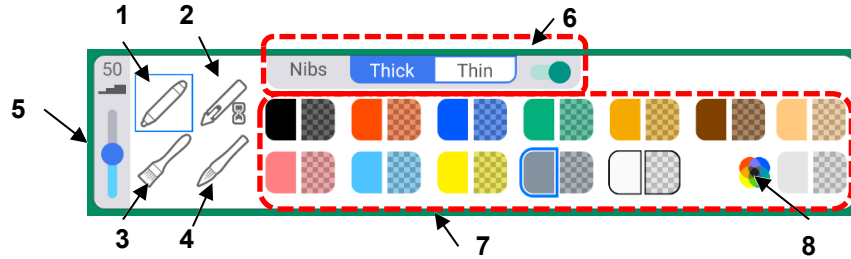

No.	Name	Function
1	Normal pen	To draw with a normal pen.
2	Instruction pen	To draw lines that will disappear in 3 seconds.
3	Paint brush	To draw with a pen with a vertical rectangular nib.
4	Ink brush	To draw with a pen whose thickness changes with speed.
5	Line thickness	To set the line thickness of the pen.
6	Pen nib settings	To configure the settings of the supplied Touch pen when the Normal pen is selected. <ul style="list-style-type: none"> <li>● Thick: to configure the settings of the thick nib.</li> <li>● Thin: to configure the settings of the thin nib.</li> <li>● You can enable or disable the thin nib with the switch on the right. (When the Thin nib setting is disabled, the Thick nib setting will be applied to both thin nib and thick nib of the Touch pen.)</li> </ul>
7	Pen color	To select the color of the pen.
8	Color palette	To display the color palette. You can select any color in the color palette.

## ◆ Eraser menu

The Eraser menu will appear when the Eraser icon in the toolbar is tapped again in the Eraser mode.

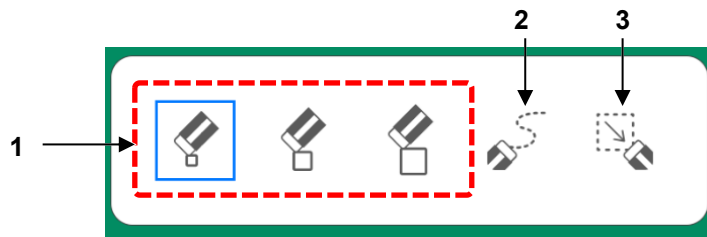

No.	Name	Function
1	Normal eraser	To delete a portion of the drawing touched by the Eraser icon. There are 3 different sizes of icons available: Small, Medium, Large
2	Partial eraser	To delete a portion of the drawing touched by your finger while dragging on the screen.
3	Area eraser	To delete the drawing in the area selected by dragging on the screen.

### Note Deleting with the palm of your hand or the supplied Eraser

When your palm (an area of contact exceeding a predetermined size) or the supplied Eraser is detected, the Eraser icon will appear on the screen, and you can delete a portion of the drawing touched by the Eraser icon.



To prevent a deletion failure, ensure to perform the deleting operation only after the Eraser icon is displayed.

**Caution** Shapes (excluding lines) and images cannot be deleted using the "Normal eraser" function, the palm of your hand, or the supplied Eraser. Use the "Partial eraser" function or the "Area eraser" function.

## ◆ Selection Menu

The Selection menu will appear when the Select icon in the toolbar is tapped again in the Selection mode.

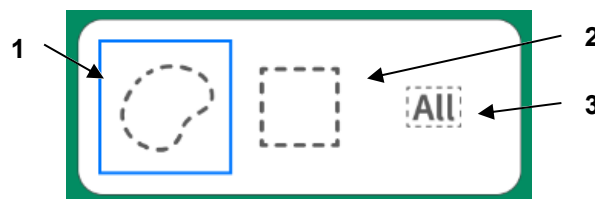

No.	Name	Function
1	Lasso selection	To select the objects within the range specified by the lasso. You can also select by tapping each object.
2	Rectangular selection	To select the objects within the range specified by dragging. You can also select by tapping each object.
3	Select all	To select all the objects on the screen.

## ◆ Shapes Menu

The Shapes menu will appear when the Shapes icon in the toolbar is tapped again in the Shapes mode.

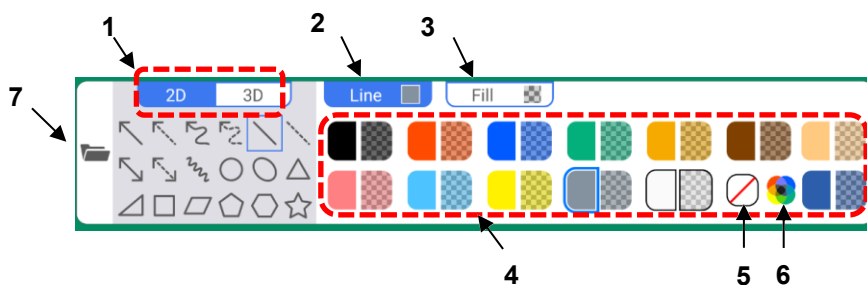

No.	Name	Function
1	2D·3D	To switch between 2D and 3D for the shape.
2	Line	To select the color of the line.
3	Fill	To select the color of the shape.
4	Color	To select the color.
5	Transparent	To make the color transparent.
6	Color palette	To display the color palette. You can select any color in the color palette.
7	File	To start the File Manager app. You can paste images and videos onto the whiteboard.

## ◆ Functions Available in the Operation Mode

The product will enter the Operation mode when the Operation icon in the toolbar is tapped.

No.	Name	Function
1	Enlarge	To change the magnification ratio during zoom in/out operations. The screen will be enlarged, centering on where you originally touched. To enlarge the area selected by dragging operation. Using icons “+” and “-”, you can change the magnification ratio between 100% and 2400%. In the Operation mode, you can change the magnification ratio between 50% and 2400%.
2	+ · -	To change the magnification ratio between 100% and 2400%. “+” and “-” icons will not appear when the magnification ratio is 100%.
3	Scroll	To scroll the enlarged area of the screen by dragging. This function is disabled if the magnification ratio is 100% or less.

## ◆ Background Menu

The Background menu will appear when the Background icon in the toolbar is tapped.

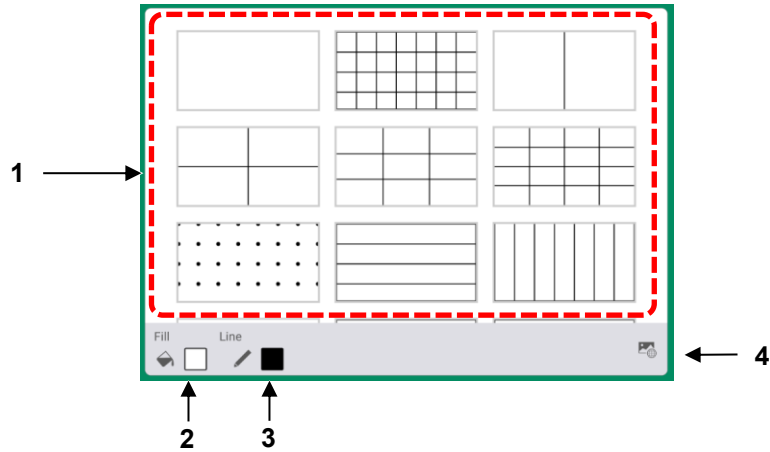

No.	Name	Function
1	Background	To select the background. Tap any background design to change the background.
2	Fill	To select the color of the background. You can also select the color from the color palette.
3	Line	To select the color of the line. You can also select the color from the color palette.
4	Background image	To display the Background image menu.

## ◆ Background Image Menu

The Background image menu will appear when the Background image icon [  ] at the bottom right of the screen in the Background menu is tapped.

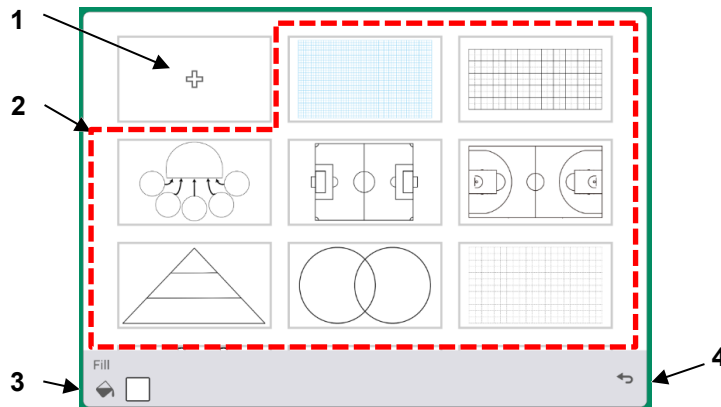

No.	Name	Function
1	Add new background image	To add an image file to be displayed as the background from the File Manager.
2	Background image	To select a pre-installed background image as the background.
3	Fill	To select the color of the background. You can also select the color from the color palette.
4	Return	To go back to the Background menu.

## ◆ Page Operation Menu

The Page operation menu will appear when the icon [ x / y ] in the toolbar is tapped.

Up to 5 pages are displayed as thumbnails at the same time. If there are more than 6 pages, you can switch the display by scrolling the menu with a swipe action.

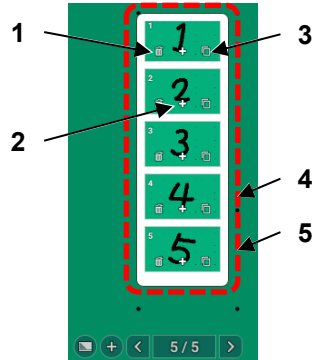

No.	Name	Function
1	Delete page	To delete the selected page.
2	Add page	To add a new page to the next page of the selected page. The same background as the selected page will be applied to the added page.
3	Copy page	To copy the selected page and add to the next page of the selected page. The same background as the selected page will be applied to the copied page.
4	Change page order	To change the page order by drag and drop action.
5	Move to selected page	To go back to the whiteboard and move to the selected page by tapping the thumbnail.

## ◆ Add Page Menu

The Add page menu will appear when the Page forward icon in the last page is tapped.

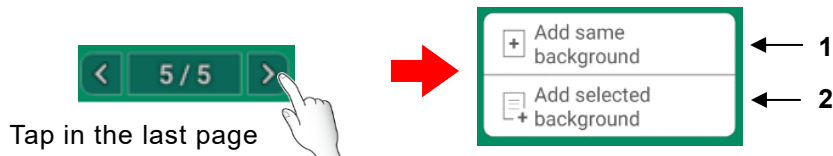



No.	Name	Function
1	Add page with same background	To add a new page with the same background as the last page.
2	Add page with different background	To add a new page with the background selected in the Background menu.

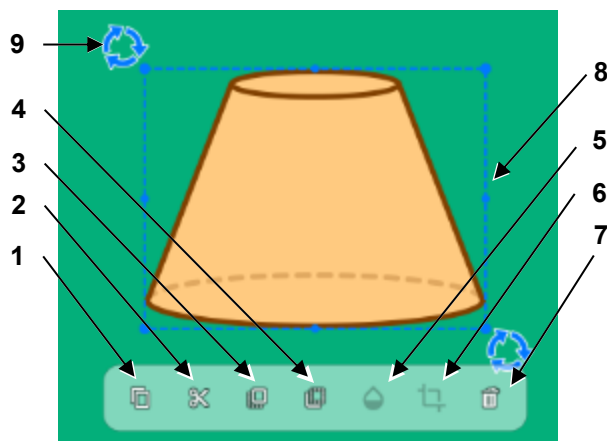

## ◆ Functions Available When Selecting an Object

Tap the Select icon in the toolbar to select an object (shape, image, and video).



No.	Name	Function
1	Copy	To copy the selected object. The Paste icon  will appear when any part of the screen other than the object is tapped. Tap the Paste icon to paste the copied object.
2	Cut	To cut the selected object. The Paste icon  will appear when any part of the screen other than the object is tapped. Tap the Paste icon to paste the cut object.
3	Bring to front	To bring the selected object to the front.
4	Bring to back	To bring the selected object to the back.
5	Transparent	To make the selected object transparent. (only for images and materials) When this icon is tapped, a slider will appear to adjust the level of transparency.
6	Trim	To trim the selected object. (only for images and materials) When this icon is tapped, a frame will appear around the object to adjust the trimming area.
7	Delete	To delete the selected object.
8	Change size	To change the size of the selected object by dragging the frame. Shapes such as circles and stars will be scaled up or down while maintaining a 1: 1 aspect ratio.
9	Rotate	To rotate the selected object by dragging the Rotate icon.
-	Move	To move the object by dragging.
-	Free transform	To freely change the size and rotate by pinching two points.

## ■ Video Object Operations

Tap the Operation icon in the toolbar to operate a video object.

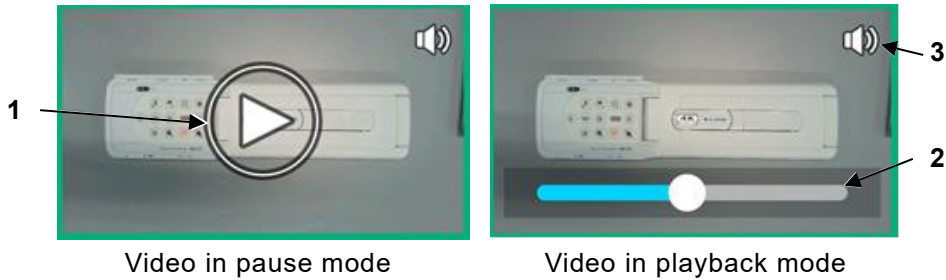

Video in pause mode

Video in playback mode

No.	Name	Function
1	Playback / Pause	To play the video. The Playback mode and the Pause mode can be switched by tapping on the video object. During playback, the video will be stretched to fit the object size.
2	Seek bar	To change the playback position. The seek bar will disappear over time. Tap the screen to display it again.
3	Volume bar	To display the volume bar by tapping on the video object. The volume decreases as the bar is dragged to the left.

## ◆ Menu Operations

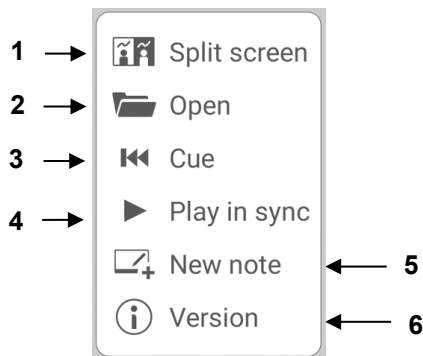

No.	Name	Function
1	Split screen	To enter the Split screen mode. (⇒P.35)
2	Open	To open files. All pages will be loaded for pdf files with multiple pages and note format files. Image data files will be loaded as the background image file.
3	Cue	To play the video from the beginning. This function is not available when there is no video.
4	Play in sync	To play two videos at the same time. This function is not available when there is no video.
5	New note	To create a new note.
6	Version	To display version information and license information. Scroll down to read all information.



## ◆ Split Screen Mode

In the Split screen mode, two or three users can draw or delete lines at the same time.

- 1 Tap the Split screen icon in the menu.
- 2 A dialog box will appear. Select “Two split screen” or “Three split screen” and tap “OK”.

The screen will be split as selected.

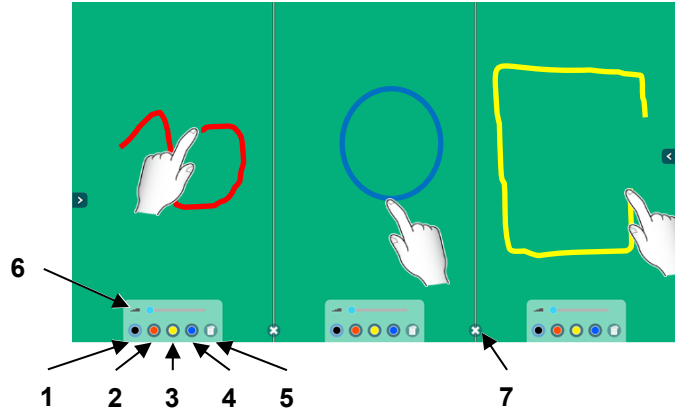

No.	Name	Function
1	Black pen	To select Black pen.
2	Red pen	To select Red pen.
3	Yellow pen	To select Yellow pen.
4	Blue pen	To select Blue pen.
5	Delete screen	To delete all drawings on your split screen only.
6	Pen thickness	To adjust the thickness of the line.
7	Exit	To end the Split screen mode. All drawings made will be put together before ending the Split screen mode.

---

**Note** The drawings can be deleted using the palm of your hand or the supplied Eraser. Multiple users can perform the deleting operation at the same time.

---

## ◆ Saving Images

Tap the Save icon to save the drawing as an image in either PNG format, PDF format, or Note format.

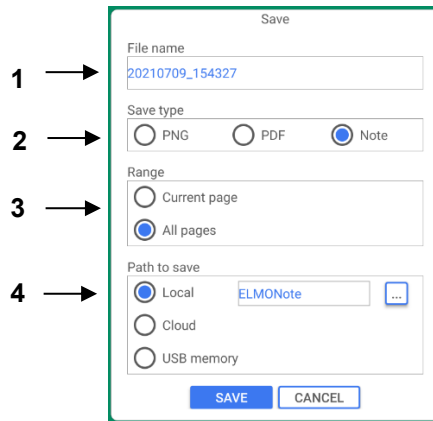

No.	Name	Function
1	File name	To enter the file name to save.
2	Save type	To select the save format.
3	Range	To select the page to save.
4	Path to save	To select the location to save the file. Tap <input type="button" value="..."/> to select the local save location.

### Note

- The following 9 characters cannot be used for the saved image data. 「 < > : \* ? " / ¥ | 」
- When all pages are saved in PNG format, page numbers such as "\_001" and "\_002" will be added to the file name in sequence.
- The saving process may fail when saving a large amount of data that exceeds 10 pages in PDF format. If ELMO Note is closed unexpectedly, restore the data and save it again, or save it in another format.
- When USB flash drive is selected as the save destination, the image data will be saved in the root folder of the USB flash drive (located directly under the USB flash drive). If the USB flash drive is not inserted, the image data will be saved in the local storage.
- Writing to the USB flash drive may still be in progress even after the image data is saved. In order to prevent data corruption, wait about 10 seconds before removing the USB flash drive.
- The background will be saved in association with the object. If it is not possible to save the background, change the position of the object.

#### <About using Cloud>

- Cloud cannot be used as the storage in the initial version. It will be supported in future version upgrades.
- For Cloud, you can select "Google Drive" or "One Drive". You need to have your account to use them. (⇒P.58)
- You can also upload the file to Cloud from the File Manager. After saving the file in the local storage, start the File Manager from the list of apps to upload to Cloud. (⇒P.60)

## 3.2 Using Overlay Function

You can draw on the entire surface of the external input video or browser screen in the same way as ELMO Note.

### ◆ Startup

Tap the Overlay icon in the list of apps or the side menu bar.



### ◆ Toolbar Description

When toolbar is displayed



When toolbar is hidden (in the Operation mode)



No.	Name	Function
1	Operation functions	Same functions as ELMO Note (whiteboard) are available. Refer to page P.27 for details.
2	Screenshot	To capture and save the screen image. The captured screen image will be saved in the Camera Roll folder in png format.
3	Hide toolbar	To hide the toolbar. Tap this icon again to show the toolbar. The product is in the Operation mode when the toolbar is hidden.
4	Exit	To end the Overlay app.

#### Note

- To temporarily end the overlay function and operate the product, put the Overlay app in the Operation mode.  
(The toolbar will disappear and a finger icon will appear.)

#### Caution

- If you use the enlarge function in the Overlay app, the captured screen will be enlarged. Therefore, on-screen operations such as video playback, camera image output, and screen mirroring will temporarily stop. The magnification ratio will be from 100% to 2400%.
- In the Operation mode, all drawings will be deleted. The deleted drawings can be displayed again by tapping "Return".
- When switching from the Enlarge mode to the Operation mode, the drawings will be deleted. The deleted drawings cannot be displayed again even by tapping "Return".

## 3.3 Using Camera Roll Function

You can display saved images and videos in a list to compare them or paste to ELMO Note.

### ◆ Startup

Tap the Camera Roll icon in the list of apps.



### ◆ Screen Description

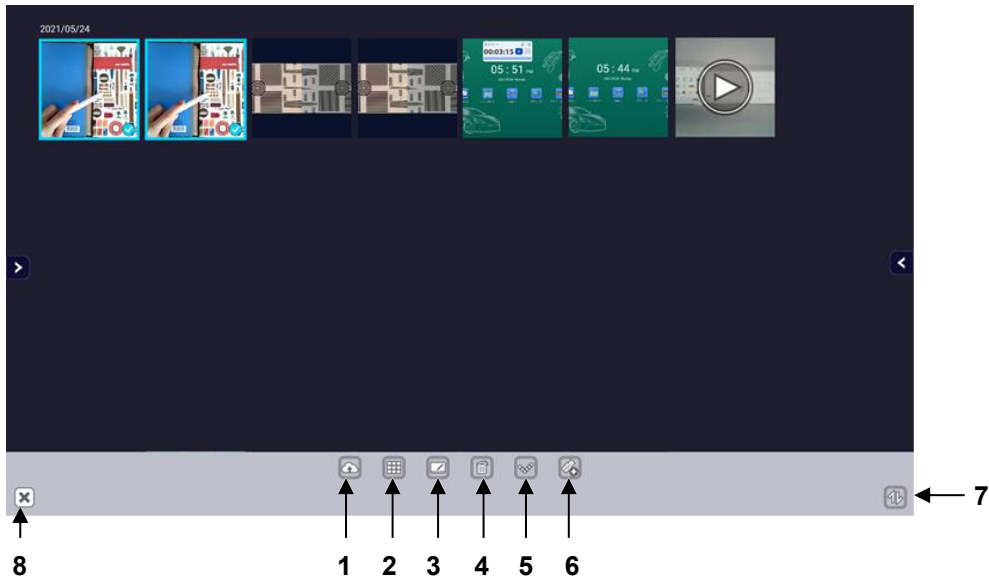

No.	Name	Function
1	Cloud	To upload images and videos to Cloud. This function is not available in the initial version. It will be supported in future version upgrades.
2	Compare	To compare the selected images and videos. (⇒P.39)
3	ELMO Note	To paste the selected images and videos to ELMO Note (whiteboard)
4	Delete	To delete the selected images and videos.
5	Deselect	To deselect all the selected items.
6	Load from USB	To load images and videos from a USB flash drive to display in the Camera Roll.
7	Sort in ascending / descending order	To sort files in ascending / descending order of date and time.
8	Exit	To end the Camera Roll app.

#### Note

- The following images and videos can be loaded from a USB flash drive:  
Image: jpeg / jpg / gif / bmp, Video: mp4 / mov  
Some files may not be viewed or played.
- For Cloud, you can select "Google Drive" or "One Drive". You need to have your account to use them. (⇒P.58)
- You can also upload the file to Cloud from the File Manager. Start the File Manager from the list of apps to upload to Cloud. (⇒P.60)

## ◆ Comparing Images and Videos

### 1 Select images and videos to compare and tap the Compare icon.

Select 2 to 9 images and videos in total.

If you want to include videos, select no more than two videos.

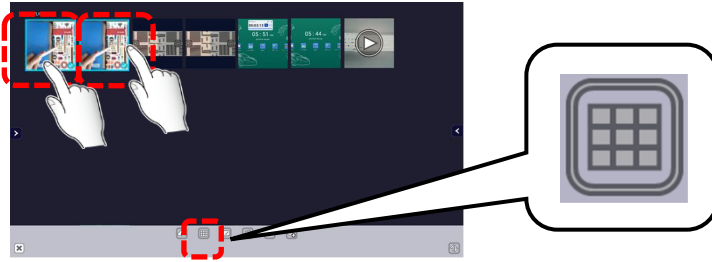

### 2 The selected images and videos will be displayed side by side.

Depending on the number of images and videos selected, the screen will be split in 2, 4, 6, or 9 sections.

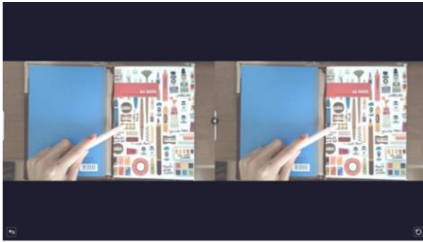

### 3 Drag the handle between the images.

The size of the images will be enlarged or reduced according to the position of the handle. The size can be initialized with the Return icon at the bottom right of the screen.

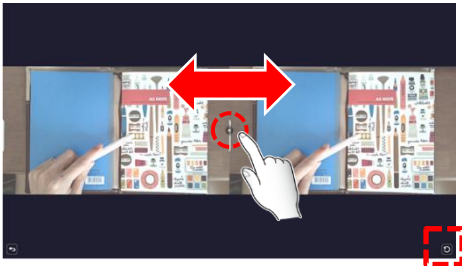

## ◆ Pasting to ELMO Note (whiteboard)

### 1 Select images and videos and tap the ELMO Note icon.

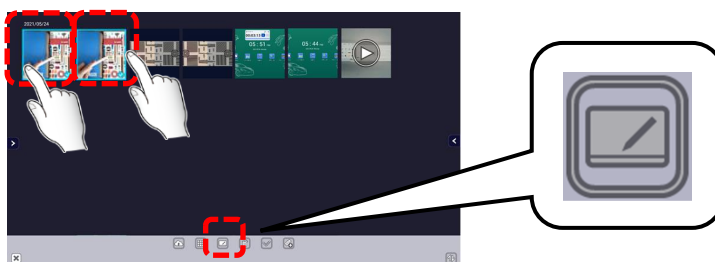

### 2 ELMO Note (whiteboard) will start and the selected images and videos will be pasted.

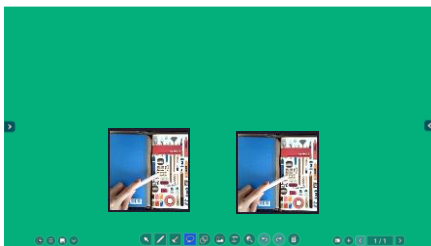

---

**Note** Up to 2 videos can be pasted to ELMO Note.  
Up to 9 images and videos can be pasted at the same time.

---

## 3.4 Using a USB Camera

You can operate or set a USB camera by connecting it to the USB3.0 port or USB2.0 port of the display monitor.

### ◆ Startup

Tap the ELMO Camera icon in the list of apps or the side menu bar.



### ◆ Screen Description

Tap the icon either at the bottom right of bottom left of the screen to display the menu bar.

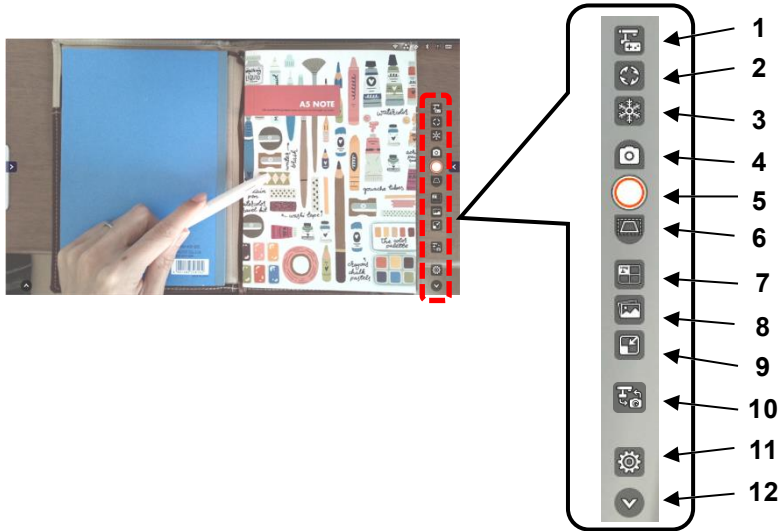

No.	Name	Function
1	Camera control	To adjust the level of zoom, brightness, and AF of the USB camera. You can operate ELMO document cameras.
2	Image rotation	To rotate the camera image.
3	Freeze	To pause the camera image. Tap this icon again to restart the camera image.
4	Recording settings	To configure the recording settings of the camera image. <ul style="list-style-type: none"> <li>●  Image: To capture the current screen image.</li> <li>●  Video: To record a video. Maximum recording time is 30 minutes. Audio cannot be recorded.</li> <li>●  Interval shooting: To record a series of still images automatically at set intervals.</li> </ul>
5	Record	To record the camera image. For video recording, tap this icon again to stop the recording. The recorded still images and videos will be saved in the CameraRoll folder.
6	Keystone correction	To perform keystone correction on the image. A rectangle will appear. Correct the deformation of the image by moving 4 points. The corrected image will be saved in the CameraRoll folder.
7	4 split screen	To divide the screen into 4 sections. The upper left section shows the live camera image. Each time you tap the Screenshot button, the captured image will appear in the order of upper right section, lower left section, and lower right section.
8	Camera Roll	To start the Camera Roll app. (⇒P.38)
9	Minimize	To display a minimized screen. The screen can be enlarged or reduced by pinch-in and pinch-out gesture.



No.	Name	Function
10	Camera select	To switch between the USB camera images. This icon appears when more than 2 USB cameras are connected.
11	Settings	To display the USB camera settings screen. (⇒P.41)
12	Hide menu bar	To hide the menu bar.

## ◆ USB Camera Settings Screen

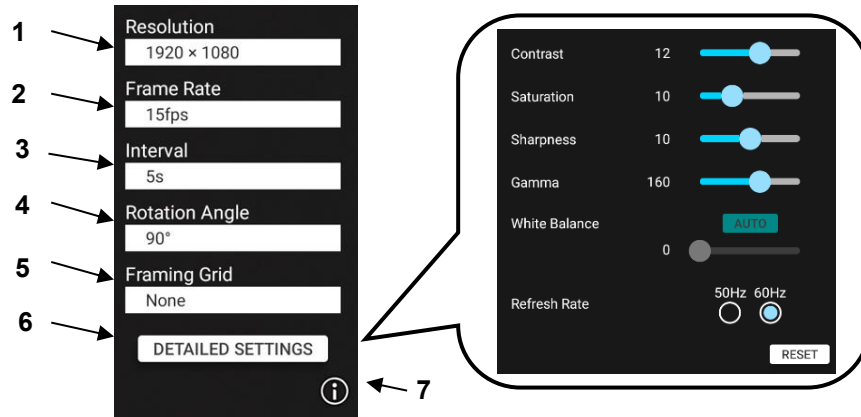

No.	Name	Function
1	Resolution	To set the resolution of the USB camera.
2	Frame Rate	To set the frame rate of the USB camera.
3	Interval	To set the interval for the interval shooting.
4	Rotation Angle	To set the rotation angle for the image rotation.
5	Framing Grid	To display grid-like frame lines on the screen.
6	DETAILED SETTINGS	To configure the detailed settings such as the contrast setting and saturation setting.
7	Information	To display the version information and license information of the USB Camera app.

### Caution

- The following products can be controlled with the Camera control function on the menu bar:  
L-12F, L-12W, L-12iD, MA-1, MO-2, MX-P3, MX-P, OX-1, PX-30E, etc.  
For details about models that support the Camera control function, contact the dealer from whom you purchased the product or the nearest ELMO sales office.
- The MX-P2 does not support USB3.0.  
When using the MX-P2, connect it to the USB 2.0 port on the side of the display monitor. When connecting to the USB3.0 port, use a USB 2.0 cable.  
The zoom and brightness of the MX-2 cannot be controlled by the Camera control function on the menu bar. Use the buttons of the MX-P2 to control the zoom and brightness of the MX-P2.
- Depending on the USB camera, it may not be possible to output images.
- To record when using the Overlay app (⇒P.37), use the Screenshot icon on the overlay toolbar or the Screenshot button on the front of the display monitor.
- In rare cases, the ELMO Camera app may freeze when the USB camera is disconnected. In that case, restart the app.

## 3.5 Viewing Web Page (E Browser)

You can view web pages with E Browser.

An Internet connection is needed to view web pages.

### ◆ Startup

Tap the E Browser icon in the list of apps or the side menu bar.



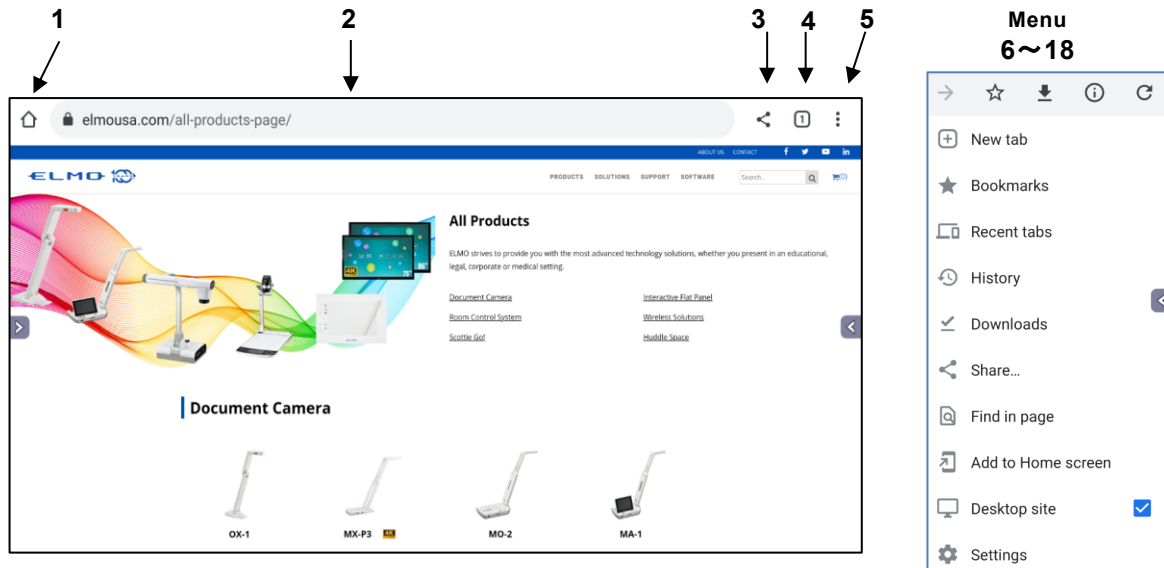

### ◆ Screen Description



No.	Name	Icon	Function
1	Home		To display the Home screen of the browser.
2	Address bar		To enter URL by tapping the screen.
3	Share URL		To share the URL of the page being viewed.
4	List of tabs		To display a list of open tabs.
5	Menu		To display the menu.

## <Menu>

No.	Name	Function
1	Back 	To go back to the previous page.
2	Next 	To go to the next page.
3	Refresh 	To update the page being viewed.
4	New tab	To open a new tab.
5	Bookmarks	To display, edit or delete a list of bookmarks.
6	Recent tabs	To display or delete the history of tabs.
7	History	To display or delete the history of browsed pages.
8	Downloads	To display or delete a list of downloaded files.
9	Add to Home screen	To add shortcuts or bookmarks to the Home screen.
10	Share	To share the URL of the page being viewed.
11	Find in page	To search specific text on the page being viewed.
12	Desktop site	To switch between the Desktop mode and Mobile mode.
13	Settings	To configure the operational settings of the browser.

## ◆ Popup Display Settings

When playing video content, a notification pop-up may appear at the bottom right of the screen.

To hide this pop-up, turn off the setting “Show notifications”.

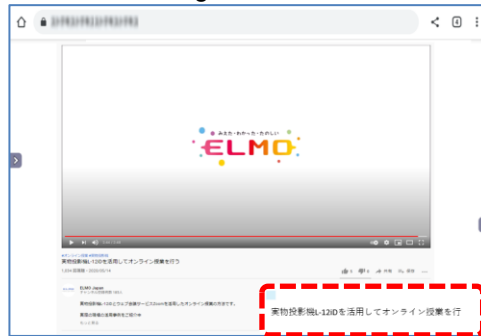

Notification popup

- 1 Tap “Settings” in the E Browser menu.
- 2 Tap “Notifications”.
- 3 Turn off the setting “Show notifications”.

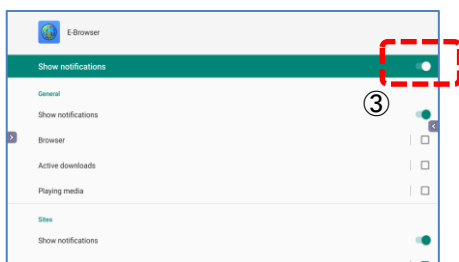
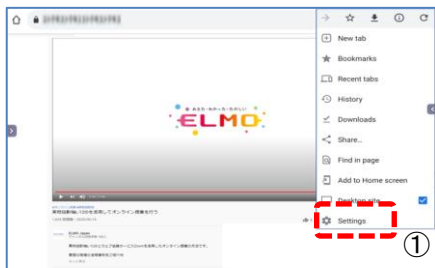

Turn off this setting.  
The notification popup will not appear.

## 3.6 Using ELMO Timer Function

The ELMO timer has a timer function and a stopwatch function.

- With the timer function, multiple timers and tasks can be set.
- With the stopwatch function, a lap recording is possible.

### ◆ Startup

Tap the Timer icon in the list of apps.



### ◆ Basic Operations (Timer)

**1** Tap the icon “ + “ in the Timer List screen to create a new timer.

If the timer has not been created yet and there is no timer list, start from step 2.

**2** The Timer settings screen will appear.

You can set the time by entering the number directly by tapping the screen.

You can also set the time by moving icons (H (hours), M (minutes), and S (seconds)) on the circle slider.

**3** Save the timer setting.

The screen will return to the Timer List screen.

**4** Tap  to start the timer.

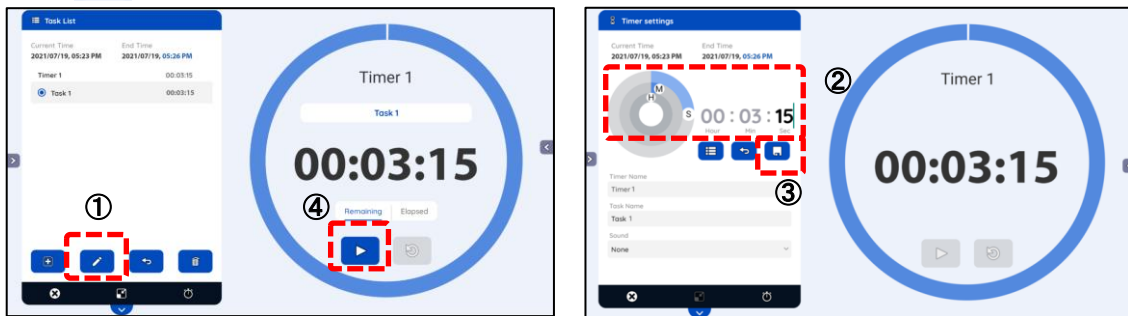

### ◆ Basic Operations (Stopwatch)

**1** Select “Stopwatch” from the Timer List screen.

**2** Tap the Start button on the Stopwatch screen.

The stopwatch will start.



## ◆ Creating Tasks using Timer

Perform the steps 1 to 3 described in "Basic Operation (Timer)".

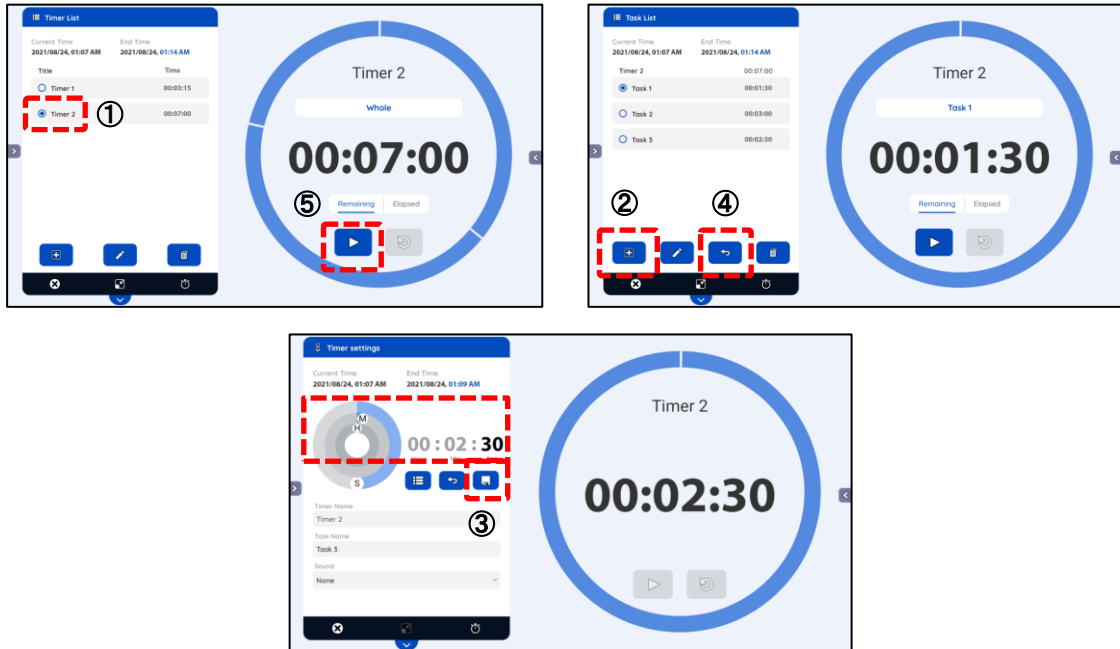

- 1 Tap the title of the created timer in the Timer List screen.
- 2 Tap the icon “ + “ in the Task List screen to create a new task.
- 3 In the Timer settings screen, set the time for the task and save the timer setting.
- 4 Tap the Return icon in the Task List screen to go back to the Timer List screen.
- 5 Tap  to start the timer.





### Note

- To select the timer in step ①, tap the text part of the title. (For example, tap “Timer 2” in the above figure).
- You can also start the timer from the Task List screen. In this case, the total time cannot be displayed.

## ■ Maximizing or Minimizing the Screen

Maximizing the screen : Press  to maximize the screen. Press  to return the screen to normal size.

Minimizing the screen : Press  to minimize the screen. Press  to return the screen to normal size.

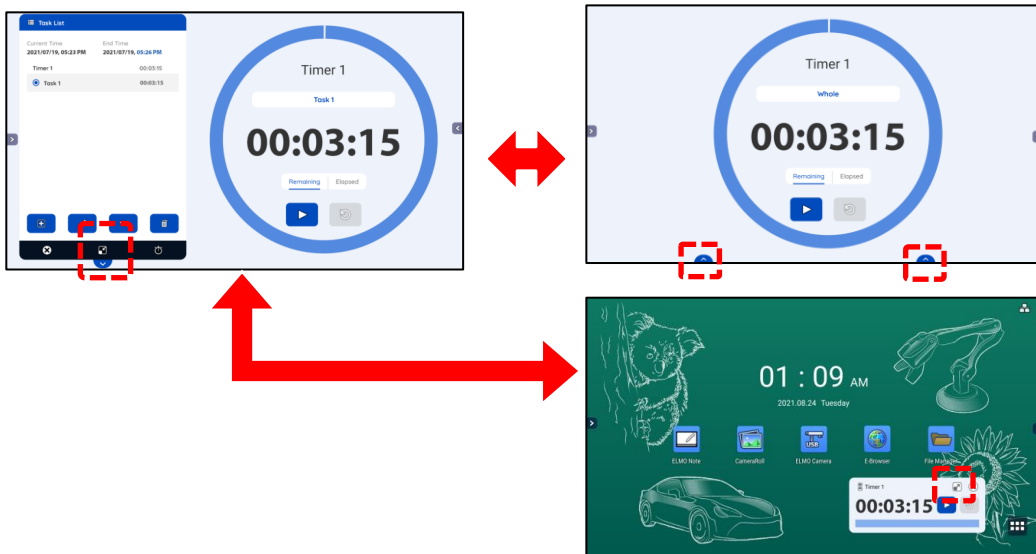

## ◆ Timer List Screen

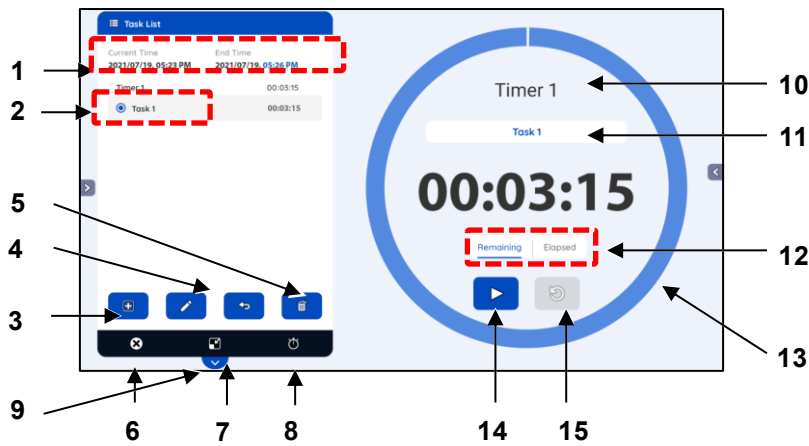

No.	Name	Function
1	Current Time / End Time	To display the start time (current time) and the end time for the timer.
2	Timer List	To display a list of created timers. Tap the  mark at the left of the title to select. The Task List screen will appear when the title is tapped. (⇒P.46)
3	Create new timer	To create a new timer. The Timer settings screen will appear. (⇒P.49)
4	Change title	To change the title of the selected timer.
5	Delete timer	To delete the selected timer.
6	Exit	To end the ELMO timer app.
7	Minimize screen	To minimize the timer screen. (⇒P.50)
8	Stopwatch	To display the Stopwatch screen. (⇒P.50)
9	Maximize screen	To maximize the timer screen.
10	Display title	To display the title of the selected timer.
11	Total time / Task time	To switch between Total time display and Task time display.
12	Remaining time / Elapsed time	To switch between Remaining time display and Elapsed time display.
13	Pie chart	To display the elapsed time as a pie chart.
14	Start / Stop	To start the timer. Tap this button again to stop the timer.
15	Reset	To reset the timer to the start time.



## ◆ Task List Screen

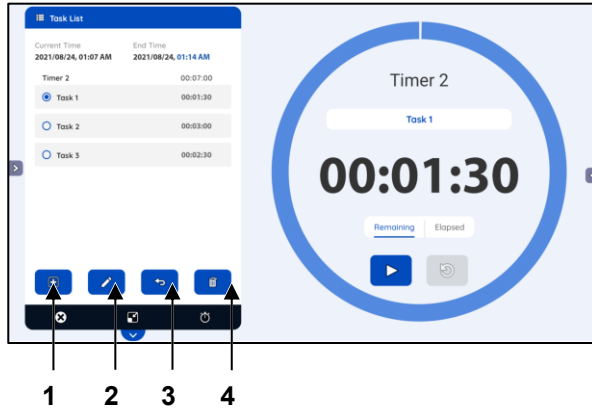

No.	Name	Function
1	Create new task	To create a new task. The Timer settings screen will appear.
2	Edit task	To edit the selected task. The Timer settings screen will appear.
3	Return	To go back to the Timer List screen.
4	Delete task	To delete the selected task.

## ◆ Timer Settings Screen

You can set the time by entering the number directly by tapping the screen. You can also set the time by moving icons (H (hours), M (minutes), and S (seconds)) on the circle slider.

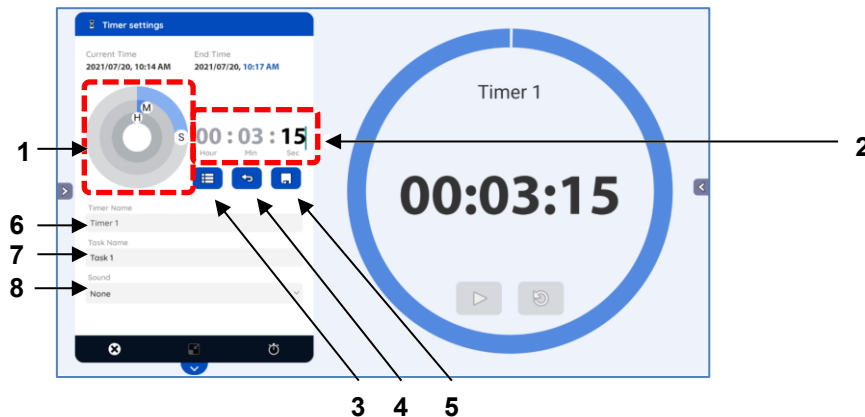

No.	Name	Function
1	Set Time (Circle slider)	To set the time by moving icons (H (hours), M (minutes), and S (seconds)) on the circle slider.
2	Set Time (Number)	To set the time by entering the number directly by tapping the screen.
3	Timer screen	To go back to the Timer List screen.
4	Return	To go back to the Task List screen. The configured settings will not be saved.
5	Save	To go back to the Task List screen after saving the settings.
6	Timer Name	To display the timer name. The timer name cannot be configured here.
7	Task Name	To set the task name.
8	Sound	To set the sound to be heard when the task is ended.

## ◆ Minimizing the Screen

If the screen is minimized, the Timer will be displayed in reduced size.

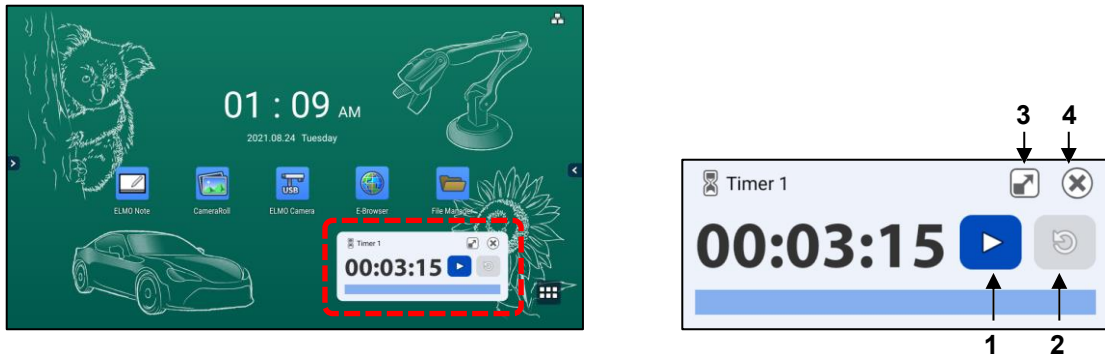

No.	Name	Function
1	Start / Stop	To start the timer. Tap this icon again to stop the timer.
2	Reset	To reset the timer to the start time.
3	Maximize screen	To maximize the screen.
4	Exit	To end the ELMO timer app.

## ◆ Stopwatch Screen

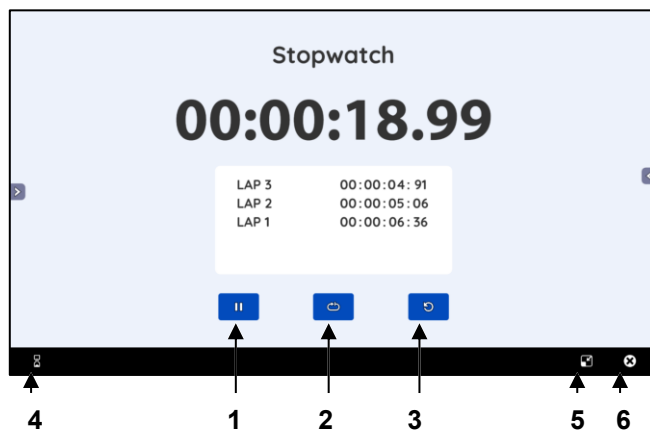

No.	Name	Function
1	Start / Stop	To start the stopwatch. Tap this icon again to stop the stopwatch.
2	Lap time	To get a lap time every time you tap.
3	Reset	To reset the stopwatch to the start time.
4	Timer screen	To display the Timer List screen or Task List screen.
5	Minimize screen	To minimize the screen.
6	Exit	To end the ELMO timer app.

## 3.7 Using Wireless Casting Function (Transcreen)

You can do mirroring of the screen of a device such as a computer, tablet, and smartphone to the display monitor of the product.

### ◆ Preparation

Connect a device such as a tablet to the network and install the Transcreen app. For iOS (iPhone or iPad) and MacOS, mirroring is possible without installing the Transcreen app.

#### 1 Connect a device such as a tablet to the network.

Connect a device such as a tablet to the network by using the product as a hotspot (⇒P.74) or setup the device in the same network as the product with Wi-Fi.

#### 2 Install the Transcreen app on the device.

Access <https://transcreen.app/pc.php> to install the app on a device.

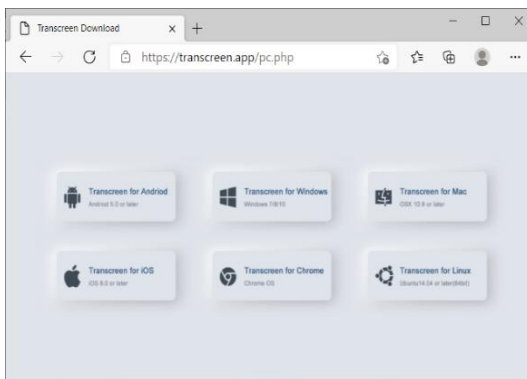

#### Note

- When installing the app on a Windows computer, use Microsoft Edge.
- If you are using a Chromebook, you can also install the Transcreen app from the chrome store (<https://chrome.google.com/webstore/>). Search "Transcreen" in the chrome store.

#### Caution

Only Class C IP addresses (192.0.0.0 --223.255.255.255) can be used for the wireless casting of the product.

## ◆ Using on Windows OS



- 1 Tap the Screen Mirror icon in the list of apps.
- 2 Start the Transcreen app installed on the Windows device.
- 3 Select the device name of the product and tap “Start Mirroring”.
- 4 The screen of the connected device will be displayed on the display monitor of the product.

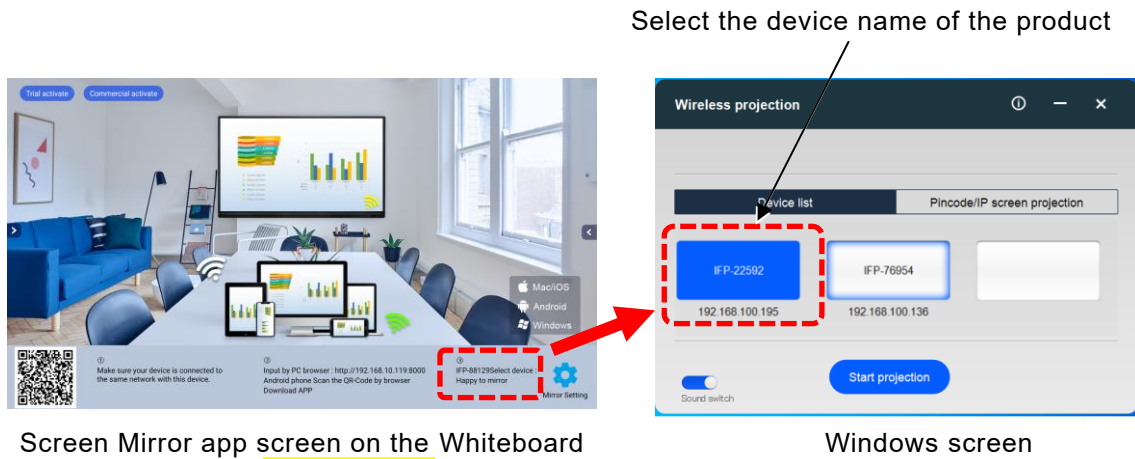

Screen Mirror app screen on the Whiteboard

Windows screen

### Note

- When installing the app on a Windows computer, use Microsoft Edge.
- You can also check the device name of the product from “Terminal information” in “Settings”. (⇒P.78)

## ◆ Using on iOS or MacOS



- 1 Tap the Screen Mirror icon in the list of apps.
- 2 Start Airplay (a screen mirroring app) installed on the iOS device or Mac OS device.
- 3 Select the device name of the product.
- 4 The screen of the connected device will be displayed on the display monitor of the product.

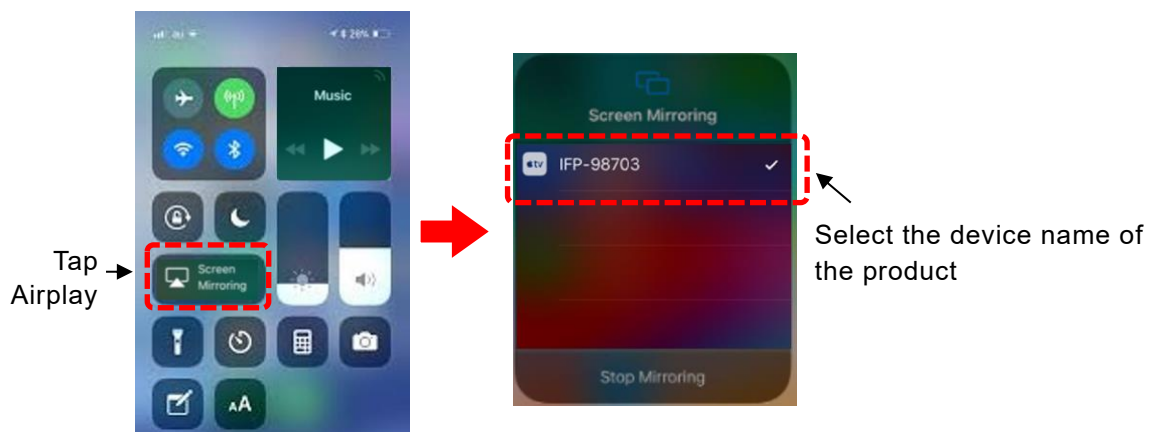

## ◆ Using on Chrome OS

- 1 Tap the Screen Mirror icon in the list of apps. 
- 2 Start the Transcreen app installed on the Chrome device.
- 3 Select the device name of the product and tap “Connect”.
- 4 Tap “Share Screen”.
- 5 Select the screen you want to display and tap “Share”.
- 6 The screen of the connected device will be displayed on the display monitor of the product.

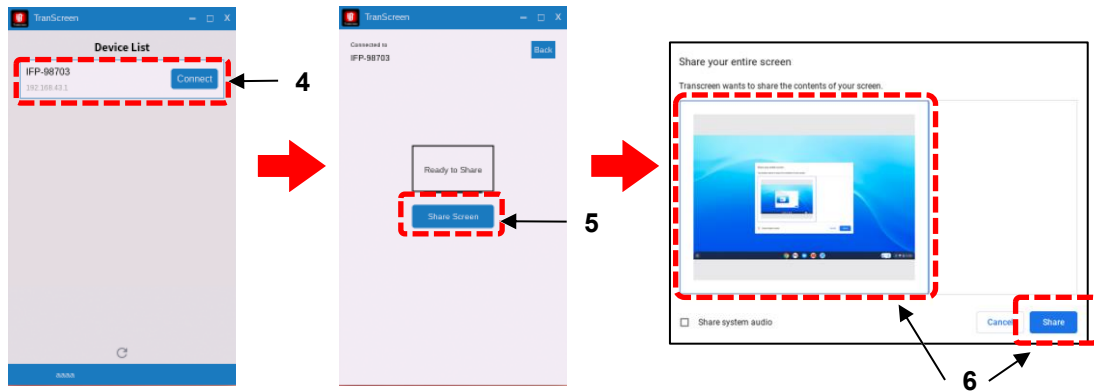

## ◆ Using on Android OS

- 1 Tap the Screen Mirror icon in the list of apps. 
- 2 Start the Transcreen app installed on the Android device.
- 3 Tap “Airplay” or “Mirror” on the app screen of the Android device.
- 4 The screen of the connected device will be displayed on the display monitor of the product.

### Note

For detailed settings of each device, refer to the instruction manual of the respective device.

## ◆ Mirroring Screen

You can switch between List display and Full screen display.



## 3.8 Using Anti-Virus Function (Avira Security)

You can do virus scanning of the internal memory of the product or perform a cleanup of the internal memory.

### ◆ Startup

Tap the Avira Security icon in the list of apps.



### ◆ Initial Startup

Make the initial settings according to the instructions on the screen.



① Tap "Accept"



② If you do not want to use the Dark Mode, tap

### ◆ Basic Operations

#### ■ Virus Scanning

Tap the "Dashboard" tab, and then tap "Smart Scan" to do virus scanning of the internal memory.

If a USB flash drive is connected, the data in the USB flash drive will also be scanned.

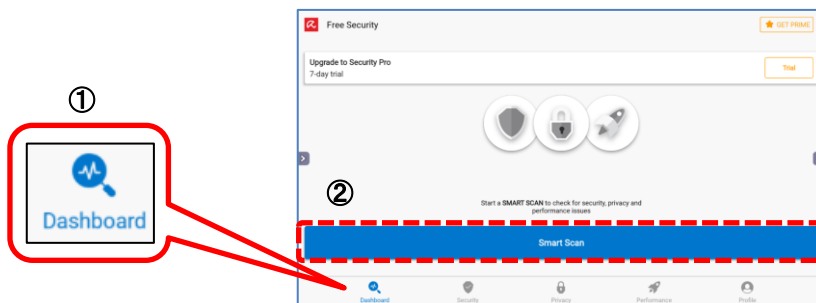

#### ■ Cleanup of the Internal Memory

Tap the "Performance" tab, and then tap "Optimizer" to perform a cleanup of the internal memory.

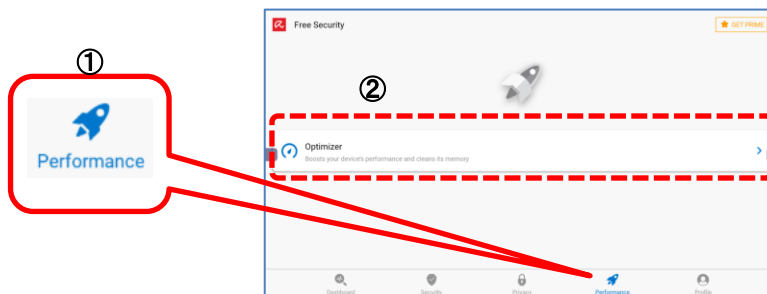

#### Note

Items marked with  are paid content. If you would like to use it, contact the dealer from whom you purchased the product or the nearest ELMO sales office.



## 3.9 Using ELMO Play

With ELMO Play, you can download apps from the ELMO portal site and add various useful functions to the product. (Paid content is also available.)

### ◆ Startup

Tap the ELMO Play icon in the list of apps.  
Select the app you want to install in ELMO Play and start the installation.



#### Note

Before installing an app from ELMO Play, go to “Apps” from “Settings” and turn on the setting of “Application Installation”. (⇒P.77)

After the installation is completed, turn off the above setting so that unnecessary apps are not installed.



Tap to scroll down

### ■ Some Examples of Apps Compatible with the Product

#### Perfect Piano

A smart piano simulator app designed for Android smartphones and tablets. You can learn the piano while enjoying the immersive music.

If you are connected to the network, you can load the score.

#### Programming Zemi

A learning app with child-friendly interface designed for children. Even children can easily learn programming.

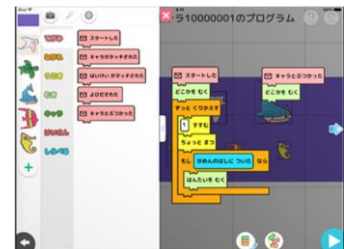

## 3.10 Using File Manger Function

You can manage files such as saved image files and video files.

You can also save files to a USB flash drive or read files from a USB flash drive.

### ◆ Startup

Tap the File Manager icon in the list of apps.



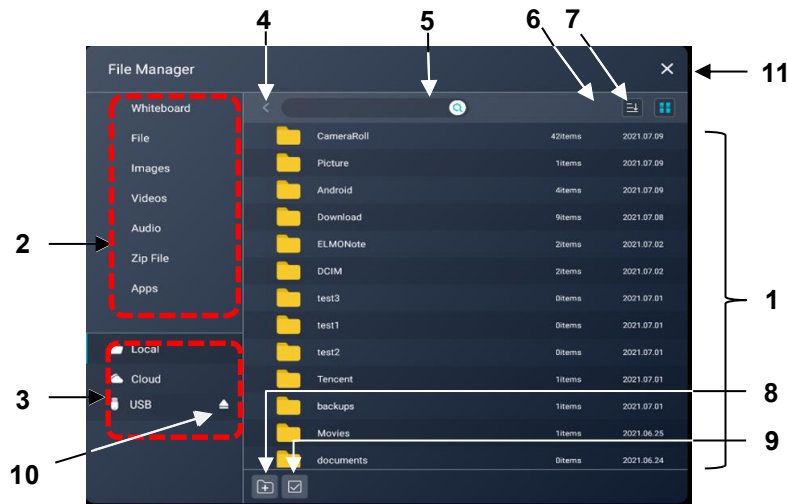

### ◆ Screen Description



No.	Name	Function
1	Manage file	To select files or folders by tapping. The File Manager app will enter the File edit mode (⇒P.57) when the File icon is pressed long.
2	File type	To display all file types of locally stored files by type. <ul style="list-style-type: none"> <li>● Whiteboard : iwb(S-Write)</li> <li>● File : txt·pptx(WPS file)·pdf</li> <li>● Video : mp4·mov</li> <li>● Audio : mp3</li> <li>● ZIP file : zip</li> <li>● App : apl</li> </ul> The xod file (ELMO Note) will be displayed in the category of "Whiteboard" in future version upgrades.
3	Select drive	To select the location to read files from. <ul style="list-style-type: none"> <li>● Local : Files stored in the product will be displayed.</li> <li>● Cloud : You can choose Google Drive or One Drive online. The files saved in the selected Cloud will be displayed.</li> <li>● USB : The name of the USB flash drive will appear when a USB flash drive is connected.</li> </ul>
4	Return to upper level	To return to the upper level.
5	Search	To search the file name.
6	Sort in ascending / descending order	To sort files and folders in ascending / descending order of name, date, and file size.
7	Display style	To switch the display style of folders and files between list display and icon display.
8	Create new folder	To create a new folder.



No.	Name	Function
9	File select mode	To select a file when  is displayed. The File Manager app will enter the File edit mode when this icon is tapped. (⇒P.57)
10	Remove USB flash drive	To remove the USB flash drive safely by tapping  .
11	Exit	To end the File Manager app

## ■ File Edit Mode

The File Manager app will enter the File edit mode when the File icon is pressed long.



No.	Name	Function
1	Create new folder	To create a new folder.
2	Select all/ Deselect all	To select or deselect all files.
3	Copy	To copy the selected file.
4	Cut	To cut the selected file.
5	Delete	To delete the selected file.
6	Change name	To change the name of the selected file.
7	Bluetooth	To send the selected file via Bluetooth.
8	Cloud	To upload the selected file to Cloud. Cloud account settings (⇒P.58)
9	Return	To go back to the File select mode.

## ■ File Paste Mode

The File Manager app will enter the File paste mode when the Copy icon or Cut icon is tapped.

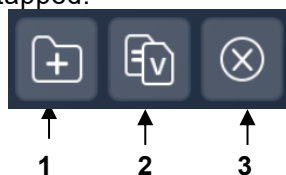

No.	Name	Function
1	Create new folder	To create a new folder.
2	Paste	To paste the copied or cut file.
3	Return	To go back to the File edit mode

### Note

You can start the File Manager app by tapping  that appears immediately after inserting a USB flash drive.



## ◆ Cloud Account Settings

If you are using Cloud for the first time or if you want to add a Cloud account to the product, use "Browser" to set the authentication.



- 1 Tap the Settings icon in the list of apps.
- 2 Tap "Application", and then tap "Application List".  
You need to enter the administrator password to display the apps. (⇒P.70)
- 3 Tap "Browser" in the list.

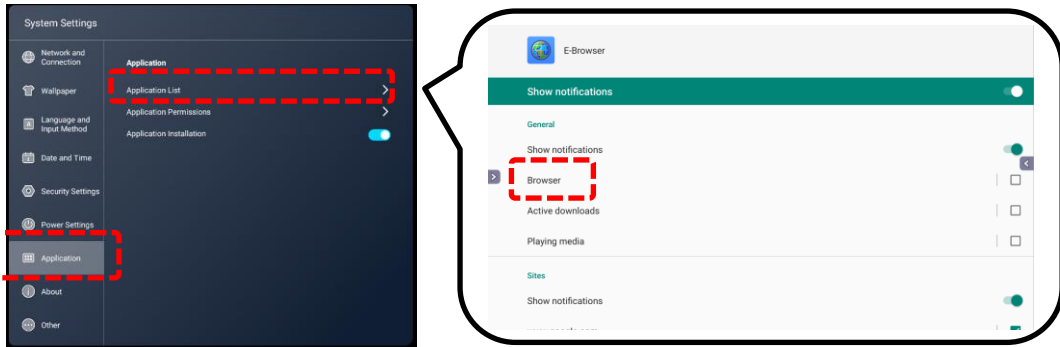

- 4 Tap "Advanced", then tap "Browser app".  
Tap "Browser app" again, then check the option "Browser".

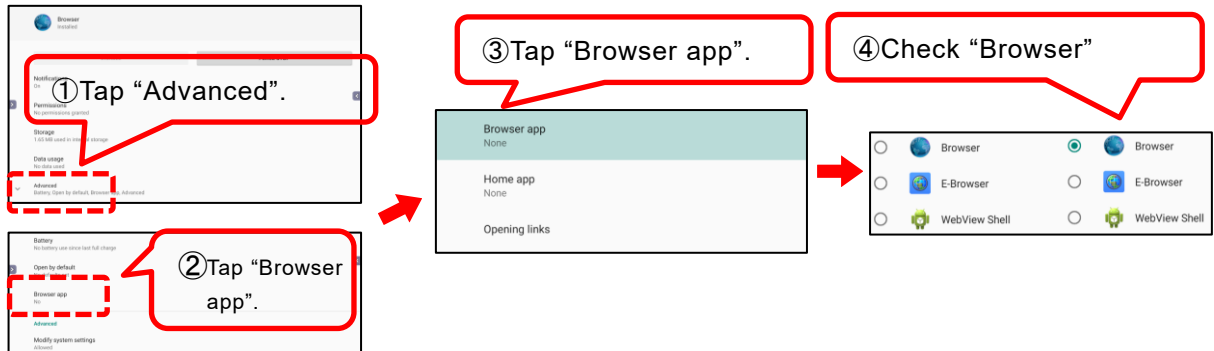

- 5 Go back to the Home screen and start the File Manager app.  
Select "Cloud".

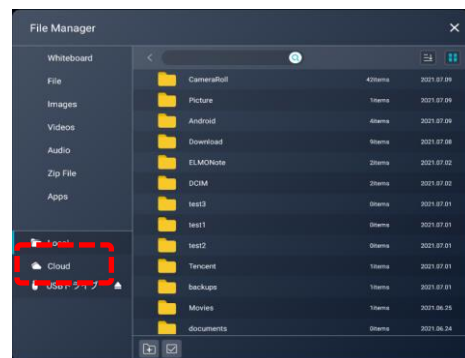

**6 Select “Google Drive” or “One Drive”, then login (authentication process) to it.**

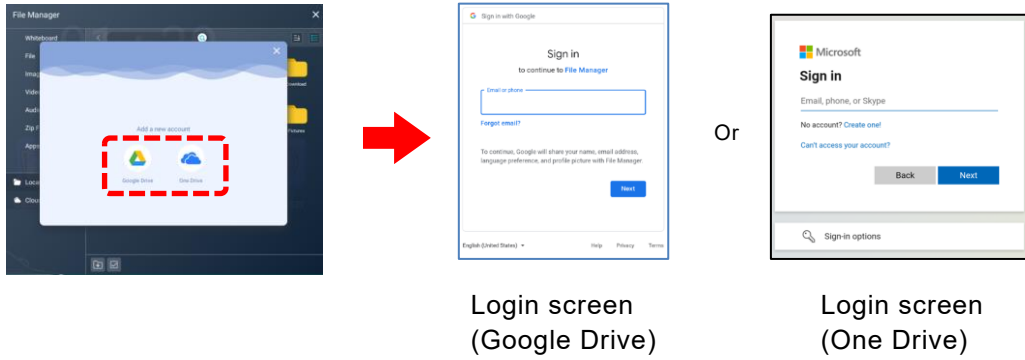

If the following dialog box appears when you login to your account, tap “Advanced” and then tap “Go to File Manager (unsafe)”.

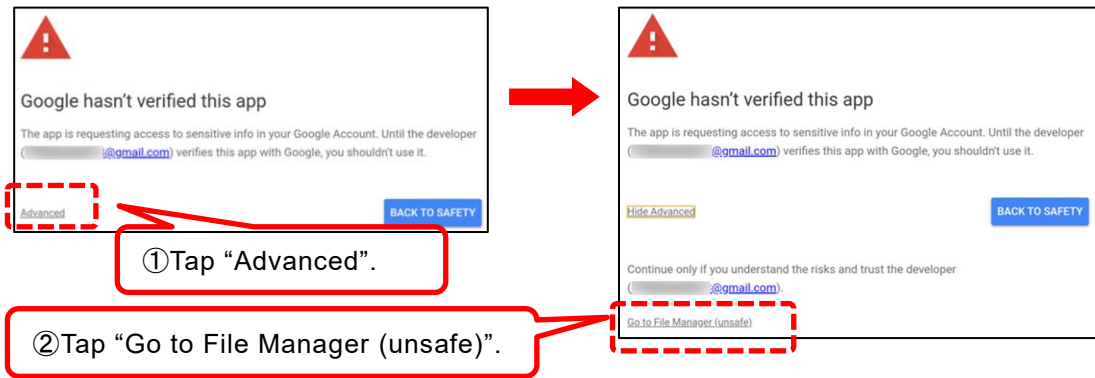

**7 Once you successfully login to your account, your account information will appear in the upper right corner.**

You can also check it from the Cloud screen after starting it from the File Manager.

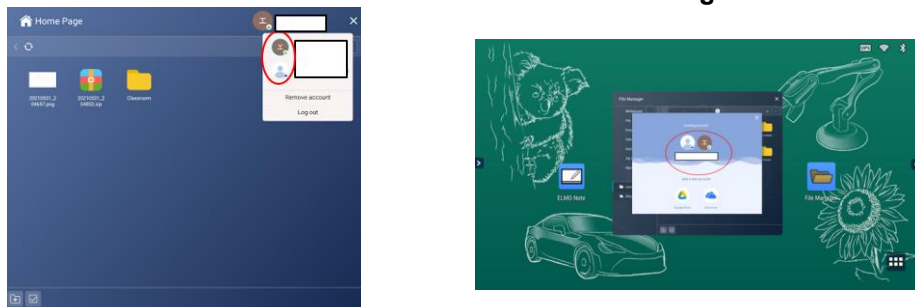

**8 After logging in to your account, follow the steps 1 to 3 to display the Browser app settings. Then check the option “E-Browser”.**

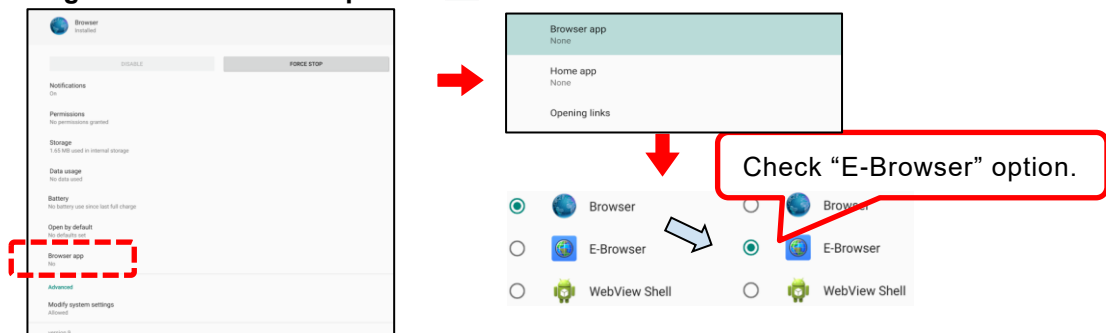

## ◆ Uploading Files to Cloud

- 1 Open the File Manager and select a file to upload to Cloud.
- 2 Tap the Cloud icon after selecting a file.
- 3 The Login screen will appear. Select the account and go to the cloud folder.
- 4 Tap “Confirm” to start the upload.

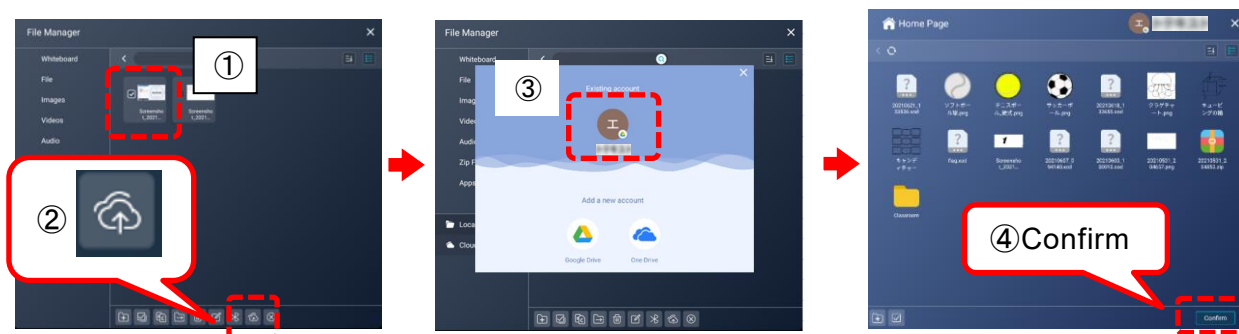

## 3.11 Using Utilities Function

You can use pre-installed utilities.



### ◆ Startup

Tap the Utilities icon in the side menu bar.

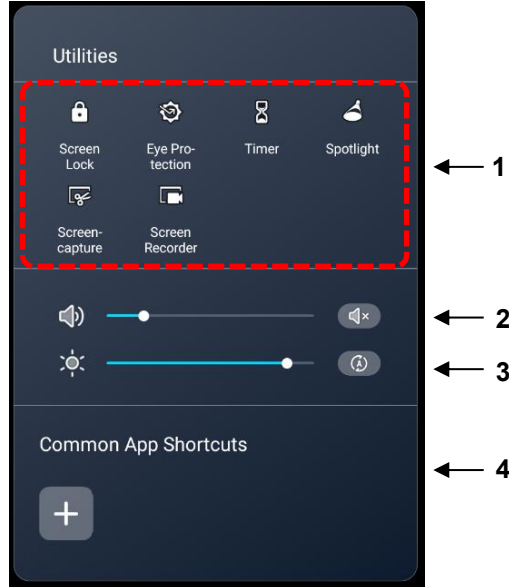

### ◆ Screen Description



No.	Name	Function
1	Utilities	To display a list of utilities. Tap each icon to start the respective utility.
2	Volume	To adjust the audio volume by moving the slider left or right. Tap  to mute the audio.
3	Brightness	To adjust the screen brightness by moving the slider left or right. Tap  to activate the auto brightness adjustment.
4	Common App Shortcuts	To add app shortcuts.

### ■ List of Utilities

Name	Function
Screen Lock	To lock the screen.
Eye Protection	To set the screen to the Eye protection mode by adjusting the screen brightness.
Timer	To start the Timer app.
Spotlight	To start the Spotlight app.
Screen capture	To capture a part of the screen.
Screen recorder	To record the screen and save it as a video.

## 4 Using with External Devices

You can display the live image being output from the document camera or computer on the display monitor, or play the audio of the product through an external speaker.

### 4.1 Connecting Devices

#### ◆ Displaying the Computer Screen (Video and Audio)

##### ■ Connecting via USB Type-C

If you connect the USB Type-C port of the display monitor and the USB Type-C port of the computer with a USB Type-C cable, the computer screen will appear on the display monitor and the computer audio will be played through the display monitor. Without connecting to the TOUCH-USB port, you can operate the computer by touching the screen of the display monitor.

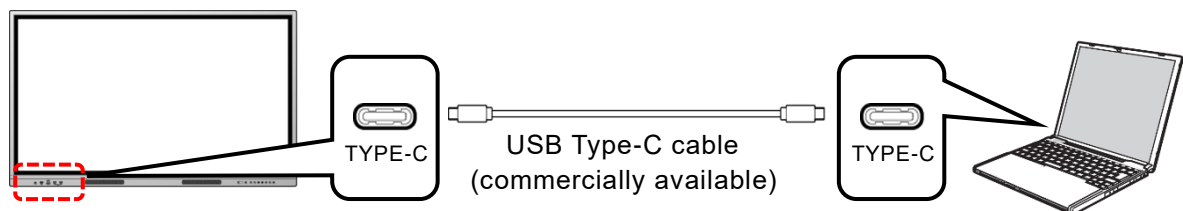

##### ■ Connecting via HDMI (Use the ports on the front)

If you connect the HDMI in port on the front of the display monitor and the HDMI out port of the computer with the supplied HDMI cable, the computer screen will appear on the display monitor and the computer audio will be played through the display monitor.

If you connect the TOUCH-USB port on the front of the display monitor and the USB Type-A port of the computer with the supplied USB cable, you can operate the computer by touching the screen of the display monitor.

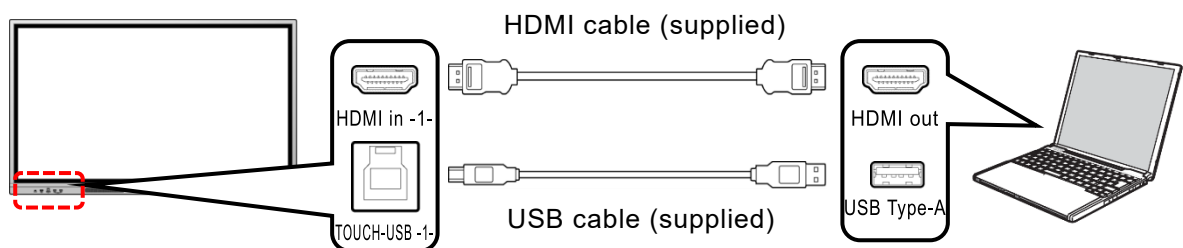

## ■ Connecting via HDMI (Use the ports on the side)

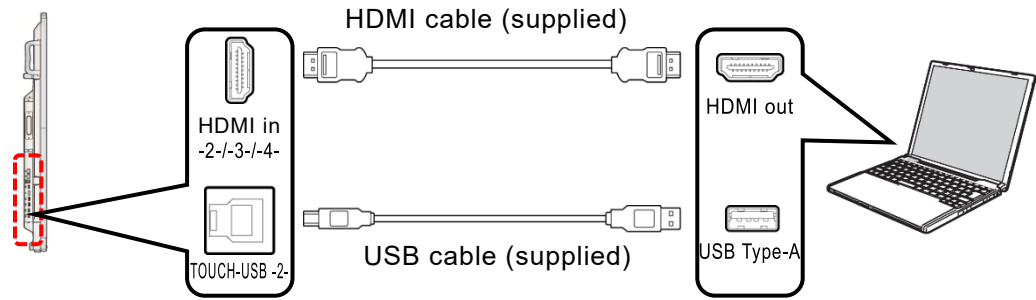

### Note

- Depending on the OS of the computer, you may not be able to operate the computer even if you touch the display monitor connected to the computer via USB Type-C. In that case, connect the computer and the display monitor via HDMI and TOUCH-USB.
- The USB Type-C cable and HDMI cable can send both video data and audio data. There is no need to connect a separate audio cable.
- When using the TOUCH-USB port on the front of the display monitor, use the HDMI in port on the front. When using the TOUCH-USB port on the side, use the HDMI in port on the side. If you confuse the front and side ports, you will not be able to operate the computer with touch operation.
- When using the Display Port in port on the side, use the TOUCH-USB port on the side.
- When using an HDMI cable other than the one supplied, use an HDMI cable that supports HDMI 2.0.

## ■ Connecting with VGA cable and Audio cable

If you connect the VGA in port on the bottom of the display monitor and the VGA out port of the computer with a VGA cable, the computer screen will appear on the display monitor.

If you connect the Audio in port on the bottom of the display monitor and the Audio out port of the computer with a stereo mini audio cable, the computer audio will be played through the display monitor.

If you connect the TOUCH-USB port on the side of the display monitor and the USB Type-A port of the computer with the supplied USB cable, you can operate the computer by touching the screen of the display monitor.

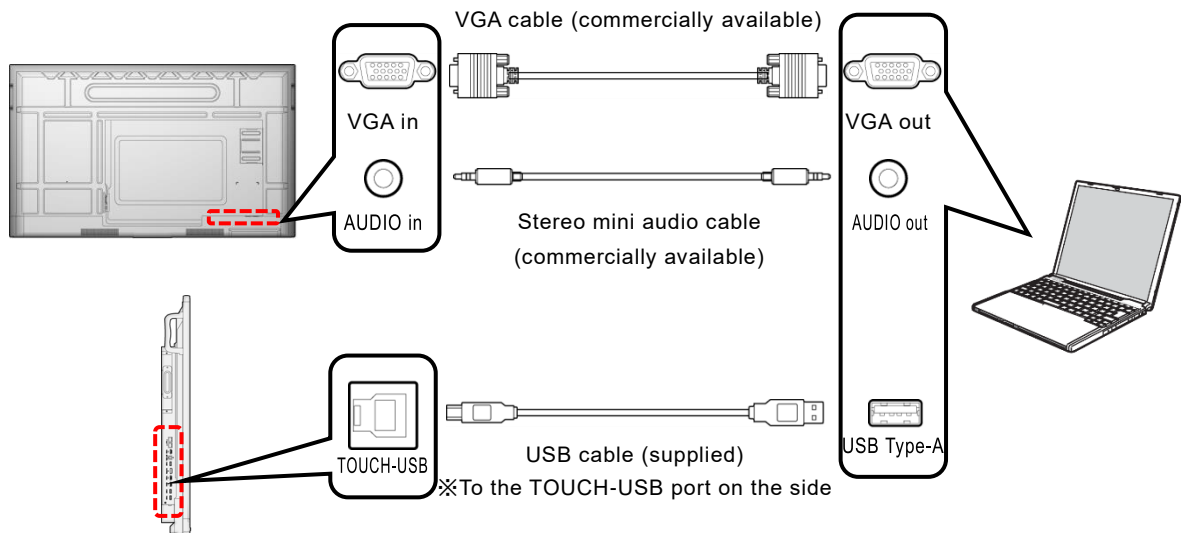

### Note

Use a computer with an OS that is still supported. The computer's specifications must meet the minimum system requirements for that OS.



## ◆ Controlling the Product from a Computer (Serial Control)

### ■ Controlling via RS-232C Commands

By connecting the RS-232C port on the bottom of the display monitor to the RS-232C port of the computer, you can control the functions of the product from the computer.

Note that not all functions can be controlled.

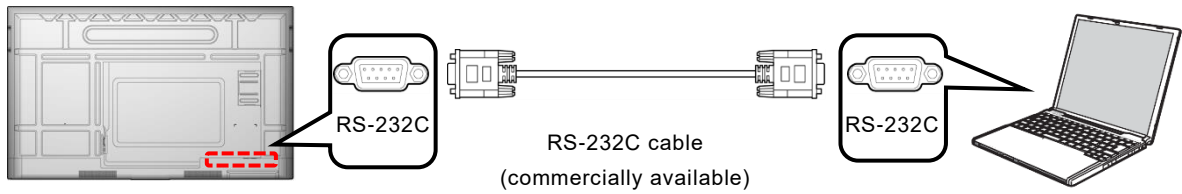

### ■ Controlling via LAN

By connecting the LAN port on the side of the display monitor to the LAN port of the computer with a LAN cable, you can control the functions of the product from the computer.

Note that not all functions can be controlled.

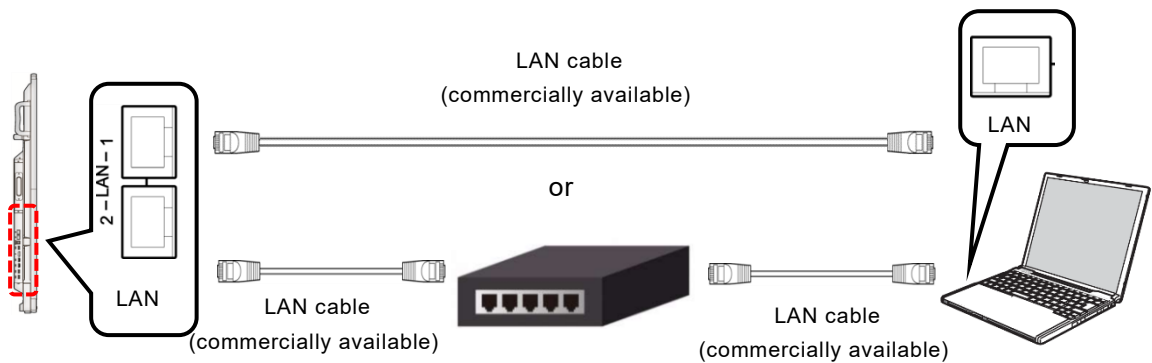

---

**Note**

- For information about commands used for RS-232C and LAN control, contact the dealer from whom you purchased the product or the nearest ELMO sales office.
-

## ◆ Displaying the Screen of the Connected Device (Video and Audio)

### ■ Connecting via HDMI

If you connect the HDMI in port on the front or side of the display monitor and the HDMI out port of the device with the supplied HDMI cable, the image being output from the device will appear on the display monitor and the audio will be played through the display monitor.

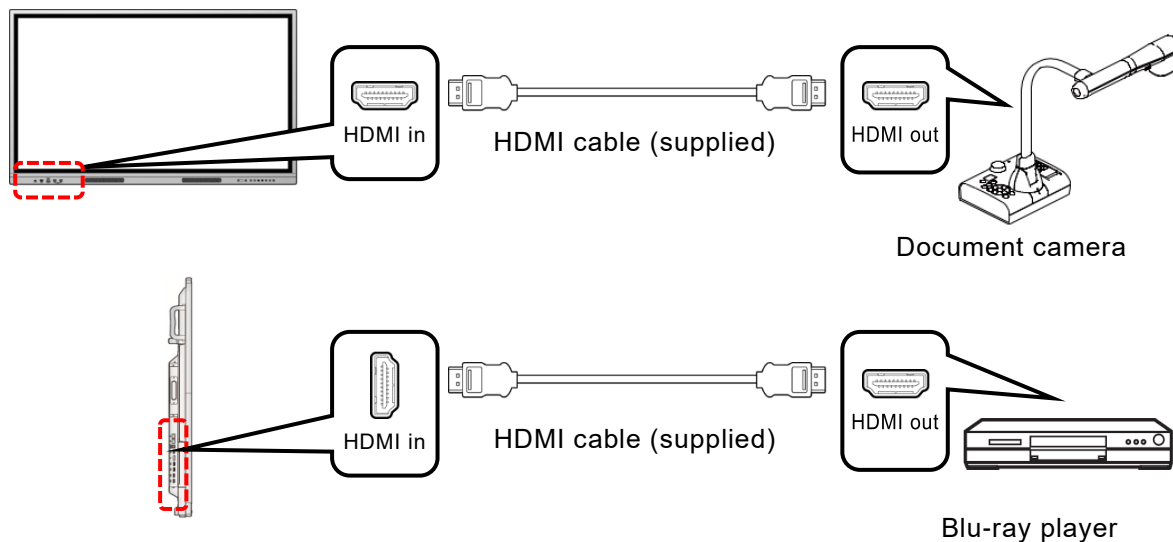

#### Note

The HDMI cable can send both video data and audio data. There is no need to connect a separate audio cable.

## ◆ Playing the Audio of the Product through Other Devices

If you connect the SPDIF out port on the bottom of the display monitor to the SPDIF in port of the audio output device, or connect the AUDIO out port on the bottom of the display monitor to the AUDIO in port of the audio output device, the audio of the product will be played through the audio output device.

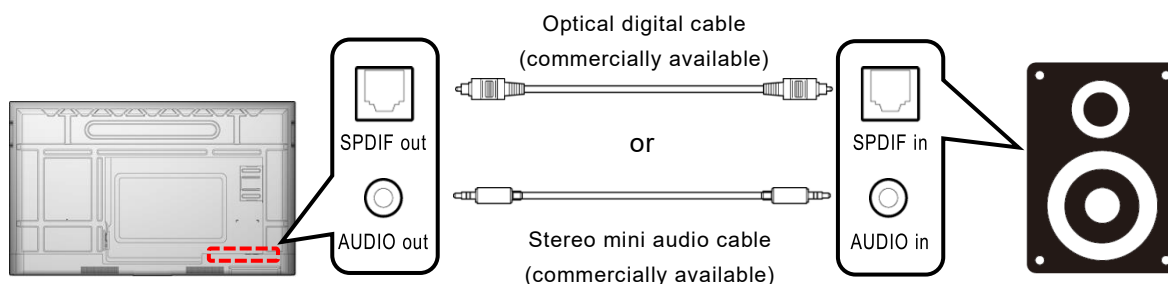

#### Note

Be sure to turn off the power of the devices to be connected before connecting them to the product.

## Switching the Input Source

You can switch the input source connected to the product.

### ◆ Operation



- 1 Tap the Menu icon in the list of apps or the side menu bar.

Tap "Source Preview".

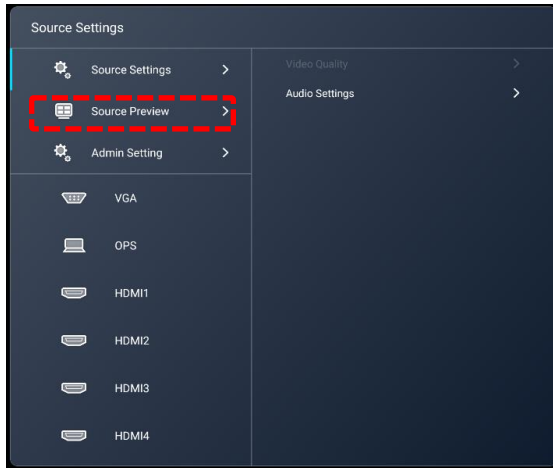

---

**Note** You can also switch between screens by directly tapping the input source name such as VGA, OPS, HDMI1 displayed on the Source Settings screen. If there is an input signal,  will appear next to the icon.

---

- 2 Select the thumbnail of the screen that you want to display, and then tap it. The selected thumbnail will be displayed in full screen.

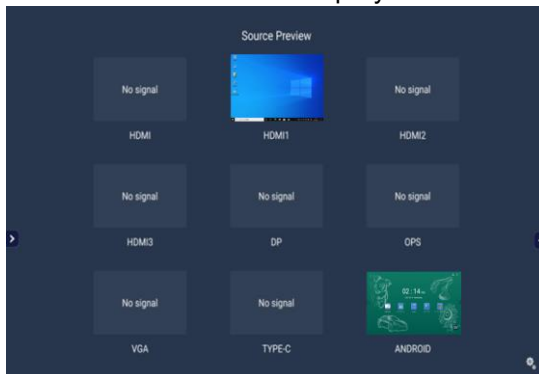

---

**Note** The Source Preview screen can also be displayed by flicking from the bottom of the Home screen.

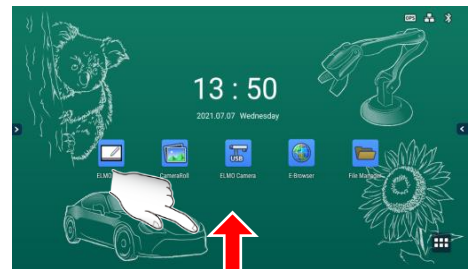

Home screen  
(flick from the bottom)

---

## ◆ Configuring the Source Settings

**1** Tap “Admin Setting” and enter the administrator password.

The default password is 0000000 (7 digits).

**2** The Source Settings menu will appear.

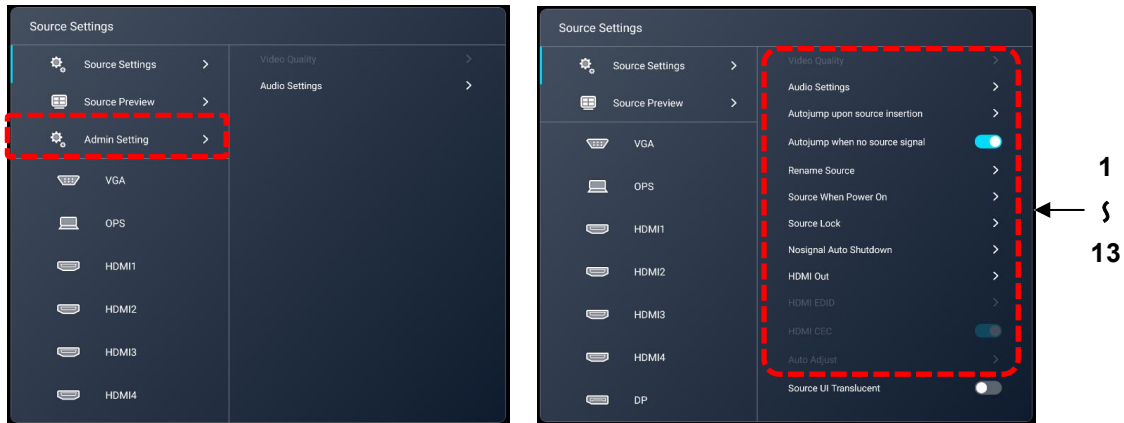

No.	Name	Function
1	Video Quality	To set the brightness, contrast, and color tone of the input video. (*You cannot configure the screen settings of an Android device with this menu item.) You can select this menu item from "Menu" in the side menu bar while the image is displayed on the display monitor.
2	Audio Settings	To configure the settings of the speaker of the product.
3	Autojump upon source insertion	To switch to the newly added input source automatically. [Auto Jump]: The screen will switch automatically when a new input source is added. [Popup Prompt]: A popup will appear when a new input source is added. The screen will not switch automatically. ●Default setting : Auto Jump
4	Autojump when no source signal	To switch to other input source automatically when the input source being used is disconnected. ●Default setting: ON
5	Rename Source	To change the name of the input source.
6	Source When Power On	To select the default input source which appears on the screen after power on. ●Default setting : Android (Home screen)
7	Source Lock	To set whether or not to lock each input source. ●Default setting : OFF(not locked)
8	Nosignal Auto Shutdown	To set the time before the product shuts down automatically when there is no input signal. Close / 5 min. / 10 min. / 15 min. ●Default setting : Close (The product does not shut down.)
9	HDMI Out	To select the resolution for HDMI output. Auto / 1920×1080 / 3840×2160 ●Default setting: Auto (This function is available only for models with an HDMI Out port.)
10	HDMI EDID	To switch between HDMI 1.4 and 2.0. ●Default setting : 2.0 (This setting item is available only when the HDMI image is displayed on the display monitor.)

No.	Name	Function
11	HDMI CEC	To turn on or off the CEC function of HDMI. ●Default setting: ON (This setting item is available only when the HDMI image is displayed on the display monitor.)
12	Auto Adjust	To automatically adjust the display position of the VGA image. (This setting item is available only when the VGA image is displayed on the display monitor.)

# 5 Configuring the Settings

## ◆ Startup

Tap the Settings icon in the list of apps.



## ◆ Before Configuring the Settings

To configure various settings, you need to enter the administrator password.

- 1 Tap the Settings icon  in the list of apps.
- 2 Tap “Admin Setting” and enter the administrator password.

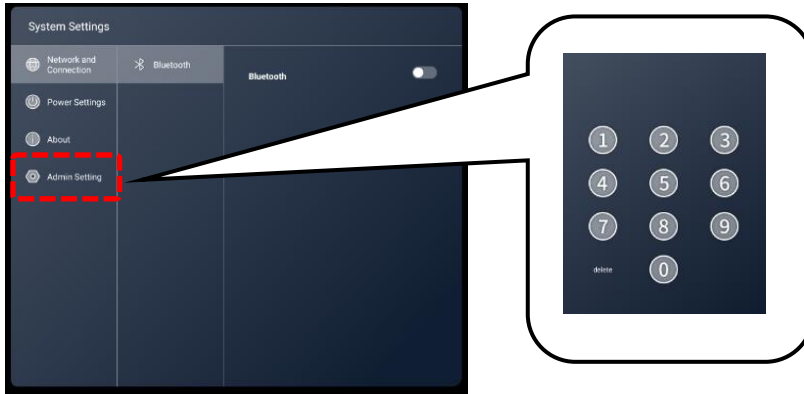

**Note** The default password is 0000000 (7 digits).

## ◆ Network and Connection

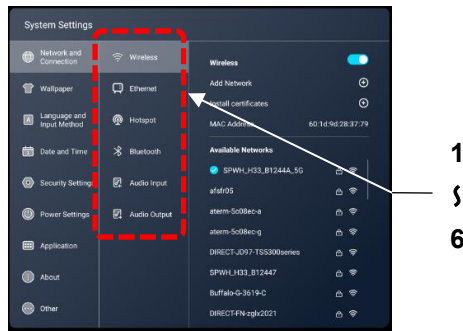

No.	Name	Function
1	Wireless	To configure the wireless network (Wi-Fi) settings. (⇒P.71)
2	Ethernet	To configure the wired network settings. (⇒P.72)
3	Hotspot	To configure the Hotspot settings. (⇒P.74)
4	Bluetooth	To configure the Bluetooth settings. (⇒P.74)
5	Audio Input	To configure the audio input settings.
6	Audio Output	To configure the audio output settings.

## ■ Configuring the Wireless Network (Wi-Fi) Settings (with the Settings App)



- 1 Tap the Settings icon  in the list of apps.
- 2 Tap “Network and Connection” and tap “Wireless”. Set the slide switch to ON.
- 3 Select the network to connect.

Enter the password for the network device and the product will be connected to the device.

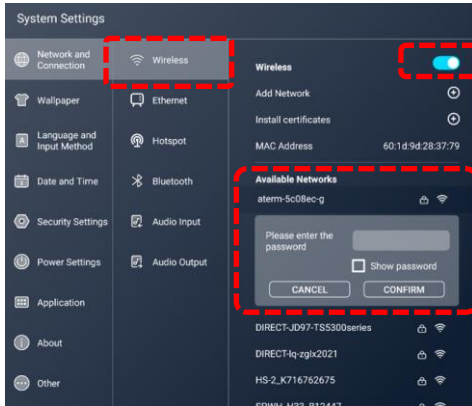

The "Add Network" (manual network setting) option is not available in the initial version. Set from the Advanced Setting app.

## ■ Configuring the Wireless Network (Wi-Fi) Settings (with the Advanced Setting App)



Configure the wireless network (Wi-Fi) settings with the Advanced Setting app when you want to set the proxy settings or connect to the stealth access point.

- 1 Tap the Settings icon  in the list of apps and confirm that the slide switch in the Ethernet settings is set to OFF.

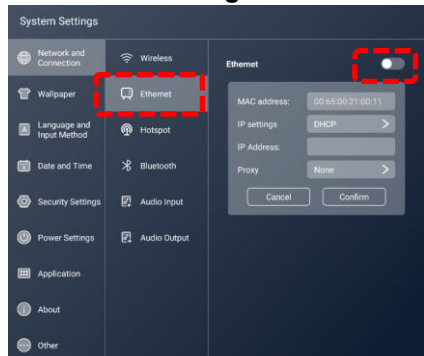

- 2 Tap the Advanced Settings icon  in the list of apps.
- 3 Enter “wifi\_settings” to the Input Command field and tap “Run”.

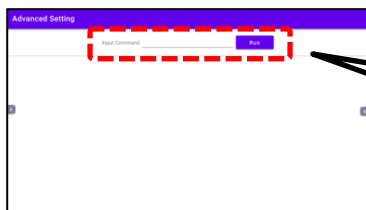

<Enter>  
Input Command wifi\_settings

- Set the slide switch for “Use Wi-Fi” at the top right of the screen to ON. A list of available network connections will appear. Scroll down the list and tap “Add network”.



- Enter the setting items, and then tap “SAVE”.

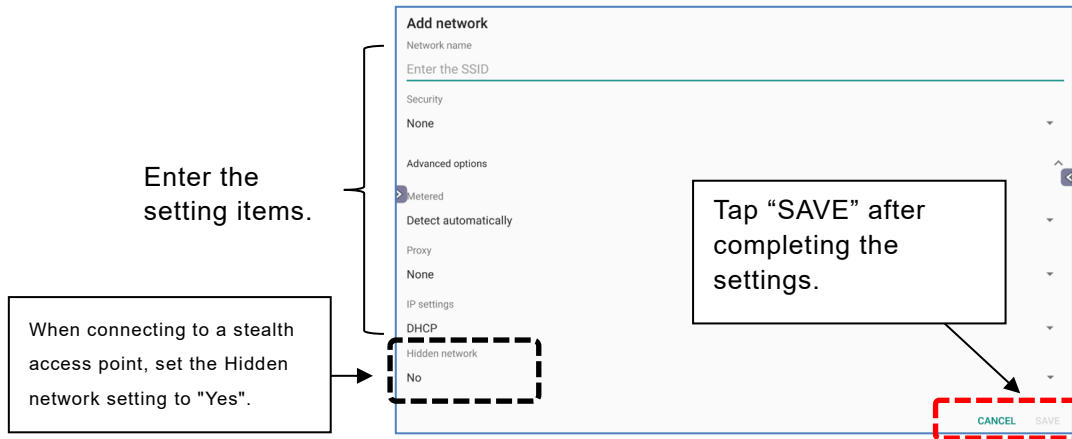

**Note**

- Consult with your network administrator for details of the network settings.
- Proxy settings and stealth access point settings will be available from the Settings app  in future version upgrades.

## ■ Configuring the Wired Network (LAN) Settings

The product can be connected to the network using a LAN cable.

- Connect the LAN cable to the LAN port on the side of the product and to the LAN port of the hub or router.

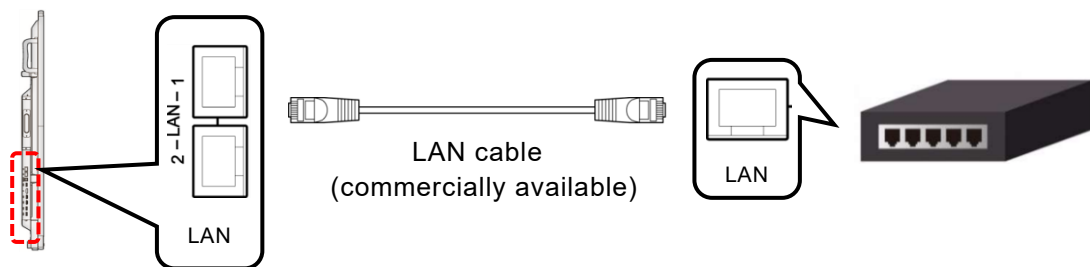

- Tap the Settings icon  in the list of apps.



**3 Tap “Network and Connection” and tap “Ethernet”. Set the slide switch to ON.**

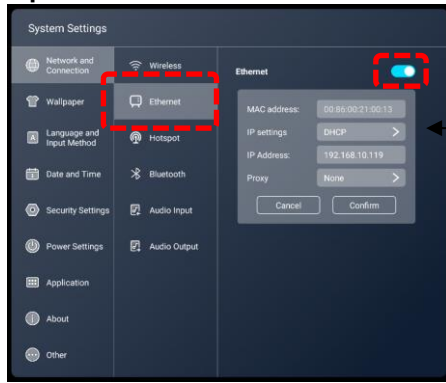

Tap “IP settings” and set it to “Static” to configure the Ethernet settings manually.

**Note**

- Consult with your network administrator for details of the network settings.
- If you use Wireless connection, Ethernet connection will be disabled.
- If you use Ethernet connection, Wireless connection will be disabled.

## ■ Configuring the HotSpot Settings

You can use the product as a hotspot to connect wireless devices.

- 1 Tap “Network and Connection” and tap “Hotspot”. Set the slide switch to ON.

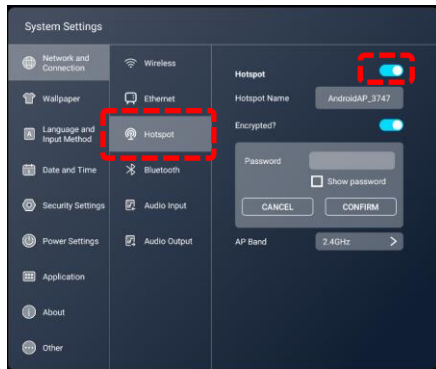

- 2 Configure the settings of the device to be connected.

Select “Wi-Fi” in the settings menu of the connected device.

Look for the access point with the name indicated in “Hotspot Name” of the product, and then connect to it. The device is now connected to the product.

## ■ Configuring the Bluetooth Settings

Using the built-in Bluetooth feature, you can connect Bluetooth-compatible devices such as a keyboard, mouse, or computer to the product.

- 1 Tap “Network and Connection” and tap “Bluetooth”. Set the slide switch to ON.

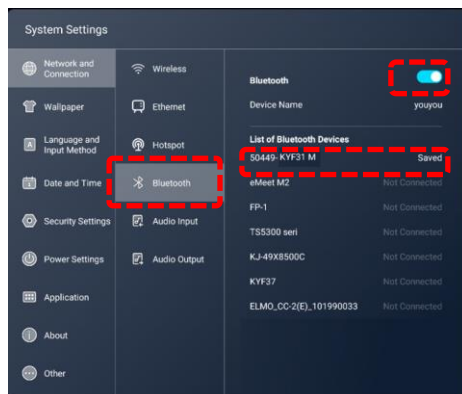

- 2 Select the Bluetooth device to be connected.

The device is now connected to the product.

### Note

- The maximum connectable distance for Wi-Fi and Bluetooth is 10m when there are no obstacles such as walls.
- For details about Wi-Fi settings and Bluetooth settings for the connected device, refer to the instruction manual of the connected device.
- Up to 10 devices can be connected to the hotspot at the same time. However, it may vary depending on the communication environment.

## ◆ System Settings

### ■ Wallpaper

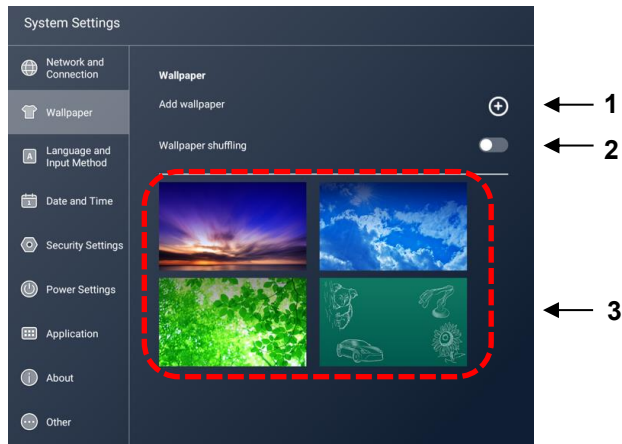

No.	Name	Function
1	Add wallpaper	To start the File Manager app. You can add a wallpaper by selecting a file. You can select files with the extension jpg and png.
2	Wallpaper shuffling	To change the wallpaper at set intervals. The interval can be set at 1 minute, 10 minutes, 30 minutes, 1 hour, or 6 hours. ● Default setting: OFF
3	Wallpaper	To select the wallpaper. Tap the wallpaper you want to set to change the wallpaper.

#### Note

#### <Adding a wallpaper: File Manager>

Tap "Insert" after selecting the file to set as wallpaper.

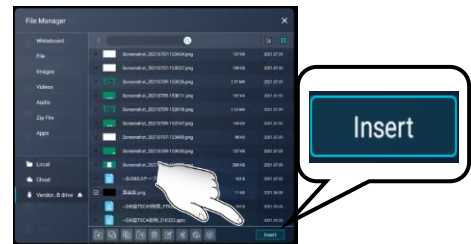

### ■ Language and Input Method

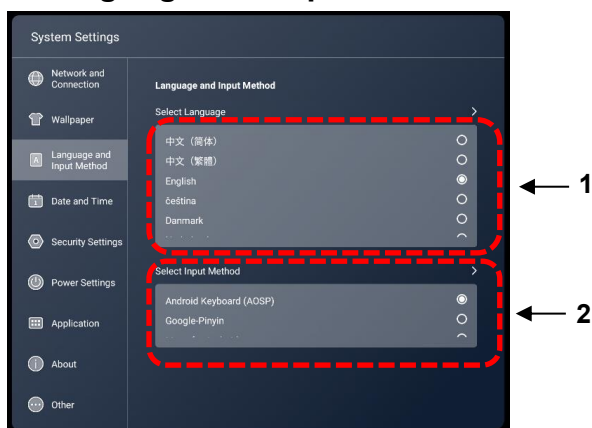

No.	Name	Function
1	Select Language	To set the language for the system.
2	Select Input Method	To set the input method.

## ■ Date and Time

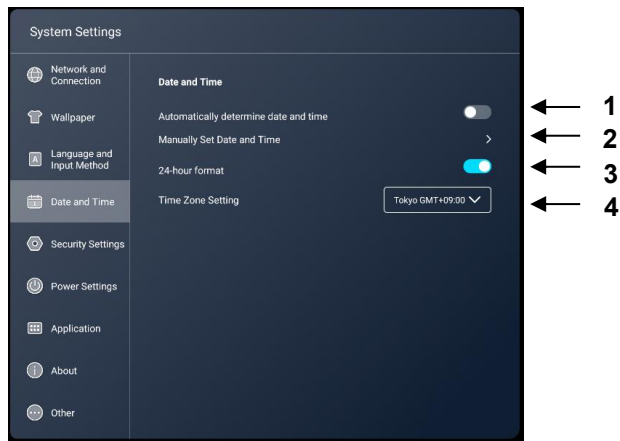

No.	Name	Function
1	Automatically determine date and time	To set whether or not to use the date and time information provided by the network.
2	Manually Set Date and Time	To set the date and time of the system manually when "Automatically determine date and time" setting is set to OFF.
3	24-hour format	To switch between 12-hour display and 24-hour display. ON: 24-hour display OFF: 12-hour display
4	Time Zone Setting	To set the time zone of the system.

## ■ Security Settings

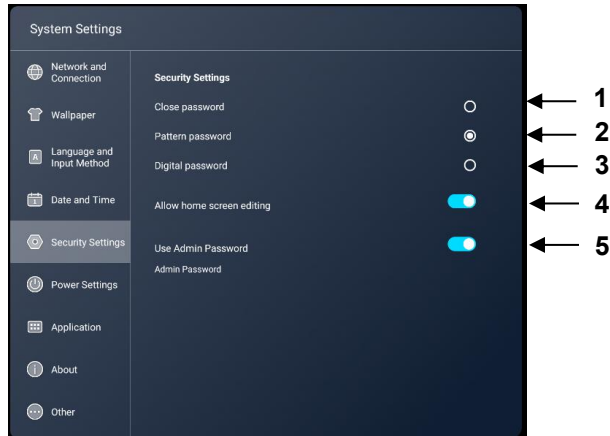

No.	Name	Function
1	Close password	To disable the password to edit the Home screen.
2	Pattern password	To set a pattern password to edit the Home screen. Set a pattern by connecting 4 dots or more.
3	Digital password	To set a 4 digit password to edit the Home screen.
4	Allow home screen editing	To set whether or not to allow the user to register or delete the app icon (shortcut) or change its position. (⇒P.21) Default setting: OFF
5	Use Admin Password Admin Password	To change the administrator password. Set a 7 digit password.

## ■ Power Settings

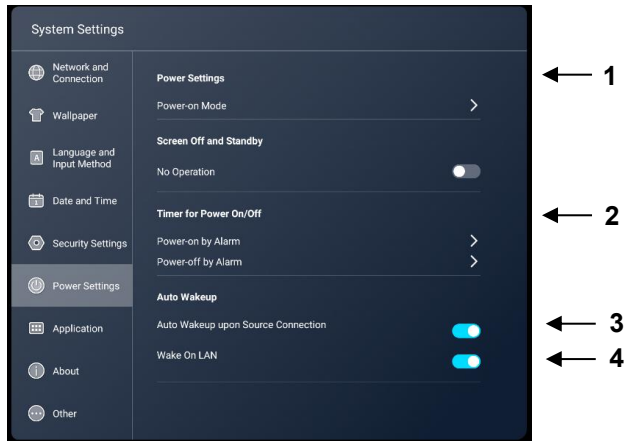

No.	Name	Function
1	Power-on Mode	To select the startup mode from "Power-on", "Power-on Standby", and "Power-on Memory". ●Default setting: Power-on
2	Timer for Power On/Off	Power-on by Alarm: To set the time when the power is automatically turned on. Power-off by Alarm: To set the time when the power is automatically turned off.
3	Auto Wakeup upon Source Connection	To set whether or not to make the product to return from the standby mode when there is a signal input from the source. ●Default setting: OFF
4	Wake On LAN	To set whether or not to allow the user to start the product by sending commands over the wired network. ●Default setting: OFF

## ■ Application

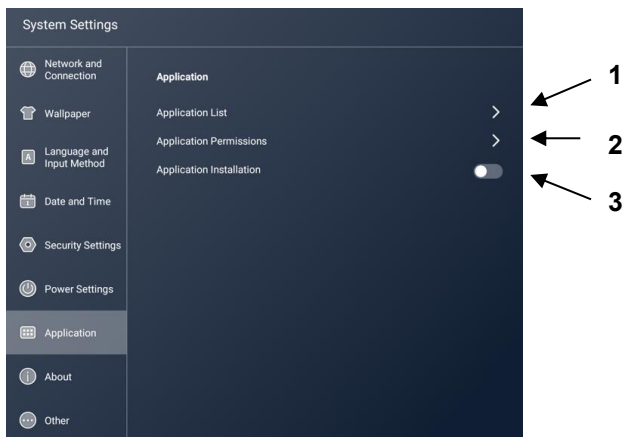

No.	Name	Function
1	Application List	To display a list of installed apps. Settings for each app can be configured from the screen displaying the list.
2	Application Permissions	To change permission settings for each app.
3	Application Installation	To set whether or not to allow the user to install an app. ●Default setting: OFF

## ■ Device Information

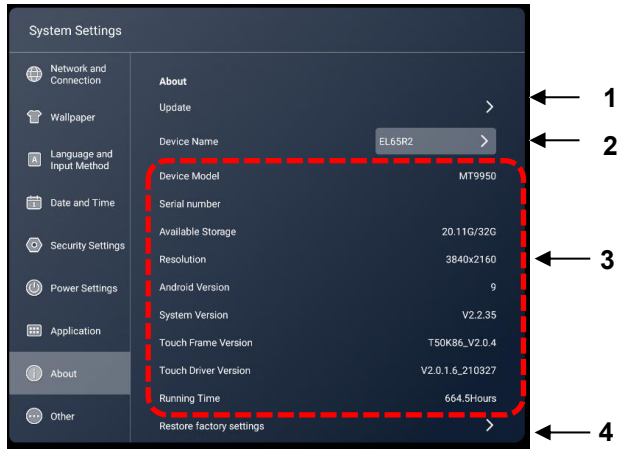

No.	Name	Function
1	Update	To update the firmware via the network.
2	Device Name	To display the device name of the product. Tap the device name to change it.
3	Information	To display various information of the product.
4	Restore factory settings	To reset the product to the factory default settings. The internal memory will be deleted after the reset.

## Others (Lock settings)

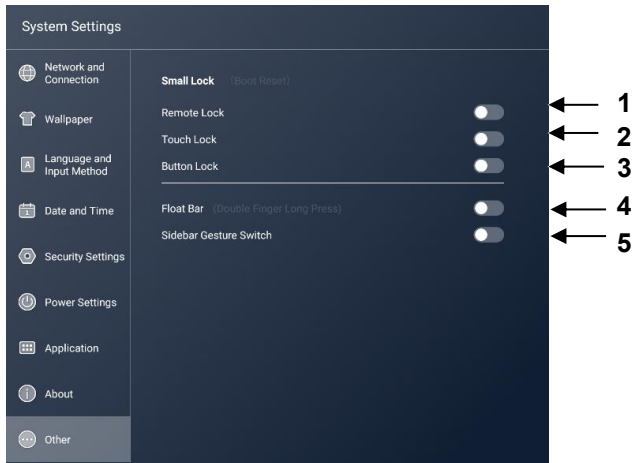

No.	Name	Function
1	Remote Lock	To set whether or not to disable the remote control operation. ●Default setting: OFF This setting will be set to OFF when the product is restarted.
2	Touch Lock	To set whether or not to disable the touch operation. ●Default setting: OFF This setting will be set to OFF when the product is restarted.
3	Button Lock	To set whether or not to disable the buttons on the operating panel. ●Default setting: OFF This setting will be set to OFF when the product is restarted.
4	Float Bar	To set whether or not to enable the Float Bar. On the Home screen, press and hold two points (long tap with two fingers) to start the Float Bar (shortcut menu). ●Default setting: OFF
5	Sidebar Gesture Switch	To set whether or not to hide the side menu bar. ●Default setting: ON

# 6 Optional Item

## 6.1 Easy Controller

By using the optional Easy Controller, you can do basic operations such as draw and erase with the buttons.

- 1 Install the Easy Controller to the right side of the display monitor.

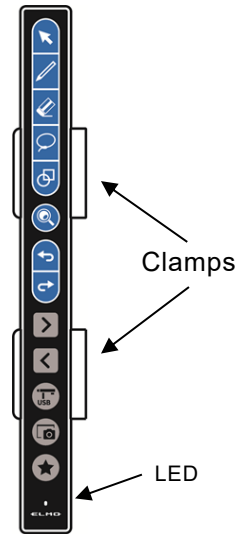
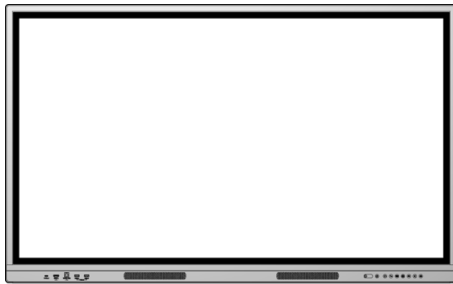

If you want to install the Easy Controller to the left side of the display monitor, rotate the clamps (2 pcs) 180 degrees.

- 1) Push the clamps horizontally to remove.
- 2) Rotate the clamps 180 degree, and then attach them back from the left side.

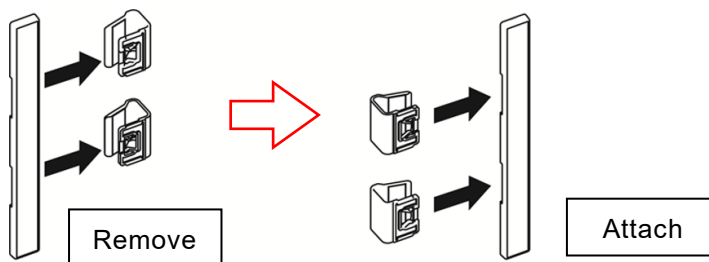

### Caution

- The clamp contains magnet. Keep away from objects that are sensitive to magnetic force, such as computers, monitors, and magnetic cards.

- 2 Connect the Easy Controller and the display monitor using the USB cable supplied with the Easy Controller.

Connect the Type-C plug of the USB cable to the Easy Controller and the Type-A plug to the display monitor.

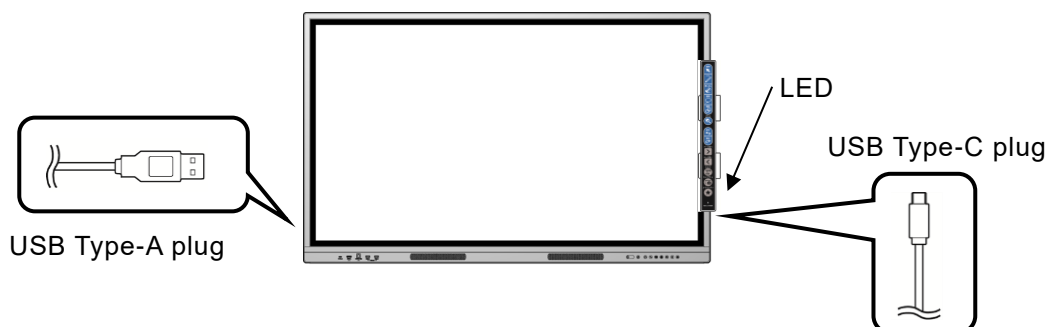















**Note**

The LED on the Easy Controller will light up if the connection is successful.

## ◆ Easy Controller Buttons

Button	Name	Function
	Operation	To enter the Operation mode. (⇒P.30)
	Pen	To draw free-hand lines. Tap this icon 2 times to display the Pen menu. (⇒P.28)
	Eraser	To delete the lines and objects. Tap this icon 2 times to display the Eraser menu. (⇒P.29)
	Select	To select the lines and objects on the screen. Tap this icon 2 times to display the Select menu. (⇒P.29)
	Shapes	To draw various shapes. Tap this icon 2 times to display the Shapes menu. (⇒P.30)
	Enlarge	To enlarge the area selected by dragging operation.
	Undo	To undo the last operation.
	Redo	To cancel the undo operation.
	Page forward	To move to the next page when using ELMO Note (whiteboard).
	Page back	To move to the previous page when using ELMO Note (whiteboard).
	USB camera	To start the ELMO Camera app. (⇒P.40)
	Screenshot	To capture the currently displayed screen and save it as a still image.
	Utilities	To start the shortcut of the app.

**Note**

Operation button, Pen button, Eraser button, Select button, Shapes button, Enlarge button, Undo button, and Redo button are used in ELMO Note and the Overlay app.

# 7 Troubleshooting and Maintenance

## 7.1 Troubleshooting

◆ **The product does not operate properly.**

Symptom	Check points and Countermeasures
<b>The remote control does not work properly.</b>	Check if there is an obstacle between the remote control and the receiver, preventing infrared rays from reaching.
	Operate the remote control toward the receiver.
	Check that the batteries of the remote control are inserted in the correct direction with the (+) and (-) terminals properly aligned.
	Check that the batteries in the remote control are full.
<b>The product automatically shuts down.</b>	Check if the auto shutdown function in "no signal" state is working.
	Check if there is a power failure.

◆ **The image of the input source cannot be output correctly.**

Symptom	Check points and Countermeasures
The image is not displayed correctly.	Check that the cables are connected correctly.
	Check that the connected cable and the input source setting of the product match.
	Check if the connected cables are broken or disconnected.
Vertical stripes and lines appear in the background.	Check that the cables are connected correctly.
	Check if the connected cables are broken or disconnected.
	Check if there are other electronic devices or appliances near the product. ● Radio waves may be affected by other devices. Move the product away from other equipment or change its position.
Image has no colors or colors are incorrect.	Check that the cables are connected correctly.
	Adjust "Contrast", "Brightness", and "Color Tone" in "Video Quality" settings menu.
There is a distortion in the image.	Check that the cables are connected correctly.
	Check if the connected cables are broken or disconnected.

◆ **No audio is output from the speaker.**

Symptom	Check points and Countermeasures
<b>No image is displayed and no audio is output from the speaker.</b>	Check if the power of the product is off or the product is in the standby mode.
	Check that the cables are connected correctly.
	Check that the connected cable and the input source setting of the product match.
<b>Image is displayed but audio is not output speaker.</b>	Press the mute button on the remote control and check if it is muted.
	Adjust the volume with the remote control or the volume control button on the front panel of the product.
	Check that the audio cable is properly connected. <ul style="list-style-type: none"> <li>● In the case of VGA connection, it is necessary to connect the stereo mini cable for audio output separately from the VGA cable.</li> </ul>

◆ **Touch operations do not work properly.**

Symptom	Check points and Countermeasures
<b>The product does not recognize the touch input or recognizes improperly.</b>	Check if the touch operation is disabled. <ul style="list-style-type: none"> <li>● System Settings &gt; Others &gt; Touch Lock</li> </ul>
	Make sure the size of the touched area is not too small compared to the size of your finger.
	Check if there are any abnormalities with the tip of the touch pen.
	When the touch operation of the computer connected to the product with the HDMI cable is not possible, check that correct ports are used. <ul style="list-style-type: none"> <li>● When using the TOUCH-USB port on the front of the product, use the HDMI in port on the front of the product. When using the TOUCH-USB port on the side of the product, use the HDMI in port on the side of the product.</li> <li>● Check that the product and the computer are connected with the supplied USB cable.</li> </ul>
	Check that the display monitor is clean.

◆ **Cannot connect to the network.**

Symptom		Check points and Countermeasures	
<b>Cannot connect to the network.</b>	General	Check that the network device such as a router is turned on.	
	Wireless	Check that the Wireless switch is set to ON.	
	Ethernet		Check that the Ethernet switch is set to ON.
			Check that the LAN cable is connected correctly.
			Check if the connected LAN cable is broken or disconnected.
	Hotspot		Check that the Hotspot switch is set to ON.
		Check that the device is connected to the Hotspot name of the product.	
The network speed is slow.	General	Check if the product is connected to a different access point.	

## 7.2 Maintenance

Clean and check the product regularly for long-term use.

---



### Caution

- Be sure to disconnect the power plug from the outlet before cleaning.
  - Rubbing or wiping the screen strongly may scratch the surface of the LCD display.
  - Do not wipe with chemicals such as thinner, benzene or alcohol, and do not apply insecticide.  
It may cause discoloration or damage the surface finish.
  - If the IR receiver becomes dirty, it may not operate properly. Wipe off any dirt with a soft cloth.
  - If dust collects inside the IR receiver, infrared rays cannot be transmitted or received correctly, causing malfunction.
  - For cleaning the inside of the product, consult with the dealer where you purchased the product. (Chargeable)
  - Be sure to pull out the power plug when the product is not used for a long time.
- 

### ◆ Cleaning of the LCD display

Wipe gently with a soft, dry cloth.

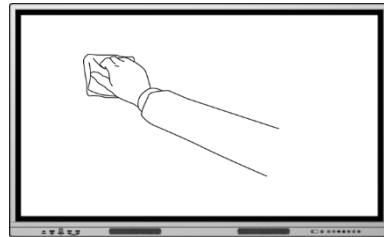

# 8 Specifications

## 8.1 Product Specifications

Model	EL55R2	EL65R2	EL75R2	EL86R2
Power supply	AC:100~240V 50/60Hz			
Power consumption	300W	300W	330W	450W
Temperature	0~40°C			
Humidity	20~80% (no condensation)			
Speaker	15W+15W	15W+15W	15W+15W	15W+15W
VESA	400x400 (M6 screw)	600x400 (M8 screw)	800x400 (M8 screw)	800x600 (M8 screw)
Dimensions	1290x93x792 [mm]	1512x88x920 [mm]	1723x88x1035 [mm]	1968x88x1173 [mm]
Weight	32kg	41kg	50kg	63kg
Screen size	55"	65"	75"	86"
Resolution	3840 × 2160	3840 × 2160	3840 × 2160	3840 × 2160
Brightness	375 cd/m <sup>2</sup>	450 cd/m <sup>2</sup>	550 cd/m <sup>2</sup>	450 cd/m <sup>2</sup>
Contrast	1300:1	1200:1	1200:1	1200:1
LCD response speed	6 ms	8 ms	8 ms	8 ms
Angle of view	Left/Right 178° Up/Down 178°			
Number of touch points	20 points			
Protective glass	Anti-Glare 3.2mm			
OS	Android 9.0			
CPU(CHIP)	Cortex A73 (MT9950)			
CPU SPEC	1.8GHz QuadCore			
RAM	4GB			
ROM	32GB			
Wi-Fi	IEEE802.11a/b/g/n/ac (2.4G/5G)			
Bluetooth	Bluetooth5.0			
OPS slot	1			
Touchscreen compatible OS	Windows, Mac , Chrome			

Function		Description
Input	Video	HDMI Type-A × 4 DisplayPort × 1 VGA (D-Sub:15pin) × 1
	Audio	ϕ 3.5mm mini × 1 (AUDIO) ϕ 3.5mm mini × 1 (MIC)
Output	Audio	ϕ 3.5mm mini × 1 SPDIF × 1
USB port		USB Type-C × 1 USB3.0 Type-A × 4 USB2.0 Type-A × 1
RS-232C port		D-Sub 9pin × 1
LAN port		1000BaseT (RJ-45) × 2
Touch port		USB 3.0 Type-B × 2

\* KL55R2 (HOL), KL65R2 (HOL), KL75 (HOL), KL86 (HOL) is a model without HDMI-out.

**Note**

- Some specifications may differ depending on the version and destination of the product. For details, contact the dealer from whom you purchased the product or the nearest ELMO sales office.

## 9 After-Sales Service

### 9.1 Product Warranty

This product comes with a warranty. The warranty card will be handed to you by the dealer after filling out the required information. Please read it carefully and keep it in a safe place.

The warranty period is one year from the date of purchase.

(The LED backlight of the light source and the pen are consumable items and are not covered by the warranty.)

You may be charged for repairs even during the warranty period, so please read the warranty carefully.

The warranty applies only to the hardware of the product.

Customers are responsible for the cost of removing and re-installing the product for repair.

A separate work fee will be charged when performing recovery work for defects that are not caused by the hardware of the product.

### 9.2 Repair Procedure

Read "Troubleshooting" in this manual, and if the problem still persists, unplug the power cord from the outlet and contact the dealer from whom you purchased the product or the nearest ELMO sales office.

Please make a note of the product model number and serial number when making inquiries.

Do not repair by yourself as it is very dangerous. If you repair by yourself, the warranty will be void, even within the warranty period.

#### **Within warranty period**

We will repair the product in accordance with the terms of the warranty.

#### **After warranty period**

Repairable products will be repaired on chargeable basis upon request of the customer.

Please contact the dealer from whom you purchased the product or the nearest ELMO sales office.

When making a repair request, please inform us of the product name, customer name, address, telephone number, date of purchase, and details of the failure.

#### **Repair charge**

The repair fee consists of [Technical fee] + [Parts cost] + [Business trip fee] + [Transportation fee].

## Trademarks

- **ELMO** is a registered trademark of TECHNO HORIZON CO., LTD.
- Bluetooth is a registered trademark of Bluetooth SIG, Inc.
- Microsoft, Windows, and One Drive are registered trademarks of the Microsoft Corporation in the U.S. and other countries.
- HDMI, HDMI logo, and High-Definition Multimedia Interface are trademarks or registered trademarks of HDMI Licensing LLC in the U.S. and other countries.
- Android OS and Google Drive are trademarks of Google LLC.
- Display Port is a registered trademark of Video Electronics Standards Association.

All other company/product names described in this manual are trademarks or registered trademarks of their respective companies.



## テクノホライゾン株式会社 エルモカンパニー

〒457-0071  
愛知県名古屋市南区千竈通二丁目 13 番地 1  
Web : <https://www.elmo.co.jp>

製品のお問い合わせは、下記オフィスへ

- 札幌オフィス  
〒060-0908  
北海道札幌市東区北 8 条東 3 丁目 1-1 宮村ビル 3 階  
TEL.011-594-8450
- 仙台オフィス  
〒980-0802  
宮城県仙台市青葉区二日町 13 番 18 号 ステーションプラザビル 6 階  
TEL.022-266-3255
- 品川オフィス  
〒108-0075  
東京都港区港南 2 丁目 16 番 4 号 品川グランドセントラルタワー17 階  
TEL.03-3471-4577
- 名古屋オフィス  
〒457-0078  
愛知県名古屋市南区塩屋町 1 丁目 3 番 4  
TEL.052-811-5261
- 京都オフィス  
〒604-8101  
京都府京都市中京区柳馬場御池下る柳八幡町 65  
京都朝日ビル 10 階  
TEL.075-744-1360
- 大阪オフィス  
〒550-0002  
大阪府大阪市西区江戸堀 1-9-6 肥後橋ユニオンビル 10 階  
TEL.06-6443-6001
- 姫路オフィス  
〒670-0912  
兵庫県姫路市南町 63 ミツワビル 1 階  
TEL.079-257-1636
- 広島オフィス  
〒730-0012  
広島県広島市中区上八丁堀 4-1 アーバンビューグランドタワー1104  
TEL.082-221-2801
- 福岡オフィス  
〒812-0039  
福岡県福岡市博多区冷泉町 2 番 8 号 朝日プラザ祇園 2 階  
TEL.092-281-4131
- 熊本オフィス  
〒862-0976  
熊本県熊本市中央区九品寺 1 丁目 11 番 4 号  
熊本県教育会館 4 階  
TEL.096-282-8338

## OVERSEAS SUBSIDIARY COMPANIES

### ELMO USA CORP.

- Headquarters  
6851 Jericho Turnpike  
Suite 145  
Syosset, NY 11791  
Tel. (516) 501-1400  
Fax.(516) 501-0429  
E-mail : [elmo@elmousa.com](mailto:elmo@elmousa.com)  
Web : <https://www.elmousa.com/>

### ELMO Europe SAS

- Headquarters  
60, av. Charles de Gaulle  
92200 Neuilly - sur - Seine FRANCE  
Tel. +33 (0) 1 73 02 67 06  
Fax. +33 (0) 1 73 02 67 10  
E-mail : [info@elmoeurope.com](mailto:info@elmoeurope.com)  
Web : <https://www.elmoeurope.com/>

### German Branch

Monschauerstr. 1  
40549 Düsseldorf  
Tel. +49 (0) 211 544756 40  
Fax. +49 (0) 211 544756 60  
E-mail : [info@elmoeurope.com](mailto:info@elmoeurope.com)  
Web : <https://www.elmo-germany.de/>

### Middle East Branch

5WA-129, Dubai Airport Free Zone,  
P.O Box 371556, Dubai,  
United Arab Emirates  
Tel. +971-(0)4-260-2390  
Fax. +971-(0)4-260-2392  
E-mail : [tariq@elmoeurope.com](mailto:tariq@elmoeurope.com)  
Web : <https://www.elmoeurope.com/>

### TECHNO HORIZON CO., LTD.

2-13-1, Chikama-Tori, Minami-ku,  
Nagoya-shi, Aichi, Japan 457-0071

6X1XSYA24-R0-epx