

xSync Board/ELMO BOARD
EL55R1/EL65R1/EL75R1/EL86R1

Instruction Manual



Table of contents

Safety instructions	5
Operating precautions	7
Package contents	8
Part names and functions	9
Front	9
Side	10
Back	11
Installation	12
Installation conditions	12
Remote control	13
Inserting batteries	13
Operating range of the Remote control	13
Remote control operations	14
Connecting the devices	15
Displaying the computer screen (video and audio)	15
Connecting with HDMI cable	15
Connecting with VGA cable and audio cable	16
Displaying the screen of the connected device (video and audio)	17
Connecting with HDMI cable	17
Connecting with AV cable	18
Displaying the screen of the monitor on other display monitor	19
Playing the sound on other device	20
Controlling the product from a computer (serial control)	21
Connecting to the network	22
Connecting via Wi-Fi	22
Connecting via LAN	22
Connecting via Bluetooth	23
Connecting the power cord	23
Turning on or off the power	24

Standby mode	26
Touch operations	27
Touch pen	28
Basic operations	29
Home screen	29
Displaying the side menu bar	30
Displaying the floating menu	31
Opening list of apps	32
Using the whiteboard app (S-write)	33
Startup	33
Screen description	33
Drawing and erasing	34
Select mode	34
Eraser mode	35
Saving and reading data	35
Import picture function and split screen mode	36
Browsing the files	37
Starting the File app	37
Operating the File app	37
Connecting to the server	38
Browsing the website	40
Starting the Browser app	40
Operating the Browser app	40
Using a USB camera	41
Starting the USB camera app	41
Operating the USB camera app	41
Screen Mirror (Transcreen)	43
Using on Windows OS	43
Using on iOS or Mac OS	44
Using on Chrome OS	44

Using on Android	45
ELMO Play	46
Anti-virus app (KINGSOFT Mobile Security Plus)	46
Scottie Go !	46
Switching the input source	47
Startup	47
Operation	47
Input source settings	48
Other functions	51
Screenshots function	51
Countdown function	51
Configuring the settings	52
Advanced settings	52
Troubleshooting	61
The product does not operate properly	61
The image of the input source cannot be output correctly	61
No audio is output from the speaker	62
Touch operations do not work properly	62
Cannot connect to the network	62
Maintenance	63
Specifications	64
Field frequency	65
After-sales service	67
Product warranty	67
Repair procedure	67

SAFETY INSTRUCTIONS

Make sure to read the "Safety precautions" in this guide before using this product.

WARNING

- Failure to follow the installation instructions included with the display could result in injury and product damage which may not be covered by the warranty.
- Do not open or disassemble the display.
You risk electrical shock from the high voltage inside the casing. Opening the casing also voids the warranty.
- Do not stand (or allow children to stand) on a chair to touch the surface of the display.
Rather, mount the product at the appropriate height.
- To reduce the risk of fire or electric shock, do not expose the display to rain or moisture.
- If the display requires replacement parts, make sure the service technician uses replacement parts specified by ELMO or parts with the same characteristics as the original.
- Ensure that any cables that cross the floor to the display are properly bundled and marked to avoid a trip hazard.
- Do not insert objects inside the cabinet ventilation holes, because they could touch dangerous voltage points and cause electric shock, fire or product damage which may not be covered by the warranty.
- Do not place heavy objects on the power cable. Damage to the cable could cause shock, fire or product damage which may not be covered by the warranty.
- Use only extension cords and outlets that can fully accommodate the display's polarized plug.
- Use the power cable provided with the display. If a power cable is not supplied, contact your supplier.
Use only power cables that match the AC voltage of the power outlet and that comply with your country's safety standards.
- If the glass is broken, do not touch the liquid crystal. To prevent injury, handle glass fragments with care when disposing of them.
- Do not move or mount the display by connecting rope or wire to its handles.
The display is heavy, and failure of the rope, wire or handle could lead to injury.
- Use only VESA®-approved mounts if using a mount other than the one supplied with the display.
- Disconnect all of the display's power cables from the wall outlet and seek assistance from qualified service personnel if any of the following occur:
 - * The power cable or plug is damaged. * Liquid is spilled into the display. * Objects fall into the display. * The display is dropped.
 - * Structural damage, such as cracking, occurs * The display behaves unexpectedly when you follow operating instructions

CAUTION

- Turn off the display before cleaning its screen. Otherwise, you may scramble the desktop icons or inadvertently activate applications when you wipe the screen.
 - Avoid setting up and using the display in an area with excessive levels of dust, humidity, and smoke.
 - Make sure an electrical socket is near the display and remains easily accessible during use.
 - The display should be used only with European TN and TT power distribution systems. It is not suitable for older, IT-type power distribution systems found in some European countries. This system (IT-type) is widely used isolated from earth, in some installations in France, with impedance to earth, at 230/400V, and in Norway, with voltage limiter, neutral not distributed, at 230V line-to-line.
Contact qualified personnel if you're uncertain of the type of power system available where you're installing the display.
 - You must connect the USB cable that came with the display to a computer that has a USB compliant interface and that bears the USB logo.
In addition, the USB source computer must be compliant with IEC 60950-1 and/or IEC 62368-1.
The source computer must be CE marked and carry safety certification marks for Canada and USA.
This is for operating safety and to avoid damage to the display.
 - Read Instructions - All the safety and operating instructions should be read before the appliance is operated.
 - Retain Instructions - The safety and operating instructions should be retained for future reference.
 - Heed Warnings - All warnings on the product and in the operating instructions should be adhered to.
 - Follow Instructions - All operating and use instructions should be followed.
 - Cleaning - Unplug this product from the wall outlet before cleaning. Do not use liquid cleaners or aerosol cleaners. Use a damp cloth for cleaning.
 - Attachments - Do not use attachments not recommended by the product manufacturer as they may cause hazards.
 - Water and Moisture - Do not use this product near water - for example, near a bath tub, wash bowl, kitchen sink, or laundry tub, in a wet basement, or near a swimming pool, and the like.
 - Placement - Do not place this product on an unstable cart, stand, tripod, bracket, or table.
The product may fall, causing serious injury to a child or adult, and serious damage to the product.
Use only with a cart, stand, tripod, bracket, or table recommended by the manufacturer, or sold with the product.
Any mounting of the product should follow the manufacturer's instructions, and should use a mounting accessory recommended by the manufacturer.
 - Ventilation - Slots and openings in the cabinet are provided for ventilation and to ensure reliable operation of the product and to protect it from overheating, and these openings must not be blocked or covered.
The openings should never be blocked by placing the product on a bed, sofa, rug, or other similar surface.
This product should not be placed in a built-in installation such as a bookcase or rack unless proper ventilation is provided or the manufacturer's instructions have been adhered to.
 - Lightning - For added protection for this product during a lightning storm, or when it is left unattended and unused for long periods of time, unplug it from the wall outlet and disconnect the antenna or cable system. This will prevent damage to the product due to lightning and power-line surges.
 - Overloading - Do not overload wall outlets, extension cords, or integral convenience receptacles as this can result in a risk of fire or electric shock.
 - **A product and cart combination should be moved with care. Quick stops, excessive force, and uneven surfaces may cause the product and cart combination to overturn.**
- 

- Servicing - Do not attempt to service this product yourself as opening or removing covers may expose you to dangerous voltage or other hazards.
Refer all servicing to qualified service personnel.
- Safety Check - Upon completion of any service or repairs to this product, ask the service technician to perform safety checks to determine that the product is in proper operating condition.
- Heat - The product should be situated away from heat sources such as radiators, heat registers, stoves, or other products (including amplifiers) that produce heat.

IMPORTANT

The following are the normal operating requirements for the display, including AM module and speakers:

MODEL	Power requirements
EL55R1	AC100V~240V 140W max
EL65R1	AC100V~240V 220W max
EL75R1	AC100V~240V 400W max
EL86R1	AC100V~240V 440W max

For additional requirements and other information, refer to the display's specifications.

Federal Communication Commission interference statement

FCC

Suppliers Declaration of Conformity

47 CFR § 2.1077 Compliance Information

Unique Identifier: EL55R1, EL65R1, EL75R1, EL86R1

Responsible Party – U.S. Contact Information

ELMO USA CORP.

6851 Jericho Turnpike, Suite 145

Syosset, NY 11791

This device complies with Part 15 of the FCC Rules. Operation is subject to the following two conditions:

1. This device may not cause harmful interference, and
2. This device must accept any interference received, including interference that may cause undesired operation.

NOTE

This equipment has been tested and found to comply with the limits for a Class A digital device, pursuant to part 15 of the FCC Rules.

These limits are designed to provide reasonable protection against harmful interference when the equipment is operated in a commercial environment. This equipment generates, uses, and can radiate radio frequency energy and, if not installed and used in accordance with the instruction manual, may cause harmful interference to radio communications. Operation of this equipment in a residential area is likely to cause harmful interference in which case the user will be required to correct the interference at his own expense.

CAUTION

Any changes or modifications not expressly approved by the party responsible for compliance could void the user's authority to operate this equipment.

Restriction

Operations in the 5.15-5.25GHz band are restricted to indoor usage only.

IEEE 802.11b or 802.11g operation of this product in the USA is firmware limited to channels 1 through 13.

CAUTION

- i. the device for operation in the band 5150-5250 MHz is only for indoor use to reduce the potential for harmful interference to co-channel mobile satellite systems;
- ii. the maximum antenna gain permitted for devices in the bands 5250-5350 MHz and 5470-5725 MHz shall comply with the e.i.r.p. limit; and
- iii. the maximum antenna gain permitted for devices in the band 5725-5825 MHz shall comply with the e.i.r.p. limits specified for point-to-point and non point-to-point operation as appropriate.
- iv. Users should also be advised that high-power radars are allocated as primary users (i.e., priority users) of the bands 5250-5350 MHz and 5650-5850 MHz and that these radars could cause interference and/or damage to LE-LAN devices.

Radiation exposure statement

This equipment complies with FCC radiation exposure limits set forth for an uncontrolled environment.

This equipment should be installed and operated with minimum distance of 20 cm between the antenna of this device and all nearby persons.

This transmitter must not be co-located or operated in conjunction with any other antenna or transmitter.

EU declaration of conformity

Hereby ELMO CO., LTD. declares that the radio equipment type Interactive displays model EL55R1, EL65R1, EL75R1, EL86R1 are in compliance with directive 2014/53/EU.

WARNING

Operation of this equipment in a residential environment this equipment may could cause radio interference.

The frequency band and the maximum transmitted power in EU are listed below:

Transmitting Band (MHz)	2402-2483.5	5150-5350	5470-5725
Maximum Transmit Power EIRP (dBm)	19	23	23

Restrictions in

AT/BE/BG/CZ/DK/EE/FR/DE/IS/IE/IT/EL/ES/CY/LV/LI/LT/LU/HU/MT/NL/NO/PL/PT/RO/SI/SK/TR/FI/SE/CH/UK/HR—5150MHz-5350MHz is for indoor use only

CAUTION: EXPOSURE TO RADIO FREQUENCY RADIATION

This equipment complies with EU radiation exposure limits set forth for an uncontrolled environment.

This equipment should be installed and operated with minimum distance 20 cm between the radiator and your body.

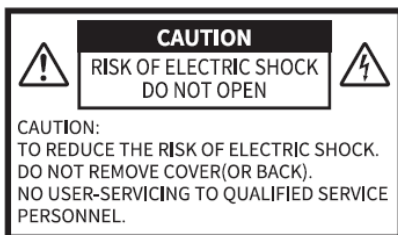

The lightning flash with arrowhead symbol, within an equilateral triangle, is intended to alert the user to the presence of uninsulated "dangerous voltage" within the product's enclosure that may be of sufficient magnitude to constitute a risk of electric shock to persons.



The exclamation point within an equilateral triangle is intended to alert the user to the presence of important operating and maintenance (servicing) instructions in the literature accompanying the product.

 This symbol [crossed-out wheeled bin WEEE Annex IV] indicates separate collection of waste electrical and electronic equipment in the EU countries. Please do not throw the equipment into the domestic refuse. Please use the return and collection systems available in your country for the disposal of this product.

WARNING

TO REDUCE THE RISK OF FIRE OR ELECTRIC SHOCK, DO NOT EXPOSE THIS PRODUCT TO RAIN OR MOISTURE.

The connection of a non-shielded equipment interface cable to this equipment will invalidate the FCC Certification or Declaration of this device and may cause interference levels which exceed the limits established by the FCC for this equipment. It is the responsibility of the user to obtain and use a shielded equipment interface cable with this device. If this equipment has more than one interface connector, do not leave cables connected to unused interfaces. Changes or modifications not expressly approved by the manufacturer could void the user's authority to operate the equipment.

USER-INSTALLER

CAUTION:

Your authority to operate this FCC verified equipment could be voided if you make changes or modifications not expressly approved by the party responsible for compliance to Part 15 of the FCC rules.

Operating precautions

- Be sure to use the cable supplied with the product.
- The supplied power cord are designed for exclusive use with this product.
- Do not strongly press the touchscreen or press it with sharp objects.
- This may result in damage or malfunction to the touchscreen.
- Be sure to use the power cord applicable to your local power specifications. It may be discolored, deformed, or damaged.
- Do not place this product in any humid, dusty, salt bearing wind, or vibrating locations.
Use it under the following environmental conditions:
Temperature : 0°C ~ 40°C
Humidity : 30% ~ 85% (No condensation)
- Use a soft, dry cloth for cleaning. Do not use any volatile solvent such as thinner or benzene.
- If this product is used for longer than the warranty period, its performance and quality may deteriorate due to the lifetime of its parts.
For parts replacement (on chargeable basis), consult the dealer from whom you purchased this product or our branch/office near your location.
- Copyright
Unless used for personal use, it is prohibited strictly under copyright law to use any photo files without the prior consent of the copyright holder.
- It is prohibited under copyright law to use or copy any part or the whole of this document without our prior written consent.
- ELMO shall not be liable for any claim for damage or loss of earnings or any claim raised by a third person due to the use, malfunction or repair of this product.

ELMO is registered trademarks of ELMO Co., Ltd.

All other company/product names described in this manual are trademarks or registered trademarks of their respective companies.

Package contents

The items below are included in the package. If any item is missing, contact the dealer from whom you purchased this product.



Display monitor



Remote control x1



Touch pen (Hard type x2,
Soft type x2)



Power cord (3m)

See Note below.



HDMI cable x1 (3m)



USB cable x1 (3m)

※TypeB-TypeA

Quick Start Guide
(incl. Warranty card)

Important
Safeguards

Note

The type of the power cord varies depending on the country.

For the USA and Japan : Type A, Type A (JP tape attached) , Type C

Do not use the power cord with the JP tape attached except in Japan.





For the EU/EEA and the UK : Type C, Type BF



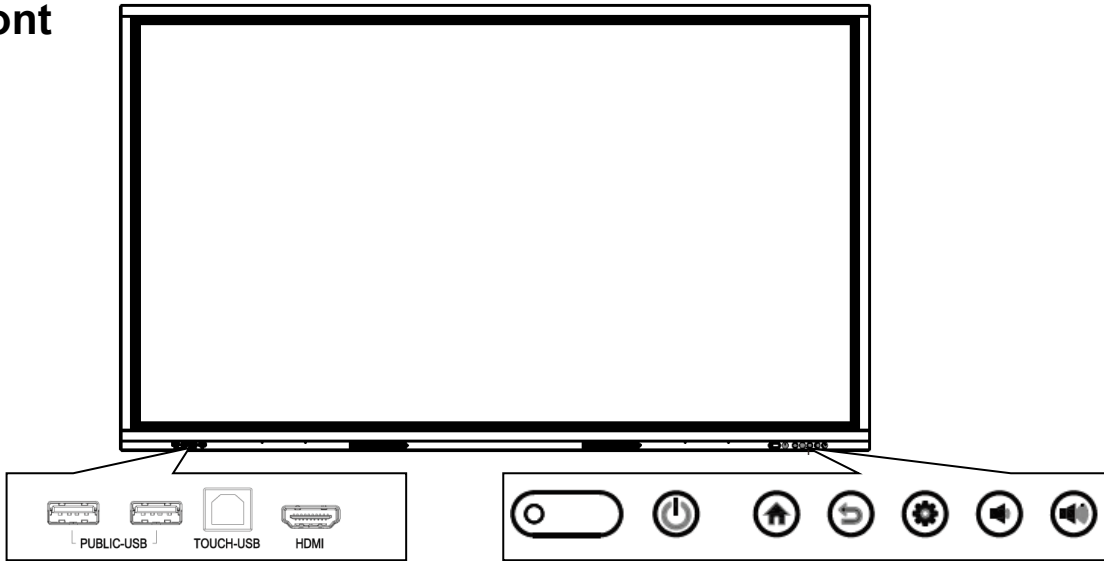



For other countries : Use the power cord usable in your country.

Part names and functions

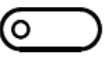
■Front



	USB2.0 port (TypeA)	To connect a USB device.
	USB2.0 port (TypeA)	To connect a USB device.
	Touch port (USB TypeB)	To perform touch operations of the device on the monitor, when connected with the supplied USB cable.
	HDMI input port (TypeA)	To connect a video source device using the supplied HDMI cable.

	IR receiver	IR receiver for the remote control.
	Power LED	To indicate the power status. On: Green Off: Red
	Power	To turn on or off the power. When power status is on: Long press to turn off the power, short press to enter the standby mode. When power status is off: Short press to turn on the power.
	Home	To display the Home screen. ⇒P.29
	Return	To go back to the previous screen.
	Settings	To start the Configuration software. ⇒P.52 In the Input Source Setting, "Input image adjustment" is activated. ⇒P.47
	Volume down	To decrease the volume.
	Volume up	To increase the volume.

■Side

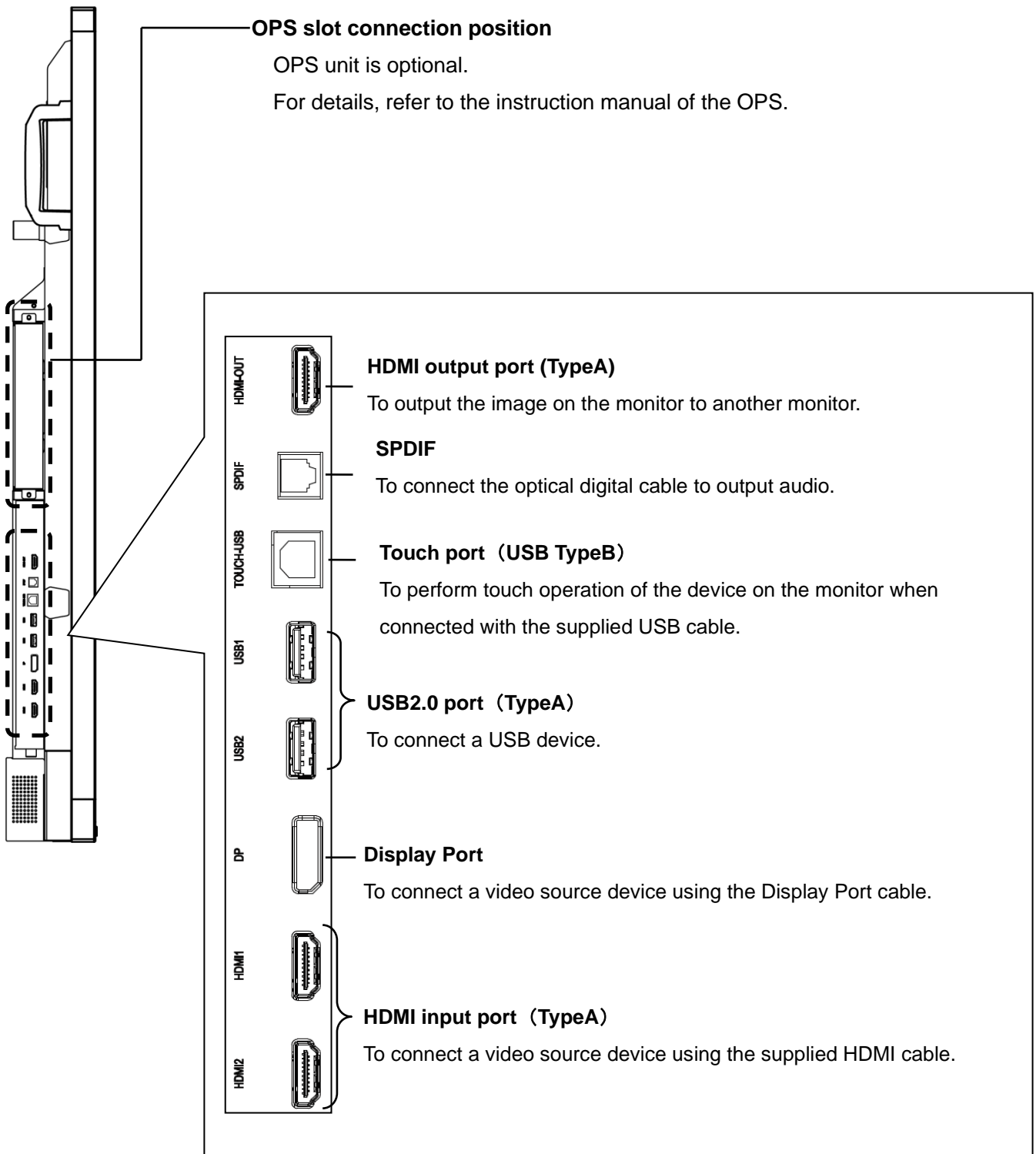

■Back

700 mm : EL86R1
 600 mm : EL75R1、EL65R1
 400 mm : EL55R1

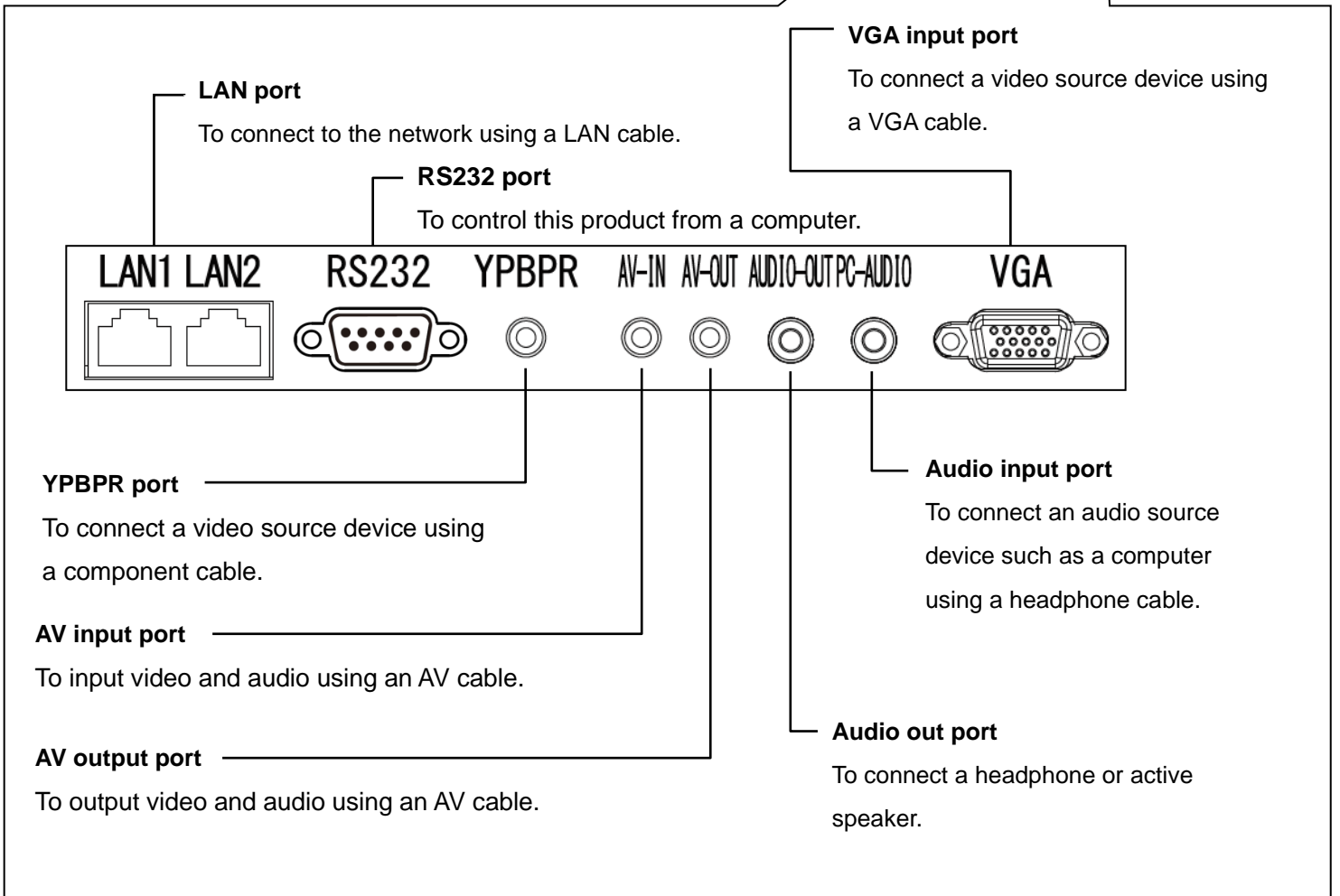
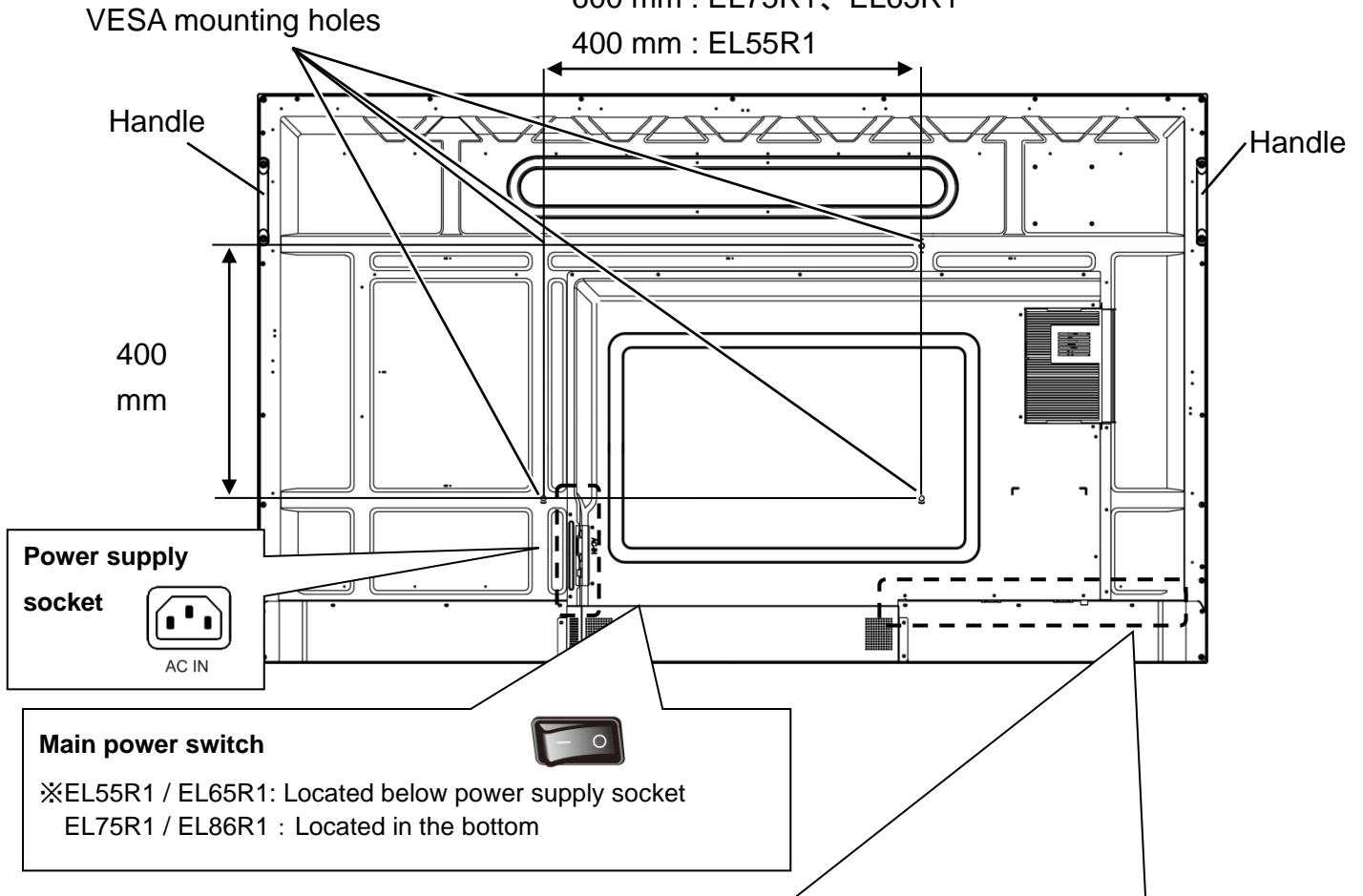

Installation

■ Installation conditions

- Use this product in the following environment.

Temperature	0~40°C
Humidity	20~80%

- Do not install this product in places where it may be hit by rain or water, or where the humidity is high.
- Do not install this product near the air outlet of air conditioner.

Condensation may occur due to sudden temperature changes, causing internal corrosion and failure.

- To prevent internal heat buildup, install this product in a well-ventilated place, keeping the following distance from the surrounding area.

- EL65R1、EL75R1、EL86R1 : Use M8 screws with a length of 20 mm to attach the VESA brackets.
- EL55R1 : Use M6 screws with a length of 20 mm to attach the VESA brackets.

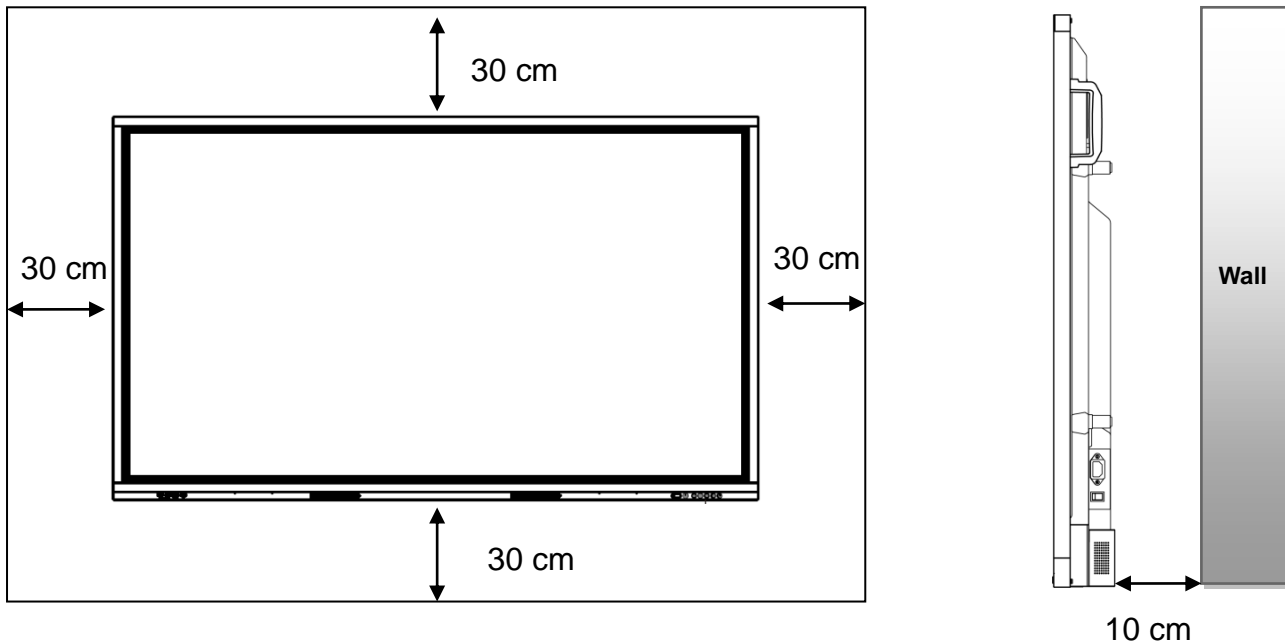

Caution

- Since this product is heavy, consult the dealer from whom you purchased this product when installing, removing or moving it.

- Always install, remove, and move this product with 4 or more people.

The product may fall and cause injury.

- If you want to mount this product on a wall or suspend it from the ceiling, ask a specialist for installation work.

ELMO is not responsible for any accident or damage caused by improper installation.

- Be careful not to block the ventilation holes when installing. The heat will be trapped inside and may cause a malfunction or a fire.

Remote control

■ Inserting batteries

1. Slide and open the cover in the back of the remote control.
2. Insert 2pcs of AAA batteries.
Pay attention to the polarity, which is printed inside the remote control.
3. Firmly close the cover.

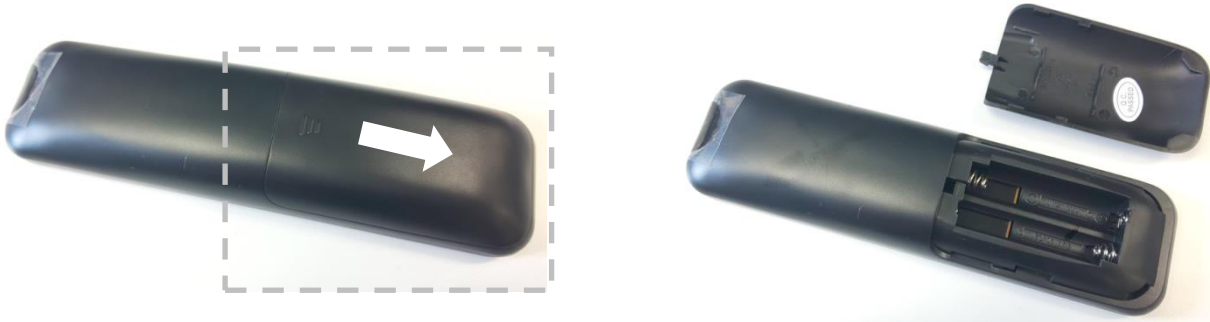

Note

- When battery power becomes low, replace with new batteries as soon as possible.
- Use manganese or alkaline AAA batteries.
- If you do not use the remote control for a long time, remove the batteries.

■ Operating range of the Remote control.

If there is no obstruction between the IR receiver of the product and the remote control, the operatable range of the remote control will be as follows:

Distance: within 5m

Angle: within 30° up, down, left, and right

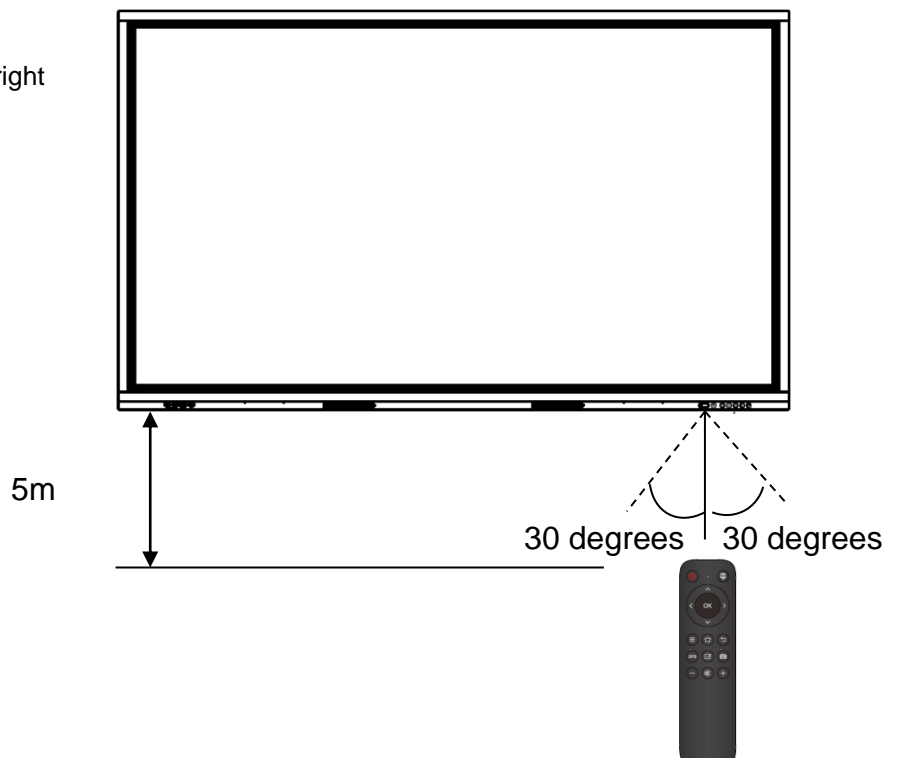

■Remote control operations

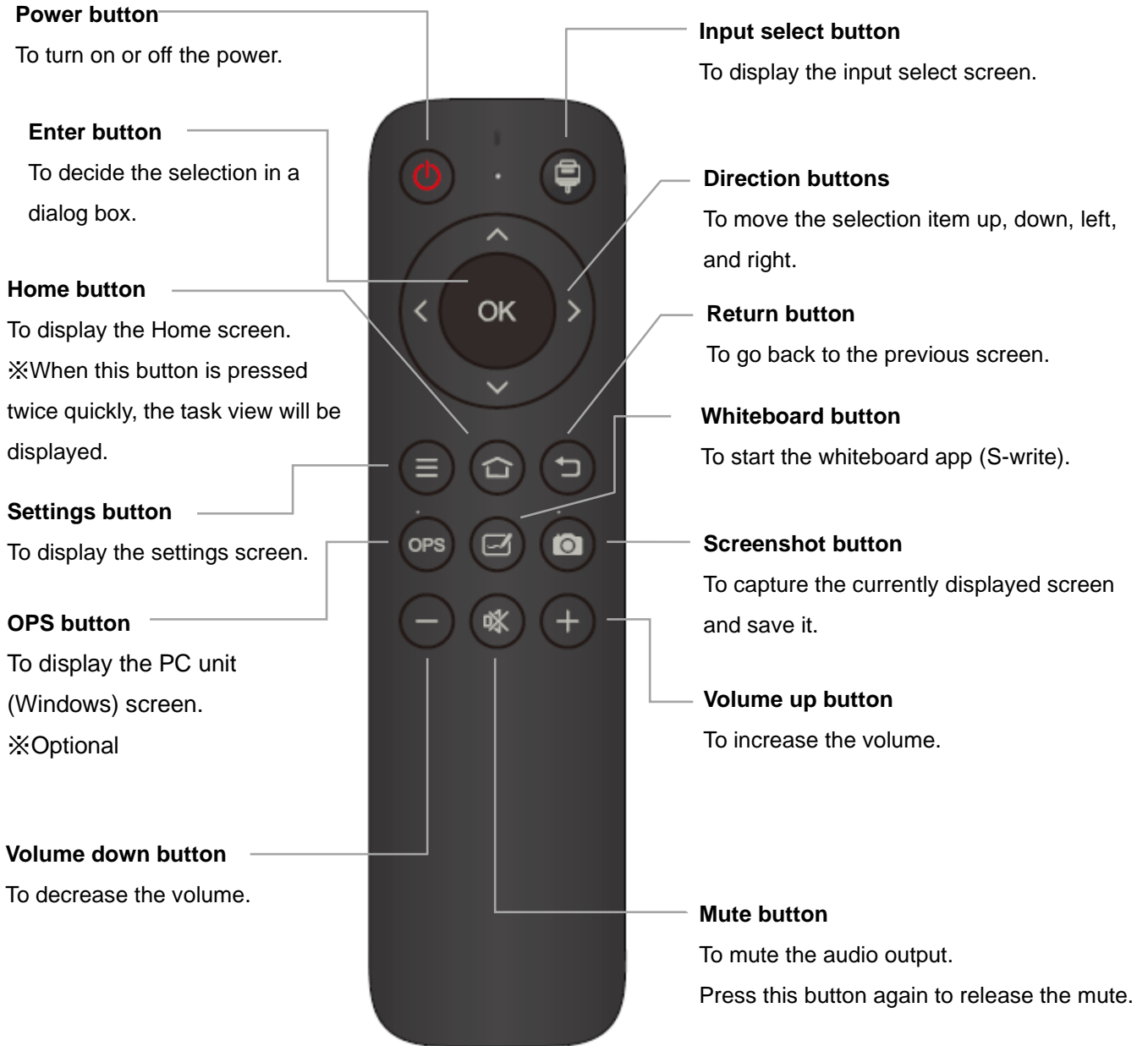

Note

The destination to save the image by the Screenshot button:

When using a USB flash drive : USB flash drive > Pictures > Screenshots

When not using a USB flash drive : Local > Pictures > Screenshots

Connecting the devices

■ Displaying the computer screen (video and audio)

Connecting via HDMI input port on the front

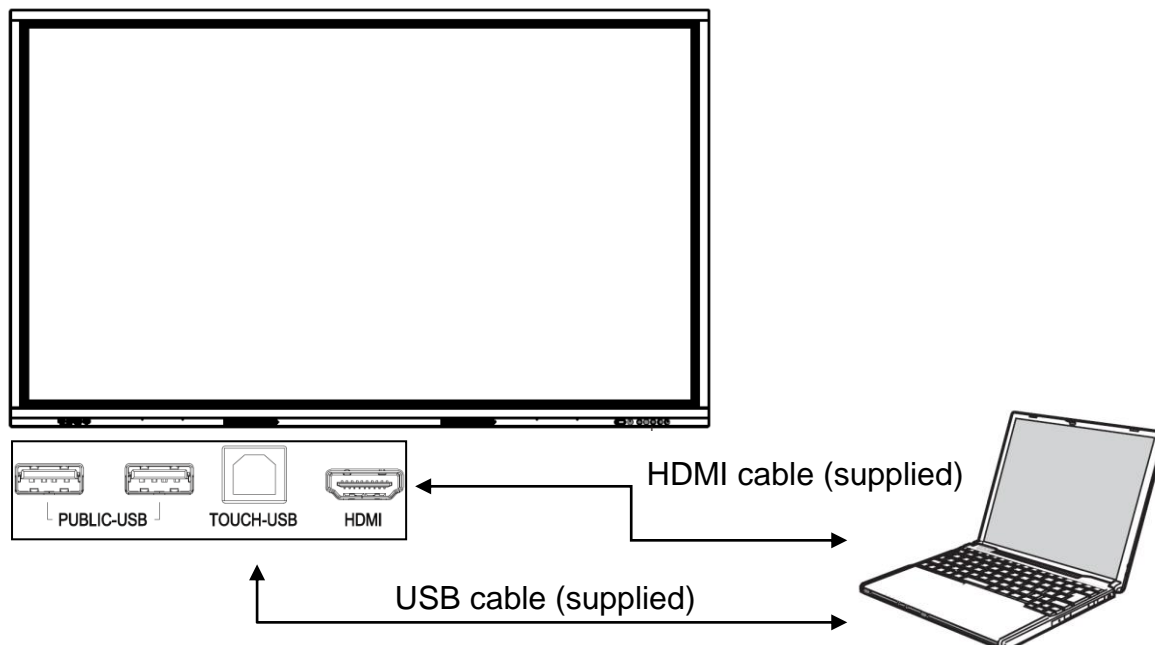

Connecting via HDMI using the HDMI input port on the side

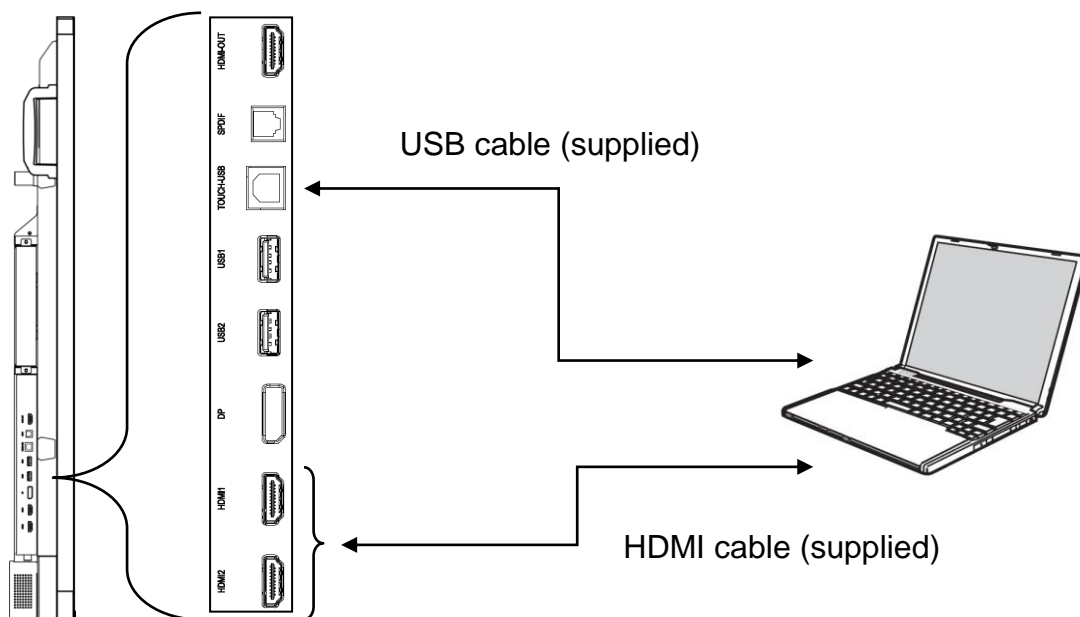

Connect one end of the HDMI cable to the HDMI input port of the monitor and other end to the HDMI output port of the computer. The computer screen will be displayed on the monitor.

Note

- When performing touch operations of the computer on the monitor, connect between the touch port of the monitor and the USB port of the computer using the USB cable.
- When using the touch port on the front of the monitor, use the HDMI input port on the front. When using the touch port on the side of the monitor, use the HDMI input port at the side.

Connecting with VGA cable and audio cable

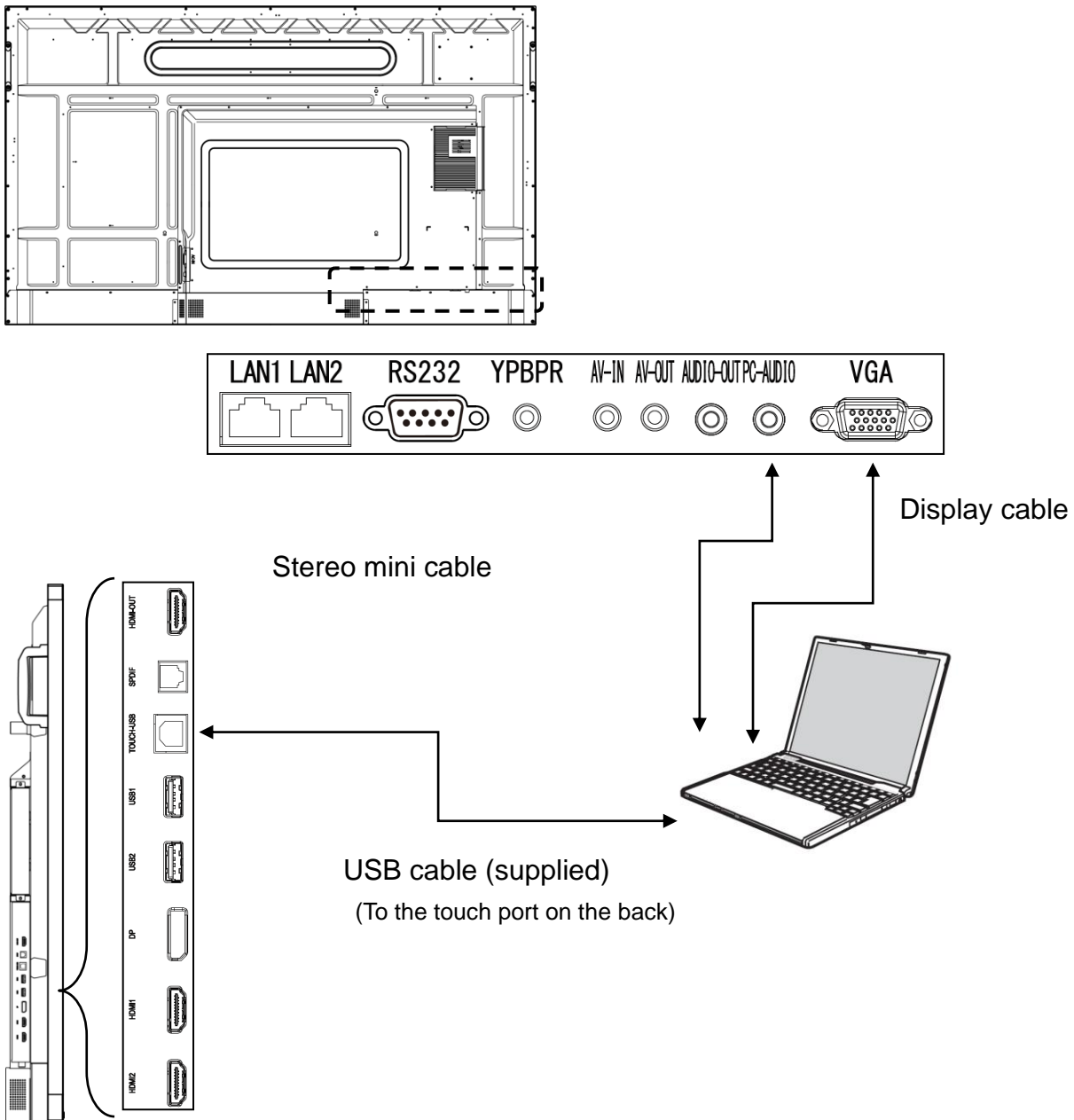

- Connect one end of the display cable to the VGA input port of the monitor and other end to the VGA output port of the computer. The computer screen will be displayed on the monitor.
- Connect one end of the stereo mini cable to the audio input port of the monitor and other end to the audio output port of the computer. The sound from the computer will be played.
- Connect the touch port on the side of the monitor and the USB port of the computer using the USB cable. You can perform touch operations of the computer on the monitor.

Note

- Make sure that the OS on the computer is currently supported and the computer meets the requirements to run the OS.
- If the displayed image is out of alignment, adjust it with "VGA automatic adjustment". ⇒P.49

■Displaying the screen of the connected device (video and audio)

Connecting with HDMI cable

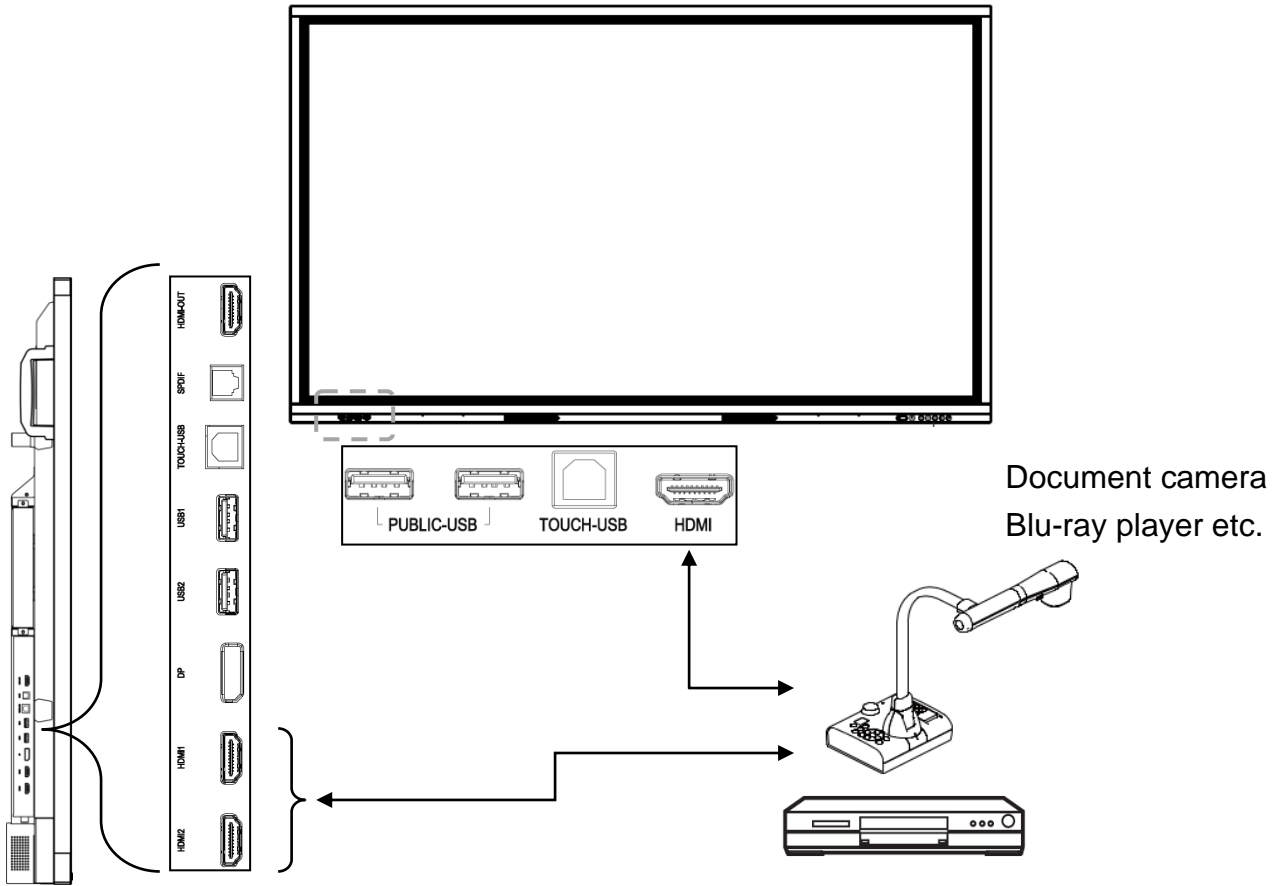

Connect one end of the HDMI cable to the HDMI input port of the monitor (front or side) and other end to the HDMI output port of the device. The image output from the device will be displayed on the monitor.

Note

- Since the HDMI cable can send both audio and video data, there is no need to connect an audio cable separately.
- Since this product emits infrared rays, a nearby remote control may malfunction.

Connecting with AV cable

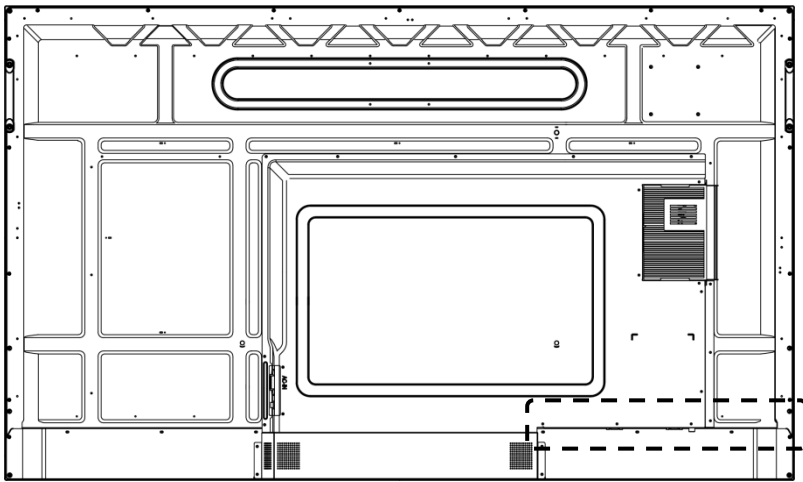

AV cable

DVD player
Blu-ray player etc.



Connect the mini plug of an AV cable to the AV input port of the monitor and RCA plug to the device. The image being output from the device will be displayed on the monitor.

■Displaying the screen of the monitor on other display monitor

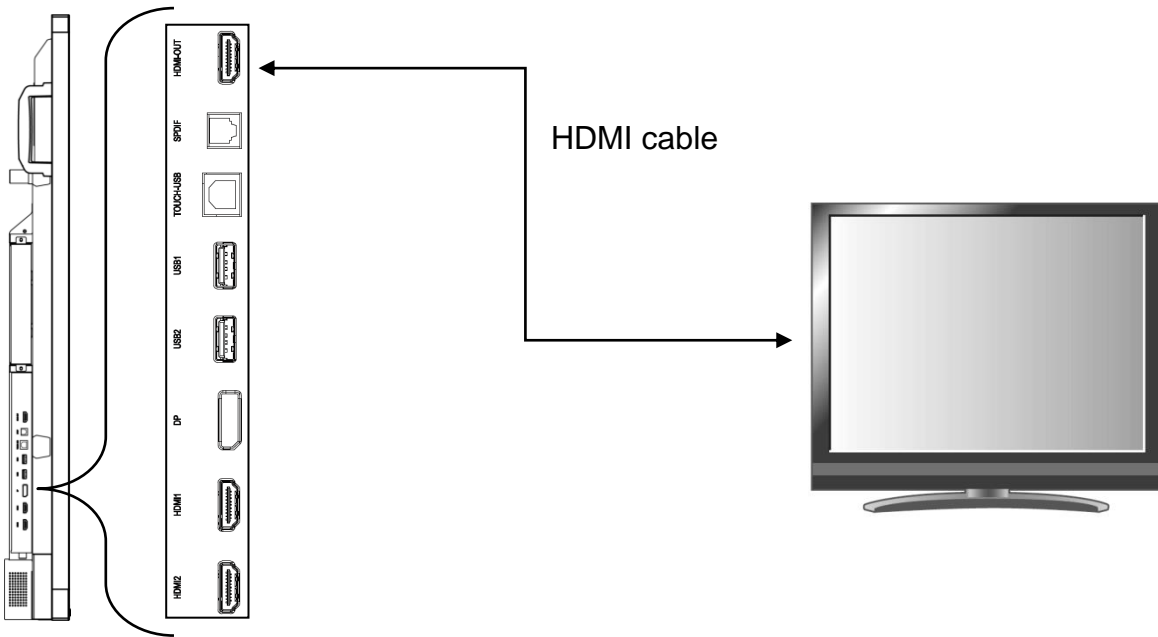

Connect one end of the HDMI cable to the HDMI input port of the connected display monitor and other end to the HDMI output port on the side of the monitor of this product. The screen image of the monitor of this product will be displayed on the connected monitor.

Note

It is necessary to set the output resolution according to the connected display monitor from the menu settings in advance.

※1920×1080(2K)/3840×2160(4K) ⇒P.50

■Playing the sound on other device

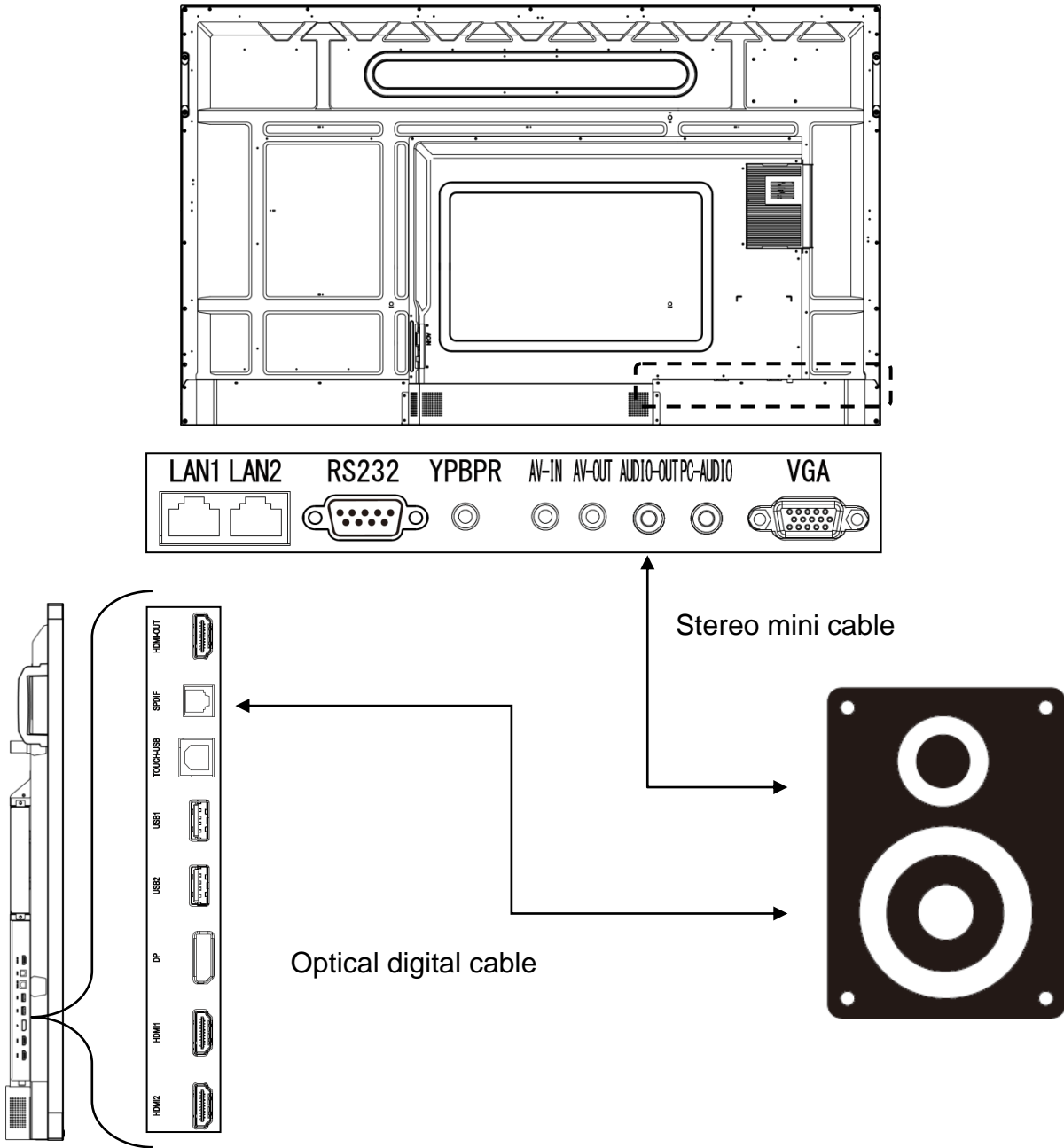

- Connect between the optical digital audio out port (SPDIF) on the side of the monitor or the audio out port on the back of the monitor with the input port of an audio device. The sound from the product will be delivered to the device.

■Controlling the product from a computer (serial control)

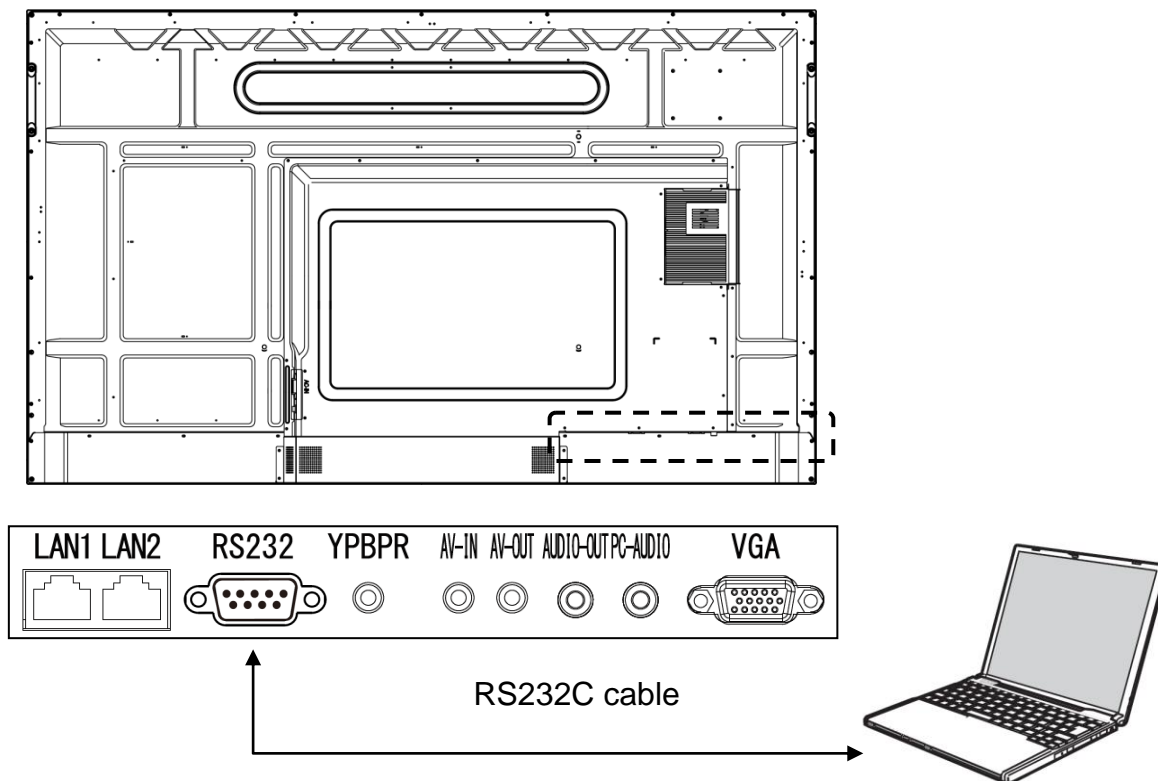

By connecting the RS232C port of the monitor with the RS232C port of a computer, you can control a part of the functions of the product.

Connecting to the network

■ Connecting via WiFi

This product can be connected to the network via WiFi.

WiFi setting can be configured by the Settings button on the front or the Settings app. ⇒P.52



Note
If there is no obstruction, the maximum WiFi distance will be 10m.

■ Connecting via LAN

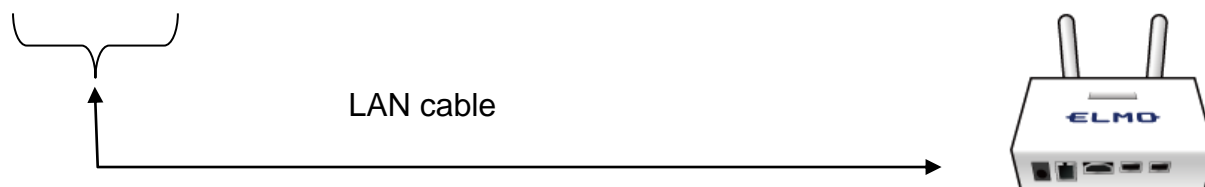
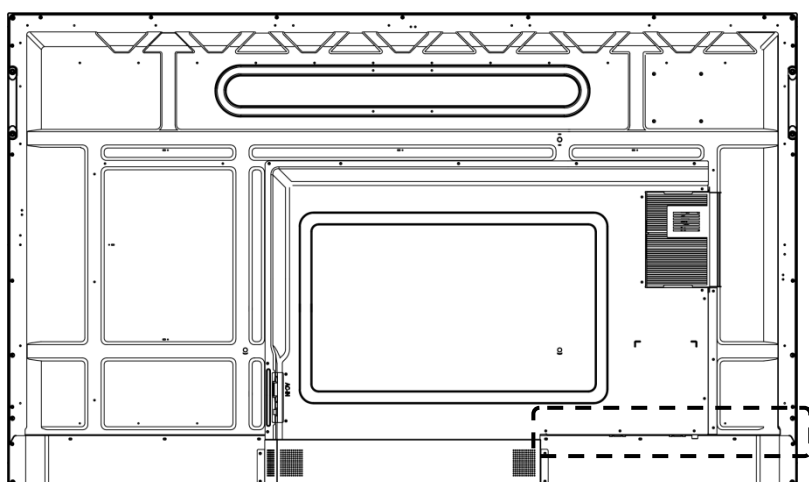

Use a LAN cable to connect the network port on the back of the product to the LAN port of the hub or router.

Network settings can be configured from the "Settings button" on the front or the Settings app.

For details of the network settings, consult with your network administrator.

Connecting via Bluetooth

Using the Bluetooth feature of the product, it is possible to connect to a keyboard or mouse that supports Bluetooth.

⇒P.57

Bluetooth settings can be configured from the "Settings button" on the front or the Settings app.

A list of available devices will be displayed by pressing "Bluetooth" in [].

For details of the settings of the connected device, refer to the instruction manual of the respective devices.

Note

The maximum connection distance via Bluetooth is 10m without obstruction.

Connecting the power cord

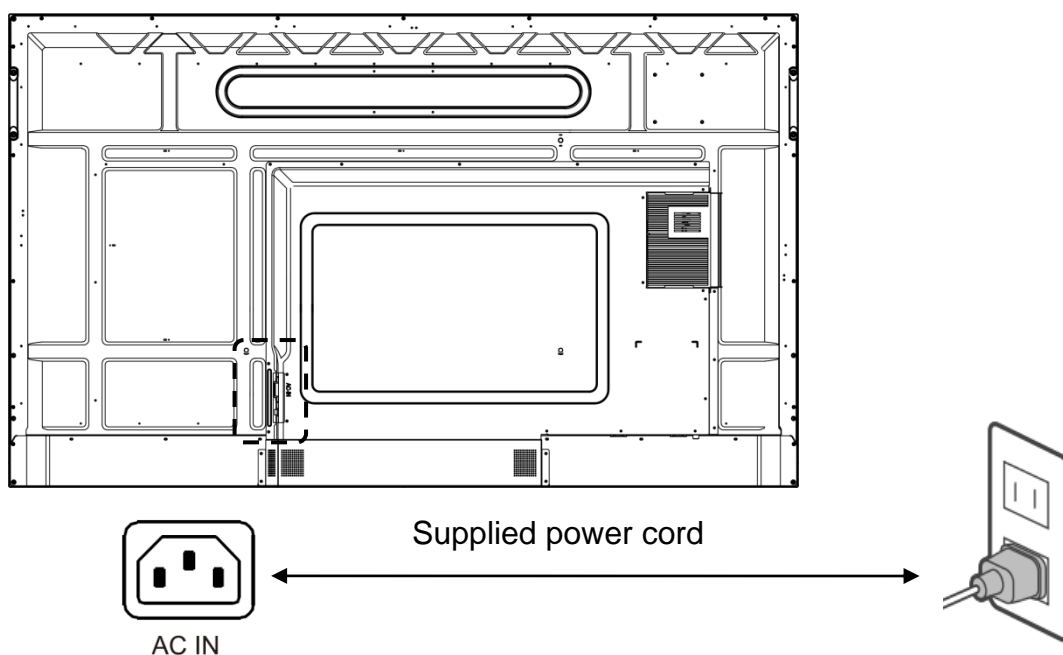

Connect the supplied power cord to the power supply socket at the back and plug into an outlet.

Caution

- The type of the power cord varies depending on the country.
- The type of the power cord varies depending on the country.
 - For the American market : Do not use the power cord with JP tape attached except in Japan.
 - For the European market : Use the power cord usable in your country.
- Always use the supplied power cord.
- Be sure to connect the ground.
- Be sure to connect the ground before connecting the power plug to an outlet.
- Be sure to remove the power plug from the outlet when removing the ground.

Turning on or off the product

■Turning on

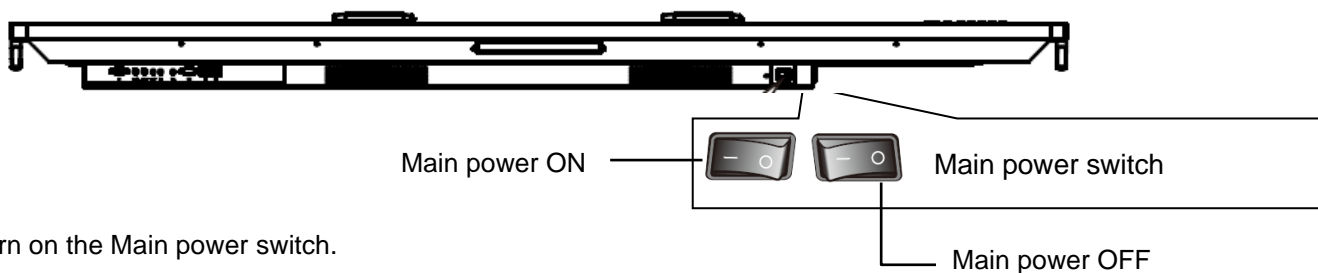

- 1) Turn on the Main power switch.
- 2) Short-press the Power button on the front or on the remote control.

Initial startup

At initial startup, the Settings screen appears in the order of "Language settings" "Network settings" "Date and Time settings".

Settings after "Language setting" can be skipped by pressing "Skip all" or "→" icon.

Language setting, Network setting and Date and Time setting can be reset. ⇒P.52 – P.56

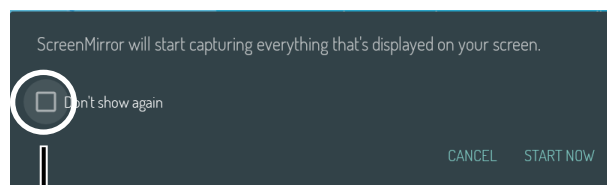
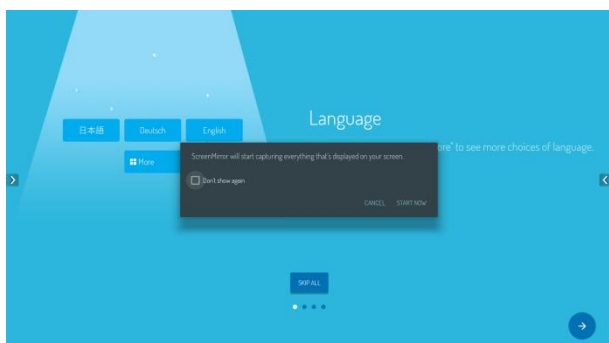

To prevent this screen from being displayed in the future, check here and press "START NOW".

Language setting

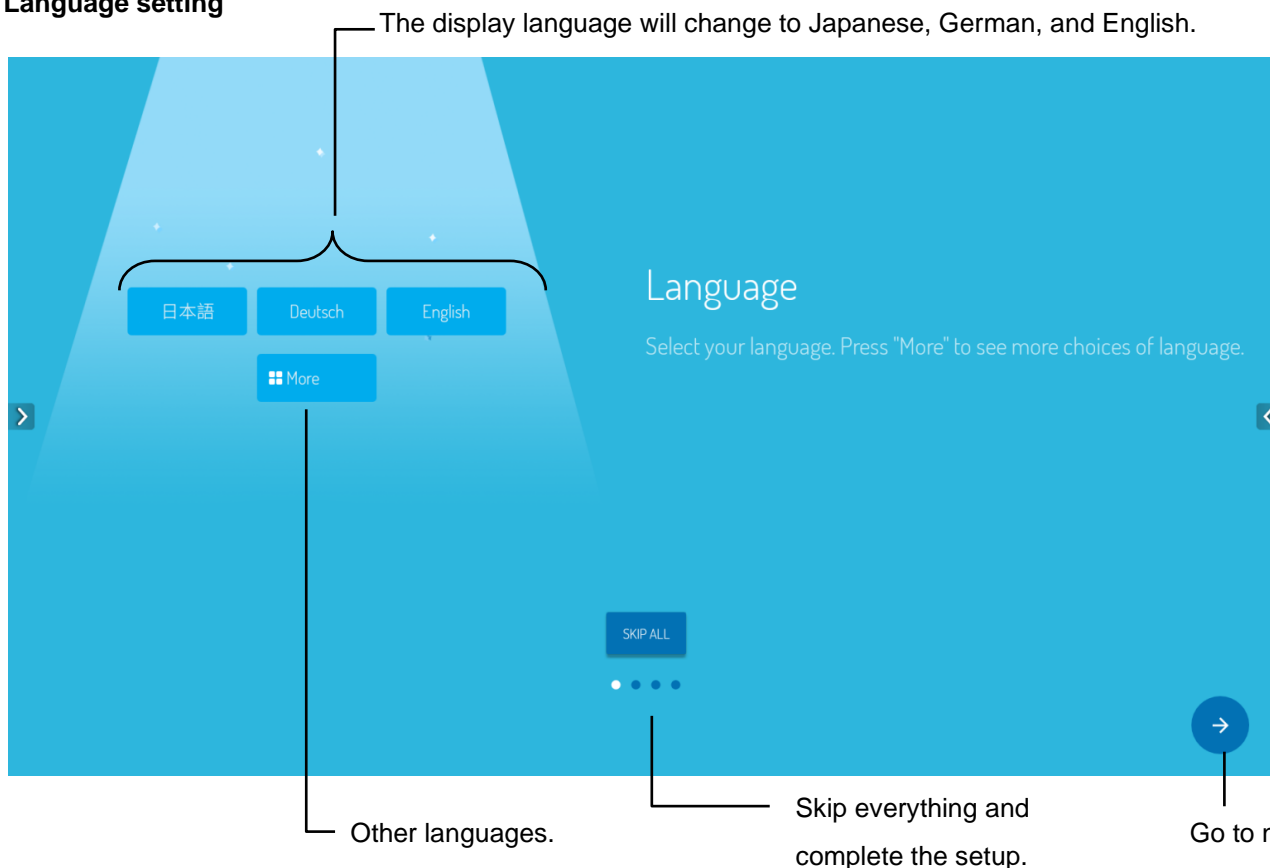

Network setting

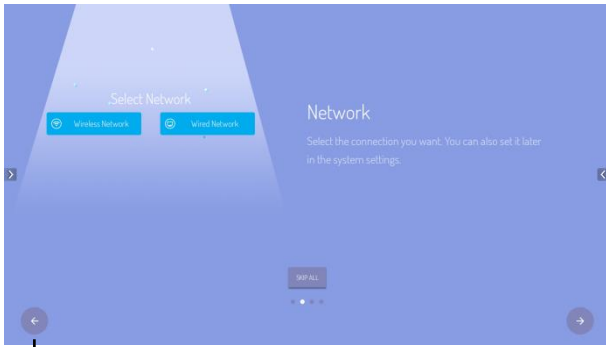

Go back to the previous page.

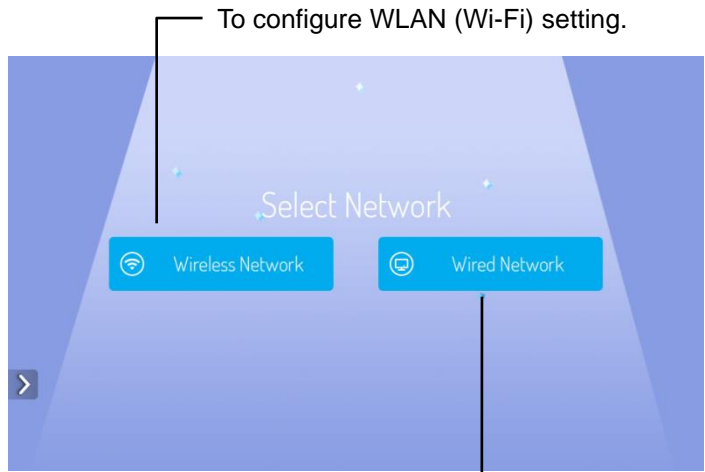

To configure the Ethernet settings.

Automatic time setting / 24-hour display setting

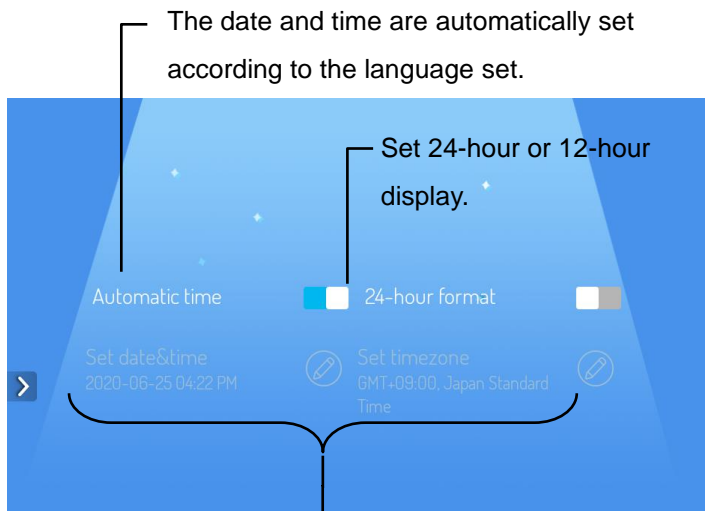
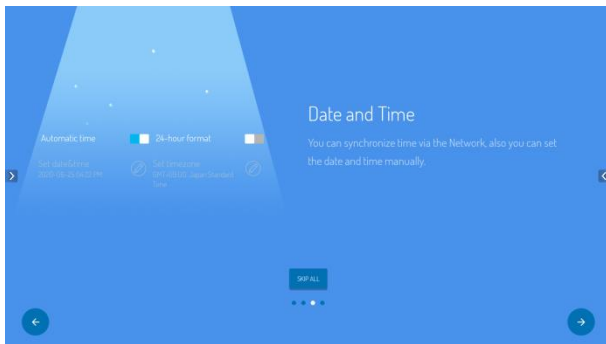

Configure these settings when the Automatic time setting is OFF.

Complete the configuration

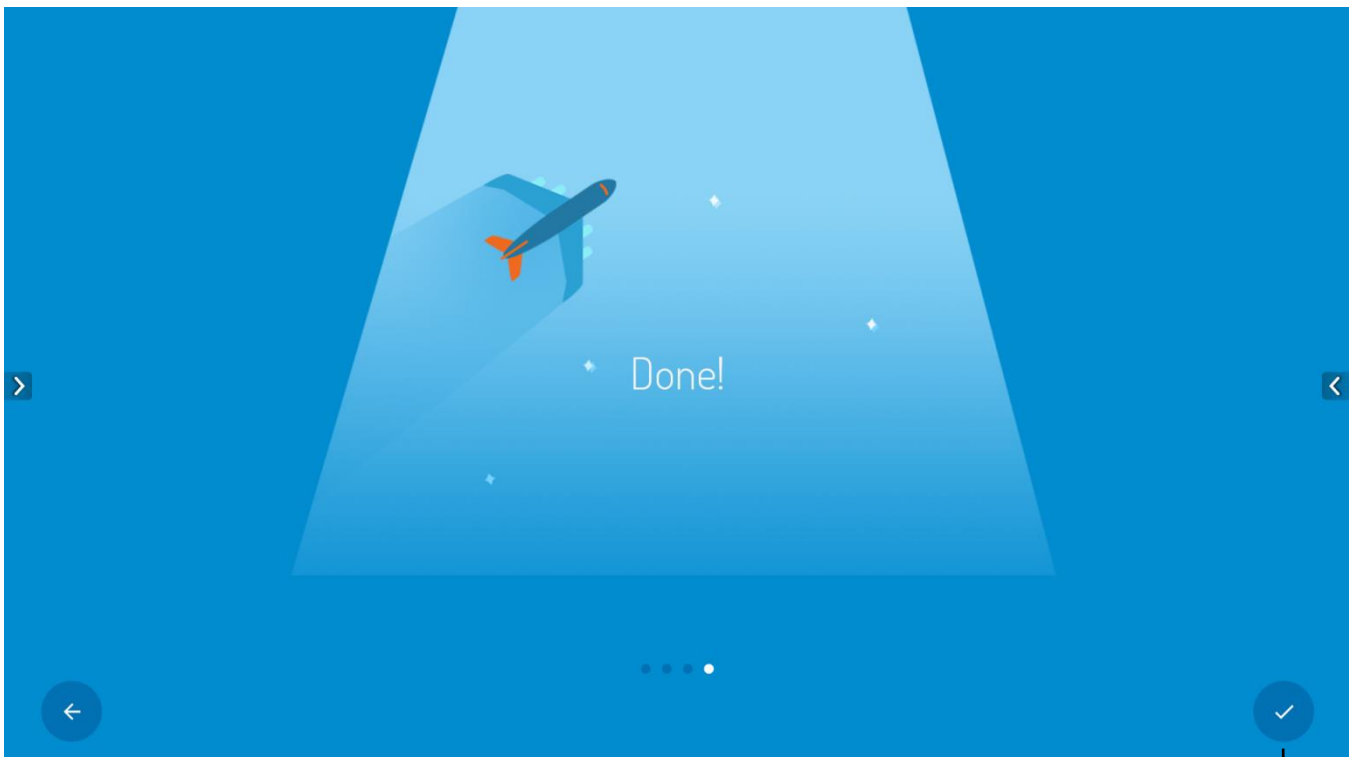

Click here to complete the configuration.

■Turning off

- 1) Long-press the Power button on the front or short-press the Power button on the remote control. The Shutdown confirmation dialog box will be displayed.
- 2) Select "Shutdown". (If you want to cancel, select "Cancel".)
- 3) Turn off the Main power switch on the back.

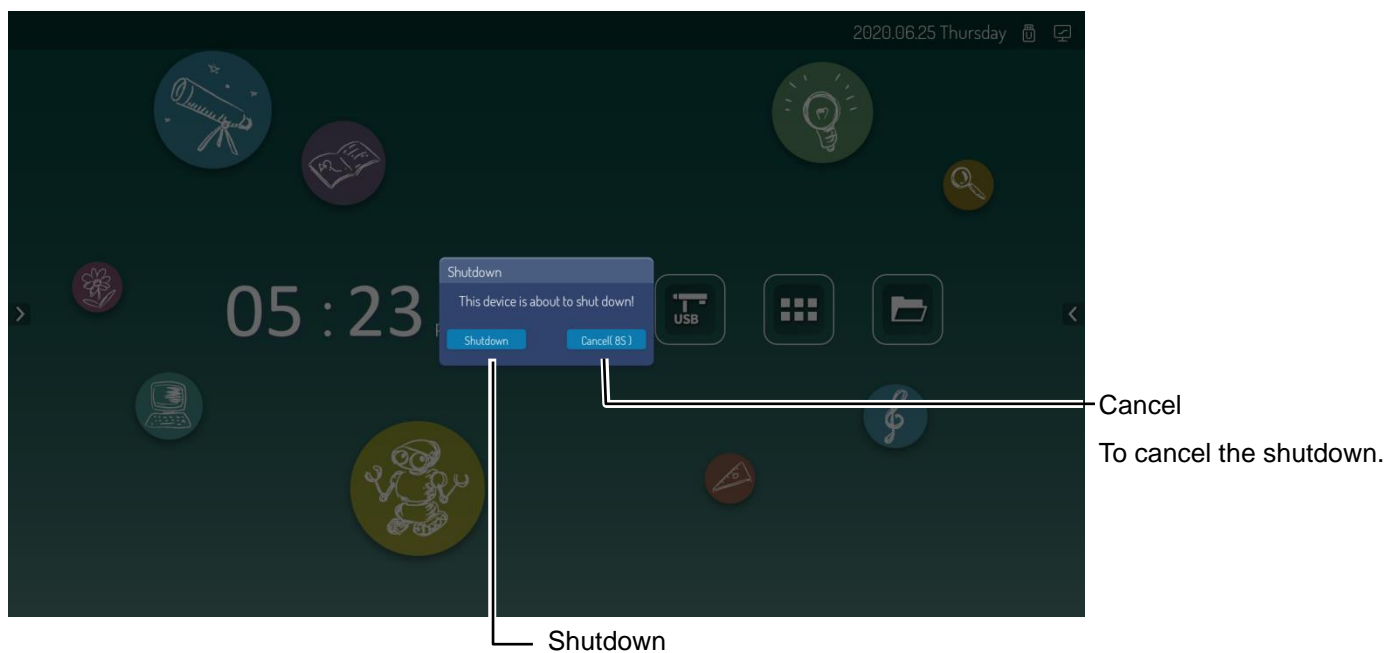

Caution

- Do not turn off the Main power switch before shutting down the product. Doing so may cause a malfunction.

Standby mode

Press the Power button on the front to enter the Standby mode.

Note

- It is not possible to enter the Standby mode from the remote control.
- The Power LED turns green in the Standby mode.

Touch operations

You can perform touch operations with your finger or the supplied touch pen.

For details on Windows touch operations, refer to Windows Help.

Single tap

Touch once briefly.

※Works as the left click of a mouse.

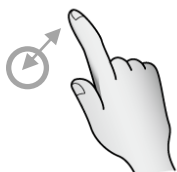

Double tap

Touch same place twice quickly.

※Works as the double click of a mouse.

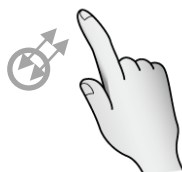

Long-press

Touch and hold.

※Works as the right click of a mouse.



Drag and drop

Touch and hold the icon or slide and move it. Then release the finger at the specified position.

※Works same as the drag and drop by a mouse.

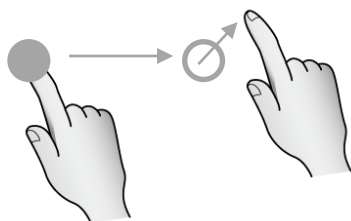

Swipe / Flick

Swipe: Move the finger while touching the screen.

Flick: Touch the screen and brush the finger quickly across the screen.

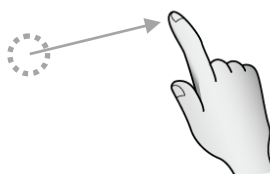

2-finger press

The popup menu (floating menu) will be displayed.

※The distance between two points should be 2-5 cm.



Zoom out

Touch two points at the same time and move fingers closer to each other.

※To be used in the screen where zooming operation is possible.

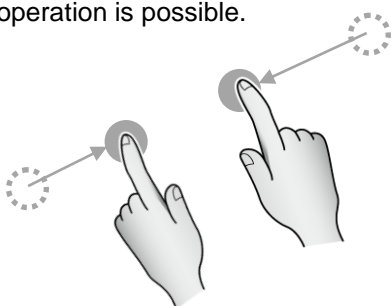

Zoom in

Touch two points at the same time and move fingers away from each other.

※To be used in the screen where zooming operation is possible.

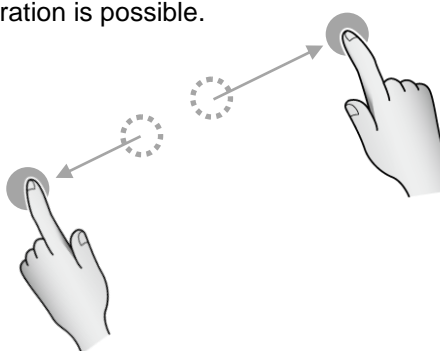

Touch pen

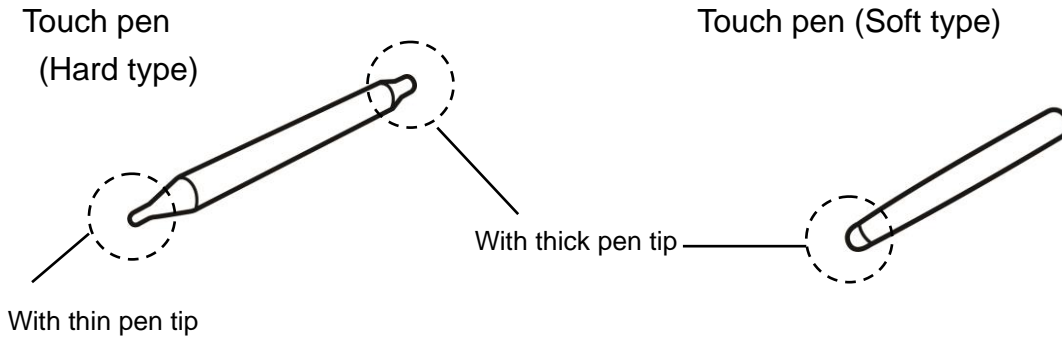

The supplied Touch pen can be placed in the touch pen holder at the front.



Note

- If you place your finger near the tip of the touch pen, Malfunction may occur.
- If you use the thick pen tip away from the touchscreen, it may be recognized as a thin pen tip.
- Do not press the pen tip anywhere other than the screen. It may not work properly.
- When using multiple touch pens, touch positions and pen information may be swapped, and line breaks may occur.
- If the pen tip becomes worn or damaged, replace the touch pen.
For purchasing a touch pen, contact the dealer where you purchased the product.
- Do not place anything other than the supplied touch pen at the pen storage of the product.
- The supplied touch pen has a built-in magnet. Keep the pen away from watches or magnetic cards.





Basic operations

■ Home screen

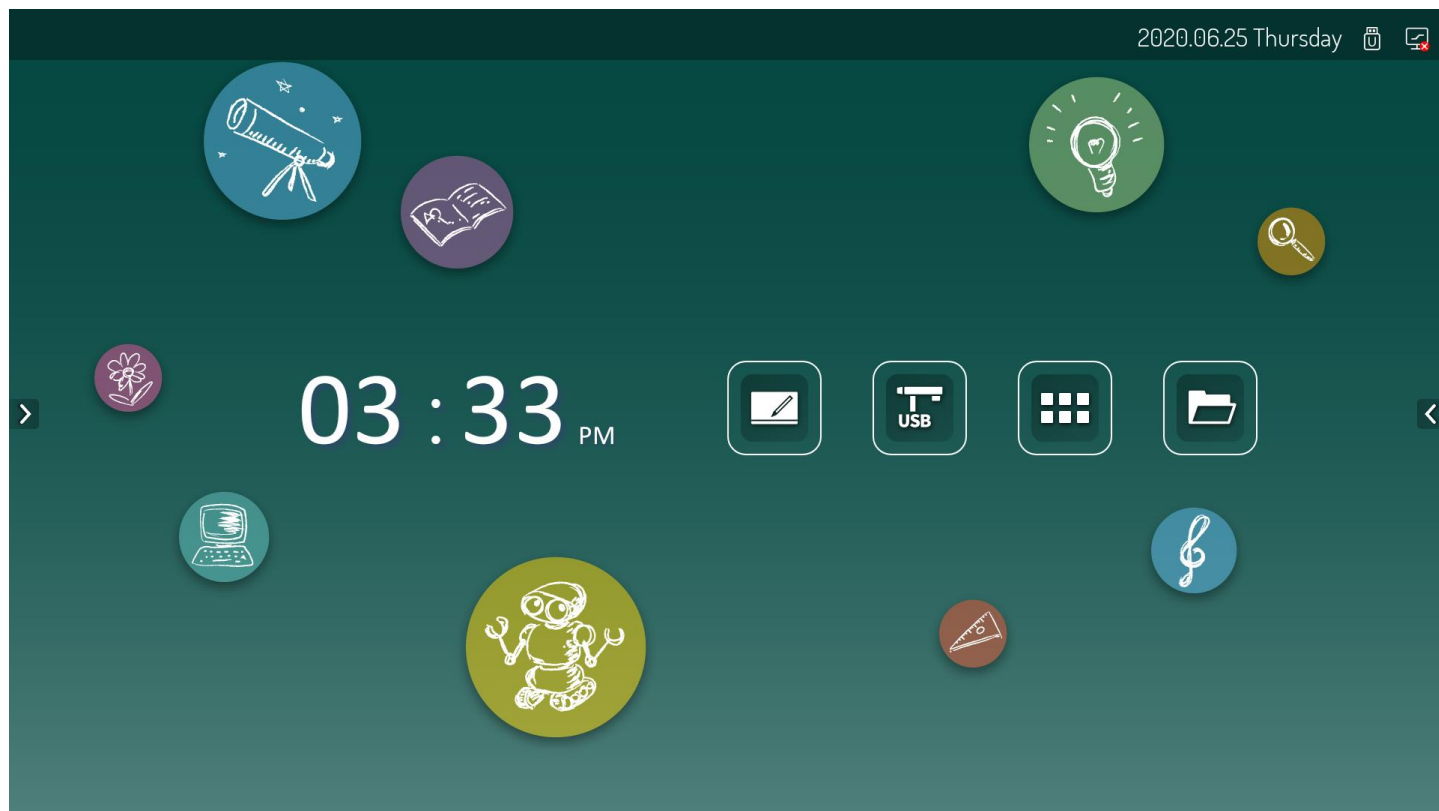
The Home screen will appear when the power is turned on.

The Home screen of this product is from Android built in the product.









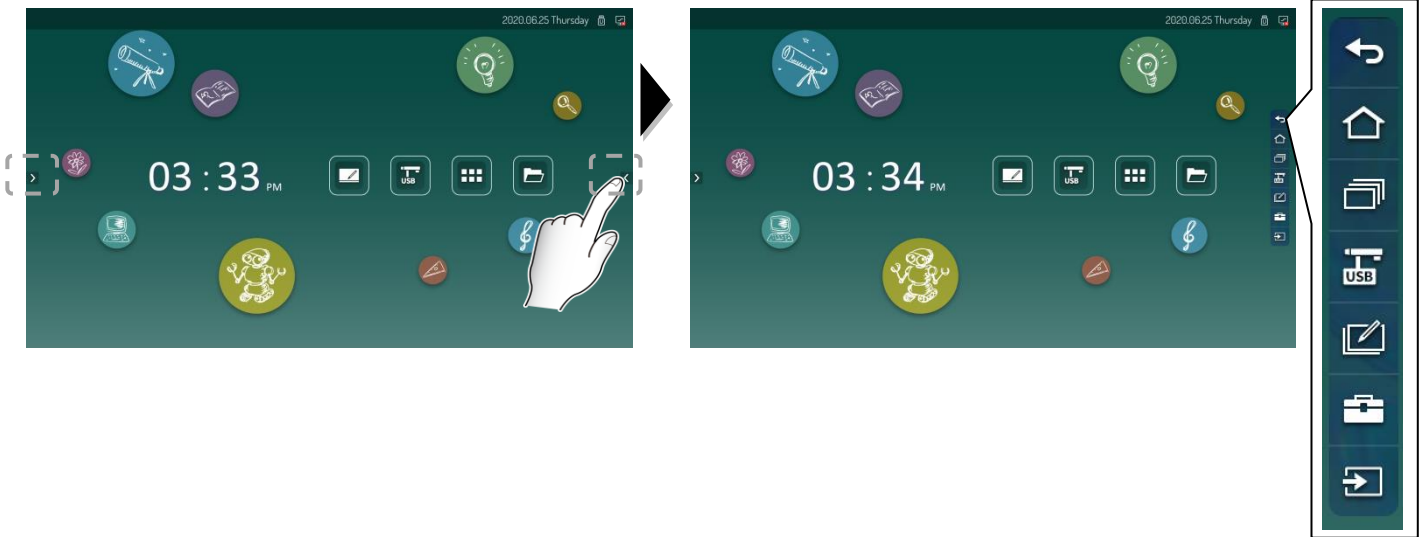

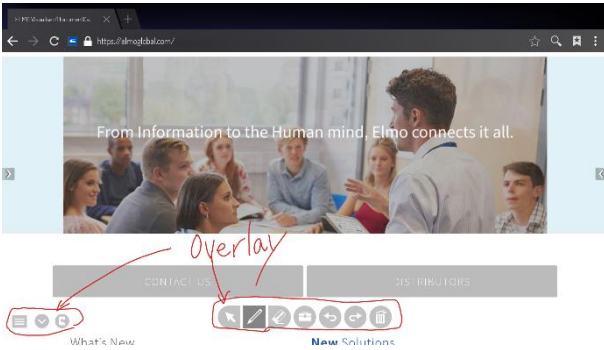

	Whiteboard	To start the whiteboard app “S-write” ⇒P.33 You can use the screen as a whiteboard or blackboard.
	USB camera	To start the USB camera app. ⇒P.41 You can display the image from the camera connected to the USB port of the product.
	List of apps	To display a list of apps installed on the product. ⇒P.32
	File	To start the file app. ⇒P.37 You can open the file in the product or in the USB flash driver connected to the product.

■Displaying the side menu bar

Touch [] on either edge of the Home screen to display the side menu bar.



	Return	To go back to the previous screen.
	Home	To display the Home screen. ⇒P.29
	Task view	To display a list of screens once displayed. Input sources are also displayed as tasks, to switch the source.
	USB camera	To start the USB camera app. ⇒P.41 You can display an image from the camera connected to the USB port of the product.
	Overlay pen	To start the Overlay pen app. You can draw on the web page or external video. 
	Tool box	 Screenshot function ⇒P.50 To take a picture of the selected part of the screen and save it to the following folder. Folder> Pictures> Screenshots  Memory cleaner To delete unnecessary data and increase the memory space.  Countdown function ⇒P.51 To set the timer to count down and up.
	Input source select	To display an image of the input source. ⇒P.47

■Displaying the floating menu

Press two points on the screen for long to display the floating menu. (Floating menu is disabled by default.)

The floating menu can be enabled by the following procedure:



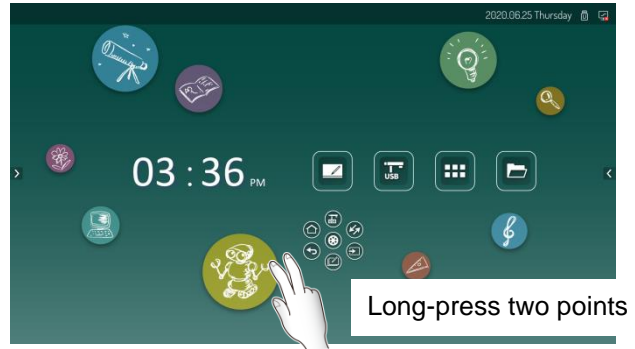





Settings > Lock control > Gesture switch > Turn on the Floating menu switch ⇒P.55-P.56



		USB camera	To start the USB camera app. ⇒P.41 You can display an image from the camera connected to the USB port of the product.
		Home	To display the Home screen. ⇒P.29
		Return	To go back to the previous screen.
		Overlay pen	To start the Overlay pen app. You can draw on the web page or external video.
		Input source select	To display an image of the input source. ⇒P.47
		Menu select	To switch between menu screens of a floating menu.
		Minimize	To minimize a floating menu.
		Re-display	To display a floating menu again.
		Screen lock	To lock the screen. Enter a password to release the lock. Default password : 888888
		Screenshot	Screenshot function ⇒P.51 To take a picture of the selected part of the screen and save it.
		Memory cleaner	To delete unnecessary data to increase memory space.
		Task view	To display a list of screens once displayed. Input sources are also displayed as tasks, to switch the source.
		Backlight	To adjust the backlight. (0~100)
		Volume control	To adjust the volume.

■ Opening list of apps



	Browser	To access the Internet through the browser. ⇒P.40
	WPS Office	To create/view/edit/save Office files and browse PDF files.
	ELMO Play	To install apps from the ELMO portal site. ⇒P.46
	Search app	To start Google search.
	Screen Mirror (Transcreen)	To cast the screens of other devices such as a tablet. ⇒P.43
	File	To start the file app. ⇒P.37 You can open the file in the product or in the USB flash driver connected to the product.
	USB camera	To start the USB camera app. ⇒P.41 You can display an image from the camera connected to the USB port of the product.
	Settings	To display the Settings screen to configure various settings. ⇒P.52
	Whiteboard	To start the whiteboard app “S-write” ⇒P.33 You can use the screen as a whiteboard or blackboard.

Note

- Some functions of the pre-installed WPS Office may not work.
When displaying a document created on a computer with this product, the layout may collapse.

Using the whiteboard app (S-write)

You can annotate on the screen like a whiteboard.

■Startup

Tap the "Whiteboard app (S-write)" icon on the Home screen or in the list of apps.

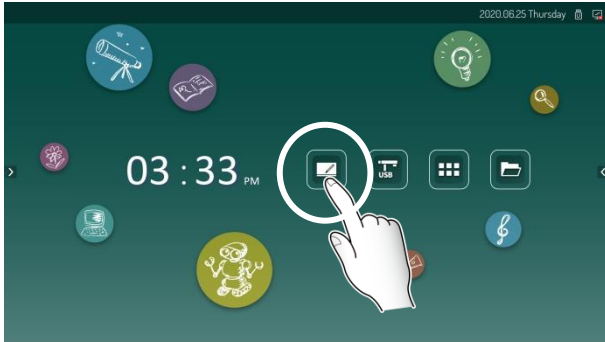

■Screen

Menu button
To open the menu.

To hide the menu bar.

Finish
• Cancel
• Save
• Do not save

Operation
To pan and zoom the whole area.

Pen
To draw free-hand lines.

Eraser
To delete lines and objects.

Select
To select an object on the screen.

Shapes
To draw various shapes.

Background
To change the background color and square shape.

Add page

Page operation

Tool box
To call the split screen and image addition functions.

Document camera mode
To display the image from the Document camera connected to the product.

Clear all
To delete all the drawings and shapes.

Cancel undo
To cancel the undo operation.

Undo
To undo the last operation.

Note

- To delete the added page, double-tap the page number in the center of the page operation to display the page list, and tap "x" at the top left.
- When "Finish" is tapped, the following options will be displayed: "Cancel" (cancel the finish) "Save" or "Do not save"

■ Drawing and erasing

Drawing lines and shapes

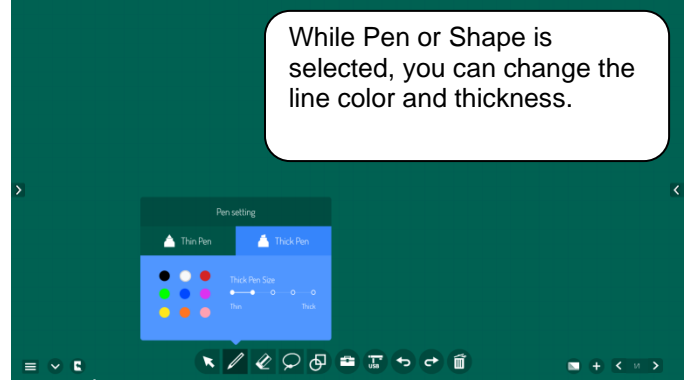
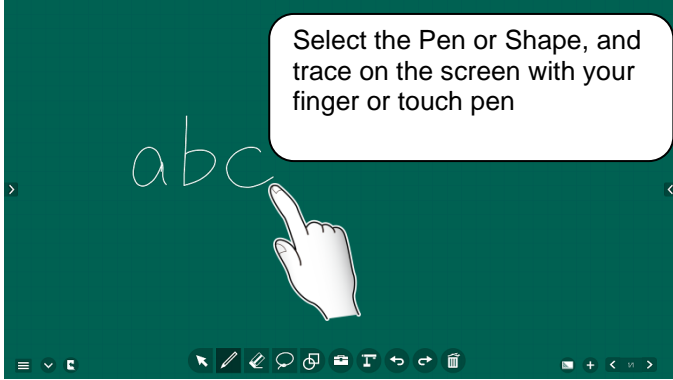

Erasing lines and shapes

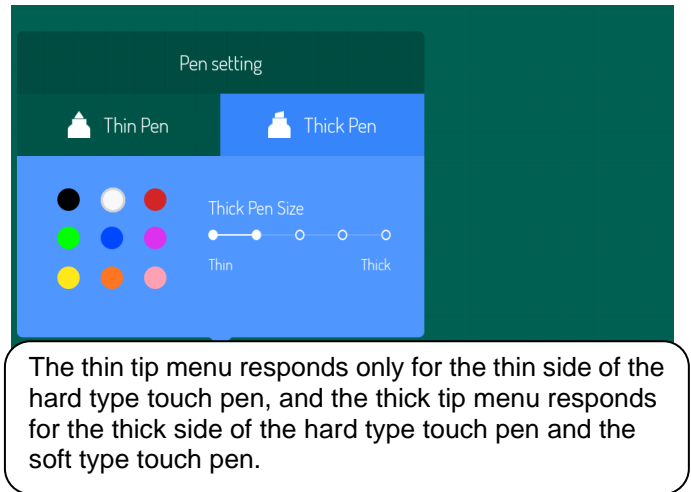
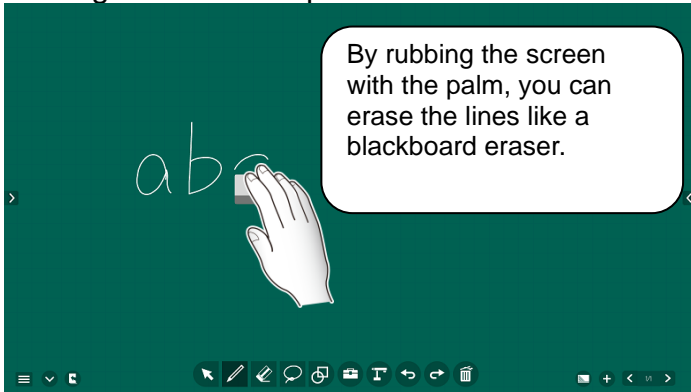

■ Select mode

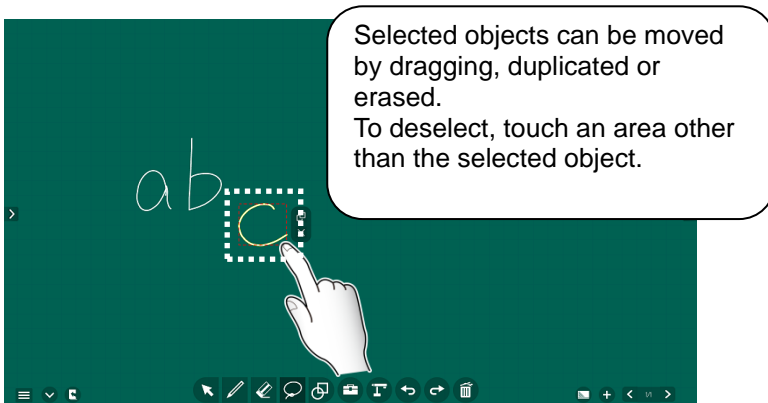
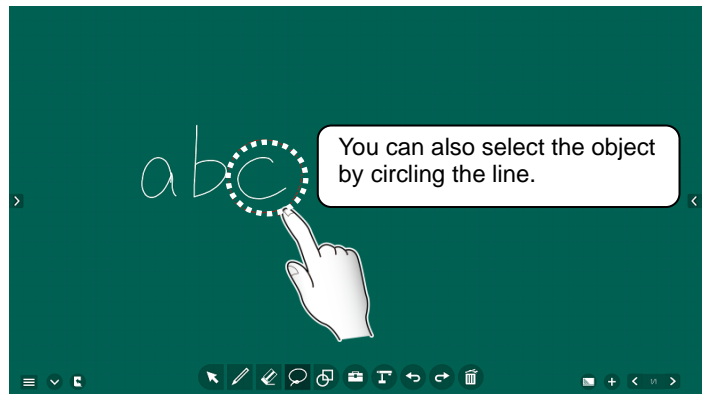
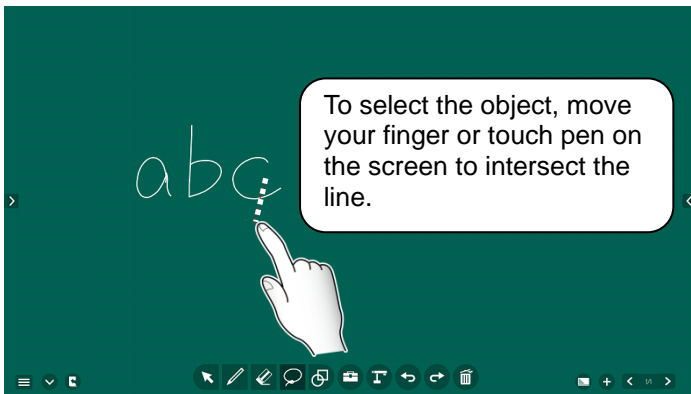

■Eraser mode

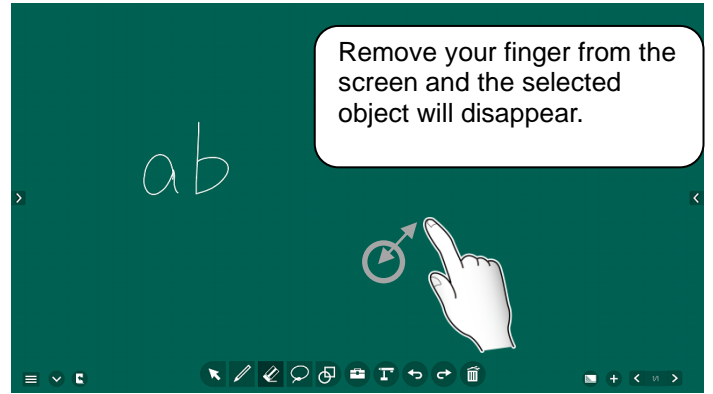
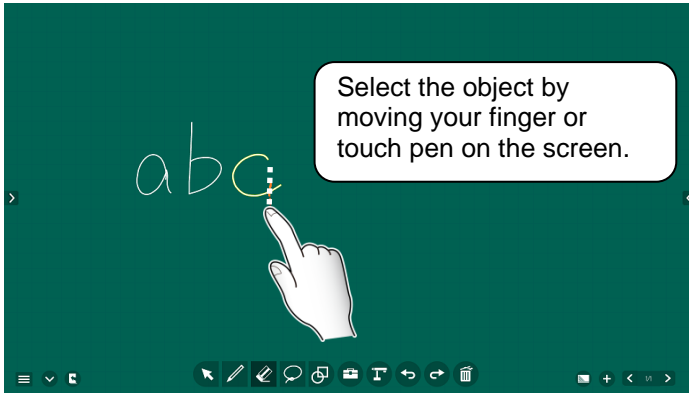

■Saving and reading data

You can save the image to the note or open the data saved in the note.

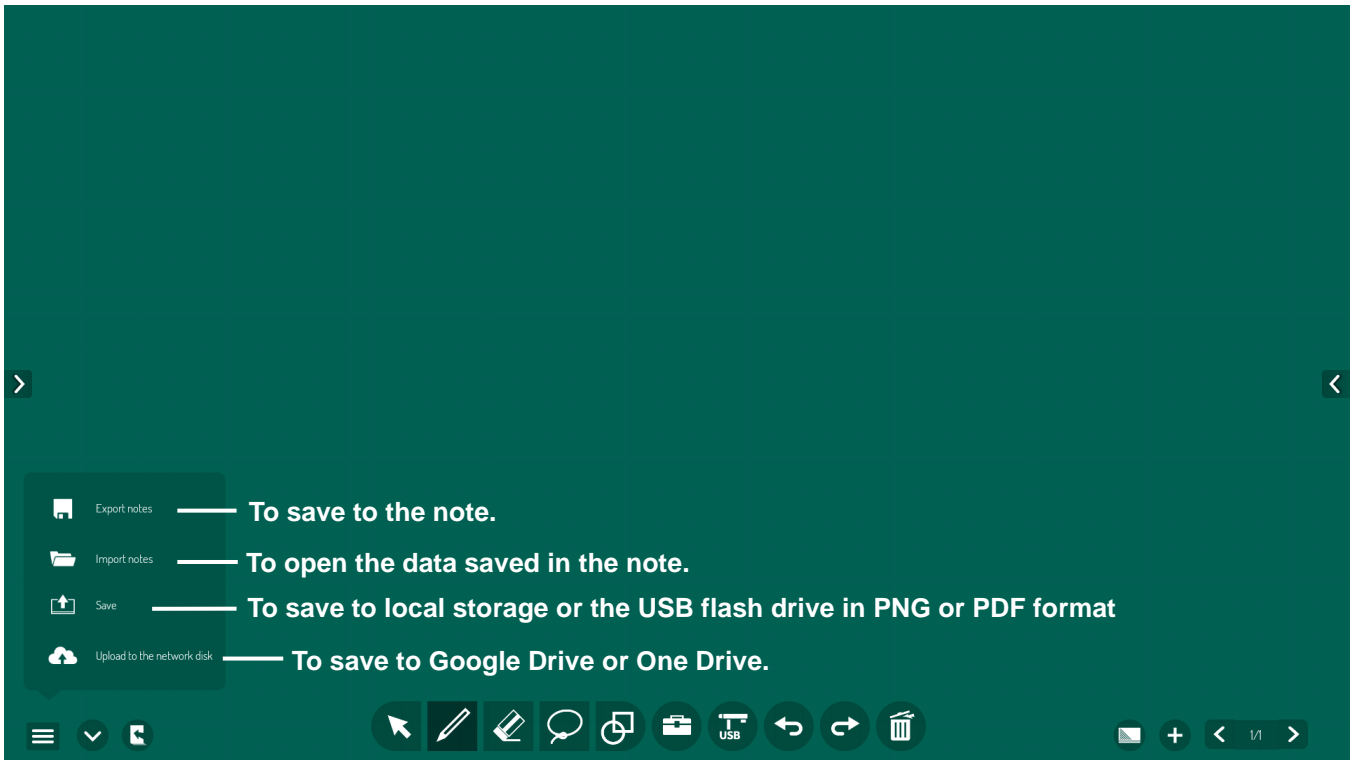

Save destination

Note : Pictures > note

Local storage : Pictures > White Board > PNG or PDF

USB flash drive : Pictures > White Board > PNG or PDF

Note

- The following 9 characters cannot be used.
「 < > : * ? " / ¥ | 」
- When “Export notes” is selected, the currently displayed page will be saved.

■ Import picture and split screen

(simultaneous drawing with multiple users)

In the Split screen mode, multiple users (2 or 3 users) can draw or delete lines on the screen at the same time.

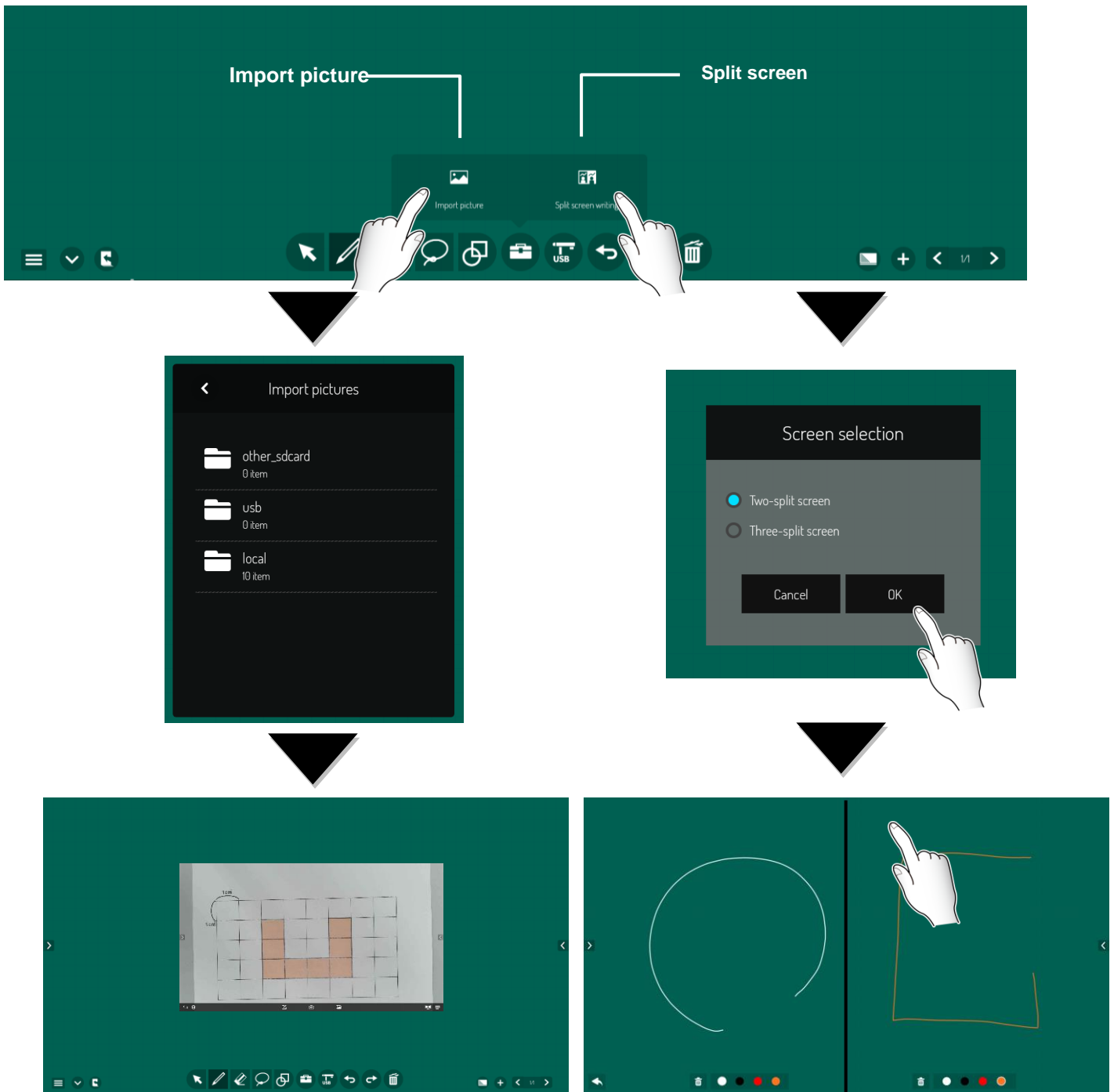

Select a folder to open the saved image, and paste it.

The screen will be split. (Split screen mode)

Browsing the files

You can browse the files saved in the product and the files in the USB flash drive connected to the product.

■ Starting the File app

Tap the File app icon on the Home screen.

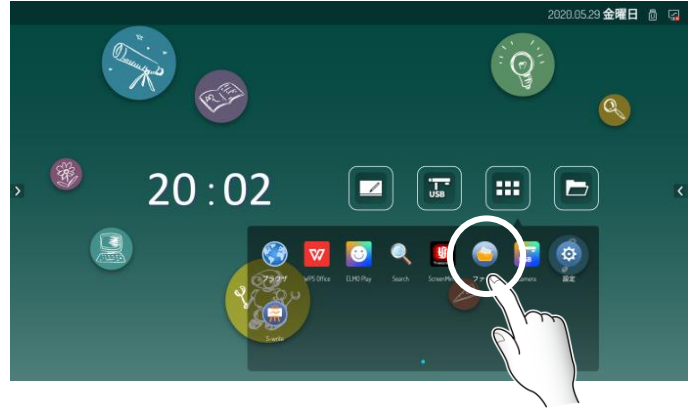

■ Operating the File app

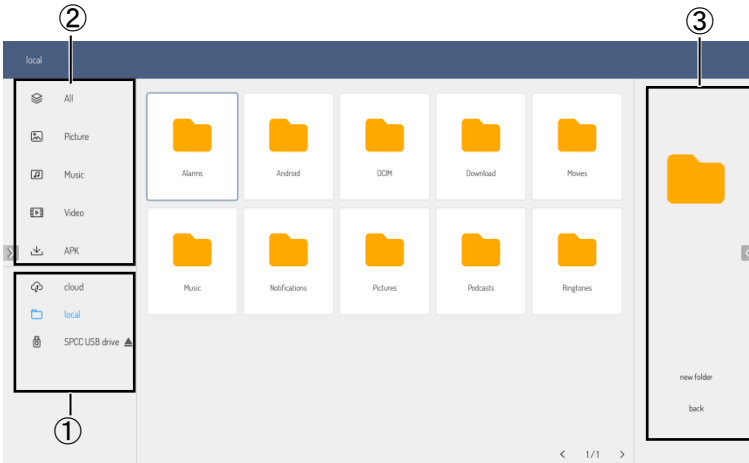

①	Select the media to browse.	
	Cloud	To browse Google Drive and One Drive.
	Local	To display the files in the product.
	USB	To display the files in the USB flash drive.
<div style="border: 1px solid black; padding: 5px; margin: 10px 0;"> <p>Caution</p> <p>Be sure to disconnect the USB flash drive after touching [].</p> </div>		
②	Select the file type.	

③	Perform file operations or folder operations.							
	<ul style="list-style-type: none"> • In normal situation: <table border="1" style="margin-left: 20px;"> <tr><td>New folder</td></tr> <tr><td>Return</td></tr> </table> • When file is selected: <table border="1" style="margin-left: 20px;"> <tr><td>Copy</td></tr> <tr><td>Delete</td></tr> <tr><td>Cut</td></tr> <tr><td>Change name</td></tr> <tr><td>Upload</td></tr> <tr><td>Return</td></tr> </table> <p>※Tap the File icon long to enter the File select mode.</p> <p>※To exit the File select mode, select [Return].</p>	New folder	Return	Copy	Delete	Cut	Change name	Upload
New folder								
Return								
Copy								
Delete								
Cut								
Change name								
Upload								
Return								

■Connecting to the server

1. Select "Cloud Storage" in the left menu of the "Folder" app.
A selection screen (Google Drive or One Drive) will be displayed.
Select the cloud service to use.

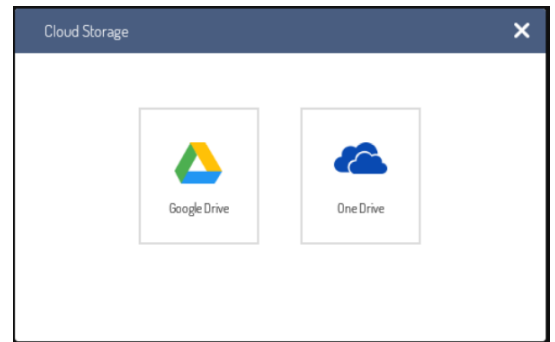

2. The screen on the right will be displayed.
Tap "+" to register the cloud account.

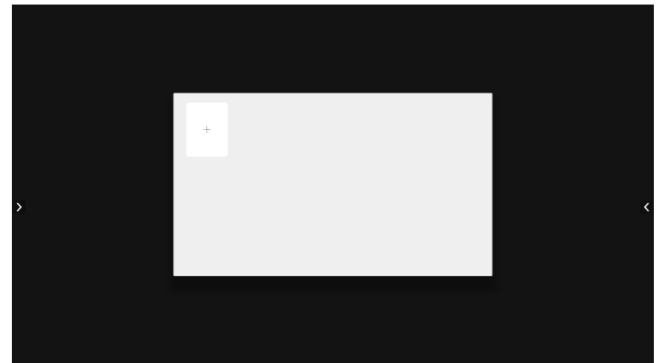

3. Proceed with the login process according to the instruction displayed on the browser.

(The following is an example of Google Drive login process.)

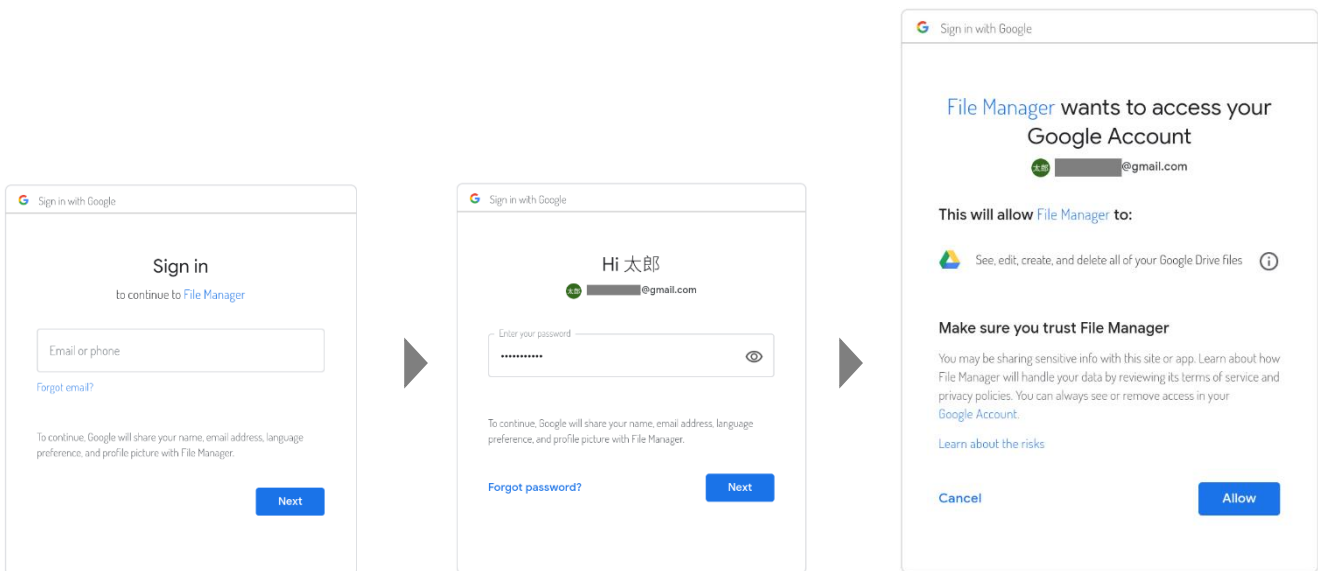

Note

Two-step verification may be required depending on the account settings

4. After successfully logged in, you can browse the folder in the cloud storage.

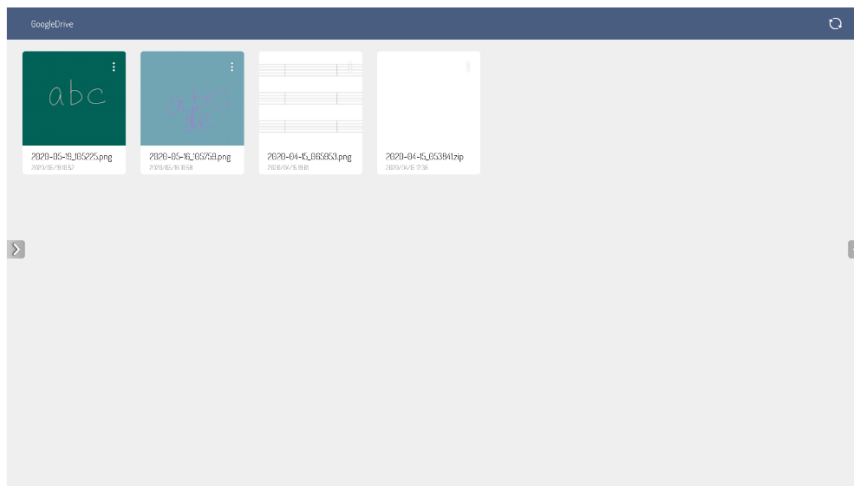

Press [] on the remote control or [] in the side menu bar to exit from this screen.

5. From next time onwards, select the registered account to access the server.



If you want to delete the registered account, long press the account to delete.

Note

As specifications may be changed by cloud service providers, we do not guarantee the continuous use of this function.

Browsing the website

In order to browse the website, you need to connect the product to the Internet.

■ Starting the Browser app

Tap the Browser app icon on the Home screen.



■ Operating the Browser app

Page operation (Return to previous page / Go to next page)

To refresh the page.

To close the tab. The Browser app will be closed when the last tab is closed.

To add a tab.

To display the bookmark and page history.

To add to the bookmark.

Tap to type a website address.

Using a USB camera

By connecting a USB camera or a UVC-compatible document camera to the product, you can display the images from them.



■ Starting the USB camera app

Tap the USB camera app icon on the Home screen.

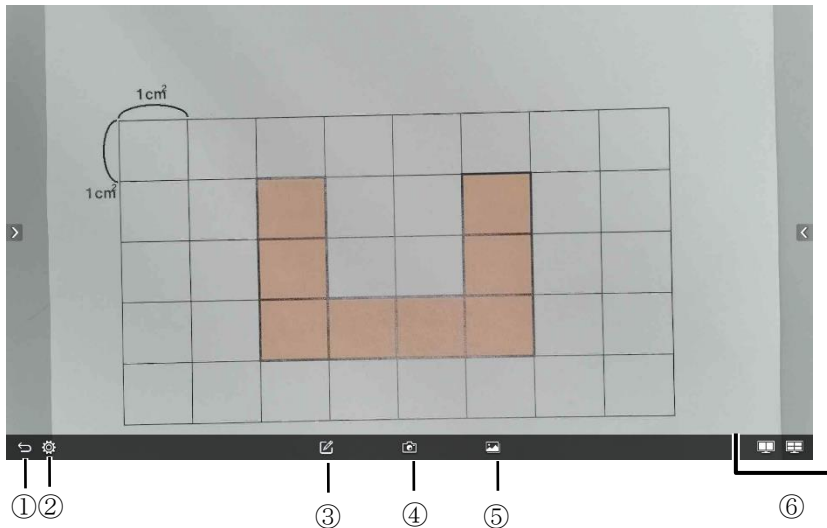

■ Operating the USB camera app



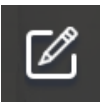
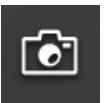
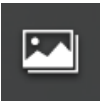

①		To go back to the previous screen.
②		To set the resolution of the camera.
③		To display the toolbar for pen annotation.
④		To save the current camera image displayed as a picture. (Save destination : Local/Pictures/CameraRoll)
⑤		To display a list of pictures in the camera roll.

To display Compare mode screen. (2 split screens / 4 split screens.)

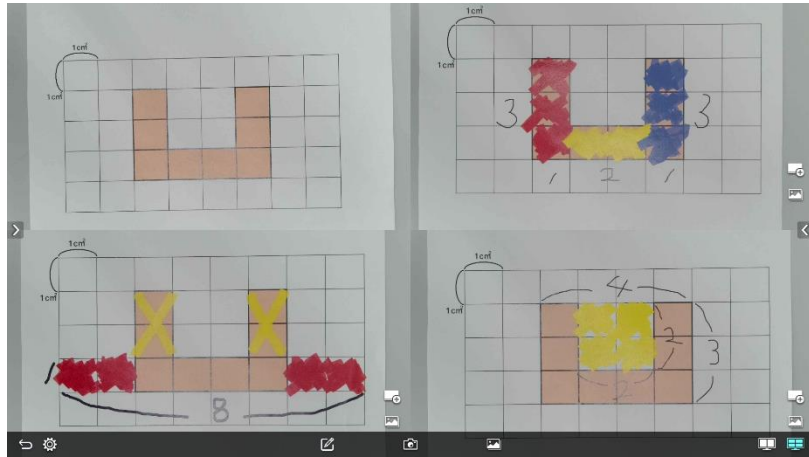
⑥



⑦
⑧

<p>⑦</p> 	<p>To add a saved picture to the whiteboard.</p> <p>This icon will be displayed when [] is pressed in the Compare mode screen.</p>
<p>⑧</p> 	<p>To change a picture to be compared.</p>

Note

- Multiple USB cameras cannot be connected to the product at the same time.
- When multiple USB cameras are connected, the image from the first USB camera will be displayed.
- While multiple USB cameras are connected, and if you disconnect the camera that displays the image, no other camera image will be displayed.
- If the connection is lost, disconnect the camera and then reconnect.
- We do not guarantee connection with all USB cameras.

Screen Mirror (Transcreen)

By using the Screen Mirror app, you can mirror the screens of the connected devices.



To install Transcreen on each OS device, start the Screen Mirror app and install from the QR code at the bottom of the screen or by accessing the website <http://192.168.43.1:8000>.

※The device to connect needs to be connected to the Internet in advance.

A banner for the Screen Mirror app. On the left is a QR code. To its right are two scenarios:
Scene 1: Wireless connection 5G with hotspot
① Connect local hotspot. SSID:AndroidAP_3749 password:Unknown
② Visit "http://192.168.43.1:8000" to download the client by PC. Scan the left QR Code to download the client by Android phone.
③ Select the device "IFP-98703",mirror screen.
Scene 2: Local 2.4G/5G wireless or wired connect to external routers.
① Connect mobile devices, PC and receiver to the same router.
② Visit "http://192.168.10.17:8000" to download the client by PC. Scan the left QR Code to download the client by Android phone.
③ Select the device "IFP-98703",mirror screen.
On the right, there are icons for Android and Windows, and a "Mirror Setting" button with a gear icon.

Note

- The connection method may vary depending on the OS used.
- The available functions may vary depending on the OS used.
- Maximum four different devices can be displayed at the same time.

■Using on Windows OS

- 1) Install Transcreen app on the device you want to connect to the product.
- 2) Connect the device to the product with Wi-Fi.
- 3) Start Transcreen app installed on the connected device.
- 4) Select the screen you want to display and press the Start Mirroring button.



- Select the screen you want to display
- Tap "Start Mirroring".

- 5) The screen of the connected device will be displayed.

Note

- Touch operations on the mirrored screen can be performed.

■Using on iOS or Mac OS

- 1) Connect the device to the product with Wi-Fi.
- 2) Start Airplay (a screen mirroring app) installed on iOS or Mac OS.



Tap "Airplay".



3) Select the screen to display.

- 4) The screen of the connected device will be displayed.

■Using on Chrome OS

- 1) Install Transcreen app on the device you want to connect to the product from Chrome web store.
- 2) Connect the device to the product with Wi-Fi.
- 3) Start Transcreen app installed on the connected device.

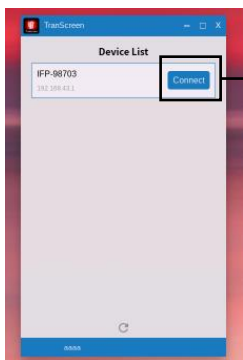

4) Tap "Connect".

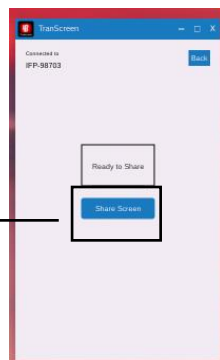

5) Tap "Share Screen".

6) Select the screen you want to display.



7) Tap "Share".

- 8) The screen of the connected device will be displayed.

Note

For iOS, Mac OS, and Chrome OS, only screen sharing is possible.

■Using on Android

- 1) Install Transcreen app on the device you want to connect to the product.
- 2) Connect the device to the product with Wi-Fi.
- 3) Start Transcreen app installed on the connected device. Tap “Airplay” button or “Mirror” button.

What you can do with Transcreen for Android:

Sharing of screens of the connected devices.

Sharing of documents stored in the connected devices.

Displaying the screen of the product on the device to perform operations of the product or make annotations on the screen.

Operating the screen of the product remotely from the device.

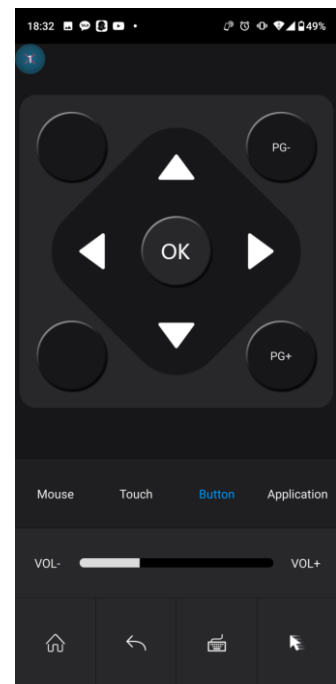
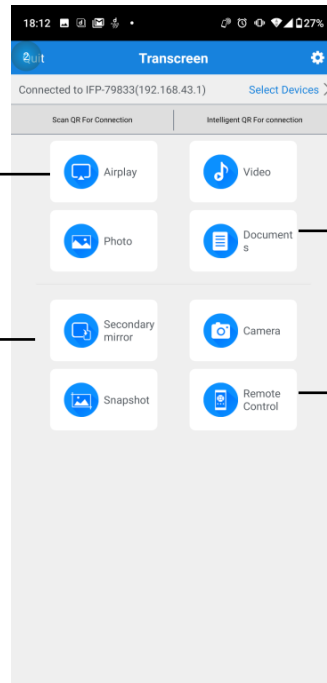

ELMO Play

ELMO Play is an app for installing apps from the ELMO portal site.

You can install and use useful apps from the ELMO portal site. (Paid content is also available.)



1) Before installing an app from ELMO Play, go to “Apps” from “Settings” and turn off the setting of "Prohibit app installation".

2) Select the app you want to install and start the installation.

3) After the installation is completed, turn on the above setting so that unnecessary apps are not installed.

*During the installation process, a dialog asking for a permission to install an unknown app will be displayed.

The apps on the ELMO portal site are provided by the application developer.

Select “Continue installation” to install.



■ Anti-virus app (KINGSOFT Mobile Security Plus)

Mobile Security Plus developed by KINGSOFT is an anti-virus app recommended by us.

If you want to use it, you need to purchase a serial key.

■Scottie Go !

Scottie Go! is a free programming learning app recommended by us.

Tiles need to be purchased.

A USB camera is needed to use this app.

Switching the input source

You can switch the input source connected to the product.

■Startup

Method 1) With the under bar switch turned on, swipe up on the screen from the center of the bottom.

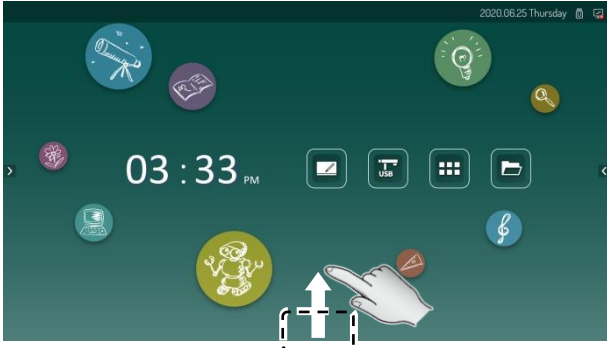

Method 2) Select [] in the side menu bar.

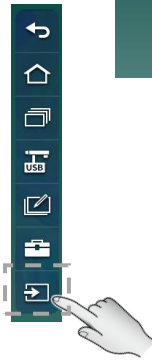
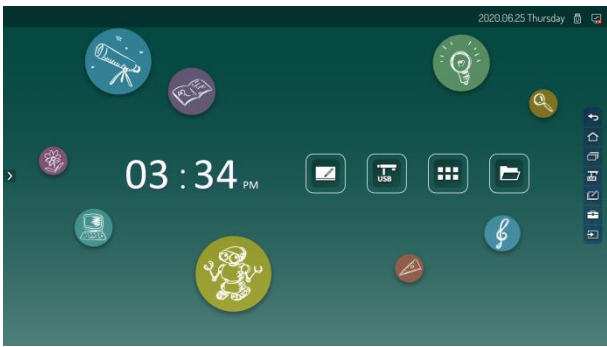

■Operation

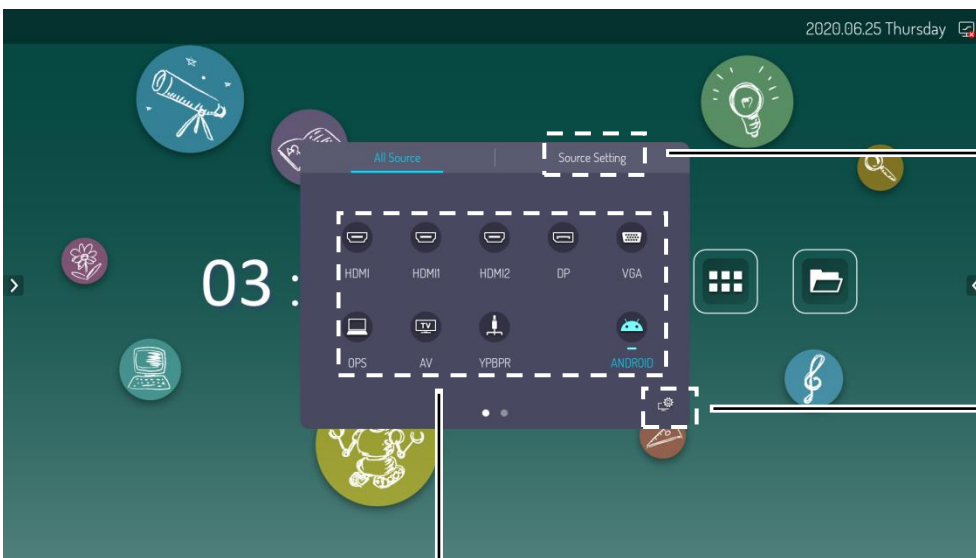

To display the settings screen of the input source.

To display the following menu screens:

- 「Input image adjustment」
- 「Audio adjustment」
- 「Menu settings」

To select the input source to switch.

Note

- By pressing the input source name long, you can change the name.
- For details about the bar switch on the bottom of the screen or in the side menu bar, refer to [page 59](#).

■ Input source settings

Source setting

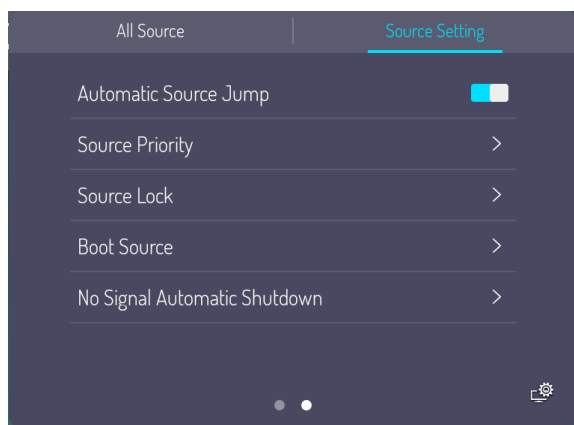

Source Priority switch	When this setting is turned on, the source will be switched according to the priority set in "Automatic Source Jump".
Automatic Source Jump	This menu can be selected by turning on the Source Priority switch. Tap this menu to display the "Source Priority" screen.
Source Priority	This menu will be displayed when "Source Priority" is turned on. You can assign a priority level from 1 to 5 to the input source. OPS / DS / HDMI / HDMI1 / HDMI2
Source Lock	To lock the input source not used.
Boot Source	To set the input source that is prioritized when the power is turned on.
No Signal Automatic Shutdown	Set the time for the input source to automatically shut down when there is no signal. OFF / 5 min. / 15 min. / 30 min.

Input image adjustment

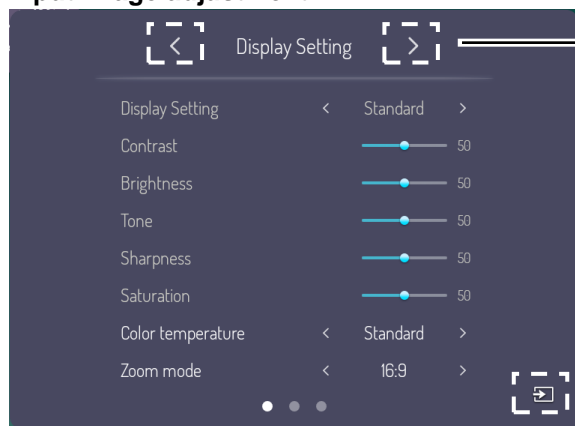

To change the following menu screens:

「Input image adjustment」

「Audio adjustment」

「Menu settings」

To return to “All source” screen.

Display Setting	To change the image contrast and brightness to the following pre-defined settings: PC / Gentle to the eyes / Standard / Bright / Soft / Custom When there is no image input, only “Standard” can be selected.
Contrast	To adjust the contrast. (Adjustable range: 0~100)
Brightness	To adjust the brightness. (Adjustable range: 0~100)
Tone	To adjust the color tone. (Adjustable range: 0~100)
Sharpness	To adjust the sharpness. (Adjustable range: 0~100)
Saturation	To adjust the saturation. (Adjustable range: 0~100)
Color temperature	To change the color temperature. Standard / Warm color / Cold color
Zoom mode (Aspect ratio)	To change the aspect ratio to 16 : 9 or 4 : 3.
Color range	To change the color range. Auto / 16~235 / 0~255
Automatic VGA adjustment	To automatically adjust the display position of the image.

Audio adjustment

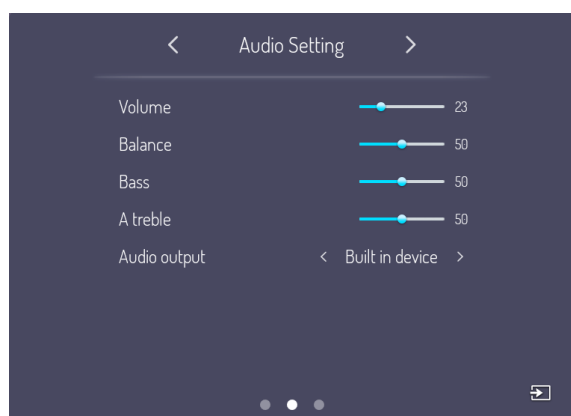

Volume	To adjust the audio volume. (Adjustable range: 0~100)
Balance	To adjust the audio balance (left – right).
Bass	To adjust the bass. (Adjustable range: 0~100)
Treble	To adjust the treble. (Adjustable range: 0~100)
Audio output	To switch the audio output between the built-in device (built-in speaker) and the external device (external speaker).

Menu setting

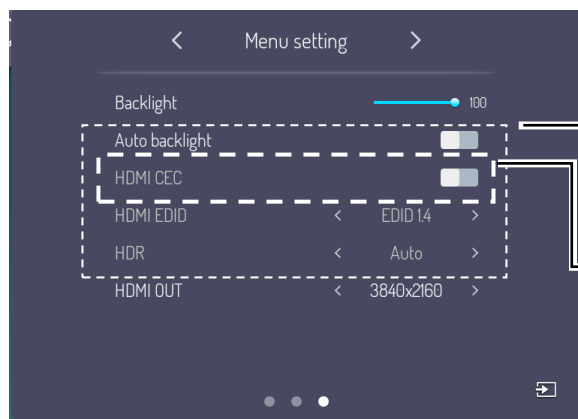

This item can be selected only when HDMI input is selected.

This menu will be displayed only when ARC compatible devices are connected.

Backlight	To adjust the brightness of the backlight. (Adjustable range: 0~100)
Auto backlight	When this setting is turned on, the backlight will be automatically adjusted according to the surrounding environment.
HDMI CEC	To switch the CEC function of HDMI on/off.
ARC	By using an ARC-compatible device, you can play digital sounds of both devices with a single HDMI cable.
HDMI EDID	To switch between HDMI 1.4 and 2.0.
HDR	To change HDR (High Dynamic Range). Ref .Mode / High / Auto / Middle / Low
HDMI OUT	To change the resolution for HDMI output. 1920×1080 / 3840×2160

Other functions

■Screenshots function

You can take a picture of the selected part of the screen and save it to the following folder:

Folder > Pictures > Screenshots



To change the selection area.

- Square
- Free-hand

Enter

Exit

Select entire screen

■Countdown function

You can set the timer to count down and up from the set time.

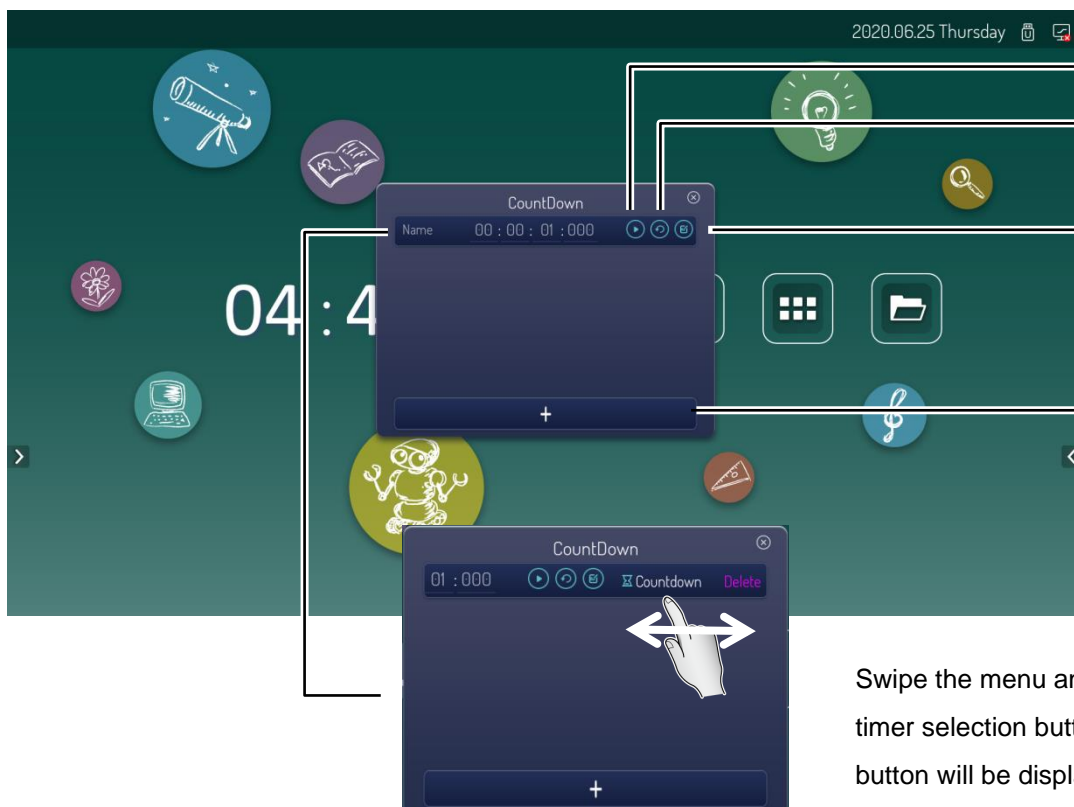

Start / Stop

Reset

To return to the set value.

Change settings

To change the name and value.

To add the countdown setting item.

Swipe the menu and the countdown / timer selection button and a delete button will be displayed.

Configuring the settings

■Advanced settings

Network (WiFi)

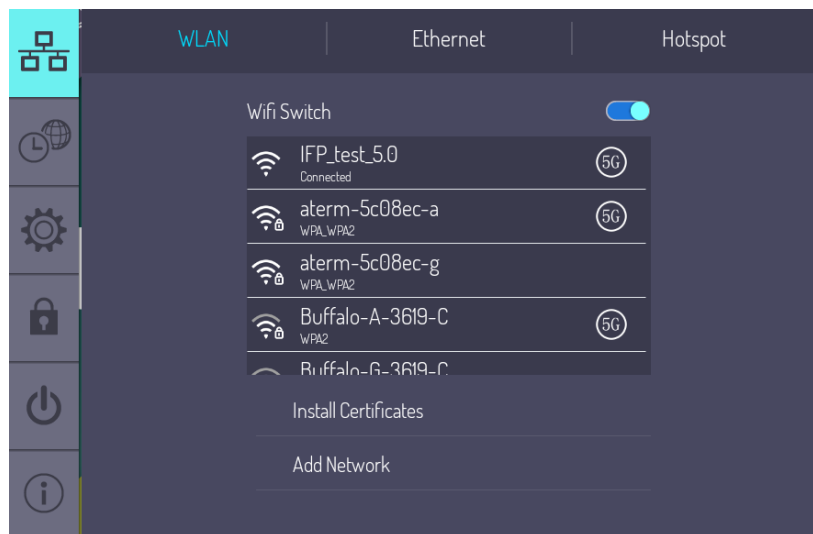

WiFi Switch	To switch WiFi connection on/off.
WiFi list	To select the network to connect from the connection list when WiFi is on.
Install Certifications	To install the client certificate.
Add Network	You can add a network by specifying the SSID. This function is used when connecting to a network the SSID of which is hidden.

Network (LAN)

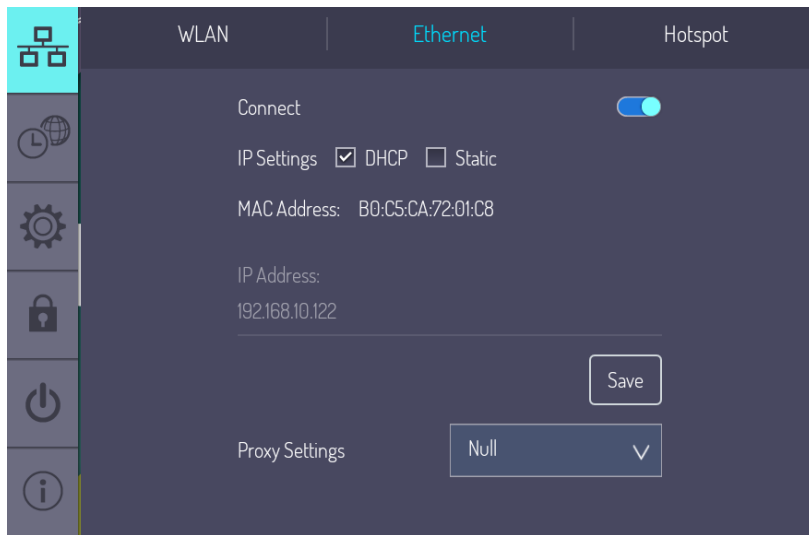

Connect	To switch LAN (Ethernet) connection on/off.
IP Settings	To switch between [DHCP] and [Static]. [DHCP]: IP address will be acquired automatically. [Static]: IP address will be set manually.
MAC Address	To display MAC address.
IP Address	[DHCP]: Automatically acquired IP address will be displayed. [Static]: IP address will be set manually.
Proxy Settings	To switch between [Auto] and [Manual]. When set to [Manual], the following items will be set: <ul style="list-style-type: none"> ▪ Host name of the proxy server ▪ Port of the proxy server ▪ Website that does not use a proxy server

Network (Hotspot)

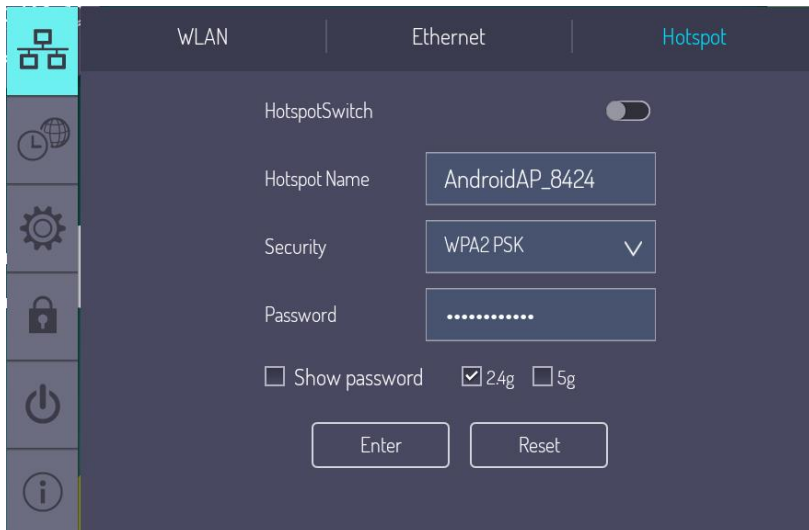

Hotspot Switch	To switch Hotspot (access point) function on/off.
Hotspot Name	To set the Hotspot name (SSID).
Security	To set the encryption type.
Password	To set the password for connecting to the Hotspot of this product.
Show password	To display the password.
2.4g / 5g	To select the radio wave to use. (2.4GHz / 5GHz)

Note

- The Hotspot function of this product is for a small number of people.
Though it depends on the communication environment, the maximum number of simultaneous connections is 10.

Date and Time settings

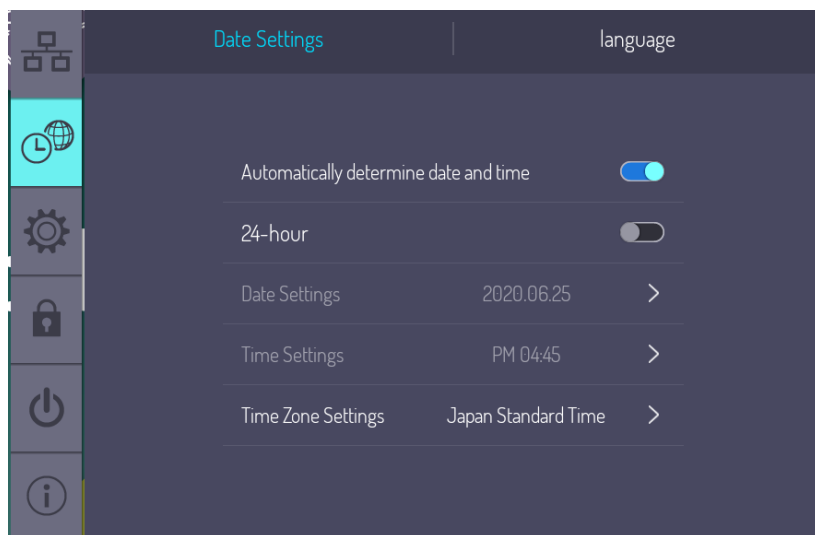

Automatically determine date and time	To use the time provided by the network.
24-hour	To switch between 12-hour display and 24-hour display.
Date Settings	To set the date of the system when "Automatically determine date and time" setting is off.
Time Settings	To set the time of the system when "Automatically determine date and time" setting is off.
Time Zone Settings	To set the time zone of the system.

Language

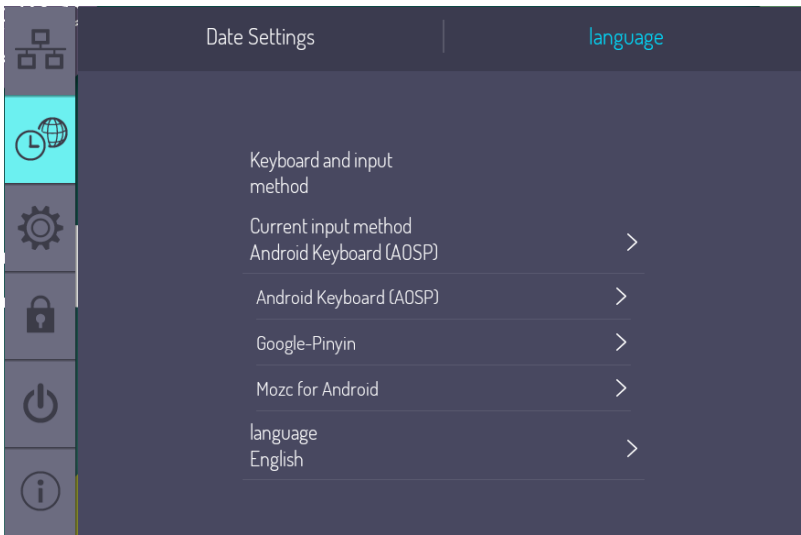

Current input method	To display the current input method. The input method can be changed.
List of input method	To configure the respective input methods.
Language	To set the display language.

System Settings

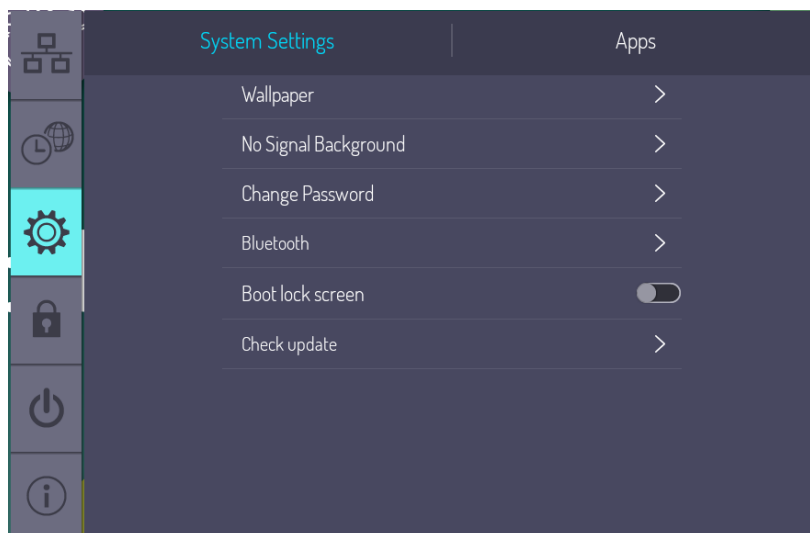

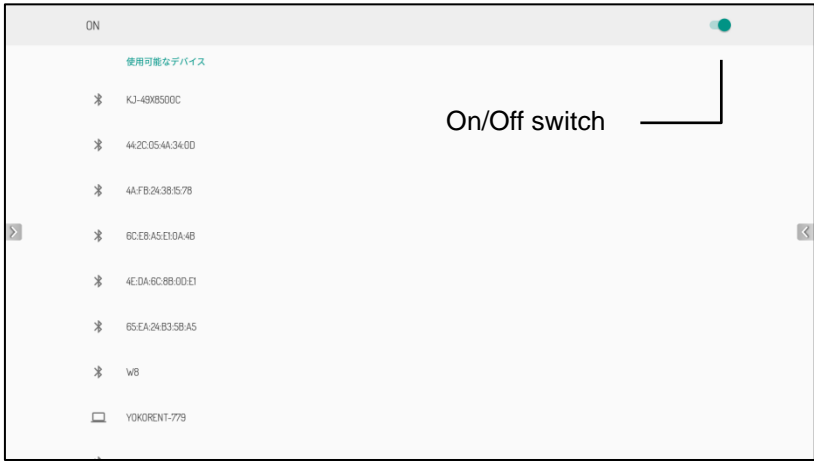
Wallpaper	To set a specified image as the wallpaper for the background of the Home screen.
No Signal Background	To set the background image displayed on the screen when there is no input signal from the input source such as HDMI to a specified image.
Change Password	To set a password for unlocking the screen. The initial password is "888888". If you forget your password, contact our Help Desk. ⇒P.68
Bluetooth	To set the Bluetooth device to connect to this product. 
Boot lock screen	To set to start from lock screen at startup.
Check update	To check the availability of the latest version. If there is any update available, you can proceed with the update. ※An Internet connection is required for update.

Apps

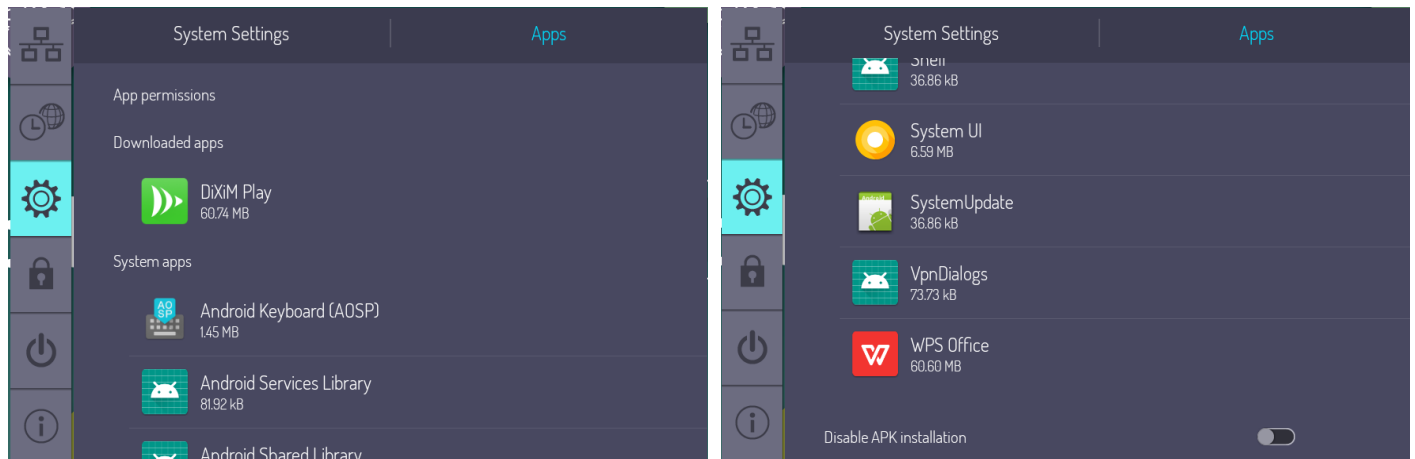

App permissions	To set app permissions.
Downloaded apps	To display the apps downloaded and installed by the user. It is also possible to uninstall the app.
System apps	To display a list of system apps.
Prohibit to install apps	To set whether to prohibit the installation of apps from APK files. In order to avoid users from installing apps, it is recommended to set it to ON (prohibit) for normal operation and to turn it OFF (permit) only when the administrator installs apps.

Lock control

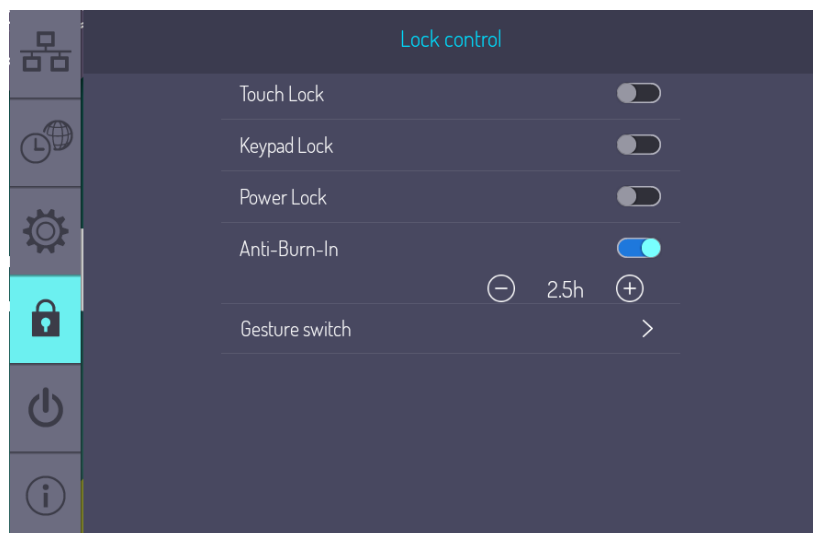

Touch Lock	To temporarily lock the touchscreen. Password is required to unlock.	
Keypad Lock	To disable the buttons other than the Power button located on the lower right of the front of the product.	
Power Lock	To disable the Power button.	
Anti-Burn-In	To prevent the screen burn-in at a certain period of time. 0.5h、1.0h、1.5h、2.0h、2.5h	
Gesture switch	To set whether to display the menu by gesture.	
	Side bar switch	To set to display the side menu bar when both ends of the monitor screen is swiped. When this setting is off, [>][<] tabs will be displayed on both ends.
	Under bar switch	To set to display the input source screen when the bottom center of the monitor screen is swiped up.
	Floating menu switch	To set to display the floating menu when two points on the monitor screen are pressed long.

Power setting

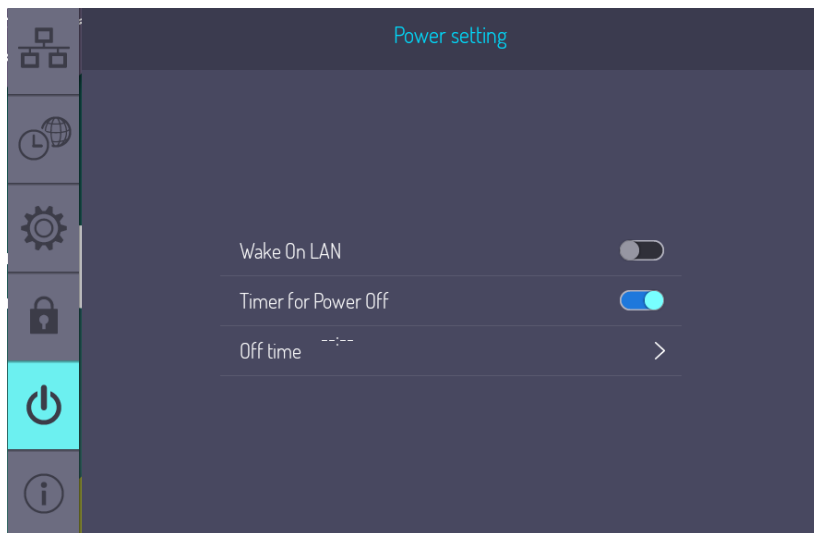

Wake On LAN	To set Wake On LAN function on/off.
Timer for Power Off	To set the timer function to shut down at the specified time on/off.
Off time	To set the power off time and day of the week.

Troubleshooting

■The product does not operate properly.

Symptom	Countermeasures
The remote control does not work properly.	Check if there is an obstacle between the remote control and the receiver, preventing infrared rays from reaching.
	Operate the remote control toward the receiver.
	Check that the batteries of the remote control are inserted in the correct direction with the (+) and (-) terminals properly aligned.
	Check that the batteries in the remote control are full.
The product automatically shuts down.	Check if the auto shutdown function in "no signal" state is working.
	Check if there is a power failure.

■The image of the input source cannot be output correctly.

Symptom	Countermeasures
The image is not displayed correctly.	Check if the cables are connected correctly.
	Check if the connected cable and the input source setting of the product match.
	Check if the connected cables are broken or disconnected.
	Check if a different cable is connected.
Vertical stripes and lines appear in the background.	Check if the cables are connected correctly.
	Check if the connected cables are broken or disconnected.
	Check if there are other electronic devices or appliances near the product. → Radio waves may be affected by other devices.
	Move the product away from other equipment or change its position.
Image has no colors or colors are incorrect.	Check if the VGA port is connected properly and there is no problem with the connector.
	Adjust "Contrast", "Brightness", "Tone", "Sharpness", and "Saturation" in "Input image adjustment" settings menu.
There is a distortion in the image.	Check if the cables are connected correctly.
	Check if the connected cables are broken or disconnected.

■No audio is output from the speaker.

Symptom	Countermeasures
No image is displayed and no audio is output from the speaker.	Check if the power of the product is off or the product is in the standby mode.
	Check if the cables are connected correctly.
	Check if the connected cable and the input source setting of the product match.
Image is displayed but audio is not output speaker.	Press the mute button on the remote control and check if it is muted.
	Adjust the volume with the remote control or the volume control button on the front panel of the product.
	Check if the audio cable is properly connected. → In the case of VGA connection, it is necessary to connect the headphone cable for audio output separately from the VGA cable.
The audio is output from only one speaker.	Check if the audio cable is connected correctly.
	Adjust the audio balance with "Audio adjustment" menu in the Input source settings.

■Touch operations do not work properly.

Symptom	Countermeasures
The product does not recognize the touch input or recognizes improperly.	Check if the touch function is disabled.
	Make sure the size of the touched area is not too small compared to the size of your finger.
	Check the tip of the touch pen for any abnormalities.
	When the touch operation of the connected computer is not recognized, check the followings: <ul style="list-style-type: none"> • Check that the touch port of the product and the USB port on the computer are connected with the supplied USB cable. • Check that the touch driver is properly installed and the software is running.

■Cannot connect to the network.

Symptom	Countermeasures	
Cannot connect to the network.	General	Check if the network device such as a router is turned on.
	Wi-Fi	Check if the Wi-Fi connection setting switch is turned on.
	LAN	Check if the LAN connection setting switch is turned on.
		Check if the LAN cable is connected correctly.
		Check if the connected LAN cable is broken or disconnected.
	Hotspot	Check if the hotspot connection setting switch is turned on.
Check if the device is connected to the hotspot name of the product.		
The network speed is slow.	General	Check if the product is connected to a different access point.

Maintenance

Clean the product regularly for long-term use.

Before cleaning or maintenance, disconnect the power plug to prevent electric shock.

Caution

- Be sure to disconnect the power plug from the outlet before cleaning.
- Do not wipe with chemicals such as thinner, benzene or alcohol, and do not apply insecticide.
It may cause discoloration or damage the surface finish.
- For cleaning the inside of the product, consult with the dealer where you purchased the product.
- Wiping the screen strongly or wiping it with a hard cloth may scratch the surface of the LCD display.
- Be sure to pull out the power plug when the product is not used for a long time.

Cleaning of the LCD display

Wipe gently with a soft, dry cloth.

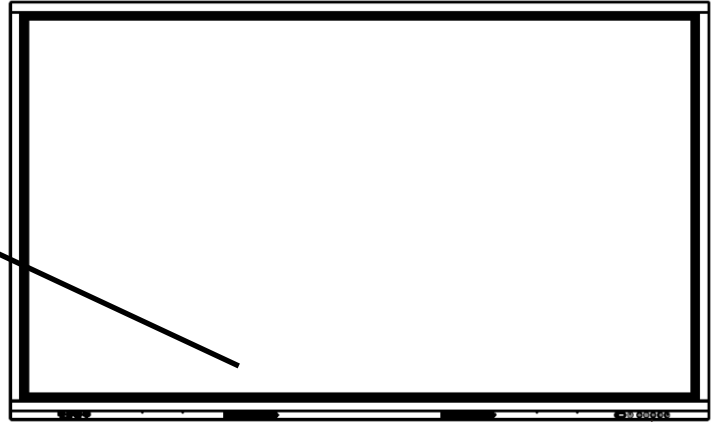

Specifications

Model	EL55R1	EL65R1	EL75R1	EL86R1
Power supply	100V AC 50/60Hz	100V AC 50/60Hz	100V AC 50/60Hz	100V AC 50/60Hz
Power consumption	140W	220W	330W	400W
Temperature	0~40°C	0~40°C	0~40°C	0~40°C
Humidity	20~80% (no condensation)	20~80% (no condensation)	20~80% (no condensation)	20~80% (no condensation)
Speaker	15W+15W	15W+15W	15W+15W	15W+15W
VESA	400x400 M6 screw	600x400 M8 screw	600x400 M8 screw	700x400 M8 screw
Dimensions	1298x94x789mm	1506x96x901mm	1736x104x1035mm	1989x120x1180mm
Weight	29kg	39kg	54kg	73kg
Screen size	55"	65"	75"	86"
System	ADS	ADS	ADS	ADS
Resolution	3840x2160	3840x2160	3840x2160	3840x2160
Brightness	375cd/m ²	450cd/m ²	550cd/m ²	450cd/m ²
Contrast	1300:1	1200:1	1200:1	1200:1
LCD response speed	6ms	8ms	8ms	8ms
Display colors	Approx. 1.07 billion colors	Approx. 1.07 billion colors	Approx. 1.07 billion colors	Approx. 1.07 billion colors
Angle of view	178°	178°	178°	178°
Number of touch points	20 points	20 points	20 points	20 points
Touch response speed	10ms or less	8ms or less	8ms or less	8ms or less
Protective glass	Anti-Glare 3.2mm	Anti-Glare 3.2mm	Anti-Glare 3.2mm	Anti-Glare 3.2mm
HDMI input port (HDMI,HDMI1,HDMI2)	HDMI Type-A x 3	HDMI Type-A x 3	HDMI Type-A x 3	HDMI Type-A x 3
Display Port (DP)	Display Port x 1	Display Port x 1	Display Port x 1	Display Port x 1
VGA input port (VGA)	D-Sub 15pin x 1	D-Sub 15pin x 1	D-Sub 15pin x 1	D-Sub 15pin x 1
AV input port (AV-IN)	4pin mini x 1	4pin mini x 1	4pin mini x 1	4pin mini x 1
YPbPr input port (YPbPr)	6pin mini x 1	6pin mini x 1	6pin mini x 1	6pin mini x 1
AUDIO input port (PC-AUDIO)	3pin mini x 1	3pin mini x 1	3pin mini x 1	3pin mini x 1
HDMI output port (HDMI-OUT)	HDMI Type-A x 1	HDMI Type-A x 1	HDMI Type-A x 1	HDMI Type-A x 1
AV output port (AV-OUT)	4pin mini x 1	4pin mini x 1	4pin mini x 1	4pin mini x 1
AUDIO output port (AUDIO-OUT)	3pin mini x 1	3pin mini x 1	3pin mini x 1	3pin mini x 1
SPDIF output port (S/PDIF)	S / PDIF x 1	S / PDIF x 1	S / PDIF x 1	S / PDIF x 1
Serial port (RS232)	D-Sub 9pin x 1	D-Sub 9pin x 1	D-Sub 9pin x 1	D-Sub 9pin x 1
LAN port (LAN1,LAN2)	RJ45 x 2 (10/100 BASE-T)	RJ45 x 2 (10/100 BASE-T)	RJ45 x 2 (10/100 BASE-T)	RJ45 x 2 (10/100 BASE-T)
USB port (USB, PUBLIC-USB)	USB Type-A x 4 (USB2.0)	USB Type-A x 4 (USB2.0)	USB Type-A x 4 (USB2.0)	USB Type-A x 4 (USB2.0)
Touch port (TOUCH-USB)	USB Type-B x 2 (USB2.0)	USB Type-B x 2 (USB2.0)	USB Type-B x 2 (USB2.0)	USB Type-B x 2 (USB2.0)

Model	EL55R1	EL65R1	EL75R1	EL86R1
OS	Android 8.0	Android 8.0	Android 8.0	Android 8.0
CPU(CHIP)	ArmA73+A53 (MSD8386)	ArmA73+A53 (MSD8386)	ArmA73+A53 (MSD8386)	ArmA73+A53 (MSD8386)
CPU SPEC	1.5GHz Quad Core	1.5GHz Quad Core	1.5GHz Quad Core	1.5GHz Quad Core
GPU	MaliG51	MaliG51	MaliG51	MaliG51
RAM	3GB	3GB	3GB	3GB
ROM	32GB	32GB	32GB	32GB
Wi-Fi	IEEE802.11a/b/g/n/ac (2.4G/5G)	IEEE802.11a/b/g/n/ac (2.4G/5G)	IEEE802.11a/b/g/n/ac (2.4G/5G)	IEEE802.11a/b/g/n/ac (2.4G/5G)
Bluetooth	Bluetooth4.2	Bluetooth4.2	Bluetooth4.2	Bluetooth4.2
OPS slot	1	1	1	1
Touchscreen compatible OS	Windows, Mac, Chrome	Windows, Mac, Chrome	Windows, Mac, Chrome	Windows, Mac, Chrome

■Field frequency

VGA

No.	Mode	Resolution	Field frequency
1	VGA	640×480	60Hz
2	SVGA	800×600	
3	XGA	1024×768	
4	WXGA	1360×768	
5	WUXGA	1920×1080	

HDMI

No.	Mode	Resolution	Field frequency
1	SD	720×480	70Hz
2		720×576	50Hz
3		1280×720	50Hz
4		1280×720	60Hz
5	HD	1920×1080	50Hz
6		1920×1080	60Hz
7	UD	3840×2160	30Hz
8		3840×2160	60Hz

YPBPR

No.	Mode	Resolution	Field frequency
1	SD	480i	60Hz
2		576i	50Hz
3		480p	60Hz
4		576p	60Hz
5		720p	50Hz
6		720p	60Hz
7	HD	1080i	50Hz
8		1080i	60Hz
9		1080p	50Hz
10		1080p	60Hz

Display Port

No.	Mode	Resolution	Field frequency
1	SD	720×480	70Hz
2		720×576	50Hz
3		1280×720	50Hz
4		1280×720	60Hz
5	HD	1920×1080	50Hz
6		1920×1080	60Hz
7	UD	3840×2160	30Hz
8		3840×2160	60Hz

After-sales service

■Product warranty

This product comes with a warranty. The warranty card will be handed to you by the dealer after filling out the required information. Please read it carefully and keep it in a safe place.

The warranty period is one year from the date of purchase. Please ask your dealer for more details.

(The LED backlight of the light source and the pen are consumable items and are not covered by the warranty.)

You may be charged for repairs even during the warranty period, so please read the warranty card carefully.

The warranty applies only to the hardware of the product.

Customers are responsible for the cost of removing and re-installing the product for repair.

A separate work fee will be charged when performing recovery work for defects that are not caused by the hardware of the product.

■Repair procedure

Read "Troubleshooting" in this manual, and if the problem still persists, unplug the power cord from the outlet and contact the dealer from whom you purchased the product or our sales office.

Please make a note of the product model number and serial number when making inquiries.

Do not repair by yourself as it is very dangerous.

Within warranty period

We will repair the product in accordance with the terms of the warranty.

After warranty period

Repairable products will be repaired on chargeable basis upon request of the customer.

Please contact the dealer from whom you purchased the product or our sales office.

When making a repair request, please inform us of the product name, customer name, address, telephone number, date of purchase, and details of the failure.

Repair charge

The repair fee consists of [Technical fee] + [Parts cost] + [Business trip fee] + [Transportation fee].

Trademarks

- Bluetooth is the registered trademark of Bluetooth SIG, Inc.
- Microsoft, Windows, and One Drive are registered trademarks of the Microsoft Corporation in the U.S. and other countries.
- HDMI, HDMI logo, and High-Definition Multimedia Interface are trademarks or registered trademarks of HDMI Licensing LLC in the U.S. and other countries.
- Android OS and Google Drive are trademarks of Google LLC.
- Display Port is the registered trademark of Video Electronics Standards Association.

All other company/product names described in this manual are trademarks or registered trademarks of their respective companies.

ELMO CO., LTD.
1-3-4, Shioya-cho, Minami-ku
Nagoya, 457-0078, Japan

OVERSEAS SUBSIDIARY COMPANIES

ELMO USA CORP.

Headquarters

6851 Jericho Turnpike

Suite 145

Syosset, NY 11791

Tel. (516) 501-1400 Fax.(516) 501-0429

E-mail: elmo@elmousa.com

Web: <http://www.elmousa.com>

ELMO Europe SAS

Headquarters

12 place de la Défense

Maison de la Défense

92974 Paris la Défense Cedex FRANCE

Tel. 33 (0) 1 73 02 67 06

Fax. 33 (0) 1 73 02 67 10

E-mail: info@elmoeurope.com

Web: <http://www.elmoeurope.com>

German Branch

Monschauerstr. 1

40549 Düsseldorf

Tel. 49 (0) 211 544756 40

Fax. 49 (0) 211 544756 60

Middle East (Branch)

5WA-129, Dubai Airport Free Zone

P.O. Box 371556, Dubai

United Arab Emirates

TEL. +971-(0)4-260-2390

FAX. +971-(0)4-260-2392

6X1XSYA04 R0-Xox