

SAVE THIS MANUAL

Instruction Manual

Battery Brushless Motor Crimping Tool

P/N: 902-605

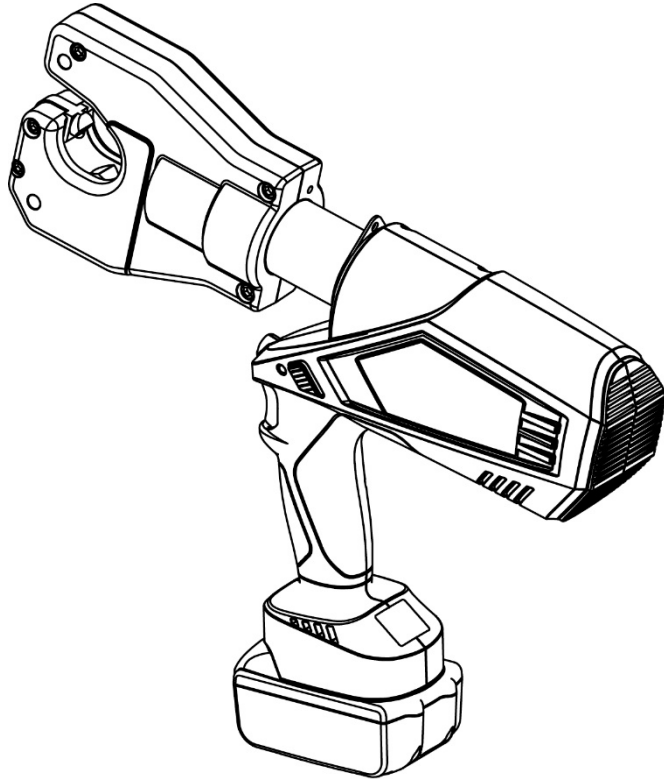

Due to continuing improvements, actual product may differ slightly from the product described herein.



Read this material before using this product.

Failure to do so can result in serious injury.

SAVE THIS MANUAL

Keep this manual for the safety warnings and precautions, assembly, operating, inspection, maintenance and cleaning procedures. Write the month and year of purchase. Keep this manual and the receipt in a safe and dry place for future reference.

IMPORTANT SAFETY INFORMATION

In this manual, on the labeling, and all other information provided with this product:



This is the safety alert symbol. It is used to alert you to potential personal injury hazards. Obey all safety messages that follow this symbol to avoid possible injury or death.

DANGER

DANGER indicates a hazardous situation which, if not avoided, will result in death or serious injury.

WARNING

WARNING indicates a hazardous situation which, if not avoided, could result in death or serious injury.

CAUTION

CAUTION, used with the safety alert symbol, indicates a hazardous situation which, if not avoided, could result in minor or moderate injury.

GENERAL SAFETY RULES

TO WORK IN SAFE CONDITIONS WITH THIS TOOLING, IT IS IMPERATIVE TO READ THE DIRECTIONS CAREFULLY FOR USE AND TO FOLLOW THE INSTRUCTIONS IT CONTAINS. IF YOU DO NOT RESPECT THE INFORMATION WRITTEN IN THE INSTRUCTION MANUAL THE WARRANTY WILL BE CANCELLED.

1. Work area safety

- a. Keep work area clean and clear. Cluttered or dark areas invite accidents.
- b. This tool is not insulated; please do not use it on live conductor.
- c. Please do not use or store the tool under high temperature, or one filled with corrosive fluid. Pay attention to the O-Ring kits becoming aged.
- d. Keep children and bystanders away while operating the hydraulic crimping tool. Distractions will cause you to lose control.

2. Electrical safety

- e. Make sure the plug matches with the outlet. Never try any changes on the plug.
- f. Do not put tool, battery and charger into a rainy or humid environment, it is easy to trigger an electric shock accident if any water goes into the electric system of the tool.
- g. Do not use electric cord to carry, pull, or to pull out the plug and do not connect the “-“and “+”, the damaged or frayed wire may cause an electric shock accident.
- h. If the charger was strongly shocked by dropping or any other damage happens, please do not try to repair it by yourself, send it back to the authorized service center as soon as possible. The damaged charger may cause an electric shock accident.
- i. The best temperature for charging is between 10°C-40°C. Make sure the air hole of the battery and charger are uncovered during charging.
- j. Please turn off the power of the charger each time to reduce the hazard to children or the person who may not be expert with the tool.

- k. Do not wait to charge the battery until the when the power is completely drained, it may cause the battery to stop working. Please keep the battery out of the tool to avoid power discharge.
- l. Please do not burn the battery or make it being short-circuited, it may cause explosion.
- m. Do not use a wasted battery otherwise it may cause electric shock.
- n. Do not disassemble the battery and charger. If any problem occurs, please contact the authorized service center.

3. Personal safety

- o. Stay alert, watch what you are doing and use common sense when operating the tool. Do not use the tool while you are tired or still under the influence of drugs, alcohol or medication. A moment of inattention may result in serious personal injury.
- p. Use safety equipment. Always use safety equipment such as mask, helmet, safety cap, insulating shoes, etc to reduce the risk of personal injury.
- q. Dress properly. Do not wear loose clothing or jewelry. Keep your hair, clothing and gloves away from moving parts. Loose clothes, jewelry or long hair can be caught in moving parts.
- r. Maintain power tools. Check for misalignment or binding of moving parts, breakage of parts and any other condition that may affect the tool operation. If damaged, have the tool repaired before use. Many accidents are caused by poorly maintained power tools.
- s. Please use the tool properly, the tool with correct power will do the job better and safer at the rate for which it was designed.
- t. Do not put your fingers into the head of the tool during operation. Your fingers could be pinched very severely.

3. Service

Have your Battery Crimping Tool serviced by a qualified service technician and use

only original replacement parts. This will ensure that the safety of the Hydraulic Crimping Tool Kit is maintained.

SPECIFIC SAFETY RULES

- 1) Maintain labels and nameplates on the tool that carry important safety information. If unreadable or missing, contact the agent to replace.
- 2) This product is not a toy, keep it out of reach of children.
- 3) Do not put your fingers into the head of the tool during operating. Your fingers could be pinched very severely.
- 4) Make sure the head is locked firmly during operation.
- 5) Do not crimp on live cables or conductors
- 6) Do only crimp cooper or Al conductor material
- 7) Do not impact/drop any parts of the tool, otherwise it may cause injury.
- 8) The design of the limit screw on the head is for preventing the head from dropping or popping.
- 9) Make sure the head is locked firmly during operation.
- 10) Do not use this tool for continuous use. After 30 to 40 cycles, allow the tool to cool for 15 minutes.
- 11) Do not secure this tool in a vise. This tool is designed for hand-held operation.
- 12) The built-in safety valve goes through strict pressure test before sale; please do not adjust the pressure by yourself. If the pressure is not enough please return the tools back to the service center. The tool only can be reused after checking and testing by trained person.
- 13) The warnings, precautions, and instructions discussed in this instruction manual cannot cover all possible conditions and situations that may occur. It must be understood by the operator that common sense and caution are factors which cannot be built into this product, but must be supplied by the operator.

UNDERSTAND YOUR TOOL

902-605 is a tool for crimping Cu/Al lugs with cable from AWG 8 to 500 MCM. It is powered by Li-ion, actuated by motor and controlled by MCU, with OLED display and a

high pressure hydraulic system, it is a perfect tool to be used in electrical construction site.

1. Specification

Max. crimping force:	60KN
Crimping range:	Cu AWG 8 to 500MCM
Stroke:	1.38 inches
Hydraulic oil:	Shell Tellus T15# S2V HV15
Oil capacity	115ml
Ambient temperature	-10-40°C
Voltage/capacity:	18V/3.0Ah
Time/crimp:	2.5-5s(depend on the size of cable)
Time/charger:	Approx. 250 times (CU 150mm ²)
Charging voltage:	AC 100V~240V ;50~60Hz
Charging time:	Approx.1 hour
Size of tool	400x350x78mm
Accessories:	
Battery:	2 pcs
Charger:	1 pc

2. Description of components:

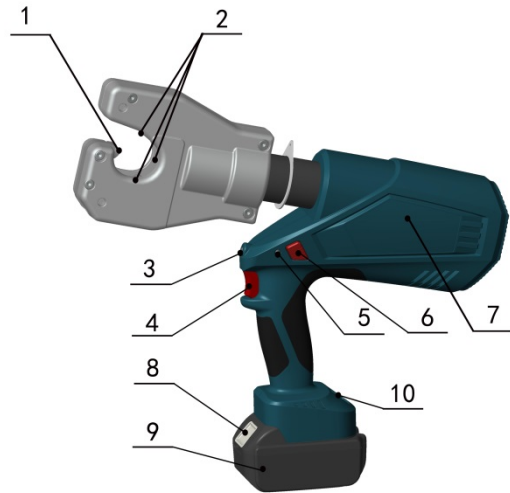

Parts No.	Description	Function
1-2	Indentors	For crimping
3	White LED	For lighting
4	Start button	For starting operation
5	Red LED	For indicating the operating condition and battery discharging situation.
6	Retract button	For manual retracting the piston in case of an incorrect operation.
7	Label	For sticking company logo
8	Battery lock	For locking/unlocking the battery.
9	Battery	For supplying power, rechargeable Li-ion (18V)
10	OLED display	Show crimping time, electricity errors info

3. Function description



Microcomputer control system-automatically detects the pressure when in crimping with double safety protection.



OLED display - Dot matrix OLED display, which shows crimp times, battery power, working pressure (if equipped with pressure sensor), maintenance reminder and fault code.



Pressure monitoring and control technology -The pressure of the tool system is monitored by a pressure sensor and the tool is pressure controlled. (if configured)



Auto reset- Release the pressure automatically, retract the piston to the starting position when reached the max output.



Manual reset —Can retract the piston to the starting positioning in case of an incorrect operation.



The unit is equipped with a double piston pump which is characterized by a rapid approach of the die towards the connector and a slow crimping motion.



The head can be smoothly turned by 360°around the longitudinal axis in order to gain better access to tight corners and other difficult working areas.



If a deviation from the set operating pressure or low battery charge is identified, an acoustic signal sounds and a red display flashes.



The whole tool is controlled by one trigger. This results in an easy handling and a better grip compared to a two button operation.









A temperature sensor makes the tool stop working automatically when

the temperature over 60°C under long time working, the fault signal sounds, it means the toll can't continue work until the temperature reduce to the normal.

OPERATING INSTRUCTION

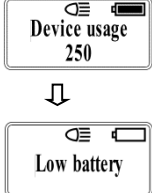
Read the entire SAFETY INFORMATION section at the beginning of this manual including all text under subheadings therein before using this product.

Use this tool for the manufacturer's intended purpose only. Use other than that described in this manual may result injury or property damage.

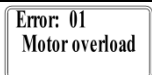
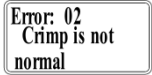
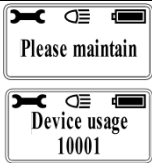
Series No	Instruction	LED (red)	LED (white)		OLED screen	What it means
1	Self-checking	□□ (2Hz)				Self-checking to assure everything is ok
2	Light		Delay 20s off			Enter the working state, the battery is full
3	Charging signal	□□□ (2Hz)				Lacking power and needs charging.
		□ (5ms)				Lacking power and needs charging.
		□ (100ms)				No power and needs charging immediately
4	High temperature warning	□□□□ (2Hz)		○○○○○ (2Hz)		Motor surface temperature is too high, waiting for cooling to restart the tool
5	overload	□ (3s)				Battery reloading, recovery work interface
6	Crimp is not normal	□ (5s)		○ (5s)		Battery reloading, recovery work interface
7	Maintenance reminder			○ (0.5s)		Tool must be maintained

1. Charging

Push battery into charger and connect the plug with the outlet. Make sure the ambient temperature is between 10°C-40°C. The charging time is around 1hour. Please see the illustration below.

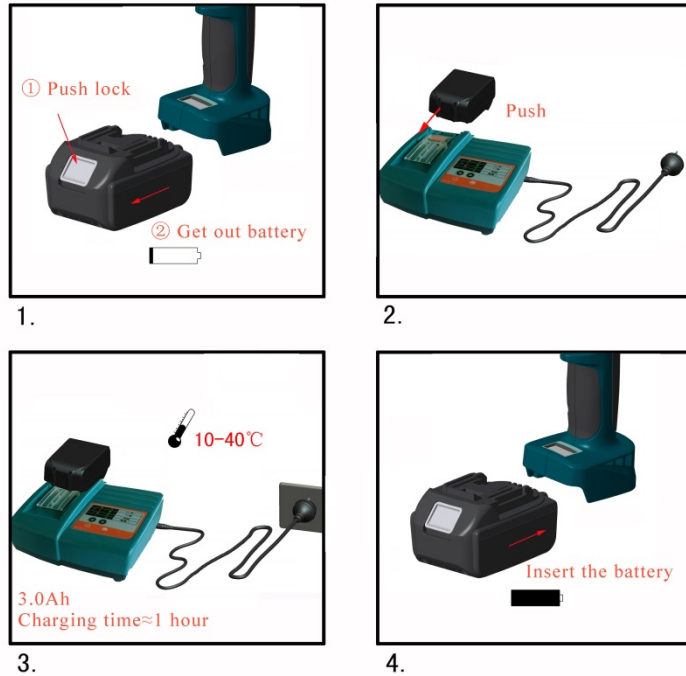

For detail of the charging information, please refer to the manual (MANUAL FOR CHARGER)

⚠ CAUTION

The battery can be used for hundreds of times, when the life span is obviously reduced, change to a new battery.

Please charge the battery in time to avoid it to be used up absolutely; otherwise it will become permanently damaged. if the battery is not be used for a long time, it will discharge automatically. Make sure to charge it at least one time per quarter year.

2. Usage of the tool

OLED display interface description:

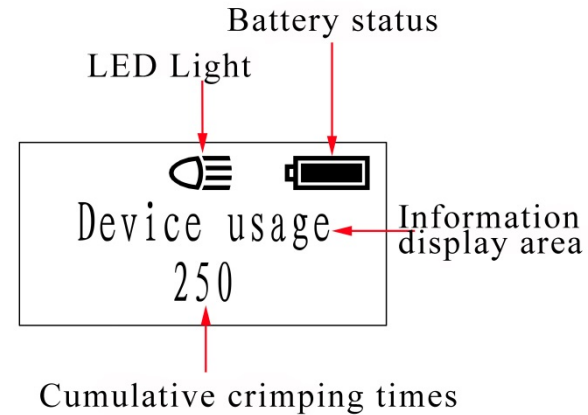

Tool LED illuminator:

After clicking the start button, the LED illuminator light goes on, After the tool is released, the button will automatically turn off after a delay of 20 seconds. Press the start button before installing the battery. When the battery is installed, release the start button and the LED light is off. If the light is on, the battery must be reinstalled once. As shown in the figure.

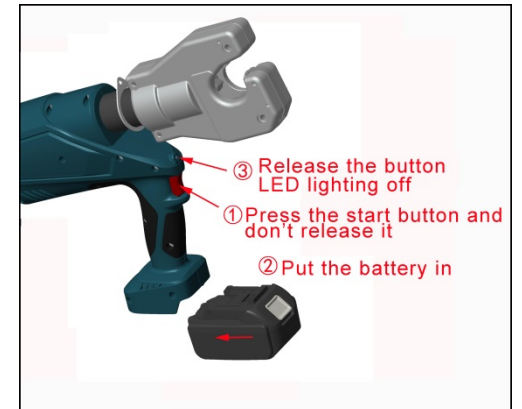

3. Crimping operation

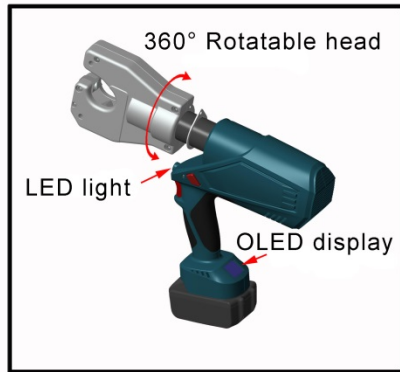

1.

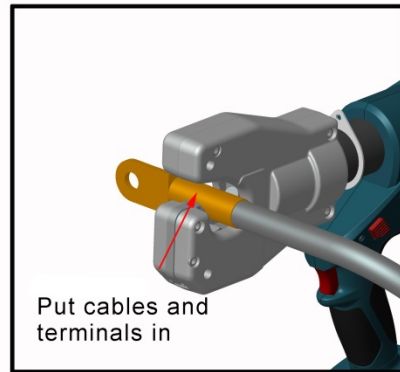

2.

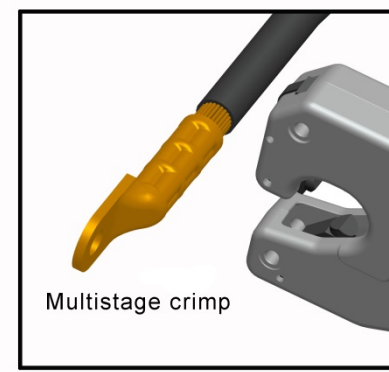

7.

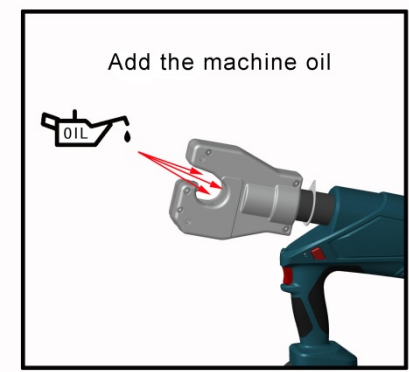

8.

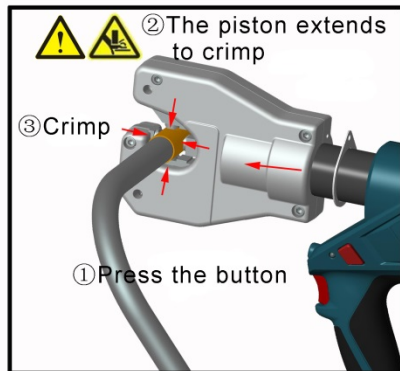

3.

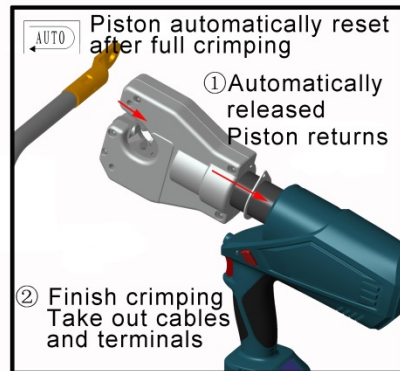

4.

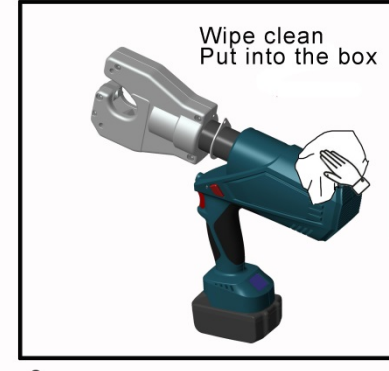

9.

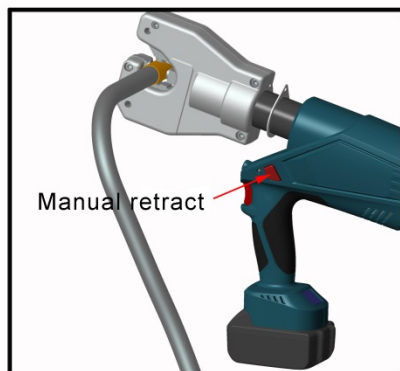

5.

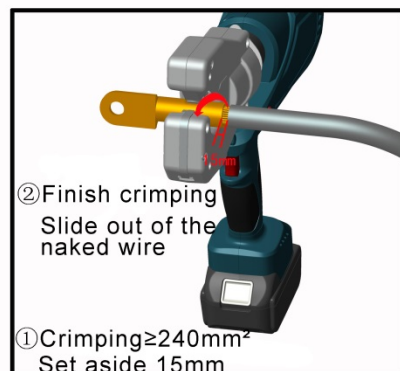

6.

⚠CAUTION

During crimping, please make sure the connector with cable in the center of crimping head, otherwise it will damage the tool or failure to crimping.

See the following illustration:

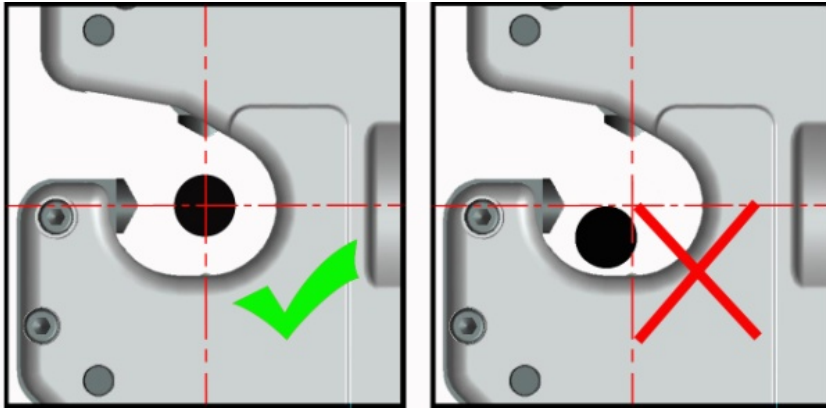

⚠WARNING

Non interchangeable crimping dies have the feature of automatic centering, four point indent crimping type.

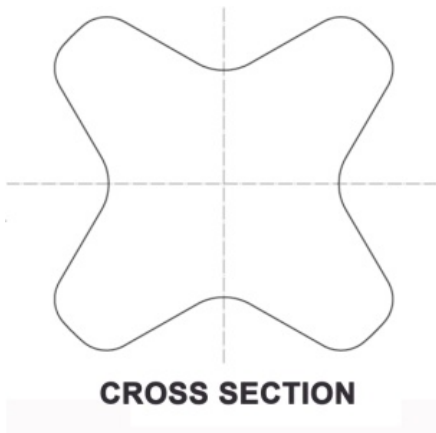

MAINTENANCE AND SERVICING

⚠WARNING

Damaged equipment may cause serious personal injury. Do not use damaged equipment. If abnormal noise or vibration occurs, have the problem corrected before further use.

- 1) **Before each use**, inspect the general condition of the tool. Check for loose screws, misalignment or binding of moving parts, cracked or broken parts, or any other condition that may affect its safe operation.
- 2) **After using**, clean external surfaces of the tool with clean, moist, smear the rust preventing oil on the metal surface of the tool and the dies to avoid rust. Store the tool in a dry environment.
- 3) Service to the tool should only be done by a qualified Service Technician.
- 4) In order to prolong the life of the tool please change the oil at least once per year. Make sure the oil filtered by 120 mesh net or over 30µm strainer. Meantime avoid getting the dust into the oil cup.
- 5) After a long time of use, the O-Rings will be damaged, if there is leakage please contact with the manufacturer and/or the distributor to change the sealing kits.
- 6) If the tool is not used for a long time, please make sure the piston stays in its starting position, clean up the tool and coat with rustproof oil both the tool and accessories. Take the battery out and put it into the storage case and store the tool in a dry environment.

TROUBLESHOOTING

FAULT	ANALYSIS	SOLUTION
A. Tool is inoperative	<ol style="list-style-type: none">1. Dirt, contaminants, etc in ram area of tool.2. The battery ran out3. Tool components worn or damaged.	<ol style="list-style-type: none">1. Clean hydraulic system2. Charge the battery3. Return tool to manufacturer or distributor
B. No power during operation or not up to the rated power	<ol style="list-style-type: none">1. Low/No oil2. Dirt, contaminants inside of oil sac.3. Inner leakage	<ol style="list-style-type: none">1. Fill oil2. Return tool to manufacturer or distributor3. Return tool to manufacturer or distributor
C. Leakage on the head or plunger	<ol style="list-style-type: none">1. Worn out sealing kits (O-Rings)	<ol style="list-style-type: none">1. Return tool to manufacturer or distributor
D. Motor runs but no power output	<ol style="list-style-type: none">1. No oil in the oil sac2. Air into the hydraulic system3. Cold oil	<ol style="list-style-type: none">1. Fill or change the oil2. Return tool to manufacturer or distributor3. Use the tool between -20 °C -40°C
E. Error alarm	<ol style="list-style-type: none">1. No battery power	<ol style="list-style-type: none">1. The battery needs to charge

LIMITED 2 YEAR WARRANTY

We make every effort to assure our products meet high quality and durability standards, and warrant to the original purchaser that this product is free from defects in materials and workmanship for the period of one year from the date of purchase (90 days if used by a professional contractor or if used as rental equipment). This warranty does not apply to damage due directly or indirectly, to misuse, abuse, negligence or accidents, repairs or alterations outside our facilities, normal wear and tear, or to lack of maintenance. We shall in no event be liable for death, injuries to persons or property, or for incidental, contingent, special or consequential damages arising from the use of our product. Some states do not allow the exclusion or limitation of incidental or consequential damages, so the above limitation of exclusion may not apply to you. **THIS WARRANTY IS EXPRESSLY IN LIEU OF ALL OTHER WARRANTIES, EXPRESS OR IMPLIED, INCLUDING THE WARRANTIES OF MERCHANTABILITY AND FITNESS.**

To take advantage of this warranty, the product or part must be returned to us with a pre-approve RMA# (Returned Material Authorization), proof of purchase date and an explanation of the complaint must accompany the merchandise. If our inspection verifies the defect, we will either repair or replace the product at our discretion or we may elect to refund the purchase price if we cannot readily and quickly provide you with a replacement. We will return repaired products at our expense, but if we determine there is no defect, or that the defect resulted from causes not within the scope of our warranty, then you must bear the cost of returning the product.

The warranty gives you specific legal rights and you may also have other rights which vary from state to state.