

EIKI

OWNER'S MANUAL

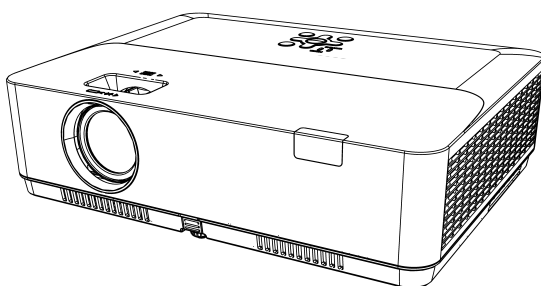

EK-120U
EK-121W

Features and Design

This Projector is designed with the most advanced technology for portability, durability, and ease of use. This projector utilizes built-in multimedia features, a palette of 10.7 million colors, and matrix liquid crystal display (LCD) technology.

Simple Computer System Setting

The projector has the Multi-scan system to conform to almost all computer output signals quickly. Up to WUXGA resolution can be accepted.

Useful Functions for Presentations

The digital zoom function allows you to focus on the crucial information during a presentation.

Lamp Control

Brightness of the projection lamp can be selected.

Logo Function

The Logo function allows you to customize the screen logo. *This function is not available on EK-120U.

Multilanguage Menu Display

The on screen menu of the projector is available in 26 languages: English, German, French, Italian, Spanish, Polish, Swedish, Dutch, Portuguese, Japanese, Simplified Chinese, Traditional Chinese, Korean, Russian, Arabic, Turkey, Finland, Norway, Denmark, Indonesia, Hungary, Czech Republic, Kazakhstan, Vietnamese, Thai, Farsi.

Helpful Maintenance Functions

Filter maintenance functions provide for better and proper maintenance of the projector.

Security Function

The Security function helps you to ensure security of the projector. With the Key lock function, you can lock the operation on the top control or remote control. PIN code lock function prevents unauthorized use of the projector.

LAN Network Function

This projector is loaded with the wired LAN function. You can operate and manage the projector via network. (Page 52-59.)

Auto Setup Function

This function enables input source search, auto pc adjust and auto keystone by simple pressing the AUTO button on the remote control.

Colorboard Function

At the time of simple projection on the colored wall, you can get the close color image to the color image projected on a white screen by selecting the similar color to the wall color from the preset four colors.

Power Management

The Power management function reduces power consumption and maintains the lamp life.

Closed Caption

This is a printed version of the program sound or other information displayed on the screen. You can turn on the feature and switch the channels.

✓ Note:

- The screen menu and pictures in the manual may slightly differ from the real product.
- The manual is subject to change without prior notice.

Contents

Features and Design	2	Setting	37
Contents	3	On start	37
Safety Instructions	4	Standby mode	37
Safety Guide	5	High land	38
Air circulation	6	Lamp control	38
Moving the projector	6	Cooling fast	38
Installing the projector properly	6	Closed Caption	39
Compliance	7	Key lock	39
Accessories	8	Iris	40
Part names and functions	9	Sound	40
Front	9	HDMI setup	41
Back	9	Expand	42
Bottom	9	Language	42
Terminals	10	Auto setup	42
Top control and Indicators	11	Keystone	43
Remote control	12	Logo	45
Install remote control batteries	13	Security	46
Operating range	13	Power management	47
Adjustable foot	13	Filter counter	47
Installation	14	Test Pattern	48
Positioning the projector	14	Network	48
Connecting to computer (Digital and analog RGB)	15	Factory default	49
Connecting to video equipment (Video)	16	Lamp counter reset	49
Connecting to audio equipment	17	Memory viewer	50
Connecting to USB device (USB-A, USB-B)	18	Set Slide	50
Connecting the AC power cord	19	Slide transition effect	50
Basic operation	20	Sort Order	50
Turn on the projector	20	Rotate	50
Turn off the projector	21	Best Fit	50
Adjust zoom and focus	22	Repeat	50
Auto setup function	22	Apply	50
Keystone	23	Information	51
Volume	24	Network Control Instructions	52
Remote control operation	25	LAN control	52
Input select	27	Using useful functions	60
How to operate the screen menu	28	Memory Viewer function	60
Menu bar	29	USB Display function	62
Display	30	Maintenance and cleaning	64
Auto PC adj.	30	WARNING indicator	64
Fine sync	30	Cleaning the filter	65
H Position	30	Filter counter reset	65
V Position	30	Clean the projector lens	66
H.Size	30	Clean the cabinet	66
Aspect	31	Appendix	67
Project Way	31	Troubleshooting	67
Menu Position	32	Menu Tree	69
Background Display	32	Indicator and projector state	73
System	33	Compatible computer specifications	74
Color adjust	34	Technical Specifications	75
Image Mode	34	Configurations of terminals	76
Color adjust (Computer)	35	Content of hazardous substances and elements	77
Color adjust (Video)	36	Dimensions	77
		PIN code memorandum	78





Safety Instructions

Please read this manual completely before installing and operating the projector.

The projector provides many convenient features and functions. Proper operation may enable you to fully utilize the features and keep it in good condition. Otherwise, it will not only shorten the service life of the unit, but also may cause malfunction, a fire, or other accidents.

If your projector cannot work properly, please read this manual again, check the operating methods and cable connection, and try the solutions in the part of Troubleshooting. If the problem still exists, contact the dealer or the service center.

The lamp of the projector is a wearing part. The luminance may decrease after a period of operation and be weaker than that of a new lamp. This is normal. Please strictly follow the steps in Turning on the unit and Turning off the unit to turn on/off the projector, and the requirements in Maintaining and cleaning the projector to service and clean the projector regularly. Otherwise the high temperature residual heat may not radiate, greatly shorten the service life of the projector and lamp, or even damage them within a short period.

 <div style="background-color: black; color: white; padding: 5px; text-align: center; font-weight: bold;"> Caution ELECTRIC SHOCK DO NOT OPEN </div> 
<p>CAUTION: TO REDUCE THE RISK OF ELECTRIC SHOCK, DO NOT REMOVE COVER (OR BACK). NO USER SERVICEABLE PARTS INSIDE EXCEPT LAMP REPLACEMENT. REFER SERVICING TO QUALIFIED SERVICE PERSONNEL.</p>
<p> THIS SYMBOL INDICATES THAT DANGEROUS VOLTAGE CONSTITUTING A RISK OF ELECTRIC SHOCK IS PRESENT WITHIN THIS UNIT.</p>
<p> THIS SYMBOL INDICATES THAT THERE ARE IMPORTANT OPERATING AND MAINTENANCE INSTRUCTIONS IN THE USER'S MANUAL WITH THIS UNIT.</p>

FOR EU USERS
 The symbol mark and recycling systems described below apply to EU countries and do not apply to countries in other areas of the world.
 Your product is designed and manufactured with high quality materials and components which can be recycled and/or reused.
 The symbol mark means that electrical and electronic equipment, batteries and accumulators, at their end of life, should be disposed of separately from your household waste.
 Note:
 If a chemical symbol is printed beneath the symbol mark, this chemical symbol means that the battery or accumulator contains a heavy metal at a certain concentration. This will be indicated as follows: Hg: mercury, Cd: cadmium, Pb: lead
 In the European Union there are separate collection systems for used electrical and electronic equipment, batteries and accumulators.
 Please, dispose of them correctly at your local community waste collection/recycling centre.
 Please help us to conserve the environment we live in!





Safety precautions

Caution:

- The projector must be grounded.
- Do not expose the projector to raindrops or high humidity to avoid a fire or electric shock.

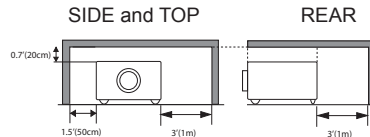
- This projector produces intense light from the projection lens. Avoid staring directly into the lens, otherwise eye damage could be caused. Be especially careful that children do not stare directly into the beam.
- Place the projector in a proper position. Otherwise it may result in fire hazard.
- Leave an appropriate space from the top, sides, and back of the shell in order to ventilate and cool down the projector. The figures below indicate the minimum distance to be left. It must be satisfied if the projector is placed in sealed environment like a cabinet.



- Do not cover the vent of the projector. Poor radiation may shorten the service life or even cause dangers.
- Remove the AC power plug if the projector is not to be used for a long time.
- Do not project the same image for a long time; otherwise, a residual image may appear on the LCD panel due to its characteristic.



Caution:

Do not set the projector in greasy, wet, or smoky conditions such as in a kitchen, to prevent a malfunction or accident. If the projector comes in contact with oil or chemicals, it may become deteriorated.

Read and keep this manual for future reference.

The mains plug/appliance coupler is used as disconnect device, the disconnect device shall remain readily operable.



Caution:

Contains mercury

For more information on safe handling procedures, the measures to be taken in case of accidental breakage and safe disposal options

visit: ec.gc.ca/mercure-mercury/

Dispose of or recycle in accordance with applicable laws.

Safety Guide

All the safety and operating instructions should be read before the product is operated.

Read all of the instructions given here and retain them for later use. Unplug this projector from AC power supply before cleaning. Do not use liquid or aerosol cleaners.

Use a damp cloth for cleaning.

Follow all warnings and instructions marked on the projector.

For added protection to the projector during a lightning storm, or when it is left unattended and unused for long periods of time, unplug it from the wall outlet. This will prevent damage due to lightning and power line surges.

Do not expose this unit to rain or use near water... for example, in a wet basement, near a swimming pool, etc...

Do not use attachments not recommended by the manufacturer as they may cause hazards. Do not place this projector on an unstable cart, stand, or table. The projector may fall, causing serious injury to a child or an adult, and serious damage to the projector.

Use only with a cart or stand recommended by the manufacturer, or sold with the projector. Wall or shelf mounting should follow the manufacturer's instructions, and should use a mounting kit approved by the manufacturers.

An appliance and cart combination should be moved with care. Quick stops, excessive force, and uneven surfaces may cause the appliance and cart combination to overturn.



Slots and openings in the back and bottom of the cabinet are provided for ventilation, to ensure reliable operation of the equipment and to protect it from overheating.

The openings should never be covered with cloth or other materials, and the bottom opening should not be blocked by placing the projector on a bed, sofa, rug, or other similar surface. This projector should never be placed near or over a radiator or heat register.

This projector should not be placed in a built-in installation such as a book case unless proper ventilation is provided.

Never push objects of any kind into this projector through cabinet slots as they may touch dangerous voltage points or short out parts that could result in a fire or electric shock. Never spill liquid of any kind on the projector.

Do not install the projector near the ventilation duct of air-conditioning equipment.

This projector should be operated only from the type of power source indicated on the marking label. If you are not sure of the type of power supplied, consult your authorized dealer or local power company.

Do not overload wall outlets and extension cords as this can result in fire or electric shock. Do not allow anything to rest on the power cord. Do not locate this projector where the cord may be damaged by persons walking on it.

Do not attempt to service this projector yourself as opening or removing Covers may expose you to dangerous voltage or other hazards. Refer all servicing to qualified service personnel.

Unplug this projector from wall outlet and refer servicing to qualified service personnel under the following conditions:

- When the power cord or plug is damaged or frayed.
- If liquid has been spilled into the projector.
- If the projector has been exposed to rain or water.
- If the projector does not operate normally by following the operating instructions. Adjust only those controls that are covered by the operating instructions as improper adjustment of other controls may result in damage and will often require extensive work by a qualified technician to restore the projector to normal operation.
- If the projector has been dropped or the cabinet has been damaged.
- When the projector exhibits a distinct change in performance-this indicates a need for service.

When replacement parts are required, be sure the service technician has used replacement parts specified by the manufacturer that have the same characteristics as the original part. Unauthorized substitutions may result in fire, electric shock, or injury to persons.

Upon completion of any service or repairs to this projector, ask the service technician to perform routine safety checks to determine that the projector is in safe operating condition.

Information for users in the European Union

This is a device to project images onto a screen, etc., and is not intended for use as indoor lighting in a domestic environment. Directive 2009/125/EC.

NOTE FOR CUSTOMERS IN THE US

(Hg) LAMP(S) INSIDE THIS PRODUCT CONTAIN MERCURY AND MUST BE RECYCLED OR DISPOSED OF ACCORDING TO LOCAL STATE OR FEDERAL LAWS.

Safety Guide

Air circulation

Vents in the cabinet are provided for ventilation. To ensure reliable operation of the product and to protect it from overheating, these openings must not be blocked or covered.



Caution

Hot air is exhausted from the exhaust vent. When using or installing the projector, the following precautions should be taken.

- Do not put any flammable objects, or spray can near the projector. Hot air is exhausted from the air vents.
- Keep the exhaust vent at least 1m away from any objects.
- Do not touch a peripheral part of the exhaust vent, especially screws and metallic part. This area will become hot while the projector is being used.
- Do not put anything on the projector. Objects put on the cabinet will not only get damaged but also may cause fire hazard by heat.
- Cooling fans are provided to cool down the projector.
- The fan's running speed is changed according to the temperature inside the projector.

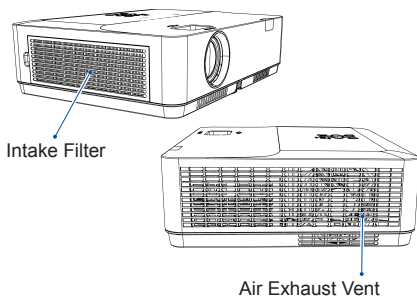

Moving the projector

When moving the projector, take care of the lens and retract the adjustable feet to prevent damage to the lens and cabinet.



Caution in moving or transporting the projector

- Do not drop or bump the projector, otherwise damages or malfunctions may result.
- When carrying the projector, use a suitable carrying case.

- Do not transport the projector by courier or any other transport service in an unsuitable transport case. This may cause damage to the projector. For more information about transporting the projector by courier or any other transport service, consult your dealer.
- Do not put the projector in a case before it is cooled enough.

Installing the projector properly

Please set the projector on nearly-level. Be sure to install the projector properly. Improper installation may reduce the lamp lifetime and even cause a fire hazard.

Do not roll the projector over 10° from side to side.

Do not pitch the projector more than 10° backward and forward.



Do not point the projector up to project an image.



Do not point the projector down to project an image.



Do not put the projector on either side to project an image.

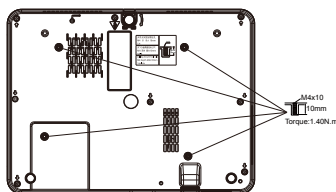

Caution in ceiling installation the projector

- Only qualified personal is authorized for ceiling installation.
- We are not responsible for the hurt and damage caused by ceiling bracket that purchased from unauthorized dealer even in warranty period.
- Remove the ceiling bracket immediately while not use.
- While installing, torque screwdriver is suggested, don't use electric or impact-type screwdriver.
- Please read the manual of bracket for details.

Compliance

FCC Caution

Note: This equipment has been tested and found to comply with the limits for a Class B digital device, pursuant to Part 15 of the FCC Rules. These limits are designed to provide reasonable protection against harmful interference in a residential installation. This equipment generates, uses, and can radiate radio frequency energy, and if not installed and used in accordance with the instructions, may cause harmful interference to radio communications. However, there is no guarantee that interference will not occur in a particular installation. If this equipment does cause harmful interference to radio or television reception, which can be determined by turning the equipment off and on, the user is encouraged to try to correct the interference by one or more of the following measures:

- Reorient or relocate the receiving antenna.
- Increase the separation between the equipment and receiver.
- Connect the equipment into an outlet on a circuit different from that to which the receiver is connected.
- Consult the dealer or an experienced radio/TV technician for help.

Use of shielded cable is required to comply with class B limits in Subpart B of Part 15 of FCC Rules.

Do not make any changes or modifications to the equipment unless otherwise specified in the instructions. If such changes or modifications should be made, you could be required to stop operation of the equipment.

Model Number : EK-120 series

Trade Name : EIKI

Responsible party : EIKI International, Inc.

Address : 30251 Esperanza Rancho Santa Margarita CA 92688-2132

Telephone No. : 800-242-3454 (949-457-0200)

AC Power Cord Requirement

The AC Power Cord supplied with this projector meets the requirement for use in the country you purchased it.

AC Power Cord for the United States and Canada:

AC Power Cord used in the United States and Canada is listed by the Underwriters Laboratories (UL) and certified by the Canadian Standard Association (CSA).

AC Power Cord has a grounding-type AC line plug. This is a safety feature to be sure that the plug will fit into the power outlet. Do not try to defeat this safety feature. Should you be unable to insert the plug into the outlet, contact your electrician.

AC Power Cord for the United Kingdom:

This cord is already fitted with a moulded plug incorporating a fuse, the value of which is indicated on the pin face of the plug. Should the fuse need to be replaced, an ASTA approved BS 1362 fuse must be used of the same rating, marked thus . If the fuse cover is detachable, never use the plug with the cover omitted. If a replacement fuse cover is required, ensure it is of the same colour as that visible on the pin face of the plug (i.e. red or orange). Fuse covers are available from the Parts Department indicated in your User Instructions.

If the plug supplied is not suitable for your socket outlet, it should be cut off and destroyed.

The end of the flexible cord should be suitably prepared and the correct plug fitted.

WARNING : A PLUG WITH BARED FLEXIBLE CORD IS HAZARDOUS IF ENGAGED IN A LIVE SOCKET OUTLET.

The Wires in this mains lead are coloured in accordance with the following code:

Green-and-yellow	Earth
Blue	Neutral
Brown	Live

As the colours of the wires in the mains lead of this apparatus may not correspond with the coloured markings identifying the terminals in your plug proceed as follows:

The wire which is coloured green-and-yellow must be connected to the terminal in the plug which is marked by the letter E or by the safety earth symbol  or coloured green or green-and-yellow.

The wire which is coloured blue must be connected to the terminal which is marked with the letter N or coloured black.

The wire which is coloured brown must be connected to the terminal which is marked with the letter L or coloured red.

WARNING: THIS APPARATUS MUST BE EARTHED.

THE SOCKET-OUTLET SHOULD BE INSTALLED NEAR THE EQUIPMENT AND EASILY ACCESSIBLE.

Accessories

AC Power cord

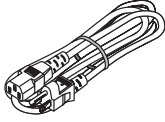

VGA cable

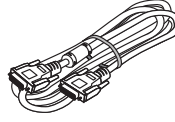

Remote control with batteries
(AAA or LR3)



Quick start guide

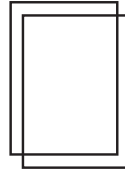

Safety Information



Part names and functions

Front

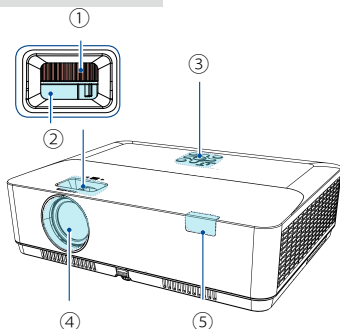

- ① Focus adjust ring
- ② Zoom adjust ring
- ③ Top control panel and indicator
- ④ Projector Lens
- ⑤ Remote control receiver (front)

Rear

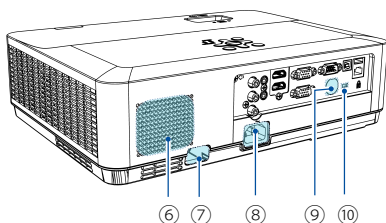

- ⑥ Speaker
- ⑦ Anti-theft bar
- ⑧ AC cord connector
- ⑨ Remote control receiver(rear)
- ⑩ Kensington Security Slot



Caution

- Kensington Security Slot is for a Kensington lock used to deter theft of the projector.
- Kensington is a registered trademark of ACCO Brands Corporation.

Bottom

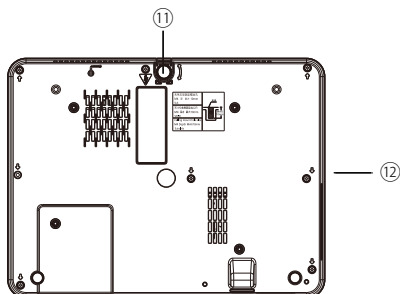

- ⑪ Adjustable foot
- ⑫ Exhaust vent



Caution

Hot air is exhausted from the exhaust vent. Do not put heat-sensitive objects near this side.

Part names and functions

Terminals

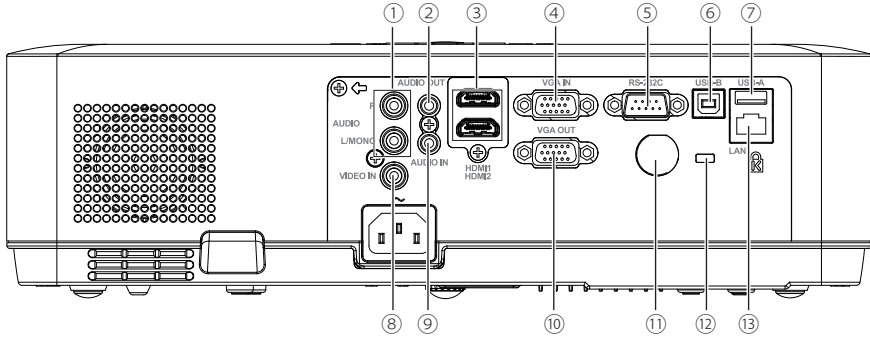

① MONO(R/L)

For a mono audio signal (a single audio jack), connect it to MONO(R/L) jack.

② AUDIO OUT

Connect external audio amplifier to this jack.

③ HDMI

This is the terminal to input the HDMI signals.

④ VGA IN

Connect a computer output to this terminal.

⑤ RS-232C

When using RS232 to control the projector, please connect the serial control line to this terminal.

⑥ USB-B

This terminal is used to connect the projector to the computer with a USB cable when you want to use the "USB Display" function.(Refer to Page 62-63).

⑦ USB-A

When using the "Memory Viewer" function, insert the USB memory directly to this terminal.(Refer to Page 60-61)

⑧ VIDEO IN

This is the terminal to input video signals.

⑨ AUDIO IN

This is the terminal to input computer audio signals.

⑩ VGA OUT

Output the analog signal form ② to other monitor.

⑪ Remote Control receiver(BACK)

Operation the projector by remote control.

⑫ Kensington Security Slot

This slot is for a Kensington lock used to deter theft of the projector.

* Kensington is a registered trademark of ACCO Brands Corporation

⑬ LAN

- This is the LAN terminal to connect to the network.

- Connect the projector to the computer via RJ45 cable when you use the "Network" Display function.

Part names and functions

Top control and Indicators

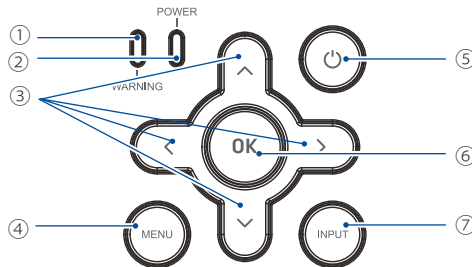

- ① **WARNING indicator(Refer to Page 73)**
 - It flashes red when the internal projector temperature is beyond the operating temperature range.
- ② **POWER indicator(Refer to Page 73)**
 - It lights red when the projector is in stand-by mode.
 - It lights green during normal operations.
 - It flashes green during the Power management mode.
 - It flashes red during fans cooling.
 - It turns steady green-yellow while the power is abnormal.
- ③ **▲▼◀▶/UP/DOWN/VOL+/VOL-**
 - Select an item or adjust the value in the screen menu.
 - Select the image display area in D.zoom + mode.
 - Increase or decrease volume.
- ④ **MENU**
 - Open or close the screen menu.
- ⑤ **POWER**
 - Turn on/off the projector.
- ⑥ **OK**
 - Enter menu operation.
 - Execute the selected item.
- ⑦ **INPUT**
 - Select an input source.

Part names and functions

Remote control

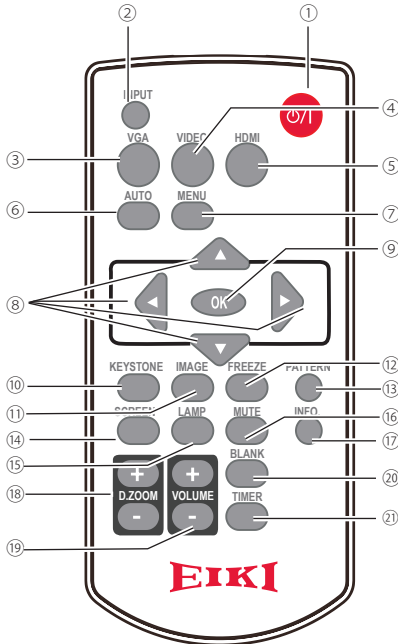

- ① **POWER**
Turn on or turn off the projector.
- ② **INPUT**
Open or close the input source menu.
- ③ **VGA**
Select "Computer 1" as input source.
- ④ **VIDEO**
Select "Video" as input source.
- ⑤ **HDMI**
Select "HDMI" as input source.
- ⑥ **AUTO**
Enter auto setup adjust mode.
- ⑦ **MENU**
Open or close the screen menu.
- ⑧ **▲▼◀▶ button**
- Select item or adjust the value in screen menu.
- Select the image display area in digital zoom + mode.
- ⑨ **OK**
Enter the menu or select an item in the menu.
- ⑩ **KEYSTONE**
Correct the keystone distortion.
- ⑪ **IMAGE**
Select the image mode.
- ⑫ **FREEZE**
Freeze the projected image.
- ⑬ **PATTERN**
Set the internal test image.
- ⑭ **SCREEN**
Select the screen size.
- ⑮ **LAMP**
Select the lamp mode.
- ⑯ **MUTE**
Turn off the volume.
- ⑰ **INFO.**
Display the projector information.
- ⑱ **D.ZOOM +/-**
Digital zoom in / zoom out the image.
- ⑲ **VOLUME +/-**
Increase / decrease the volume.
- ⑳ **BLANK**
Temporarily close the image on the screen.
- ㉑ **TIMER**
Enable the timer function.



PATTERN button on the remote controller is invalid when you choose USB display, Memory viewer and Network as input signal.

Part names and functions

Install remote control batteries

- ① Open the battery cover.

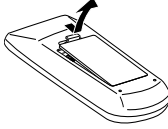

- ② Install new batteries.

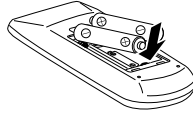

Two AAA batteries
For correct polarity (+ and -), be sure battery terminals are in contact with pins in the compartment.

- ③ Put the cover back.

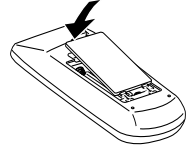

To ensure safe operation, please observe the following precautions:

- Use two (2) AAA or LR3 type alkaline batteries.
- Always replace batteries in sets.
- Do not use a new battery with a used battery.
- Avoid contact with water or liquid matter.
- Do not expose the remote control to moisture or heat.
- Do not drop the remote control.
- If the battery has leaked in the remote control, carefully wipe the case clean and install new batteries.
- Risk of explosion if two batteries are replaced by an incorrect type.
- Dispose of used batteries according to the instructions on the battery or local regulations or guides.

Operating range

Point the remote control toward the remote control receivers on the projector (front and back) when pressing any button.

The maximum operating range for the remote control is about 5 meters and 60 degrees.

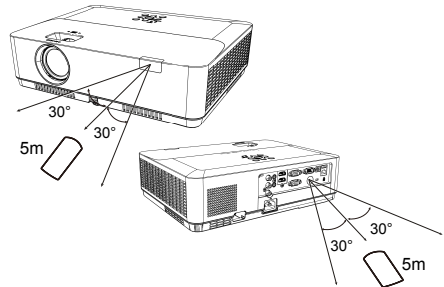

Adjustable foot

The projector can be adjusted up to 40 mm (10 degree) with the adjustable foot.

Rotate the adjustable foot to lift the projector to a certain height. During lifting, rotate the foot clockwise.

To lower or retract the adjustable foot, rotate the foot counterclockwise.

Keystone distortion of projected images can be corrected by auto settings, remote control operation or menu operation.

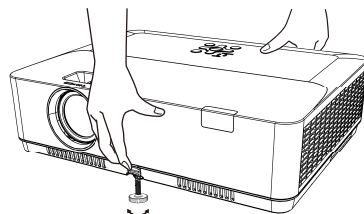

Adjustable foot

Installation

Positioning the projector

✓ *Note:*

- The brightness in a room has a great influence on picture quality. It is recommended to limit the ambient lighting in order to get the best image.
- All measurements are approximate and may vary from the actual sizes.

WXGA model:

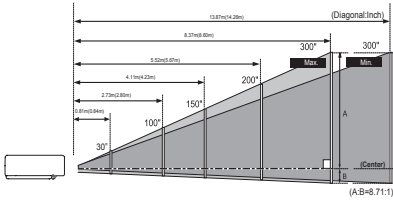

✓ *Note:*

The data in "()" is the project distance for 16:9 aspect ratio.

WUXGA model:

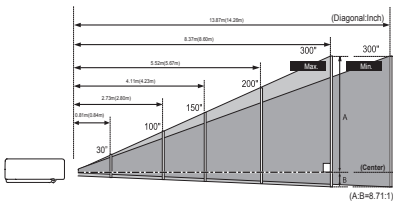

✓ *Note:*

The data in "()" is the project distance for 16:9 aspect ratio.

16:10

Screen size (WxH)mm	30"	100"	150"	200"	300"
16:10 aspect ratio	646x404	2154x1346	3231x2019	4308x2692	6462x4039
Minimum	1.35m	4.52m	6.82m	9.15m	13.87m
Maximum	0.81m	2.73m	4.11m	5.52m	8.37m

16:9

Screen size (WxH)mm	30"	100"	150"	200"	300"
16:9 aspect ratio	664x374	2214x1245	3321x1868	4428x2491	6641x3736
Minimum	1.38m	4.65m	7.01m	9.41m	14.26m
Maximum	0.84m	2.80m	4.23m	5.67m	8.60m

16:10

Screen size (WxH)mm	30"	100"	150"	200"	300"
16:10 aspect ratio	646x404	2154x1346	3231x2019	4308x2692	6462x4039
Minimum	1.35m	4.52m	6.82m	9.15m	13.87m
Maximum	0.81m	2.73m	4.11m	5.52m	8.37m

16:9

Screen size (WxH)mm	30"	100"	150"	200"	300"
16:9 aspect ratio	664x374	2214x1245	3321x1868	4428x2491	6641x3736
Minimum	1.38m	4.65m	7.01m	9.41m	14.26m
Maximum	0.84m	2.80m	4.23m	5.67m	8.60m

Installation

Connecting to computer (Digital and analog RGB)

Cables used for connection:

- VGA cable
- HDMI cable*
- Serial cable(crossover type)*

(*=Cables are not supplied with the projector)

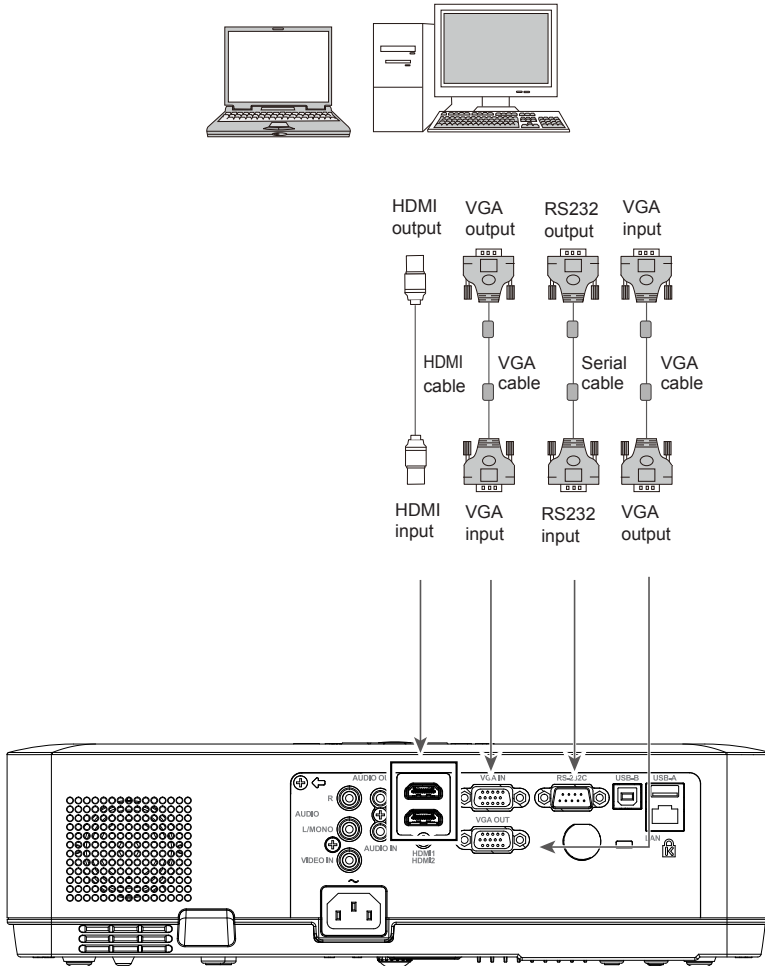

Unplug the power cords of both the projector and external equipment from the AC outlet before connecting the cables.

Installation

Connecting to video equipment (Video, S-Video)

Cables used for connection:

- S-video cable**
- Video cable*
- Component conversion cable*

(*=Cables are not supplied with the projector)

**=Dedicated cable is required and can be ordered through your dealer)

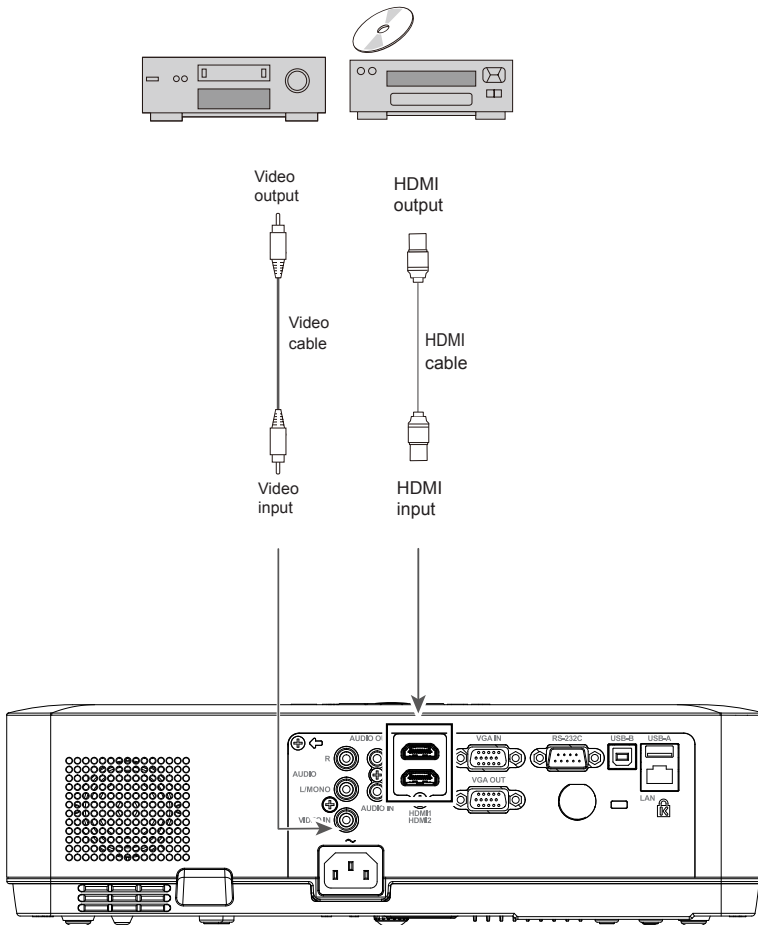

Unplug the power cords of both the projector and external equipment from the AC outlet before connecting the cables.

Installation

Connecting to audio equipment

Cables used for connection:

- Audio cable*

(*=Cables are not supplied with the projector)

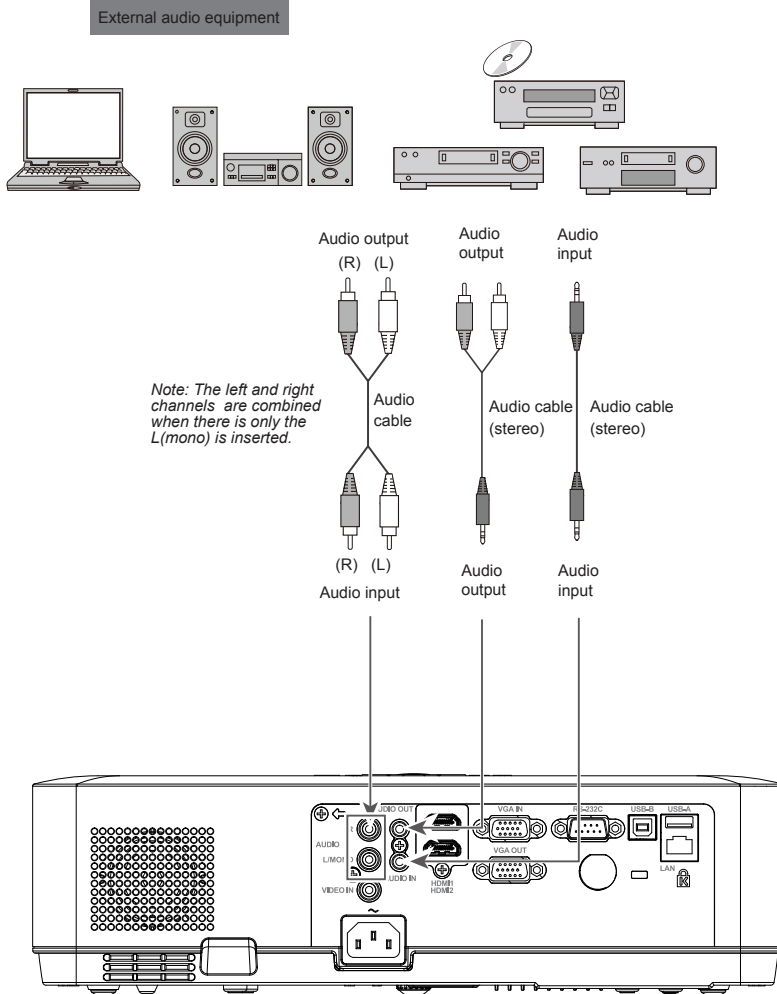

Unplug the power cords of both the projector and external equipment from the AC outlet before connecting the cables.

Installation

Connecting to USB device (USB-A, USB-B)

Cables used for connection:

- USB-B cable*

(*=Cables are not supplied with the projector)

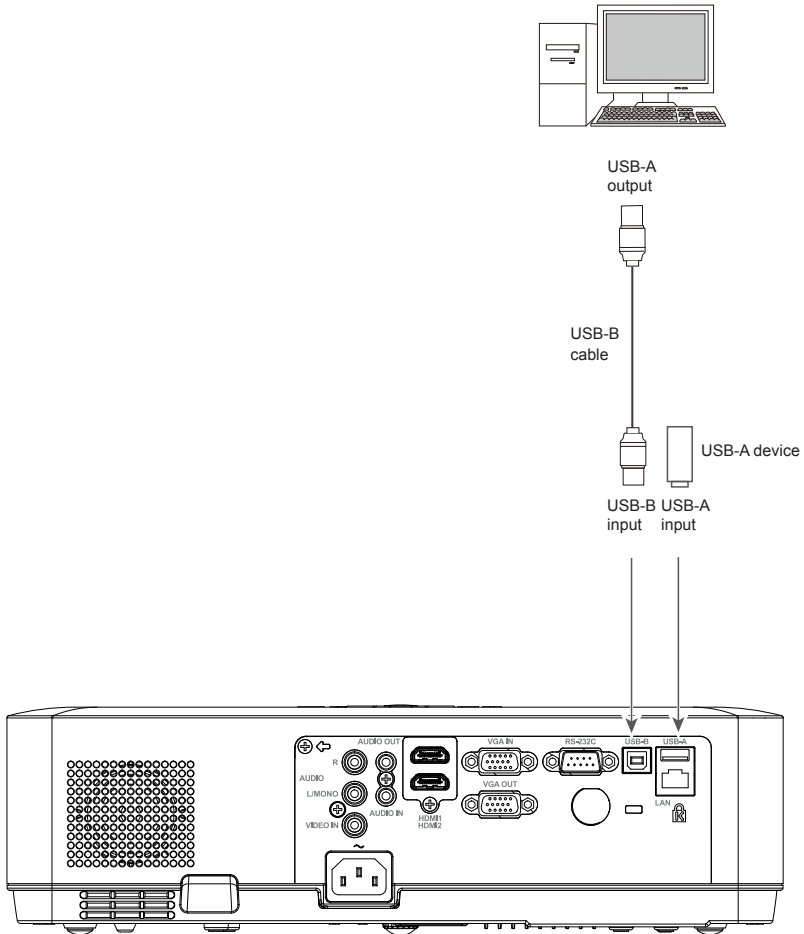

Unplug the power cords of both the projector and external equipment from the AC outlet before connecting the cables.

Installation

Connecting the AC power cord

This projector uses nominal input voltages of 100–240V AC and it automatically applies to different input voltages. It is designed to work with a single-phase power system having a grounded neutral conductor. To reduce the risk of electrical shock, do not plug into any other type of power system. If you are not sure of the type of power being supplied, consult your authorized dealer or service station. Connect the projector with all peripheral equipment before turning it on.

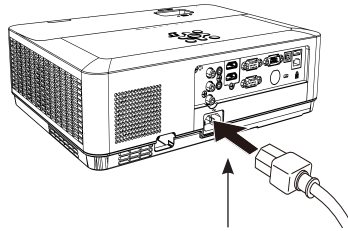

Connect the AC power cord (supplied) to the projector.



Note:

The AC outlet should be near this equipment and must be easily accessible.

✓ Note:

For safety, unplug the AC power cord when the projector is not in use. When the projector is connected to an outlet with AC power cord, it is in stand-by mode and consumes a little electric power.

Note on the power cord

AC power cord must meet the requirements of the country where you use the projector. Confirm the AC plug type with the chart below and proper AC power cord must be used. If the supplied AC power cord does not match your AC outlet, contact your sales dealer.

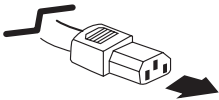
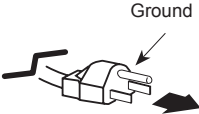
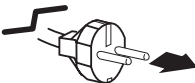
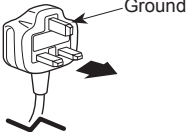
Projector side	AC outlet side		
	For the U.S.A. and Canada	For Continental Europe	For the U.K.
 To power cord connector on your projector.	 To the AC outlet.	 To the AC outlet.	 To the AC outlet.

✓ Note:

- *Using incorrect power cord may influence the product performance, or even cause hazards like an electric shock or fire. To ensure the product performance and security, please apply the cable of the same model with the original one.*

Basic operation

Turn on the projector

1. Complete peripheral connections (with a computer, video, etc.) before turning on the projector.
2. Connect the projector's AC power cord into the AC outlet. The POWER indicator turns red.
3. Press the POWER button on the top control or on the remote control. The POWER indicator becomes green and the cooling fans start to work. The preparation display appears on the screen.
4. If the projector is locked with a PIN code, a PIN code input dialog box appears. Enter the PIN code as instructed below.

✓ *Note:*

- When the logo select is set to be "Off", the logo will not be displayed on the screen. (See page 46)

Enter a PIN code

Press the OK button, press ◀▶ button to select a number and press the OK button to enter it to the PIN code box, then number changes to "*", automatically move the cursor to next box. If you fixed an incorrect number, press MENU button to reset it again. Repeat the steps to complete entering a three-digit number.

After entering the three-digit number, automatically move the cursor to "Set", press the OK button then you can start to operate the projector.

If you entered an incorrect "PIN code", the number (***) turn red. PIN code will be reset within one second automatically. Enter the correct PIN code all over again.

What is PIN code?

PIN (Personal Identification Number) code is a security code that allows the person who knows it to operate the projector. Setting the PIN code can prevent unauthorized use of the projector. A PIN code consists of a three-digit number. Refer to the PIN code lock function in the "Expand" "Security" menu on page 47 for PIN code lock operation of the projector.

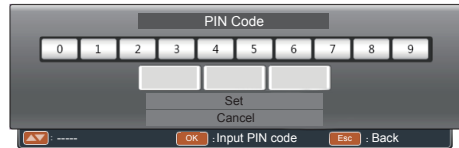

Move the cursor to "Set", and press "OK".



Caution on handling the PIN code
If you forget your PIN code, the projector can no longer be started. Take a special care in setting a new PIN code. Write down the number in a column on page 81 of this manual and keep it properly. Should the PIN code be missing or forgotten, consult your dealer or service center.

Basic operation

Turn off the projector

1. Press the POWER button on the top control or on the remote control, and "Power off?" appears on the screen.
2. Then, press the POWER button again in 4 seconds. The POWER indicator starts to flash red, and the cooling fans keep running (You can select the fan noise and running speed). Now you can unplug the AC power cord after the fans stop running. Otherwise, the service life of the projector will be affected or the projector will can not be turned on or turn on abnormal.
- 3 When the projector has cooled down enough to be turned on again, the POWER indicator stops flashing.

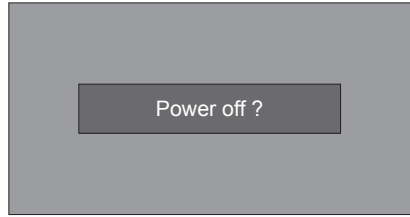

"Power off ?" disappears after 4 seconds.



To maintain the lamp life, once you turn the projector on, wait at least 5 minutes before turning it off.



Do not operate the projector continuously without reset. Continuous use may result in shortening the lamp life. Turn off the projector and let it standby for about an hour in every 24 hours.

✓ *Note:*

- *When the On start function is "On" , this projector is turned on automatically by connecting the AC power cord to an AC outlet .*
- *The running speed of cooling fans is changed according to the temperature inside the projector.*
- *Do not put the projector in a case before it is cooled enough.*
- *If the POWER indicator flashes or emits a red light, see page 76.*
- *While the POWER indicator is flashing, the lamp is being cooled down and the projector cannot be turned on. Wait until the POWER indicator turns red to turn on the projector again.*
- *The fan rotation will terminate directly if the AC power cord is unplugged immediately after the projector is turned off.*
- *The projector can be turned on after the POWER indicator turns red. The waiting time to restart will be shortened when the normal power-off processing for fan cooling is completed, comparing with the time the AC power cord is immediately unplugged after the power-off.*

Basic operation

Adjust zoom and focus

Rotate the ZOOM ring to zoom in or zoom out the image.

Rotate the FOCUS ring to adjust the focus of the image.

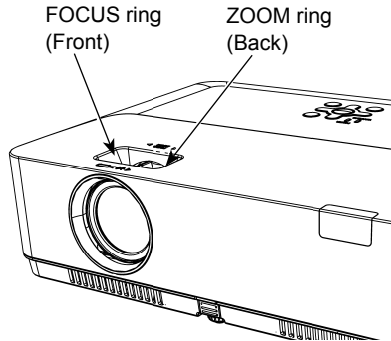

Auto setup function

Auto setup function is available just by pressing the AUTO button on the Remote controller.

The system will be worked automatically below settings. (Page 42)

Auto PC adj. : ON

Auto keystone : Manual

Remote control

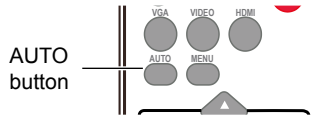

Basic operation

Keystone

If a projected image has keystone distortion, follow the steps below to manually correct the keystone distortion.

Press KEYSTONE button on the remote control. The Keystone screen will displayed, (it includes: H/V Keystone, Corner correction, Curved correction and Reset value), press ▲▼ to select the item.

H/V Keystone

Adjusts when the horizontal or vertical trapezoid of the projected image is distorted.

Corner correction

Adjusts when the four corners of the projected image are distorted.

Curved correction

Adjusts when the linearity is not uniform or the vertical and horizontal lines are distorted. (This function is not available for EK-120U)

Reset value

Return the corrected values to the factory default values.

Remote control

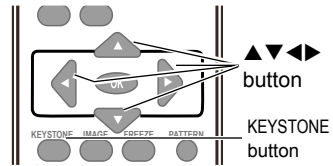

Keystone screen

(EK-121W)

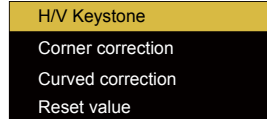

(EK-120U)

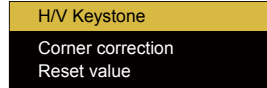

H/V Keystone

- The arrows are white when there is no correction.
- The arrows that are used for correction turns red.
- Press ▲▼◀▶ button long time, the arrows turn red and can be adjusted quickly
- The arrows disappear at the maximum correction.
- If you press the KEYSTONE button on the remote control once again while the keystone dialog box is being displayed, the keystone adjustment is canceled.
- The adjustable range can be limited depending on the input signal.

Basic operation

Volume

Direct operation

Volume

Press the VOLUME +/- buttons on the remote control or top control to adjust the volume.

Mute

Press the MUTE button on the remote control and select "On" to turn off the audio temporarily. To restore the audio to its previous level, press the MUTE button again and select "Off" or press the VOLUME +/- buttons.

Mute function is also effective for AUDIO OUT jack.

Top control

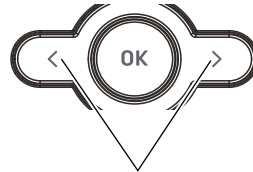

VOLUME +/- button

Remote control

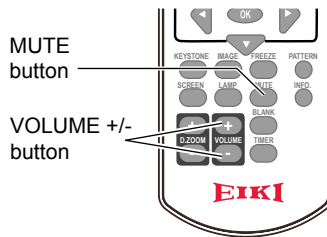

Menu operation

1 Press the MENU button to display the screen menu. Press ▲▼ button to select the "Setting" menu icon. Press the OK button to enter the submenu entry.

2 Press ▲▼ button to select "Sound" and then press the OK button.

3 Press ▲▼ button to select "Volume" or "Mute" to adjust.

Volume

Press ▲ to increase the volume and ▼ to decrease the volume.

Mute

Press ▲▼ button to switch the mute function (On/Off).

4 Press the OK button to select.

Volume menu

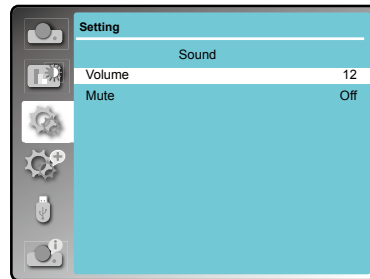

Basic operation

Remote control operation

Using the remote control for some frequently used operations is advisable. Just pressing one of the buttons enables you to quickly without calling up the screen menu.

FREEZE button

Press FREEZE button on the remote control, video will be paused and the audio is muted. The icon is displayed on the screen during Freeze. Press FREEZE button again, the video playback resumes and the audio is unmuted.

MUTE button

Press MUTE button on the remote control to turn off the volume. Press MUTE button again or VOLUME +/- button to cancel mute function.

VOLUME +/- button

Press VOLUME +/- button on the remote control to increase or decrease the volume.

IMAGE button

Press IMAGE button on the remote control to select the image mode you want.
(Dynamic / Standard / Cinema / Blackboard (Green) / Colorboard / User Image)

LAMP button

Press LAMP button to select a lamp mode to change the brightness of the screen.

- ☹ Normal ...Normal brightness.
- ☹ ECO Lower brightness, reducing the lamp power consumption and extending the lamp life.

INFO button

Press INFO button on the remote control to display the projector information.

Remote control

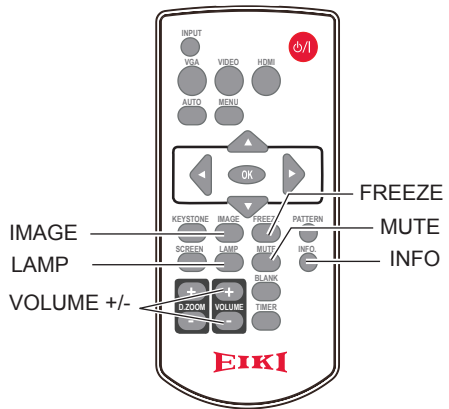

✓ *Note:*

See the next page for the description of other buttons.

Basic operation

BLANK button

Press BLANK button on the remote control to black out the image. To restore to normal, press the BLANK button again or press any other button.

The screen changes each time you press the button as follows:

Black out → Normal → Black out → Normal ...

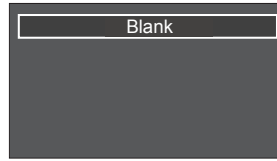

"Blank" disappears after 2 seconds if there is no other button operation.

TIMER button

Press TIMER button. The timer display "00:00" appears on the screen and the timer starts to count time (00:00–59:59).

To stop the Timer, press TIMER button. Press TIMER button again, and then the Timer display disappears.



Timer display

SCREEN button

Press SCREEN button on the remote control to select the screen size you want. (Normal / Wide / Full)

*"Full" is not available for EK-120U

D.ZOOM+ button

Press D.ZOOM+ button, the on-screen menu will disappear after for a while.

Press ▲ ▼ ◀ ▶ to move the image horizontally and vertically.

The moving is effective only when the image is larger than the size of the screen.

*D.ZOOM function does not work while Timer is ON

D.ZOOM- button

Press D.ZOOM- button, the on-screen menu will disappear while the information on digital zoom appears.

*D.ZOOM function does not work while Timer is ON

To return to normal size, select "SCREEN" button on the remote control to adjust screen size.

Remote control

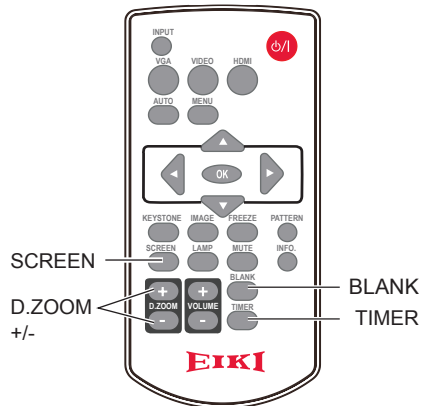

Basic operation

Input select

Direct Operation

Press VGA, ViIcE or HDMI on the remote control as input source.

Menu operation

1 Press INPUT button on the top control or remote control to display the input select menu.

2 Press ▲▼ button to select VGA, HDMI, HDMI 2, Video, Network, Memory Viewer or USB Display, then press the OK button.

VGA

When input source is from computer connected to VGA IN terminal with VGA cable, please select "VGA".

HDMI 1

When input source is from equipment connected to HDMI terminal with HDMI cable, please select "HDMI".

HDMI 2

When input source is from equipment connected to HDMI 2 terminal with HDMI cable, please select "HDMI 2".

Video

Select it when the video input signal is connected to VIDEO IN terminal.

Network

When input source is from network connected to LAN terminal with LAN cable, please select "Network".

Memory Viewer

When input source is from device connected to USB-A terminal, please select "Memory Viewer".

USB Display

When input source is from device connected to USB-B terminal, please select "USB Display".

Remote control

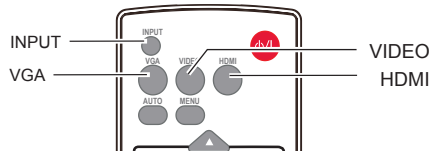

Top control

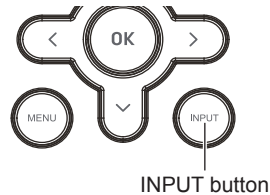

Input select menu

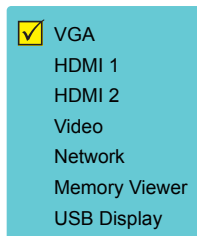

✓ Note:

- When the "Input search" function is set to "On" in the "Auto setup" function, press AUTO button, the input signal will be searched automatically.
- When signal is in "USB Display", "Memory Viewer" and "Network", FREEZE, ASPECT, IMAGE, AUTO SETUP and SCREEN function cannot work.
- Memory Viewer function, please refer to page 60-61.
- USB Display function, please refer to page 62

Basic operation

How to operate the screen menu

The projector can be adjusted or set via the on-screen menu. Each main menu can be divided into several levels of submenus, and submenus are also divided into several levels of submenus.

For each adjustment and setting procedure, refer to the respective sections in this manual.

1 Press the MENU button on the remote control or top control to display the screen menu.

2 Press ▲▼ buttons to select an entry in the main menu and then press the OK button to enter the submenu.

3 Press ▲▼ buttons to select an item, and then press the OK button to set or enter the submenu.

4 Press ▲▼ buttons to adjust settings or switch among the items. Press the OK button for corresponding operation.

5 Press ◀ button on the remote control or top control to go back to the previous menu. Press MENU button again to exit the screen menu.

Top control

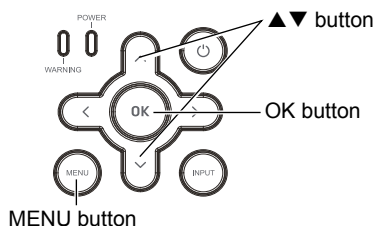

Remote control

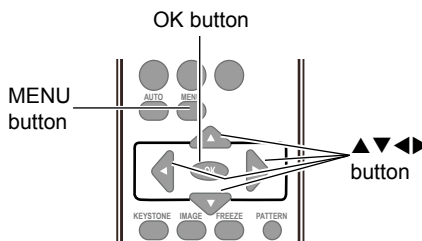

Screen menu

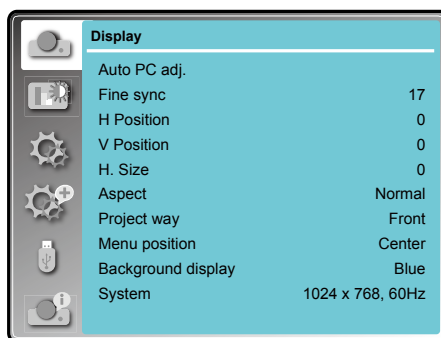

Basic operation

Menu bar

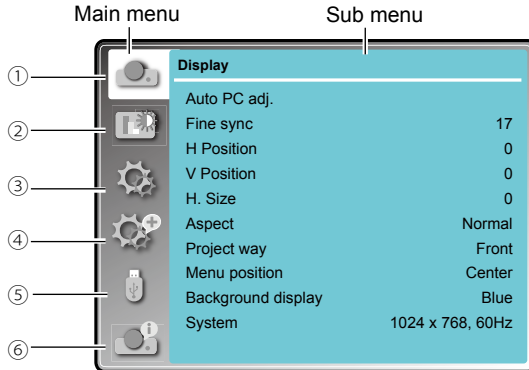

① Display

- Adjust computer parameters to match with VGA input signal format: **Auto PC adj.**, **Fine sync**, **H Position**, **V Position** and **H.Size**.
- **Aspect**: **Normal** and **Wide**.
- **Project way**: select a project way among **Front**, **Rear**, **Ceiling/Front**, **Ceiling/Rear**, **Auto ceiling/Front** and **Auto ceiling/Rear**.
- **Menu position**: set the menu's position on the screen.
- **Background display**: set the background display color.
- **System**: select a system signal format to match the input source.

② Color adjust

- **Image mode**: the available image modes is **Standard**, **Dynamic**, **User Image**, **Colorboard**, **Blackboard(Green)** or **Cinema**.
- Image color adjust:
If a computer is selected as a signal source, the following image adjusting options are available: **Contrast**, **Brightness**, **Color temp.**, **White balance (R/G/B)** and **Sharpness**.
If video equipment is selected as a signal source, the following image adjusting options are available: **Contrast**, **Brightness**, **Color**, **Tint**, **White balance (R/G/B)** and **Sharpness**.

③ Setting

Configure basic operation settings of the projector: **On start**, **Standby mode**, **High land**, **Lamp control**, **Cooling fast**, **Closed caption**, **Key lock**, **Iris**, **Terminal**, **Sound** and **HDMI setup**.

④ Expand

Configure expand operation settings of the projector: **Language**, **Auto setup**, **Keystone**, **Logo**, **Security**, **Power management**, **Filter counter**, **Test Pattern**, **Network**, **Factory default** and **Lamp counter**.

⑤ Memory viewer

Configure operation settings for Memory Viewer function: **Set Slide**, **Slide transition effect**, **Sort order**, **Rotate**, **Best fit**, **Repeat** and **Apply**.

⑥ Info.

The system information of the projector.

Display

Auto PC adj.

Auto PC Adjustment function is provided to automatically adjust Fine sync, Horizontal, Vertical and H.Size to conform to your computer.

Menu operation

Auto PC adj.

1. Press MENU button on the remote control or top control to display screen menu. Press **▲▼** button to select "Display", then press the OK button.
2. Press **▲▼** button to select "Auto PC adj.", then press the OK button. "Please wait" will be displayed on the screen, the Auto PC adj. function will be executed.

Auto PC adj. Menu

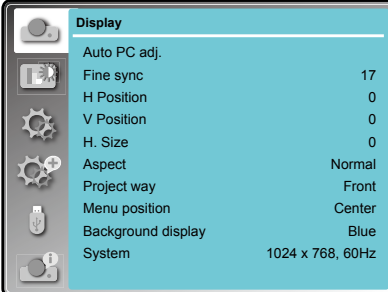

Display	
Auto PC adj.	
Fine sync	17
H Position	0
V Position	0
H. Size	0
Aspect	Normal
Project way	Front
Menu position	Center
Background display	Blue
System	1024 x 768, 60Hz

Fine sync

You can cut off flicker from the image displayed by pressing **▲▼** to adjust the value.(from 0 to 31).

H Position

Press **▲▼** to adjust the horizontal image position.

V Position

Press **▲▼** to adjust the vertical image position.

H.Size

This function is used to adjust and minimize the effect of interference caused by projection of patterns consisting of vertical stripes. The projection of the vertical striped pattern may cause cyclic patterns (noise). Adjust to minimize the amount of interference.(From -15 to +15). H.Size must be set before adjust Fine sync.

√ Note:

The adjustment of Fine sync, H Position, V Position and H.Size is only for computer signal input.

√ Note:

- The projector executes the Auto PC adj. automatically when the computer signals input the projector for the first time.
- Automatic adjustment may not work depending on the model of the computer and the input signal.
- The Auto PC adj. cannot be operated when 480i, 576i, 480p, 576p, 720p 1080i or 1080p is selected in the "Display" menu → "System", or when the signal is coming from the HDMI terminal.

Display

Aspect

You can set a screen size to fit the image while maintaining the aspect ratio of the input signal.

1. Press ▲▼ to select "Aspect" and then press the OK button.
2. Press ▲▼ button to select the item, then press the OK button.

Normal

Projects the image at the maximum size while maintaining the aspect ratio of the input signal.

Wide

Projects the image at 16:9 aspect ratio.

Full (EK-121W only)

To provide an image to fit the screen.

Advanced (EK-121W only)

Adjust the proportion and position of the screen manually.

*Can only with VGA as input source.

Aspect menu

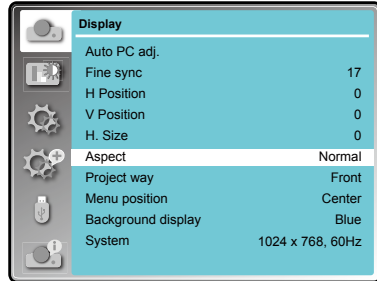

Display	
Auto PC adj.	
Fine sync	17
H Position	0
V Position	0
H. Size	0
Aspect	Normal
Project way	Front
Menu position	Center
Background display	Blue
System	1024 x 768, 60Hz

Project Way

This function is used to set the project way.

- 1 Press MENU button on the remote control to display screen menu. Press ▲▼ button to select "Display", then press the OK button.
- 2 Press ▲▼ button to select "Project way", press the OK button.
- 3 Press ▲▼ button to select the item you want to set, press the OK button.

Front

Projects to front screen when projector is front standing.

Rear

Projects to rear screen when projector is front standing.

Ceiling/Front

Projects to front screen when projector is in ceiling state.

Ceiling/Rear

Projects to rear screen when projector is in ceiling state.

Auto ceiling/Front

Projects to front screen and modify as front standing or ceiling automatically.

Auto ceiling/Rear

Projects to rear screen and modify as front standing or ceiling automatically.

Project way menu

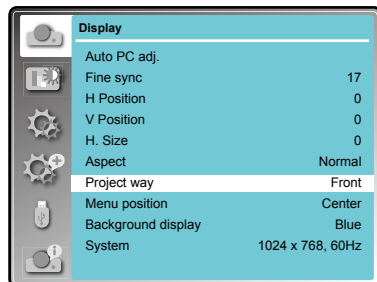

Display	
Auto PC adj.	
Fine sync	17
H Position	0
V Position	0
H. Size	0
Aspect	Normal
Project way	Front
Menu position	Center
Background display	Blue
System	1024 x 768, 60Hz

Display

Menu Position

This function is used to change the position of screen menu.

- 1 Press MENU button on the remote control to display screen menu. Press ▲▼ button to select "Display", then press the OK button.
- 2 Press ▲▼ button to select "Menu position", press the OK button.
- 3 Press ▲▼ button to select the item you want to set, press the OK button.

Upper left

Menu locates on upper left of the screen.

Upper right

Menu locates on upper right of the screen.

Center

Menu locates at the center of the screen.

Lower left

Menu locates on lower left of the screen.

Lower right

Menu locates on lower right of the screen.

Menu position

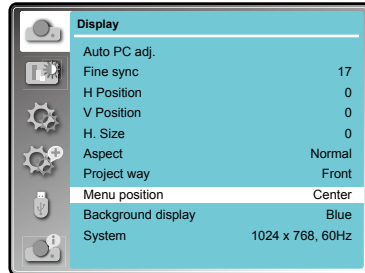

Display	
Auto PC adj.	
Fine sync	17
H Position	0
V Position	0
H. Size	0
Aspect	Normal
Project way	Front
Menu position	Center
Background display	Blue
System	1024 x 768, 60Hz

Background Display

This function is used to select the screen background of the projector when there is no signal detected.

- 1 Press MENU button on the remote control or top control to display screen menu. Press ▲▼ button to select "Display", then press the OK button.
- 2 Press ▲▼ button to select "Background display", press the OK button.
- 3 Press ▲▼ button to select the item you want to set, press the OK button.

Black Select black background.

Blue Select blue background.

Background display

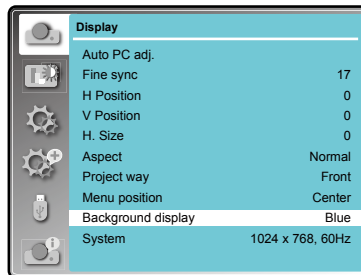

Display	
Auto PC adj.	
Fine sync	17
H Position	0
V Position	0
H. Size	0
Aspect	Normal
Project way	Front
Menu position	Center
Background display	Blue
System	1024 x 768, 60Hz

✓ *Note:*

this function will be invalid once you select input signal as usb display, memory viewer and network.

Display

System

Computer system select

The projector automatically tunes to various types of computers with its function of Multi-scan system and Auto PC Adjustment. If a computer is selected as a signal source, the projector automatically detects the signal format and tunes to project proper images without any additional setting.

One of the following messages may appear:

Auto

When the projector cannot recognize the connected signal conforming to the provided computer system, Auto is displayed on the System menu box and the Auto PC Adj. function works to display proper images. If the image is not projected properly, a manual adjustment is required.

There is no signal input from computer. Check the connection between your computer and projector.

Select computer system manually

The system can also be selected manually.

- 1 Press MENU button on the remote control or on top control to display the screen menu. Press ▲▼ button to select the "Display" icon, and press the OK button.
- 2 Press ▲▼ button to select "System" and press the OK button.
- 3 Press ▲▼ button to select your required system, and then press the OK button.

✓ Note:

When HDMI, Network, Memory Viewer, USB Display is selected, System menu for computer is disable.

Video

Auto

The projector automatically detects an incoming video system, and adjusts itself to optimize its performance. When Video System is PAL-M, PAL-N or PAL60, select the system manually.

PAL/SECAM/NTSC/NTSC4.43/PAL-M/PAL-N/PAL60

If the projector cannot reproduce proper video images, select a specific broadcast signal format from PAL, SECAM, NTSC, NTSC 4.43, PAL-M, PAL-N and PAL60.

System menu

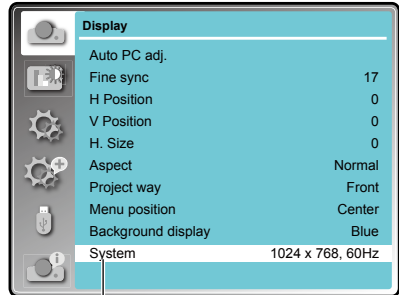

System

System for computer signal

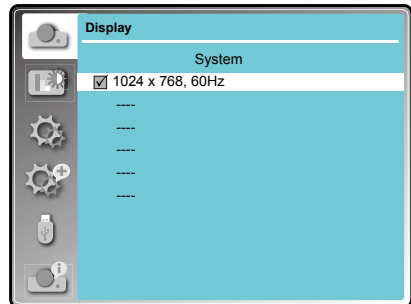

System for Video or S-video signal

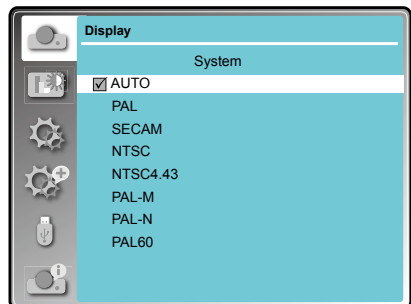

Color adjust

Color adjust menu is used to set the image mode and adjust the image.

- 1 Press MENU button on the remote control or top control to display screen menu. Press ▲▼ button to select "Color adjust", then press the OK button.
- 2 Press▲▼ button to select the item you want to set, press the OK button.
- 3 Press▲▼ button to adjust the item, then press the OK button.

Image Mode

Direct operation

Press IMAGE button on the remote control to select the image mode.

Menu operation

- 1 Press MENU button on the remote control or top control to display screen menu. Press ▲▼ button to select "Color adjust" menu, then press the OK button.
- 2 Press▲▼ button to select "Image mode", press the OK button.
- 3 Press▲▼ button to select the item you want to set, press the OK button.

Dynamic

The light output is maximized for use in bright areas.

Standard

The picture becomes suitable for moving images in general.

Cinema

For watching movies with multiple gray scale levels.

Blackboard (Green)

For viewing the image projected on a blackboard (green) by enhancing the image quality. This is mainly effective on a green colored board instead of a black colored board.

Colorboard

For images projected onto a red, blue, yellow, or green wallpaper.

User Image

Image quality preset by the user in the Image adjustment menu.

Top control

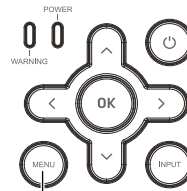

MENU button

Remote control

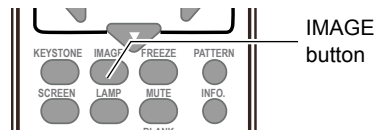

IMAGE button

Image mode (Computer)

Color adjust	
Image mode	Standard
Contrast	32
Brightness	32
Color temp.	Mid
Red	32
Green	32
Blue	32
Sharpness	8

Color adjust

Color adjust (Computer)

- 1 Press MENU button on the remote control or top control to display screen menu. Press ▲▼ button to select "Color adjust", then press the OK button.
- 2 Press▲▼ button to select the item you want to set, press the OK button.
- 3 Press▲▼ button to adjust the data.

Contrast

Press ▼ to decrease the contrast and ▲ to increase it.

Brightness

Press ▼ to decrease the brightness and ▲ to increase it.

Color temp.

Press▲▼ to select color temperature.(Low, Mid and High)

Red (White balance)

Press ▼ to lighten the red tone and ▲ to deepen it.

Green (White balance)

Press ▼ to lighten the green tone and ▲ to deepen it.

Blue (White balance)

Press ▼ to lighten the blue tone and ▲ to deepen it.

Sharpness

Press ▼ to decrease the sharpness of the image and ▲ to increase it.

Color adjust (Computer)

Color adjust	
Image mode	Standard
Contrast	32
Brightness	32
Color temp.	Mid
Red	32
Green	32
Blue	32
Sharpness	8

Color adjust

Color adjust (Video)

- 1 Press MENU button on the remote control or top control to display screen menu. Press ▲▼ button to select "Color adjust", then press the OK button.
- 2 Press▲▼ button to select the item you want to set, press the OK button.
- 3 Press▲▼ button to adjust the data.

Contrast

Press ▼ to decrease the contrast and ▲ to increase it.

Brightness

Press ▼ to decrease the brightness and ▲ to increase it.

Color

Press ▼ to decrease the chroma and ▲ to increase it.

Tint

Press ▲▼ to select the appropriate tone for the image.

Red (White balance)

Press ▼ to lighten the red tone and ▲ to deepen it.

Green (White balance)

Press ▼ to lighten the green tone and ▲ to deepen it.

Blue (White balance)

Press ▼ to lighten the blue tone and ▲ to deepen it.

Sharpness

Press ▼ to decrease the sharpness of an image and ▲ to increase it.

Color adjust (Video,S-video, Component)

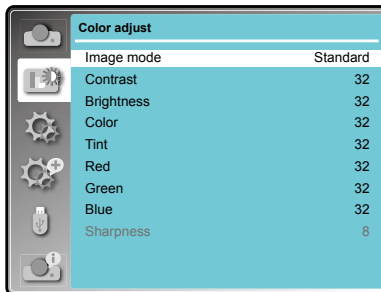

Color adjust	
Image mode	Standard
Contrast	32
Brightness	32
Color	32
Tint	32
Red	32
Green	32
Blue	32
Sharpness	8

√ Note:

- While the input signal as "Video", "Tint" and "Sharpness" adjustment is in grey as disable.

Setting

The projector has "Setting" menu that allows you to set the other various functions described as follows.

- 1 Press MENU button on the remote control or top control to display screen menu. Press ▲▼ button to select "Setting", then press the OK button.
- 2 Press ▲▼ button to select the item you want to set, press the OK button.
- 3 Press ▲▼ button to adjust the item, then press the OK button.

Setting menu

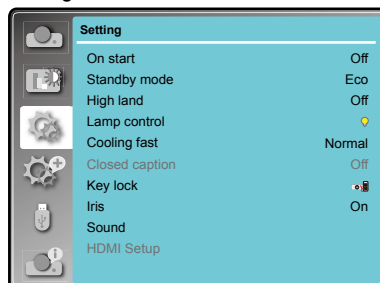

On start

Enable the projector to be turned on automatically just by connecting the AC power cord to an outlet when this function is set to On.

On

Start the projection immediately, enter countdown display.

Off

Start up in the standby mode.

On start

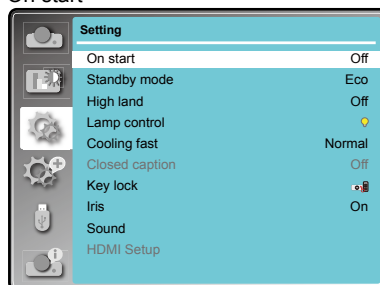

Standby mode

This function is available when operating the projector via network.

Press ▲▼ button to select the item below:

ECO. –

Choose "Eco" to save power consumption

Normal–

Choose "Normal" to return to normal standby

Network–

Choose "Network" as network standby mode

Standby mode

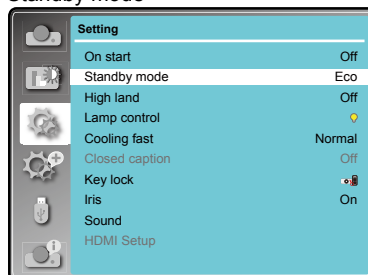

	LAN	RS232C	Keypad	Remote Controller
ECO	X	Δ	Δ	Δ
Normal	√	√	Δ	Δ
Network	*X	Δ	Δ	Δ

x: No Control Δ: Power On command Only √: All commands are active

*x: Power On command is active with "Wake On LAN" software.

- The "Wake On LAN" software and its manual can be downloaded from EIKI global website <https://global.eiki.com/>
File Name : Software_WakeOnLAN

Setting

High land

Enable to control the fan through the Setting menu.

You can select the running speed of the fan according to the altitude of the location where the projector is installed.

Off

Normal speed. Set it so if the projector is operated at a lower altitude.

On

Faster than Off. Set it so if the projector is operated at a higher altitude as fans will produce weaker effects.

✓*Note:*

Please set High land "On" when operating the projector higher than 1400 meters.

High land

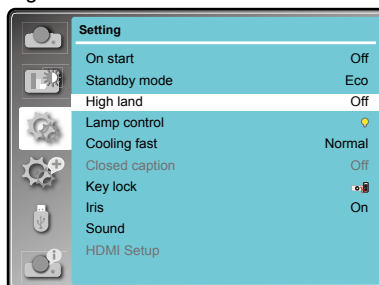

Lamp control

Change the brightness of the screen.

💡 Normal Normal brightness.

💡 Eco Lower brightness, reducing power consumption and extending the lamp life.

Lamp control

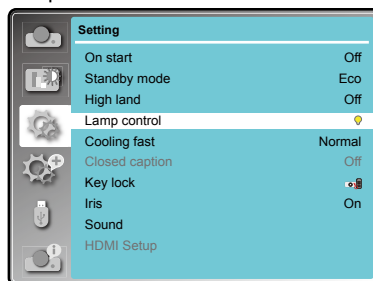

Cooling fast

This function provides the following options in the cooling fans' operation after turning off the projector.

Normal (90 sec)

Normal cooling speed.

60 sec

Faster and louder than Normal, cooling time is shorter.

0 sec

Enable you directly unplug the AC power cord after turning off the projector, no need waiting for cooling.

Cooling fast

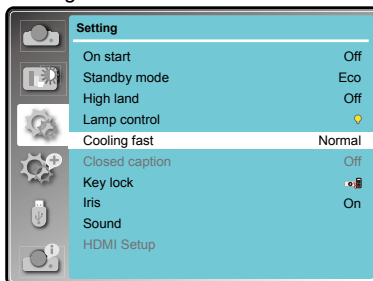

✓*Note:*

When it is set to "0 sec", you cannot restart the projector immediately after the power-off. The lamp remains high temperature and needs to be cooled, so it takes longer time than usual for the lamp to light up again.

Setting

Closed Caption

Allows the subtitle to be displayed for the audio contents or other information. If the input source contains closed caption, you can enable this function and change the channel. Press ▲▼ to select Off, CC1, CC2, CC3 or CC4.

✓ *Note:*

- The icon of Closed Caption is displayed in grey when it is disable.
- Closed caption is disable when screen menu or Timer displayed on screen.

Closed Caption

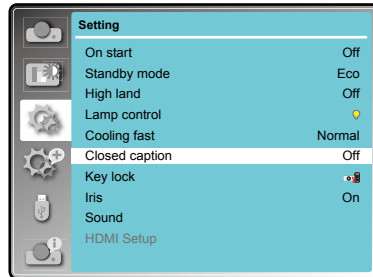

Key lock

This function allows you to use the Key lock to set the security for the projector operation. Select "Key lock" and press the OK button, then press ▲▼ button to select the item you want.

 Off Unlock.

Projector

Lock the operation of the top control. To unlock, use the remote control.

Remote Control

Lock the operation of the remote control. To unlock, use the top control.

Key lock

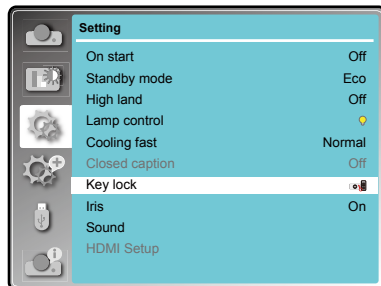

If the top control accidentally becomes locked and you do not have the remote control nearby or there is something wrong with your remote control, contact the dealer where you purchased the projector or the service center.

Setting

Iris

This function is used to increase the contrast of the image.

On Enable Iris function, increase the contrast of the image.

Off Disable Iris function.

Iris

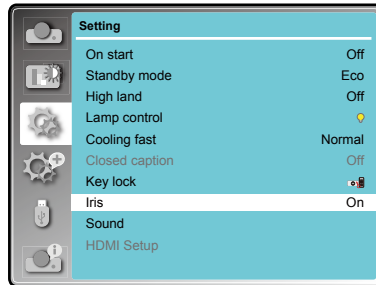

Sound

This item is used to adjust the volume.

Sound

Press ▲ button to increase the volume, press ▼ button to decrease the volume. (0~25)

Mute

Press ▲▼ button to switch mute function. (On/Off)

Sound

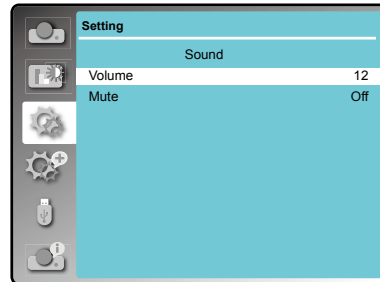

Setting

HDMI setup

When the external equipment is connected to "HDMI" terminal, if the image is not projected properly, please switch the settings of "Image" or "Sound" in "HDMI setup" menu.

- 1 Press the MENU button to display the screen menu. Press ▲▼ button to select the "Setting" menu icon. Press the OK to enter the submenu entry.
- 2 Press ▲▼ button to select "HDMI setup" and then press the OK button.
- 3 Press ▲▼ button to select "Image" or "Sound" to adjust.
- 4 Press ▲▼ button to switch the item.

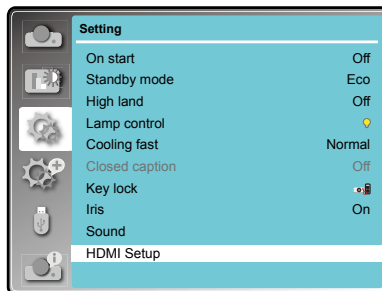

Image

- 64-940 Select when the HDMI terminal of an external device (such as a blu-ray player) is connected to the "HDMI" terminal.
- 0-1023 Select when the output of an external device (such as a computer) is connected to the "HDMI" terminal via a conversion cable or similar cable. Select also when the HDMI terminal output of a computer or other device is connected to the "HDMI" terminal.

✓ Note:

The optimal setting varies depending on the output setting of the connected external device. Refer to the operation instruction of the external device regarding the output of the external device.

Sound

- HDMI Select when the HDMI cable is connected, the image and audio are transmitted, and you do not need to connect the audio signal separately.
- VGA ... Select when the terminal output of an external device (such as a computer) is connected to the "HDMI" terminal via a conversion cable or similar cable. The sound will not be transmitted, the audio signal is input to "AUDIO IN" terminal.

HDMI EQ setup

Adjust the HDMI input signal level depending on the devices connected to the HDMI port. Select EQ setup from 1/2/3/4.

Expand

The projector has Expand menu that allows you to set the other various expand functions described as follows.

- 1 Press MENU button on the remote control to display screen menu. Press ▲▼ button to select "Expand", then press the OK button.
- 2 Press ▲▼ button to select the item you want to set, press the OK button.
- 3 Press ▲▼ button to adjust the item, then press the OK button.

Language

This projector provides multi-language screen menu.

You can press▲▼ button to select the language you want.

26 languages: English, German, French, Italian, Spanish, Polish, Swedish, Dutch, Portuguese, Japanese, Simplified Chinese, Traditional Chinese, Korean, Russian, Arabic, Turkey, Finland, Norway, Denmark, Indonesia, Hungary, Czech Republic, Kazakhstan, Vietnamese, Thai, Farsi.

Auto setup

Press AUTO button on the remote control to execute "Auto PC adj." and "Auto keystone" functions.

Input search

Allows you to automatically detect input signals when the signal is available. Press ▲▼ button to select an option below:

- On Enabled. This function is used to detect input signals automatically.
Off Disabled.

Auto PC adj.

- On Press the AUTO button on the remote control or top control to enable Auto PC adj. function automatically.
Off Cancel Auto PC adj. function.

Auto keystone

- Auto When detecting the projector is tilted, correct the vertical keystone in real time.
Manual When pressing AUTO button on the remote control or top control, correct a vertical keystone.
Off Disabled.

Expand menu



Auto setup

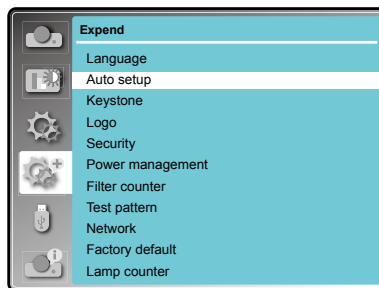

✓ Note:

- "Input search", "Auto PC Adj." and "Auto Keystone" cannot be set to "Off" at the same time. At least one of them is set to "On".
- Sometimes the auto keystone maybe correct image imperfectly, manual keystone is required.
- The Auto keystone function cannot work when "Display" → "Project way" is set to "Ceiling/Front" or "Ceiling/Rear".

Expand

Keystone

This function is used to store or reset the keystone correction when the AC power cord is unplugged.

- 1 Press MENU button on the remote control to display screen menu. Press ▲▼ button to select "Expand", then press the OK button.
- 2 Press ▲▼ button to select "Keystone", press the OK button.
- 3 Press ▲▼ button to select the item you want to set, press the OK button.

Keystone menu

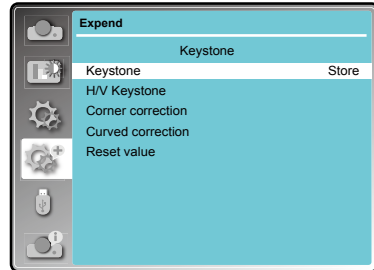

Keystone

Sets whether or not to keep the keystone correction after turn off the projector or plug out the power cord.

Store The keystone correction will be kept when plug out the power cord or turn off the projector.

Reset When "Standby mode" is set to "Eco", plug out the power cord or turn off the projector, the keystone correction will be canceled. When "Standby mode" is set to "Normal", plug out the power cord, the keystone correction will be canceled; turn off the projector, the keystone correction will be kept.

H/V Keystone

Adjust when the horizontal or vertical trapezoid of the projected image is distorted.

Reduce the upper width with ▲ button.

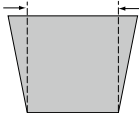

Reduce the lower width with ▼ button.

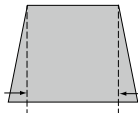

Reduce the left width with ◀ button.

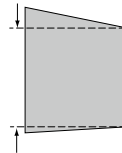

Reduce the right width with ▶ button.

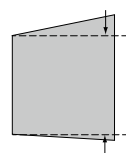

Corner correction

Adjust when the four corners of the projected image are distorted.

Press ▲▼◀▶ to adjust the item.

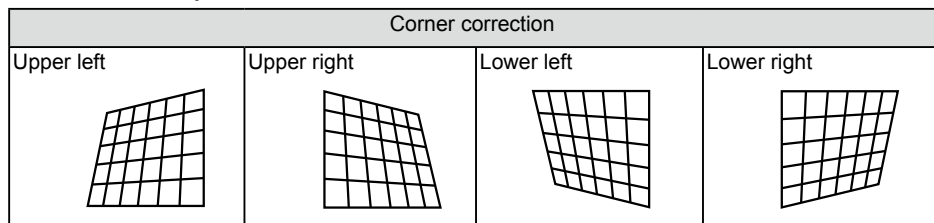

✓ Note:



- The white arrows indicate that there is no correction.
- A red arrow indicates the direction of correction.
- An arrow disappears at the maximum correction.

Expand

Curved correction (Not available for WUXGA model)

Adjust when the linearity is not uniform or the vertical and horizontal lines are distorted.

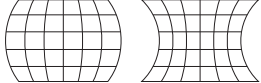
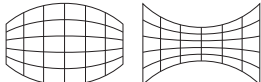
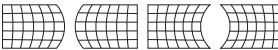
Press ▲ ▼ ◀ ▶ to adjust the item.

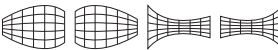
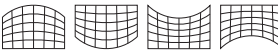
Items	Operation	Adjustment
Curved correction - X/Y Gain	Press the ◀ & ▶ button	Adjust the right & left of the width 
	Press the ▲ & ▼ button	Adjust the top & bottom of the width 
Curved correction - X Offset	Press the ◀ / ▶ button	Adjust the left / right of the distortion 
	Press the ▲ / ▼ button	Adjust the top / bottom of the distortion 
Curved Correction - Y Offset	Press the ◀ / ▶ button	Adjust the left / right of the distortion 
	Press the ▲ / ▼ button	Adjust the top / bottom of the distortion 

✓ Note:

- Either "H/V Keystone", "Corner correction" or "Curved correction" setting value is valid. When the "H/V Keystone", "Corner correction" or "Curved correction" adjustment is finished, the adjusted value will be reset when you adjust the other one.
- The "Curved Correction X Offset" and the "Curved Correction Y Offset" can not be adjusted independently. After adjusting the "Curved Correction X/Y Gain" at the beginning, please adjust the "Curved Correction X Offset" and "Curved Correction Y Offset".
- Press the KEYSTONE button on the remote control when the keystone screen is displaying (it includes: H/V Keystone, Corner correction, Curved correction and Reset value), press ▲ ▼ button switch to the other adjustment screen.
- Correcting up to $\pm 30^\circ$ for the tilt in the vertical direction and $\pm 15^\circ$ for the tilt in the horizontal direction are available for adjustments with "Keystone". However, the image quality will degrade and it will get harder to focus with more correction. Install the projector so that the correction will be as small as possible.
- Screen size will also change when "H/V Keystone" is used to perform various adjustments.
- Aspect ratio of the image size may shift depending on the correction.

Reset value

Return the corrected values to the factory default values.

Press ▲ ▼ to select "Reset value", then press the OK button, the state of the keystone correction is released.

Expand

Logo

This function allows you to customize the screen logo with Logo select, Capture, Logo PIN code lock and Logo PIN code change functions.

Logo Select

This function decides on the starting-up display from following options.

Default Show the factory-set logo.

User.....Show the image captured by user.

Off Show the countdown display only.

*"User" is not available for EK-120U

Capture

You can capture a projected image as start logo .

Select "Capture" and press the OK button on remote control or control panel.

Confirmation dialog box appears, select "Yes" to start capturing.

*"Capture" is not available for EK-120U

Logo

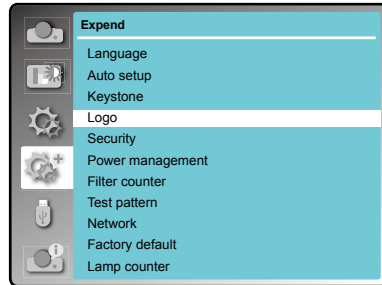

Logo PIN code Lock

This function prevents an unauthorized person from changing the screen logo.

OffThe screen logo can be changed freely from the Logo menu.

OnThe screen logo cannot be changed without a Logo PIN code.

If you want to change the Logo PIN code lock setting, press the OK button and the Logo PIN code dialog box appears. Enter a Logo PIN code by following the steps below.

*Default PIN code is "111"

Press OK button to enter the PIN code. Press ◀▶ button to select a number, and then press the OK button to enter this number, the cursor automatically move to next box. If you fixed an incorrect number, press MENU button to reset it again.

Repeat this step to complete entering a three-digit number.

After entering the three-digit number, the cursor automatically move to "Set", and press the OK button, then you can start to operate the projector.

If you entered an incorrect PIN code, the number (***) turn red, it will be reset automatically within one second. Enter the correct PIN code all over again.

Logo PIN code change

You can change the Logo PIN code (three number). Press the OK button to select Logo PIN code change. Logo Pin code dialog box appears, press ◀▶ button to enter the correct PIN code. The New Logo PIN code input dialog box appears. Set a new Logo PIN code, confirmation box appears, select Yes to set the new Logo Pin code.

Be sure to note the new Logo PIN code and keep it on hand. If you lost the number, you could no longer change the Logo PIN code setting.

CAUTION:

WHEN YOU HAVE CHANGED THE LOGO PIN CODE, WRITE DOWN THE NEW PIN CODE IN COLUMN OF THE LOGO PIN CODE NO. MEMO ON PAGE 81, AND KEEP IT SECURELY. SHOULD THE LOGO PIN CODE BE LOST OR FORGOTTEN, THE LOGO PIN CODE SETTING CAN NO LONGER BE CHANGED.

Expand

Security

This function allows you to use the PIN code lock and PIN code change functions to set the security for the projector operation.

PIN code lock

This function prevents the projector from being operated by unauthorized persons and provides the following setting options for security.

Off Unlocked.

On Enter the PIN code every time turning on the projector. If you want to change PIN code lock setting or PIN code, you must enter the PIN code. The default PIN code is "111".

If you want to change the PIN code lock setting, press the OK button, then PIN code dialog box appears.

Press ◀▶ button to select a number, and then press the OK button to enter this number, the cursor automatically move to next box. If you fixed an incorrect number, press MENU button to reset it again.

Repeat this step to complete entering a three-digit number.

After entering the three-digit number, the cursor automatically move to "Set", and press the OK button, then you can change the PIN code lock setting.

If you entered an incorrect PIN code, the number (***) turn red, it will be reset automatically within one second. Enter the correct PIN code all over again.

PIN code change

The PIN code can be changed to three-digit number. Press ▲▼ button to select PIN code change. Pin code dialog box appears, Press ◀▶ button to enter the correct code. The New PIN code input dialog box appears. Set a new PIN code.

Security

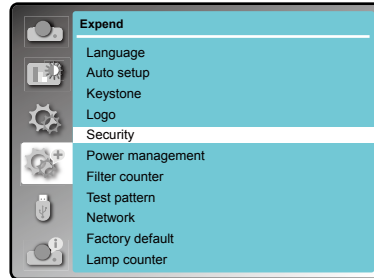

✓ Note:

- Keysotne-Curved correction and Logo - Capture and User function does not support EK-120U.

CAUTION:

WHEN YOU HAVE CHANGED THE LOGO PIN CODE, WRITE DOWN THE NEW PIN CODE IN COLUMN OF THE LOGO PIN CODE NO. MEMO ON PAGE 81, AND KEEP IT SECURELY. SHOULD THE LOGO PIN CODE BE LOST OR FORGOTTEN, THE LOGO PIN CODE SETTING CAN NO LONGER BE CHANGED.

Expand

Power management

For reducing power consumption as well as maintaining the lamp life, the Power management function turns off the projection lamp when the projector is not operated for a certain period. Select one of the following options:

Ready

When the lamp has been fully cooled down, the POWER indicator changes to green blinking. In this condition, the projection lamp will be turned on if the input signal is reconnected or any button on the remote control or top control is pressed.

Power off

When the lamp has been fully cooled down, the power will be turned off.

Off

Power management function is off.

Timer

If the input signal is interrupted and no button is pressed for more than 30 seconds, the timer display with No signal appears. It starts the countdown until the lamp is turned off. Press ▲▼ button to set the Timer(1~30min.)

Ready countdown

Set the time that ready status transfers to standby status automatically.(0-30min. 0 Min: not transfer automatically)

In ready status, press POWER button to switch to standby status, and press any other button to turn on the projector.

Power management

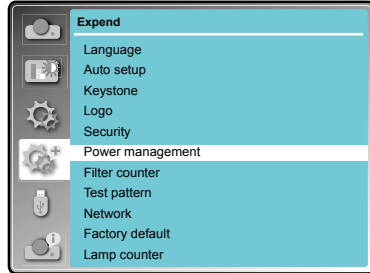

Time left before Lamp is off.

✓ Note:

*Factory default: "Timer: 5 min",
"Ready countdown: 5 min".*

Filter counter

This function is used to set a frequency for filter cleaning.

When the projector reached a specified time between cleanings, a Filter warning icon appears on the screen, notifying the cleaning is necessary. After cleaning the filter, be sure to select RESET and set the timer. The Filter warning icon will not turn off until the filter counter is reset.

Filter counter

Display the using time of the filter.

Timer

Set the time to display the warning icon.
Select Timer from OFF/100/200/300.

Filter counter reset

Reset the filter counter.(See page 65)

Filter counter

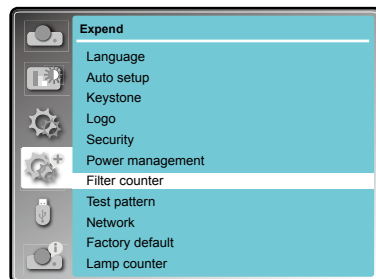

Expand

Filter check

Check the temperature inside the projector and make reactions.

On: enable the filter check function

*when the projector checked any filter issue the warning message would pop-up automatically

Off: disable the filter check function

✓ *Note:*

- When the lamp counter is less than 50 hours, and the projector has checked filter warning condition, there won't pop-up the warning message but the filter check function would change the setting from On to Off automatically.
- The warning message will automatically disappear after 30 seconds, there only the power button is effective during that period.
- The warning message will pop-up again if the projector has checked the filter warning condition.
- The checking term of filter check function is every 10 minutes after power on the projector. And the projector would stop to check the filter condition after the 3rd term (30 minutes).

Test Pattern

This function is used to set the internal test signal: Gray scale 1, Gray scale 2, Gray scale 3, Gray scale 4, Color bar, Red, Green, Blue, Cross hatch, White, Black and Raster gray.

When you get into the Test Pattern mode, press MENU to get back the selection page of Test Pattern.

Test Pattern

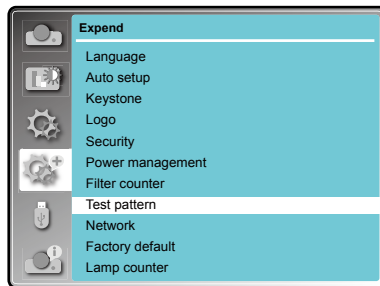

Network

Function : PC controls projector via LAN.

Preparation:

1. Equipments: PC, projector, cables
2. Connection procedures:

Connect the projector to routers or switches of the LAN by direct or cross cable. If it fails to connect PC and projector by parallel cable, please switch to cross cable as suggested.

3. After the computer is booted and the projector is plugged in, indicator lights of LAN interface on will flash continuously.

Operation procedures:

- 1 Turn on the projector.
- 2 Obtain network address. DHCP set is displayed as On and obtain network address automatically. (If familiar with network, you can set DHCP as Off and obtain network address manually.)
- 3 Enter network settings menu.

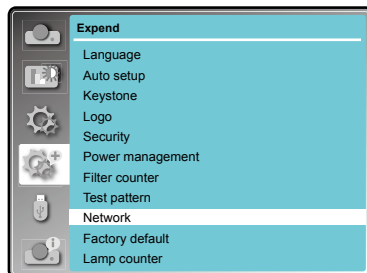

Expand

- (1) Press MENU button on the remote control to display screen menu. Press ▲▼ button to select Expand, then press the OK button.
- (2) Press ▲▼ button to select Network, and then press the OK button to enter the network menu.

MAC address ... Displays the MAC address of wired network of this projector.

IP addressDisplays the IP address of wired network of this projector.

- (3) When DHCP is set On, IP address, Subnet, Gateway and DNS will be obtained automatically, press the OK at "Set" to confirm the parameters.

When DHCP is set Off, press the OK button to enter IP address, then press ▼ button to enter Subnet, Gateway and DNS respectively, press the OK at "Set" to confirm the parameters.

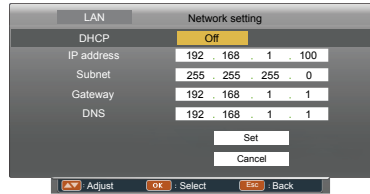
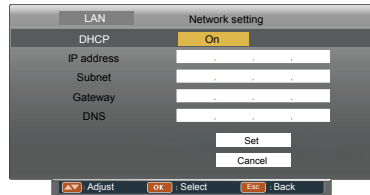

✓ Note:

See page 53 for usage of Network.

Factory default

This function returns all setting values except for the User logo, PIN code lock, Logo PIN code lock, Lamp counter and Filter counter to the factory default settings.

Lamp Counter Reset

This function resets the counter of Lamp usage hours. Please be sure to reset the lamp counter after replacing the lamp. WARNING indicator turns Off and the lamp replacement icon disappears after reset the lamp counter.

Press < MENU > button on the remote controller or on the top control panel to display the OSD menu. Press ▲▼ button to select the Expand menu, then press <OK> or ► button.

- 1) Press ▲▼ button to select [Lamp counter] menu.
- 2) Press <OK > button.
- 3) Press ▲▼ button to select [Lamp counter reset], then press <OK> button.
- 4) " Lamp replacement counter reset ? " conformation box appear.
- 5) Select "Yes" and Press <OK> button.

Lamp counter

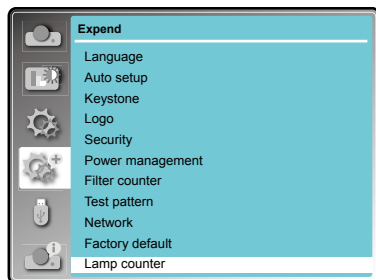

Memory viewer

The Memory Viewer function makes it possible to project the pictures which are stored in the USB memory when the USB memory is inserted into the projector

- 1 Press INPUT button on the remote control to select MEMORY VIEWER from the Input menu.
- 2 Press MENU button on the remote control to display screen menu. Press ▲▼ button to select "Memory Viewer", then press the OK button.
- 3 Press ▲▼ button to select the item you want to set, press the OK button.
- 4 Press ▲▼ button to adjust the item, then press the OK button.

Set Slide

Start the slide show.

Slide transition effect

Set the slide transition effect when the slide show image is switching.

Slide down ... Switch the image from the top to the bottom.

Slide right Switch the image from the left to the right.

Sort Order

Set the sort order of the slide show.

Extend Order Sort files or folders in extended order.

Size Order Sort files or folders in amount of data order.

Time Order Sort files or folders in stored time order.

Name Order Sort files or folders in name order.

Rotate

Set the rotate direction of image.

No Rotate Rotate is disabled.

270 Degrees Rotate 270 degrees in anti-clockwise direction.

180 Degrees Rotate 180 degrees.

90 Degrees Rotate 90 degrees in anti-clockwise direction.

Best Fit

Set the image whether or not to fit with the projected screen.

On Display the image to fit with the aspect of the projected screen.

Off Display in the normal pixels of the image.

Memory Viewer menu

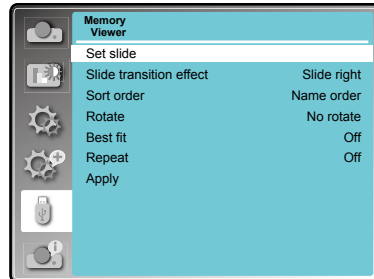

✓ Note:

- The "Memory Viewer" menu is available when the input source choose "Memory Viewer".
- The menu except for "Set Slide" which setting have been changed is not yet effective before the "Apply" is not executed.
- See page 61 for Memory viewer function.

Repeat

Set whether or not to play the slide show repeatedly.

On Repeat broadcast the first file after the last file is broadcasted.

Off Return to the thumbnail display after the last file is broadcasted.

Apply

Execute the setting in slide show.

Press ▲▼ to select "Apply", then press the OK button, the setting of the items except for "Set Slide" will be effective.

Information

The information menu is used to detect signal of projected image and running state.

Menu operation

Press MENU button on the remote control or top control to display the screen menu. Press ▲▼ to select Info., the information menu will appear as the right picture.

The information below will display in information menu.

Input

The selected input source is displayed.

H-sync freq .

The horizontal frequency of the input signal is displayed in KHz or - - - -KHz when no signal is detected.

V-sync freq .

The vertical frequency of the input signal is displayed in Hz or - - - - Hz when no signal is detected.

Lamp status

The setting status of "Lamp control" is displayed.

Lamp counter

The usage time of the lamp is displayed.

Power management

The setting status of "Power management" is displayed.

Image mode

The setting status of "Image mode" is displayed.

info. menu

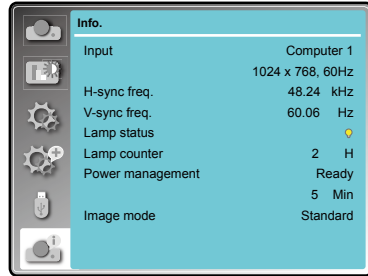

Network Control Instructions

LAN control

Function : PC controls projector via LAN.

Preparation:

1. Equipments: PC, projector, cables
2. Connection procedures:

Connect the projector to routers or switches of the LAN by direct or cross cable. If it fails to connect PC and projector by parallel cable, please switch to cross cable as suggested.

3. After the computer is booted and the projector is plugged in, indicator lights of LAN interface and computer interface will flash continuously.

Operation procedures:

- 1 Turn on the projector.
- 2 Obtain network address. DHCP set is displayed as on and obtain network address automatically. If familiar with network, you can set DHCP as close and obtain network address manually.

- 3 Enter network settings menu.

(1) Press MENU button on top control or remote control to display screen menu. Press ▲▼ button to select "Expand" icon, then press the OK button.

(2) Press ▲▼ button to select "Network" setting and press the OK button enter the network setting.

(3) Press ▲▼ button to set DHCP as on.

(4) Press ▲▼ button to "Set" and press the OK button."Please wait..." appears.

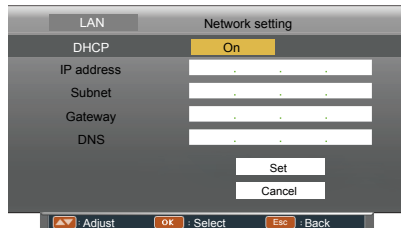
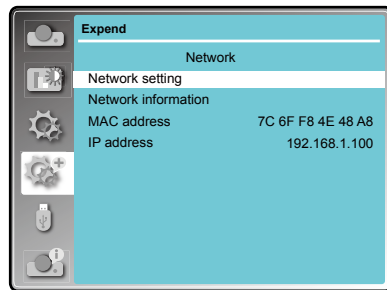

Network Control Instructions

4. Activate the Web browser in the personal computer.
5. Enter the IP address set by the projector into the URL input field of the Web browser.
6. Select "Login" to login the Network Display System page. (Both the initial name and passwords are "admin".)



✓ **Note:**

- You can click the upper right corner of the web browser screen to select the display language.
- Do not perform setting or control simultaneously by starting up multiple web browsers. Do not set or control the projector from multiple computers.
- Change the password first. (8 half-width characters). (page 55)
- If the screen for the web control is not displayed, consult your network administrator.

7. Items in Network Display System page including: "System Status", "General Setup", "Picture Setup", "Image Setup" and "Network Setup".

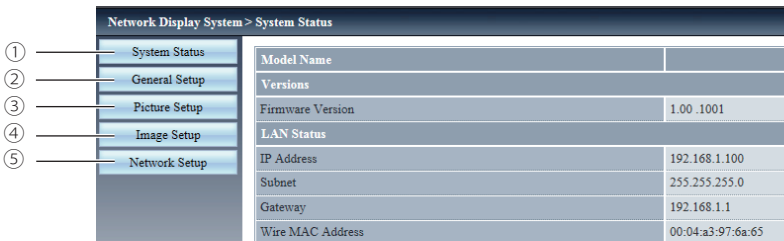

- ① **System Status**
The "System Status" page is displayed by clicking this item.
- ② **General Setup**
The "General Setup" page is displayed by clicking this item.
- ③ **Picture Setup**
The "Picture Setup" page is displayed by clicking this item.
- ④ **Image Setup**
The "Image Setup" page is displayed by clicking this item.
- ⑤ **Network Setup**
The "Network Setup" page is displayed by clicking this item.

Network Control Instructions

"System Status" page

Display the status of the projector for the following items.

Network Display System > System Status	
System Status	Model Name
General Setup	Versions
Picture Setup	Firmware Version 1.00.1001
Image Setup	LAN Status
Network Setup	IP Address 192.168.1.100
	Subnet 255.255.255.0
	Gateway 192.168.1.1
	Wire MAC Address 00:04:a3:97:6a:65

- ① Model Name
Displays the model No. of the projector.
- ② Versions
Displays the version of the firmware of the projector.
- ③ LAN Status
Displays the connection status of the LAN.

"General Setup" page

Change Password for Webpage is displayed.

Network Display System > General Setup	
System Status	Change Password for Webpage
General Setup	Enter Old password
Picture Setup	Enter New password
Image Setup	Confirm New password
Network Setup	Apply
	Power & Source
	Power <input type="radio"/> On <input type="radio"/> Off
	Source Select Computer 1

- ① Enter Old password
Enters the configured password.
- ② Enter New password
Enters the new password.
- ③ Confirm New password
Enters the wanted new password again for confirmation.
- ④ Apply
Updates the settings.
- ⑤ Power
Switches on/off the power of the projector.
- ⑥ Source Select
Switches the input source of the projector.

Network Control Instructions

"Picture Setup" page

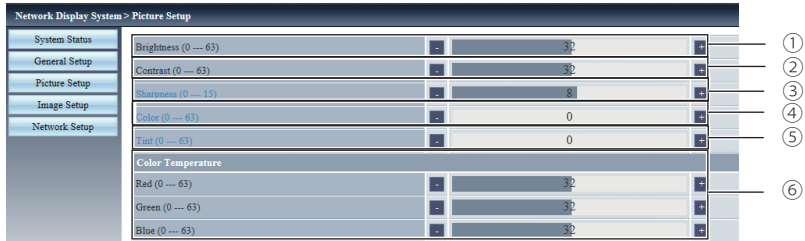

- ① Brightness
Adjusts the brightness of the projected image.
- ② Contrast
Adjusts the contrast of the projected image.
- ③ Sharpness
Adjusts the sharpness of the projected image.
- ④ Color
Adjusts the color saturation of the projected image.
- ⑤ Tint
Adjusts the skin tone of the projected image.
- ⑥ Color Temperature
Adjusts the color temperature of the projected image.

Network Control Instructions

"Image Setup" page

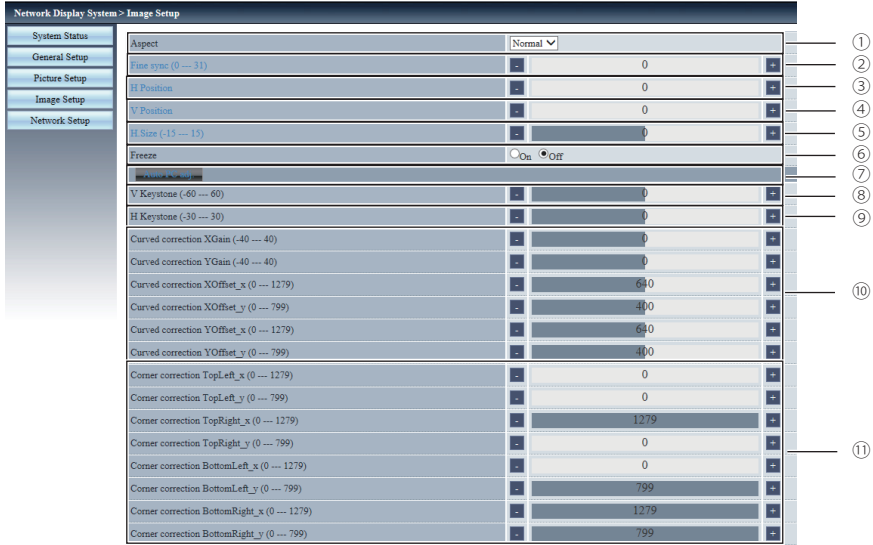

- | | |
|--|---|
| <p>① Aspect
Switches the aspect of the projected image.</p> <p>② Fine sync
Adjusts the fine sync of the projected image.</p> <p>③ H Position
Adjusts the horizontal position of the projected image.</p> <p>④ V Position
Adjusts the vertical position of the projected image.</p> <p>⑤ H.Size
Adjusts the total number of dots of the projected.</p> <p>⑥ Freeze
Switches the freeze function between on and off.</p> | <p>⑦ Auto PC adj.
Executes the Auto PC adj. function.</p> <p>⑧ V Keystone
Corrects the keystone in vertical direction.</p> <p>⑨ H Keystone
Corrects the keystone in horizontal direction.</p> <p>⑩ Curved Correction
Corrects the pincushion or barrel of the projected image.</p> <p>⑪ Corner correction
Corrects the four corners of the projected image.</p> |
|--|---|

Network Control Instructions

"Network Setup" page

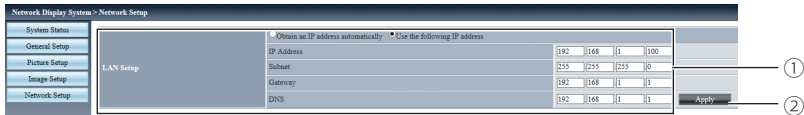

① LAN Setup

Select [Obtain an IP address automatically] if you want to enable the DHCP client.

IP Address

Enter the IP address when not using a DHCP server.

Subnet

Enter the subnet mask when not using a DHCP server.

Gateway

Enter the default gateway address when not using a DHCP server.

DNS

Enter the DNS server when not using a DHCP server.

② Apply

Updates the settings.

8. PwPresenter software: when "Network" is selected in Source Select, you can project the current computer images via network.

Input the IP address of the projector in webpage to enter the Network Display System, click "Download" to download the pwPresenter software according to your operation system.

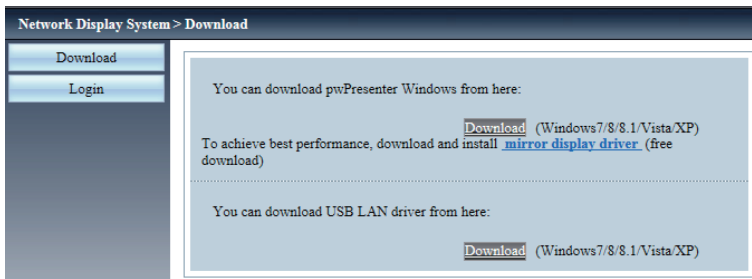

9. Click  icon to access the pwPresenter software.

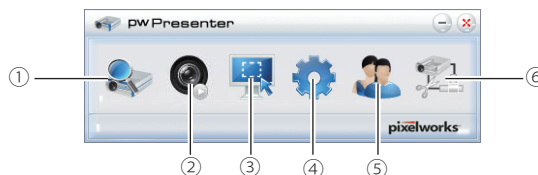

Network Control Instructions

① Search for projector display

Click to enter Search, select the projector and connect it. Please setting the same IP address of the projector in pwPresenter software, (such as: 192.168.1.100). Both the initial name and passwords are "admin".

✓ **Note:**

- Before use pwPresenter software to search, you need change Source Select to "Network".

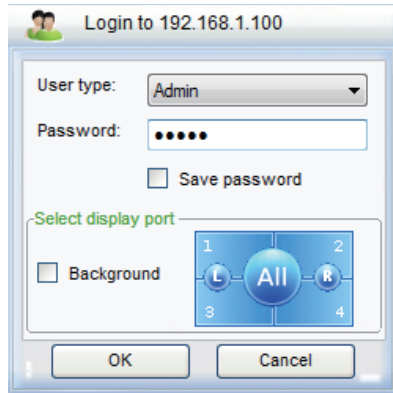
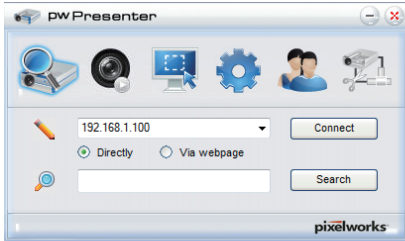

② Play/Pause

Play or pause the selected image.

③ Choose capture mode

Choose a capture mode from "FullScreen", "FixedSize" or "Alterable."

④ Parameters Setting

Basic Setting: setting language, region of capture image etc.,

Advanced Setting: setting image quality, network port etc.,

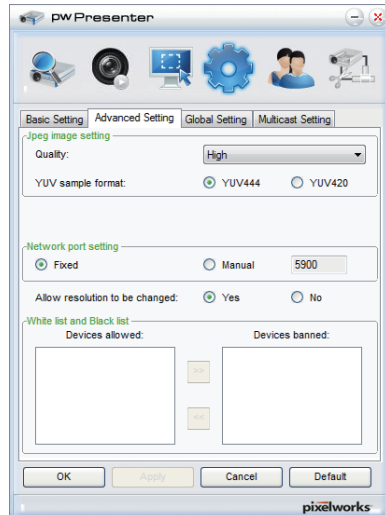
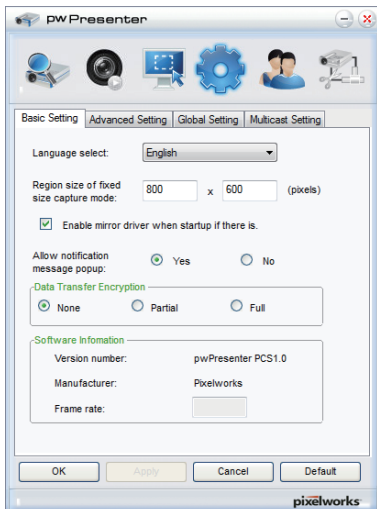

Network Control Instructions

Global Setting: setting remote control, capture by audio or screen etc.

⑤ Network Display Management
Setting device and password management.

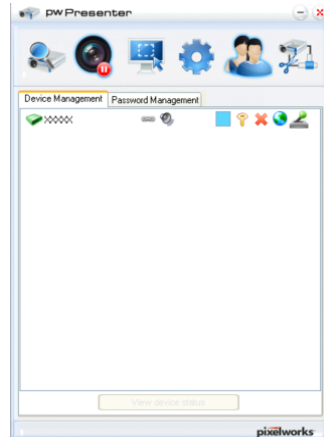
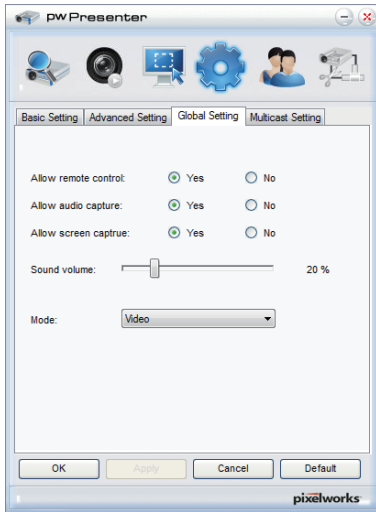

Multicast Setting: setting Sound volume, Bandwidth and Capture rate etc.

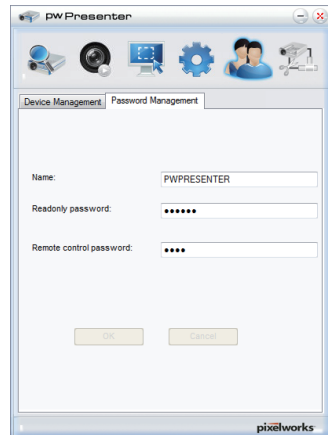
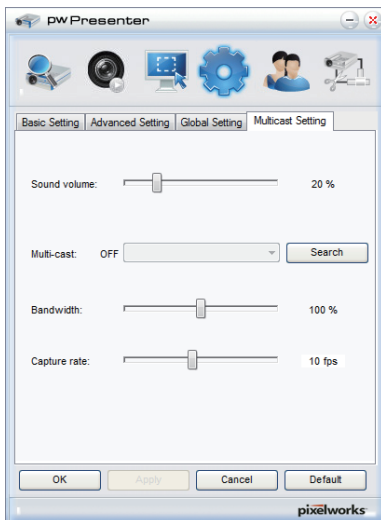

⑥ Disconnect the projector.

Using useful functions

Memory Viewer function

The Memory Viewer function is used to project the pictures which are stored in the USB memory when the USB memory is inserted into USB A(VIEWER) terminal of the projector.

Memory Viewer function supports the following image files.

	Extension name	Format	Description
Picture	jpg/jpeg	Baseline encoder 24 bit	Max. resolution : 10000 x 10000
		Progressive RGB 24 bit	Max. resolution : Panel Resolution
	bmp	1, 4, 8 bit Palette-based RGB 24, 32 bit	Max. resolution : 1280 x 800
	png	24, 48 bit True color	24 bit color palette space Max. resolution : 1024 x 768
	gif	1, 4, 8 bit Palette-based	Max. resolution : 800 x 600
	tiff	—	Max. resolution : 800 x 600

Display the Memory Viewer screen

1. Press the INPUT button on the remote controller or the top control panel to select the input source as Memory Viewer from the pop-up menu.
2. Insert the USB memory into the USB-A terminal of the projector directly, the standby screen as Please Press "OK" appears when the USB memory icon is displayed on the screen.
3. Press the OK button on the remote controller, the root directory of the USB memory will appear in thumbnail on the screen.

Play the pictures

It will display a picture when play the picture manually every time.

1. Press ▲▼◀▶ to select a file.
2. Press the OK button, the picture will display on the full screen.
3. Press ▶ to switch to the next picture, press ◀ to return to the previous picture.
4. Press the OK button on the remote control.

Executing the slide

All pictures in the same folder will play automatically when "Slide Transition Effect" of "Memory Viewer" menu are set to the special setting.

1. Press ▲▼◀▶ to select a file.
2. Press the "MENU" button to select the "Memory Viewer" → "Set Slide".
3. Press the OK button.
 - The picture will display on the full screen.
 - Press the OK button to return to the thumbnail screen.

Termination of the Memory Viewer

1. Press ▲▼◀▶ to the thumbnail  which is displayed on the upper left corner.
2. Press the OK button on the remote controller to return to the standby screen.
3. Remove the USB memory directly.

Using useful functions



Note:

- When insert a USB memory, please ensure the right direction to avoid the damage of the port.
- Please following the instruction while inserting or removing the USB memory:
 - a. The indicator beside the USB-A port is flashing while reading the data from USB memory. Do not remove the USB memory when the indicator is flashing.
 - b. The indicator beside the USB-A port will not turn on when there is problem to read the data from the USB memory device. Please exit the memory viewer function and turn off the projector, then remove the USB memory device.
 - c. Do not insert and remove USB memory frequently. Remove the USB memory device at least 5 seconds after the installation.

Precautions on processing and storage of USB memory device

- Please do not place the USB memory or the lid on where the children can reach. Swallow USB memory or the lid may cause choking.
- If smoke or produce abnormal smell, close the external device and contact the dealer.
- Do not let the water, chemicals or oil into the USB memory, or it may cause a short circuit or fire.
- Do not put foreign matter or metal items in the USB port. Static electricity may cause data loss or data damage.
- When USB memory is reading, Do not remove USB memory from the projector, otherwise it may result in data loss or corruption of data.
- Please do not put the USB memory in high temperature, damp or dusty place, or next to magnetic materials.

✓ Note:

It allows the insertion or removal of the USB memory when the projector is in any power status.

Using useful functions

USB Display function

The USB Display function is used to project the image from the computer which is connected to USB-B(DISPLAY) terminal of the projector by a USB converting cable.

■ When using Windows

Windows operation environment

OS	Windows Vista 32 bit, Windows 7 32/64 bit, Windows 8 32/64 bit
CPU	Intel Core 2 Duo 2.0 GHz or faster, the compatible processor
Amount of memory	256 MB or more (Recommended : 512 MB or more)
Hard-disk free space	20 MB or more
Display	Resolution 640 x 480 or more, 1 600 x 1 200 or less

- There is no guarantee for all computers that meet the above conditions will operate properly.

Projecting the USB Display

1. Connect the USB-B terminal of the projector to a computer with a USB converting cable.
2. Press the USB DISPLAY button on the remote control or switch the input source to USB Display.
 - Press the INPUT button on the top control and select the input source in the Input menu.
 - The startup screen will be displayed automatically due to the driver which is built-in the projector, and executes the installation according to the instructions of the screen. The displaying of the auto installation screen depends on the setting of computer. At this time, please select "Run autorun.exe". Please double-click "autorun.exe" in the folder of the USB Display when the automatical startup is disabled.
 - The image on the computer screen is projected.
3. Click the driver icon  in the task bar of computer and select one item in Pop-up menu.
 - Pop-up menu is only displayed in English.
 - The item which is displayed in gray is unavailable.

Active audio/ Disable audio	Set whether to output the audio from the computer.
Play video/ Pause video	Switch between play and pause the image.
Start/Stop	Set whether to display the image from the computer.
Exit	Exit USB Display.

✓ Note:

- The driver is not installed in your computer, and it will be removed from the computer when disconnecting the USB cable.
- It will take a while when you want to project the computer screen.
- Connect a USB cable directly to the USB connector of a computer. It will not work when connecting through a USB hub.

Termination of the USB display

When terminate the USB display, remove the USB cable directly. There is no need to follow "Remove hardware safely" when a USB cable is disconnected.

Using useful functions

■ When using Mac OS

Mac OS operating environment

OS	Mac OS X 10.5, 10.6, 10.7
CPU	Power PC G4 1GHz or faster
Amount of memory	512 MB or more
Hard-disk free space	20 MB or more
Display	Resolution 640 x 480 or more, 1 600 x 1 200 or less

- There is no guarantee for all computers that meet the above conditions will operate properly.

Projecting the USB Display

1. Connect the USB-B terminal of the projector to a computer with a USB converting cable.
2. Press the USB DISPLAY button on the remote control or switch the input source to USB Display.
 - Press the INPUT button on the top control and select the input source in the Input menu.
 - The image on the computer screen is projected.
3. Double-click "Monitor.app" in the virtual disk that has been mounted.
4. Right-click the driver icon  in the dock of computer and select one item in Pop-up menu.
 - Pop-up menu is only displayed in English.
 - The item which is displayed in gray is unavailable.

Active audio/ Disable audio	Set whether to output the audio from the computer.
Play video/ Pause video	Switch between playing and pausing the image.
Start/Stop	Set whether to display the image from the computer.
Quit	Terminate the USB Display.

✓ Note:

- It will take a while when you want to project the computer screen.
- Connect a USB cable directly to the USB connector of a computer. It will not work when connecting through a USB hub.

Termination of the USB display

When terminate the USB display, remove the USB cable directly.

Maintenance and cleaning

WARNING indicator

The WARNING indicator shows the state of the function which protects the projector. Check the state of the WARNING and POWER indicator to take proper maintenance.

The projector is shut down and the WARNING indicator is flashing red.

When the temperature inside the projector exceeds the normal temperature, the projector is automatically shut down to protect internal components. The POWER indicator is blinking while the projector is cooling down. When the projector has cooled down enough (to its normal operating temperature), and the POWER indicator stop blinkign, it can be turned on again by pressing the POWER button.

Check the items below:

- Did you provide appropriate space for the projector to be ventilated?
Check the installing condition to see if ventilation slots are not blocked.
- Has the projector been installed near the duct or vent of an airconditioning?
Move the installation of the projector away from the duct or vent.
- Are the air filters clean? Clean the air filters periodically.

The projector is shut down and the POWER indicator lights yellow.

When the projector detects an abnormal condition, it is automatically shut down to protect the internal components and the POWER indicator lights yellow. In this case, unplug the AC power cord and plug it again, and then turn on the projector once again to verify operation. If the projector cannot be turned on and the Power indicator keep lights yellow, unplug the AC power cord and contact the service center for servicing and maintenance.

WARNING indicator

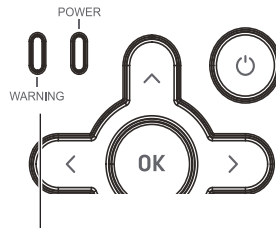

WARNING indicator flashes red.

✓ *Note:*

The Power indicator stop blinking while the temperature inside the projector has cool down to normal.

POWER indicator

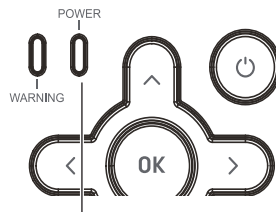

POWER indicator lights yellow.



Caution

Do not leave the projector with the AC power cord connected under an abnormal condition. It may result in fire or electric shock.

Maintenance and cleaning

Cleaning the filter

The air filter prevents dust from accumulating on the surface of the optical elements inside the projector. Should the air filter become clogged with dust particles, it will reduce cooling fans' effectiveness and may result in a buildup of internal heat and adversely affects the life of the projector. If the Filter warning icon appears on the screen, the air filter should be cleaned immediately. Clean the air filter following the steps below.

- 1 Turn off the projector, and unplug the AC power cord from the AC outlet.
- 2 Remove the air filter.
- 3 Gently clean the filter with a brush.
- 4 Reinstall the filter into the projector properly.



Caution

Do not operate the projector with the air filter removed. Dust may accumulate on the optical elements, degrading picture quality. Do not put any small objects into the air intake vents. Otherwise, it may result in malfunction of the projector.

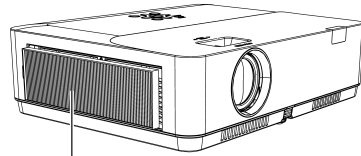

Filter

Recommendation

We recommend avoiding dusty/smoky environments when you operate the projector. Usage in these environments may cause poor image quality.

When you use the projector under dusty or smoky conditions, dust may accumulate on the lens, LCD panels, or optical elements inside the projector. When the symptoms above are noticed, contact your authorized dealer or service station for proper cleaning.

Filter counter reset

Be sure to reset the filter counter after cleaning or replacing the filter.

1. Press Menu on the remote control to display the screen menu. Press ▲▼ to select "Expand", then press the OK button.
2. Press ▲▼ to select "Filter counter", and then press the OK button.
Press ▲▼ to select "Filter counter reset" and press the OK button, "Filter counter Reset?" appears on screen, select "Yes" to continue.
3. When another dialog box pops up, select "Yes" to reset the filter counter.

Order Replacement Filter

Replacement Filter can be ordered through your dealer. When ordering a projection filter, give the following information to the dealer.

Replacement filter Model No.:
63340044

Maintenance and cleaning

Clean the projection lens

Unplug the AC power cord before cleaning.

Gently wipe the projection lens with a cleaning cloth that contains non-abrasive camera lens cleaner, or use a lens cleaning paper or commercially available air blower to clean the lens.

Avoid using an excessive amount of cleaner. Abrasive cleaners, solvents, or other harsh chemicals might scratch the surface of lens.

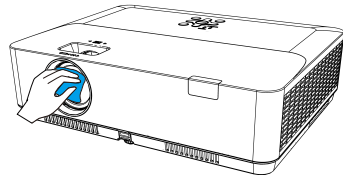

Clean the cabinet

Unplug the AC power cord before cleaning.

Gently wipe the projector surface with a soft dry cleaning cloth. When the cabinet is heavily soiled, use a small amount of mild detergent and finish with a soft dry cleaning cloth. Avoid using an excessive amount of cleaner. Abrasive cleaners, solvents, or other harsh chemicals might scratch the surface of the cabinet.

When the projector is not in use, put the projector in a pouch to protect it from dust and scratches.

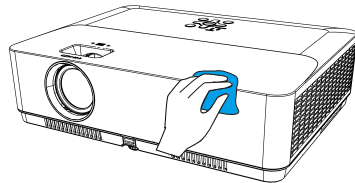

Appendix

Troubleshooting

Before calling your dealer or service center for assistance, check the items below once again.

- Make sure you have properly connected the projector to peripheral equipment.
- Make sure all equipment is connected to the AC outlet and the power is turned on.
- If the projector does not project an image when it is connected to a PC, restart the PC.

Problems	- Solutions
No power	<ul style="list-style-type: none">- Plug the power cord of the projector into the AC power outlet.- Check whether the POWER indicator lights red.- Only when the POWER indicator lights red you can power on the projector again.- Check the WARNING indicator. If it is blinking red, the projector can not be powered on. (Page 64)- Unlock the "Key lock" function. (Page 39)
No initial displaying	<ul style="list-style-type: none">- Make sure that Logo function is not set to "Off". (Page 45)
Initial displaying is inconsistent with factory defaults	<ul style="list-style-type: none">- Make sure that Logo function is not set to "Off" or "User". (Page 45)
Input signals are automatically switched (can't be switched)	<ul style="list-style-type: none">- Properly adjust the Input search function.
Ambiguous images	<ul style="list-style-type: none">- Adjust the focus.- Set a more proper projection distance.- Check whether the lens needs to be cleaned.- When moved from a environment with low temperature to the one with higher temperature, water will be condensed on the lens. If so, you have to wait till the condensed water disappears.
Image turns over leftward/ rightward Image turns over upward/ downward	<ul style="list-style-type: none">- Check the function of "Ceiling/rear". (Page 31)- Check the function of "Ceiling".(Page 31)
Image not bright enough	<ul style="list-style-type: none">- Check whether the contrast or brightness is adjusted correctly. (Page 35-36)- Check whether the Image mode is properly selected. (Page 34)- Check the function of lamp brightness adjusting. (Page 35-36)
No image	<ul style="list-style-type: none">- Check the connection between Computer or video equipment and the projector.- Check whether the signal from Computer is correct. If connected to certain laptops, the settings of their video adapters need to be changed. You can refer to the operating instructions of the Computer for such modification.- Images can show up only about 20 seconds after the projector is powered on.- Check the input signal, color system, video system or Computer system mode.- Make sure that the temperature doesn't exceed the permitted operating temperature(41°F-104°F [5°C - 40°C]).- If BLANK function is enabled, no image will appear on the screen. You can then press the BLANK button or other button on the remote control.- If HDMI Input doesn't work, adjust "HDMI EQ Setup" (Page 41)

Appendix

No Sound	<ul style="list-style-type: none"> - Check the audio cable connection from audio input source. - Adjust the audio source. - Press the VOLUME + button. - Press the Mute button. - When the AUDIO OUT is plugged in, the projector's built-in speaker is not available. - Is the image projected? The sound can only be heard when the image is projected.
The color is abnormal	<ul style="list-style-type: none"> - Check the input signal, color system, video system or computer system mode. - Make sure that Blackboard is not selected in Image Mode menu.
Auto PC adj. function does not work.	<ul style="list-style-type: none"> - Check the Input signal. Auto PC adj. function can not work when 480p, 576p, 720p, 480i, 576i, 1080i or 1080p is selected.
The Settings cannot be saved after turning off the projector.	<ul style="list-style-type: none"> - Make sure you have selected "store" after you changed the settings. Some settings can't be saved if "store" is not selected.
Power management function does not work.	<ul style="list-style-type: none"> - Power management function can not work while Freeze or Blank function is running.
Logo function does not work.	<ul style="list-style-type: none"> - Check connections and input source.
Auto setup function does not work.	<ul style="list-style-type: none"> - Make sure no function in the Auto setup menu is set to "Off". - Make sure "On" is not chosen in the Ceiling function.
The image is distorted or disappears.	<ul style="list-style-type: none"> - Check and adjust "Screen" menu.
PIN code dialog box appears at start-up	<ul style="list-style-type: none"> - PIN code lock is being set.
The remote control does not work.	<ul style="list-style-type: none"> - Check the batteries. - Make sure no obstruction is between the projector and the remote control. - Make sure you are not too far from the projector when using the remote control. Maximum operating range is 5 m. - Unlock the Key lock function in the Setting menu for the remote control.
Indicators light or flash.	<ul style="list-style-type: none"> - Refer to Indicators and projector condition to check the status of the projector.
Exclamatory mark appears on the screen.	<ul style="list-style-type: none"> - Your operation is invalid. Operate correctly.
top control cannot be operated.	<ul style="list-style-type: none"> - Unlock the Key lock in Setting -> Key lock.
Unable to unlock the Logo PIN code, Key lock or PIN code lock.	<ul style="list-style-type: none"> - Contact the dealer or the service center.



Warning:

High voltages are used to operate this projector. Do not attempt to open the cabinet.

If problems still persist after following all operating instructions, contact the dealer where you purchased the projector or the service center. Specify the model number and explain about the problem. We will advise you how to obtain service.

Appendix

Menu Tree

Main menu	Sub menu	Setting	Note
Display	Auto PC adj.		
	Fine sync	0 to 31	
	H Position	-5 to +5	
	V Position	-5 to +5	
	H.Size	-15 to +15	In different signal, H.Size range will different
	Aspect	Normal Wide Full	"Full" is not available for EK-120U
	Project way	Front Rear Ceiling/Front Ceiling/Rear Auto ceiling/Front Auto ceiling/Rear	
	Menu positon	Upper left Upper right Center Lower left Lower right	
	Background display	Black Blue	
	System	Auto 1080p 1080i 1035i 720p 575p 575i 480p 480i	
Auto PAL SECAM NTSC NTSC4.43 PAL-M PAL-N PAL60			S-video Input Video Input
Color adjust	Image mode	Dynamic Standard Cinema Blackboard(Green) Colorboard User Image	

Appendix

Main menu	Sub menu	Setting	Note	
Color adjust	Contrast	0-63	Computer input	
	Brightness	0-63		
	Color temp.	High/Mid/Low		
	Red	0-63		
	Green	0-63		
	Blue	0-63		
	Sharpness	0-15		
	Contrast	0-63	Video Input	
	Brightness	0-63		
	Color	0-63		
	Tint	0-63		
	Red	0-63		
	Green	0-63		
	Blue	0-63		
Sharpness	0-15			
Setting	On start	On/Off		
	Standby mode	Normal/Eco		
	High land	On/Off		
	Lamp control	Normal/Eco		
	Cooling fast	Normal/60 sec/0 sec		
	Closed caption	Off, CC1,CC2,CC3, CC4		
	Key lock	Off, Projector, Remote control		
	Iris	On/Off		
	Sound	Sound	0-25	
		Mute	On/Off	
	HDMI setup	Image	64-940	
0-1023				
Sound		HDMI		
		Computer		
HDMI EQ setup	1-4			
Expand	Language	English, German, French, Italian, Spanish, Polish, Swedish, Dutch, Portugese, Japanese, Simplified Chinese, Traditional Chinese, Korea, Russian, Arabic, Turkish, Finnish, Norwegian, Danish, Indonesian, Hungarian, Czech, Kazak, Vietnamese, Thai, Farsi	26 Languages	

Appendix

Main menu	Sub menu	Setting		Note	
Expand	Auto setup	Input search	On/Off		
		Auto PC adj.	On/Off		
		Auto keystone	Off		
			Auto		
	Manual				
	Keystone	Keystone	Store/Reset		
		H/V Keystone			
		Corner correction			
		Curved correction			
		Reset value			
	Logo	Logo select	Default/User/Off		"User, Capture" is not available for EK-120U
		Capture			
		Logo PIN code lock	On/Off		
		Logo PIN code change			
	Security	PIN code lock	On/Off		
		PIN code change			
	Power management	Ready Shut down Off Timer Ready countdown			
	Filter counter	Filter counter Timer Filter counter reset			
		Filter check	On/Off		
	Test Pattern	Off, Gray scale1(1-4), Colorbar, Red, Green, Blue, Cross hatch, White, Black, Raster gray			
	Network	Network setting	DHCP IP address Subnet Gateway DNS		
Network information		MAC address IP address			
Factory default					
Lamp counter	Lamp counter Lamp counter reset				

Appendix



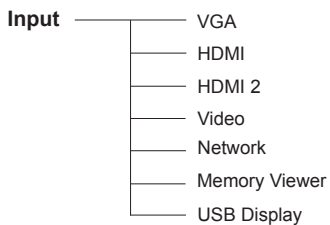



















Main menu	Sub menu	Setting	Note
Memory Viewer	Set Slide		
	Slide transition effect	Slide down Slide right	
	Sort Order	Extend order Size order Timer order Name order	
	Rotate	No Rotate 270 Degrees 180 Degrees 90 Degrees	
	Best Fit	On/Off	
	Repeat	On/Off	
	Apply		
Info.	Input		
	H-sync freq.		
	V-sync freq.		
	Lamp status		
	Lamp counter		
	Power management		
	Image mode		



Appendix

Indicator and projector state

Check the indicator to know about the state of projector.

Indicator		State of projector
WARNING (Red)	POWER (Green/Red/ Yellow)	
		Your projector is in Off status (without AC power supply).
		Your projector is in standby status. Press Power button to turn it on.
		Your projector is in normal status.
		It is ready for standby or the lamp is cooling. You may power on your projector only after the lamp is fully cooled and the POWER light indicator stops flashing.
		Your projector is in Ready mode.
		Your projector cannot power on, as its internal temperature is too high. You may power it on after it is fully cooled, temperature backs to normal, and the POWER indicator stop flashing.
		Your projector detects lamp abnormality and switches into standby mode.
		Your projector detects the temperature abnormality and switches into standby mode.
		Your projector detects lamp abnormality, and switches into cooling mode..
		Your projector detects its usage time \geq the life of the projector when the projector usage time < 1.1 times of the life of the projector.
		Your projector detects its usage time ≥ 1.1 times of the life of the projector.

 Green

 Red

 Yellow

 Off

 Flash green

 Flash red

 Flash Yellow

Appendix

Compatible computer specifications

Your projector is designed to accept every analog computer signal below Dot Clock 160MHz and digital computer signal below Dot Clock 150MHz.

See table below for details on resolution and relevant frequency.:

No.	Display	Source			Specification		
		VGA	HDMI	Video	H-Freq.(KHz)	V-Freq.(Hz)	Pixel clock (MHz)
1	NTSC	—	—	○	15.734	59.940	—
	NTSC-443	—	—	○			
	PAL-60	—	—	○			
	PAL-M	—	—	○			
2	PAL	—	—	○	15.625	50.000	—
	PAL-N	—	—	○			
	SECAM	—	—	○			
3	720x480i,60Hz	○	—	—	15.734	59.940	13.500
4	720x480i,60Hz	○	—	—	15.734	59.940	27.000
5	720x576i,50Hz	○	—	—	15.625	50.000	13.500
6	720x576i,50Hz	○	—	—	15.625	50.000	27.000
7	720x483,60Hz	○	○	—	31.469	59.940	27.000
8	720x576,50Hz	○	○	—	31.250	50.000	27.000
9	1280x720p,60Hz	○	○	—	45.000	60.000	74.250
		○	○	—	44.955	59.940	74.176
		○	○	—	37.500	50.000	74.250
11	1920x1080i,60Hz	○	○	—	33.716	59.940	74.176
		○	○	—	28.125	50.000	74.250
12	1920x1080i,50Hz	○	○	—	27.000	24.000	74.250
		○	○	—	26.970	23.980	74.176
		○	○	—	67.500	60.000	148.500
13	1920x1080p,24Hz	—	○	—	67.433	59.940	148.352
		—	○	—	56.250	50.000	148.500
15	1920x1080p,50Hz	○	○	—	31.469	59.940	25.175
16	640x480,60Hz	○	○	—	35.000	66.667	30.240
17	640x480,67Hz	○	○	—	37.861	72.809	31.500
18	640x480,72Hz	○	○	—	37.500	75.000	31.500
19	640x480,75Hz	○	○	—	43.269	85.008	36.000
20	640x480,85Hz	○	○	—	35.156	56.250	36.000
21	800x600,56Hz	○	○	—	37.879	60.317	40.000
22	800x600,60Hz	○	○	—	48.077	72.188	50.000
23	800x600,72Hz	○	○	—	46.875	75.000	49.500
24	800x600,75Hz	○	○	—	53.674	85.061	56.250
25	800x600,85Hz	○	○	—	49.725	74.550	57.283
26	832x624,75Hz	○	○	—	48.363	60.004	65.000
27	1024x768,60Hz	○	○	—	56.476	70.069	75.000
28	1024x768,70Hz	○	○	—	60.023	75.029	78.750
29	1024x768,75Hz	○	○	—	68.678	84.997	94.500
30	1024x768,85Hz	○	○	—	63.995	70.020	94.200
31	1152x864,70Hz	○	○	—	67.500	75.000	108.000
32	1152x864,75Hz	○	○	—	44.772	59.855	74.500
33	1280x720,60Hz	○	○	—	47.776	59.870	79.500
34	1280x768,60Hz	○	○	—	60.289	74.893	102.250
35	1280x768,75Hz	○	○	—	68.630	84.840	117.500
36	1280x768,85Hz	○	○	—	49.702	59.810	83.500
37	1280x800,60Hz	○	○	—	62.795	74.934	106.500
38	1280x800,75Hz	○	○	—	71.554	84.880	122.500
39	1280x800,85Hz	○	○	—	60.000	60.000	108.000
40	1280x960,60Hz	○	○	—	63.981	60.020	108.000
41	1280x1024,60Hz	○	○	—	78.160	71.970	135.060
42	1280x1024,72Hz	○	○	—	79.976	75.025	135.000
43	1280x1024,75Hz	○	○	—	91.146	85.024	157.500
44	1280x1027,85Hz	○	○	—	47.720	59.799	84.750
45	1366x768,60Hz	○	○	—	65.317	59.978	121.750
46	1400x1050,60Hz	○	○	—	82.278	74.867	156.000
47	1400x1050,75Hz	○	○	—	55.935	59.887	106.500
48	1440x900,60Hz	○	○	—	55.920	60.000	118.998
49	1600x900,60Hz	○	○	—	75.000	60.000	162.000
50	1600x1200,60Hz	○	○	—	65.290	59.954	146.250
51	1680x1050,60Hz	○	○	—	66.587	59.934	138.500
52	1920x1080,60Hz	○	○	—	74.038	59.950	154.000
53	1920x1200,60Hz	○	○	—			

○ Available "—" Disable

✓ **Note:**

Changes to this manual may be made without notice.

Appendix

Technical Specifications

LCD system	WXGA: 0.64" TFT active matrix, 3-panel WUXGA: 0.64" TFT active matrix, 3-panel WXGA: 1280X800/WUXGA: 1920X1200
LCD resolution	
<u>Compatible signals</u>	
Color standard	PAL, SECAM, NTSC, NTSC4.43, PAL-M, PAL-N and PAL60
HDTV signal	480i, 480p, 576i, 576p, 720p, 1080i and 1080p
Scanning frequency	Horizontal frequency: 15 kHz –100 KHz; Vertical frequency: 48 – 85 Hz
<u>Optical elements</u>	
Image size (diagonal lines)	30"-300"
Projection distance	WXGA: 0.8m-8.4m(W) 1.3m-13.9m(T) WUXGA: 0.8m-8.4m(W) 1.3m-13.9m(T)
Lens	F=1.7-2.11, f=17.5-29.01mm; Manual zooming and focusing; Zoom Ratio: 1.66x optics
Lamp Consumption(W)	225W
<u>Terminal</u>	
VGA IN	Mini D-sub 15 pin x1
VGA OUT	Mini D-sub 15 pin x1
HDMI	HDMI x 2
LAN	100 Base-TX (100Mbps)/10 Base-T (10Mbps) RJ45
USB-B	x1(display / Firmware upgrade)
USB-A	x1(memory viewer)
RS-232	D-sub 9 pin x1
AUDIO OUT	3.5mm Mini Type Stereo x1
AUDIO IN	3.5mm Mini Type Stereo x1
Composit Video	2RCA (L/R) x1 RCA x1
<u>Power</u>	
Voltage and power consumption	AC 100–240 V, 50/60 Hz / 217W(Eco), 310W (Normal) for EK-121W 224W (Eco), 320W (Normal) for EK-120U
Internal speaker	10W RMS 8ohm, x1
<u>Operating Environment</u>	
Operating temperature	32°F-104°F (0°C - 40°C)
Storage Temperature	14°F-131°F (-10°C - 55°C)
High land	1400 m - 2700 m
<u>Remote controller</u>	
Battery	AAA or LR3 1.5V ALKALINE TYPE x 2
Operating Range	16.4' (5 m)±30
Dimensions	50mm (W) x 18mm (H) x 110mm (D)
Net Weight	50g (including batteries)
<u>Mechanical properties</u>	
Dimensions (W×H×D)	345.0mmx99.0mmx261.0mm (Not including protrusion)
Net Weight	3.5Kg
Adjustable foot	40mm
<u>Accessories</u>	AC Power Cord, Remote Controller & battery, VGA Cable Quick Start Guide, Safety Information

- The specification is subject to change without prior notice.
- Liquid crystal panel is made on the basis of high standard, where 99.99% of the pixels are effective. Due to the nature of the liquid crystal panel, a fraction of the pixels (0.01% or less) may be ineffective.

Appendix

Configurations of terminals

VGA IN terminal pin assignments and signal names

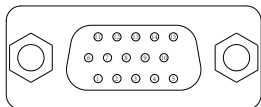

1	Red	9	----
2	Green	10	GND
3	Blue	11	GND
4	----	12	DDC data
5	GND	13	HD/SYNC
6	GND(Red)	14	VD
7	GND(Green)	15	DDC clock
8	GND(Blue)		

VGA OUT terminal pin assignments and signal names

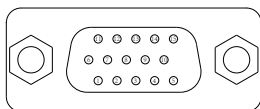

1	Red	9	----
2	Green	10	GND
3	Blue	11	GND
4	----	12	DDC data
5	GND	13	HD/SYNC
6	GND(Red)	14	VD
7	GND(Green)	15	DDC clock
8	GND(Blue)		

RS232 terminal (D-SUB-9 pin)

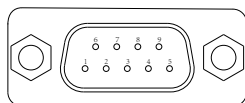

1	----
2	RXD
3	TXD
4	----
5	GND
6	----
7	----
8	----
9	----

LAN terminal

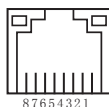

1	TX +	5	----
2	TX -	6	RX -
3	RX +	7	----
4	----	8	----

USB-B terminal

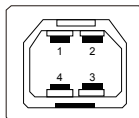

1	V Bus
2	Data -
3	Data +
4	GND

HDMI terminal pin assignments and signal names

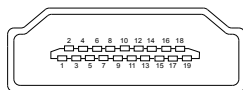

1	T.M.D.S data2+	11	T.M.D.S clock shield
2	T.M.D.S data2 shield	12	T.M.D.S clock-
3	T.M.D.S data2-	13	CEC
4	T.M.D.S data1+	14	Reserved(N.C. on device)
5	T.M.D.S data1 shield	15	SCL
6	T.M.D.S data1-	16	SDA
7	T.M.D.S data0+	17	DDC/CEC GND
8	T.M.D.S data0 shield	18	+5V
9	T.M.D.S data0-	19	Hot plug detec
10	T.M.D.S clock+		

Appendix

Content of hazardous substances and elements

Name of parts	Hazardous substances and elements					
	Pb	Hg	Cd	Cr6+	PBB	PBDE
Optical parts [*]	×	○	○	○	○	○
Electric parts ^{**}	×	○	○	○	○	○
Cabinet, mechanical parts	×	○	○	○	○	○
Lamp unit	×	×	○	○	○	○
Projection Lens	×	○	○	○	○	○
Others(Remote control, cable and other parts)	×	○	○	○	○	○
Speaker	×	○	○	○	○	○

This table is formulated in accordance with SJ/T 11364.

○ : It means that contents of hazardous substances in all homogeneous materials in this part don't exceed "Required Limitations" specified in GB/T26572.

× : It means that contents of hazardous substances in at least one homogeneous material in this part exceed "Required Limitations" specified in GB/T26572.

Note:

* : Optical parts includes optical lens, monitor, reflection lens ect.

** : Electric parts includes PCB, internal wires, fans, power supply, sensors etc.

Dimensions

Unit: mm

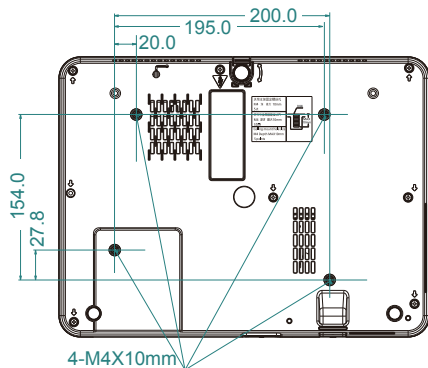
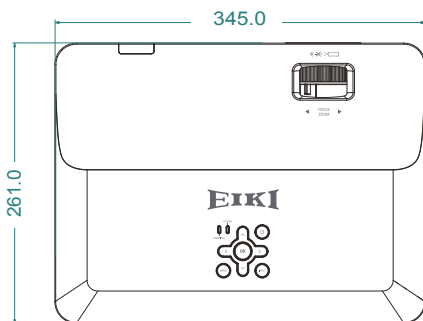
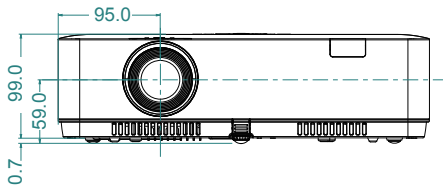

↙
Screw Holes for Ceiling Mount
Screw: M4
Depth: 10.0

Appendix

PIN code memorandum

Write down the PIN code in the blank below and keep it. If you forgot or lost the number and unable to operate the projector, contact the service center.

PIN code lock

Factory default PIN code 111*

--	--	--

Logo PIN code Lock No.

Factory default PIN code 111*

--	--	--

*If this 3-digit number is changed,
the factory default number will be ineffective.



U.S.A.

EIKI International, Inc.
30251 Esperanza
Rancho Santa Margarita
CA 92688-2132, U.S.A.
Tel: +1 800-242-3454
+1 949-457-0200
Fax: +1 800-457-3454
+1 949-457-7878
E-Mail: usa@eiki.com

Deutschland & Österreich

EIKI Deutschland GmbH
Am Frauwald 12
65510 Idstein, Deutschland
Tel: +49 6126-9371-0
Fax: +49 6126-9371-11
E-Mail: info@eiki.de

China

EIKI (Shanghai) Co., Ltd.
LAKESIDE OASIS MIDDLE RING
BUSINESS CENTRE
Block 1, Room 606,
1628, Jin Sha Jiang Road
Shanghai, 200333, CHINA
China
Tel: +86 21-3251-3993
Service Hot line: +86 21-3251-3995
Fax: +86 21-3251-3997
E-mail: info@eiki-china.com

Oceania

EIKI AUSTRALIA PTY LTD
Level 5, 11 Queens Road,
Melbourne, Victoria 3004, Australia
Tel: +61 03-8530-7048
Fax: +61 03-9820-5834
E-Mail: sales@eiki.net.au

Canada

EIKI CANADA
Eiki International, Inc.
Canadian Branch
9170 County Road 93, Suite 304,
Midland, ON, L4R 4K4, Canada
Tel: +1 800-563-3454
+1 705-527-4084
E-Mail: canada@eiki.com

Eastern Europe

EIKI CZECH SPOL. s.r.o.
Nad Cementárnou 1163/4a
Praha 4, Podolí, 147 00
Czech Republic
Tel: +420 241-410-928
+420 241-403-095
Fax: +420 241-409-435
E-Mail: info@eiki.cz

South East Asia

EIKI Industrial (M) Sdn Bhd
No. 11, Nouvelle Industrial Park,
Lorong Teknologi B, Taman Sains
Selangor 1, Kota Damansara PJU5,
47810 Petaling Jaya,
Selangor Darul Ehsan, Malaysia
Tel: +60 3-6157-9330
Fax: +60 3-6157-1320
E-Mail: sales@eiki.my

Japan & Worldwide

EIKI Industrial Company Limited.
6-23 Teramoto, Itami-shi, Hyogo,
664-0026, Japan
Tel: +81 72-782-7492
Fax: +81 72-781-5435

World Wide Website <https://global.eiki.com/>