



Operating Manual

EL 9000 T

Electronic DC Load



Attention! This document is only valid for devices with firmwares "KE: 3.09", "HMI: 2.05" or higher.



Doc ID: EL9TEN
Revision: 03
Date: 11/2021



TABLE OF CONTENTS

1 GENERAL

1.1	About this document	5
1.1.1	Retention and use	5
1.1.2	Copyright	5
1.1.3	Validity	5
1.1.4	Symbols and warnings	5
1.2	Warranty	5
1.3	Limit of liability	5
1.4	Disposal of equipment	6
1.5	Product key	6
1.6	Intended usage	6
1.7	Safety	7
1.7.1	Safety notices	7
1.7.2	Responsibility of the user	7
1.7.3	Responsibility of the operator	8
1.7.4	User requirements	8
1.7.5	Alarm signals	9
1.8	Technical data	9
1.8.1	Approved operating conditions	9
1.8.2	General technical data	9
1.8.3	Specific technical data	10
1.8.4	Views	12
1.8.5	Control elements	14
1.9	Construction and function	15
1.9.1	General description	15
1.9.2	Block diagram	15
1.9.3	Scope of delivery	15
1.9.4	Optional accessories	15
1.9.5	The control panel (HMI)	16
1.9.6	USB port (back side)	18
1.9.7	“Sense” connector (remote sensing)	19
1.9.8	Ethernet port	19
1.9.9	Analog interface	19

2 INSTALLATION & COMMISSIONING

2.1	Storage	20
2.1.1	Packaging	20
2.1.2	Storage	20
2.2	Unpacking and visual check	20
2.3	Installation	20
2.3.1	Safety procedures before installation and use	20
2.3.2	Preparation	20
2.3.3	Installing the device	20
2.3.4	Connection to DC sources	21
2.3.5	Grounding of the DC input	21
2.3.6	Connection of remote sensing	21
2.3.7	Connecting the analog interface	22
2.3.8	Connecting the USB port (rear side)	22
2.3.9	Initial commission	23
2.3.10	Commission after a firmware update or a long period of non use	23

3 OPERATION AND APPLICATION

3.1	Personal safety	24
3.2	Operating modes	24
3.2.1	Voltage regulation / Constant voltage	24
3.2.2	Current regulation / constant current / current limitation	25
3.2.3	Resistance regulation / constant resistance	25
3.2.4	Power regulation / constant power / power limitation	25
3.2.5	Dynamic characteristics and stability criteria	26
3.3	Alarm conditions	27
3.3.1	Power Fail	27
3.3.2	Overtemperature	27
3.3.3	Overvoltage	27
3.3.4	Overcurrent	27
3.3.5	Overpower	27
3.4	Manual operation	28
3.4.1	Powering the device	28
3.4.2	Switching the device off	28
3.4.3	Configuration via MENU	28
3.4.4	Adjustment limits	33
3.4.5	Changing the operating mode	33
3.4.6	Manual adjustment of set values	34
3.4.7	Switching the main screen view	34
3.4.8	Switching the DC input on or off	35
3.4.9	Recording to USB stick (logging)	36
3.5	Remote control	37
3.5.1	General	37
3.5.2	Controls locations	37
3.5.3	Remote control via a digital interface	37
3.5.4	Remote control via the analog interface (AI)	39
3.6	Alarms and monitoring	43
3.6.1	Definition of terms	43
3.6.2	Device alarm and event handling	43
3.7	Control panel (HMI) lock	45
3.8	Limits lock	46
3.9	Loading and saving a user profile	46
3.10	The function generator	48
3.10.1	Introduction	48
3.10.2	General	48
3.10.3	Method of operation	48
3.10.4	Manual operation	49
3.10.5	Sine wave function	50
3.10.6	Triangular function	50
3.10.7	Rectangular function	51
3.10.8	Trapezoidal function	52
3.10.9	Ramp function	52
3.10.10	Arbitrary function	53
3.10.11	Battery test function	57
3.10.12	MPP tracking function	59
3.10.13	Remote control of the function generator	62

3.11	Other applications	62
3.11.1	Series connection	62
3.11.2	Parallel operation	62

4 SERVICE AND MAINTENANCE

4.1	Maintenance / cleaning.....	63
4.2	Fault finding / diagnosis / repair.....	63
4.2.1	Replacing a defect mains fuse	63
4.2.2	Firmware updates	63
4.3	Calibration	64
4.3.1	Preface	64
4.3.2	Preparation.....	64
4.3.3	Calibration procedure	64

5 CONTACT AND SUPPORT

5.1	Repairs	66
5.2	Contact options	66

1. General

1.1 About this document

1.1.1 Retention and use

This document is to be kept in the vicinity of the equipment for future reference and explanation of the operation of the device. This document is to be delivered and kept with the equipment in case of change of location and/or user.

1.1.2 Copyright

Modification and partial or complete usage of this PDF document for other purposes as intended are forbidden and breach may lead to legal process.



1.1.3 Validity

This manual is valid for the following equipment.

Model	Article number
EL 9080-45 T	33 210 511
EL 9200-18 T	33 210 512
EL 9500-08 T	33 210 513

1.1.4 Symbols and warnings

Warning and safety notices as well as general notices in this document are shown in a box with a symbol as follows:

	Symbol for a life threatening danger
	Symbol for general safety notices (instructions and damage protection bans)
	<i>Symbol for general notices</i>

1.2 Warranty

EA Elektro-Automatik guarantees the functional competence of the device within the stated performance parameters. The warranty period begins with the delivery of free from defects equipment.

Terms of guarantee are included in the general terms and conditions of EA Elektro-Automatik.

1.3 Limit of liability

All statements and instructions in this manual are based on current norms and regulations, up-to-date technology and our long term knowledge and experience. EA Elektro-Automatik accepts no liability for losses due to:

- Usage for purposes other than defined
- Use by untrained personnel
- Rebuilding by the customer
- Technical changes
- Use of non authorized spare parts

The actual delivered device(s) may differ from the explanations and diagrams given here due to latest technical changes or due to customized models with the inclusion of additionally ordered options.

1.4 Disposal of equipment

A piece of equipment which is intended for disposal must, according to European laws and regulations (ElektroG, WEEE) be returned to EA Elektro-Automatik for scrapping, unless the person operating the piece of equipment or another, delegated person is conducting the disposal. Our equipment falls under these regulations and is accordingly marked with the following symbol:



1.5 Product key

Decoding of the product description on the label, using an example:

EL 9080 - 45 T

Construction/Version: T = Tower housing
Maximum current of the device in Ampere 45
Maximum voltage of the device in Volt 80
Series: 9 = Series 9000
Type identification: EL = Electronic Load

1.6 Intended usage

The equipment is intended to be used, if a power supply or battery charger, only as a variable voltage and current source, or, if an electronic load, only as a variable current sink.

Typical application for a power supply is DC supply to any relevant user, for a battery charger the charging of various battery types and for electronic loads the replacement of Ohm resistance by an adjustable DC current sink in order to load relevant voltage and current sources of any type.



- Claims of any sort due to damage caused by non-intended usage will not be accepted.
- All damage caused by non-intended usage lies solely in the responsibility of the operator.

1.7 Safety

1.7.1 Safety notices

Mortal danger - Hazardous voltage



- **Electrical equipment operation means that some parts will be under dangerous voltage. Therefore all parts under voltage must be covered!**
- **All work on connections must be carried out under zero voltage (DC input not connected to voltage sources) and may only be performed by qualified and informed persons. Improper actions can cause fatal injury as well as serious material damage.**
- **Never touch cables or connectors directly after unplugging from mains supply as the danger of electric shock remains.**
- **Never touch blank contacts on the DC input right after usage of the device, because between DC- and DC+ there can be dangerous potential against ground (PE) which either doesn't discharge at all or only very slowly!**



- The equipment must only be used as intended
- The equipment is only approved for use within the connection limits stated on the product label.
- Do not insert any object, particularly metallic, through the ventilator slots
- Avoid any use of liquids near the equipment. Protect the device from wet, damp and condensation.
- For power supplies and battery chargers: do not connect load, particularly such with low resistance, to devices under power; sparking may occur which can cause burns as well as damage to the equipment, to the load and to the user.
- For electronic loads: do not connect power sources to equipment under power, sparking may occur which can cause burns as well as damage to the equipment and to the source.
- ESD regulations must be applied when plugging interface cards or modules into the relative slot
- Interface cards or modules may only be attached or removed after the device is switched off. It'sn't necessary to open the device.
- Do not connect external power sources with reversed polarity to DC inputs or outputs! The equipment will be damaged.
- For power supply devices: avoid where possible connecting external power sources to the DC output, and never those that can generate a higher voltage than the nominal voltage of the device.
- For electronic loads: do not connect a power source to the DC input which can generate a voltage more than 120% of the nominal input voltage of the load. The equipment isn't protected against over voltage and may be irreparably damaged.
- Always configure the various protecting features against overcurrent, overpower etc. for sensitive sources to what the currently used application requires

1.7.2 Responsibility of the user

The equipment is in industrial operation. Therefore the operators are governed by the legal safety regulations. Alongside the warning and safety notices in this manual the relevant safety, accident prevention and environmental regulations must also be applied. In particular the users of the equipment:

- must be informed of the relevant job safety requirements
- must work to the defined responsibilities for operation, maintenance and cleaning of the equipment
- before starting work must have read and understood the operating manual
- must use the designated and recommended safety equipment.

Furthermore, anyone working with the equipment is responsible for ensuring that the device is at all times technically fit for use.

1.7.3 Responsibility of the operator

Operator is any natural or legal person who uses the equipment or delegates the usage to a third party, and is responsible during its usage for the safety of the user, other personnel or third parties.

The equipment is in industrial operation. Therefore the operators are governed by the legal safety regulations. Alongside the warning and safety notices in this manual the relevant safety, accident prevention and environmental regulations must also be applied. In particular the operator has to

- be acquainted with the relevant job safety requirements
 - identify other possible dangers arising from the specific usage conditions at the work station via a risk assessment
 - introduce the necessary steps in the operating procedures for the local conditions
 - regularly check that the operating procedures are current
 - update the operating procedures where necessary to reflect changes in regulation, standards or operating conditions.
 - define clearly and unambiguously the responsibilities for operation, maintenance and cleaning of the equipment.
 - ensure that all employees who use the equipment have read and understood the manual. Furthermore the users are to be regularly schooled in working with the equipment and the possible dangers.
 - provide all personnel who work with the equipment with the designated and recommended safety equipment
- Furthermore, the operator is responsible for ensuring that the device is at all times technically fit for use.

1.7.4 User requirements

Any activity with equipment of this type may only be performed by persons who are able to work correctly and reliably and satisfy the requirements of the job.

- Persons whose reaction capability is negatively influenced by e.g. drugs, alcohol or medication may not operate the equipment.
- Age or job related regulations valid at the operating site must always be applied.



Danger for unqualified users

Improper operation can cause person or object damage. Only persons who have the necessary training, knowledge and experience may use the equipment.

Delegated persons are those who have been properly and demonstrably instructed in their tasks and the attendant dangers.

Qualified persons are those who are able through training, knowledge and experience as well as knowledge of the specific details to carry out all the required tasks, identify dangers and avoid personal and other risks.

1.7.5 Alarm signals

The equipment offers various possibilities for signalling alarm conditions, however, not for danger situations. The signals may be optical (on the display as text) or electronic (pin/status output on an optional analog interface). All alarms will cause the device to switch the DC input off.

The meaning of the signals is as follows:

Signal OT (OverTemperature)	<ul style="list-style-type: none"> • Overheating of the device • DC input will be switched off • Non-critical
Signal OVP (OverVoltage)	<ul style="list-style-type: none"> • Overvoltage shutdown of the DC input occurs due to high voltage entering the device • Critical! The device and/or the load could be damaged
Signal OCP (OverCurrent)	<ul style="list-style-type: none"> • Shutdown of the DC input due to excess of the preset limit • Non-critical, protects the source from excessive current drain
Signal OPP (OverPower)	<ul style="list-style-type: none"> • Shutdown of the DC input due to excess of the preset limit • Non-critical, protects the source from excessive power drain
Signal PF (Power Fail)	<ul style="list-style-type: none"> • DC input shutdown due to AC undervoltage or internal auxiliary supply defect • Critical on AC overvoltage! AC mains input circuit could be damaged

1.8 Technical data

1.8.1 Approved operating conditions

- Use only inside buildings and in a dry environment with normally polluted air
- Ambient temperature 0-50 °C
- Operational altitude: max. 2000 m above sea level
- Maximum 80% humidity, not condensing

1.8.2 General technical data

Display: Colour TFT touch screen with gorilla glass, 3.5", 320pt x 240pt, capacitive

Controls: 2 rotary knobs with pushbutton functions, 1 button

The nominal values for the device determine the maximum adjustable ranges.

1.8.3 Specific technical data

	<i>Model</i>		
	<i>EL 9080-45 T</i>	<i>EL 9200-18 T</i>	<i>EL 9500-08 T</i>
AC supply			
Supply voltage	90...264 V AC		
Connection type	Wall socket		
Frequency	45...65 Hz		
Fuse	T 2 A		
Power consumption	Max. 40 W		
Inrush current @ 230 V	≈ 23 A		
Leak current	< 3.5 mA		
DC input			
Max. input voltage U_{Max}	80 V	200 V	500 V
Input power P_{Nom}	600 W	500 W	400 W
Input power P_{Max} @ 40°C	550 W	500 W	400 W
Max. input current I_{Max}	45 A	18 A	8 A
Overvoltage protection range	$0...1.03 * U_{Max}$	$0...1.03 * U_{Max}$	$0...1.03 * U_{Max}$
Overcurrent protection range	$0...1.1 * I_{Max}$	$0...1.1 * I_{Max}$	$0...1.1 * I_{Max}$
Overpower protection range	$0...1.1 * P_{Nom}$	$0...1.1 * P_{Nom}$	$0...1.1 * P_{Nom}$
Max. allowed input voltage	88 V	220 V	550 V
Min. input voltage for I_{Max}	Approx. 2.2 V	Approx. 2 V	Approx. 6.5 V
Temperature coefficient for set values Δ / K	Voltage / current: 100 ppm		
Voltage regulation			
Adjustment range	0...81.6 V	0...204 V	0...510 V
Stability at ΔI	< 0.05% U_{Max}	< 0.05% U_{Max}	< 0.05% U_{Max}
Accuracy ⁽¹⁾ (at 23 ± 5°C)	≤ 0.1% U_{Max}	≤ 0.1% U_{Max}	≤ 0.1% U_{Max}
Display: Adjustment resolution	See section „1.9.5.4. Resolution of the displayed values“		
Display: Accuracy ⁽²⁾	≤ 0.1%		
Remote sensing compensation	Max. 5% U_{Max}		
Current regulation			
Adjustment range	0...45.9 A	0...18.36 A	0...8.16 A
Stability at ΔU	< 0.1% I_{Max}	< 0.1% I_{Max}	< 0.1% I_{Max}
Accuracy ⁽¹⁾ (at 23 ± 5°C)	≤ 0.2% I_{Max}	≤ 0.2% I_{Max}	≤ 0.2% I_{Max}
Display: Adjustment resolution	See section „1.9.5.4. Resolution of the displayed values“		
Display: Accuracy ⁽²⁾	≤ 0.1%		
Rise time 10...90% I_{Nom}	< 23 μ s	< 40 μ s	< 22 μ s
Fall time 90...10% I_{Nom}	< 46 μ s	< 42 μ s	< 29 μ s
Power regulation			
Adjustment range	$0...1.02 * P_{Nom}$	$0...1.02 * P_{Nom}$	$0...1.02 * P_{Nom}$
Accuracy ⁽¹⁾ (at 23 ± 5°C)	< 0.5% P_{Nom}	< 0.5% P_{Nom}	< 0.5% P_{Nom}
Display: Adjustment resolution	See section „1.9.5.4. Resolution of the displayed values“		
Display: Accuracy ⁽²⁾	≤ 0.2%		
Resistance regulation			
Adjustment range	0.12...40.8 Ω	1...346.8 Ω	6...2040 Ω
Accuracy ⁽³⁾ (at 23 ± 5°C)	≤ 1% of maximum resistance + 0.3% of rated current		
Display: Adjustment resolution	See section „1.9.5.4. Resolution of the displayed values“		

(1) Related to the nominal values, the accuracy defines the maximum deviation between an adjusted values and the true (actual) value.

(2) The display accuracy adds to the accuracy of the corresponding value on the DC input

(3) Also includes the display error

	<i>Model</i>		
	<i>EL 9080-45 T</i>	<i>EL 9200-18 T</i>	<i>EL 9500-08 T</i>
Analog interface ⁽¹⁾			
Set value inputs	U, I, P, R		
Actual value output	U, I		
Control signals	DC input on/off, remote control on/off, resistance mode on/off		
Status signals	CV, OVP, OCP, OPP, OT, PF, DC input on/off		
Galvanic isolation to the device	Max. 1500 V DC		
Insulation			
Input (DC) to enclosure	DC minus: permanent max. 400 V DC plus: permanent max. 400 V + max. input voltage		
Input (AC) to input (DC)	Max. 2500 V, short-term		
Environment			
Cooling	Temperature controlled fan		
Ambient temperature	0..50 °C		
Storage temperature	-20...70 °C		
Digital interfaces			
Featured	1x USB-B for communication (rear side), 1x USB-A for functions (front side)		
Optional	1x LAN for communication (front side)		
Galvanic isolation to the device	Max. 1500 V DC		
Terminals			
Rear side	AC input, USB-B, Ethernet (optional), analog interface (optional)		
Front side	DC input, USB-A, remote sensing		
Dimensions			
Enclosure (WxHxD)	92 x 239 x 352 mm		
Total (WxHxD)	92 x 239 x min. 393 mm		
Standards	EN 61010-1:2011-07, EN 61000-6-2:2016-05, EN 61000-6-3:2011-09		
Weight	≈ 6.5 kg	≈ 6.5 kg	≈ 6.5 kg
Article number	33210511	33210512	33210513

(1 Optionally available, for technical specifications of the analog interface see „3.5.4.4 Analog interface specification“ on page 40

1.8.4 Views

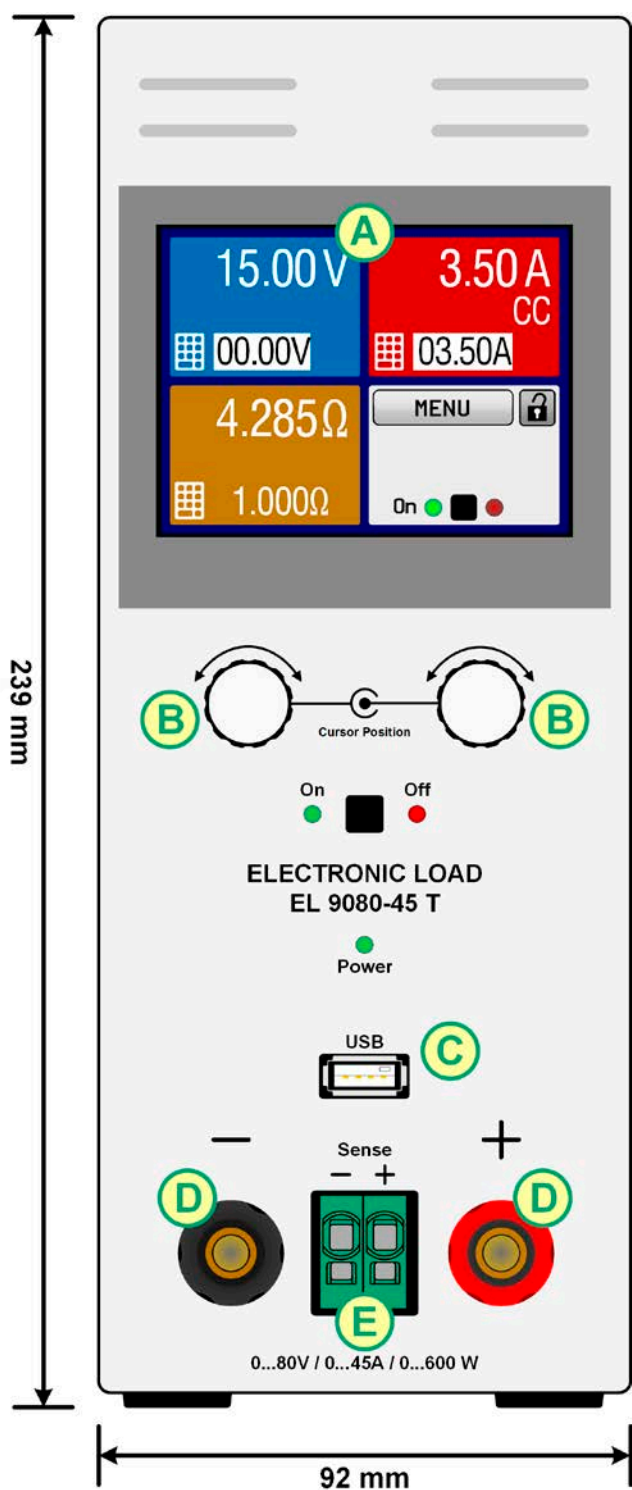

Figure 1 - Front side

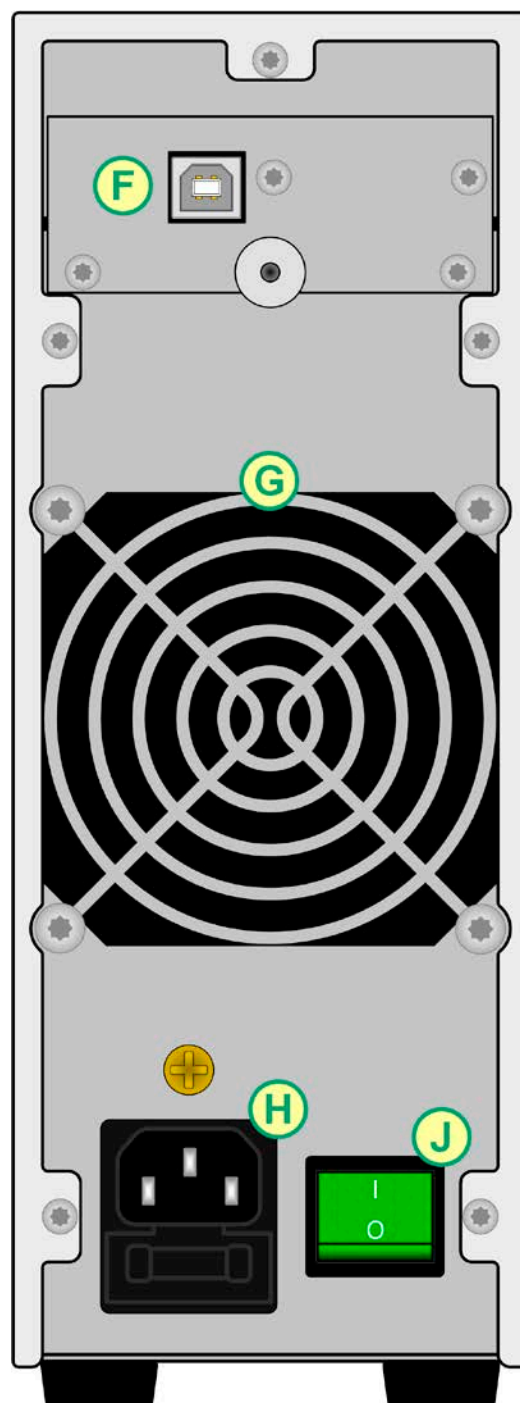

Figure 2 - Back side (delivery version with USB only)



Do not loosen the grounding point (brass screw next to fuse holder H) in order to connect PE cables! The device is supposed to be grounded via the AC cord, while the grounding point is used to connect the enclosure to PE.

- A - Touch screen
- B - Adjustment knobs
- C - Front USB port (type A)
- D - DC input
- E - Remote sensing input

- F - Slot for a remote control interface module
- G - Fan exhaust
- H - AC supply connection
- J - Power switch

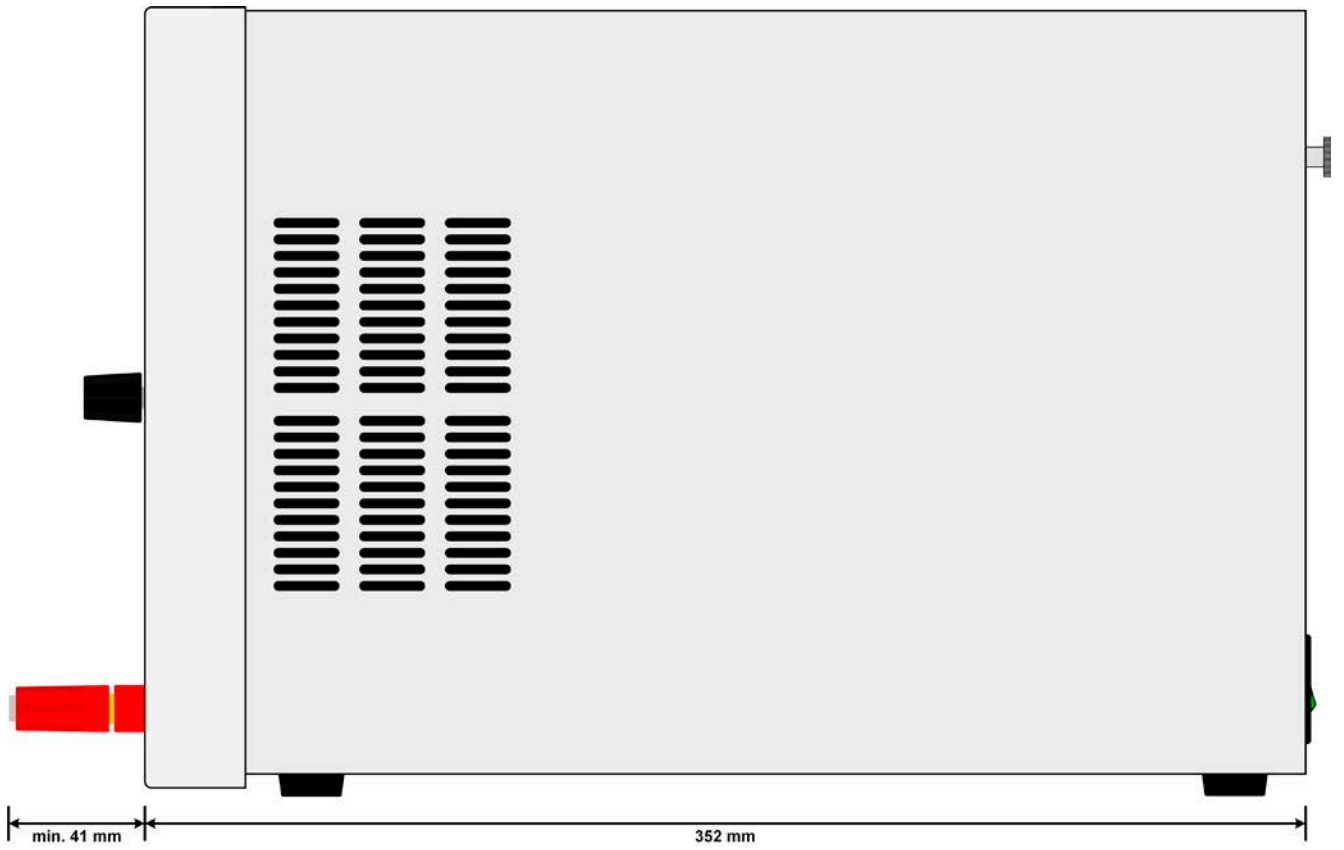

Figure 3 - Side view from right

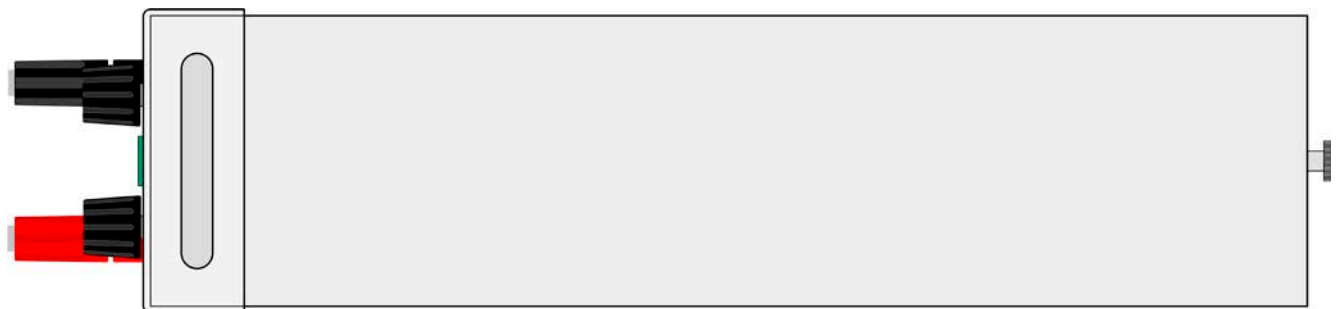

Figure 4 - Top view

1.8.5 Control elements

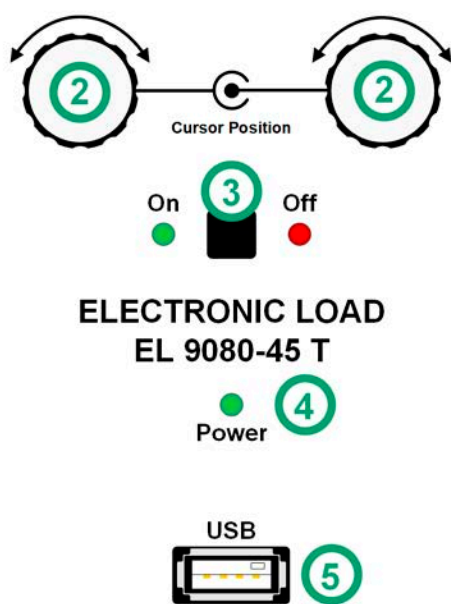
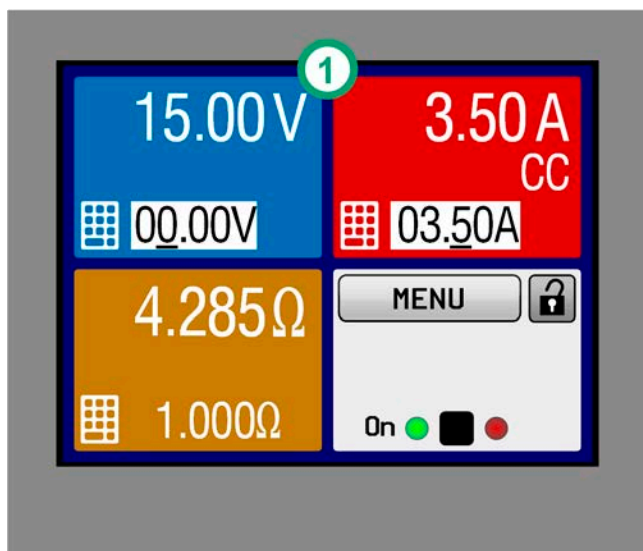

Figure 5 - Control Panel

Overview of the elements on the control panel

For a detailed description see section „1.9.5. The control panel (HMI)“ and „1.9.5.2. Rotary knobs“.

(1)	<p>Touchscreen display</p> <p>Used for selection of set values and menus, as well as display of status and actual values.</p> <p>The touchscreen can be operated with the fingers or with a stylus.</p>
(2)	<p>Rotary knob with push button function</p> <p>Left knob (turn): Adjustment of voltage, power or resistance set values. Also setting of parameter values in the menu.</p> <p>Left knob (push): Selection of the decimal position to be changed (cursor).</p> <p>Right knob (turn): Adjustment of the current set value. Also setting parameter values in the menu.</p> <p>Right knob (push): Selection of the decimal position to be changed (cursor) in the value currently assigned to the knob.</p>
(3)	<p>On/Off Button for DC input</p> <p>Used to toggle the DC input between on and off, also used to start/stop a function run. The LEDs “On” and “Off” indicate the state of the DC input, no matter if the device is manually controlled or remotely.</p>
(4)	<p>LED “Power”</p> <p>Signals different colours during the start of the device and as soon as the device is ready to operate, the LED would turn green.</p>
(5)	<p>Port for USB sticks</p> <p>For the connection of standard USB sticks. See section „1.9.5.5. USB port (front side)“ for more details..</p>

1.9 Construction and function

1.9.1 General description

The conventional, electronic DC loads of the EL 9000 T series with their small desktop enclosure in tower design are especially suitable for research laboratories or educational facilities.

Apart from basic functions of electronic loads, set point curves can be generated from the integrated function generator (sine, rectangular, triangular and other curve types). Arbitrary curves can be stored on and uploaded from an USB stick.

For remote control using a PC or PLC the devices are provided as standard with USB, but can also be extended with an Ethernet/LAN port as well as a galvanically isolated analog interface by installing an optional interface module.

All models are controlled by microprocessors.

1.9.2 Block diagram

The block diagram illustrates the main components inside the device and their relationships.

There are digital, microprocessor controlled components (KE, DR, HMI), which can be target of firmware updates.

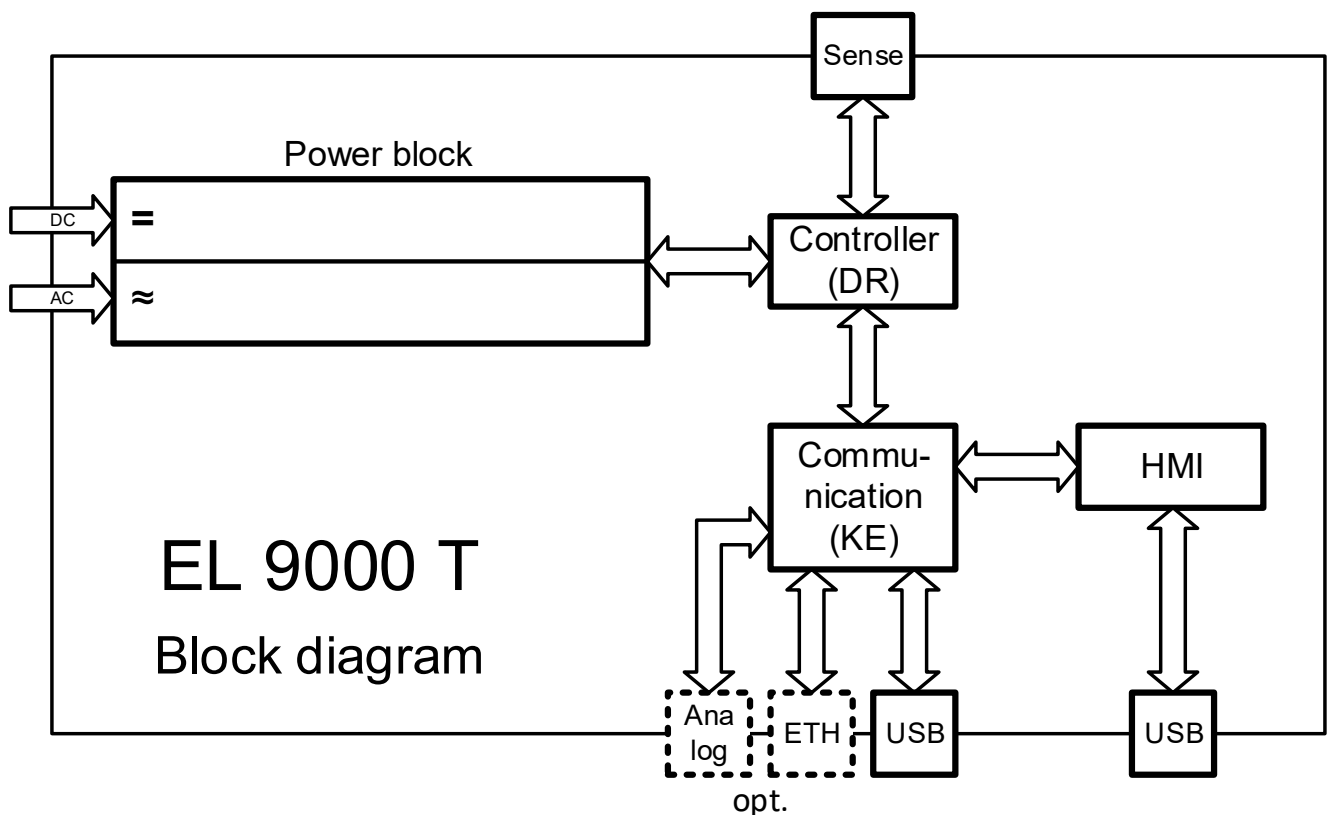

1.9.3 Scope of delivery

- 1 x Electronic load device
- 1 x 1.8 m USB cable
- 1 x USB stick with documentation and software
- 1 x Mains cord (Schuko 10 A or different for US or UK deliveries, else with plug adapter)

1.9.4 Optional accessories

For these devices the following accessories are available:

<p>IF-KE4 Ordering nr. 33 100 231</p>	<p>Exchangeable interface module with USB and Ethernet ports, as well as a 15 pole analog interface (D-Sub type). All interfaces are galvanically isolated from the device. The module can be easily retrofitted by the end user.</p>
--	---

1.9.5 The control panel (HMI)

The HMI (Human Machine Interface) consists of a display with touchscreen, two rotary knobs, a button and a USB port for thumb drives.

1.9.5.1 Touchscreen display

The graphic touchscreen display is divided into a number of areas. The complete display is touch sensitive and can be operated by finger or stylus to control the equipment.

In normal operation the screen is separated into four areas of equal size, of which three are used to show actual and set values and one to display status information:

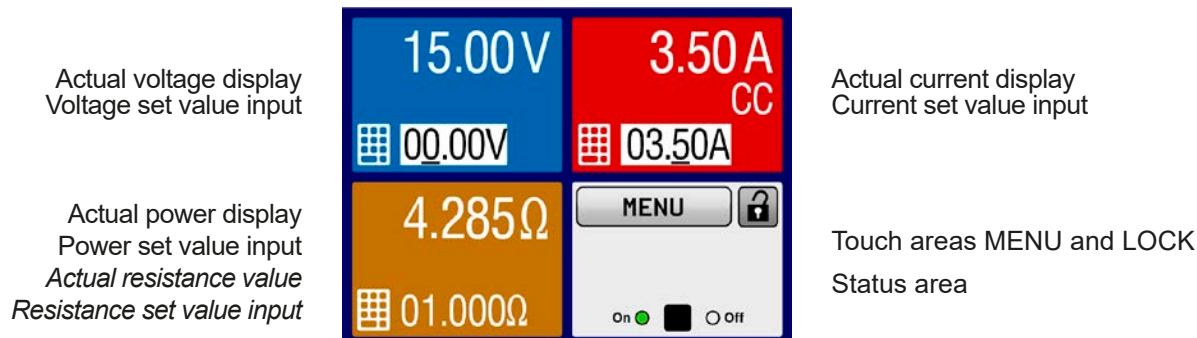

Touch areas may be enabled or disabled:

MENU

Black text or symbol = Enabled

MENU

Grey text or symbol = Disabled

• Actual / set values area (blue, red, green, brown)

In normal operation the actual values on the DC input (large numbers), as well as values (small numbers) for voltage, current and power are displayed. The set value of resistance is only displayed if resistance mode is activated. The fourth set value, P in this case, is hidden and in resistance mode only accessible via the MENU and only while the DC input is switched off.

While the DC input is switched on, the actual regulation mode **CV**, **CC**, **CP** or **CR** is displayed in the corresponding coloured area, as depicted in the figure above with “CC” as example.

The set values can be adjusted with the rotary knobs or can be entered directly via the touchscreen. When adjusting with the knobs, pushing the knob will select the digit to adjust. Logically, the values are increased by 1 when rotating clockwise and decreased by 1 when rotating anti-clockwise, until reaching a limit (see „3.4.4. Adjustment limits“).

General display and setting ranges:



Display	Unit	Range	Description
Actual voltage	V	0.2-125% U_{Nenn}	Actual value of DC input voltage
Set value of voltage ⁽¹⁾	V	0-100% U_{Nenn}	Set value for limiting the DC input voltage
Actual current	A	0.2-125% I_{Nenn}	Actual value of DC input current
Set value of current ⁽¹⁾	A	0-100% I_{Nenn}	Set value for limiting the DC input current
Actual power	W	0.2-125% P_{Peak}	Calculated actual value of input power, $P = U_{IN} * I_{IN}$
Set value of power ⁽¹⁾	W	0-100% P_{Peak}	Set value for limiting DC input power
Actual resistance	Ω	0...99.999 Ω	Calculated actual internal resistance, $R = U_{IN} / I_{IN}$
Set value of resistance	Ω	$x^{(2)}$ -102% R_{Max}	Set value for the target internal resistance
Adjustment limits 1	A,V,W	0-102% nom	U-max, I-min etc., related to the physical values
Adjustment limits 2	Ω	$x^{(2)}$ -102% nom	R-max
Protection settings 1	A,W	0-110% nom	OCP and OPP, related to the physical values
Protection settings 2	V	0-103% nom	OVP, related to the physical values

⁽¹⁾ Valid also for values related to these physical quantities, such as OVD for voltage and UCD for current

⁽²⁾ The minimum resistance set value varies according to model. See technical specifications in 1.8.3

• Status indicators (lower right)

This area displays various status texts and symbols:

Display	Description
Locked	The HMI is locked
Unlocked	The HMI is unlocked
Remote:	The device is under remote control from....
Analogthe (optional) rear analog interface
USBthe rear USB port
Ethernetthe (optional) rear Ethernet port
Local	The device has been locked by the user explicitly against remote control
Alarm:	Alarm condition which has not been acknowledged or still exists.
Event:	A user defined event has occurred which isn't yet acknowledged.
FG:	Function generator mode (remote control)
Function:	Function generator mode active (manual control)
 / 	Data logging to USB stick active or failed

1.9.5.2 Rotary knobs



As long as the device is in manual operation the two rotary knobs are used to adjust set values as well as setting the parameters in the MENU. For a detailed description of the individual functions see section „3.4. Manual operation“. While the screen shows the main page, the assignment of the left-hand knob can be changed by tapping either the blue (voltage) or green/brown (power or resistance) area on screen, unless the control panel is locked. The right-hand knob is permanently assigned to current (red) on the main page.

Alternatively, values can be entered directly with a ten-key pad by tapping on the small icons



1.9.5.3 Button function of the rotary knobs

The rotary knobs also have a pushbutton function which is used in all menu options to move the cursor for value adjustment by clockwise rotation, like this:



1.9.5.4 Resolution of the displayed values

In the display, set values can be adjusted in fixed increments. The number of decimal places depends on the device model. The values have 4 or 5 digits. Actual and set values always have the same number of digits.

Adjustment resolution and number of digits of set values in the display:

Voltage, OVP, UVD, OVD, U-min, U-max			Current, OCP, UCD, OCD, I-min, I-max			Power, OPP, OPD, P-max			Resistance, R-max		
Nominal	Digits	Step width	Nominal	Digits	Step width	Nominal	Digits	Step width	Nominal	Digits	Step width
80 V	4	0.01 V	8 A	4	0.001 A	all	4	0.1 W	40 Ω	5	0.001 Ω
200 V	5	0.01 V	18 A	5	0.001 A				340 Ω	5	0.01 Ω
500 V	4	0.1 V	45 A	4	0.01 A				2000 Ω	5	0.1 Ω

1.9.5.5 USB port (front side)

The frontal USB port, located below the LED “Power”, is intended for the connection of standard USB sticks. This can be used for uploading or downloading of sequence data for the arbitrary function generator or DC input data recording during all operation modes.

USB 2.0 sticks are widely accepted, must be **FAT32** formatted and have a **maximum capacity of 32 GB**. USB 3.0 sticks also work, but not from all manufacturers. All supported files must be held in a designated folder in the root path **HMI_FILES** of the USB drive in order to be found. Example: G:\HMI_FILES, if the drive has been assigned the letter G.

The control panel of the device can read the following file types from an USB stick:

wave_u<arbitrary_text>.csv wave_i<arbitrary_text>.csv	Function generator for an arbitrary function on voltage (U) or current (I). The name must begin with <i>wave_u</i> / <i>wave_i</i> , the rest is user defined.
profile_<nr>.csv	Previously saved user profile. The number in the file name is a counter and not related to the actual user profile number in the HMI. A max. of 10 files to select from is shown when loading a user profile.
mpp_curve_<arbitrary_text>.csv	User-defined curve data (100 voltage values) for mode MPP4 of the MPPT function

The control panel of the device can save the following file types to an USB stick:

battery_test_log_<nr>.csv	File with log data recorded from the battery test function. For a battery test log, data different and/or additional to log data of normal logging is recorded. The <nr> field in the file name is automatically counted up if equally named files already exist in the folder.
usb_log_<nr>.csv	File with log data recorded during normal operation in all modes. The file layout is identical to the those generated from the Logging feature in EA Power Control. The <nr> field in the file name is automatically counted up if equally named files already exist in the folder.
profile_<nr>.csv	User profile. The number in the file name is a counter and not related to the actual user profile number in the HMI. A max. of 10 files can be stored by in the folder.
wave_u_<nr>.csv wave_i_<nr>.csv	Function generator, arbitrary function, 99 sequence points of either voltage (U) or current (I), depending on the selection
mpp_result_<nr>.csv	Result data from MPP tracking mode 4 in form of a table with 100 data groups (Umpp, Impp, Pmpp)

1.9.6 USB port (back side)

The USB-B port on the back side of the device is provided for communication with the device and for firmware updates. The included USB cable can be used to connect the device to a PC (USB 2.0 or 3.0) or other suitable control hardware. The driver is delivered on the included USB stick and installs a virtual COM port. Details about remote control can be found in further documentatn on the included USB stick or the web site of Elektro-Automatik.

The device can be addressed via this port either using the international standard ModBus RTU protocol or by SCPI language. The device recognises the message protocol automatically.

If remote control is going to be activated, the USB interface has no priority over any other interface and can therefore only be used alternatively to them. However, monitoring is always available, no matter if the device is remotely controlled and via what interface.

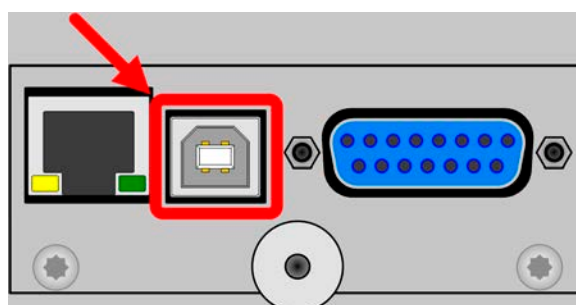

Picture shows optional IF-KE4 module

1.9.7 “Sense” connector (remote sensing)

In order to compensate for voltage drops along the DC cables, the **Sense** input (between the DC input terminals) can be connected to the source. The device will automatically detect when the sense input is wired (Sense+) and compensate the input voltage accordingly. The maximum possible compensation is given in the technical specifications.

Remote sensing compensation is only effective in constant voltage (CV) operation. Keeping this input connected in other regulation modes should be avoided as the typically thin lines can increase the oscillation tendency. Also see section 3.2.5 for more about this topic.

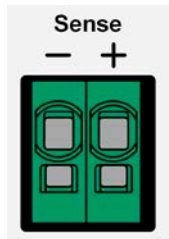

1.9.8 Ethernet port

The Ethernet port is part of an optional accessory. See section 1.9.4.

The port on the back side of the device is provided for communication with the device in terms of remote control or monitoring. The user has basically two options of access:

1. A website (HTTP, port 80) which is accessible in a standard browser under the IP or the host name given for the device. This website offers to configuration page for network parameters, as well as a input box for SCPI commands.
2. TCP/IP access via a freely selectable port (except 80 and other reserved ports). The standard port for this device is 5025. Via TCP/IP and this port, communication to the device can be established in most of the common programming languages.

Using the Ethernet port, the device can either be controlled by commands from SCPI or ModBus RTU protocol, while automatically detecting the type of message.

The network setup can be done manually or by DHCP. The transmission speed is set to “Auto negotiation” and means it can use 10MBit/s or 100MBit/s. 1GB/s isn't supported. Duplex mode is always full duplex.

If remote control is going to be activated, the Ethernet interface has no priority over any other interface and can therefore only be used alternatively to them. However, monitoring is always available, no matter if and via what interface the device is remotely controlled.

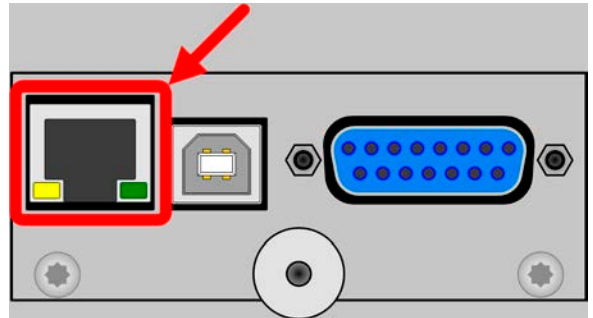

1.9.9 Analog interface

The analog interface is part of an optional accessory. See section 1.9.4.

This 15 pole Sub-D socket on the back side of the device is provided for remote control of the device via analog or digital signals.

The input voltage range of the set values and the output voltage range of the monitor values, as well as reference voltage level can be switched in the settings menu of the device between 0-5 V and 0-10 V, in both cases corresponding to 0-100% of the ratings.

If remote control is going to be activated, the analog interface has no priority over any other interface and can therefore only be used alternatively to them. However, monitoring is always available, no matter if and via what interface the device is remotely controlled.

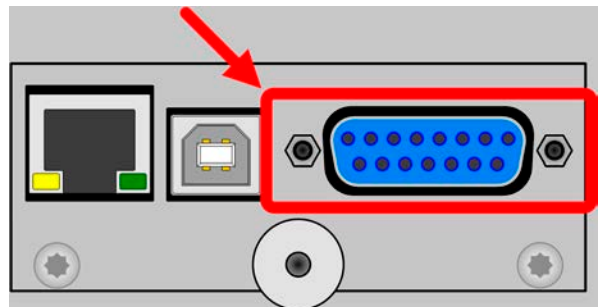

2. Installation & commissioning

2.1 Storage

2.1.1 Packaging

It's recommended to keep the complete transport packaging for the lifetime of the device for relocation or return to Elektro-Automatik for repair. Otherwise the packaging should be disposed of in an environmentally friendly way.

2.1.2 Storage

In case of long term storage of the equipment it's recommended to use the original packaging or similar. Storage must be in dry rooms, if possible in sealed packaging, to avoid corrosion, especially internal, through humidity.

2.2 Unpacking and visual check

After every transport, with or without packaging, or before commissioning, the equipment should be visually inspected for damage and completeness using the delivery note and/or parts list (see section „1.9.3. Scope of delivery“). An obviously damaged device (e.g. loose parts inside, damage outside) must under no circumstances be put in operation.

2.3 Installation

2.3.1 Safety procedures before installation and use



- Before connecting to the mains ensure that the connection is as shown on the product label. Overvoltage on the AC supply can cause equipment damage.
- Before connecting a voltage source to the DC input make sure, that the source can't generate a voltage higher than specified for your particular model or install measures which can prevent damaging the device by overvoltage input.

2.3.2 Preparation

Mains connection with an EL 9000 T series device is done via the included 1.5 meters long 3 pole mains cord.

Dimensioning of the DC wiring to the source has to reflect the following:



- The cable cross section should always be specified for at least the maximum current of the device.
- Continuous operation at the approved limit generates heat which must be removed, as well as voltage loss which depends on cable length and heating. To compensate for these the cable cross section should be increased and/or the cable length reduced.

2.3.3 Installing the device



- Select the location for the device so that the connection to the DC source is as short as possible.
- Leave sufficient space behind the equipment, minimum 30 cm, for ventilation of warm air that will be exhausted
- Never obstruct the air inlets on the sides!
- The digital interface unit on the rear side, either the included USB or the optional IF-KE4, is modular and must always be installed correctly in the device, else it can't work.

2.3.4 Connection to DC sources



- When using the 45 A model, attention has to be paid to where the load is connected to the DC input terminals. The front 4 mm Bueschel plug hole is only rated for **max. 32 A!**
- Connection of voltage sources which can generate a voltage higher than 110% nominal of the device model isn't allowed!
- Connection of voltage sources with reversed polarity isn't allowed!

The DC input is on the front side of the device and is **not** protected by a fuse. The cross section of the connection cable is determined by the current consumption, cable length and ambient temperature.

For cables **up to 5 m** and average ambient temperature up to 50°C, we recommend:

up to **10 A**: 0.75 mm² (AWG18)

up to **20 A**: 4 mm² (AWG10)

up to **45 A**: 10 mm² (AWG8)

per lead (multi-conductor, insulated, openly suspended). Single cables of, for example, 10 mm² may be replaced by e.g. 2x 4 mm² etc. If the cables are long then the cross section must be increased to avoid voltage loss and overheating.

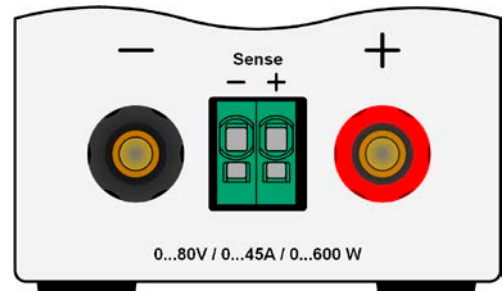

2.3.4.1 Possible connections on the DC input

The DC input on the front is of type clamp & plug and can be used with:

- 4 mm system plugs (Büschel, banana, safety) for **max. 32 A**
- Spade lugs (6 mm or bigger)
- Soldered cable ends (only recommended for small currents up to 10 A)

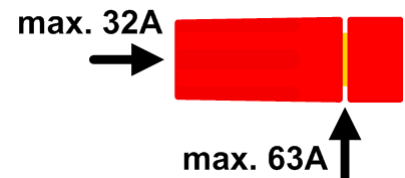

When using any type of lugs or cable end sleeves, only use insulated ones in order to ensure electric shock protection!

2.3.5 Grounding of the DC input

The device can be grounded on the DC minus pole anytime, it means directly connected to PE. The DC plus pole, however, when grounded can only be used for input voltages up to 400 V with the 500 V model, contrary to operation without grounded DC poles, because the potential of the minus pole is shifted into negative direction by the value of the input voltage. Also see technical specification sheets in 1.8.3, item "Insulation".



Do not ground the DC plus pole on the 500 V model or at least make sure the DC input voltage can never exceed 400 V as long as the DC plus pole is grounded.

2.3.6 Connection of remote sensing



- *Remote sensing is only effective during constant voltage operation (CV) and for other regulation modes the sense input should be disconnected, if possible, because connecting it generally increases the oscillation tendency.*
- *The cross section of the sensing cables is noncritical. Recommendation for cables up to 5 m: use at least 0.5 mm².*
- *Sensing cables should be twisted and laid close to the DC cables to damp oscillation. If necessary, an additional capacitor can be installed at the source to eliminate oscillation. Also see section 3.2.5.*
- *Sensing cables must be connected + to + and - to - at the source, otherwise the sense input of the electronic load can be damaged. For an example see Figure 6 below.*

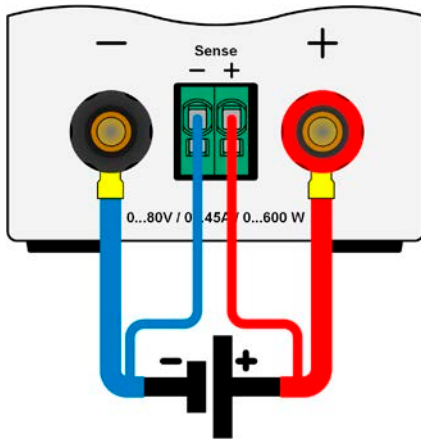

Figure 6 - Example for remote sensing wiring

The connector Sense is a clamp terminal. It means for the remote sensing cables:

- Insert cables: crimp sleeves onto the cable ends and simply push them into the bigger square hole
- Remove cables: use a small flat screwdriver and push into the smaller square hole below the bigger one to loosen the cable clamp, then remove cable end

2.3.7 Connecting the analog interface

The optionally available 15 pole connector (Type: Sub-D, D-Sub) on the rear side is an analog interface. To connect this to a controlling hardware (PC, electronic circuit), a standard plug is necessary (not included in the scope of delivery). It's generally advisable to switch the device completely off before connecting or disconnecting this connector, but at least the DC input.



The analog interface is galvanically isolated from the device internally. Therefore do not connect any ground of the analog interface (AGND) to the DC minus input as this will cancel the galvanic isolation.

2.3.8 Connecting the USB port (rear side)

In order to remotely control the device via this port, connect the device with a PC using the included USB cable and switch the device on.

2.3.8.1 Driver installation (Windows)

On the initial connection with a PC the operating system will identify the device as new hardware and will try to install a driver. The required driver is for a Communication Device Class (CDC) device and is usually integrated in current operating systems such as Windows 7 or 10. But it's strongly recommended to use the included driver installer (on USB stick) to gain maximum compatibility of the device to our softwares.

2.3.8.2 Driver installation (Linux, MacOS)

We can't provide drivers or installation instructions for these operating systems. Whether a suitable driver is available is best found out by searching the Internet. With newer versions of Linux or MacOS, a generic CDC driver should be "on board".

2.3.8.3 Alternative drivers

In case the CDC driver described above isn't available on your system, or for some reason do not function correctly, commercial suppliers can help. Search the Internet for suppliers using the keywords "cdc driver windows" or "cdc driver linux" or "cdc driver macos".

2.3.9 Initial commission

For the first start-up after purchasing and installing the device, the following procedures have to be executed:

- Confirm that the connection cables to be used are of a satisfactory cross section!
- Check if the factory settings of set values, safety and monitoring functions and communication are suitable for your intended application of the device and adjust them if required, as described in the manual!
- In case of remote control via PC, read the additional documentation for interfaces and software!
- In case of remote control via the analog interface, read the section in this manual concerning analog interfaces!

2.3.10 Commission after a firmware update or a long period of non use

In case of a firmware update, return of the equipment following repair or a location or configuration change, similar measures should be taken to those of initial start up. Refer to „2.3.9. *Initial commission*“.

Only after successful checking of the device as listed may it be operated as usual.

3. Operation and application

3.1 Personal safety



- In order to guarantee safety when using the device, it's essential that only persons operate the device who are fully acquainted and trained in the required safety measures to be taken when working with dangerous electrical voltages
- For models which accept dangerous voltages, a protection against unwanted physical contact has to be installed on the DC input
- Whenever the DC input is going to be re-configured, the source must be switched off or better, disconnected!

3.2 Operating modes

An electronic load is internally controlled by different control or regulation circuits, which shall hold voltage, current and power constant on the adjusted limits, if possible. These circuits follow typical laws of control systems engineering, resulting in different operating modes. Every operating mode has its own characteristics which is explained below in short form.

3.2.1 Voltage regulation / Constant voltage

Constant voltage operation (short: CV) or voltage regulation is a subordinate operating mode of electronic loads. In normal operation, a voltage source is connected to electronic load, representing a certain input voltage. If the set value for the voltage in constant voltage operation is higher than the actual voltage of the source, the value cannot be reached. The load will then sink no current from the source. If the voltage set value is lower than the input voltage then the load will attempt to sink enough current from the source to achieve the desired voltage level. If the resulting current reaches the adjusted current limit or the actual power according to $P = U_{IN} * I_{IN}$ reaches the adjusted power limit, the load will automatically switch to constant current or constant power operation. Then the adjusted input voltage can no longer be achieved.

While the DC input is switched on and constant voltage mode is active, then the condition "CV mode active" will be shown on the graphics display by the abbreviation **CV**, as well it will be passed as a signal to the analog interface (depending on the settings) and stored as internal status which can be read via digital interface.

3.2.1.1 Speed of the voltage controller

The internal voltage controller can be switched between **Slow** and **Fast** (see „3.4.3.2. Sub menu "General Settings""). Factory default value is **Slow**. Which setting to select depends on the actual situation in which the device is going to be operated, but primarily it depends of the type of voltage source. An active, regulated source such as a switching mode power supply has its own voltage control circuit which works concurrently to the load's circuit. Both might work against each other and lead to oscillation. Should this occur it's recommended to set the controller speed to **Slow**.

In other situations, e.g. operating the function generator and applying various functions to the load's input voltage and setting of small time increments, it might be necessary to set the voltage controller to **Fast** in order to achieve the expected results.

3.2.1.2 Minimum voltage for maximum current

Due to technical reasons, all models in this series have a minimum internal resistance that makes the unit to be supplied with a minimum input voltage (U_{MIN}) in order to be able to draw the full current (I_{MAX}). This minimum input voltage varies from model to model and is listed in the technical specifications. If less voltage than U_{MIN} is supplied, the load proportionally draws less current, which can be calculated easily.

See principle view to the right.

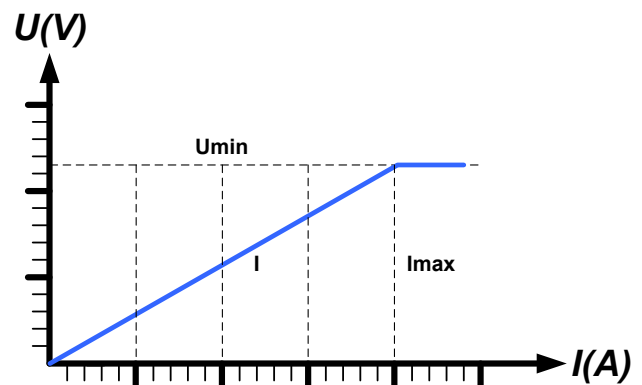

3.2.2 Current regulation / constant current / current limitation

Current regulation is also known as current limitation or constant current mode (short: CC). It's fundamental to the normal operation of an electronic load. The input current is held at a predetermined level, the set value or limit, by varying the internal resistance according to Ohm's law $R = U / I$ such that, based on the input voltage, a constant current flows. Once the current has reached the adjusted value, the device automatically switches to constant current regulation. However, if the power consumption reaches the adjusted power limit or the maximum possible power in derating condition, the device will automatically switch to power limitation and adjust the input current according to $I_{MAX} = P_{SET} / U_{IN}$, even if the maximum current limit is higher.

While the DC input is switched on and constant current mode is active, the condition "CC mode active" will be shown on the graphics display by the abbreviation **CC** and can also be read via digital interface.

3.2.3 Resistance regulation / constant resistance

Inside electronic loads, whose operating principle is based on a variable internal resistance, constant resistance mode (short: CR) is almost a natural characteristic. The load attempts to set the internal resistance to the user defined value by determining the input current depending on the input voltage according to Ohm's law $I_{IN} = U_{IN} / R_{SET}$. The adjustable internal resistance range is naturally limited between a technically based minimum and a specific maximum where the resolution of current regulation starts to become more and more inaccurate.

While the DC input is switched on and constant resistance mode is active, the condition "CR mode active" will be shown on the graphics display by the abbreviation **CR**, as well it will be stored as internal status which can be read via digital interface.

3.2.4 Power regulation / constant power / power limitation

Power regulation, also known as power limitation or constant power (short: CP), keeps the input power of the device at the adjusted limit if the current flowing from the source together with the input voltage reaches the adjusted limit according to $P_{IN} = U_{IN} * I_{IN}$. The power limitation would then limit the input current according to $I_{IN} = P_{SET} / U_{IN}$.

Power limitation operates according to the auto-range principle such that at lower input voltages higher current can flow and vice versa, in order to maintain constant power within the range P_N (see diagram to the right).

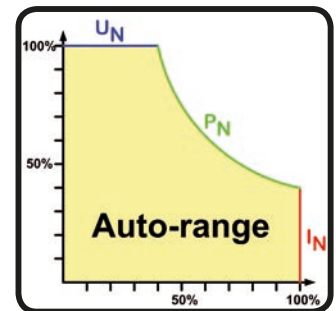

While the DC input is switched on and constant power operation is active, the condition "CP mode active" will be shown on the graphic display by the abbreviation **CP**, as well it will be stored as internal status which can be read via digital interface.

Constant power operation impacts the internal set current value. This means that the maximum set current may not be reachable if the set power value according to $I = P / U$ sets a lower current. The user defined and displayed set current value is always the upper limit only.

3.2.4.1 Temperature dependent derating

This series consists of conventional electronic loads which convert the consumed electrical energy into heat and dissipate it. In order to avoid overheating, the device will automatically reduce, i.e. derate the actual input power when heating up. It means, at a cold start it can take the peak power (see technical specs) for a certain time before it starts reducing.

This derating is depending on the ambient temperature. It means, that at 10°C the load can take the peak power for a much longer time than at 20°C ambient temperature or higher. Disregarding the ambient temperature, the derating will be constant at a certain power per degree Kelvin (x W/K, see technical specifications), down to the steady power which is rated for the typical ambient temperature of 40°C (104°F) and further down.

If the device is supplied with less power than the rated steady power at a certain ambient temperature, the derating won't necessarily impact the operation. However, the internal power reduction is always imminent. For example, if you would run a model with rated 600 W power for a while at 400 W constant actual power, while the power limit's set to 600 W, and your source would make a voltage step or the load a current step, the power limit of 600 W could still not be achieved.

See the diagrams below for clarification.

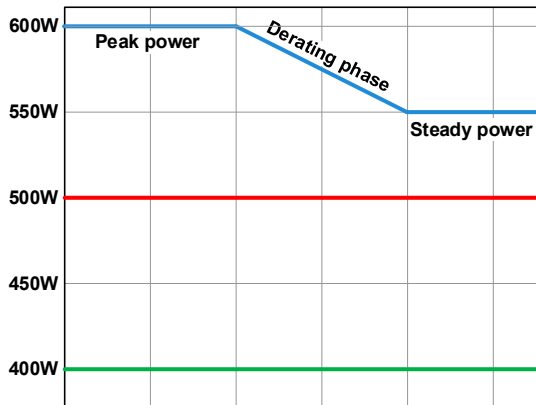

Principle derating progression

The maximum power is absorbed by the load device for a time x, before derating starts. After the start of derating, the available input power of the load will settle around the point as given in the technical for 40°C ambient. The true input power can be read from the device's actual power value (display or via interface). In case the ambient temperature rises, the derating will continue.

blue: 80 V model

red: 200 V model

green: 500 V model

3.2.5 Dynamic characteristics and stability criteria

The electronic load is characterised by short rise and fall times of the current, which are achieved by a high bandwidth of the internal regulation circuit.

In case of testing sources with own regulation circuits at the load, like for example power supplies, a regulation instability may occur. This instability is caused if the complete system (feeding source and electronic load) has too little phase and gain margin at certain frequencies. 180° phase shift at >0 dB amplification fulfils the condition for an oscillation and results in instability. The same can occur when using sources without own regulation circuit (eg. batteries), if the connection cables are highly inductive or inductive-capacitive.

The instability isn't caused by a malfunction of the load, but by the behaviour of the complete system. An improvement of the phase and gain margin can solve this. In practice, a capacity is directly connected to the DC input of the load. The value to achieve the expected result isn't defined and has to be found out. We recommend:

80 V model: 1000 µF...4700 µF

200 V model: 100 µF...470 µF

500 V model: 47 µF...150 µF

3.3 Alarm conditions



This section only gives an overview about device alarms. What to do in case your device indicates an alarm condition is described in section „3.6. Alarms and monitoring“.

As a basic principle, all alarm conditions are signalled optically as text message in the display, plus as a readable status and alarm counter via the digital interface. In addition, the alarms OT and OVP are reported as signals on the analogue interface (optional accessory). For later acquisition, an alarm counter can be read from the display or via digital interface.

3.3.1 Power Fail

Power Fail (PF) indicates an alarm condition which may have various causes:

- AC input voltage too low (mains undervoltage, mains failure)
- Defect in the input circuit (PFC)

As soon as a power fail occurs, the device will stop to sink power and switch off the DC input. In case the power fail was an undervoltage and is gone later on, the alarm will vanish from display and doesn't require to be acknowledged.

The condition of the DC input after a gone PF alarm can be determined in the MENU. See 3.4.3.



Switching off the device with the mains switch can't be distinguished from a mains blackout and thus the device will signalise a PF alarm every time the device is switched off. This can be ignored.

3.3.2 Overtemperature

An overtemperature alarm (OT) can occur if an excess temperature inside the device and causes it to stop sinking power temporarily. This can occur due to a defect of the internal fan regulation or due to excessive ambient temperature. Though the device recovers most of the consumed energy with a high efficiency, it requires cooling.

The condition of the DC input after a gone OT alarm, i. e. the device has cooled down, can be determined in the MENU. See 3.4.3. Depending on the chosen setting, the device would automatically continue to work. The OT alarm doesn't require to be acknowledged.

3.3.3 Overvoltage

An overvoltage alarm (OVP) will switch off the DC input and can occur if:

- the connected voltage source provides a higher voltage to the DC input than set in the overvoltage alarm threshold (OVP, 0...103% U_{NOM})

This function serves to warn the user of the electronic load that the connected voltage source has generated an excessive voltage and thereby could damage or even destroy the DC input circuit and other parts of the device.



The device isn't fitted with protection from external overvoltage.

3.3.4 Overcurrent

An overcurrent alarm (OCP) will switch off the DC input and can occur if:

- The current in the DC input exceeds the adjusted OCP limit.

This function serves to protect the voltage and current source so that this isn't overloaded and possibly damaged, rather than offering protection to the electronic load.

3.3.5 Overpower

An overpower alarm (OPP) will switch off the DC input and can occur if:

- the product of the DC input voltage and DC input current exceeds the adjusted OPP limit.

This function serves to protect the voltage and current source so that this isn't overloaded and possibly damaged, rather than offering protection to the electronic load.

3.4 Manual operation

3.4.1 Powering the device

The device should, as far as possible, always be switched on using the toggle switch on the rear of the device. After switching on, the display will first show the company logo, followed by a language selection which will close automatically after 3 seconds and later manufacturer's name and address, device type, firmware version(s), serial number and item number.

In setup (see section „3.4.3. Configuration via MENU“), in the second level menu **General settings** is an option **Input after power ON** in which the user can determine the condition of the DC input after power-up. Factory setting here is **OFF**, meaning that the DC input will always be switched off on power-up, while **Restore** means that the last condition of the DC input will be restored, either on or off. All set values are also restored.



For the time of the start phase the analog interface (if installed) can signal undefined statuses on the output pins such as ALARMS 1. Those signals must be ignored until the device has finished booting and is ready to work.

3.4.2 Switching the device off

On switch-off, the last input condition and the most recent set values and input status are saved. Furthermore, a PF alarm (power failure) will be reported, but has to be ignored here.

The DC input is immediately switched off and after a short while fans will shut down and after another few seconds the device will be completely powered off.

3.4.3 Configuration via MENU

The MENU serves to configure all operating parameters which are not constantly required. These can be set by finger touch on the MENU touch area, but only if the DC input is switched OFF. See figure to the right.

Menu navigation is by finger touch. Values are set using the rotary knobs. The assignment of the knobs to the adjustable values isn't indicated, but there is an assignment rule: upper or left-hand value -> left-hand knob, lower or right-hand value -> right-hand knob.

Some setting parameters are self-explanatory, others are not. The latter will be explained on the pages following.

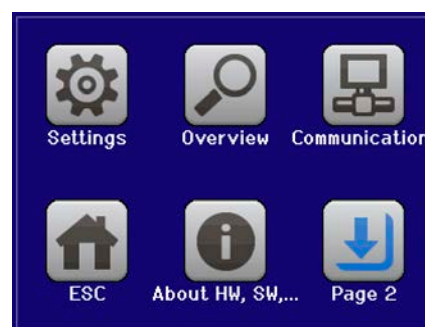
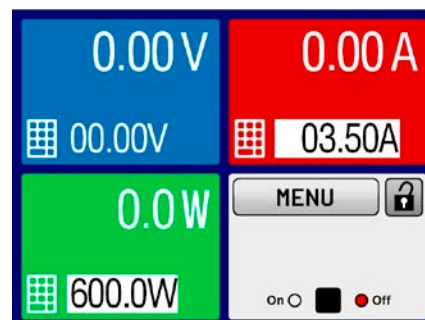

3.4.3.1 Sub menu “Settings”

This is main menu for all settings related to the general operation of the device and of the interface(s).

Sub menu	Description
Input Settings	Allows for adjustment of set values related to the DC input, alternatively to the handling in the main screen of the display
Protection	Allows for adjustment of protection thresholds (here: OVP, OCP, OPP) related to the DC input. Also see section „3.3. Alarm conditions“
Limit Settings	Allows for adjustment of adjustment limits for set values. Also see section „3.4.4. Adjustment limits“
General Settings	Settings for the operation of the device and its interface(s). Details below
Reset device	Touch area Start will initiate a reset of all settings (HMI, profile etc.) to factory defaults.
Calibrate device	Opens a new menu with several options to calibrate DC input related values. Refer to section „4.3. Calibration“ for details.
Event Settings	Allows for adjustment of supervision features related to the DC input. Also see section „3.6.2.1. User defined events“

3.4.3.2 Sub menu “General Settings”

Setting	Description
Allow remote control	Selection No means that the device can't be remotely controlled over either the digital or analog interfaces. If remote control isn't allowed, the status will be shown as Local in the status area on the main display. Also see section 1.9.5.1.
Analog interface range	<i>This parameter is only displayed if the optional analog interface is installed.</i> Selects the voltage range for the analog set value inputs, monitoring outputs and reference voltage output. <ul style="list-style-type: none"> • 0...5 V = Range is 0...100% set /actual values, reference voltage 5 V • 0...10 V = Range is 0...100% set /actual values, reference voltage 10 V See also section „3.5.4. Remote control via the analog interface (AI)“
Analog interface Rem-SB	<i>This parameter is only displayed if the optional analog interface is installed.</i> Selects how the input pin REM-SB of the analog interface shall be working regarding levels and logic: <ul style="list-style-type: none"> • Normal = Levels and function as described in the table in 3.5.4.4 • Inverted = Levels and function will be inverted Also see „3.5.4.7. Application examples“
Analog Rem-SB action	<i>This parameter is only displayed if the optional analog interface is installed.</i> Selects the action on the DC input that is initiated when changing the level of analog input REM-SB: <ul style="list-style-type: none"> • DC OFF = the pin can only be used to switch the DC input off • DC ON/OFF = the pin can be used to switch the DC input off and on again, if it has been switched on before at least from a different control location
Analog interface pin 6	Pin 6 of the analog interface (see section 3.5.4.4) is by default assigned to only signal the device alarms OT and PF. This parameter allows to also enable signalling only one of both (3 possible combinations): <ul style="list-style-type: none"> • OT = Enable/disable signalling of alarm OT on pin 6 • PF = Enable/disable signalling of alarm PF on pin 6
Analog interface pin 14	Pin 14 of the analog interface (see section 3.5.4.4) is by default assigned to only signal the device alarm OVP. This parameter allows to also enable signalling further device alarms (7 possible combinations): <ul style="list-style-type: none"> • OVP = Enable/disable signalling of alarm OVP on pin 14 • OCP = Enable/disable signalling of alarm OCP on pin 14 • OPP = Enable/disable signalling of alarm OPP on pin 14

Setting	Description
Analog interface pin 15	Pin 15 of the analog interface (see section 3.5.4.4) is by default assigned to only signal the regulation mode CV. This parameter allows to enable signalling a different device status (2 options): <ul style="list-style-type: none"> • Regulation mode = Enable/disable signalling of CV reg mode on pin 15 • DC status = Enable/disable signalling of DC input status on pin 15
DC input after OT alarm	Determines how the DC power stages shall react after an overtemperature (OT) alarm has occurred and the power stages have cooled down again: <ul style="list-style-type: none"> • OFF = DC power stage(s) will be off • AUTO = The device will automatically restore the situation before the OT alarm, which usually means the DC power stage to be on
DC input after power ON	Determines the condition of the DC input after power-up. <ul style="list-style-type: none"> • OFF = DC input is always off after switching on the device. • Restore = DC input condition will be restored to the condition prior to switch off.
DC input after PF alarm	Determines how the DC input shall react after a power fail (PF) alarm has occurred: <ul style="list-style-type: none"> • OFF = DC input will be switched off and remain until user action • AUTO = DC input will switch on again after the PF alarm cause is gone and if it was switched on before the alarm occurred
DC input after remote	Determines the condition of the DC input after leaving remote control either manually or by command. <ul style="list-style-type: none"> • OFF = DC input will be always off when switching from remote to manual • AUTO = DC input will keep the last condition
Enable R mode	Activates (Yes) or deactivates (No) the internal resistance control. If activated, the resistance set value can be adjusted on the main screen as additional value. For details refer to „3.2.3. Resistance regulation / constant resistance“.
Voltage controller setting	Selects the regulation speed of the internal voltage regulator between Slow and Fast . See „3.2.1.1. Speed of the voltage controller“.
USB file separator format	Switches the decimal point format of values and also the CSV file separator for USB logging (see 1.9.5.5 and 3.4.9), as well as for other features where a CSV file can be loaded <ul style="list-style-type: none"> • US = Comma separator (US standard for CSV files) • Default = Semicolon separator (german/european standard for CSV files)
USB logging with units (V,A,W)	CSV files generated from USB logging by default add physical units to values. This can be deactivated by setting this option to “No”

3.4.3.3 Menu “Profiles”

See „3.9 Loading and saving a user profile“ on page 46.

3.4.3.4 Menu “Overview”

This menu has several sub menus which all displays overview information about DC input related set values, limits, events and an alarm history which lists the number of device alarms that probably occurred since the device has been powered. Nothing can be changed here.

3.4.3.5 Menu “About HW, SW...”

This menu page displays an overview of device relevant data such as serial number, article number etc.

3.4.3.6 Menu “Function Generator”

See „3.10 The function generator“ on page 48.

3.4.3.7 Menu “Communication”

Apart from settings related to the USB logging feature, all settings for the digital interface(s) on the rear side are configured here. Upon delivery, the device only features an USB port which doesn't require configuration. It can be extended by an Ethernet/LAN port by installing the optional 3-way interface board IF-KE4. After installation or a complete device reset, the Ethernet port has following **default settings** assigned:

- DHCP: off
- IP: 192.168.0.2
- Subnet mask: 255.255.255.0
- Gateway: 192.168.0.1
- Port: 5025
- DNS: 0.0.0.0
- Host name: empty, but configurable via HMI
- Domain: empty, but configurable via HMI

Those settings can be re-configured anytime. Furthermore, there are global communication settings available regarding timing and protocols.

Sub menu “IP Settings 1”

Element	Description
Adr. Source	DHCP: With setting DHCP the device will instantly try to get network parameters (IP, subnet mask, gateway, DNS) assigned from a DHCP server after power-on or when changing from Manual to DHCP and submitting the change with button ENTER. If the DHCP configuration attempt fails, the device will use the settings from Manual . In this case, the overview in screen View settings will indicate the DCHP status as DHCP (failed) , otherwise as DHCP(active) Manual (default setting): uses either the default network parameters (after reset) or the last user setting. Those parameters are not overwritten from selection DHCP and are thus available when switching to Manual again.
IP address	Only available with setting Manual . Default value: 192.168.0.2 Manual setting of the device's IP address in standard IP format (setting will be stored)
Subnet mask	Only available with setting Manual . Default value: 255.255.255.0 Manual setting of the subnet mask in standard IP format (setting will be stored)
Gateway	Only available with setting Manual . Default value: 192.168.0.1 Manual setting of the gateway address in standard IP format (setting will be stored)

Sub menu “IP Settings 2”

Element	Description
DNS address	Default value: 0.0.0.0 Permanent manual setting of the network address of a domain name server (short: DNS) which has to be present in order to translate the host name to the device's IP, so the device could alternatively access by the host name
Port	Default value: 5025 Adjust the socket port here, which belongs to the IP address and serves for TCP/IP access when controlling the device remotely via Ethernet

Sub menu “Logging”

Element	Description
Enable USB logging	Default setting: disabled Enables/disables the “log to USB stick” feature. Once enabled, you can define the Logging interval (multiple steps, 500 ms ... 5 s) and choose between Start/stop with DC ON/OFF or Manual start/stop . With a properly formatted USB stick (also see 1.9.5.5) plugged, logging to USB stick can be used anytime. For more refer to „3.4.9. Recording to USB stick (logging)“.

Sub menu “**Com Timeout**” (communication timeout)

Element	Description
Timeout USB [ms]	Default value: 5 , Range: 5...65535 USB/RS232 communication timeout in milliseconds. Defines the max. time between two subsequent bytes or blocks of a transferred message. For more information about the timeout refer to the external programming documentation “Programming Guide ModBus & SCPI”.
Timeout ETH [s]	Default value: 5 , Range: 0, 5...65535 Defines a timeout after which the device would close the socket connection if there was no command communication between the controlling unit (PC, PLC etc.) and the device for the adjusted time. The timeout is ineffective as long as option TCP Keep-alive is enabled. Setting 0 would deactivate the timeout completely.
Enable interface monitoring	Default setting: disabled Enables/disables the digital interface monitoring feature. See „3.5.3.4. Interface monitoring“
Timeout interface monitoring [s]	Default value: 5 , Range: 1...36000 Defines a timeout for the interface monitoring feature. See above at Enable interface monitoring .

Sub menu “**Com Protocols**” (communication protocols)

Element	Description
SCPI / ModBus	Default setting: both enabled Enables/disables SCPI or ModBus communication protocols for the device. The change is immediately effective after submitting it with ENTER button. Only one of both can be disabled.
ModBus specification compliance	Default setting: Limited Allows to switch from Limited (default setting) to Full which makes the device send messages in ModBus RTU or ModBus TCP format which fully comply to the specification and are compatible to softwares available on the market. With Limited the device would still use the old, partially wrong message format (see programming guide for details).

Sub menu “**TCP Keep-Alive**”

Element	Description
Enable TCP Keep-Alive	Default setting: disabled Enables/disables the “keep-alive” functionality of TCP.

3.4.3.8 Menu “HMI Setup”

These settings refer exclusively to the control panel (HMI).

Element	Description
Language	Selection of the display language between German, English, Russian or Chinese. This selection screen is also shown for 3 seconds during the startup phase of the device.
Backlight	The choice here is whether the backlight remains permanently on or if it should be switched off when no input via screen or rotary knob is made for 60 s. As soon as input is made, the backlight returns automatically. Furthermore the backlight intensity can be adjusted here.
HMI Lock	Configure and to activate the HMI lock. For more information refer to „3.7. Control panel (HMI) lock“.
Status Page	When enabled, this option switches the main screen of the device display to a simpler version with only voltage and current plus status.

3.4.4 Adjustment limits



Adjustment limits are only effective on the related set values, no matter if using manual adjustment or remote control!



The limits settings could be locked by a PIN (see MENU, "Limits lock")

Defaults are, that all set values (U, I, P, R) are adjustable from 0 to 102% of the corresponding rated value.

This may be obstructive in some cases, especially for protection of applications against overcurrent. Therefore upper and lower limits for current (I) and voltage (U) can be set which limit the range of the adjustable set values.

For power (P) and resistance (R) only upper value limits can be set.

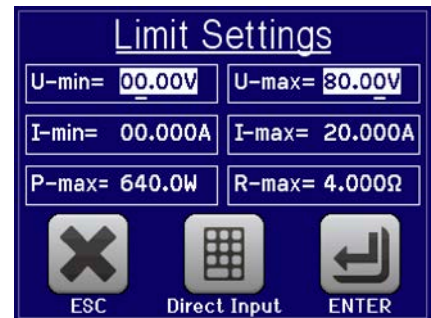

► How to configure the adjustment limits

1. On the main screen, tap **MENU** to access the SETTINGS menu.



2. Tap on **Settings** and then on **Limit Settings** to open the menu page for the adjustment limits.
3. In each case a pair of upper and lower limits for U/I or the upper limit for P/R is assigned to the rotary knobs and can be adjusted. Tap another pair to switch the selection.

4. Accept the settings with **ENTER**.



The values can also be entered directly using the ten-key pad. This appears when tapping touch area "Direct input".



The adjustment limits are coupled to the set values. It means, that the upper limit may not be set lower than the corresponding set value. Example: If you wish to set the upper limit for the current (I-max) to 35 A while the set value of current is adjusted to 40 A, then the set value would first have to be reduced to 35 A or less, in order to enable setting I-max down to 35 A.

3.4.5 Changing the operating mode

In general, the manual operation of an EL 9000 T distinguishes between two operating modes: UIP and UIR.

With mode UIR selected, the resistance set value is adjustable additionally to the one of U and I, while in UIP the power set value replaces the resistance value. The resistance, as adjustable set value, is only available after activation of the resistance mode (short: UIR) in the MENU (also see „3.4.3.2. Sub menu "General Settings"").

► How to switch the operation mode between UIP and UIR

1. Activate the resistance mode in the MENU. After leaving the menu again, the area which was filled green before and showed the set and actual values of power now is filled with an orange-brown and will show set and actual values of resistance.
2. Going back to UIP mode is done vice versa, by deactivating UIR mode in the MENU again. The lower left area is then switched back to green fill and power values are shown again.

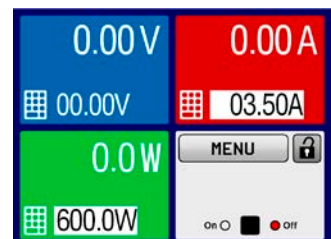

Depending on the selection, a different value (U, P or R) is assigned to the left-hand rotary knob while the right-hand knob is always assigned to the current (I).



Switching to UIR mode does not deactivate the set value of power. It means, the adjusted power value is still in effect. During UIR mode, the power set value can only be accessed and adjusted in the MENU.



3.4.6 Manual adjustment of set values

The set values for voltage, current, power and resistance are the fundamental operating possibilities of an electronic load and hence the two rotary knobs on the front of the device are always assigned to two of the four values in manual operation.

The set values can be entered manually in two ways: via **rotary knob** or **direct input**. While the rotary knobs adjust values continuously, entering them via numeric pad can be used to change values in bigger steps.



Changing a value is immediately submitted, no matter if the DC terminal is switched on or off.



When adjusting the set values, upper or lower limits may come into effect. See section „3.4.4. Adjustment limits“. Once a limit's reached, the display will show a note like "Limit: U-max" etc. for 1.5 seconds next to the adjusted value or will refuse to accept a value entered by direct input.

► How to adjust values with the rotary knobs

1. First check if the value you want to change is already assigned to one of the rotary knobs. The main screen displays the assignment with the two assigned set values being inverted.
2. If, as shown in the example, the assignment is voltage (U, left-hand knob) and current (I, right-hand knob) and you wish to set the power the assignment of the left-hand knob can be changed by tapping the green area for power. This will switch the knob to power adjustment and highlight the power value.



3. After successful selection, the desired value can be set within the defined limits. Selecting a digit's done by pushing the rotary knob which shifts the cursor from right to left (selected digit will be underlined):



► How to adjust values via direct input

1. In the main screen, depending on the rotary knob assignment, values can be set for voltage (U), current (I), power (P) or resistance (R) via direct input by tapping on the small keypad symbol in the set/actual value display areas, e.g. in the uppermost area of voltage.
2. Enter the required value using the ten-key pad. Similar to a pocket calculator the key **c** clears the input.



Decimal values are set by tapping the point key. For example, 54.3 V is set with **5** **4** **.** **3** and **ENTER**.

3. The display reverts to the main page and the set values take effect.

3.4.7 Switching the main screen view

The main screen, also called status page, with its set values, actual values and device status can be switched from the standard view mode with three values to a simpler mode with only voltage and current display. The advantage of the alternative view mode is that actual values are displayed with **bigger numbers**, so they read be read from a larger distance. Refer to „3.4.3.8. Menu "HMI Setup"“ to see where to switch the view mode in the MENU. Comparison:

Standard status page

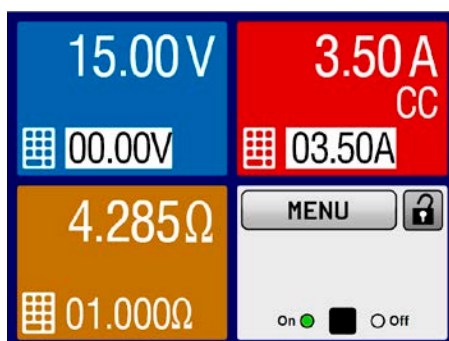

Alternative status page

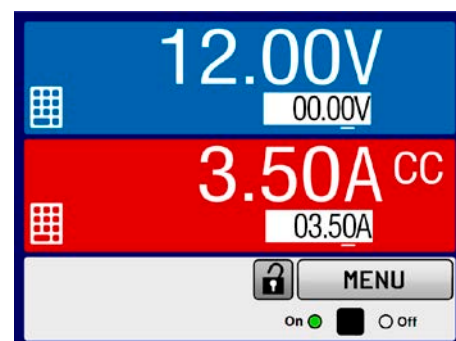

Limitations of the alternative status page:



In alternative status page mode, the set values of power and resistance are not adjustable while the DC input is switched on. They can only be accessed and adjusted in the MENU, in "Settings->Input Settings" while the DC input is off.

Rules for manual handling of the HMI in alternative status page mode:

- The two rotary knobs are assigned to voltage (left knob) and current (right knob) all the time, except for menus
- Set value input is the same as in standard status page mode, with knobs or by direct input
- Regulation modes CP and CR are displayed alternatively to CC at the same position

3.4.8 Switching the DC input on or off

The DC input of the device can be manually or remotely switched on and off. This can be restricted in manual operation by the control panel being locked.



Switching the DC input on during manual operation or digital remote control can be disabled by pin REM-SB of the built-in analog interface. For more information refer to 3.4.3.2 and example a) in 3.5.4.7. In such a situation, the device will show a notification in the display.

► How to manually switch the DC input on or off

1. As long as the control panel (HMI) isn't fully locked press the button ON/OFF. Otherwise you are asked to disable the HMI lock (simple unlock or by entering the PIN, if activated in menu **HMI Lock**).
2. The ON/OFF button toggles between on and off, as long as a change isn't restricted by any alarm or the device being in **Remote**. The DC input condition is displayed as either "On" or "Off", next to LEDs with corresponding colour.

► How to remotely switch the DC input on or off via the analog interface

1. See section „3.5.4 Remote control via the analog interface (AI)“ on page 39.

► How to remotely switch the DC input on or off via the digital interface

1. See the external documentation "Programming Guide ModBus & SCPI" if you are using custom software, or refer to the external documentation of LabView VIs or other documentation provided by EA Elektro-Automatik.

3.4.9 Recording to USB stick (logging)

Device data can be recorded to USB stick (2.0, 3.0, not all vendors supported) anytime. For specifications of the USB stick and the generated log files refer to section „1.9.5.5. USB port (front side)“.



The logging stores files of CSV format on the stick. The layout of the log data is the same as when logging via PC with software EA Power Control. The advantage of USB logging over PC logging is the mobility and that no PC is required. The logging feature just has to be activated and configured in the MENU.

3.4.9.1 Configuration

Also see section 3.4.3.7. After USB logging has been enabled and the parameters **Logging interval** and **Start/Stop** have been set, logging can be started anytime from within the MENU or after leaving it, depends on the selected start/stop mode.

3.4.9.2 Handling (start/stop)

With setting **Start/stop with DC on/off** logging will start each time the DC input of the device is switched on, no matter if manually with the front button “On/Off” or remotely via analog or digital interface. With setting **Manual start/stop** it's different. Logging is then started and stopped only in the MENU, in the logging configuration page.

Soon after logging has been started, the symbol  indicates the ongoing logging action. In case there is an error while logging, such as USB stick full or removed, it will be indicated by another symbol (). After every manual stop or switching the DC input off the logging is stopped and the log file closed.

3.4.9.3 Log file format

Type: text file in european CSV format

Layout:

	A	B	C	D	E	F	G	H	I	J	K	L	M
1	U set	U actual	I set	I actual	P set	P actual	R set	R actual	R mode	Output/Input	Device mode	Error	Time
2	2,00V	11,92V	1,20A	1,20A	7344W	15W	N/A	N/A	OFF	ON	CC	NONE	00:00:00,942
3	2,00V	11,90V	1,20A	1,20A	7344W	15W	N/A	N/A	OFF	ON	CC	NONE	00:00:01,942
4	2,00V	11,89V	1,20A	1,20A	7344W	15W	N/A	N/A	OFF	ON	CC	NONE	00:00:02,942
5	2,00V	11,87V	1,20A	1,20A	7344W	15W	N/A	N/A	OFF	ON	CC	NONE	00:00:03,942

Legend:

U set / I set / P set / R set: Set values

U actual / I actual / P actual / R actual: Actual values

R mode: resistance mode on or off

Output/Input: state of the DC input

Device mode: actual regulation mode (also see „3.2. Operating modes“)

Error: device alarms

Time: elapsed time since logging start

Important to know:

- R set and R actual are only recorded if UIR mode is active (refer to section 3.4.5)
- Unlike the logging on PC, every log start here creates a new log file with a counter in the file name, starting generally with 1, but minding existing files

3.4.9.4 Special notes and limitations

- Max. log file size (due to FAT32 formatting): 4 GB
- Max. number of log files in folder HMI_FILES: 1024
- With setting **Start/stop with DC ON/OFF**, the logging will also stop on alarms or events with action **Alarm**, because they switch off the DC input
- With setting **Manual start/stop** the device will continue to log even on occurring alarms, so this mode can be used to determine the period of temporary alarms like OT or PF

3.5 Remote control

3.5.1 General

Remote control is possible via the built-in USB port (rear side) or the optionally available interfaces Analog and Ethernet (also see sections 1.9.4, 1.9.8 and 1.9.9). Important here is that only the analog or any of the digital interfaces can be in control. It means that if, for example, an attempt were to be made to switch to remote control via the digital interface whilst analog remote control is active (pin REMOTE = LOW) the device would report an error via the digital interface. In the opposite direction, a switch-over via pin REMOTE would be ignored. In both cases, however, status monitoring and reading of values are always possible.

3.5.2 Controls locations

Control locations are those locations from where the device can be controlled. Essentially there are two: at the device itself (manual control) and external (remote control). The following locations are defined:

Displayed location	Description
- (free)	If neither of the other locations is displayed then manual control is active and access from the analog and digital interfaces is allowed. This location isn't explicitly displayed
Remote	Remote control via any interface is active
Local	Remote control is locked, only manual operation is allowed.

Remote control may be allowed or inhibited using the setting **Allow remote control** (see „3.4.3.2. Sub menu *General Settings*“). In inhibited condition, the status **Local** will be displayed in the bottom right area. Activating the lock can be useful if the device is remotely controlled by software or some electronic device, but it's required to make adjustments at the device or deal with emergency, which would not be possible remotely.

Activating condition **Local** causes the following:

- If remote control via the digital interface is active (**Remote:**), then it's immediately terminated and in order to continue remote control once **Local** is no longer active, it has to be reactivated at the PC
- If remote control via the analog interface is active (**Remote: Analog**), then it's temporarily interrupted until remote control is allowed again by deactivating **Local**, because pin REMOTE continues to signal 'remote control = on', unless this has been changed during the **Local** period.

3.5.3 Remote control via a digital interface

3.5.3.1 Selecting an interface

The device only supports the built-in digital interfaces USB and Ethernet (optionally available).

For USB, a standard USB cable is included in the delivery, as well as a driver for Windows on USB stick. The USB interface requires no setup in the MENU.

The Ethernet interface typically requires network setup (manual or DHCP), but can also be used with its default parameters right from the start.

3.5.3.2 General

For the network port installation refer to „1.9.8. Ethernet port“.

The digital interface require little or no setup for operation and can be directly used with their default configuration. All specific settings will be permanently stored, but could also be reset to defaults with the setup menu item **Reset Device**.

Via the digital interface primarily the set values (voltage, current, power, resistance) and device conditions can be set and monitored. Furthermore, various other functions are supported as described in separate programming documentation.

Changing to remote control will retain the last set values for the device until these are changed. Thus a simple voltage control by setting a target value is possible without changing any other values.

3.5.3.3 Programming

Programming details for the interfaces, the communication protocols etc. are to be found in the documentation "Programming Guide ModBus & SCPI" which is supplied on the included USB stick or which is available as download from the EA Elektro-Automatik website.

3.5.3.4 Interface monitoring

Interface monitoring is a configurable functionality introduced in firmwares KE 3.08 and HMI 2.05. Its goal is to monitor (or supervise) the communication line between the device and a superior control unit, such as PC or PLC, and to ensure that the device wouldn't continue working uncontrolled in case the communication line fails. A failing line can mean that it's either physically interrupted (damaged cable, bad contact, cable pulled) or the interface port inside the device hangs.

The monitoring is always only valid for one of the digital interfaces, the one being used for remote control. It thus means that the monitoring can become temporarily inactive when the device leaves remote control. It's furthermore based on a user-definable timeout which would run out if not at least one message is sent to the device within the given time frame. After every message, the timeout would start again and reset with the next message coming. In case it runs out, following reaction of the device is defined:

- Exit remote control
- In case the DC input is switched on, either switch the DC output off or leave it on, as defined by the parameter **DC input after remote** (see 3.4.3.2)

Notes for the operation:

- The monitoring can be deactivated or activated anytime via remote control
- The timeout of the monitoring can be changed anytime via remote control; the new value would only be valid after the current timeout has elapsed
- The interface monitoring doesn't deactivate the Ethernet connection timeout (see 3.4.3.7), so these two timeouts can overlap

3.5.4 Remote control via the analog interface (AI)

3.5.4.1 General

The optionally available, galvanically isolated, 15 pole analog interface (short: AI) is located on the back side of the device after installation and offers the following possibilities:

- Remote control of current, voltage, power and resistance
- Remote status monitoring (CV, DC on/off)
- Remote alarm monitoring (OT, OVP, PF, OPP, OCP)
- Remote monitoring of actual values
- Remote on/off switching of the DC input

Setting the **three** set values of voltage, current and power via the analog interface must always be done concurrently. It means, that for example the voltage can't be given via the AI and current and power set by the rotary knobs, or vice versa. The internal resistance set value can additionally be adjusted.

The OVP set value and other supervision (events) and alarm thresholds can't be set via the AI and therefore must be adapted to the given situation before the AI will be in control. Analog set values can be supplied by an external voltage or generated from the reference voltage on pin 3. As soon as remote control via the analog interface is activated, the display set values will be those provided by the interface.

The AI can be operated in the common voltage ranges 0...5 V and 0...10 V, both representing 0...100% of the nominal value. The selection of the voltage range can be done in the device setup. See section „3.4.3. Configuration via MENU“ for details. The reference voltage sent out from pin 3 (VREF) will be adapted accordingly:

0-5 V: Reference voltage = 5 V, 0...5 V set value (VSEL, CSEL, PSEL, RSEL) correspond to 0...100% of the rated value or $R_{Min}...R_{Max}$, 0...100% of the actual values correspond to 0...5 V at the outputs CMON and VMON.

0-10 V: Reference voltage = 10 V, 0...10 V set value (VSEL, CSEL, PSEL, RSEL) correspond to 0...100% of the rated value or $R_{Min}...R_{Max}$, 0...100% of the actual values correspond to 0...10 V at the outputs CMON and VMON.

All set values are always additionally limited to the corresponding adjustment limits (U-max, I-max etc.), which would clip setting excess values for the DC input. Also see section „3.4.4. Adjustment limits“.

Before you begin, please read these important notes for use of the interface:



After powering the device and during the start phase the AI signals undefined statuses on the output pins. Those must be ignored until it's ready to work.

- Analog remote control of the device must be activated by switching pin REMOTE first. Only exception is pin REM-SB, which can be used independently
- Before the hardware is connected that will control the analog interface, it shall be checked that it can't provide voltage to the pins higher than specified
- Set value inputs, such as VSEL, CSEL, PSEL and RSEL (if R mode is activated), must not be left unconnected (i.e. floating) during analog remote control. In case any of the set values isn't used for adjustment, it can be tied to a defined level or connected to pin VREF (solder bridge or different), so it gives 100%

3.5.4.2 Resolution

The analog interface is internally sampled and processed by a digital microcontroller. This causes a limited resolution of analog steps. The resolution is the same for set values (VSEL etc.) and actual values (VMON/CMON) and is approx. 16384 (14 bits) when working with the 10 V range. In the 5 V range this resolution halves. Due to tolerances, the truly achievable resolution can be slightly lower.

3.5.4.3 Acknowledging device alarms

In case of a device alarm occurring during remote control via analog interface, the DC input will be switched off the same way as in manual control. The device would indicate an alarm (see 3.6.2) in the front display and, if activated, acoustically and also signal most of them on the analog interface. Which alarms actually are signalled can be set up in the device configuration menu (see „3.4.3.2. Sub menu “General Settings”“).

Most device alarms have to be acknowledged (see „3.6.2. Device alarm and event handling“). Acknowledgment is done with pin REM-SB switching the DC input off and on again, which represents a HIGH-LOW-HIGH signal (min. 50ms for LOW), when using the default level setting for this pin.

3.5.4.4 Analog interface specification

Pin	Name	Type*	Description	Default levels	Electrical specification
1	VSEL	AI	Set voltage value	0...10 V or. 0...5 V correspond to 0..100% of U_{Nom}	Accuracy 0-5 V range: < 0.4% ***** Accuracy 0-10 V range: < 0.2% *****
2	CSEL	AI	Set current value	0...10 V or. 0...5 V correspond to 0..100% of I_{Nom}	Input impedance $R_i > 40\text{ k} \dots 100\text{ k}$
3	VREF	AO	Reference voltage	10 V or 5 V	Tolerance < 0.2% at $I_{max} = +5\text{ mA}$ Short-circuit-proof against AGND
4	DGND	POT	Ground for all digital signals		For control and status signals
5	REMOTE	DI	Switching manual / external control	External = LOW, $U_{Low} < 1\text{ V}$ Manual = HIGH, $U_{High} > 4\text{ V}$ Manual, if pin not wired	Voltage range = 0...30 V $I_{Max} = -1\text{ mA}$ bei 5 V U_{LOW} to HIGH typ. = 3 V Rec'd sender: Open collector against DGND
6	ALARMS 1	DO	Overheating alarm Power fail alarm	Alarm= HIGH, $U_{High} > 4\text{ V}$ No alarm= LOW, $U_{Low} < 1\text{ V}$	Quasi open collector with pull-up against V_{cc} ** With 5 V on the pin max. flow +1 mA $I_{Max} = -10\text{ mA}$ at $U_{CE} = 0,3\text{ V}$ $U_{Max} = 30\text{ V}$ Short-circuit-proof against DGND
7	RSEL	AI	Set internal resistance value	0...10 V or. 0...5 V correspond to 0..100% of R_{Max}	Accuracy 0-5 V range: < 0.4% ***** Accuracy 0-10 V range: < 0.2% *****
8	PSEL	AI	Set power value	0...10 V or. 0...5 V correspond to 0..100% of P_{Nom}	Input impedance $R_i > 40\text{ k} \dots 100\text{ k}$
9	VMON	AO	Actual voltage	0...10 V or. 0...5 V correspond to 0..100% of U_{Nom}	Accuracy < 0.2% at $I_{Max} = +2\text{ mA}$ Short-circuit-proof against AGND
10	CMON	AO	Actual current	0...10 V or. 0...5 V correspond to 0..100% of I_{Nom}	
11	AGND	POT	Ground for all analog signals		For -SEL, -MON, VREF signals
12	R-ACTIVE	DI	R mode on / off	Off = LOW, $U_{Low} < 1\text{ V}$ On = HIGH, $U_{High} > 4\text{ V}$ On, if pin not wired	Voltage range = 0...30 V $I_{Max} = -1\text{ mA}$ bei 5 V U_{LOW} to HIGH typ. = 3 V Rec'd sender: Open collector against DGND
13	REM-SB	DI	DC input OFF (DC input ON) (ACK alarms ****)	Off = LOW, $U_{Low} < 1\text{ V}$ On= HIGH, $U_{High} > 4\text{ V}$ On = Open	Voltage range = 0...30 V $I_{Max} = +1\text{ mA}$ at 5 V Rec'd sender: Open collector against DGND
14	ALARMS 2	DO	Overvoltage alarm Overcurrent alarm Overpower alarm	Alarm = HIGH, $U_{High} > 4\text{ V}$ No alarm = LOW, $U_{Low} < 1\text{ V}$	Quasi open collector with pull-up against V_{cc} ** With 5 V on the pin max. flow +1 mA $I_{Max} = -10\text{ mA}$ at $U_{CE} = 0,3\text{ V}$, $U_{Max} = 30\text{ V}$ Short-circuit-proof against DGND
15	STATUS***	DO	Constant voltage regulation active DC input	CV = LOW, $U_{Low} < 1\text{ V}$ No CV = HIGH, $U_{High} > 4\text{ V}$ Off = LOW, $U_{Low} < 1\text{ V}$ On = HIGH, $U_{High} > 4\text{ V}$	

* AI = Analog Input, AO = Analog Output, DI = Digital Input, DO = Digital Output, POT = Potential

** Internal V_{cc} is approx. 10 V

*** Only one of both signals possible, see section 3.4.3.2

**** Only during remote control

***** The error of a set value input adds to the general error of the related value on the DC input of the device

3.5.4.5 Overview of the Sub-D Socket

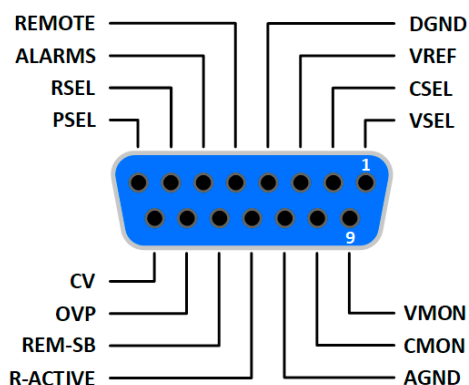

3.5.4.6 Simplified diagram of the pins

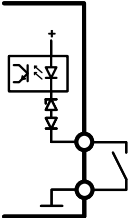
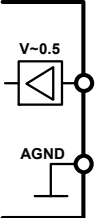
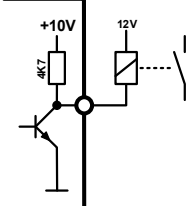
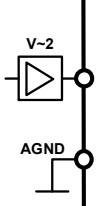
	<p>Digital Input (DI)</p> <p>It requires to use a switch with low resistance (relay, switch, circuit breaker etc.) in order to send a clean signal to the DGND.</p>		<p>Analog Input (AI)</p> <p>High resistance input (impedance >40 kΩ) for an operation amplifier circuit.</p>
	<p>Digital Output (DO)</p> <p>A quasi open collector, realized as high resistance pull-up against the internal supply. In condition LOW it can't drive any load, only sink small current, as shown in the diagram with a relay as example.</p>		<p>Analog Output (AO)</p> <p>Output from an operation amplifier circuit, low impedance. See specifications table above.</p>

3.5.4.7 Application examples

a) Switching off the DC input via the pin REM-SB



A digital output, e.g. from a PLC, may be unable to cleanly effect this as it may not be of low enough resistance. Check the specification of the controlling application. Also see pin diagrams above.

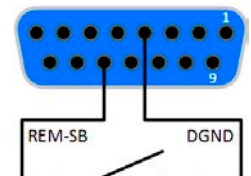

In analog remote control, pin REM-SB is used to switch the DC input of the device on and off. This function is also available without analog remote control being active and can on the one hand block the DC input from being switched on in manual or digital remote control, and on the other hand the pin can switch the DC input on or off, but not standalone. See below at "Remote control has not been activated".

It's recommended that a low resistance contact such as a switch, relay or transistor is used to switch the pin to ground (DGND).

Following situations can occur:

- **Remote control has been activated**

During remote control via analog interface, only pin REM-SB determines the states of the DC input, according to the levels definitions in 3.5.4.4. The logical function and the default levels can be inverted by a parameter in the setup menu of the device. See 3.4.3.2.



If the pin is unconnected or the connected contact is open, the pin will be HIGH. With parameter 'Analog interface Rem-SB' being set to 'Normal', it requests 'DC input on'. So when activating remote control, the DC input would instantly switch on.

- **Remote control has no been activated**

In this mode of operation pin "REM-SB" can serve as lock, preventing the DC input from being switched on by any means. This results in following possible situations:

DC-input	+	Level on pin „REM-SB“	+	Parameter „Analog interface REM-SB“	→	Behaviour
is off	+	HIGH	+	Normal	→	The DC input isn't locked. It can be switched on by pushbutton "On/Off" (front panel) or via command from digital interface.
		LOW	+	Inverted		
	+	HIGH	+	Inverted	→	The DC input is locked. It can't be switched on by pushbutton "On/Off" (front panel) or via command from digital interface. When trying to switch on, a popup in the display resp. an error message will be generated.
		LOW	+	Normal		

In case the DC input is already switched on, toggling the pin will switch the DC input off, similar to what it does in analog remote control:

DC-input	+	Level on pin „REM-SB“	+	Parameter „Analog interface REM-SB“	→	Behaviour
is on	+	HIGH	+	Normal	→	The DC input remains on, nothing is locked. It can be switched on or off by pushbutton or digital command.
		LOW	+	Inverted		
	+	HIGH	+	Inverted	→	The DC input will be switched off and locked. Later it can be switched on again by toggling the pin. During lock, pushbutton or digital command can delete the request to switch on by pin.
		LOW	+	Normal		

b) Remote control of current and power.

Requires remote control to be activated (pin REMOTE = LOW)

The set values PSEL and CSEL are generated from, for example, the reference voltage VREF, using potentiometers for each. Hence the electronic load can selectively work in current limiting or power limiting mode. According to the specification of max. 5 mA load for the VREF output, potentiometers of at least 10 kΩ must be used.

The voltage set value VSEL is directly connected to AGND (ground) and therefore has no influence on constant current or power operation.

If the control voltage is fed in from an external source it's necessary to consider the input voltage ranges for set values (0...5 V or 0...10 V).

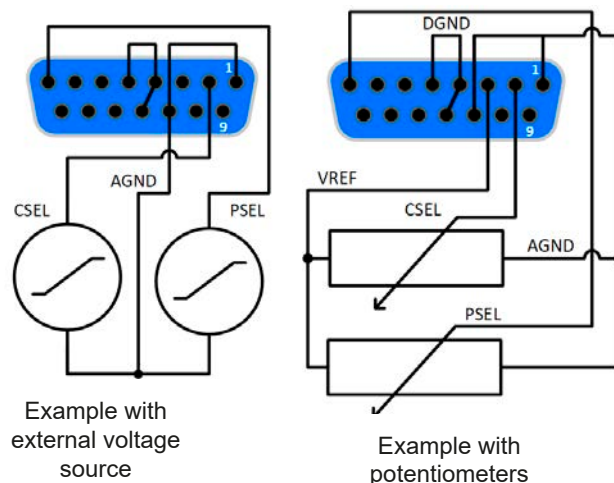

Use of the input voltage range 0...5 V for 0...100% set value halves the effective resolution.

c) Reading actual values

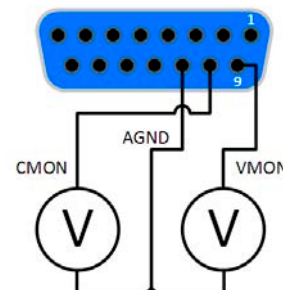

The AI provides the DC input values as current and voltage monitor. These can be read using a standard multimeter or similar.



3.6 Alarms and monitoring

3.6.1 Definition of terms

There is a clear distinction between equipment alarms (see „3.3. Alarm conditions“) such as overvoltage or overheating, and user defined events such as e.g **OVD** overvoltage monitoring. Whilst device alarms primarily serve to protect the source by switching off the DC input, user defined events can also switch off the DC input (**Action = ALARM**), but can also simply make the user aware by a pop-up in the display. The actions driven by user defined events can be selected:

Action	Impact	Example
NONE	User defined event is disabled.	
SIGNAL	On reaching the condition which triggers the event, the action SIGNAL will show a text message in the status area of the display.	
WARNING	On reaching the condition which triggers the event, the action WARNING will show a text message in the status area of the display and pop up an additional warning message, and additionally emit an acoustic signal (if activated).	
ALARM	On reaching the condition which triggers the event, the action ALARM will show a text message in the status area of the display with an additional alarm pop-up. Furthermore the DC input is switched off. Certain device alarms are also signalled to the analog interface or can be queried via the digital interface.	

3.6.2 Device alarm and event handling

Important to know:



- The current drained from a switching power supply or similar sources can be much higher than expected due to capacities on the source's output, even if the source is current limited, and might thus trigger the overcurrent shutdown OCP or the overcurrent event OCD of the electronic load, in case these supervision thresholds are adjusted to too sensitive levels
- When switching off the DC input of the electronic load while a current limited source still supplies energy, the output voltage of the source will rise immediately and due to response and settling times in effect, the output voltage can have an overshoot of unknown level which might trigger the overvoltage shutdown OVP or overvoltage supervision event OVD, in case these thresholds are adjusted to too sensitive levels

A device alarm incident will usually lead to DC input switch-off, the appearance of a pop-up in the middle of the display to make the user aware. The alarm must always be acknowledged. If the alarm condition no longer exists, e.g. the device has cooled down following overheating, the alarm indication will disappear. If the condition persists, the display remains and, following elimination of the cause, must be acknowledged again.

► How to acknowledge an alarm in the display (during manual control)

1. If the alarm is indicated as a pop-up, tap **OK**.
2. If the alarm has already been acknowledged, but is still displayed in the status area, then first tap the status area to make the alert pop up again and then acknowledge with **OK**.



In order to acknowledge an alarm during analog remote control, see „3.5.4.3. Acknowledging device alarms“. To acknowledge in digital remotecontrol, refer to the external documentation “Programming Guide ModBus & SCPI”.

Some device alarms are configurable:

Alarm	Meaning	Description	Range	Indication
OVP	OverVoltage Protection	Triggers an alarm as soon as the DC input voltage reaches the defined threshold. The DC input will be switched off..	0 V...1.03*U _{Nom}	Display, analog & digital interface
OCP	OverCurrent Protection	Triggers an alarm as soon as the DC input current reaches the defined threshold. The DC input will be switched off..	0 A...1.1*I _{Nom}	
OPP	OverPower Protection	Triggers an alarm as soon as the DC input power reaches the defined threshold, The DC input will be switched off..	0 W...1.1*P _{Nom}	

These device alarms can't be configured and are based on hardware:

Alarm	Meaning	Description	Indication
PF	Power Fail	AC supply over- or undervoltage. Triggers an alarm if the AC supply is out of specification or when the device is cut from supply, for example when switching it off with the power switch. The DC input will be switched off. The condition of the DC input, after the cause of the PF alarm has been removed, can be determined by the setting DC input after PF alarm .	Display, analog & digital interface
OT	OverTemperature	Triggers an alarm if the internal temperature exceeds a certain limit. The DC input will be switched off. The condition of the DC input after cooling down can be determined by the setting DC input after OT alarm .	

► How to configure the device alarms

1. While the DC input is switched off, tap the touch area  on the main screen.
2. In the menu tap on **Settings** and then on **Protection Settings**.
3. Set the thresholds for the device alarms relevant to your application if the default value of 103% (OVP) resp. 110% (OCP, OPP) is unsuitable.



The set values can also be entered using a numeric pad, which appears when tapping the numpad symbol on this screen.

3.6.2.1 User defined events

The monitoring functions of the device can be configured for user defined events. By default, events are deactivated (**Action = NONE**). Contrary to device alarms, the events only work while the DC input is switched on. It means, for instance, that you can't detect undervoltage (UVD) anymore after switching the DC input off and the voltage is still sinking.



The following events can be configured independently and can, in each case, trigger the actions **NONE**, **SIGNAL**, **WARNING** or **ALARM**.

Event	Meaning	Description	Range
UVD	UnderVoltage Detection	Triggers an event if the input voltage falls below the defined threshold.	0 V...U _{Nom}
OVD	OverVoltage Detection	Triggers an event if the input voltage exceeds the defined threshold.	0 V...U _{Nom}
UCD	UnderCurrent Detection	Triggers an event if the input current falls below the defined threshold.	0 A...I _{Nom}
OCD	OverCurrent Detection	Triggers an event if the input current exceeds the defined threshold.	0 A...I _{Nom}
OPD	OverPower Detection	Triggers an event if the input power exceeds the defined threshold.	0 W...P _{Nom}



These events should not be confused with alarms such as OT and OVP which are for device protection. User defined events can, however, if set to action ALARM, switch off the DC input and thus protect the source (power supply, battery)

► How to configure user defined events

1. While the DC input is switched off, tap the touch area  on the main screen.
2. In the menu tap on **Settings**, then on **Page 2** and there on **Event Settings**.
3. Switch between parameters for voltage, current and power monitoring with the touch areas **Event U**, **Event I** and **Event P** on the right side.
4. Set the monitoring limits with the left hand rotary knob and the triggered action with the right hand knob relevant to the application (also see „3.6.1. Definition of terms“). Switching between the upper and lower values is done by tapping the stroked area.
5. Accept the settings with .



User events are an integral part of the actual user profile. Thus, if another user profile or the default profile is selected and used the events could either be differently configured or not at all.



The set values can be entered using the ten-key tab. This will appear by tapping the touch area “Direct input”.

3.7 Control panel (HMI) lock

In order to avoid the accidental alteration of a value during manual operation, the rotary knobs or the touchscreen can be locked so that no alteration of values will be accepted without prior unlocking.

► How to lock the HMI

1. In the main page, tap the lock symbol .
2. In the settings page **HMI Lock Setup** you are then asked to chose between a complete HMI lock (check mark set for **Lock HMI**) or a partial lock where the On/Off button on the front of the device is still usable (check mark also set for **On/Off**). You may also chose to activate the additional PIN (**Enable PIN**). The device would later request to enter this PIN every time you want to unlock the HMI, until the PIN is deactivated again.



Be careful with the “Enable PIN” option if you are unsure what PIN is currently set. If you are unsure, use “Change PIN” to define a new one.

3. Activate the lock with . The status **Locked** as shown in the figure to the right.

If an attempt is made to alter something whilst the HMI is locked, a requester appears in the display asking if the lock should be disabled.

► How to unlock the HMI

1. Tap any part of the touchscreen of the locked HMI, or turn one of the rotary knobs or press the button “On/Off” (only in complete lock mode).
2. This request pop-up will appear: .
3. Unlock the HMI by tapping on **Tap to unlock** within 5 seconds, otherwise the pop-up will disappear and the HMI remains locked. In case the additional **PIN code** lock has been activated in the **HMI Lock Setup**, another requester will pop up, asking you to enter the **PIN** before it finally unlocks the HMI.

3.8 Limits lock

In order to avoid the alteration of the adjustment limits (also see „3.4.4. Adjustment limits“) by an unprivileged user, the screen with the adjustment limit settings (“Limits”) can be locked by a PIN code. The menu pages **Limit Settings** and **Profiles** will then become inaccessible until the lock is removed. Tapping a locked menu page. i.e. touch area is greyed out, will give the option to unlock the access by entering the PIN.

► How to lock the limits settings

1. While the DC input is switched off, tap the touch area  on the main screen.
2. In the menu tap **Settings**, then on **Page 2**, then on **HMI Settings** and there on **HMI Lock**.
3. In the settings page set the check mark for “**Lock limits**” and also “**Enable PIN**”.





Enabling the PIN for the limits lock is recommended. The PIN is also used for the HMI lock.

4. Activate the lock by leaving the settings page with .



Be careful with the “Enable PIN” option if you are unsure what PIN is currently set. If you are unsure, use “Change PIN” to define a new one.

► How to unlock the limits settings

1. While the DC input is switched off, tap the touch area  on the main screen.
2. In the menu tap **Settings**, then on **Page 2**, then on **HMI Settings** and there on **HMI Lock**.
3. In the settings page **HMI Lock Setup** unset the check mark for **Lock Limits**. In the following pop-up tap on **Unlock** and then you will be asked to enter the 4-digit PIN.
4. Deactivate the lock by submitting the correct PIN with .

3.9 Loading and saving a user profile

The menu **Profiles** serves to select between a default profile and up to 5 user profiles. A profile is a collection of all settings and set values. Upon delivery, or after a reset, all 6 profiles have the same settings and all set values are 0. If the user changes settings or sets target values then these create a working profile which can be saved to one of the 5 user profiles. These profiles or the default one can then be switched. The default profile is read-only.

The purpose of a profile is to load a set of set values, settings limits and monitoring thresholds quickly without having to readjust these. As all HMI settings are saved in the profile, including language, a profile change can also be accompanied by a change in HMI language.

On calling up the menu page and selecting a profile the most important settings can be seen, but not changed.

► How to save the current values and settings (working profile) as a user profile

1. While the DC input is switched off, tap the touch area  on the main screen
2. In the menu page, tap on **Page 2** and then on **Profiles**.
3. In the selection screen (see image to the right) choose between user profiles 1-5 in which the settings are to be saved. The profile will then be displayed and the values can be checked, but not changed.
4. Tap on touch area **SAVE/LOAD** and in the next screen save the user profile with touch area **SAVE**.

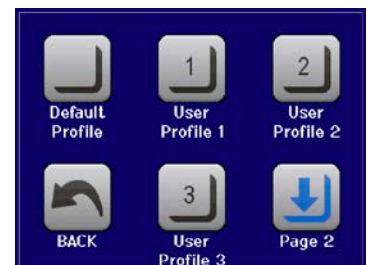

► **How to load a user profile to work with**

1. While the DC input is switched off, tap the touch area  on the main screen
2. In the menu page, tap on **Page 2** and then on **Profiles**.
3. In the selection screen (see image to the right) choose between user profiles 1-5 in which the settings are to be saved. The profile will then be displayed and the values can be checked, but not changed.
4. Tap on touch area **SAVE/LOAD** and in the next screen load the user profile with touch area **LOAD**.

User profiles can also be loaded from and saved to a properly formatted USB stick (see section 1.9.5.5 for details).

► **How to load a user profile from USB stick or save to**

1. While the DC input is switched off, tap the touch area  on the main screen
2. In the menu page, tap on **Page 2** and then on **Profiles**.
3. In the selection screen (see image to the right) choose between user profiles 1-5 in which the settings are to be saved. The profile will then be displayed and the values can be checked, but not changed.
4. Tap on touch area **Import/Export** and in the next screen either save the profile to USB stick by tapping on **Save to USB** or load it from the stick with **Load from USB**.



- *When loading a profile from USB stick it will overwrite all previously stored values of the selected user profile*
- *The number in the profile file name is not related to the user profile number from which it once was saved or to which is it going to be loaded*
- *The selector for picking a profile file to load can only list the first 10 files in the folder*
- *Profile files are checked for validity upon load to determine if the stored values match the device (a profile from an 80 V, 45 A model can't be loaded for a 200 V, 10A)*

After a profile has been loaded from USB stick it doesn't become effective automatically. Like when switching between profiles, it requires to load the user profile into the working profile. See above for the steps.

3.10 The function generator

3.10.1 Introduction

The built-in **function generator** (short: **FG**) is able to create various signal forms and apply these to the set value of voltage or current.

All standard functions are based on the also available arbitrary generator. During manual control, the standard functions such as sine wave can be selected and uses separately. In remote control, they are represented by several sequence points and configured with 8 parameters each. Some of the values on display are not directly available to be read via the digital interfaces, but can be obtained by reading other values and do corresponding calculation.

The following functions are retrievable, configurable and controllable:

Function	Short description
Sine wave	Sine wave generation with adjustable amplitude, offset and frequency
Triangle	Triangular wave signal generation with adjustable amplitude, offset, gain and decay times
Rectangular	Rectangular wave signal generation with adjustable amplitude, offset and duty cycle
Trapezoid	Trapezoidal wave signal generation with adjustable amplitude, offset, rise time, pulse time, fall time, idle time
Ramp	Generation of a linear rise or fall ramp with start and end values and time before and after the ramp
Arbitrary	Generation of a process with up to 99 freely configurable curve points, each with a start and end value (AC/DC), start and end frequency, phase angle and duration
Battery test	Battery discharge test with constant or pulsed current, along with Ah, Wh and time counters
MPP Tracking	Simulates the tracking characteristics of a solar inverter when finding the MPP

3.10.2 General

3.10.2.1 Limitations

The function generator isn't accessible, neither for manual access nor for remote control, if resistance mode (R/I adjustment mode, also called UIR mode) is active.

3.10.2.2 Effective resolution

Depending on D/A and A/D converters and their resolution of 14 bits, the device can achieve an effective resolution of 16384 steps on the full scale of all voltage or current related values on the DC input.

3.10.2.3 Minimum slope / maximum ramp time

When using a rising or falling offset (i.e. DC part) at functions like ramp, trapezoid, triangle and even sine wave, a minimum slope, calculated from the rated values of voltage or current, is required or else the adjusted settings would be neglected by the device. Calculating the minimum slope can help to determine if a certain ramp over time can be achieved by the device or not. Example: model EL 9080-45 T is going to be used, with 80 V and 45 A rating. **Formula: minimum slope = 0.000725 * rated value / s.** For the example model it results in $\Delta U/\Delta t$ of 58 mV/s and $\Delta I/\Delta t$ of 32 mA/s. The maximum time which can be achieved with the minimum slope then calculates as approximately 1379 seconds according to formula $t_{\text{Max}} = \text{rated value} / \text{min. slope}$.

3.10.3 Method of operation

In order to understand how the function generator works and how the value settings interact, the following should be noted:

The device operates always with the three set values U, I and P, also in function generator mode.

The selected function can be used on one of the values U or I, the other two are then constants and have a limiting effect, but are not set automatically to optimal value by the device.

That means, if, e.g. a voltage of 10 V is applied to the DC input and a sine wave function should operate on the current with an amplitude of 20 A and offset 20 A, then the function generator will create a sine wave progression of current between 0 A (min) and 40 A (max), which will result in an input power between 0 W (min) and 400 W (max). The input power, however, is limited to its set value. If this were, for instance, 300 W then the current would be limited to 30 A and if clamped to an oscilloscope it would look like truncated at 30 A and never reach the target of 40 A.

3.10.4 Manual operation

3.10.4.1 Function selection and control

All the functions listed in 3.10.1 can be called on the touch screen, configured and controlled. Selection and configuration are only possible while the DC input is switched off.

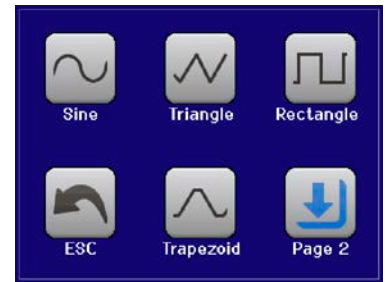

► How to select a function and adjust parameters

1. While the DC input is switched off, tap the touch area **MENU** on the main screen.
2. In the menu tap on **Page 2**, then **Function Generator** and there on the desired function.
3. Then you are requested to select to what physical value the function is going to be applied, **U** or **I**.
4. Adjust the parameters as you desire, like offset, amplitude and frequency for a sine wave, for example.



With all functions and also the arbitrary generator, if there is a difference between start and end value of the curve and that difference is too low (min. $\Delta Y/\Delta t$), also depending on the time that is defined for one function run, the function generator will not accept the settings and pop up an error.

5. Do not forget to adjust the overall limits of voltage, current and power, which you can access with touch area **NEXT**.



When entering function generator mode, those global limits are reset to safe values, which might prevent the function from working at all. For example, if you apply the selected function to the input current, then the overall current limit should not interfere and should at least be as high as offset + amplitude.

Setting the various functions is described below. After setting it up, the function can be loaded.

► How to load a function

1. After setting the values for the required signal generation, tap on the touch area **LOAD**.

The device will then load the data into the internal controller and change the display. Shortly afterwards the static values are set (power and voltage or current), the DC input is switched on and the touch area **START** enabled. Only then can the function be started.

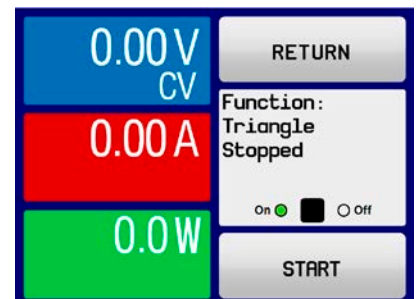

Because the DC input is automatically switched on in order to settle the start situation, the static values are effective to the source immediately after loading the function. These static values represent the situation before start and after the end of the function, so it doesn't need to start from 0. Only exception: when applying any function to the current (I), there is no adjustable static current value, so the function would always start from 0 A.

► How to start and stop a function

1. The function can be started either by tapping **START** or pushing the “On/Off” button, if the DC input is currently switched off. The function then starts immediately. In case **START** is used while the DC input is still switched off, the DC input will be switched on automatically.
2. The function can be stopped either by tapping **STOP** or pushing the “On/Off” button. However, there is a difference:
 - a) The **STOP** are only stops the function, the DC input remains ON with the static values in effect.
 - b) The “On/Off” button stops the function and switches the DC input off.



Every device alarm (overvoltage, overtemperature etc.), protection (OPP, OCP) or event with action = Alarm stops the function progress automatically, switches off the DC input and reports the alarm.

3.10.5 Sine wave function

The following parameters can be configured for a sine function:

Value	Range	Description
Ampl.	0...(Nominal value - Offset) of U, I	Amplitude of the signal to be generated
Offset	Ampl...(Nominal value - Ampl.) of U, I	Offset of the zero point of the mathematical sine curve against 0, may not be smaller than the amplitude.
Freq.	1...10000 Hz	Static frequency of the signal to be generated

Schematic diagram:

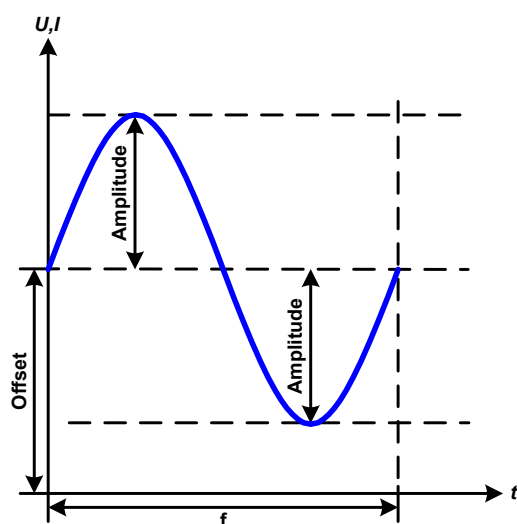

Application and result:

A normal sine wave signal is generated and applied to the selected set value, e.g. current (I). At a constant input voltage the current input of the load will follow a sine wave.

For calculating the maximum power input the amplitude and offset values for the current must be added.

Example: with an input voltage of 15 V and sin(I) selected, set the amplitude to 8 A and the offset to 12 A. The resulting maximum input power is then achieved at the highest point of the sine wave and is $(12\text{ A} + 8\text{ A}) \cdot 15\text{ V} = 300\text{ W}$.

3.10.6 Triangular function

The following parameters can be configured for a triangular wave function:

Value	Range	Description
Ampl.	0...(Nominal value - Offset) of U, I	Amplitude of the signal to be generated
Offset	Ampl...(Nominal value - Ampl.) of U, I	Offset of the foot of the triangular wave against 0
t1	0.01 ms...36000 s	Time for the positive slope of the triangular wave signal.
t2	0.01 ms...36000 s	Time for the negative slope of the triangular wave signal



When adjusting very short time value for t1 and t2 not every adjustable amplitude can be gained on the DC input. Rule of thumb: the smaller the time value, the lower the true amplitude.

Schematic diagram:

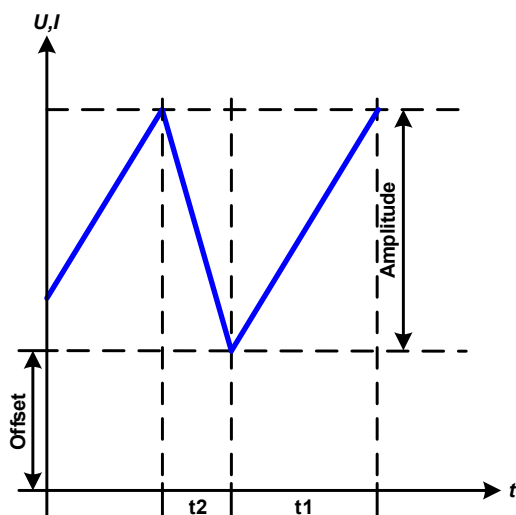

Application and result:

A triangular wave signal for input current or input voltage is generated. The positive and negative slope times are variable and can be set independently.

The offset shifts the signal on the Y-axis.

The sum of the intervals t_1 and t_2 gives the cycle time and its reciprocal is the frequency.

Example: a frequency of 10 Hz is required and would lead to periodic duration of 100 ms. This 100 ms can be freely allocated to t_1 and t_2 , e.g. 50 ms:50 ms (isosceles triangle) or 99.9 ms:0.1 ms (right-angled triangle or sawtooth).

3.10.7 Rectangular function

The following parameters can be configured for a rectangular wave function:

Value	Range	Description
Ampl.	0...(Nominal value - Offset) of U, I	Amplitude of the signal to be generated
Offset	Ampl...(Nominal value - Ampl.) of U, I	Offset of the foot of the rectangular wave against 0
t_1	0.01 ms...36000 s	Time (pulse width) of the upper level (amplitude)
t_2	0.01 ms...36000 s	Time (pause width) of the lower level (offset)



When adjusting very short time value for t_1 and t_2 not every adjustable amplitude can be gained on the DC input. Rule of thumb: the smaller the time value, the lower the true amplitude.

Schematic diagram:

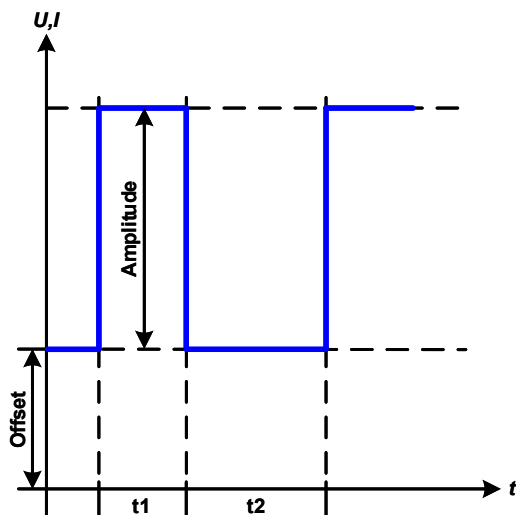

Application and result:

A rectangular or square wave signal for input current or input voltage is generated. The intervals t_1 and t_2 define how long the value of the amplitude (pulse) and how long the value of the offset (pause) are effective.

The offset shifts the signal on the Y axis.

Intervals t_1 and t_2 can be used to define a duty cycle. The sum of t_1 and t_2 gives the period and its reciprocal is the frequency.

Example: a rectangular wave signal of 25 Hz and a duty cycle of 80% are required. The sum of t_1 and t_2 , the period, is $1/25 \text{ Hz} = 40 \text{ ms}$. For a duty cycle of 80% the pulse time (t_1) is $40 \text{ ms} \cdot 0.8 = 32 \text{ ms}$ and the pause time (t_2) is 8 ms

3.10.8 Trapezoidal function

The following parameters can be configured for a trapezoidal curve function:

Value	Range	Description
Ampl.	0...(Nominal value - Offset) of U, I	Amplitude of the signal to be generated
Offset	Ampl...(Nominal value - Ampl.) of U, I	Offset of the foot of the trapezoidal wave against 0
t1	0.01 ms...36000 s	Time for the negative slope of the trapezoidal wave signal
t2	0.01 ms...36000 s	Time for the top value of the trapezoidal wave signal
t3	0.01 ms...36000 s	Time for the negative slope of the trapezoidal wave signal
t4	0.01 ms...36000 s	Time for the base value (offset) of the trapezoidal wave signal

Schematic diagram:

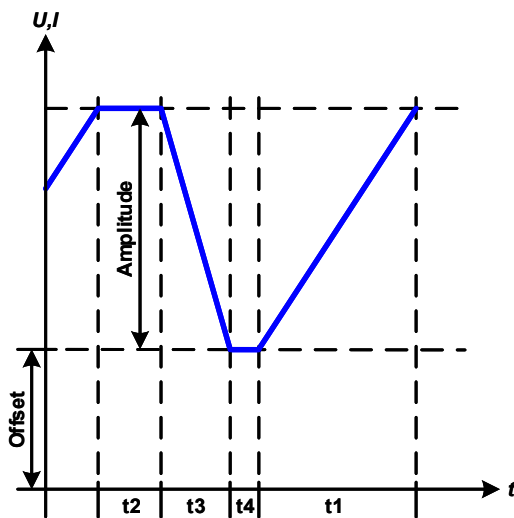

Application and result:

Here a trapezoidal signal can be applied to a set value of U or I. The slopes of the trapezium can be varied by setting different times for gain and decay.

The periodic duration and repeat frequency are the result of four time elements. With suitable settings the trapezium can be deformed to a triangular or rectangular wave. It has, therefore, universal use.

When adjusting very short time values for t1 not every adjustable amplitude can be gained on the DC input. Rule of thumb: the smaller the time value, the lower the true amplitude.

3.10.9 Ramp function

The following parameters can be configured for a ramp function.

Value	Range	Description
Start	0...Nominal value of U, I	Start value (U,I)
End	0...Nominal value of U, I	End value (U, I)
t1	0.01 ms...36000 s	Time before ramp-up or ramp-down of the signal.
t2	0.01 ms...36000 s	Ramp-up or ramp-down time

Schematic diagram:

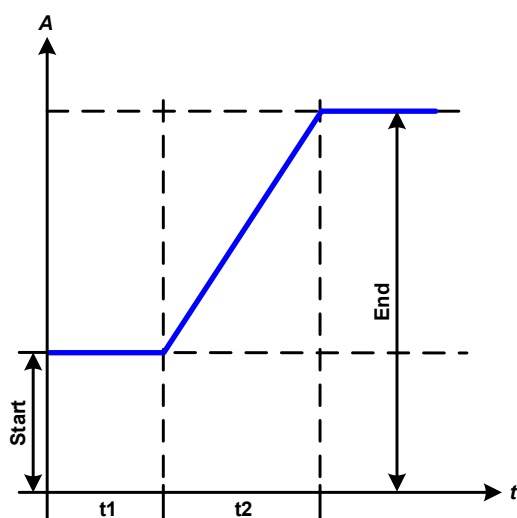

Application and result:

This function generates a rising or falling ramp between start and end values over the time **t2**. Time **t1** creates a delay before the ramp starts.

The function runs once and stops at the end value. To have a repeating ramp, function Trapezoid would have to be used instead (see 3.10.8).

Important to consider are the static values of U and I which define the start levels at the beginning of the ramp. It's recommended that these values are set equal to the one in set for **Start**, unless the power source shall not be loaded before the start of the ramp. In that case the static values should be set to zero.

10h after reaching the ramp end, the function will stop automatically (i.e. I = 0 A resp. U = 0 V), unless it has been stopped manually before.

3.10.10 Arbitrary function

The arbitrary (freely definable) function or function generator offers the user a wider scope of options. There are 99 curve segments (here: sequence points) available for use on either current (I) or voltage (U), all of which have the same set of parameters but can be differently configured, so that a complex function curve can be “constructed”. An arbitrary number out of the 99 sequence points can run in a sequence point block and this block can then be repeated up to 999 times or infinitely. Since the function must be assigned to either current or voltage, mix assignments of sequence point to both is not possible.

The arbitrary curve can overlay a linear progression (DC) with a sine curve (AC) whose amplitude and frequency is shaped between start and end. When both, start frequency and end frequency, are 0 Hz the AC overlay has no impact and only the DC part is effective. Each sequence point is allocated a sequence point time in which the AC/DC curve from start to end will be generated.

The following parameters can be configured for each sequence point in the arbitrary function:

Value	Range	Description
ACs	0...50% nominal value of U, I	Start amplitude of the sine wave part of the curve (AC)
ACe	0...50% nominal value U, I	End amplitude of the sine wave part of the curve (AC)
DCs	ACs...(Nominal value - ACs) of U, I	Start value of the DC part of the curve
DCe	ACe...(Nominal value - ACe) of U, I	End value of the DC part of the curve
S.Freq	0 Hz...10000 Hz	Start frequency of the sine wave part of the curve (AC)
E.Freq	0 Hz...10000 Hz	End frequency of the sine wave part of the curve (AC)
Angle	0 °...359 °	Start angle of the sine wave part of the curve (AC)
Time	0.01 ms...36000 s	Sequence point time



The sequence point time (here: Time) and the start and end frequency are related. The minimum value for $\Delta f/s$ is 9.3. Thus, for example, a setting of S.Freq = 1 Hz, E.Freq = 11 Hz and Time = 5 s would not be accepted as $\Delta f/s$ is only 2. A sequence point time of 1 s would be accepted or, if the time remains at 5 s, then E.Freq = 51 Hz or higher must be set.



The amplitude change between start and end is related to the sequence time. A minimal change over an extended time is not possible and in such a case the device will report an inapplicable setting.

After the settings for the selected sequence are accepted with **SAVE**, further sequence points can be configured. If the button **NEXT** is touched a second settings screen appears in which global settings for all 99 sequences are displayed. The following parameters can be set for the total run of an arbitrary function:

Value	Range	Description
Start seq.	1...End seq.	First sequence in the sequence point block
End seq.	Start seq...99	Last sequence in the sequence point block
Seq. Cycles	∞ or 1...999	Number of cycles of the sequence point block

After continuing with  there are global set values to define as last part of the function generator setup.

Schematic diagram:

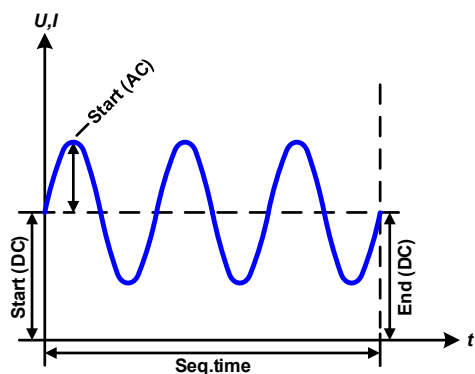

Applications and results:

Example 1

Focussing 1 cycle of 1 sequence point:

DC values for start and end are the same, also the AC amplitude. With a frequency >0 a sine wave progression of the set value is generated with a defined amplitude, frequency and Y shift (offset, DC value at start and end)

The number of sine waves per cycle depend on the sequence point time and the frequency. If the time were 1 s and the frequency 1 Hz, there would be exactly 1 sine wave. If the time were 0.5 s at the same frequency, there would only be a half sine wave.

Schematic diagram:

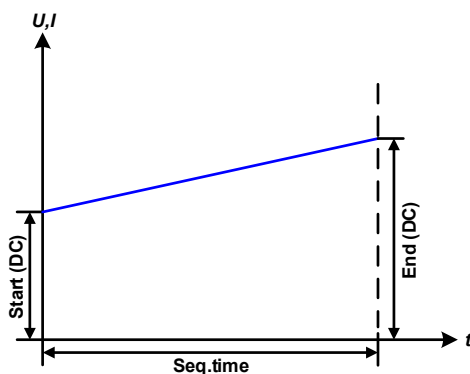
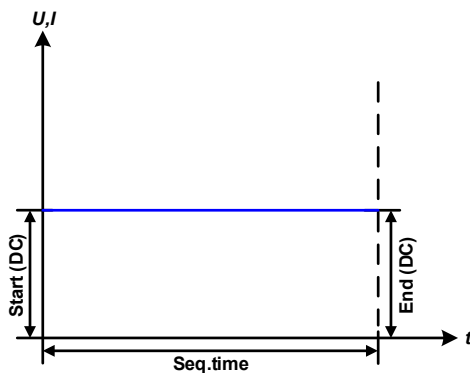
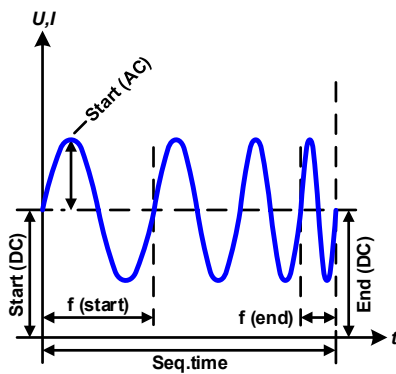
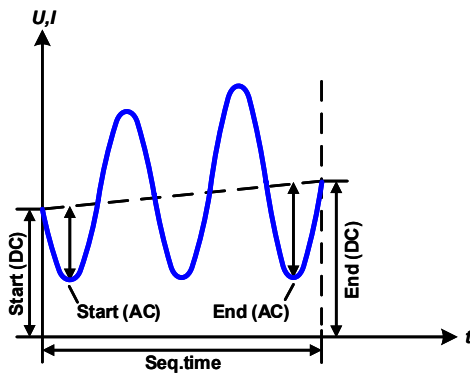
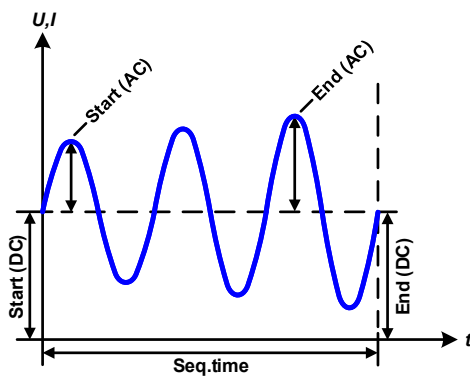

Applications and results:

Example 2

Focussing 1 cycle of 1 sequence point:

The DC values at start and end are the same but the AC (amplitude) not. The end value is higher than the start so that the amplitude increases with each new half sine wave continuously through the sequence. This, of course, only if the sequence time and frequency allow for multiple waves to be created. For example, with Freq. = 1 Hz and Time = 3 s three complete waves would be generated, if Angle = 0 °, and reciprocally the same for Freq = 3 s and Time = 1 s.

Example 3

Focussing 1 cycle of 1 sequence point:

The DC values at start and end are unequal, as are also the AC values. In both cases the end value is higher than the start so that the offset increases from DC start (**DCs**) to DC end (**DCe**) and the amplitude also with each new half sine wave.

Additionally the first sine wave starts with a negative half wave because the angle is set at 180 °. The start angle can be shifted at will in 1 ° steps between 0 ° and 359 °.

Example 4

Focussing 1 cycle of 1 sequence point:

Similar to example 1 but with another end frequency. Here this is shown as higher than the start frequency. This impacts the period of the sine waves such that each new wave will be shorter over the total span of the sequence time.

Example 5

Focussing 1 cycle of 1 sequence point:

Similar to example 1 but with a start and end frequency of 0 Hz. Without a frequency no sine wave part (AC) will be created and only the DC settings will be effective. A ramp with a horizontal progression is generated.

Example 6

Focussing 1 cycle of 1 sequence point:

Similar to example 1 but with a start and end frequency of 0 Hz. Without a frequency no sine wave part (AC) will be created and only the DC settings will be effective. Here start and end values are unequal and a steadily increasing ramp is generated.

By linking together a number of differently configured sequences, complex progressions can be created. Smart configuration of the arbitrary generator can be used to match triangular, sine, rectangular or trapezoidal wave functions and thus, e.g. a sequence of rectangular waves with differing amplitudes or duty cycles could be produced.

Schematic diagrams:

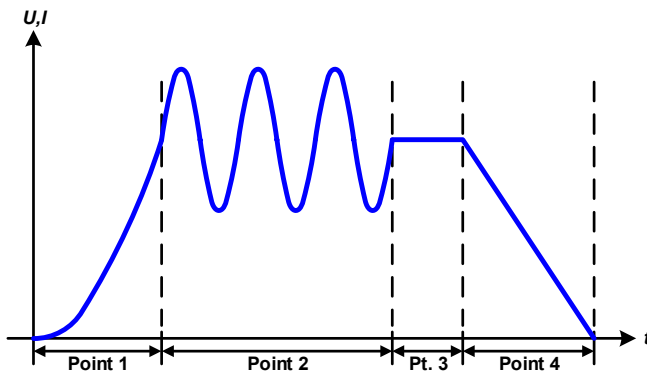
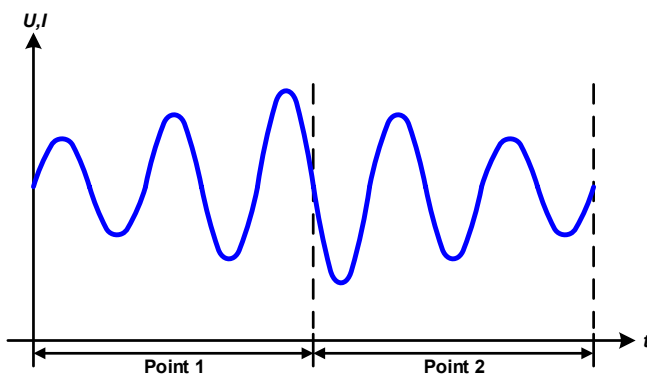
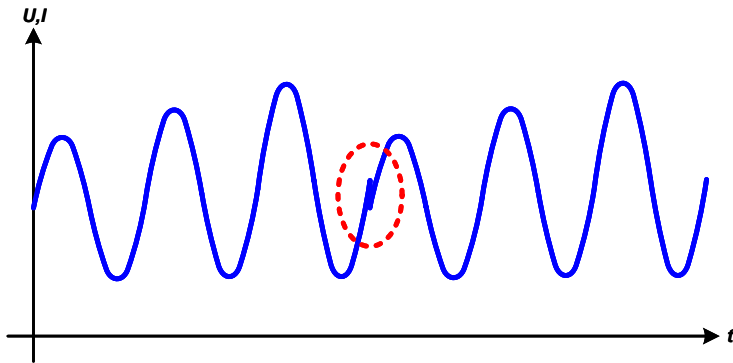

Applications and results:

Example 7

Focussing 2 cycles of 1 sequence point:

A sequence configured as in example 3 is run. As the settings demand that the end offset (**DCe**) is higher than the start, the second sequence run will revert to the same start level as the first, regardless of the values achieved at the end of the first run. This can produce a discontinuity in the total progression (marked in red) which may only be compensated with careful choice of settings.

Example 8

Focussing 1 cycle of 2 sequence points:

Two sequence points run consecutively. The first generates a sine wave with increasing amplitude, the second with a decreasing amplitude. Together they produce a progression as shown left. In order to ensure that the maximum wave in the middle occurs only once, the first sequence must end with a positive half wave and the second start with a negative half wave as shown in the diagram..

Example 9

Focussing 1 cycle of 4 sequence points:

- Point 1: 1/4th of sine wave (**Angle** = 270°)
- Point 2: 3 Sine waves (ratio of frequency to sequence point time: 1:3)
- Point 3: Horizontal ramp ($f = 0$)
- Point 4: Falling ramp ($f = 0$)

3.10.10.1 Loading and saving the arbitrary function

The 100 sequence points of the arbitrary function, which can be manually configured with the control panel of the device and which are applicable either to voltage (U) or current (I), can be saved to or loaded from a common USB stick via the front side USB port. Generally, all 99 points are saved or loaded using a text file of type CSV (semicolon separator), which represents a table of values.

In order to load a sequence point table for the arbitrary generator, following requirements have to be met:

- The table must contain exactly 99 rows (100 are also accepted for compatibility to previous firmware versions) with 8 subsequent values (8 columns, separated by semicolons) and must not have gaps
- The column separator (semicolon, comma) must be as selected by MENU parameter **USB file separator format**; it also defines the decimal separator (dot, comma)
- The files must be stored inside a folder called HMI_FILES which has to be in the root of the USB drive
- The file name must always start with WAVE_U or WAVE_I (not case-sensitive)
- All values in every row and column have to be within the specified range (see below)
- The columns in the table have to be in a defined order which must not be changed

Following value ranges are given for use in the table, related to the manual configuration of the arbitrary generator (column headers like in Excel):

Column	Parameter	Range
A	AC start amplitude	0...50% U or I
B	AC end amplitude	0...50% U or I
C	Start frequency	0...10000 Hz
D	End frequency	0...10000 Hz
E	AC start angle	0...359°
F	DC start offset	0...(Nominal value of U or I) - AC start amplitude
G	DC end offset	0...(Nominal value of U or I) - AC end amplitude
H	Sequence point time in μ s	100...36.000.000.000 (36 billion μ s)

For details about the parameter and the arbitrary function refer to „3.10.10. Arbitrary function“.

Example CSV:



	A	B	C	D	E	F	G	H	
1	20,00	30,00		5	5	90	50,00	50,00	50000000
2	30,00	20,00		5	5	90	50,00	50,00	30000000
3	0,00	0,00		0	0	0	0,00	0,00	1000
4	0,00	0,00		0	0	0	0,00	0,00	1000
5	0,00	0,00		0	0	0	0,00	0,00	1000
6	0,00	0,00		0	0	0	0,00	0,00	1000

The example shows that only the first two sequence points are configured, while all others are set to default values. The table could be loaded as WAVE_U or WAVE_I when using, for example, the model EL 9080-45 T, because the values would fit both, voltage and current. The file naming, however, is unique. A filter prevents you from loading a WAVE_I file after you have selected the arbitrary function for voltage in the function generator menu. The file would not be listed at all.

► How to load a sequence point table from an USB stick:

1. Do not plug the USB drive yet or remove it.
2. Access the function selection menu of the function generator with **MENU** -> **Page 2** -> **Function Generator** -> **Page 2** -> **Arbitrary** -> **U/I**, to see the main screen of Sequence select, as depicted to the right.



3. Tap touch area  , then  and follow the instructions on screen. If at least one valid files has been recognized (for file and path naming see above), the device will show a list of files to select from by tapping on the file name.

4. Tap touch area  in the bottom right corner. The selected file is then checked and loaded, if valid. In case it'sn't valid, the device will show an error message. Then the file must be corrected and the steps repeated.

► How to save a sequence point table to an USB stick:

1. Do not plug the USB stick yet or remove it.
2. Access the function selection menu of the function generator with **MENU -> Page 2 -> Function Generator -> Page 2 -> Arbitrary -> U/I.**



3. Tap on **Import/Export**, then **SAVE to USB**. The device will request you to plug the USB stick now.
4. After plugging it, the device will try to access the USB stick and find the folder HMI_FILES and read the content. If there are already WAVE_U or WAVE_I files present, they will be listed and you can either select one for overwriting by tapping on the file name, otherwise select **-NEW FILE-** for a new file.



5. Finally save the sequence table with **SAVE to USB**.

3.10.11 Battery test function

The purpose of the battery test function is to discharge various battery types in industrial product tests or laboratory applications. With date November, 2016 it's only available via access on the HMI, at least as setup and use are described below, but can also be achieved in remote control using the arbitrary function generator. The only disadvantage in remote control are the missing counters of battery capacity (Ah), energy (Wh) and time. But those can be calculated by custom remote control software when programming a time counter and regularly querying actual values from the device.

The function is usually applied on the DC input current and can either be selected and run in **Static** (constant current) or **Dynamic** (pulsed current) mode. In static mode, the settings for power or resistance can also let the device run the function in constant power (CP) or constant resistance (CR). Like in the normal operation of the load the set values determine what regulation mode (CC, CP, CR) is resulting on the DC input. If, for example, CP operation is projected, the set value of current should be set to maximum and resistance mode should be turned off, so that both don't interfere. For a projected CR operation it's similar. There current and power should be set to maximum.

For dynamic mode there is also a power setting, but it can't be used to run the dynamic battery test function in pulsed power mode or at least the result would not be as expected. It's recommended to adjust the power values always according to the test parameters, so it doesn't interfere with the pulsed current, i. e. dynamic mode.

When discharging with high currents, compared to the nominal battery capacity and in dynamic mode, it may happen that the battery voltage shortly drops below the U-DV threshold and the test will unintentionally stop. Here it's recommended to adjust U-DV accordingly.

Graphical depiction of both battery test modes:

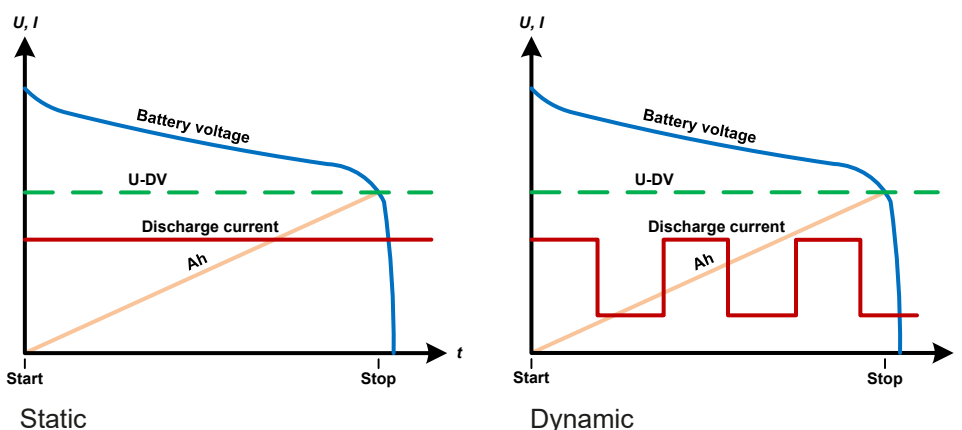

3.10.11.1 Parameters for static mode

The following parameters can be configured for the static battery test function.

Value	Range	Description
I	0...Nominal value of I	Maximum discharge current in Ampere
P	0...Nominal value of P	Maximum discharge power in Watt
R	Min....max. nominal value of R	Maximum discharge resistance in Ω (can be deactivated --> "OFF")

3.10.11.2 Parameters for dynamic mode

The following parameters can be configured for the dynamic battery test function.

Value	Range	Description
I_1	0...Nominal value of I	Upper resp. lower current setting for pulsed operation (the higher value of both is automatically used as upper level)
I_2	0...Nominal value of I	
P	0...Nominal value of P	Maximum discharge power in Watt
t_1	1 s ... 36000 s	t1 = Time for the upper level of the pulsed current (pulse)
t_2	1 s ... 36000 s	t2 = Time for the lower level of the pulsed current (pause)

3.10.11.3 Other parameters

These parameters are available in both test modes, but the values are separately adjustable for the modes.

Parameter	Range	Description
Discharge voltage	0...Nominal value of U	Variable voltage threshold to make the test stop when reached (is connected to the battery voltage on the DC input of the load)
Discharge time	0...10 h	Maximum test time after which the test can stop automatically
Discharge capacity	0...99999 Ah	Maximum capacity to consume from the battery after which the test can stop automatically
Action	NONE, SIGNAL, End of test	Separately defines an action for parameters Discharge time and Discharge capacity . It determines what shall happen with the test run once the adjusted values for those parameters are reached: NONE = No action, test will continue SIGNAL = Text Time limit will be displayed, test will continue End of test = The test will stop
Enable USB logging	on/off	By setting the check mark, USB logging is enabled and will record data. For more information see 3.10.11.5
Logging interval	100 ms - 1 s, 5 s, 10 s	Writing interval for USB logging

3.10.11.4 Displayed values

During the test run, the display will show a set of values and status:

- Actual battery voltage on the DC input in V
- Actual discharge current in A
- Actual power in W
- Discharge voltage (U_{DV}) in V
- Consumed battery capacity in Ah
- Consumed energy in Wh
- Elapsed time in HH:MM:SS,MS
- Regulation mode (CC, CP, CR)



3.10.11.5 Data recording (USB logging)

At the end of the configuration of both, static and dynamic mode, there is the option to enable the USB logging feature. With an USB stick plugged and formatted as required (see), the device can record data during the test run directly to the stick and in the defined interval. Active USB logging is indicated in the display with a small disk symbol. After the test has stopped, the recorded data will be available as text file in CSV format.

Log file format:

	A	B	C	D	E	F	G
1	Static:Uset	Iset	Pset	Rset	DV	DT	DC
2	0,00V	0,00A	1200W	OFF	0,00V	10:00:00	99999,00Ah
3							
4	Uactual	Iactual	Pactual	Ah	Wh	Time	
5	0,34V	0,00A	0W	0,00Ah	0,00Wh	00:00:00,800	
6	0,28V	0,00A	0W	0,00Ah	0,00Wh	00:00:01,800	
7	0,28V	0,00A	0W	0,00Ah	0,00Wh	00:00:02,800	
8	0,28V	0,00A	0W	0,00Ah	0,00Wh	00:00:03,800	

Static = Selected mode
 Iset = Max. current
 Pset = Max. power
 Rset = Desired resistance
 DV = Discharge voltage
 DT = Discharge time
 DC = Discharge capacity
 U/I/Pactual = Actual values
 Ah = Consumed battery capacity
 Wh = Consumed energy



Regardless the setting for the recording interval, the values "Ah" and "Wh" are only calculated by the device once per second. When using an interval setting of < 1 s, several identical values of Ah and Wh are written into the CSV.

3.10.11.6 Possible reasons for battery test stop

The battery test function run can be stopped by different reasons:

- Manual stop on the HMI with touch area STOP
- After the max. test time has been reached and action "End of test" was set for it
- After the max. battery capacity to consume has been reached and action "End of test" was set for it
- Any device alarm which would also switch off the DC input, like OT
- Passing the discharge voltage (DV) threshold, which is equivalent to any voltage drop on the DC input caused by whatever reason



After an automatic stop, caused by any of the listed reasons, the test can't be continued or run again immediately. The full battery configuration has to be run through, accessible via touch area BACK.

3.10.12 MPP tracking function

MPP stands for the maximum power point (see principle view to the right) on the power curve of solar panels. Solar inverters, when connected to such panels, constantly track this MPP once it has been found.

The electronic load simulates this behaviour by a function. It can be used to test even huge solar panels without having to connect a usually big solar inverter device which also requires to have a load connected to its AC output. Furthermore, all MPP tracking related parameters of the load can be adjusted and it so is much more flexible than an inverter with its limited DC input range.

For evaluation and analysis purposes, the load can also record measured data, i. e. DC input values such as actual voltage, current or power, to USB stick or provide them for reading via digital interface.

The MPP tracking function offers four modes. Unlike with other functions or general use of the device, values for the MPP tracking are only entered by direct input via the touch screen.

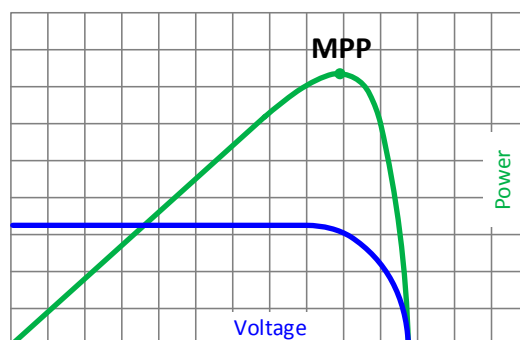

3.10.12.1 Mode MPP 1

This mode is also called “find MPP”. It’s the simplest option to have the electronic load find the MPP of a connected solar panel. It requires to set only three parameters. Value U_{OC} is necessary, because it helps to find the MPP quicker as if the load would start at 0 V or maximum voltage. Actually, it would start at a voltage level slightly above U_{OC} .

I_{SC} is used as an upper limit for the current, so the load would not try to draw more current than the panel is specified for.

Following parameters can be configured for tracking mode **MPP 1**:

Value	Range	Description
U_{OC}	0...Nominal value of U	Voltage of the solar panel when unloaded, taken from the panel specs
I_{SC}	0...Nominal value of I	Short-circuit current, max. specified current of the solar panel
Δt	5 ms...60000 ms	Time between two tracking attempts when finding the MPP

Application and result:

After the three parameters have been set, the function can be started. As soon as the MPP has been found, the function will stop and switch off the DC input. The acquired MPP values of voltage (U_{MPP}), current (I_{MPP}) and power (P_{MPP}) are then shown in the display.

The time of a function run depends on the parameter Δt . Even with the minimum setting of 5 ms one run take already a few seconds.

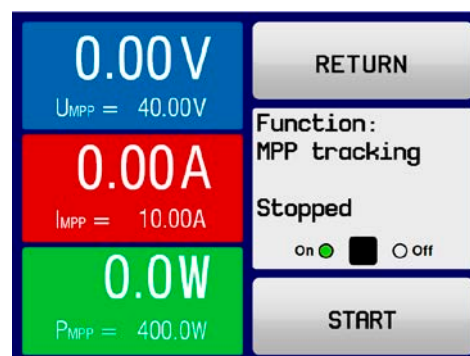

3.10.12.2 Mode MPP 2

This mode tracks the MPP, so it’s closest to the operation of a solar inverter. Once the MPP is found, the function won’t stop, but try to track the MPP permanently. Due to the nature of solar panels this can only be done below the level of the MPP. As soon as this point is reached, the voltage starts to sink further and so does the actual power. The additional parameter ΔP defines how much the power may sink before the direction is reversed and the voltage starts to rise again until the load reaches the MPP. The result is a zigzag shaped curve of both, voltage and current.

A typical curve display is shown in the picture to the right. For the example, the ΔP was set to a quite small value, so the power curve looks almost linear. With a small ΔP the load would always track close to the MPP.

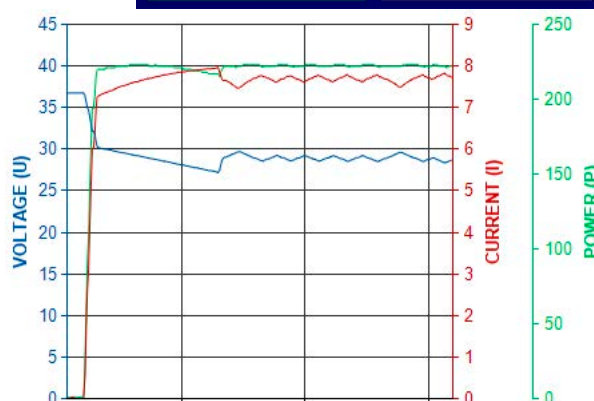

Following parameters can be configured for tracking mode **MPP 2**:

Value	Range	Description
U_{OC}	0...Nominal value of U	Voltage of the solar panel when unloaded, taken from the panel specs
I_{SC}	0...Nominal value of I	Short-circuit current, max. specified current of the solar panel
Δt	5 ms...60000 ms	Interval for measuring U and I during the process of finding the MPP
ΔP	0 W... P_{Nom}	Tracking/regulation tolerance below the MPP

3.10.12.3 Mode MPP 3

Also called “fast track”, this mode is very similar to mode MPP 2, but without the initial step which is used to find the actual MPP, because mode MPP 3 would directly jump to the power point defined by user input (U_{MPP} , P_{MPP}). In case the MPP values of the equipment under test are known, this can save a lot of time in repetitive tests. The rest of the function run is the same as with MPP2 mode. During and after the function, the least acquired MPP values of voltage (U_{MPP}), current (I_{MPP}) and power (P_{MPP}) are shown in the display.

Following parameters can be configured for tracking mode **MPP 3**:

Value	Range	Description
U_{OC}	0...Nominal value of U	Voltage of the solar panel when unloaded, taken from the panel specs
U_{MPP}	0...Nominal value of U	Voltage in the MPP
I_{SC}	0...Nominal value of I	Short-circuit current, max. specified current of the solar panel
P_{MPP}	0...Nominal value of P	Power in the MPP

Value	Range	Description
Δt	5 ms...60000 ms	Interval for measuring U and I during the process of finding the MPP
ΔP	0 W... P_{Nom}	Tracking/regulation tolerance below the MPP

3.10.12.4 Mode MPP 4

This mode is different, because it does not track automatically. It rather offers the choice to define a user curve by setting up to 100 points of voltage values, then track this curve, measure current and power and return the results in up to 100 sets of acquired data. The curve points can be entered manually or loaded from USB stick. Start and end point can be adjusted arbitrarily, Δt defines the time between two points and the function run can be repeated up to 65535 times. Once the function stops at the end or by manual interrupt, the DC input is switched off and the measured data is made available. After the function, the acquired set of data with the highest actual power will be shown in the display as voltage (U_{MPP}), current (I_{MPP}) and power (P_{MPP}) of the MPP. Going back on the screen with **RETURN** then allows for data export to USB stick.

Following parameters can be configured for tracking mode **MPP 4**:

Value	Range	Description
$U_1...U_{100}$	0...Nominal value of U	Voltage for the up to 100 user definable curve points
Start	1-100	Start point for the run of x out of 100 subsequent points
End	1-100	End point for the run of x out of 100 subsequent points
Δt	5 ms...60000 ms	Time before the next point
Rep.	0-65535	Number of repetitions for the run from Start to End

3.10.12.5 Load curve data from USB stick for mode MPP 4

Alternatively to manual adjustment of the 1-100 available curve points, which can be quite time-consuming, the curve point data (only one voltage value per point) can be loaded from USB stick in form of a CSV file. See section 1.9.5.5 for the naming convention. Contrary to manual adjustment where you can define and use an arbitrary number of points, loading from USB requires the CSV file to always contain the full number of points (100), because it can't define which one is start and end. However, the on-screen setting for **Start** and **End** point remain valid. It means, if you actually want to use all 100 points from your loaded curve, you must set the parameters according.

File format definition:

- The file must be a text file with appendix *.csv
- The file must contain only one column of voltage values (0... rated voltage)
- The file must exactly 100 values in 100 rows, no gaps
- The decimal separator of broken values must follow the setting **USB file separator format** where selection **US** means dot as decimal separator and selection **Standard** means comma

► How to load a curve data file for MPP 4

1. While the DC terminal is switched off, enter the **MENU** and the **Function Generator** and access **MPP Tracking**.
2. In the screen switch to tab MPP4. In the lower part a button labelled **Import/Export** will appear. Tap it.
3. In the next screen tap on **LOAD MPP 4 voltage values from USB**, have your USB stick ready and follow the instructions.

3.10.12.6 Save result data from MPP4 mode to USB stick

After the MPP4 function has run through, the result data can be saved to USB stick. The device will always save 100 data sets consisting of the actual values of voltage, current and power belonging to the points it has run through. There is no extra numbering. In case the settings **Start** and **End** were not 1 and 100, the true result data can later be filtered from the file. Points which were not adjusted are automatically set to 0 V, thus it's very important to carefully adjust start and end point because with a voltage setting of 0 V an electronic load would draw its rated current. That's because in this mode, current and power are always set to max.

Format of the result data file (for naming convention see section 1.9.5.5):

	A	B	C
1	1,01V	20,960A	21,0W
2	2,99V	20,970A	63,0W
3	3,99V	20,970A	84,0W
4	5,99V	20,940A	125,0W
5	7,00V	20,920A	146,0W
6	8,00V	20,930A	168,0W
7	9,00V	20,950A	188,0W
8	9,99V	20,960A	210,0W
9	10,99V	20,970A	231,0W

Legend:

- Column A: actual voltage of points 1-100 (= U_{MPP})
- Column B: actual current of points 1-100 (= I_{MPP})
- Column C: actual power of points 1-100 (= P_{MPP})
- Rows 1-100: result data sets of all possible curve points



The values in the example table to the left are with physical units. If that's not wanted, they can be turned off in the "General settings" menu of the device with parameter "USB logging with units (V,A,W)".

► How to save a curve data file for MPP 4

1. After the function has run through, it will stop automatically. Tap on the **RETURN** button to go back to the MPP4 configuration screen.
2. Tap on the button labeled **Import/Export**.
3. In the next screen tap on **SAVE MPP 4 results to USB**, have your USB stick ready and follow the instructions. You will have the choice to either overwrite any of the displayed files or to create a new one by tapping on **-NEW FILE-**.

3.10.13 Remote control of the function generator

The function generator can be remotely controlled but configuration and control of the functions with individual commands is different from manual operation. The external documentation "Programming Guide ModBus & SCPI" explains the approach. In general the following apply:

- The function generator isn't directly controllable via the analog interface; the only impact to the function run can come from pin REM-SB switching the DC input off, which will pause the function, so it could continue later with pin REM-SB switching the DC input on again and in case the function hasn't been stopped otherwise.
- The function generator is unavailable if the device in UIR mode (resistance mode, CR)

3.11 Other applications

3.11.1 Series connection



Series connection isn't a permissible operating method for electronic loads and must not be installed or operated under any circumstances!

3.11.2 Parallel operation

Multiple devices of same kind and ideally same model can be connected in parallel in order to create a system with higher total current and hence higher power. This can be achieved by connecting all units to the DC source in parallel, so the total current can spread across all devices. There is no support for a balancing between the individual units, like in form of a master-slave system. All loads would have to be controlled and set up separately. However, it's possible to have a parallel control by the signals on the analog interface, as this one is galvanically isolated from the rest of the device. There are few general points to consider and adhere:

- Always make parallel connections only with device of same voltage, current and power rating, but at least with those of the same voltage rating
- Never connect DC input cables from load device to load device, but instead from every load device directly to the source, else the total current will exceed the current rating of the DC input clamp

4. Service and maintenance

4.1 Maintenance / cleaning

The device needs no maintenance. Cleaning may be needed for the internal fans, the frequency of cleanse is depending on the ambient conditions. The fans serve to cool the components which are heated by the inherent high dissipation of heat. Heavily dirt filled fans can lead to insufficient airflow and therefore the DC input would switch off too early due to overheating or possibly lead to defects.

Cleaning the internal fans can be performed with a vacuum cleaner or similar. For this the device needs to be opened.

4.2 Fault finding / diagnosis / repair

If the equipment suddenly performs in an unexpected way, which indicates a fault, or it has an obvious defect, this can't and must not be repaired by the user. Contact the supplier in case of suspicion and elicit the steps to be taken.

It will then usually be necessary to return the device to Elektro-Automatik (with or without warranty). If a return for checking or repair is to be carried out, ensure that:

- the supplier has been contacted and it's clarified how and where the equipment should be sent.
- the device is in fully assembled state and in suitable transport packaging, ideally the original packaging.
- a fault description in as much detail as possible is attached.
- if shipping destination is abroad, the necessary customs papers are attached.

4.2.1 Replacing a defect mains fuse

The device is protected by a fusible which is inside a fuse holder on the rear of the device. The fuse rating is printed next to the fuse holder. Replace the fuse only with one of same size and rating.

4.2.2 Firmware updates



Firmware updates should only be installed when they can eliminate existing bugs in the firmware in the device or contain new features.

The firmware of the control panel (HMI), of the communication unit (KE) and the digital controller (DR), if necessary, is updated via the rear side USB port. For this the software EA Power Control is needed which is included with the device or available as download from our website together with the firmware update, or upon request.

However, be advised not to install updates promptly. Every update includes the risk of an inoperable device or system. We recommend to install updates only if...

- an imminent problem with your device can be solved directly, especially if we suggested to install an update during a support case
- a new feature has been added which you definitely want to use. In this case, the full responsibility is transferred to you.

Following also applies in connection with firmware updates:

- Simple changes in firmwares can have crucial effects on the application the devices are use in. We thus recommend to study the list of changes in the firmware history very thoroughly.
- Newly implemented features may require an updated documentation (user manual and/or programming guide, as well as LabView VIs), which is often delivered only later, sometimes significantly later

4.3 Calibration

4.3.1 Preface

The devices of series EL 9000 T feature a function to re-adjust the most important DC input related values when doing a calibration and in case these values have moved out of tolerance. The re-adjustment is limited to compensate small differences of up to 1% or 2% of the max. value. There are several reasons which could make it necessary to re-adjust a unit: component aging, component deterioration, extreme ambient conditions, high frequent use.

In order to determine if a value is out of tolerance, the parameter must be verified first with measurement tools of high accuracy and with at least half the error of the EL device. Only then a comparison between values displayed on the EL device and true DC input values is possible.

For example, if you want to verify and possibly re-adjust the input current of model EL 9080-45 T which has 45 A maximum current stated with a max. error of 0.2%, you can only do that by using a high current shunt with max. 0.1% error or less. Also, when measuring such high currents, it's recommended to keep the process short, in order to avoid the shunt heating up too much. It's furthermore recommended to use a shunt with at least 25% reserve.

When measuring the current with a shunt, the measurement error of the multimeter on the shunt adds to the error of the shunt and the sum of both must not exceed the given max. 0.4% of the device.

4.3.2 Preparation

For a successful calibration and re-adjustment, a few tools and certain ambient conditions are required:

- A measurement device (multimeter) for voltage, with a max. error of half the EL's voltage error. That measurement device can also be used to measure the shunt voltage when re-adjusting the current
- If the current is also going to be calibrated: a suitable DC current shunt, ideally specified for at least 1.25 times the max. input current of the EL and with a max. error that is half or less than the max. current error of the EL device
- Normal ambient temperature of approx. 20-25 °C
- An adjustable voltage & current source which is capable of providing at least 102% of the max. voltage and current of the EL device, or separate voltage source and current source units

Before starting the calibration procedure, a few measures have to be taken:

- Let the EL device warm up for at least 10 minutes under 50% power, in connection with the voltage / current source
- In case the remote sensing input is going to be calibrated, prepare a cable for the remote sensing connector to DC input, but leave it yet unconnected
- Abort any form of remote control, set resistance mode to disabled
- Install the shunt between source and EL device and make sure the shunt is cooled somehow. For example , you might want to place it in the warm air stream coming out of the rear of the EL device. This helps the shunt to warm up as well to operation temperature
- Connect suitable measurement devices to the DC input and to the shunt, depending on whether the voltage is going to be calibrated first or the current

4.3.3 Calibration procedure

After the preparation, the device is ready to be calibrated. From now on, a certain sequence of parameter calibration is important. Generally, you don't need to calibrate all three parameters, but it's recommended to do so.

Important:



*The input current calibration should be done before any voltage calibration, because the calibrated input current is used for voltage calibration.
When calibrating the input voltage, the remote input sense on the rear of the device has to be disconnected.*

The calibration procedure, as explained below, is an example with model EL 9080-45 T. Other models are treated the same way, with values according to the particular EL model and the required power source.

4.3.3.1 Set values

► How to calibrate the voltage

1. Adjust the connected voltage source to approx. 102% of the maximum voltage specified for the EL device. For the example with an 80 V EL this would be 81.6 V for the source. Set the current limitation of the voltage source to >5% of the nominal current specified for EL device, for this example it's at least 2.3 A. Check again, that for voltage calibration, the sensing connector (Sense) on the front of the device isn't connected.
2. While the DC input is switched off enter MENU, then tap on **Settings**, then on **Page 2** and there on **Calibrate Device**.
3. In the next screen select: **Voltage calibration**, then **Calibrate input val.** and **NEXT**. The load will switch the DC input on and start to measure the input voltage (**U-mon**).
4. The next screen requests you to enter the measured input voltage at **Measured value=** from the multimeter. Enter it using the keypad, that appears when tapping the value. Assure yourself the value is correct and submit with **ENTER**.
5. Repeat step 4. for the next three steps (total of four steps).

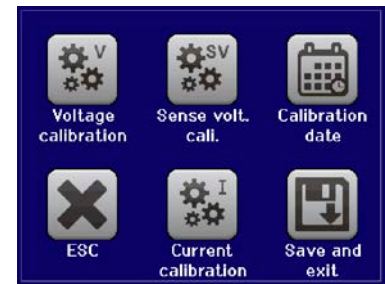

► How to calibrate the current

1. Adjust the current source to approx. 102% nominal current of the EL device, for the sample model with 45 A this would be 45.9 A, rounded to 46 A. Make sure the source can provide more current than the EL can draw, else the source's voltage will collapse. Set the output voltage of the current source to 10% of the nominal voltage specified for EL, in the example 8 V, and switch the DC output of the source on.
2. While the DC input is switched off enter MENU, then tap on **Settings**, then on **Page 2** and there on **Calibrate Device**.
3. In the next screen select: **Current calibration**, then **Calibrate input val.** and **NEXT**. The load will switch the DC input on and start to measure (**I-mon**).
4. The next screen requests you to enter the input current **Measured value=** measured with the shunt. Enter it using the keypad, assure yourself the value is correct and submit with **ENTER**.
5. Repeat step 4. for the next three steps (total of four steps).

In case you are generally using the remote sensing feature (Sense), it's recommended to readjust this parameter too, for best results. The procedure is identical to the calibration of voltage, except for it requires to have the sensing connector on the rear to be plugged and connected with correct polarity to the DC input of the EL.

► How to calibrate the remote sensing voltage

1. Adjust the connected voltage source to approx. 102% of the maximum voltage specified for the EL device. For example with an 80 V EL this would be 81.6 V for the source. Set the current limitation of the voltage source to >5% of the nominal current specified for EL device, for this example it's at least 3 A.
2. While the DC input is switched off enter MENU, then tap on **Settings**, then on **Page 2** and there on **Calibrate Device**.
3. In the next screen select: **Sense volt. calibration**, then **Calibrate input val.** and **NEXT**.
4. The next screen requests you to enter the measured sensing voltage **Measured value=** from the multimeter. Enter it using the keypad, that appears when tapping the value. Assure yourself the value is correct and submit with **ENTER**.
5. Repeat step 4. for the next three steps (total of four steps).

4.3.3.2 Actual values

Actual values of the input voltage (with and without remote sensing) and the input current are calibrated almost the same way as the set values, but here you don't need to enter anything, but just confirm the displayed values. Please proceed the above steps and instead of **Calibrate input val.** select **Calibrate actual val.** in the sub menus. After the device shows the measured values on display, wait at least 2 seconds for the measured value to settle and then tap **NEXT** until you are through all steps.

4.3.3.3 Save and exit

After calibration you may furthermore enter the current date as “calibration date” by tapping  in the selection screen and enter the date in format YYYY / MM / DD.

Last but not least save the calibration data permanently by tapping

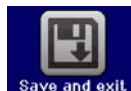

Leaving the calibration selection menu without “Save and exit” will discard calibration data and the procedure would have to be repeated!

5. Contact and support

5.1 Repairs

Repairs, if not otherwise arranged between supplier and customer, will be carried out by EA Elektro-Automatik. For this the equipment must generally be returned to the manufacturer. No RMA number is needed. It's sufficient to package the equipment adequately and send it, together with a detailed description of the fault and, if still under guarantee, a copy of the invoice, to the following address.

5.2 Contact options

Questions or problems with operation of the device, use of optional components, with the documentation or software, can be addressed to technical support either by telephone or e-Mail.

Headquarter	e-Mail	Telephone
EA Elektro-Automatik Helmholtzstr. 31-33 41747 Viersen Germany	Technical support: support@elektroautomatik.com All other topics: ea1974@elektroautomatik.com	Switchboard: +49 2162 / 37850 Support: +49 2162 / 378566



Elektro-Automatik

EA Elektro-Automatik GmbH & Co. KG

Development - Production - Sales

Helmholtzstraße 31-37

41747 Viersen

Germany

Fon: +49 2162 / 37 85-0

Mail: ea1974@elektroautomatik.com

Web: www.elektroautomatik.com