

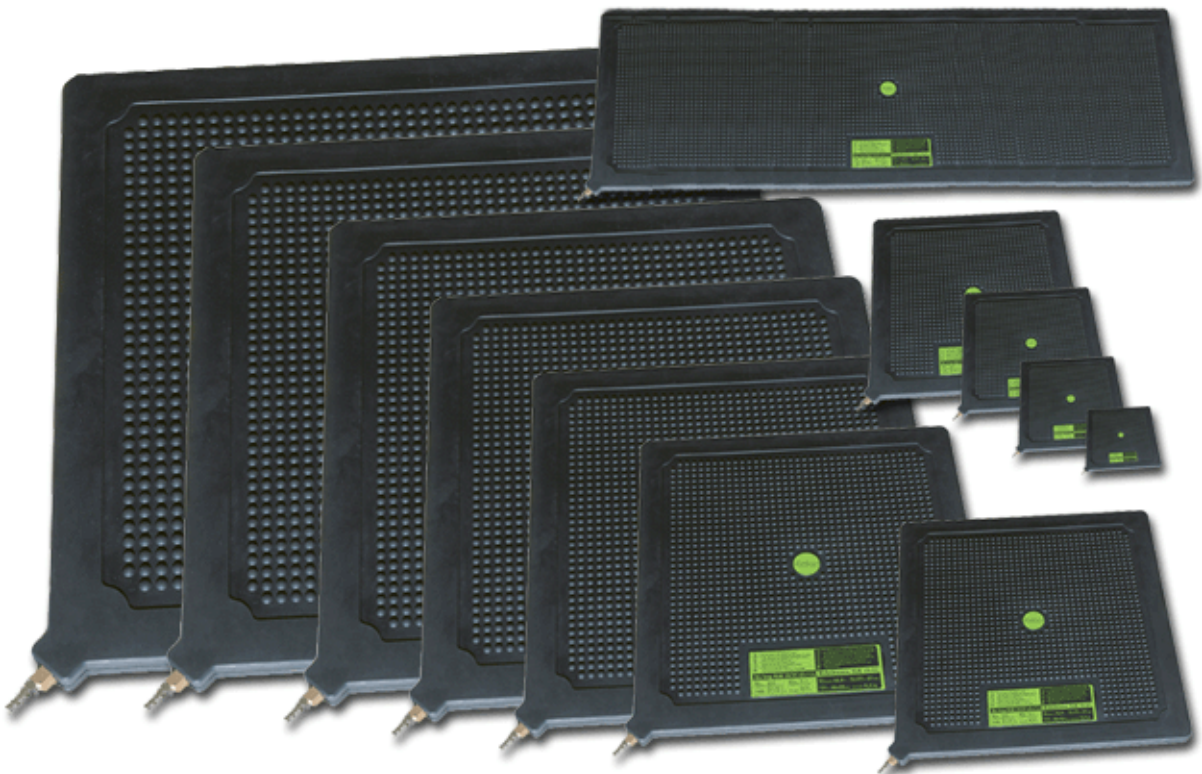

PLEASE READ AND UNDERSTAND THIS MANUAL BEFORE USING LIFTING BAGS



PNEUMATIC HIGH PRESSURE HEAVY LIFTING BAGS

SAFETY, OPERATION AND MAINTENANCE INSTRUCTIONS

NON-COMPLIANCE WITH INSTRUCTIONS AND WARNINGS FOR SAFE OPERATION OF LIFT BAGS CAN DAMAGE PRODUCTS, PROPERTY AND CAUSE SERIOUS BODILY INJURIES.

777 OAKMONT LANE, STE. 800, WESTMONT, IL 60559
BY PHONE: 1-800-323-9114 • 1-630-590-5990

HEAVY LIFT BAGS INSTRUCTION MANUAL

WARNING!

Before using Lifting Air Bags, carefully read these instructions. Non-compliance with recommendations can result in product damage and personal injury.

Never work under a load without safety supports

Never exceed the inflation pressure of 8 bar (118 PSI)

Never place more than two lifting air bags one upon another

Information

This booklet contains technical information about lifting air bags and basic instructions for use. The selection and application of air bags depend on various factors such as lifting requirements, capacity, lifting height, and shape of objects. The manufacturer doesn't assume any responsibility for personal injuries or material damages arising from improper use or misuse of lifting air bags and their constituents. The figures beside the text are shown for information only. Actual conditions of lifting techniques and characteristics depend on the particular application.

Recommendations for safe and efficient work

When using air bags, always wear protective clothing. Firemen and rescue-team members must be equipped completely in accordance with all requirements; other users should wear safety helmet, safety glasses and gloves or other equipment if required.

Proper transportation of air bags is of great importance. Care should be taken that air bags are always being carried with the inflation nozzle facing upwards to avoid impact damage to the inflation mechanism. Large, heavy air bags are to be carried by two persons. When air bags are stored or transported in horizontal position, the inflation nozzle must face a direction so that it can be easily seen when an air bag is to be moved, and that the work can be done safely without risk of damage.

When the surface temperature of the object to be lifted exceeds 55°C (131°F), the part of the air bag in contact with the object is to be protected by means of a fiberboard. Heat and temperatures exceeding the permissible level can damage the air bag. Alternatively, in cold conditions, air bags have been tested and proven to perform as specified to at least -20°C (-4°F)

Even though it is simple to place and to inflate the air bag in the dark, it is dangerous. The work area should be well illuminated. Sometimes, when due to the effect of shading or poor visibility during the day it is recommended to use additional sources of light.

High-pressure cylinders and pressure regulators

Every time the pressure regulator is attached to a cylinder the following safety and operating precautions must be used. Deviation from the following safety and operating instructions may result in fire, explosion, damage to the regulator or injury to the operator.

High-pressure cylinder/regulator care

1. Before removing the protective cap, secure the cylinder to a wall, post or cart to prevent it from falling.
2. Inspect the cylinder valve for damaged threads, dirt, dust, oil or grease. Remove contamination with a clean cloth.
3. Crack open the cylinder valve for an instant to blow out dust and foreign matter that could clog or damage the regulator. Do not place any part of your body near the airflow, as high-pressure air-jets-even at relatively low velocity-have been known to tip the cylinder over, accelerate projectiles, penetrate skin, dislocate eyeballs and cause other serious injury.

4. Inspect regulator and clean if foreign matter is present. Regulators do not require regular periodic maintenance unless they show signs of malfunction. If there is a problem noticed, remove the regulator from service and return to Sava Trade Inc. for inspection and servicing.
5. If you have a piston regulator, no user adjustments are necessary, ignore steps 6-11
6. If you have a diaphragm regulator, turn the regulator-adjusting handle counter-clockwise until the adjusting spring pressure is released (off position) then install the regulator onto the cylinder valve. Do not use grease, Teflon tape or sealants, as the compression fitting is self-sealing. Tighten compression nut with a wrench using firm pressure (excessive force is not necessary and can damage threads). If the nut is knurled and meant to be hand-tightened, do not use a wrench, vice-grip or pliers.
7. Carefully and slowly, slightly open the high-pressure valve on the cylinder turning counter-clockwise. Check for leaks.
8. To check for leaks, open the low-pressure regulator-adjusting handle one turn clockwise (pressure should be indicated on the low pressure gauge). Then close the high-pressure cylinder valve.
9. If the high pressure gauge reading drops then there is a leak in cylinder valve, inlet fitting or high pressure gauge. If the low pressure gauge reading drops then there is a leak in the output fitting. If there are no leaks present close the low-pressure regulator-adjusting handle and connect the output hose, controller(s), and lifting apparatus.
10. Open high-pressure valve only if leaks or malfunctions are not present. Open valve completely (to the valve stop) to seal the valve packing.
11. Test entire apparatus before actual use to determine proper operation and sealing of connections and apparatus.
12. It is remotely possible for a slight amount of air to continually flow from a connected high-pressure source even if control valves are off. Do not leave equipment unattended. Continuously monitor



How the single and double controller inflation system operates

Prior to use, connect the regulator to the high-pressure cylinder. Turn the regulator output control valve off (counter-clockwise). Open the high-pressure cylinder valve all the way. Set the regulator output pressure to 0.8 Mpa (8 bar, 116 PSI) using the regulator output pressure-control valve.

If you are using a regulated air compressor to supply air, set the regulator to supply at least 115 PSI.

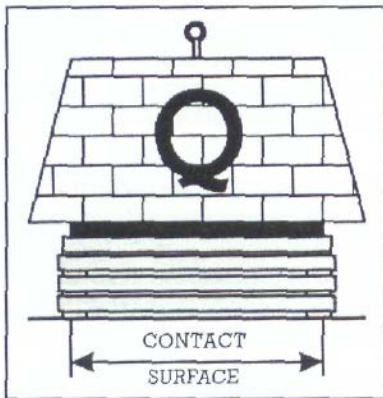

Close the controller's deflation control valve (screw clockwise) to prevent air loss while inflating. Close the controller's red inflation control valve (shown in the off position). Connect the air bags to one (red) hose; connect controller inline between that (red) hose and another (yellow) hose. Connect the yellow supply hose to the air source. Place the bag in position before inflating. Open the controller inflation valve. Monitor the pressure gauge and the air bag for proper operation during inflation. When you are ready to lower the load, close the controller inflation valve. To deflate the bag, open the deflation control valve, which is on top of the pressure relief valve (on the controller). Remove the air bags from under the load, disconnect them, press out the remaining air, and clean them.

Lifting using a single air bag

Position the air bag in a prearranged place or a constructed foundation (Figure 2). A fully emptied air bag contains very little air.

Air bags can be protected from sharp objects using flexible or non-flexible mats. When placing an air bag on the ground, cribbing, mats or other surfaces, consider the effect of the weight on the entire supporting surface structure. Be certain the surface structure will be able to support the total weight without significant distortion or displacement.

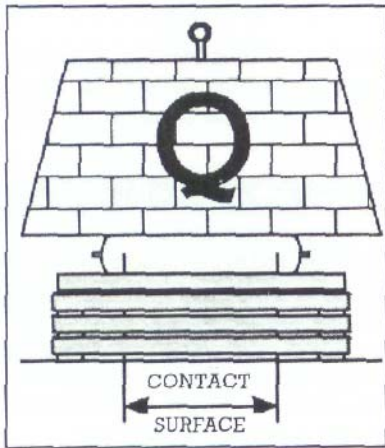

As the bag fills, and develops a spherical shape, there is less and less surface area in contact with the load. This will result in less lifting force as the height increases. The amount of weight that can be lifted is directly related to the amount of surface area in contact with the load (Figure 3). Thus, maximum force can be attained only at the beginning of inflation, when the lifting height is low and maximum surface area is in contact with the load. (see diagrams).

Figure 3'

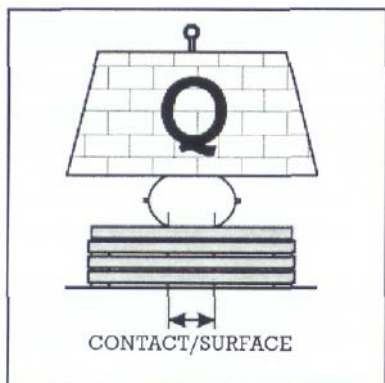

When the air bag is fully inflated, the contact surface and lifting capacity reach their minimum, and the lifting height its maximum (Figure 4). To be able to correctly operate the air bag, a user must be acquainted with the data about maximum lifting force, maximum lifting height and maximum lifting capacity at maximum lifting height. See graphs at the end of this manual for application range and lifting height vs. weight ratios.

Figure 4

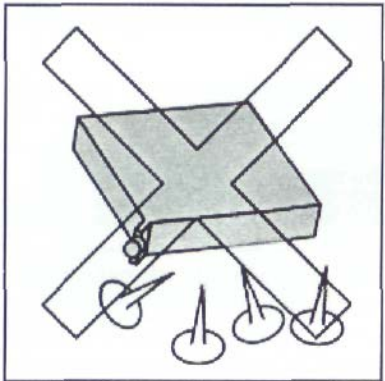

1. Clean the work area of all glass fragments and other foreign particles, which might damage the air bag. If the air bag is placed on a smooth or slippery surface, sprinkle the surface with sand or other suitable, granulated material. If the air bag is used on soft ground, a solid support or a fiberboard should be placed under the air bag.

(Figure 5)

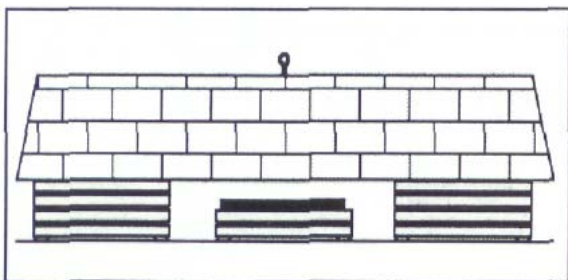

(Figure 6)

2. When there is more than 2 3/4" (70 mm) space between the ground and the object to be lifted, a firm, high enough foundation should be built, leaving just enough space to insert the deflated

bag(s). The upper surface of the foundation should be flat, without any gaps. The airbag is not designed to span surface gaps greater than 1/8".

3. On each side of the air bag foundation, additional safety supports, such as cribbing, matting or blocking, (or combination of all) should be used, progressively during lifting. This prevents load-shift failure or lift bag failure (Figure 6). This also reduces the height, from which the load would fall in case of air bag or inflation system malfunction or failure.

4. The air bag should be placed in the middle of the object load so that the inflation nozzle is pointing to the front side. Always distribute the load weight as evenly as possible and to as large of surface area as possible. Small contact surface area can cause the object to slide during inflation, causing the air bag pop out or the object to shift considerable distance. Small contact area could also stress the bag.

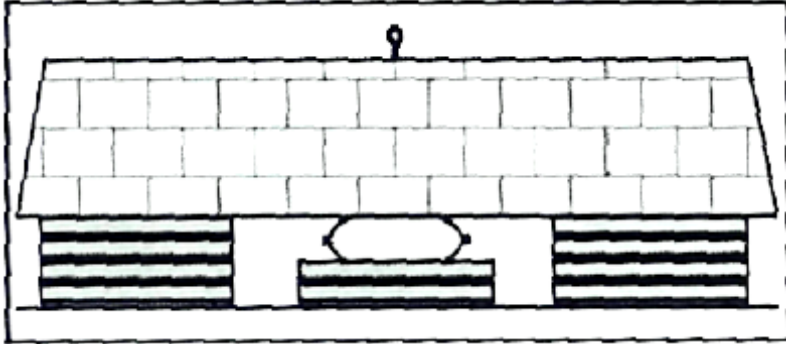

5. When lifting a load higher than the lift capacity of the bag(s), it is necessary to support the load, deflate the bag(s), and then add a foundation under the bag(s) to lift incrementally higher (Figure 7).

Have sufficient personnel available to continuously add safety supports as recommended. It is necessary to build the safety support structure simultaneously while lifting. Lift an inch, crib an inch. (Figure 7)

6. To lower the load, slowly deflate the air bag, allowing the object load to rest entirely upon the safety supports when the bag is near the deflated position. Remove the air bag foundation incrementally in the same fashion as lifting.

WARNING!

With any lifting operation, the safety support structures are of essential importance. Any work under a load supported only by an inflated air bag is extremely dangerous and is contrary to all safety guidelines and instructions.

Do not leave an inflated bag unattended for any length of time. Due to the natural porosity of rubber bags and rubber o-rings (in the inflation apparatus), air can leak out of the bag slowly. Also it is possible for a slight amount of air to continually enter the bag from a connected high-pressure source even if control valves are off.

Lifting using two air bags

Using one larger bag is always easier and safer than using two smaller bags. But if this is not possible it is acceptable to configure multiple bags to do the same work as a larger bag.

Up to two air bags can be stacked in order to increase lifting height. Placing the next size smaller bag in the center, and on top, of the larger one.

Inflation nipples for both bags should be on the same side (Figure 8), Never stack more than two air bags together.

Construct a foundation as necessary similar to the use of a single bag.

Inflate the lower, larger air bag first, so as to allow the smaller (upper) one to touch the object to be lifted if possible.

Then fully inflate the upper air bag and, if necessary, the lower one again, until the required lifting height is achieved.

Safety supports are to be added under the load with care. When lowering, slowly empty the top air bag first, then the lower bag last.

Increasing lifting capacity weight or increasing lifting capacity height

Stacking two air bags (one upon another) will only increase lifting height capacity.

A side-by-side arrangement will only increase lifting weight capacity.

With two air bags stacked, the combined weight-lifting capacity of the bags is equal only to the weight lifting capacity of the smaller air bag (Figure 10). Likewise, a side-by-side arrangement will increase weight lifting capacity.

Figure 9 shows two air bags, placed side-by-side on cribbing foundations. The first air bag can lift 8 tons, the second 12 tons. Neither of the bags can lift the load of 15 tons. However, when side-by-side, and inflated together at the same time, they are able to lift 20 tons.

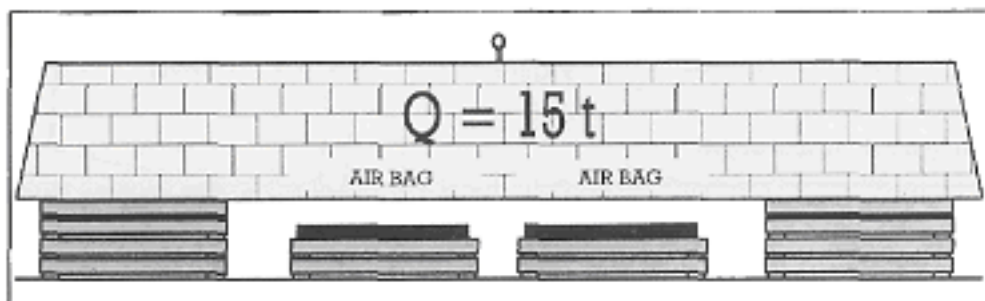

Figure 9

Lifting height can be increased by stacking one air bag on top of another (Figure 10). If the possible lifting height of one bag is 7" (18 cm) max and of the other 8-1/2" (22 cm), (both together and fully inflated can achieve the lifting height of 15 3/4" (40 cm),



(Figure 10)

WARNING!

Never stack more than two air bags one upon another. Smaller bag goes on top of the larger one.

By constructing foundation supports with blocking, cribbing and mats we can achieve higher lifting heights.

Lifting objects with unusual shapes

Lifting an I-beam or pipe

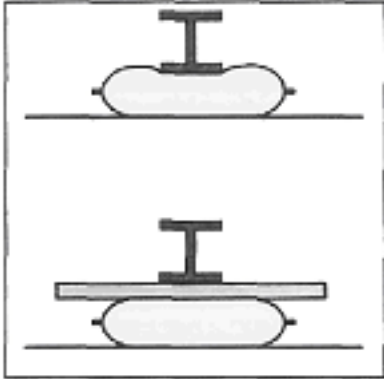

When lifting I-beams or pipes using an air bag, problems arise, as the object doesn't contact the entire surface of the bag. Further, twisting can damage the air bag's reinforcing Kevlar cord. For that reason a steel plate or fiberglass board of suitable strength should be inserted between the air bag and the object to be lifted, in order to permit the lifting force to be equally distributed over the entire lifting surface of the air bag (Figure 11),

Figure 11

Lifting a cylindrical object

Large cylindrical objects, such as pipes or tanks may require two or more air bags. If such objects are not firmly fastened they can shift and/or roll away as soon as the single air bag begins expanding to its inflated spherical shape. Inflate both bags at the same time to minimize danger (Figure 12).

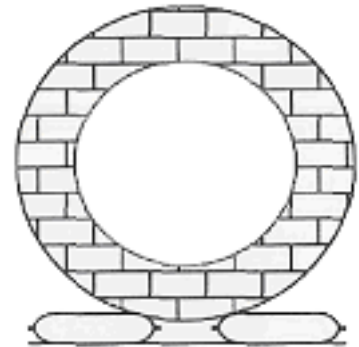
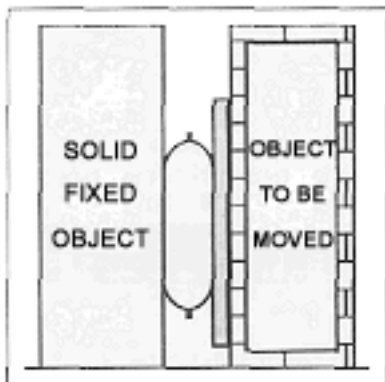

Figure 12

Separating and pushing, using air bags



Air bags can also be used to separate and to move objects, usually without special difficulties. Problems arise if an object has thin walls, which could be bent or broken by the pressure of the air bag. For that reason the air bag is to be reclined against a rib, a pillar or another tough and rigid element. If this is not possible, insert a wide steel or fiberglass board between the air bag and the object to increase the surface area that the air bag force exerts upon (Figure 13).

Figure 13

Clean air bags after each use. Oil or grease spots can cause air bags to slide. Prolonged contact with petroleum-based liquids can also cause some types of rubber to degrade prematurely. The presence of dirt in the nozzle can cause leaks or prevent hose connection. In the upright position with the nozzle at the top, the air bag is to be knocked against the floor to shake off the dirt. Check the opening in the nozzle. If it is full of dirt, remove it using a thin piece of wire. Do not push the dirt inside the bag draw it out.

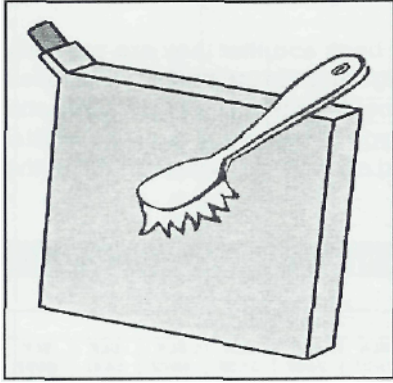

To remove accumulated dirt or mud from the air bag surface, use a dry brush with hard bristles. Move the brush in all directions. Don't use sharp objects to remove dirt from the air bag surface. After cleaning all the agglutinated dirt, soak the spots with a light solution of warm water and a dish washing detergent, and using the brush, remove the remaining dirt (Figure 14).

Figure 14

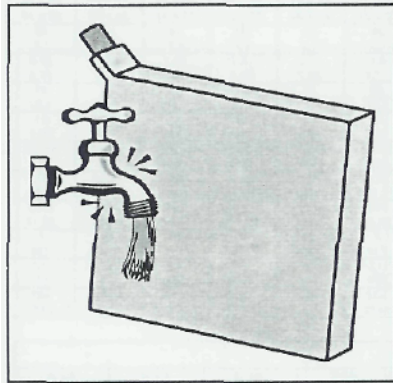

Rinse the surface with cold, fresh water (Figure 15), Strong water jet shall remove all the dirt and detergent which might have remained on the air bag surface. With the air bag in the upright position, wipe the nozzle using a clean cloth. Let the air bag dry. Don't speed up drying by putting the air bag in a drier or close to a source of heat.

Figure 15

Inspection, storage and preventive maintenance

Adequate maintenance and care for air bags require more than cleaning after use. Air bags call for inspection, and preventive maintenance throughout the period of storage.

Check after use

1. When dry, check the air bag for any blistering, cuts or worn out segments that might be hidden under the dirt. If you observe any deep cuts, damage or deep wear, mark it with a chalk, and consult the manufacturer or an authorized service.
2. Check the nozzle for any wear or damage, which could hinder a positive connection or cause leaks. Replace the nozzle, if necessary.

Metric

Maximum lifting capacity
1 kN = 1 T (UK)

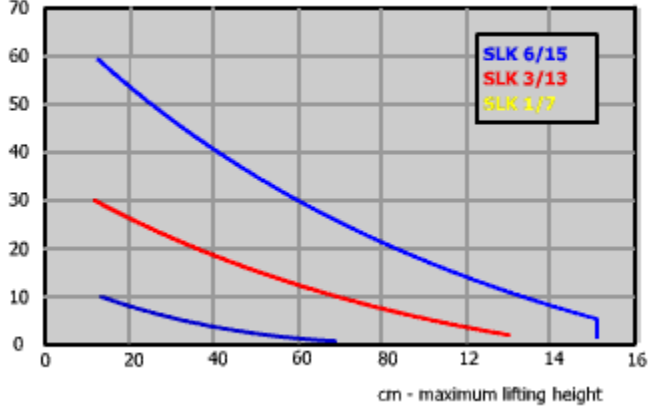

Maximum Lifting Capacity
10 kN = 1 T (UK)

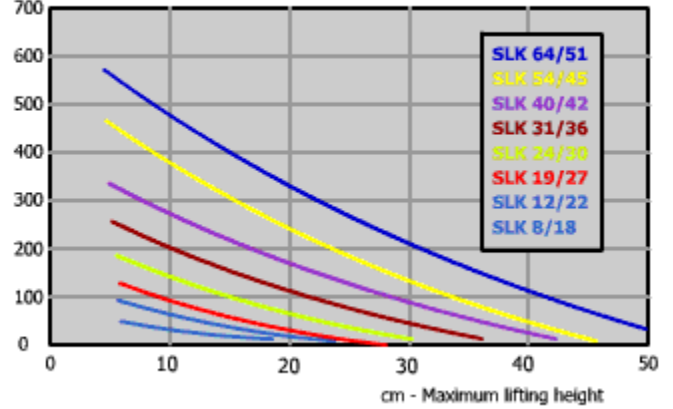

Technical data - lifting bags												
Metric	Metric MT/cm	SLK	SLK	SLK	SLK	SLK	SLK	SLK	SLK	SLK	SLK	SLK
		1/7	3/13	6/15	8/18	12/22	19/27	24/30	31/36	40/42	54/45	64/51
Size - deflated	cm x cm	15 x 15	23 x 23	30 x 30	38 x 38	45 x 45	55 x 55	61 x 61	69 x 69	78 x 78	87 x 87	91 x 91
Item number	#	77973	77974	77975	76734	76735	76736	76737	76738	76739	76794	76740
American	USA T/in.	SLK	SLK	SLK	SLK	SLK	SLK	SLK	SLK	SLK	SLK	SLK
		1.1/2.8	3.5/5	6.8/6	8.8/7	SLK	21/11	26/12	34/14	44/17	59/18	70/20
Size - deflated	sq./in.	6X6	9X9	12X12	15X15	18X18	22X22	24X24	27X27	31X31	35X35	36X36

Maximum lifting capacity
Tons US

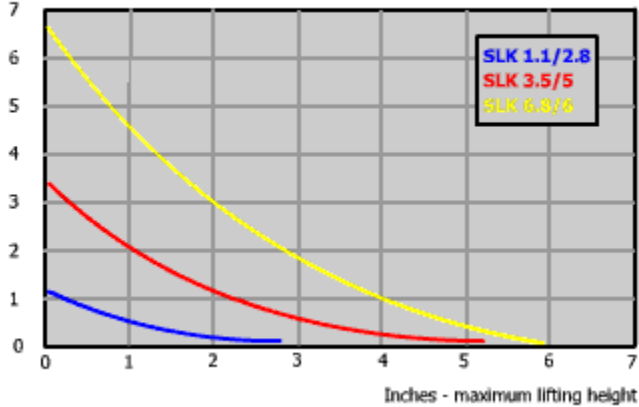

Maximum lifting capacity
Tons US

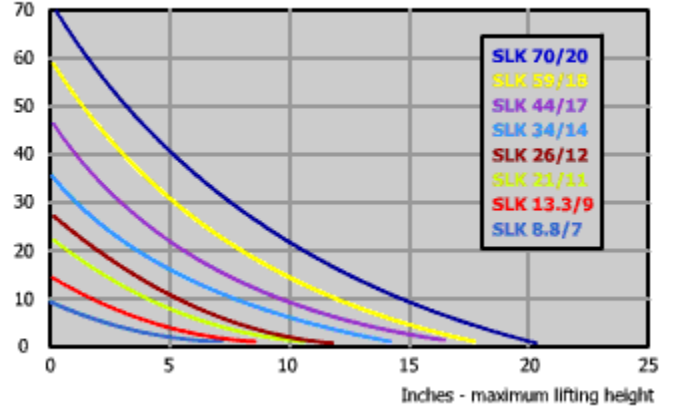

SAE USA