

Linear cylinders

Linear Cylinders

A wide variety of styles and features make Enerpac's linear cylinder line the most complete in the industry. Ranging from compact short stroke spring return cylinders to heavy-duty industrial grade double-acting automation cylinders, Enerpac has the cylinder to meet every application need. Whether you have to push it, pull it, clamp it, punch it, stamp it, press it, or hold it in place for days at a time, Enerpac has the cylinder to meet your need.



















Technical support

Refer to the "Yellow Pages" of this catalog for:

- Safety instructions
- Basic hydraulic information
- Advanced hydraulic technology
- FMS (Flexible Machining Systems) technology
- Conversion charts and hydraulic symbols.

 197 ▶

	▼ series	▼ page	
Link clamps / Link clamp arms	LU LCA	54 - 55 56 - 57	
Pull cylinder range overview		58 - 59	
Upper flange pull cylinders	PU	60 - 61	
Lower flange pull cylinders	PL	62 - 63	
Threaded body pull cylinders	PT	64 - 65	
Linear cylinders		66 - 93	
Threaded cylinders	CST, CDT	66 - 67	
Additional threaded cylinders	CYDA, WMT, WRT	68 - 69	
Manifold cylinders	CSM	70 - 71	
Block cylinders	BD, BMD BMS, BS	72 - 75	
Pull down clamps	ECH, ECM	76 - 77	
Hollow plunger cylinders	CY, HCS, QDH, RWH	78 - 79	
Positive clamping cylinders	MRS	80 - 81	
Single-acting universal cylinders	RW, MRW, REB, REP	82 - 83	
Double-acting universal cylinders	BRD, BAD	84 - 85	
Cylinder accessories	AW, BS, FN, MF	86 - 87	
Tie rod cylinder	TR	88 - 92	
Tie rod accessories	TRA, TRR	93	

Shown: LUCS-32



▶ Link clamp allows unobstructed part loading and high clamping forces. The hydraulic cylinders extend to provide clamping force, and retract to allow part removal.

Arm completely retracts to allow part loading.

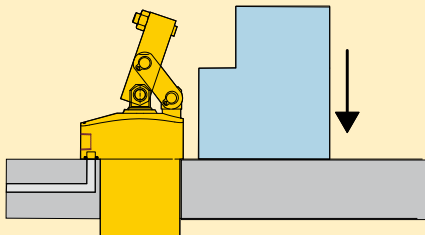

As cylinder extends, arm pivots to clamp part in place.

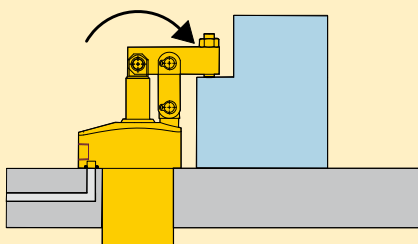

Arm location is changed easily without the use of tools.

Left Center Right

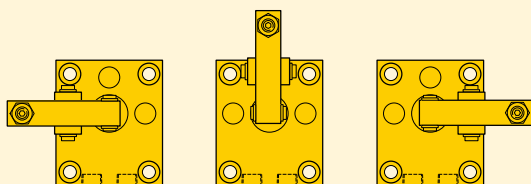

Quick and accurate clamping action

- Hydraulic cylinder pushes linkage, pivoting clamp arm into position
- Design ensures repeatable clamping location
- Linkage can be re-positioned to clamp at 90, 180, or 270 degrees from ports
- Clamps can be mounted using supplied bolts or held in place with flange nut
- Standard arm or long arm ordered separately.

Product selection

Clamping force ¹⁾	Stroke	Model number	Cylinder effective area	Oil capacity	Standard clamp arm (Sold separately)	Long clamp arm (Sold separately)
kN	mm		cm ²	cm ³		
▼ Single acting						
2,9	18,5	LUCS-32	1,23	2,27	LCAS-32	LCAL-32
7,8	23,4	LUCS-82	3,10	7,28	LCAS-82	LCAL-82
11,8	29,7	LUCS-122	4,13	12,59	LCAS-122	LCAL-122
18,7	34,5	LUCS-192	6,39	22,67	LCAS-192	LCAL-192
27,2	44,7	LUCS-282*	9,61	45,18	LCAS-282	LCAL-282
▼ Double acting						
3	18,5	LUCD-32	1,23	2,27	LCAS-32	LCAL-32
8	23,5	LUCD-82	3,10	7,28	LCAS-82	LCAL-82
12	29,7	LUCD-122	4,13	12,59	LCAS-122	LCAL-122
19	34,5	LUCD-192	6,39	22,67	LCAS-192	LCAL-192
28	44,7	LUCD-282*	9,61	45,18	LCAS-282	LCAL-282

Contact Enerpac for models with imperial threads and SAE ports.

* This product is made to order. Please contact Enerpac for delivery information before specifying in your design.

Dimensions in mm []

Model number	Port Size	C1	C2	C3	D	D1	D2	E
▼ Single acting								
LUCS-32	1/8" BSPP	27,9	36,6	55,1	M48 x 1,5	62,0	55,9	27,9°
LUCS-82	1/8" BSPP	30,0	41,4	65,0	M65 x 1,5	82,0	70,1	31,1°
LUCS-122	1/4" BSPP	37,1	49,5	79,2	M80 x 2	102,1	87,9	28,5°
LUCS-192	1/4" BSPP	39,9	58,4	93,0	M90 x 2	119,1	102,1	28,3°
LUCS-282*	1/4" BSPP	50,0	66,0	110,7	M105 x 2	134,9	119,9	24,8°
▼ Double acting								
LUCD-32	1/8" BSPP	27,9	36,6	55,1	M48 x 1,5	62,0	55,9	27,9°
LUCD-82	1/8" BSPP	30,0	41,4	65,0	M65 x 1,5	82,0	70,1	31,1°
LUCD-122	1/4" BSPP	37,1	49,5	79,2	M80 x 2	102,1	87,9	28,5°
LUCD-192	1/4" BSPP	39,9	58,4	93,0	M90 x 2	119,1	102,1	28,3°
LUCD-282*	1/4" BSPP	50,0	66,0	110,7	M105 x 2	134,9	119,9	24,8°

Contact Enerpac for models with imperial threads and SAE ports.

* This product is made to order. Please contact Enerpac for delivery information before specifying in your design.

Installation dimensions in mm

Clamp ¹⁾ force kN	Fixture hole Ø D3	Mounting thread J	Min. depth J2	Manifold O-ring ²⁾ ARP No. or Inside Ø x thickness
3	48,3	M6 x 1,0	16,5	-010
8	65,3	M8 x 1,0	19,0	-010
12	80,3	M8 x 1,0	19,0	-010
19	90,5	M10 x 1,25	22,5	-010
28	105,5	M12 x 1,25	24,0	-010

¹⁾ With standard clamp arm.
²⁾ Polyurethane, 92 Durometer

Note: Mounting bolts and O-rings included.

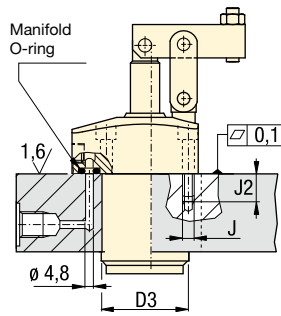

all models

Dimensions shown with standard clamp arm.

Double acting:

- A** = Clamp
- B** = Unclamp

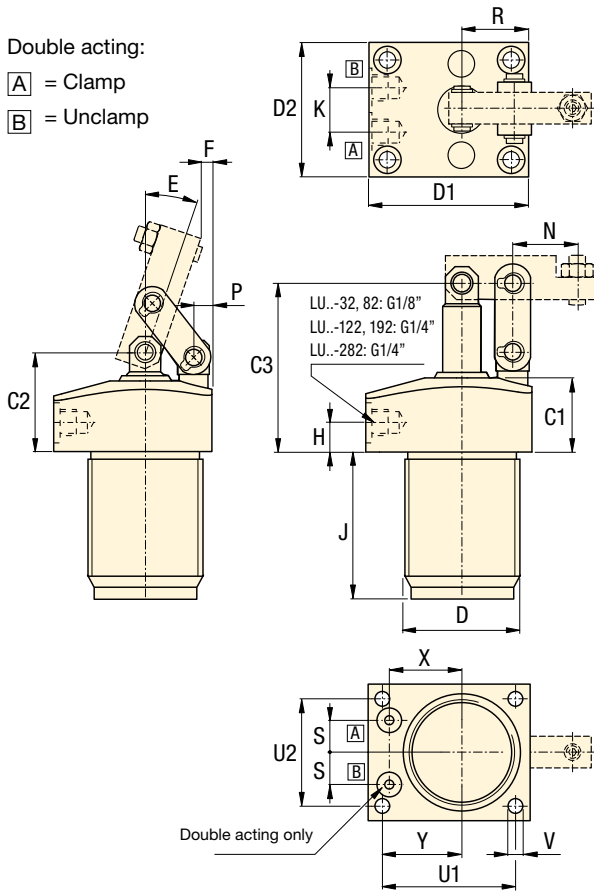

	F	H	J	K	N	P	R	S	U1	U2	V Ø	X	Y	kg
Single acting ▼														
1,0	10,9	47,0	-	23,6	8,4	27,9	10,4	52,1	46,0	6,6	28,7	29,0	1,2	
5,1	10,9	63,0	-	31,8	8,9	35,1	14,0	68,1	55,9	8,1	38,5	39,9	2,5	
0,8	11,9	71,1	-	37,6	11,9	43,9	16,1	87,9	73,9	8,1	44,2	51,1	4,5	
0,8	15,0	87,9	-	41,4	15,0	51,1	18,1	101,1	82,0	10,4	49,8	58,9	6,9	
2,0	20,1	99,1	-	51,1	16,0	59,9	20,9	115,1	100,1	13,0	57,3	65,0	11,7	
Double acting ▼														
1,0	10,9	47,0	20,1	23,6	8,4	27,9	21,6	52,1	46,0	6,6	20,5	29,0	1,2	
5,1	10,9	63,0	23,9	31,8	8,9	35,1	25,4	68,1	55,9	8,1	30,3	39,9	2,5	
0,8	11,9	71,1	30,0	37,6	11,9	43,9	26,4	87,9	73,9	8,1	37,7	51,1	5,0	
0,8	15,0	87,9	-	41,4	15,0	51,1	28,2	101,1	82,0	10,4	48,9	58,9	6,9	
2,0	20,1	99,1	38,1	51,1	16,0	59,9	30,0	115,1	100,1	13,0	52,0	65,0	11,7	

Clamp force: 2,9 - 28 kN

Stroke: 18,5 - 44,7 mm

Pressure: 35 - 350 bar

- E** Cilindros Amarre de enlace
- F** Bride basculante
- D** Gelenkspanner

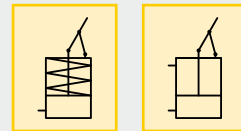

Options

Clamp arms

57 ▶



Work supports

43 ▶



Important

Single-acting cylinders use a regenerative circuit; oil is sent to both sides of the piston at the same time. This eliminates the breather port, reducing damage from coolant and contamination.

Clamp arm should be parallel to cylinder mounting surface within 3° to avoid damage to cylinder and linkage. Use the included set screw to adjust clamp arm alignment.

Clamp arms for link clamps

Shown: LCAS-32



Standard arms are readily available from Enerpac to meet most applications. In applications that require a custom designed arm, the machining information is supplied on page 57.

Important

Clamp point must be within the boundaries of the anchor links on the clamp. Clamping outside of this area will cause damage to the linkage, leading to premature failure.

Allowable clamping area

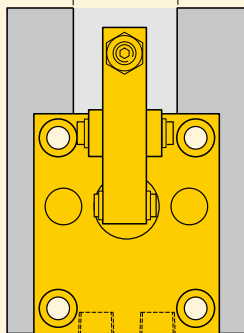

Standard or custom built

- Available from Enerpac in standard or extended length
- Standard arm includes set screw and lock nut
- Long arm is machinable
- Make your own custom arm to suit specific applications.

Pressure vs clamping force

Different length clamp arms will determine the amount of clamping force transferred to the workpiece. As the length increases, the clamping force decreases.

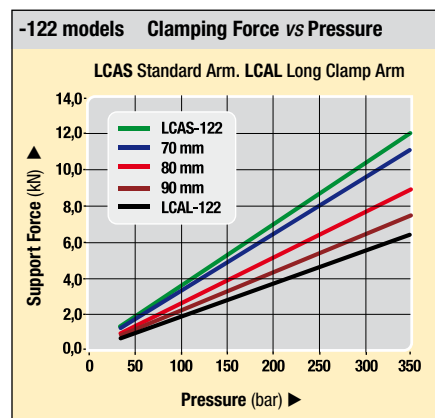
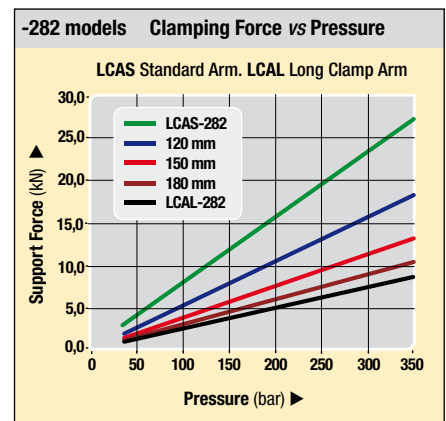
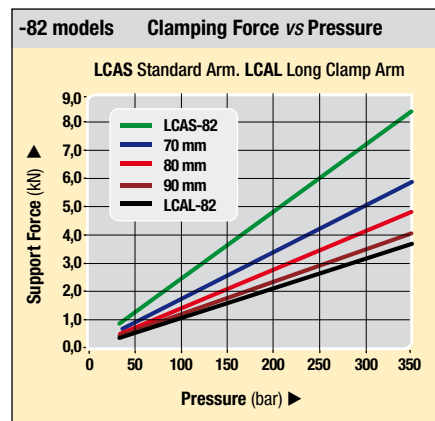
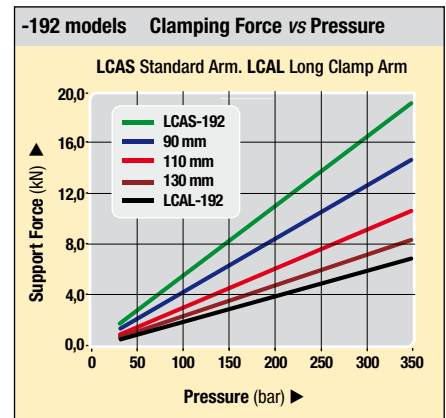
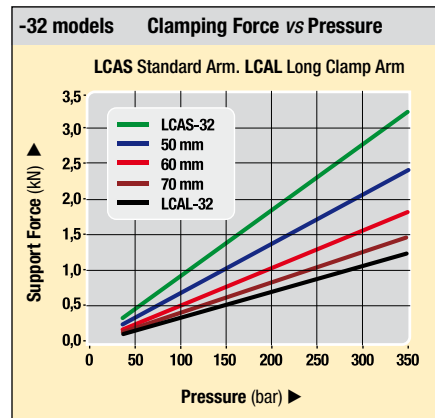

LCAS models Standard Arm

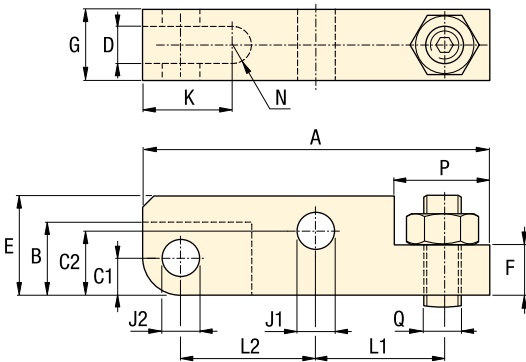

Dimensions in mm []

Clamp capacity kN	Model number	A	B	C1	C2	D	E	F	G
▼ Standard clamp arms									
3	LCAS-32	54,0	13,0	6	9,5	6	16	8	11,85
8	LCAS-82	74,5	17,5	8	15,5	10	25	13	18,85
12	LCAS-122	87,5	22,0	10	19,5	11	32	16	21,85
19	LCAS-192	102,5	26,0	11	24,0	13	38	22	24,85
28	LCAS-282	125,0	30,5	13	29,0	16	45	27	31,85

Clamp. capacity kN	Model number	J1	J2	K	L1	L2	N	P	Q
▼ Standard clamp arms									
3	LCAS-32	6,02-6,07	6,02-6,07	13	23,5	18,5	3	13	M6 x 1,0
8	LCAS-82	10,05-10,10	8,05-8,10	16	32,0	24,5	5	22	M10 x 1,5
12	LCAS-122	12,05-12,10	10,05-10,10	20	37,5	30,0	5,5	25	M12 x 1,75
19	LCAS-192	15,05-15,10	12,05-12,10	24	41,5	36,0	6,5	31	M16 x 2,0
28	LCAS-282	18,05-18,10	15,05-15,10	28	51,0	44,0	8	38	M20 x 2,5

LCAL models Long Arm

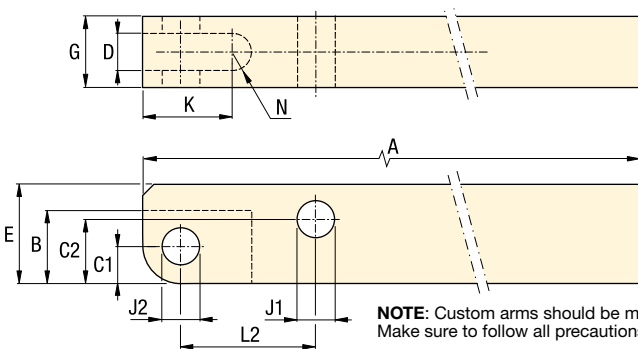

NOTE: Custom arms should be manufactured using this print. Make sure to follow all precautions listed.

Dimensions in mm []

Clamp. capacity kN	Model number	A	B	C1	C2	D	E	G	J1	J2	K	L2	N
▼ Long clamp arms													
3	LCAL-32	85	13,0	6	9,50	6	16	11,85	6,02-6,07	6,02-6,07	13	18,5	3,0
8	LCAL-82	105	17,5	8	15,50	10	25	18,85	10,05-10,10	8,05-8,10	16	24,5	5,0
12	LCAL-122	110	22,0	10	19,50	11	32	21,85	12,05-12,10	10,05-10,10	20	30,0	5,5
19	LCAL-192	160	26,0	11	24,00	13	38	24,85	15,05-15,10	12,05-12,10	24	36,0	6,5
28	LCAL-282	220	30,5	13	29,00	16	45	31,85	18,05-18,10	15,05-15,10	28	44,0	8,0

Force: 3 - 28 kN

Pressure: 35 - 350 bar

- E** Brazos de amarre
- F** Bras de bridage
- D** Spannarme

Options

Work supports [43 ▶](#)

Accessories [86 ▶](#)

Important

Clamp arm should be parallel to cylinder mounting surface within 3° to avoid damage to cylinder and linkage. Use the included set screw to adjust clamp arm alignment.

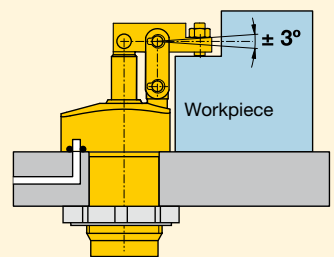

Pull cylinders *Application & selection*

Shown: PLSS-121, PUSD-121



Pull cylinders

Hydraulic pull cylinders utilize hydraulic pressure to hold down parts in a fixture. The guided plunger maintains orientation during the full clamping cycle, eliminating the need for an external guide. Internally threaded plunger ends accept various custom attachments to assist in the clamping process.

Energac offers both single- and double-acting pull cylinders, with capacities ranging from 5,6 to 43,5 kN for pulling and 13,3 to 81,9 kN for pushing applications.

■ *Hydraulic fixture with pull and swing cylinders, manifold and threaded cylinders for positioning and holding the work piece during milling process of gun breeches.*

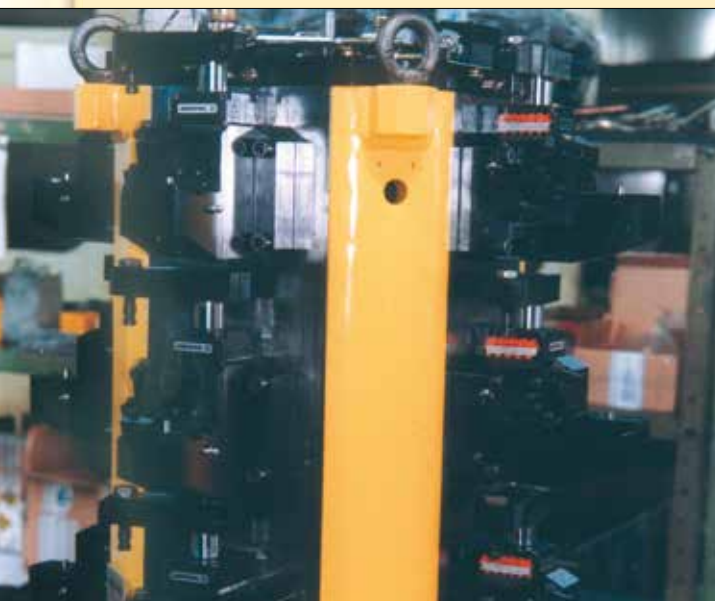

Compact and full featured design

- Guided linear plunger movement
- Compact design allows for efficient fixture layout
- Variety of mounting styles to meet design needs
- Internal plunger thread and flats across plunger top allow easy mounting of attachments
- Choice of porting styles to meet system and design requirements
- Single- and double-acting cylinders to suit a variety of hydraulic requirements.

Select your pull cylinder type:

Single acting

- The obvious choice when there are few system restrictions, and there are not many units retracting simultaneously
- Valving and plumbing is less complex.

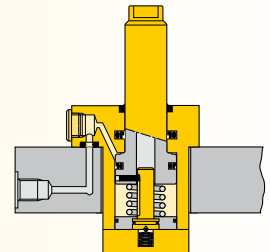

Double acting

- When greater control is required during the unclamp cycle
- When heavy attachments are being used
- When timing sequences are critical: less sensitive to system back pressures resulting from long tube lengths or numerous components being retracted at the same time.

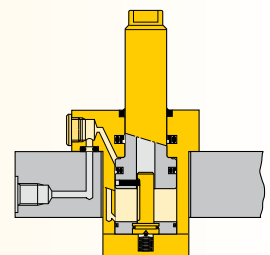

Select your mounting method:

PU series, Upper flange mounting

- Flexible design allows for manifold or threaded oil port connection
- Fixture hole does not require tight tolerances
- Easy installation with only 3 or 4 mounting bolts.

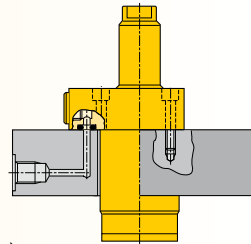

 60 ▶

PL series, Lower flange mounting

- Flexible design allows for manifold or threaded port connection
- No fixture hole required
- Easy installation with only 3 or 4 mounting bolts.

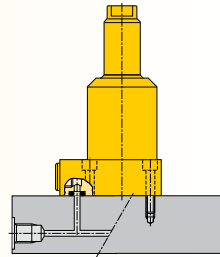

 62 ▶

PT series, Threaded body mounting

- Body thread for precise cylinder height positioning
- Threaded oil port connection
- Can be threaded directly into the fixture and secured in position by means of standard flange nuts.

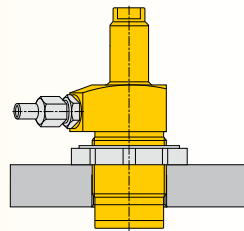

 64 ▶

Product selection

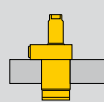
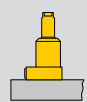
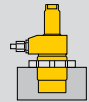
Cylinder capacity		Stroke	Upper flange	Lower flange	Threaded body
kN	mm	mm			
▼ Single acting					
5,6	–	22,6	PUSS-52	PLSS-52	PTSS-52
13,3	–	27,9	PUSS-121	PLSS-121	PTSS-121
▼ Double acting					
6,3	13,3	22,6	PUSD-52	PLSD-52	PTSD-52
11,2	28,0	22,1	PUSD-92	PLSD-92	PTSD-92
14,3	27,4	27,9	PUSD-121	PLSD-121	PTSD-121
43,5	81,9	30,5	PUSD-352	PLSD-352	PTSD-352

Note: - Call Enerpac to order models with imperial thread and SAE port connections.
- Pull forces for single-acting cylinders reduced due to spring force.

www.enerpacwh.com

Pull force: 5,6 - 43,5 kN

Push force: 13,3 - 81,9 kN

Stroke: 22,1 - 30,5 mm

Pressure: 35 - 350 bar

E Cilindros de tracción

F Verins traction

D Zugzylinder

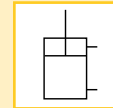
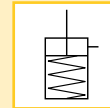

Options

Accessories

 86 ▶



Collet-Lok® push cylinders

 18 ▶



Work supports

 43 ▶



Swing cylinders

 22 ▶



Sequence valves

 152 ▶



Pull cylinders - Upper flange models

Shown: PUSS-52, PUSD-121



PU series

Upper flange pull cylinders are designed for integrated manifold mounting solutions.

Hydraulic connections are made through SAE or BSPP oil connection or the standard integrated O-ring ports.

Oil connection

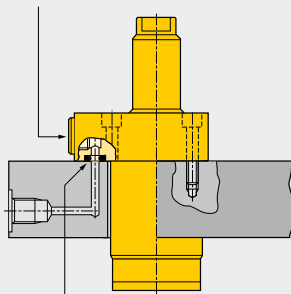

Integrated O-ring port

■ *Energac upper flange pull cylinders in a fixture for gun breech production.*



Minimal mounting height

...when space is at a premium

- Guided linear plunger movement
- Flexible design allows for manifold or threaded port connection
- Low profile mounting style allows body to be below mounting surface
- Internal plunger thread allows easy mounting of attachments
- Simple mounting preparation
- Easy to machine fixture hole: does not require tight tolerances
- Easy assembly: 3 or 4 mounting bolts
- Double oil connection: threaded port or manifold mount.

Product selection

Cylinder capacity		Stroke mm	Model number	Cylinder effective area		Oil capacity	
Pull kN	Push kN			Pull cm ²	Push cm ²	Pull cm ³	Push cm ³
▼ Single acting							
5,6	–	22,6	PUSS-52	1,81	–	4,10	–
13,3	–	27,9	PUSS-121	4,06	–	11,47	–
▼ Double acting							
6,3	13,3	22,6	PUSD-52	1,81	3,81	4,10	8,69
11,2	28,0	22,1	PUSD-92	3,16	8,06	6,88	17,70
14,3	27,4	27,9	PUSD-121	4,06	7,94	11,47	22,94
43,5	81,9	30,5	PUSD-352	12,39	23,74	37,20	71,28

Note: - Call Energac to order models with SAE oil connections.
- Pull forces for single-acting cylinders reduced due to spring force.

Dimensions in mm []

Model number	A	B	C1	D	D1	D2	E	E1	F	H
				∅			∅	∅		
▼ Single acting										
PUSS-52	128,8	106,2	24,9	34,8	54,1	57,2	16,0	15,0	13,0	14,0
PUSS-121	160,3	132,3	25,4	47,5	66,5	73,2	22,1	20,8	17,3	15,5
▼ Double acting										
PUSD-52	128,8	106,2	24,9	34,8	54,1	57,2	16,0	15,0	13,0	14,0
PUSD-92	137,9	116,1	24,9	47,8	70,1	54,1	24,9	23,6	17,8	12,4
PUSD-121	160,3	132,3	25,4	47,5	66,5	73,2	22,1	20,8	17,3	15,5
PUSD-352	204,2	173,5	24,9	79,8	100,1	88,9	38,1	36,1	28,7	12,4

Installation dimensions in mm

Pull force kN	Fixture hole Ø D3	Mounting thread J	Min. depth J2	Manifold O-ring ¹⁾ ARP numbers or Inside Ø x thickness
6,3	35,3	M6 x 1	16,5	568-011
11,2	49,0	M6 x 1	15,0	4,32 x 3,53
14,3	48,0	.312-24 UNF	20,3	568-011
43,5	78,0	M10 x 1,25	18,8	4,32 x 3,53

¹⁾ O-ring material: polyurethane, 92 Durometer

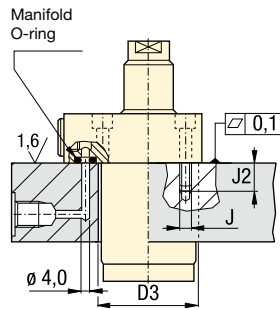

-52, 121

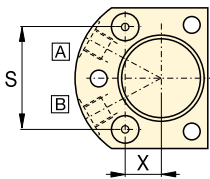
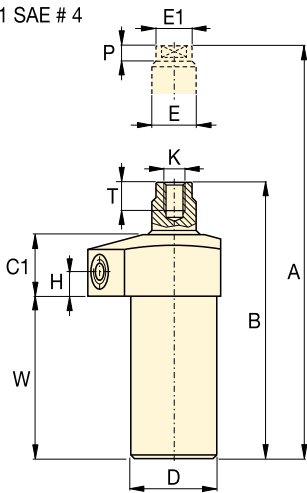
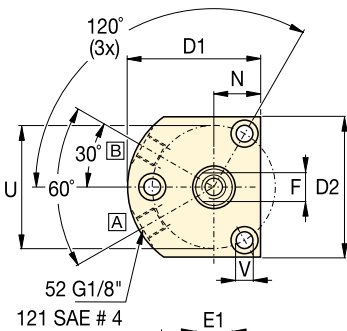

-92, -352

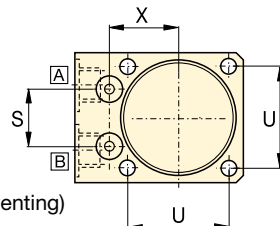
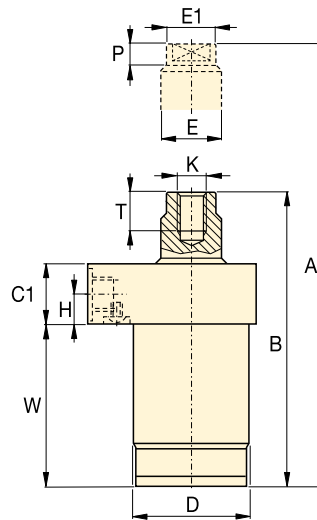
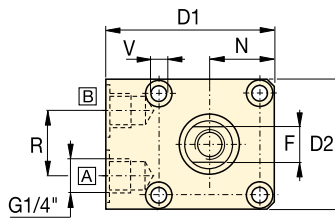

A = Pull
B = Push (venting)

Pull force: 5,6 - 43,5 kN

Push force: 13,3 - 81,9 kN

Stroke: 22,1 - 30,5 mm

Pressure: 35 - 350 bar

E Cilindros de tracción

F Verins traction

D Zugzylinder

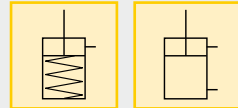

Options

Accessories  [86](#)

Collet-Lok® push cylinders  [18](#)

Swing cylinders  [22](#)

Sequence valves  [152](#)

Important

Single-acting cylinders can be vented through the manifold port.

The upper flange pull cylinder has a bolt pattern which is identical to its lower flange equivalent, enabling interchangeability.

In case there is a risk of machining coolants and debris being inhaled via the breather vent, it is recommended to pipe this port to an area outside the fixture that is protected from machining coolants and debris.

	K	N	P	R	S	T	U	V	W	X	kg	Model number
								Ø				
												Single acting ▼
	M8 x 1,25	19,1	5,8	-	41,0	15,7	50,0	6,9	66,0	14,4	1,1	PUSS-52
	.500-20 UNF	25,1	9,4	-	52,0	19,1	63,5	8,8	85,9	18,2	1,6	PUSS-121
												Double acting ▼
	M8 x 1,25	19,1	5,8	-	41,0	15,7	50,0	6,9	66,0	14,4	1,1	PUSD-52
	M10 x 1,5	26,4	10,4	25,9	23,7	16,0	41,9	6,6	75,9	28,7	2,0	PUSD-92
	.500-20 UNF	25,1	9,4	-	52,0	19,1	63,5	8,9	85,9	18,2	1,6	PUSD-121
	M16 x 2	43,4	13,0	25,9	34,8	31,0	70,1	10,9	96,5	41,6	5,6	PUSD-352

Pull cylinders - Lower flange models

Shown: PLSS-52, PLSS-121



PL series

The lower flange cylinders are designed for integrated manifold mounting solutions. Hydraulic connections are made through SAE or BSPP oil connection or the standard integrated O-ring ports.

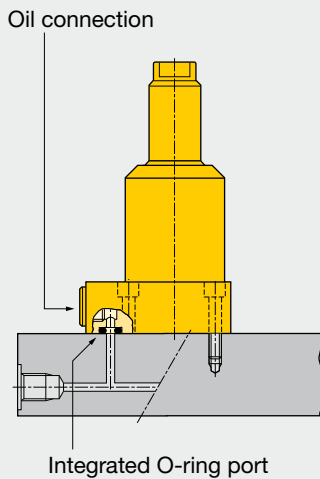

Minimal mounting height

...when space is at a premium

- Guided linear plunger movement
- Flexible design allows for manifold or threaded port connection
- Low profile mounting style allows body to be below mounting surface
- Internal plunger thread allows easy mounting of attachments
- Easiest mounting preparation in the line
- Easy to machine fixture hole: does not require tight tolerances
- Easy assembly: 3 or 4 mounting bolts
- Double oil connection: threaded port or manifold mount.

Product selection

Cylinder capacity		Stroke	Model number	Cylinder effective area		Oil capacity	
kN		mm		cm ²		cm ³	
Pull	Push			Pull	Push	Pull	Push
▼ Single acting							
5,6	–	22,6	PLSS-52	1,81	–	4,10	–
13,3	–	27,9	PLSS-121	4,06	–	11,47	–
▼ Double acting							
6,3	13,3	22,6	PLSD-52	1,81	3,81	4,10	8,69
11,2	28,0	22,1	PLSD-92	3,16	8,06	6,88	17,70
14,3	27,4	27,9	PLSD-121	4,06	7,94	11,47	22,94
43,5	81,9	30,5	PLSD-352	12,39	23,74	37,20	71,28

Note: - Call Enerpac to order models with SAE oil connections.
- Pull forces for single-acting cylinders reduced due to spring force.

Dimensions in mm []

Model number	A	B	C1	D	D1	D2	E	E1	F	H
					∅		∅	∅		
▼ Single acting										
PLSS-52	128,8	106,2	24,9	34,8	54,1	57,2	16,0	15,0	13,0	14,0
PLSS-121	160,3	132,3	25,4	47,5	66,5	73,2	22,1	20,8	17,3	15,5
▼ Double acting										
PLSD-52	128,8	106,2	24,9	34,8	54,1	57,2	16,0	15,0	13,0	14,0
PLSD-92	137,9	116,1	24,9	47,8	70,1	54,1	24,9	23,6	17,8	12,4
PLSD-121	160,3	132,3	25,4	47,5	66,5	73,2	22,1	20,8	17,3	15,5
PLSD-352	204,2	173,5	24,9	79,8	100,1	88,9	38,1	36,1	28,7	12,4

Installation dimensions in mm

Pull force kN	Mounting thread J	Minimum depth J2	Manifold O-ring ¹⁾ ARP numbers or inside Ø x thickness
6,3	M6 x 1	16,5	568-011
11,2	M6 x 1	15,0	4,32 x 3,53
14,3	M8 x 1	20,3	568-011
14,5	M10 x 1,25	18,8	4,32 x 3,53

¹⁾ O-ring material: polyurethane, 92 Durometer

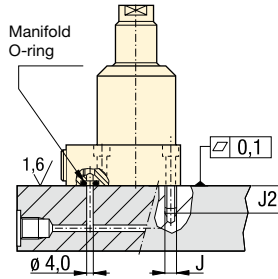

- Pull force: 5,6 - 43,5 kN**
- Push force: 13,3 - 81,9 kN**
- Stroke: 22,1 - 30,5 mm**
- Pressure: 35 - 350 bar**

- E** Cilindros de tracción
- F** Verins traction
- D** Zugzylinder

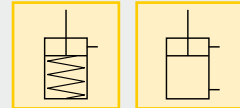

-52, -121

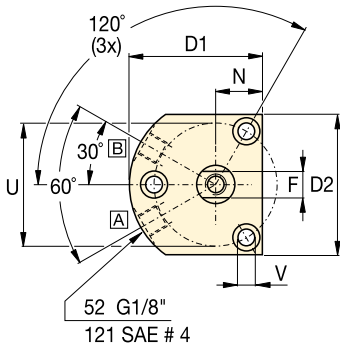

-352, -92

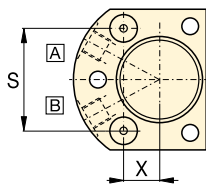
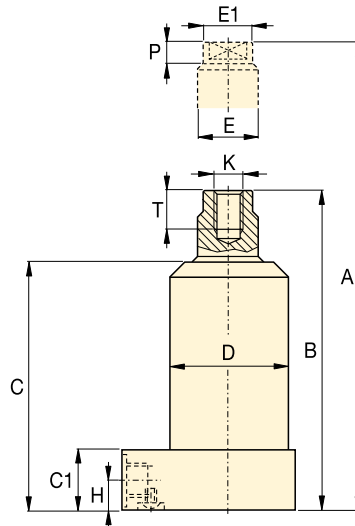
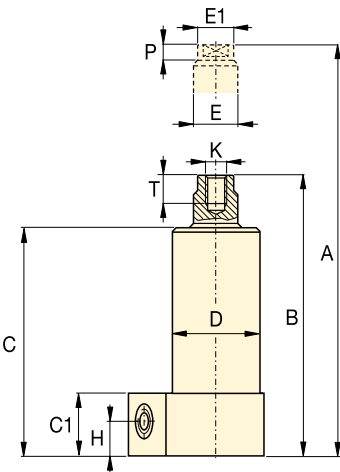
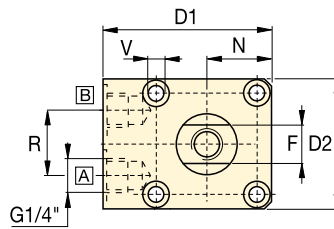

A = Pull
B = Push (venting)

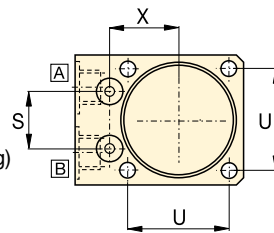

Options

Accessories 86 ▶

Collet-Lok® push cylinders 18 ▶

Swing cylinders 22 ▶

Sequence valves 152 ▶

Important

Single-acting cylinders can be vented through the manifold port.

The lower flange pull cylinder has a bolt pattern which is identical to its upper flange equivalent, enabling interchangeability.

In case there is a risk of machining coolants and debris being inhaled via the breather vent, it is recommended to pipe this port to an area outside the fixture that is protected from machining coolants and debris.

	K	N	P	R	S	T	U	V	W	X	kg	Model number
												Single acting ▼
	M8 x 1,25	19,1	5,8	-	41,0	15,7	50,0	6,9	66,0	14,4	1,1	PLSS-52
	.500-20 UNF	25,1	9,4	-	52,0	19,1	63,5	8,8	85,9	18,2	1,6	PLSS-121
												Double acting ▼
	M8 x 1,25	19,1	5,8	-	41,0	15,7	50,0	6,9	66,0	14,4	1,1	PLSD-52
	M10 x 1,5	26,4	10,4	25,9	23,7	16,0	41,9	6,6	75,9	28,7	1,6	PLSD-92
	.500-20 UNF	25,1	9,4	-	52,0	19,1	63,5	8,9	85,8	18,2	2,0	PLSD-121
	M16 X 2	43,4	12,9	25,9	34,4	31,0	70,1	10,9	96,5	41,6	5,6	PLSD-352

Pull cylinders - Threaded body models

Shown: PTSS-52, PTSD-121



PT series

The threaded body pull cylinders can be bolted to the fixture. This allows easy installation or removal of the unit and does not require machined fixture holes.

The cylinder is adjusted to the appropriate height, and then locked in place using a flange nut (□86).

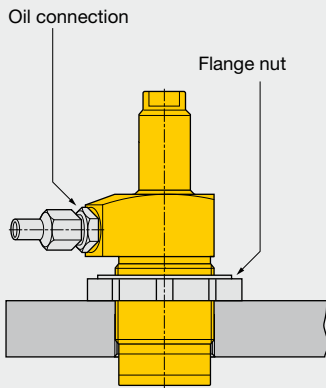

■ Threaded body pull cylinder with modified clamp arm, mounted on a frame-straightening fixture.



Threaded directly into the fixture

...can be secured at any height

- Guided linear plunger movement
- Threaded port connection
- Internal plunger thread allows easy mounting of attachments
- Simple mounting preparation
- Easy installation and removal
- Greatest flexibility in fixture design.

Product selection

Cylinder capacity		Stroke	Model number	Cylinder effective area		Oil capacity	
kN Pull	kN Push	mm		cm ² Pull	cm ² Push	cm ³ Pull	cm ³ Push
▼ Single acting							
5,6	-	22,6	PTSS-52	1,81	-	4,10	-
13,3	-	27,9	PTSS-121	4,06	-	11,47	-
▼ Double acting							
6,3	13,3	22,6	PTSD-52	1,81	3,81	4,10	8,69
11,2	28,0	22,1	PTSD-92	3,16	8,06	6,88	17,70
14,3	27,4	27,9	PTSD-121	4,06	7,94	11,47	22,94
43,5	81,9	30,5	PTSD-352	12,39	23,74	37,20	71,28

Note: - Call Enerpac to order models with SAE oil connections.
- Pull forces for single-acting cylinders reduced due to spring force.

Dimensions in mm []

Model number	A	B	C1	D	D1	D2	E
							Ø
▼ Single acting							
PTSS-52	128,8	106,2	24,9	M35 x 1,5	47,8	37,8	16,0
PTSS-121	160,3	132,6	25,4	1.875-16 UN	60,5	50,8	22,1
▼ Double acting							
PTSD-52	128,8	106,2	24,9	M35 x 1,5	47,8	37,8	16,0
PTSD-92	130,0	108,0	30,2	M48 x 1,5	62,7	48,3	24,9
PTSD-121	160,3	132,6	25,4	1.875-16 UN	60,5	50,8	22,1
PTSD-352	196,1	165,6	32,0	M80 x 2	88,4	80,0	38,1

Installation dimensions in mm

Pull force kN	Fixture hole thread size D3
6,3	M35 x 1,5
11,2	M48 x 1,5
14,3	1.875-16 UNF
43,5	M80 x 2

-52, 121

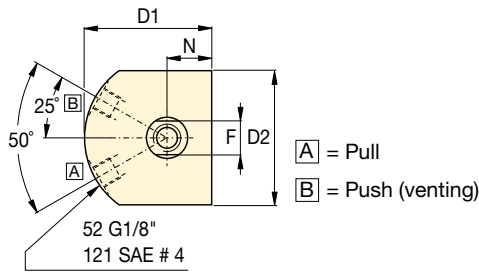

[A] = Pull
[B] = Push (venting)

-92, -352

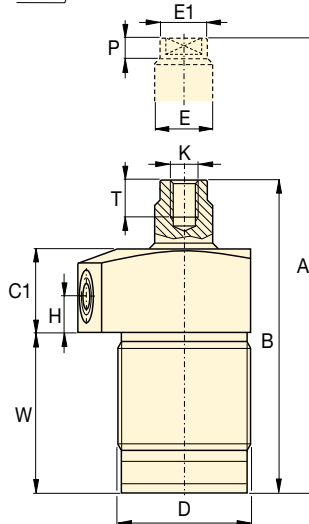
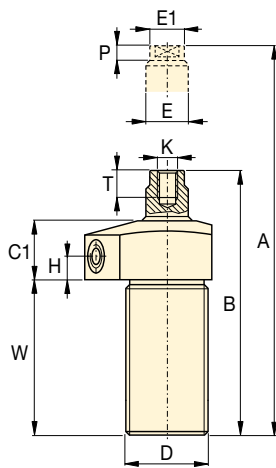
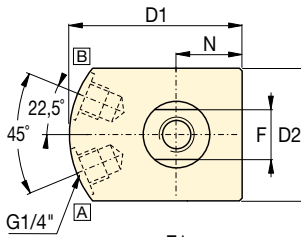
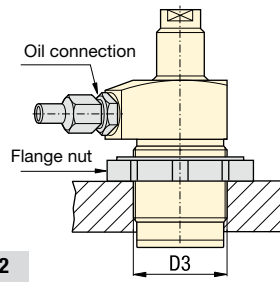

Accessory chart

Model number	Mounting flange Sold separately [87 ▶	Flange nut Sold separately [86 ▶
--------------	---	--

▼ Single acting

PTSS-52	MF-352	FN-352
PTSS-121	MF-481	FN-811

▼ Double acting

PTSD-52	MF-352	FN-352
PTSD-92	MF-482	FN-482
PTSD-121	MF-481	FN-481
PTSD-352	MF-802	FN-802

E1	F	H	K	N	P	T	W	kg	Model number
∅									
Single acting ▼									
15,0	13,0	9,7	M8 x 1,25	19,1	5,8	15,7	66,0	1,1	PTSS-52
20,8	17,3	9,7	.500-20 UNF	25,4	9,7	19,1	85,9	1,6	PTSS-121
Double acting ▼									
15,0	13,0	9,7	M8 x 1,25	19,1	5,8	15,7	66,0	1,1	PTSD-52
23,6	17,8	13,0	M10 x 1,5	24,1	10,4	16,0	62,7	2,0	PTSD-92
20,8	17,3	9,7	.500-20 UNF	25,4	9,7	19,1	85,9	1,6	PTSD-121
36,1	28,7	13,0	M16 x 2,00	39,9	13,0	31,0	81,8	4,7	PTSD-352

Pull force: 5,6 - 43,5 kN

Push force: 13,3 - 81,9 kN

Stroke: 22,1 - 30,5 mm

Pressure: 35 - 350 bar

E Cilindros de tracción

F Verins traction

D Zugzylinder

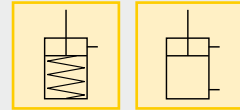

Options

Accessories

[86 ▶



Collet-Lok® swing cylinders

[18 ▶



Swing cylinders

[22 ▶



Sequence valves

[152 ▶



! Important

Single-acting cylinders can be vented through the manifold port.

In case there is a risk of machining coolants and debris being inhaled via the breather vent, it is recommended to pipe this port to an area outside the fixture that is protected from machining coolants and debris.

Threaded cylinders *Application & selection*

Shown: CST-10382, CST-572, CST18252, CDT-18132, CDT-40252



Threaded cylinders are designed for workpiece positioning, holding and ejecting applications where space is at a premium. Double-acting models are also suited to manufacturing applications, such as production punching.

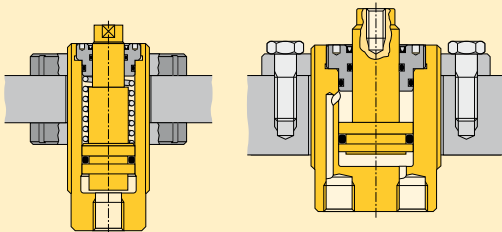

Accessory chart

Body thread D	Mounting flange Sold Separately 87 ▶	Flange nut Sold Separately 86 ▶	Plunger thread K	Contact bolt Sold Separately 86 ▶
M12 x 1,5	MF-122	FN-122	M4 x 0,7	BS-42
M20 x 1,5	MF-202	FN-202	M6 x 1	BS-62
M28 x 1,5	MF-282	FN-282	M8 x 1,25	BS-82
M30 x 1,5	-	FN-302	M10 x 1,5	BS-102
M35 x 1,5	MF-352	FN-352	M16 x 2	BS-162
M42 x 1,5	MF-422	FN-422	M20 x 2,5	BS-202
M48 x 1,5	MF-482	FN-482		
M55 x 1,5	MF-552	FN-552		
M65 x 1,5	MF-652	FN-652		
M80 x 2	MF-802	FN-802		

■ *Threaded cylinder, mounted with horizontal bracket to position the workpiece against the stops. Enerpac swing cylinders are then activated to clamp the work piece before machining operations begin.*



High clamping forces in a compact body

- Minimum cylinder diameter combined with maximized clamping forces
- Threaded body allows fine positioning and easy installation
- Internal plunger wipers allow maintenance-free, high-cycle performance
- Center-tapped plungers will hold workpiece contact buttons
- Single-acting models with spring return simplify hydraulic tubing requirements
- Double-acting models are recommended for high-cycle applications.

Product selection

Cylinder capacity at 350 bar kN	Stroke mm	Model number	Effective area cm ²		Oil capacity cm ³		
			push	pull	push	pull	
▼ Single acting							
1,7	-	7,3	CST-272	0,52	-	0,36	-
1,7	-	10,3	CST-2102	0,52	-	0,52	-
1,7	-	12,0	CST-2132	0,52	-	0,67	-
4,4	-	7,0	CST-572	1,29	-	0,82	-
4,4	-	13,0	CST-5132	1,29	-	1,64	-
4,4	-	18,8	CST-5192	1,29	-	2,46	-
4,4	-	25,0	CST-5252	1,29	-	3,11	-
4,4	-	37,4	CST-5382	1,29	-	4,75	-
11,3	-	8,6	CST-1072	3,32	-	2,32	-
11,3	-	13,0	CST-10132	3,32	-	4,31	-
11,3	-	19,0	CST-10192	3,32	-	6,30	-
11,3	-	26,8	CST-10252	3,32	-	8,29	-
11,3	-	38,0	CST-10382	3,32	-	12,60	-
17,2	-	13,0	CST-18132	5,10	-	6,63	-
17,2	-	25,0	CST-18252	5,10	-	12,74	-
17,2	-	38,0	CST-18382	5,10	-	19,37	-
17,2	-	50,0	CST-18502	5,10	-	25,48	-
26,9	-	15,0	CST-27152	7,88	-	11,82	-
26,9	-	25,0	CST-27252	7,88	-	19,70	-
26,9	-	50,0	CST-27502	7,88	-	39,40	-
39,2	-	14,6	CST-40132	11,36	-	14,76	-
39,2	-	26,6	CST-40252	11,36	-	28,39	-
39,2	-	39,6	CST-40382	11,36	-	43,15	-
39,2	-	51,6	CST-40502	11,36	-	56,78	-
▼ Double acting							
17,2	10,4	13,0	CDT-18132	5,10	3,03	6,63	3,94
17,2	10,4	25,0	CDT-18252	5,10	3,03	12,74	7,58
17,2	10,4	38,0	CDT-18382	5,10	3,03	19,37	11,52
17,2	10,4	50,0	CDT-18502	5,10	3,03	38,61	23,11
26,9	18,2	14,7	CDT-27152	7,87	5,29	11,81	7,94
26,9	18,2	24,7	CDT-27252	7,87	5,29	19,68	13,23
26,9	18,2	49,7	CDT-27502	7,87	5,29	39,35	26,45
39,2	26,1	13,0	CDT-40132	11,35	7,55	14,76	9,81
39,2	26,1	25,0	CDT-40252	11,35	7,55	28,39	18,87
39,2	26,1	38,0	CDT-40382	11,35	7,55	43,15	28,68
39,2	26,1	50,0	CDT-40502	11,35	7,55	56,77	37,74

Note: - Seal material: Buna-N, Polyurethane.
- Minimum operating pressure for single-acting models (to overcome return spring force) is 40 bar.

CST-2...., CST-5....

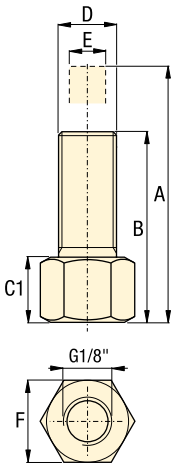

Other CST models

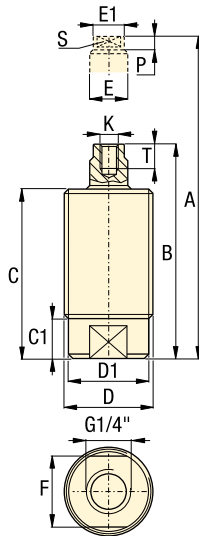

CDT models

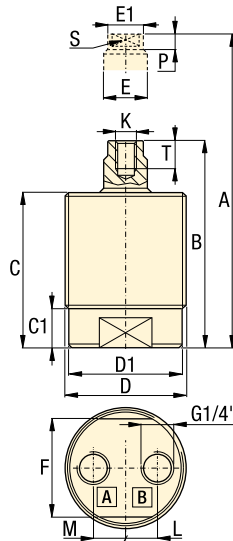

Force: 1,7 - 39,2 kN

Stroke: 7,3 - 51,6 mm

Pressure: 40 - 350 bar

- E** Cilindros roscados
- F** Vérins corps filetés
- D** Einschraubzylinder

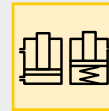

Options

Accessories

86 ▶



Product dimensions in mm []

Model number	A Ext. height	B Retr. height	C	C1	D	D1	E	E1	F	K	L	M	P	S	T	 kg
▼ Single acting																
CST-272	49,3	42,0	42,0	13,5	M12 x 1,5	-	4,8	-	16,0	-	-	-	-	-	-	0,1
CST-2102	52,8	42,8	42,8	14,3	M12 x 1,5	-	4,8	-	16,0	-	-	-	-	-	-	0,1
CST-2132	63,2	51,2	50,2	14,2	M12 x 1,5	-	4,8	-	16,0	-	-	-	-	-	-	0,1
CST-572	58,1	51,1	47,0	7,5	M20 x 1,5	17,7	7,9	7,0	15,9	M4 x 0,7	-	-	4,0	5,9	7,0	0,1
CST-5132	72,6	59,6	55,5	7,5	M20 x 1,5	17,7	7,9	7,0	15,9	M4 x 0,7	-	-	4,0	5,9	7,0	0,1
CST-5192	83,1	64,3	60,0	7,5	M20 x 1,5	17,7	7,9	7,0	15,9	M4 x 0,7	-	-	4,0	5,9	7,0	0,2
CST-5252	98,3	73,3	70,2	7,5	M20 x 1,5	17,7	7,9	7,0	15,9	M4 x 0,7	-	-	4,0	5,9	7,0	0,3
CST-5382	131,1	93,7	89,0	7,5	M20 x 1,5	17,7	7,9	7,0	15,9	M4 x 0,7	-	-	4,0	5,9	7,0	0,4
CST-1072	67,0	58,4	52,0	10,5	M28 x 1,5	26,0	11,9	11,0	24,0	M6 x 1	-	-	5,5	9,0	8,0	0,2
CST-10132	64,4	64,4	58,0	10,5	M28 x 1,5	26,0	11,9	11,0	24,0	M6 x 1	-	-	5,5	9,0	8,0	0,3
CST-10192	98,9	79,9	73,5	10,5	M28 x 1,5	26,0	11,9	11,0	24,0	M6 x 1	-	-	5,5	9,0	8,0	0,3
CST-10252	115,8	89,0	84,3	10,5	M28 x 1,5	26,0	11,9	11,0	24,0	M6 x 1	-	-	5,5	9,0	8,0	0,4
CST-10382	142,9	104,9	98,5	10,5	M28 x 1,5	26,0	11,9	11,0	24,0	M6 x 1	-	-	5,5	9,0	8,0	0,4
CST-18132	82,9	69,9	63,5	12,5	M35 x 1,5	32,5	16,0	15,0	30,0	M8 x 1,25	-	-	6,5	12,0	12,0	0,5
CST-18252	114,9	89,9	83,5	12,5	M35 x 1,5	32,5	16,0	15,0	30,0	M8 x 1,25	-	-	6,5	12,0	12,0	0,5
CST-18382	146,4	108,4	102,0	12,5	M35 x 1,5	32,5	16,0	15,0	30,0	M8 x 1,25	-	-	6,5	12,0	12,0	0,6
CST-18502	174,4	124,4	118,0	12,5	M35 x 1,5	32,5	16,0	15,0	30,0	M8 x 1,25	-	-	6,5	12,0	12,0	0,7
CST-27152	87,9	72,9	66,5	13,5	M42 x 1,5	39,8	18,0	17,0	36,0	M8 x 1,25	-	-	6,5	15,0	12,0	0,6
CST-27252	118,4	93,4	87,0	13,5	M42 x 1,5	39,8	18,0	17,0	36,0	M8 x 1,25	-	-	6,5	15,0	12,0	0,9
CST-27502	195,9	145,9	139,5	13,5	M42 x 1,5	39,8	18,0	17,0	36,0	M8 x 1,25	-	-	6,5	15,0	12,0	1,3
CST-40132	89,4	74,8	68,5	11,0	M48 x 1,5	45,4	19,9	19,0	41,4	M10 x 1,5	-	-	8,0	16,9	12,0	1,0
CST-40252	120,9	94,3	88,0	11,0	M48 x 1,5	45,4	19,9	19,0	41,4	M10 x 1,5	-	-	8,0	16,9	12,0	1,1
CST-40382	164,9	125,3	119,0	11,0	M48 x 1,5	45,4	19,9	19,0	41,4	M10 x 1,5	-	-	8,0	16,9	12,0	1,5
CST-40502	188,6	137,0	130,7	11,0	M48 x 1,5	45,4	20,0	19,0	41,4	M10 x 1,5	-	-	8,0	16,9	12,0	1,7
▼ Double acting																
CDT-18132	81,0	68,0	61,5	16,0	M48 x 1,5	45,7	15,8	15,0	41,0	M8 x 1,25	12,8	12,8	6,5	12,7	12,0	1,0
CDT-18252	107,0	82,0	75,5	16,0	M48 x 1,5	45,7	15,8	15,0	41,0	M8 x 1,25	12,8	12,8	6,5	12,7	12,0	1,3
CDT-18382	131,5	93,5	87,0	16,0	M48 x 1,5	45,7	15,8	15,0	41,0	M8 x 1,25	12,8	12,8	6,5	12,7	12,0	1,5
CDT-18502	155,5	105,5	99,0	16,0	M48 x 1,5	45,7	15,8	15,0	41,0	M8 x 1,25	12,8	12,8	6,5	12,7	12,0	1,7
CDT-27152	85,7	71,0	64,5	17,0	M55 x 1,5	52,7	17,9	17,0	46,0	M8 x 1,25	16,0	10,0	6,5	15,8	12,0	1,1
CDT-27252	106,7	82,0	75,5	17,0	M55 x 1,5	52,7	17,9	17,0	46,0	M8 x 1,25	16,0	10,0	6,5	15,8	12,0	1,4
CDT-27502	156,7	107,0	100,5	17,0	M55 x 1,5	52,7	17,9	17,0	46,0	M8 x 1,25	16,0	10,0	6,5	15,8	12,0	1,8
CDT-40132	91,5	78,5	70,5	17,5	M65 X 1,5	60,5	21,9	21	54,9	M10 x 1,5	19,5	10,5	8,0	16,9	15,0	1,8
CDT-40252	115,5	90,5	82,5	17,5	M65 x 1,5	60,5	21,9	21,0	54,9	M10 x 1,5	19,5	10,5	8,0	16,9	15,0	2,0
CDT-40382	141,5	103,5	95,5	17,5	M65 x 1,5	60,5	21,9	21,0	54,9	M10 x 1,5	19,5	10,5	8,0	16,9	15,0	2,5
CDT-40502	175,0	125,0	117,0	17,5	M65 x 1,5	60,5	21,9	21,0	54,9	M10 x 1,5	19,5	10,5	8,0	16,9	15,0	3,0

Threaded cylinders *Application & selection*

Shown: WRT-22, CYDA-15, WMT-39



▶ Threaded cylinders for workpiece positioning, holding and ejecting applications where space is at a premium. The advance and retract mode of double-acting models allow installation of clamping accessories to the plunger for pull and push action. Cylinders can be mounted with horizontal bracket to position the workpiece against the stops. Ideal for supporting or positioning a part.

Fine positioning and convenient installation

...can be fixtured into manual strap or bridge clamp assemblies

- Maximum clamping force in a compact design
- Threaded body allows exact positioning and easy installation
- Center-tapped plungers allow a variety of attachments
- Single-acting spring return models simplify hydraulic tubing requirements
- Double-acting models are ideal for applications requiring powered pulling or fast automated control
- Removable base allows CYDA-15 to be threaded into a custom manifold.

i Single or Double acting

Single acting

- The obvious choice when there are few system restrictions, and there are not many units retracting simultaneously
- Fewer valving requirements which results in a less complex circuit.

Double acting

- Used when greater control is required during the unclamp cycle
- When timing sequences are critical
- Less sensitive to system back pressures, resulting from long tube lengths or numerous components being retracted at the same time.

globe Product selection

Cylinder capacity at maximum pressure		Stroke mm	Model number	Effective area		Oil capacity		Operating pressure bar
kN push	kN pull			cm ² push	cm ² pull	cm ³ push	cm ³ pull	
▼ Single acting								
17,4	–	12,7	WRT-21	5,10	–	0,33	–	40-350
17,4	–	25,4	WRT-22	5,10	–	0,66	–	40-350
▼ Double acting								
5,3	2,7	39,6	CYDA-15	2,65	1,29	10,16	5,08	10-210
17,4	12,0	11,9	WMT-39	5,10	3,48	6,39	4,42	10-350
17,4	12,0	24,9	WMT-40	5,10	3,48	12,95	8,85	10-350

Note: - Seal material CYDA-15: Buna-N, Polyurethane
- Seal material WMT and WRT series: Buna-N, Polyurethane, Teflon.

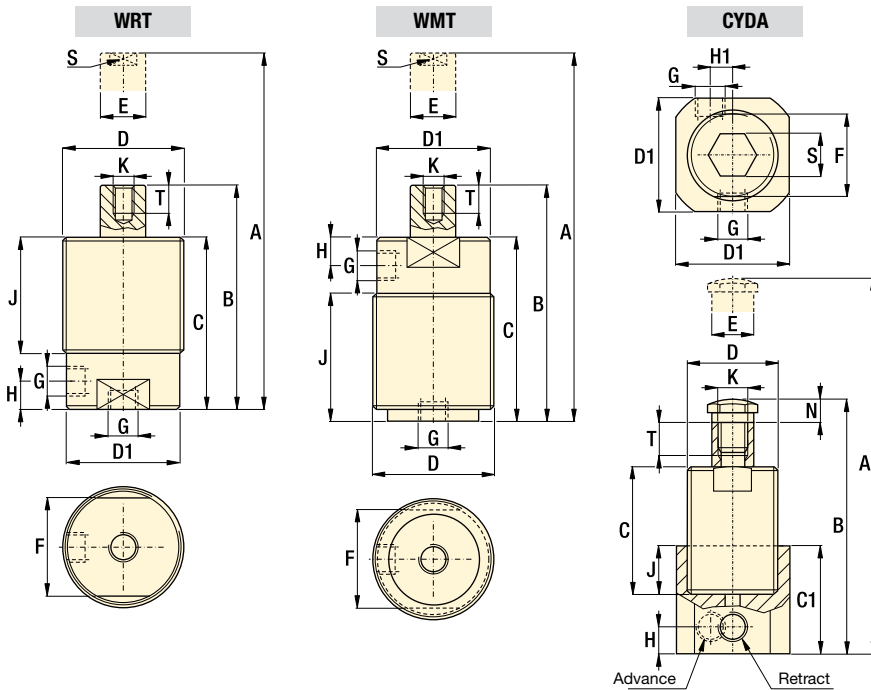

Manifold dimensions using CYDA-15 without base

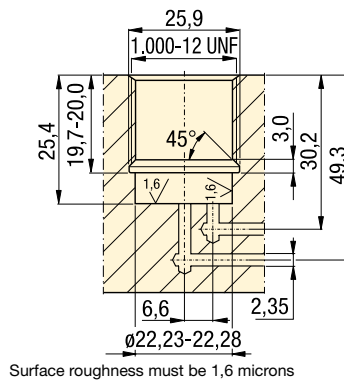

Force: 5,3 - 17,4 kN

Stroke: 11,9 - 39,6 mm

Pressure: 10 - 350 bar

- E** Cilindros roscados
- F** Vérins corps filetés
- D** Einschraubzylinder

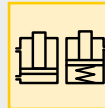

Accessory chart

Body Thread	Mounting Flange	Flange Nut	Plunger Thread	Contact Bolt
D	Sold separately	Sold separately	K	Sold separately
1.000-12 UN	MF-251	FN-251	0.250-28 UN	BS-61
1.375-18 UN	MF-351	FN-351	0.313-24 UN	BS-81

Options

Cylinder accessories

86 ▶



Important

Apply Loctite 222 or equivalent to threads and torque CYDA-15 in cavity to 8-11 Nm. Cavity must be designed to withstand hydraulic forces.

Product dimensions in mm []

Model number	A	B	C	C1	D	D1	E	F	G	H	H1	J	K	N	S	T	kg
							ø	ø					UNF				
▼ Single acting																	
WRT-21	95,3	82,6	74,9	-	1.375-18 UNEF	31,2	19,1	26,9	SAE #2	15,7	-	50,8	.250-28	-	12,7	8,1	0,5
WRT-22	120,7	95,3	87,6	-	1.375-18 UNEF	31,2	19,1	26,9	SAE #2	15,7	-	63,5	.250-28	-	12,7	8,1	0,6
▼ Double acting																	
CYDA-15	151,9	112,3	80,1	44,5	1.000-12 UNF	31,8	12,7	22,1	1/8" NPTF	9,7	5,1	25,4	.313-24	7,9	12,7	10,4	0,5
WMT-39	95,0	83,1	76,0	-	1.375-18 UNEF	33,0	14,2	26,9	1/8" NPTF	18,5	-	52,1	.250-28	-	11,9	9,9	0,5
WMT-40	120,9	96,0	88,9	-	1.375-18 UNEF	33,0	14,2	26,9	1/8" NPTF	18,5	-	65,0	.250-28	-	11,9	9,9	0,5

Manifold cylinders *Application & selection*

Shown: CSM-10132, CSM-572, CSM-18252



▶ These compact, fixture-integrated cylinders are designed for workpiece positioning, holding and ejecting applications where space is at a premium. No exposed tubing.

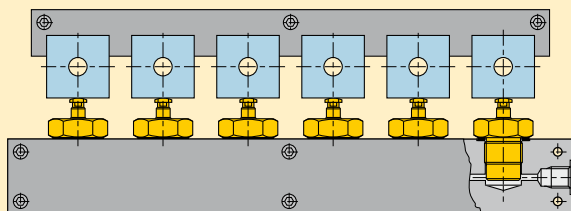

Six CSM series manifold cylinders are used to clamp piston blocks for machining. The hydraulic flow to the cylinders is side-ported in order to minimize the required manifold thickness.

■ Threaded cylinders are used here to position engine manifolds for drilling, tapping and mill finish.



Compact, fixture-integrated positioning and holding

- Design eliminates the need for fittings and tubing, minimizing space requirements and facilitating easy removal of chips and dirt
- Minimal cylinder height enables extremely compact fixture designs
- High-strength bodies and internal plunger wipers allow maintenance-free, high cycle performance
- Center-tapped plungers will hold workpiece contact buttons.

Manifold mount

Manifold cylinders are designed to be screwed directly into a manifold or fixture. Enerpac's manifold cylinders include a steel washer and O-ring providing an effective seal between the cylinder and manifold.

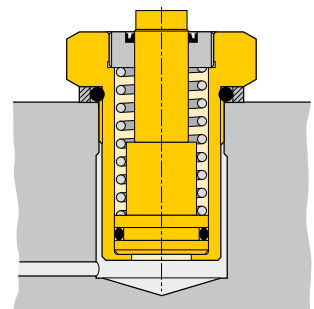

Product selection

Cylinder capacity at 350 bar	Stroke	Model number	Effective area	Oil capacity
kN	mm		cm ²	cm ³
1,7	7	CSM-272	0,5	0,4
1,7	13	CSM-2132	0,5	0,7
5,3	7	CSM-572	1,6	1,1
5,3	13	CSM-5132	1,6	2,0
11,3	7	CSM-1072	3,3	2,3
11,3	13	CSM-10132	3,3	4,3
11,3	19	CSM-10192	3,3	6,3
17,2	13	CSM-18132	5,1	6,6
17,2	25	CSM-18252	5,1	12,7
26,9	15	CSM-27152	7,9	11,8
26,9	25	CSM-27252	7,9	19,7

Note: - Seal material: Buna-N, Polyurethane.

Installation dimensions in mm []

Model number	D Thread	D2 min. ϕ	L min.
CSM-272	M12 x 1,5	11	22
CSM-2132	M12 x 1,5	11	33
CSM-572	M20 x 1,5	13	28
CSM-5132	M20 x 1,5	13	37
CSM-1072	M28 x 1,5	16	28
CSM-10132	M28 x 1,5	16	35
CSM-10192	M28 x 1,5	16	44
CSM-18132	M36 x 1,5	19	39
CSM-18252	M36 x 1,5	19	58
CSM-27152	M42 x 1,5	19	40
CSM-27252	M42 x 1,5	19	58

Note: - O-rings included.

Installation dimensions

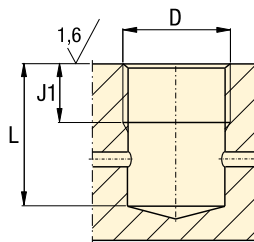

Force: 1,7 - 26,9 kN

Stroke: 7 - 25 mm

Pressure: 40 - 350 bar

- E** Cilindros para colector
- F** Vérins pour bloc foré
- D** Einbaucylinder



Accessory chart

Plunger Thread K	Contact Bolt
M4 x 0,7	BS-42
M6 x 1	BS-62
M8 x 1,25	BS-82

Options

Contact bolts 86

Important

Tighten manifold cylinders according to specifications in the instruction sheet.

Return springs in single-acting cylinders should not be used to pull back heavy attachments.

CSM-272, 2132

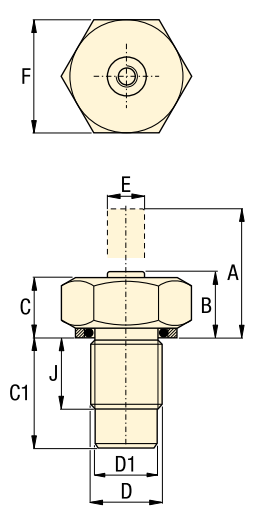

other models

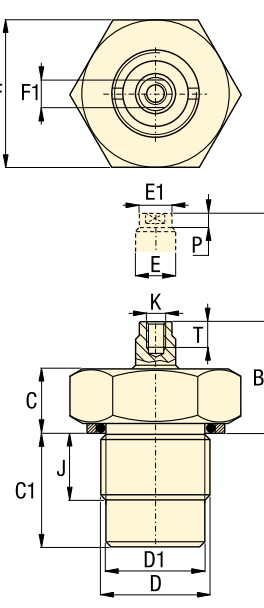

Product dimensions in mm []

Model number	A Ext. height	B Retr. height	C	C1	D	D1	E	E1	F	F1	J	K	P	T	kg
CSM-272	20,5	13,5	13,3	21,7	M12 x 1,5	10,1	4,8	-	19	-	11,4	-	-	-	0,1
CSM-2132	24,4	11,4	11,2	32,2	M12 x 1,5	10,1	4,8	-	19	-	11,4	-	-	-	0,1
CSM-572	23,5	16,5	12,5	27,5	M20 x 1,5	17,5	7,9	7	27	5,9	12,5	M4 x 0,7	4,0	7	0,2
CSM-5132	29,5	16,5	12,5	36,0	M20 x 1,5	17,5	7,9	7	27	5,9	12,5	M4 x 0,7	4,0	7	0,3
CSM-1072	27,3	20,3	14,8	27,1	M28 x 1,5	25,6	11,9	11	36	9,0	14,1	M6 x 1	5,5	8	0,5
CSM-10132	33,3	20,3	14,8	33,1	M28 x 1,5	25,6	11,9	11	36	9,0	14,1	M6 x 1	5,5	8	0,6
CSM-10192	39,3	20,3	14,8	48,6	M28 x 1,5	25,6	11,9	11	36	9,0	14,1	M6 x 1	5,5	8	0,7
CSM-18132	36,2	23,2	16,8	36,6	M36 x 1,5	34,2	15,9	15	46	12,0	18,1	M8 x 1,25	6,5	12	0,5
CSM-18252	48,2	23,2	16,8	56,1	M36 x 1,5	34,2	15,9	15	46	12,0	18,1	M8 x 1,25	6,5	12	0,6
CSM-27152	42,2	27,2	20,8	37,5	M42 x 1,5	39,7	17,9	17	55	15,0	16,9	M8 x 1,25	6,5	12	0,7
CSM-27252	52,8	27,8	21,3	56,0	M42 x 1,5	39,7	17,9	17	55	15,0	16,9	M8 x 1,25	6,5	12	0,9

Block cylinders *Application & selection*

Shown: BD-18202, BMD-70502, BD-40252



BD, BMD, BMS, BS-series

Block cylinders are used for punching, pressing, riveting and bending applications. In general, these cylinders are used for moving, positioning, lifting, opening and closing.

■ The versatile Enerpac block cylinders, fixture mounted for clamping applications.



Versatile, all purpose cylinder

- Six clamping capacities enable you to choose the right size for your application
- Variety of strokes, to meet design needs
- Double acting and single acting (spring return), allows selection of cylinder that best conforms to your hydraulic system
- Two oil connection possibilities:
 - with BSPP threaded oil ports
 - with manifold O-ring ports
- Compact cylinder design does not require large amounts of space on your fixture
- Integral wiper ring, keeps contaminants out of cylinder to extend life
- Designed according ISO-standards.

Select your block cylinder type:

BMS, BS series, single-acting

- BS series with BSPP oil port
- BMS series with manifold O-ring ports
- Internal threaded plunger
- Nickel-plated plunger
- Strong return spring
- Black oxide base
- Filtered vent plug.

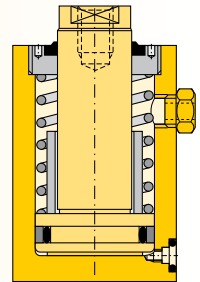

BMD, BD series, double-acting

- BD series with BSPP oil port
- BMS series with manifold O-ring ports
- Internal threaded plunger
- Nickel-plated plunger
- Black oxide base.

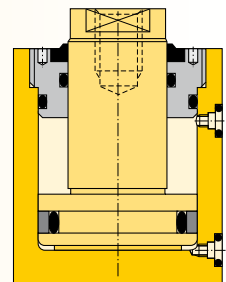

Application example

Block cylinder positions workpiece against fixed point with further clamping coming from an Enerpac swing cylinder.

Spherical Contact Bolts

Allow cylinders to act as a datum point in your clamping applications, and protect the piston when cylinders are used for pushing applications.

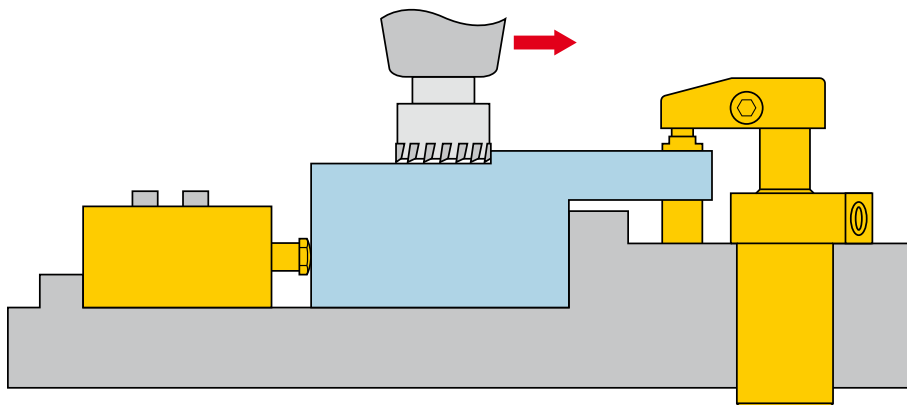

Force: 10,9 - 274,8 kN

Stroke: 8 - 56 mm

Pressure: 40 - 350 bar

- E** Cilindros tipo bloque
- F** Vérins cube
- D** Blockzylinder



Options

Contact bolts

 86 ▶



Fittings

 194 ▶



Valves

 156 ▶



Product selection

Piston Ø	Rod Ø	Clamping force		Stroke mm	Model Nr. Manifold O-ring oil port	Model Nr. BSPB threaded oil port	Cylinder effective area		Cylinder oil capacity		Minimum spring return force N	 kg
		push kN	pull kN				push cm ²	pull cm ²	push cm ³	pull cm ³		
▼ Single acting												
20	12	10,9	-	8	BMS-1082	BS-1082	3,1	-	2,5	-	93	0,9
20	12	10,9	-	18	BMS-10182	BS-10182	3,1	-	5,7	-	108	1,2
25	16	17,0	-	10	BMS-18102	BS-18102	4,9	-	4,9	-	168	1,3
25	16	17,0	-	25	BMS-18252	BS-18252	4,9	-	12,3	-	157	1,8
40	25	43,6	-	12	BMS-40122	BS-40122	12,6	-	15,1	-	378	2,0
40	25	43,6	-	25	BMS-40252	BS-40252	12,6	-	31,4	-	381	2,7
50	32	68,2	-	12	BMS-70122	BS-70122	19,6	-	23,6	-	471	3,3
50	32	68,2	-	25	BMS-70252	BS-70252	19,6	-	49,1	-	425	4,4
80	50	174,9	-	20	BMS-180202	BS-180202	50,2	-	100,5	-	917	12,0
100	63	273,4	-	25	BMS-280252	BS-280252	78,5	-	196,3	-	1419	19,0
▼ Double acting												
20	12	11,0	7,0	16	BMD-10162	BD-10162	3,1	2,0	5,0	3,2	-	0,9
20	12	11,0	7,0	36	BMD-10362	BD-10362	3,1	2,0	11,3	7,2	-	1,2
25	16	17,2	10,1	20	BMD-18202	BD-18202	4,9	2,9	9,8	5,8	-	1,3
25	16	17,2	10,1	50	BMD-18502	BD-18502	4,9	2,9	24,5	14,8	-	1,8
40	25	44,0	26,8	25	BMD-40252	BD-40252	12,6	6,3	31,4	15,8	-	1,9
40	25	44,0	26,8	50	BMD-40502	BD-40502	12,6	6,3	62,8	31,6	-	2,6
50	32	68,7	40,6	25	BMD-70252	BD-70252	19,6	11,6	49,1	29,0	-	3,2
50	32	68,7	40,6	50	BMD-70502	BD-70502	19,6	11,6	98,2	58,0	-	4,3
80	50	175,8	107,2	25	BMD-180252	BD-180252	50,2	30,6	125,6	76,6	-	9,3
80	50	175,8	107,2	50	BMD-180502	BD-180502	50,2	30,6	251,2	153,1	-	11,5
100	63	274,8	165,7	28	BMD-280282	BD-280282	78,5	47,3	219,8	132,6	-	14,7
100	63	274,8	165,7	56	BMD-280562	BD-280562	78,5	47,3	439,6	265,1	-	18,2

Block cylinders *Dimensions & options*

Shown: BD-18202, BMD-70502, BD-40252



BD, BMD, BMS, BS-series

These compact block cylinders are easily mounted in horizontal or vertical position for a range of special tooling applications.

They can be used for positioning, clamping, pushing, pressing or punching operations.

The plunger has an internal thread to accommodate accessories such as contact bolts.

All BS and BD models

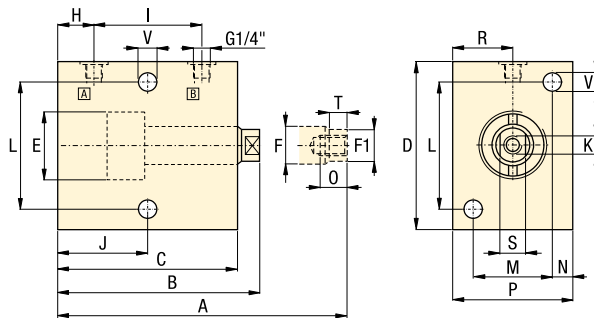

- BMS-1082** **BMD-10162**
- BMS-18102** **BMD-18202**
- BMS-40122** **BMD-40252**
- BMS-70122** **BMD-70252**
- BMD-280282**

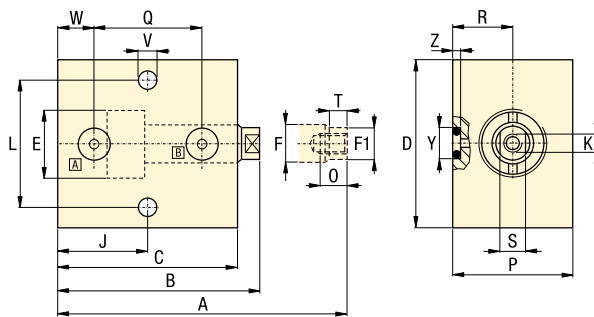

- BMS-10182** **BMD-10362**
- BMS-18252** **BMD-18502**
- BMS-40252** **BMD-40502**
- BMS-70252** **BMD-70502**
- BMS-180252** **BMD-180502**
- BMS-280252** **BMD-280562**

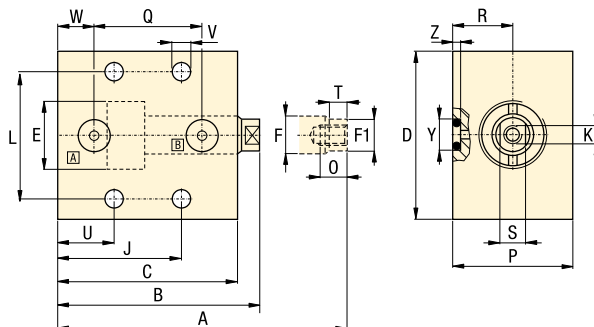

Dimensions in mm [mm]

Model Nr. Manifold O-ring port	Model Nr. BSPP port	A	B	C	D	E	F	F1	H	I	J
▼ Single acting											
BMS-1082	BS-1082	70	62	54,5	60	20	12	11	12,0	25	24,5
BMS-10182	BS-10182	100	82	74,5	60	20	12	11	12,0	45	44,5
BMS-18102	BS-18102	80	70	62,0	65	25	16	15	12,0	30	27,0
BMS-18252	BS-18252	125	100	92,0	65	25	16	15	12,0	60	57,0
BMS-40122	BS-40122	92	80	68,0	80	40	25	24	12,0	35	32,0
BMS-40252	BS-40252	130	105	93,0	80	40	25	24	12,0	60	57,0
BMS-70122	BS-70122	102	90	76,0	100	50	32	31	14,0	40	36,0
BMS-70252	BS-70252	140	115	101,0	100	50	32	31	14,0	65	61,0
BMS-180202	BS-180202	151	131	114,0	140	80	50	49	15,5	70	66,5
BMS-280252	BS-280252	177	152	132,5	170	100	63	62	18,0	80	77,5
▼ Double acting											
BMD-10162	BD-10162	78	62	54,5	60	20	12	11	12,0	25	24,5
BMD-10362	BD-10362	118	82	74,5	60	20	12	11	12,0	45	44,5
BMD-18202	BD-18202	90	70	62,0	65	25	16	15	12,0	30	27,0
BMD-18502	BD-18502	150	100	92,0	65	25	16	15	12,0	60	57,0
BMD-40252	BD-40252	105	80	68,0	80	40	25	24	12,0	35	32,0
BMD-40502	BD-40502	155	105	93,0	80	40	25	24	12,0	60	57,0
BMD-70252	BD-70252	115	90	76,0	100	50	32	31	14,0	40	36,0
BMD-70502	BD-70502	165	115	101,0	100	50	32	31	14,0	65	61,0
BMD-180252	BD-180252	131	106	89,0	140	80	50	49	15,5	45	41,5
BMD-180502	BD-180502	181	131	114,0	140	80	50	49	15,5	70	66,5
BMD-280282	BD-280282	152	124	104,5	170	100	63	62	18,0	52	49,5
BMD-280562	BD-280562	208	152	132,5	170	100	63	62	18,0	80	77,5

■ *Block cylinder used for punching applications.*



i Installation instructions

When operating above 140 bar in applications as shown in the figure below, provide cylinder back-up using a support to eliminate shear loads on the mounting bolts.

Manifold mounting

When hydraulic connections are made through the standard integrated O-ring ports as shown in figure, the sealing surface must have a roughness of 1,6 microns

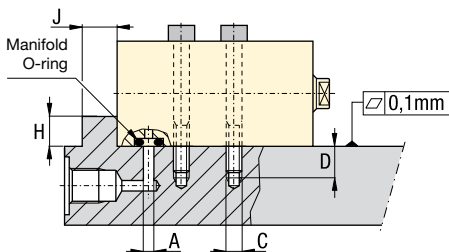

Single-acting cylinders

If the risk of machining coolants or debris being entering via the breather vent (port B) exists, it is recommended that this port be connected to a clean, remote termination point.

A Installation dimensions in mm []

Clamping force at 350 bar	Oil channel diameter	Mounting thread	Minimum thread length	Torque (bolt type 12.9 DIN 912)	Minimum support dimensions		Manifold O-ring	
kN	A	C	D	Nm	H	J	Di x W	Partnumber
11	ø 4	M6	11	17	5	7	4,34 x 3,53	CZ392.041
17	ø 4	M8	13	40	5	8	4,34 x 3,53	CZ392.041
44	ø 4	M10	16	85	5	10	4,34 x 3,53	CZ392.041
68	ø 4	M12	19	145	5	13	4,34 x 3,53	CZ392.041
175	ø 6	M16	24	353	10	16	7,52 x 3,53	CZ935.041
275	ø 6	M20	30	675	10	21	7,52 x 3,53	CZ935.041

¹⁾ Manifold O-rings included

Force: 10,9 - 274,8 kN

Stroke: 16 - 56 mm

Pressure: 40 - 350 bar

E Cilindros tipo bloque

F Vérins cube

D Blockzylinder

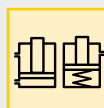

⚠ Important

Linear cylinder support is required at operating pressures above 140 bar. Follow the instructions on this page.

B Accessory chart

Plunger Thread K	Contact Bolt 86 ▶
M6 x 1	BS-62
M8 x 1,25	BS-82
M16 x 2	BS-16
M20 x 2,5	BS-20
M30 x 3,5	BS-30
M36 x 4	BS-36

	K	L	M	N	O	P	Q	R	S	T	U	V	W	Y	Z	Model Nr. Manifold O-ring	Model Nr. BSPP port
												ø		ø			
	Single acting ▼																
	M6	45	25	7,5	10	40	25,0	20,0	9	5,5	-	7,0	12,0	11,0 - 11,1	2,8 - 2,9	BMS-1082	BS-1082
	M6	45	25	7,5	10	40	45,0	20,0	9	5,5	24,5	7,0	12,0	11,0 - 11,1	2,8 - 2,9	BMS-10182	BS-10182
	M8	50	30	7,5	12	45	30,0	22,5	13	6,0	-	9,0	12,0	11,0 - 11,1	2,8 - 2,9	BMS-18102	BS-18102
	M8	50	30	7,5	12	45	60,0	22,5	13	6,0	27,0	9,0	12,0	11,0 - 11,1	2,8 - 2,9	BMS-18252	BS-18252
	M16	60	35	10,0	25	55	37,5	27,5	22	9,5	-	11,0	9,5	11,0 - 11,1	2,8 - 2,9	BMS-40122	BS-40122
	M16	60	35	10,0	25	55	62,5	27,5	22	9,5	27,0	11,0	9,5	11,0 - 11,1	2,8 - 2,9	BMS-40252	BS-40252
	M20	80	45	10,0	30	65	40,0	32,5	27	11,0	-	12,5	12,5	11,0 - 11,1	2,8 - 2,9	BMS-70122	BS-70122
	M20	80	45	10,0	30	65	65,0	32,5	27	11,0	26,0	12,5	12,5	11,0 - 11,1	2,8 - 2,9	BMS-70252	BS-70252
	M30	110	80	15,0	45	110	70,0	55,0	41	14,5	26,5	17,0	15,5	14,1 - 14,2	2,8 - 2,9	BMS-180202	BS-180202
	M36	135	90	17,5	50	125	80,0	62,5	50	17,0	37,5	21,0	18,0	14,1 - 14,2	2,8 - 2,9	BMS-280252	BS-280252
	Double acting ▼																
	M6	45	25	7,5	10	40	25,0	20,0	9	5,5	-	7,0	12,0	11,0 - 11,1	2,8 - 2,9	BMD-10162	BD-10162
	M6	45	25	7,5	10	40	45,0	20,0	9	5,5	24,5	7,0	12,0	11,0 - 11,1	2,8 - 2,9	BMD-10362	BD-10362
	M8	50	30	7,5	12	45	30,0	22,5	13	6,0	-	9,0	12,0	11,0 - 11,1	2,8 - 2,9	BMD-18202	BD-18202
	M8	50	30	7,5	12	45	60,0	22,5	13	6,0	27,0	9,0	12,0	11,0 - 11,1	2,8 - 2,9	BMD-18502	BD-18502
	M16	60	35	10,0	25	55	37,5	27,5	22	9,5	-	11,0	9,5	11,0 - 11,1	2,8 - 2,9	BMD-40252	BD-40252
	M16	60	35	10,0	25	55	62,5	27,5	22	9,5	27,0	11,0	9,5	11,0 - 11,1	2,8 - 2,9	BMD-40502	BD-40502
	M20	80	45	10,0	30	65	40,0	32,5	27	11,0	-	12,5	12,5	11,0 - 11,1	2,8 - 2,9	BMD-70252	BD-70252
	M20	80	45	10,0	30	65	65,0	32,5	27	11,0	26,0	12,5	12,5	11,0 - 11,1	2,8 - 2,9	BMD-70502	BD-70502
	M30	110	80	15,0	45	110	45,0	55,0	41	14,5	-	17,0	15,5	14,1 - 14,2	2,8 - 2,9	BMD-18052	BD-18052
	M30	110	80	15,0	45	110	70,0	55,0	41	14,5	26,5	17,0	15,5	14,1 - 14,2	2,8 - 2,9	BMD-180502	BD-180502
	M36	135	90	17,5	50	125	52,0	62,5	50	17,0	-	21,0	18,0	14,1 - 14,2	2,8 - 2,9	BMD-280282	BD-280282
	M36	135	90	17,5	50	125	80,0	62,5	50	17,0	37,5	21,0	18,0	14,1 - 14,2	2,8 - 2,9	BMD-280562	BD-280562

Pull down clamps *Application & selection*

Shown: ECM-20, ECH-202, ECM-5, ECH-52



► Enerpac pull down clamps are designed to allow unobstructed top face machining. Independent horizontal and vertical movement achieves high lateral and pull down forces to hold the workpiece firmly down against the machine table or fixture. The pull down forces are approximately 33% of the clamping force.

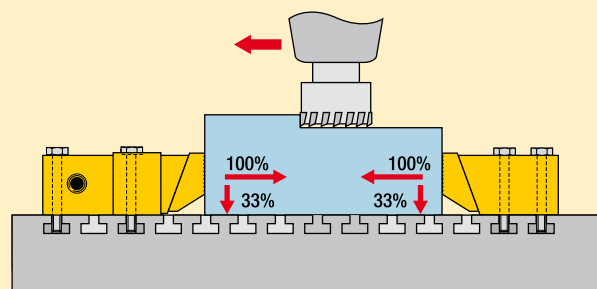

The pull down clamps can be permanently mounted using the supplied mounting bolts. Optional T-nuts can be used for adapting to varying workpiece sizes.

■ Enerpac hydraulic pull down clamps and their mechanical counter parts used to manufacture tie-rod cylinder end caps.



Low profile clamp

..... for unobstructed top face machining

- Independent horizontal and vertical movement for a true pull down effect
- Compact size and low height allows more flexible and economic mounting than comparable dedicated vise
- Manifold and BSPP porting
- Investment high-alloy cast, heat-treated clamping jaw and plunger
- Contamination resistant design for low maintenance, removable guard for chip removal
- Oil ports on both sides for mounting flexibility
- Optional mechanical counter hold provides pull down on end stop for large parts
- Mounting bolts included for ease of installation.

i Pull down clamp operation

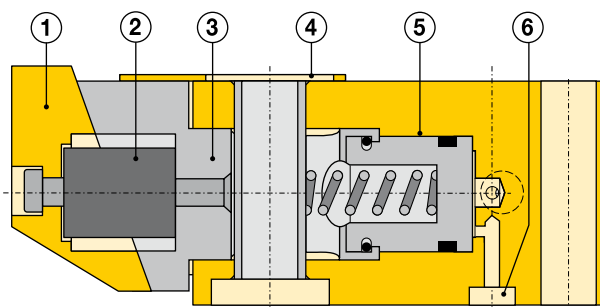

The moveable jaw ① and the flexible connection design ② allows lateral movement and eliminate any bending moment. Roller finished cylinder bore ③ improves seal life. The removable guard ④ prevents the entry of chips and allows easy cleaning. Heat treated, centerless ground plunger ⑤ for extremely close tolerances and long life. The clamps feature both manifold mount ⑥ and plumbed oil connection.

Product selection

Lateral clamping force at 350 bar	Pull down force at 350 bar	Stroke	Model number	Effective area	Oil capacity	Mounting bolts ¹⁾ (included)
kN	kN	mm		cm ²	cm ³	

▼ Hydraulic pull down clamps

3,9	1,3	5,1	ECH-52	1,16	0,13	M8 x 45
17,4	5,8	7,9	ECH-202	5,03	1,07	M12 x 80

Holding force	For pull down clamp model number	Model number	Mounting bolts included ¹⁾ number	Replaceable ribbed jaws model
kN				

▼ Mechanical counter holds

3,9	ECH-52	ECM-5	M8 x 35	ECJR-5
17,4	ECH-202	ECM-20	M12 x 65	ECJR-20

¹⁾ Torque M8 with 24,4 Nm, M12 with 85,4 Nm.
The use of T-nuts requires longer bolts.

i Pull down force

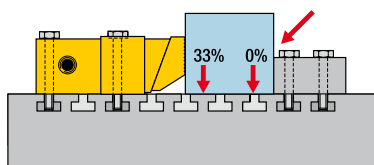

Fixed stop set-up

A very workable set-up for workpieces that are not larger or wider than twice the width of the edge clamp. The pull down force of the hydraulic actuated edge clamp is sufficient to pull down and hold the product during actual machining.

The mounting surface must extend out under the jaw.

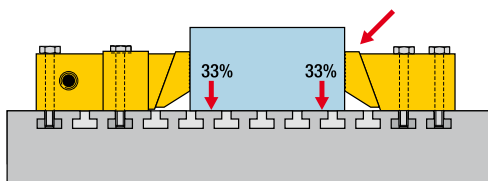
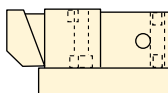

Counter hold set-up

For workpieces larger than twice the width of the edge clamp used, it is recommended to install a mechanical counter hold. The counter hold also produces a pull down force equal to 1/3 of the lateral force of the hydraulic edge clamp applied. In this way the grip on the workpiece is very tight. Another advantage of this set-up is the repeated accuracy of machining results.

ECH-52, -202

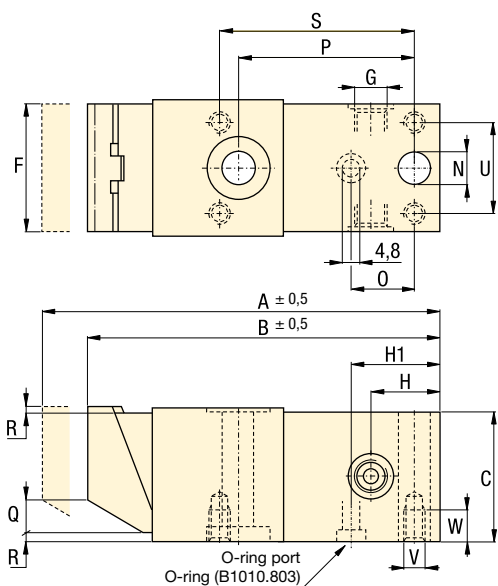

ECM-5, -20

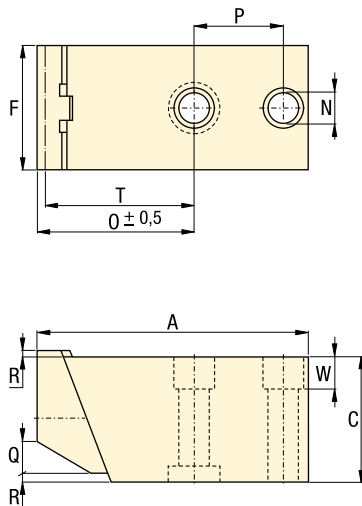

- Force: 3,9 - 17,4 kN
- Stroke: 5,1 - 7,9 mm
- Pressure: 15 - 350 bar

- E** Garras de empuje oblicuo
- F** Crampons plaqueurs
- D** Niederzugspanner

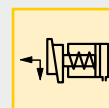

Options

Fittings

194



Threaded cylinders

66



Positive clamping cylinders

80



! Important

Do not allow the clamping jaw to extend below the lower surface of the clamp body.

Product dimensions in mm [$\nabla \oplus$]

Model number	A	B	C	F	G	H	H1	N	O	P	Q	R	S	T	U	V	W	kg
▼ Hydraulic pull down clamps																		
ECH-52	105,2	100,1	30,0	30,0	G1/8"	19,1	18,8	8,4	11,7	53,1	3,0	2,0	58,9	-	22,1	M5 x 0,8	6,1	0,7
ECH-202	142,7	134,9	50,0	50,0	G1/4"	24,9	23,6	12,4	13,7	67,1	14,0	3,0	73,9	-	36,1	M8 x 1,25	11,9	2,5
▼ Mechanical counter holds																		
ECM-5	79,0	-	30,0	30,0	-	-	-	8,4	41,9	25,9	3,0	2,0	-	40,9	-	-	7,9	0,6
ECM-20	102,1	-	50,0	50,0	-	-	-	12,4	59,9	30,0	14,0	3,0	-	58,9	-	-	13,0	1,9

Hollow plunger cylinders *Application & selection*

Shown: HCS-20, RWH-121, RWH-202



▶ These cylinders are regularly used for upgrading mechanical clamping to faster and easier hydraulic clamping. Other typical applications include production pressing, punching and crimping operations.

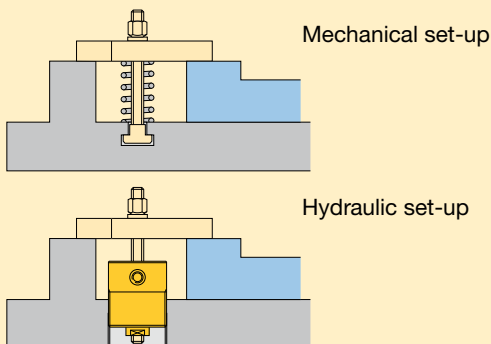

Traditional mechanical elements in a clamping fixture are replaced by a hollow plunger hydraulic cylinder.

■ Two Enerpac RWH-121 hollow cylinders mounted at the back side of a fixture.

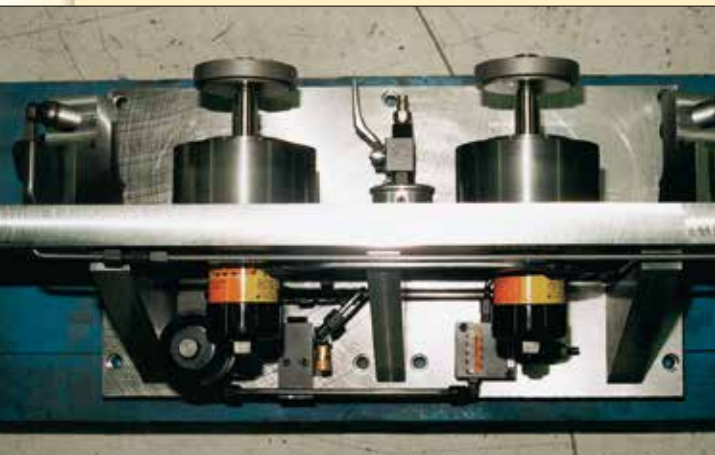

For high force push and pull applications on and around the fixture

- Load can be attached to either end of the cylinder, providing a choice of push or pull actions - both realizing full cylinder capacity
- Very high cylinder capacities contained within small dimensions allow compact fixture designs
- Spring return operation allows for easy unloading of the workpiece
- Threaded collars and base mounting holes allow mounting flexibility, including table-top surfaces and T-slots
- Nickel-plated plungers, plunger wipers and internal venting prevent corrosion and support longer operation life on all HCS models
- The CY series hollow plunger cylinders can be manifold mounted (except for CY-1254-25).

Product selection

Cylinder capacity ¹⁾	Stroke	Center hole diameter	Model number	Effective area	Oil capacity	Operating pressure
kN	mm	mm		cm ²	cm ³	bar
11,6	6,4	9,9	CY1254-25	5,61	3,61	210
17,8	8,4	13,5	MRH-20	8,58	6,72	210
17,8	8,4	13,5	RWH-20	8,58	6,72	210
17,8	8,4	13,5	RWH-20T	8,58	6,72	210
21,5	10,2	10,7	HCS-20*	6,19	6,23	350
33,0	7,9	19,6	CY2129-25	15,94	12,62	210
33,0	16,0	19,6	CY2129-5	15,94	25,56	210
56,3	12,1	13,0	HCS-50*	16,26	19,50	350
59,3	16,0	22,6	CY2754-5	28,65	45,88	210
61,4	8,1	19,6	MRH-120	17,81	14,09	350
61,4	8,1	19,6	QDH-120	17,81	14,09	350
61,4	8,1	19,6	RWH-120	17,81	14,09	350
61,4	25,9	19,6	RWH-121	17,81	45,23	350
83,7	14,2	17,0	HCS-80*	23,42	32,61	350
104,6	13,2	26,9	RWH-200	30,58	38,84	350
104,6	51,3	26,9	RWH-202	30,58	155,35	350
113,4	16,0	21,0	HCS-110*	32,65	52,27	350
160,2	12,7	33,3	RWH-300	46,58	58,99	350
160,2	25,4	33,3	RWH-301	46,58	118,31	350
160,2	63,2	33,3	RWH-302	46,58	294,97	350

¹⁾ At maximum operating pressure. **Note:** Seal material Buna-N, Polyurethane, Teflon.
* This product is made to order. Please contact Enerpac for delivery information before specifying in your design.

Optional Heat Treated Hollow Saddles

Saddle type	Cylinder model number	Saddle model No.	Saddle Dimensions (mm)		
			A	B	C
Threaded hollow	RWH-200, 202	HP-2015	53,6	1"-8	9,7
	RWH-300, 301, 302	HP-3015	63,3	1¼"-7	9,7

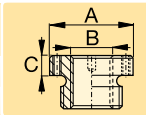

Smooth hollow saddles are standard on all RWH-20 and 30-models (RWH-12 models are not equipped with saddles).

MRH-20, 120

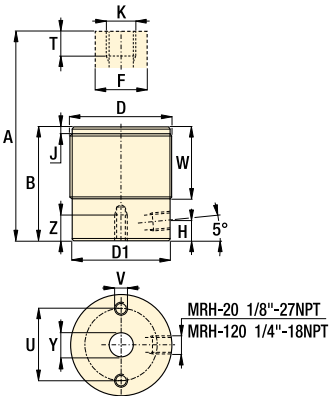

RWH-20, 120, 121, QDH-20

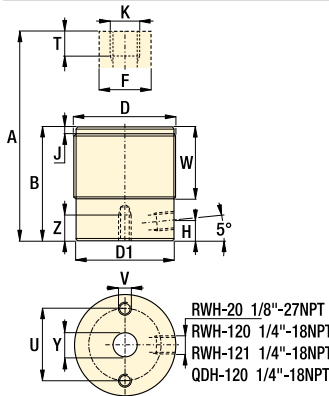

other RWH model

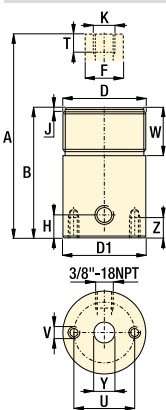

CY models

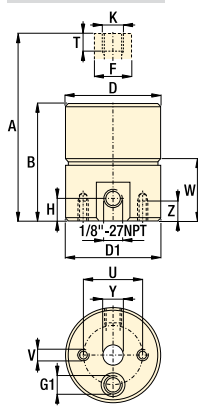

HCS models

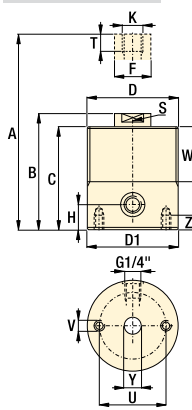

Force: 11,6 - 160,2 kN
Stroke: 6,4 - 63,2 mm
Pressure: 55 - 350 bar

- E** Cilindros de émbolo hueco
- F** Vérins a piston creux
- D** Hohlkolbenzylinder

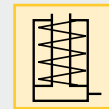

Options

Flange nuts

86 ▶

Important

Use Grade 8 (DIN12.9) bolt quality or better for pulling. Use Grade B7 (DIN10.9) threaded rod quality or better for pulling applications.

RWH cylinders can be used up to 700 bar maximum working pressure (except RWH-20 and RWH120).

Product dimensions in mm

Model nr.	A	B	C	D	D1	F	H	J	K	S	T	U	V	W	Y	Z	kg
				ø	ø							ø					
CY1254-25	57,2	50,8	-	ø 44,5	44,5	14,2	7,4	-	.375-16 UNC	-	15,7	31,8	.250-20 UNC	24,6	ø 9,9	9,7	0,5
MRH-20	60,8	52,3	-	M48 x 1,5	45,0	25,3	7,1	3,0	ø 13,5	-	22,4	35,1	M6 x 1	38,1	ø 12,7	6,4	0,6
RWH-20	60,7	52,3	-	1.875-16 UN	45,5	25,4	7,1	3,0	ø 13,5	-	22,1	35,1	.250-20 UNC	38,1	.500-20 UNF	6,35	1,4
RWH-20T	60,7	52,3	-	1.875-16 UN	45,5	25,4	7,1	3,0	.500-20 UNF	-	12,4	35,1	.250-20 UNC	38,1	ø 13,5	6,4	1,4
HCS-20*	84,3	74,4	66,0	M58 x 1,5	58,0	18,0	11,0	-	M10 x 1,5	14,0	25,8	40,0	M6 x 1	40,0	ø 10,7	10,0	1,1
CY2129-25¹⁾	58,7	50,8	-	ø 66,8	63,5	28,7	7,9	-	.750-10 UNC	-	28,7	44,5	.375-16 UNC	20,3	ø 19,6	8,6	1,1
CY2129-5¹⁾	85,3	69,3	-	ø 66,8	63,5	28,7	7,9	-	.750-10 UNC	-	28,7	44,5	.375-16 UNC	39,1	ø 19,6	11,2	1,4
HCS-50*	96,5	84,4	75,0	M65 x 1,5	65,0	28,0	14,0	-	M12 x 1,75	22,0	24,2	45,0	M8 x 1,25	45,0	ø 13,0	12,0	1,5
CY2754-5¹⁾	92,2	76,2	-	ø 88,9	79,5	31,8	11,2	-	.875-9 UNC	-	31,8	53,8	.375-16 UNC	40,9	ø 22,6	11,2	2,7
MRH-120	64,5	56,0	-	M70 x 1,5	70,0	35,0	10,0	4,8	M18 x 1,5	-	15,2	50,0	M8 x 1,25	30,2	ø 17,3	6,1	1,4
QDH-120	64,5	56,4	-	2.750-16 UN	69,9	35,1	9,9	4,8	.750-10 UNC	-	15,7	50,8	.312-18 UNC	30,2	ø 17,3	6,4	1,4
RWH-120	64,5	56,4	-	2.750-16 UN	69,9	35,1	9,9	4,8	.750-16 UNF	-	15,5	50,8	.312-18 UNC	30,2	ø 17,3	6,4	1,4
RWH-121	107,7	81,8	-	2.750-16 UN	69,9	35,1	13,5	4,8	.750-16 UNF	-	18,5	50,8	.312-18 UNC	30,2	ø 17,3	6,4	2,2
HCS-80*	109,4	95,2	85,0	M75 x 1,5	75,0	32,0	17,0	-	M16 x 2	24,0	32,2	55,0	M8 x 1,25	50,0	ø 17,0	12,0	2,3
RWH-200	136,9	124,0	-	3.875-12 UN	98,6	53,8	19,1	4,8	1.562-16 UN	-	22,4	82,6	.375-16 UNC	38,1	ø 26,9	9,7	6,2
RWH-202	213,1	161,8	-	3.875-12 UN	98,6	53,8	19,1	4,8	1.562-16 UN	-	22,4	82,6	.375-16 UNC	38,1	ø 26,9	9,7	7,7
HCS-110*	120,4	104,4	93,0	M90 x 2	90,0	40,0	19,0	-	M20 x 2,5	32,0	36,7	65,0	M10 x 1,5	60,0	ø 21,0	15,0	3,6
RWH-300	140,2	127,5	-	4.500-12 UN	114,0	64,5	21,6	4,8	1.812-16 UN	-	22,4	91,9	.375-16 UNC	42,2	ø 33,3	15,7	8,6
RWH-301	165,6	140,2	-	4.500-12 UN	114,0	64,5	21,6	4,8	1.812-16 UN	-	22,4	91,9	.375-16 UNC	42,2	ø 33,3	15,7	9,8
RWH-302	241,8	178,6	-	4.500-12 UN	114,0	64,5	21,6	4,8	1.812-16 UN	-	22,4	91,9	.375-16 UNC	42,2	ø 33,3	15,7	10,9

¹⁾ For these models G1 = manifold and 1/8-27 NPTF

Positive clamping cylinder *Application & selection*

Shown: MRS-1, MRS-1001, MRS-5001



▶ These cylinders are designed for prolonged clamping applications in moveable machine parts, tools, fixtures, pallets and workpieces.

The mechanical clamping force of this cylinder is ideal for FMS applications. Hydraulic pressure is used to release the workpiece and is not required to maintain the clamping force on the workpiece. Internal high strength springs produce the required clamping force.

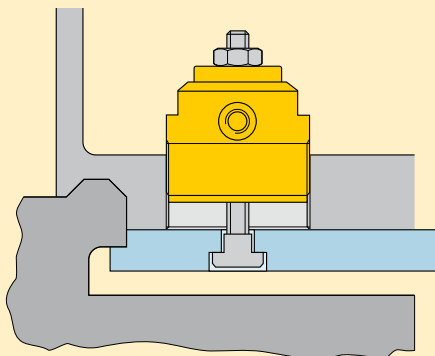

■ When pressure is released, the Enerpac MRS cylinders clamp the workpiece by pushing it against the frame that is attached to the fixture.

Ideal for palletized applications

- Heavy disk springs maintain the clamping force - hydraulic pressure is used for release
- Single-acting design allows easy setup of hydraulic system
- Hollow plunger design allows easy retrofit for mechanical clamping
- Custom buttons can be fitted into the plunger for clamping directly against a workpiece
- Threaded body allows easy cylinders mounting directly into fixture plate
- Internal threaded plunger allows accessories to be used easily for retrofit applications.

i Positive clamping operation

The applied clamping force is determined by how far the cylinder's plunger is being retracted when engaging contact with the workpiece (referred to as the effective clamping stroke).

Use the diagrams on the next page as a guide to your fixture set-up. Note that in order to load and unload the workpiece, the plunger must be retracted somewhat further than the effective clamping stroke.

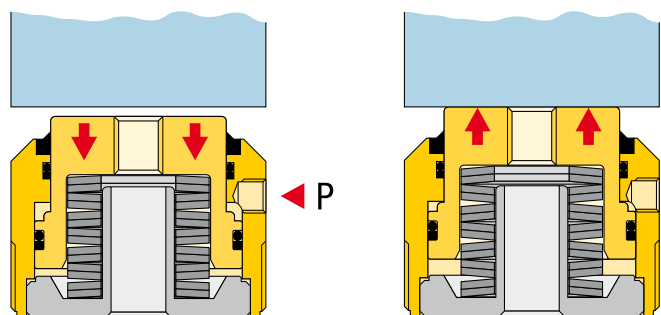

Hydraulic pressure applied

- Plunger retracts
- Work piece is released
- New work piece is loaded.

Hydraulic pressure released

- Springs apply force
- Workpiece is clamped
- Machining can take place.

Product selection

Cylinder capacity at 350 bar	Effective clamping stroke	Model number	Required operating pressure ¹⁾	Max. tensioning stroke	Oil capacity
kN	mm		bar	mm	cm ³
12,0	2,3	MRS-1	350	2,3	8,36
26,7	2,3	MRS-2	350	2,3	4,26
51,2	2,3	MRS-5	350	2,3	8,19
8,5	2,5	MRS-1001	140	5,1	8,85
16,5	2,5	MRS-2001	185	5,1	11,96
25,8	2,5	MRS-3001	180	5,1	19,99
37,8	3,0	MRS-5001	235	5,6	22,12

¹⁾ Minimum operating pressure to fully retract the plunger.

Note: Seal material Buna-N, Polyurethane.

1 Pressure/Stroke/Force diagrams

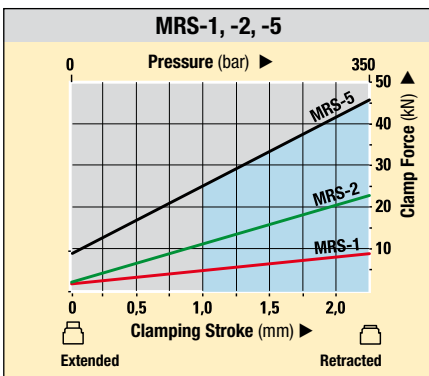
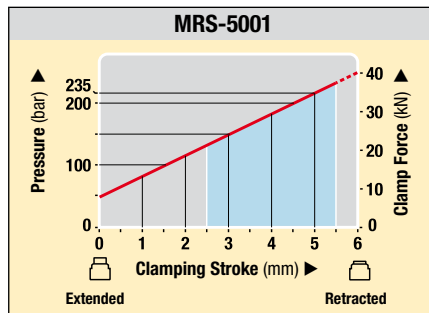
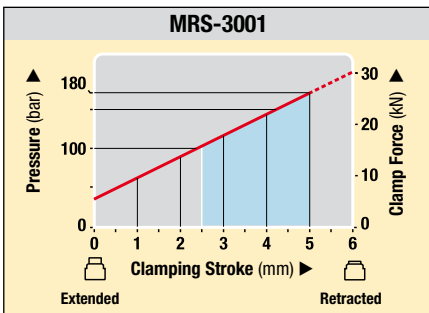
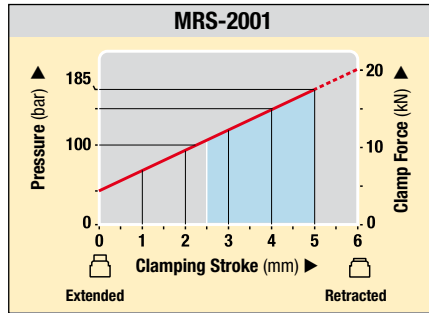
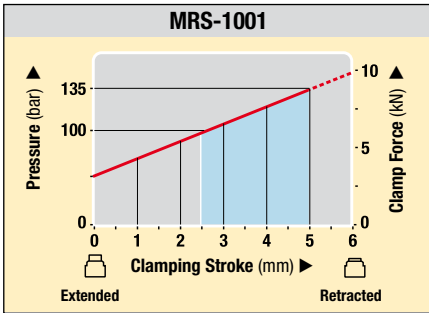

= Suggested Clamping Range

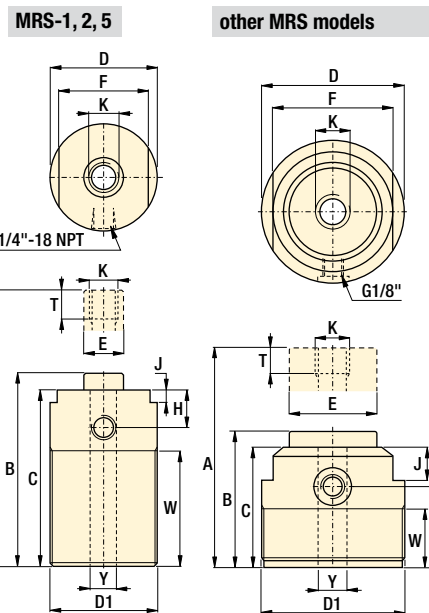

- Force:** 8,5 - 51,2 kN
- Stroke:** 2,3 - 5,6 mm
- Pressure:** 140 - 350 bar

- E** Cilindros de amarre
- F** Vérins de bridage positif
- D** Federspannzylinder



Options

Contact bolts [86](#)

Flange nuts [86](#)

Collet-Lok® work supports [16](#)

Important

Be sure to refer to the force/stroke chart when selecting cylinders for an application. Piece parts with a large variation at the clamping point may be prone to having variations in clamping force.

Depending on the cycle usage of the application and amount of deflection, the internal disk springs may need to be replaced at scheduled intervals.

Product dimensions in mm []

Model number	A	B	C	D	D1	E	F	H	J	K	T	W	Y	kg
MRS-1	85,1	82,8	79,0	36,1	M36 x 1,5	12,7	30,0	18,0	6,1	M8 x 1,25	36,1	50,0	8,9	0,5
MRS-2	89,9	87,9	84,1	48,0	M48 x 1,5	17,3	39,9	20,1	7,1	M10 x 1,5	38,1	50,0	10,9	0,9
MRS-5	125,0	122,7	119,1	59,9	M60 x 2	22,1	50,0	21,1	7,1	M16 x 2	39,9	85,1	17,0	1,8
MRS-1001	62,0	56,9	53,1	65,0	M65 x 1,5	39,9	55,1	35,1	15,0	M12 x 1,75	20,1	24,9	13,0	1,2
MRS-2001	65,0	59,9	56,9	80,0	M80 x 2	54,9	65,0	38,1	15,0	M 16 x 2	20,1	29,0	17,0	2,1
MRS-3001	73,9	69,1	66,0	95,0	M95 x 2	59,9	80,0	46,0	17,0	M20 x 2,5	20,1	37,1	21,1	3,0
MRS-5001	96,0	65,0	67,6	95,0	M95 x 2	59,9	80,0	46,0	17,0	M20 x 2,5	20,1	37,1	21,1	3,5

Universal cylinders - Single acting *Application & selection*

Shown: RW-50, BRW-104



► Used when high cylinder forces or long strokes are required in a confined area. Can handle a wide range of production tooling applications.

i Block and cylindrical models

Cylindrical models

- Long stroke
- Flexible in fixture design
- Variety of attachments

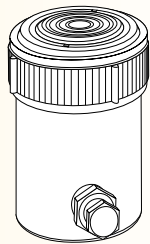

Block models

- Easily mounted
- Compact design

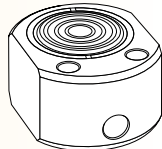

■ Enerpac RW-101 cylinders used in a high pressure toggle style clamping set-up.



Heavy-duty cylinders

...handle a variety of applications

- High pressure design when additional force is required
- Long stroke lengths in a compact design, well suited for welding applications
- Collar mounting threads and base mounting holes allow flexible mounting options
- Cylinders are provided with hardened saddles for additional plunger protection
- Snap-in saddles are easily removed for adapting to different plunger devices
- Chrome plated plunger with bronze upper and lower bearing provides a long cylinder life.

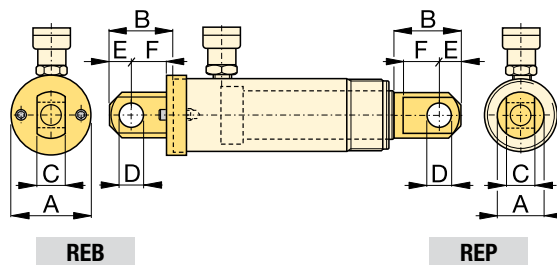

Type	Model number	Clevis eye dimensions (mm)						Pin to pin* mm
		A	B	C	D	E	F	
Base ¹⁾	REB-5	44,5	47,8	14,2	16,0	16,0	25,4	60,2
	REB-10	63,5	66,8	25,4	22,3	25,4	35,1	78,0
Plunger	REP-5	28,7	41,2	14,2	16,0	16,0	19,1	—
	REP-10	42,9	50,8	25,4	22,3	25,4	28,7	—

* Pin to Pin- REB and REP Clevises fitted. Add cylinder stroke length.

¹⁾ Mounting screws are included.

globe Product selection

Cylinder capacity at 350 bar	Stroke	Model number	Effective area	Oil capacity	Operating pressure
kN	mm		cm ²	cm ³	bar
▼ Block models					
22,1	15,7	RW-41	6,39	10,16	6-550
22,1	15,7	RW-50	6,39	10,16	40-700
22,1	15,0	MRW-50F	6,39	10,16	6-550
22,1	15,0	MRW-50M	6,39	10,16	6-550
▼ Cylindrical models					
22,1	25,7	BRW-51	6,39	16,22	40-700
22,1	80,5	BRW-53	6,39	48,67	40-700
22,1	131,3	BRW-55	6,39	81,12	40-700
50,6	25,1	BRW-101	14,39	36,54	40-700
50,6	55,4	BRW-102	14,39	77,84	40-700
50,6	106,2	BRW-104	14,39	150,92	40-700
50,6	155,2	BRW-106	14,39	224,01	40-700
50,6	257,3	BRW-1010	14,39	370,18	40-700

Note: Seal material Buna-N, Polyurethan.

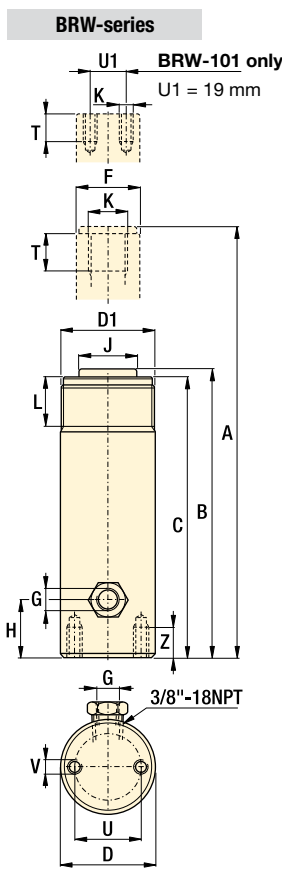
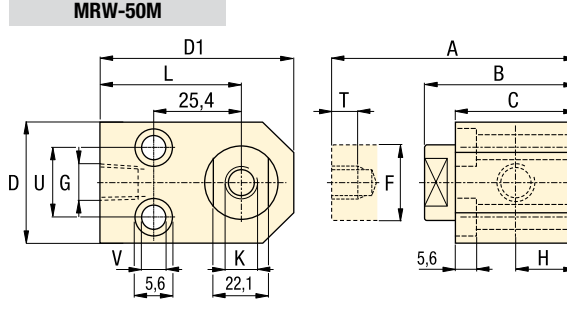
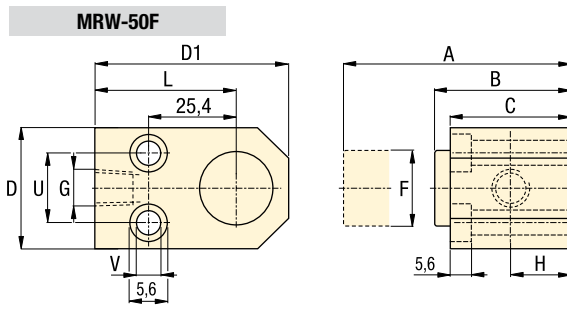
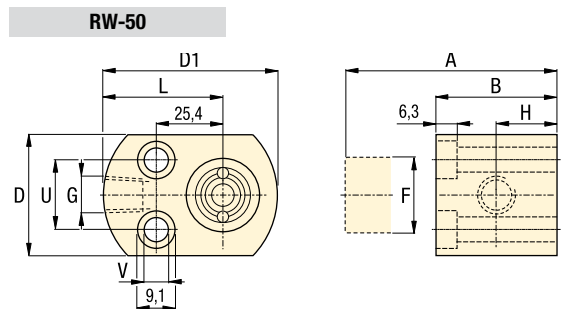
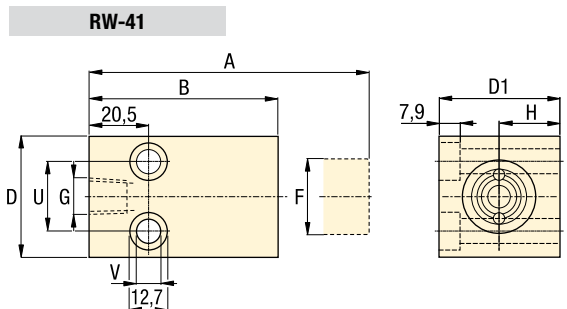

Force: 22,1 - 50,6 kN

Stroke: 15,0 - 257,3 mm

Pressure: 40 - 350 bar

- E** Cilindros universales
- F** Vérins universels
- D** Universelle Linearzylinder



Options

Cylinder accessories 86 ▶

Important

These cylinders are intended for medium cycle applications. The return spring is intended for retracting the plunger for heavy devices should not be attached to it.

Plungers should be shielded in welding applications to prevent splatter from sticking to chrome plating.

Do not use these cylinders continuously at full stroke or damage to return spring may result.

Product dimensions in mm [± 0.1]

Model number	A	B	C	D	D1	F	G	H	J	K	L	T	U	V	Z	kg	
							NPTF										
▼ Block models																	
RW-41	80,8	65,0	-	41,1	41,1	25,4	1/4 -18	20,6	-	-	-	-	25,4	8,9	-	0,8	
RW-50	56,9	41,4	-	41,1	58,9	25,4	3/8 -18	19,1	-	-	38,1	-	28,4	5,6	-	0,8	
MRW-50F	55,9	40,9	40,9	41,1	65,0	25,4	3/8 -18	20,6	-	-	44,5	-	28,4	5,6	-	0,8	
MRW-50M	66,0	51,1	40,9	41,1	65,0	25,4	3/8 -18	20,6	-	M8 x 1,25	44,5	6,1	28,4	5,6	-	0,8	
▼ Cylindrical models																	
BRW-51	137,7	112,0	103,9	38,1	M38 x 1,5	25,4	1/4 -18	19,1	25,4	M18 x 2,5	30,0	15,5	25,4	M6 x 1	14,0	1,0	
BRW-53	247,1	166,6	158,8	38,1	M38 x 1,5	25,4	1/4 -18	19,1	25,4	M18 x 2,5	30,0	15,5	25,4	M6 x 1	14,0	1,4	
BRW-55	349,0	217,7	209,6	38,1	M38 x 1,5	25,4	1/4 -18	19,1	25,4	M18 x 2,5	30,0	15,5	25,4	M6 x 1	14,0	1,8	
BRW-101	115,1	89,9	86,6	57,2	M56 x 2	38,1	1/4 -18	19,1	-	M5 x 0,8	29,2	6,1	39,6	M8 x 1,25	12,4	1,7	
BRW-102	177,0	121,7	115,1	57,2	M56 x 2	38,1	1/4 -18	19,1	35,1	M22 x 1,5	29,2	17,3	39,6	M8 x 1,25	12,4	2,2	
BRW-104	278,6	172,5	165,9	57,2	M56 x 2	38,1	1/4 -18	19,1	35,1	M22 x 1,5	29,2	17,3	39,6	M8 x 1,25	12,4	3,2	
BRW-106	401,8	246,6	241,3	57,2	M56 x 2	38,1	1/4 -18	19,1	35,1	M22 x 1,5	29,2	17,3	39,6	M8 x 1,25	12,4	4,4	
BRW-1010	606,6	349,3	342,9	57,2	M56 x 2	38,1	1/4 -18	19,1	35,1	M22 x 1,5	28,7	19,1	39,6	M8 x 1,25	12,7	6,3	

Linear Cylinders Power Sources Valves Pallet Components System Components Yellow Pages

Universal cylinders - Double acting *Application & selection*

Shown: BRD-2510, BRD-96, BRD-256, BRD-41, BRD-166



▶ Used when high cylinder forces with a powered return stroke is required in a confined area.

Cylinders can push or pull a workpiece into position and the threaded plunger allows adapting standard clevis attachments.

■ Clamping application using Enerpac BRD cylinders (with clevis eye attachments on both ends) for their high pressure capability and mounting flexibility.



Heavy-duty cylinders

...provide push as well as pull forces

- High pressure design when additional force is required for push or pull applications
- Long strokes in a compact design are well suited for custom toggle style clamping
- Various features for mounting
- Threaded plunger allows a wide range of mounting adapter devices
- Chrome plated plunger provides a long cylinder life

i Optional cylinder attachments

For added cylinder flexibility, a selection of interchangeable mountings is available to fit plunger or cylinder threads.



Foot mounting

Mounts onto cylinder collar thread. Retainer nut included. Mounting screws not included.



Flange mounting

Mounts onto cylinder collar thread. Retainer nut included. Mounting screws not included.



Retainer nut

Locking foot or flange mountings. Mounts onto cylinder base or collar threads. Included with foot and flange mountings.



Clevis eye

Threads onto plunger or base.

globe Product selection

Cylinder capacity at 350 bar		Stroke mm	Model number	Effective area		Oil capacity	
push	pull			push	pull	push	pull
17,4	7,7	28,2	BRD-41	5,10	2,19	14,58	6,55
17,4	7,7	78,9	BRD-43	5,10	2,19	40,48	18,03
17,4	7,7	155,2	BRD-46	5,10	2,19	79,31	34,41
40,0	21,8	31,6	BRD-93	11,42	6,32	32,77	18,03
40,0	21,8	82,3	BRD-93	11,42	6,32	90,78	49,16
40,0	21,8	158,0	BRD-96	11,42	6,32	178,29	98,32
40,0	21,8	260,2	BRD-910	11,42	6,32	293,98	162,23
69,0	36,9	157,2	BRD-166	20,32	10,71	322,33	170,42
69,0	36,9	258,8	BRD-1610	20,32	10,71	528,64	278,58
109,0	47,8	159,7	BRD-256	31,74	13,87	503,57	219,59
109,0	47,8	261,1	BRD-2510	31,74	13,87	825,90	360,51

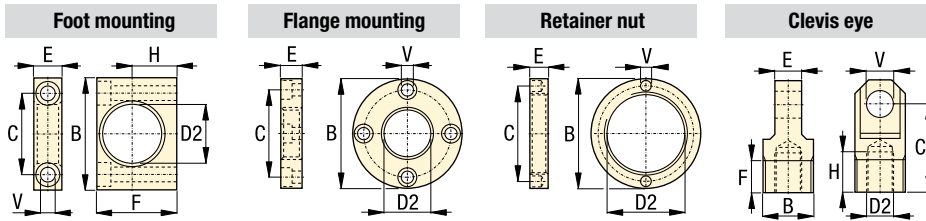

- Force: 17,4 - 109 kN**
- Stroke: 28,2 - 261,1 mm**
- Pressure: 35 - 700 bar**

- E Cilindros universales**
- F Vérins universels**
- D Universelle Linearzylinder**



Cylinder attachments in mm [\varnothing]

Cylinder capacity at 350 bar kN	D2	Model number	B	C	E	F	H	V	kg	
										at 700 bar kN
▼ Foot mounting with retainer nut										
17,4	34,8	42,1	BAD-141	80,0	58,0	20,0	57,0	31,8	10,5	0,4
40,0	80,0	56,1	BAD-171	105,0	78,0	25,0	82,5	44,5	13,5	1,2
69,0	138,0	70,1	BAD-181	127,0	95,2	35,0	100,0	52,4	20,0	2,9
109,0	218,0	85,1	BAD-191	159,0	117,5	45,0	125,0	63,5	26,5	4,5
▼ Flange mounting with retainer nut										
17,4	34,8	42,1	BAD-142	98,4	78,6	19,0	-	-	11,0	1,0
40,0	80,0	56,1	BAD-172	120,5	98,4	25,4	-	-	11,0	2,1
69,0	138,0	70,1	BAD-182	143,0	115,9	35,0	-	-	14,0	3,8
109,0	218,0	85,1	BAD-192	165,0	135,7	44,5	-	-	17,0	6,0
▼ Retainer nut										
17,4	34,8	M42 x 1,5	BAD-143	57,0	49,5	9,5	-	-	6,3	0,1
40,0	80,0	M56 x 2	BAD-173	75,0	63,5	12,7	-	-	6,7	0,3
69,0	138,0	M70 x 2	BAD-183	92,0	79,4	19,0	-	-	6,7	0,6
109,0	218,0	M85 x 2	BAD-193	108,0	95,2	25,4	-	-	6,7	0,8
▼ Clevis eye										
17,4	34,8	M16 x 1,5	BAD-150	M30 x 1,5	52,4	15,9	19,1	23,8	16,0	0,2
40,0	80,0	M22 x 1,5	BAD-151	M42 x 1,5	57,1	25,4	25,4	23,8	20,0	0,6
69,0	138,0	M30 x 1,5	BAD-152	M56 x 2	77,8	31,9	25,4	26,9	25,0	1,3
109,0	218,0	M42 x 1,5	BAD-153	M70 x 2	77,8	38,2	25,4	30,2	32,0	2,1

Options

Cylinder accessories

86 ▶

Important

Be certain that the mounting devices can handle forces in the push and pull direction.

BRD series cylinders are designed for a maximum operating pressure of 700 bar.

When applying 700 bar cylinder capacities double as well.

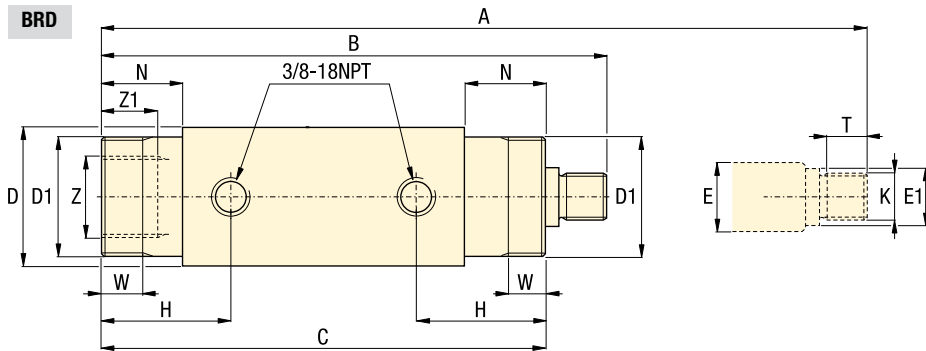

Product dimensions in mm [\varnothing]

Model number	A	B	C	D	D1	E	E1	H	K	N	T	W	Z	Z1	kg
BRD-41	213,7	185,5	162,3	50,8	M42 x 1,5	19,0	17,5	47,0	M16 x 1,5	29,0	19,3	11,0	M30 x 1,5	12,0	2,2
BRD-43	315,3	236,4	213,0	50,8	M42 x 1,5	19,0	17,5	47,0	M16 x 1,5	29,0	19,3	11,0	M30 x 1,5	12,0	2,9
BRD-46	467,7	312,5	289,3	50,8	M42 x 1,5	19,0	17,5	47,0	M16 x 1,5	29,0	19,3	11,0	M30 x 1,5	12,0	4,1
BRD-91	253,4	221,8	198,4	63,5	M56 x 2	25,4	23,9	57,7	M22 x 1,5	38,1	19,4	14,2	M42 x 1,5	14,8	4,1
BRD-93	355,0	272,7	249,2	63,5	M56 x 2	25,4	23,9	57,7	M22 x 1,5	38,1	19,4	14,2	M42 x 1,5	14,8	5,0
BRD-96	506,9	348,9	325,4	63,5	M56 x 2	25,4	23,9	57,7	M22 x 1,5	38,1	19,4	14,2	M42 x 1,5	14,8	6,3
BRD-910	710,6	450,4	427,0	63,5	M56 x 2	25,4	23,9	57,7	M22 x 1,5	38,1	19,4	14,2	M42 x 1,5	14,8	8,6
BRD-166	547,2	390,0	358,8	76,2	M70 x 2	34,9	32,0	73,7	M30 x 1,5	53,8	25,4	22,4	M56 x 2	26,2	10,0
BRD-1610	750,4	491,6	358,8	76,2	M70 x 2	34,9	32,0	73,7	M30 x 1,5	53,8	25,4	22,4	M56 x 2	26,2	13,2
BRD-256	583,7	424,0	397,0	95,0	M85 x 2	47,6	45,0	89,0	M42 x 1,5	70,0	22,3	28,5	M70 x 2	25,2	16,3
BRD-2510	786,2	525,1	397,0	95,0	M85 x 2	47,6	45,0	89,0	M42 x 1,5	70,0	22,3	28,5	M70 x 2	25,2	20,9

Shown: Cylinder accessories



These accessories are provided so that you can effectively position, mount and actuate Enerpac hydraulic cylinders according to your specific fixturing or production applications.

For optimum mounting and fixture flexibility

...to match specific applications

- **Contact bolts**
Allow cylinders to act as a datum point in your clamping applications, and protect the piston when cylinders are used for pushing applications
- **Cylindrical flange nuts**
For mounting threaded body cylinders in any position
- **Mounting brackets**
For bolting cylinders to suit the application.

All BS Models

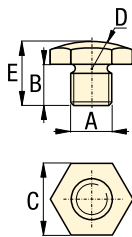

FN-121, 201, 251

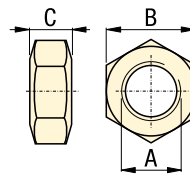

All other FN models

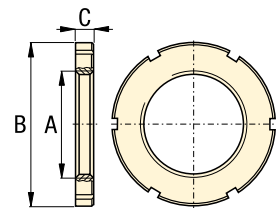

Product dimensions in inches [mm]

A thread	Model number	B	C	D	E
▼ Spherical contact bolts					
#6-32 UNC	BS-21	5,1	6,4	6,0	8,9
#8-32 UNC	BS-41	7,1	7,9	7,9	10,9
M4 x 0,7	BS-42	7,1	7,9	7,9	10,9
.250-28 UNF	BS-61	7,9	11,1	11,1	14,0
M6 x 1	BS-62	7,9	11,1	11,1	14,0
.313-24 UNF	BS-81	9,9	14,2	14,0	17,0
M8 x 1,25	BS-82	9,9	14,0	14,0	17,0
.375-16 UNC	BS-91	9,9	16,0	16,2	17,0
.500-13 UNC	BS-101	9,9	17,5	17,0	18,0
M10 x 1,5	BS-102	6,6	17,0	23,1	10,9
M16 x 2	BS-162	11,9	22,0	22,0	23,9
M20 x 2,5	BS-202	11,9	23,9	22,0	23,9

A thread	Model number	B	C
▼ Jam nuts			
.500-20 UNF	FN-121	19,0	7,9
M12 x 1,5	FN-122	27,9	6,1
.750-16 UNF	FN-201	28,7	10,7
M20 x 1,5	FN-202	36,1	7,9
1.000-12 UNF	FN-251	38,1	14,0
1.125-16 UN	FN-281	44,4	9,9
M28 x 1,5	FN-282	50,0	9,9
1.25-16 UN	FN-301	47,7	9,9
M30 x 1,5	FN-302	50,0	9,9
1.313-16 UN	FN-331	47,7	6,4
1.375-18 UNEF	FN-351	47,7	6,4
M35 x 1,5	FN-352	55,1	10,9
1.625-16	FN-421	57,1	7,9
M42 x 1,5	FN-422	63,5	11,9
1.875-16	FN-481	63,5	13,0
M48 x 1,5	FN-482	74,9	13,0
2.125-16 UN	FN-551	79,5	9,7
M55 x 1,5	FN-552	80,0	13,0
2.500-16 UN	FN-651	82,5	9,9
M65 x 1,5	FN-652	95,0	14,0
3.125-16 UN	FN-801	104,9	13,0
M80 x 2	FN-802	115,1	16,0

Enerpac worksupport locked in position using an FN series self-locking flange nut.



Product dimensions in mm [mm]

A thread	Model number	B	C	D	E	F	H	J
▼ Yoke								
.312-24 UN	Y-3121	12,7	7,9	7,9	31,8	16	12,7	39,6

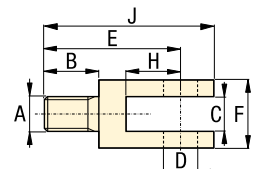

MF and AW-51 models

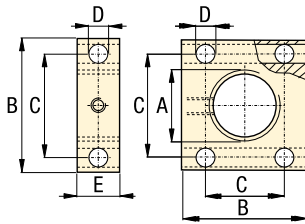

other AW models

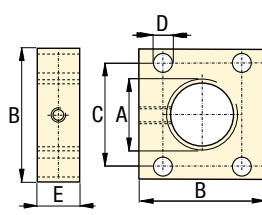

Product dimensions in mm [$\nabla \oplus$]

A thread	Model number	B	C	D \varnothing	E
▼ Mounting flanges – Rectangular					
1.375-18 UNEF	AW-5	44,5	34,0	6,9	12,7
1.500-16 UN	AW-51	57,1 x 69,8	41,1 x 53,8	10,4	25,4
1.875-16 UN	AW-89	57,2	45,0	8,4	25,4
2.500-16 UN	AW-19	82,6	55,1	8,9	24,9
3.125-16 UN	AW-90	95,3 x 120,7	60,4 x 88,9	16,3	31,8
.500-20 UNF	MF-121	38,1	25,4	6,9	25,4
M12 x 1,5	MF-122	39,9	24,9	6,4	24,9
1.000-12 UNF	MF-201	57,2	38,1	10,2	38,1
M20 x 1,5	MF-202	65,0	45,0	10,2	39,9
1.000-12 UNF	MF-251	63,5	44,5	10,2	38,1
1.125-16 UN	MF-281	69,8	50,8	10,2	38,1
M28 x 1,5	MF-282	74,9	50,0	10,2	39,9
1.313-16 UN	MF-331	76,2	57,2	10,2	38,1
1.375-18 UNF	MF-351	76,2	57,2	10,2	38,1
M35 x 1,5	MF-352	80,0	56,9	10,2	39,9
1.625-16 UN	MF-421	82,6	63,5	10,2	38,1
M42 x 1,5	MF-422	90,0	63,0	10,2	39,9
1.875-16 UN	MF-481	89,0	70,0	10,2	38,1
M48 x 1,5	MF-482	95,0	70,1	10,2	39,9
2.125-16 UN	MF-551	101,6	76,2	11,7	44,5
M55 x 1,5	MF-552	110,0	82,0	11,9	45,0
2.500-16 UN	MF-651	114,3	88,9	11,7	44,5
M65 x 1,5	MF-652	115,1	88,9	11,9	45,0
3.125-16 UN	MF-801	127,0	101,6	11,7	44,5
M80 x 2	MF-802	134,9	108,0	11,9	45,0

AW-53, -121

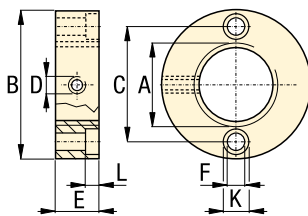

AW-102

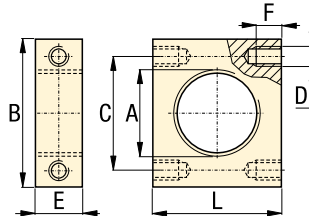

Product dimensions in mm [$\nabla \oplus$]

A thread	Model number	B \varnothing	C	D thread	E	F \varnothing	K \varnothing	L
▼ Mounting flanges – Cylindrical								
1.500-16 UN	AW-53	73,2	57,2	.250-20 UNC	19,1	7,1	10,4	7,9
2.750-16 UN	AW-121	114,3	92,2	.250-20 UNC	19,1	8,6	12,7	9,7
▼ Mounting flanges – Rectangular								
2.250-14 UNS	AW-102	101,6	76,2	.438-20 UNF	31,8	15,7	-	82,6

- E** Accesorios de cilindro
- F** Accessoires pour vérins
- D** Zubehör für Zylinder

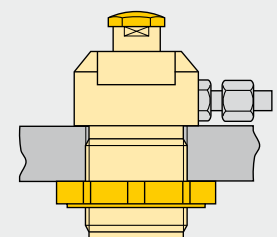
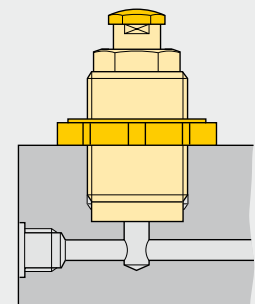
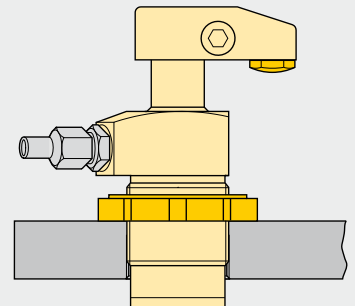
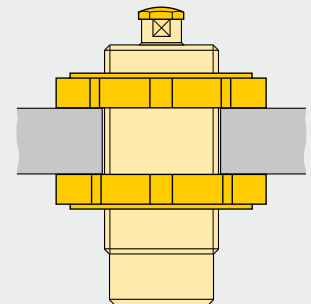
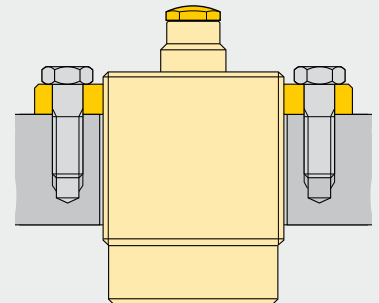

Linear Cylinders

Power Sources

Valves

Pallet Components

System Components

Yellow Pages

350 bar Tie Rod Cylinders *Application & selection*

Shown: TRFM-1506, TRFL-3210 and TRCM-3206



Enerpac 350 bar Tie Rod cylinders provide a variety of mounting options for pushing and positioning workpieces and fixtures on a machine.

Enerpac tie rod cylinders are designed to the highest industry standards to provide long life and worry-free performance in the most demanding applications.

Standard bore sizes

Bore diameter mm	Rod diameter mm	Capacity at 350 bar		Effective area	
		Push kN	Pull kN	Push cm ²	Pull cm ²
38,1	25,4	39	22	11,4	6,3
50,8	35,0	70	37	20,3	10,7
63,5	44,4	109	56	31,7	16,1
82,5	50,8	185	115	53,5	33,3
101,6	63,5	280	170	81,1	49,4

Additional bore sizes

Bore diameter mm	Rod diameter mm	Capacity at 350 bar	
		Push kN	Pull kN
127,0	88,9	437	223
152,4	101,6	629	349
177,8	127,0	856	419
203,2	139,7	1118	590

Contact Enerpac for ordering information on additional bore sizes.

Flexibility of motion

- Rod seal (1) uses spring loaded multiple lip vee rings, a supporting bronze bearing ring bushing and a double lip wiper
- Piston seal (2) combines two bi-directional sealing cast iron piston rings with two block vee seals with back-up rings
- Hardened chrome plated piston rod (3) resists scoring and corrosion, assuring maximum life
- Steel tubing barrel (4), honed to a fine finish assures superior sealing, minimum friction and maximum seal life
- Rod bushing and seals can be serviced by merely removing the retainer plate (5) on most models.

Tie Rod cylinder construction

- 1 Rod Seal
- 2 Piston Seal
- 3 Piston Rod
- 4 Barrel
- 5 Retainer Plate

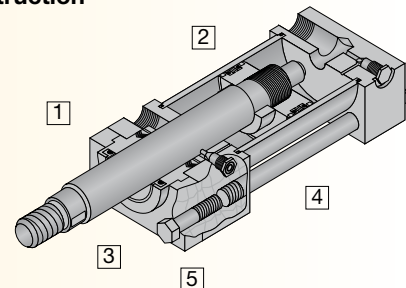

Tie Rod cylinder mounting styles

Clevis Mount – TRCM Series

- NFPA style MP1
- Allows cylinder to pivot
- Requires provision for pivoting on rod end.

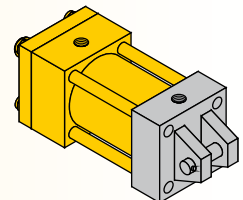

Foot mount – TRFM series

- NFPA style MS2
- Allows easy mounting with only four bolts
- Backup key included in design to ensure long life.

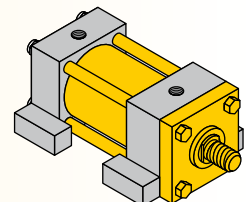

Flange mount – TRFL series

- NFPA style ME5
- Allows cylinder length to be buried in machine
- Strongest, most rigid mount.

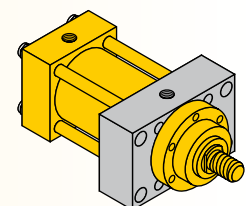

Product selection

Piston diameter	Rod diameter	Stroke	Clevis mount	Foot mount	Flange mount
mm	mm	mm			
38,1	25,4	50,8	TRCM-1502	TRFM-1502	TRFL-1502
38,1	25,4	101,6	TRCM-1504	TRFM-1504	TRFL-1504
38,1	25,4	152,4	TRCM-1506	TRFM-1506	TRFL-1506
38,1	25,4	254,0	TRCM-1510*	TRFM-1510	TRFL-1510
38,1	25,4	304,8	TRCM-1512*	TRFM-1512	TRFL-1512
50,8	35,0	50,8	TRCM-2002	TRFM-2002	TRFL-2002
50,8	35,0	101,6	TRCM-2004	TRFM-2004	TRFL-2004
50,8	35,0	152,4	TRCM-2006	TRFM-2006	TRFL-2006
50,8	35,0	254,0	TRCM-2010	TRFM-2010	TRFL-2010
50,8	35,0	304,8	TRCM-2012	TRFM-2012	TRFL-2012
63,5	44,4	50,8	TRCM-2502	TRFM-2502	TRFL-2502
63,5	44,4	101,6	TRCM-2504	TRFM-2504	TRFL-2504
63,5	44,4	152,4	TRCM-2506	TRFM-2506	TRFL-2506
63,5	44,4	254,0	TRCM-2510	TRFM-2510	TRFL-2510
63,5	44,4	304,8	TRCM-2512	TRFM-2512	TRFL-2512
82,5	50,8	50,8	TRCM-3202	TRFM-3202	TRFL-3202
82,5	50,8	101,6	TRCM-3204	TRFM-3204	TRFL-3204
82,5	50,8	152,4	TRCM-3206	TRFM-3206	TRFL-3206
82,5	50,8	254,0	TRCM-3210	TRFM-3210	TRFL-3210
82,5	50,8	304,8	TRCM-3212	TRFM-3212	TRFL-3212
101,6	63,5	50,8	TRCM-4002	TRFM-4002	TRFL-4002
101,6	63,5	101,6	TRCM-4004	TRFM-4004	TRFL-4004
101,6	63,5	152,4	TRCM-4006	TRFM-4006	TRFL-4006
101,6	63,5	254,0	TRCM-4010	TRFM-4010	TRFL-4010
101,6	63,5	304,8	TRCM-4012	TRFM-4012	TRFL-4012

Cushions are available for all cylinder models. Cushions slow down heavy loads prior to end of stroke, preventing damage to the cylinder of the machine. To add cushions to your Enerpac Tie Rod cylinder, simply add the letter "C" to the end of any model number. Note: the addition of cushions does not affect the outside dimensions of the cylinder.

* These models are only rated to 276 bar due to constraints on the mechanical properties of the rod.

Custom build your Tie Rod cylinder

TR	CM	15	12	C
1	2	3	4	5
1 Product Type TR = Tie Rod		3 Bore Diameter (mm) 15 = 38,1 mm 20 = 50,8 25 = 63,5 32 = 82,5 40 = 101,6	4 Stroke (mm) 02 = 50,8 04 = 101,6 06 = 152,4 10 = 254,0 12 = 304,8	5 Cushions Blank = None C = Cushions both ends
2 Mounting CM = Clevis Mount FM = Foot Mount FL = Flange Mount				

Seal and repair kits

Seal kits include piston, rod and barrel seals. Repair kits include seal kit plus rod bushing and rear bearing ring.

Product dimensions in mm

Bore diameter mm	Rod diameter mm	Seal kit	Repair kit
38,1	25,4	TR15SK	TR15RK
50,8	35,0	TR20SK	TR20RK
63,5	44,4	TR25SK	TR25RK
82,5	50,8	TR32SK	TR32RK
101,6	63,5	TR40SK	TR40RK

Force: 39 - 280 kN

Stroke: 50,8 - 304,8 mm

Pressure: 35 - 350 bar

E Cilindros Atirantados

F Vérins à tirants

D Zugankerzylinder

Options

Accessories

93 ▶



ZW Series Pumps

114 ▶



VP Series Valves

136 ▶



Fittings

194 ▶



Important

Consult individual product selection pages for application and installation criteria specific to each mounting style. If you are unsure of an application, contact Enerpac directly.

Enerpac can provide many other tie rod cylinders in a wide variety of mounting styles, bore and stroke sizes. Contact Enerpac directly and talk to our Custom Products group for a quotation.

Shown: TRCM-3204



TR series clevis mount

Enerpac clevis mount 350 bar Tie Rod cylinders provide for motion in two axis, increasing the range of motion on your machine with only one cylinder.

Special rod ends

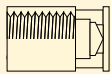

- Either internal or external threads available
- Custom designs to match your tooling requirements

Flexibility of motion

- Clevis mount cylinders include pivot pin for mounting in your machine
- Standard rod eyes and rod clevises available for each bore size.
- NFPA style MP1
- Designed to carry shear loads
- Pivot pins should be carried by rigidly held bearings and closely fit for the entire length of the pin

TRCM models Clevis mount

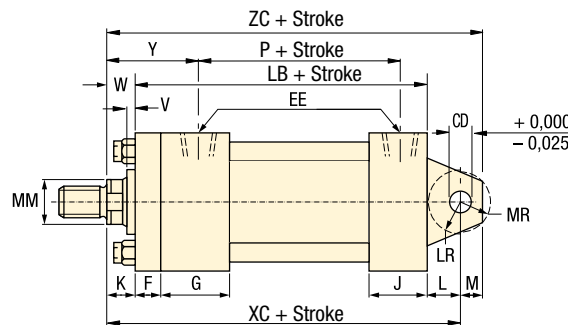
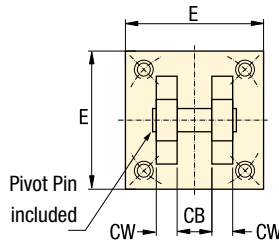

Force: 39 - 280 kN

Stroke: 50,8 - 304,8 mm

Pressure: 35 - 350 bar

E Cilindros Atirantados

F Vérins à tirants

D Zugankerzylinder

Options

Accessories

93



ZW Series Pumps

114



VP Series Valves

136



Fittings

194



Dimensions in mm [mm]

Bore diameter	Rod diameter	Model number	A	B	C	CB	CD	CW	D*	E	EE	F	G	J	K
38,1	25,4	TRCM-15xx**	28,7	38,1	12,7	19,0	12,7	12,7	22,3	63,5	SAE #10	9,6	44,4	38,1	12,7
50,8	35,0	TRCM-20xx	41,4	50,8	16,0	31,7	19,0	16,0	28,7	76,2	SAE #10	16,0	44,4	38,1	16,0
63,5	44,4	TRCM-25xx	50,8	60,4	19,0	31,7	19,0	16,0	38,1	88,9	SAE #10	16,0	44,4	38,1	16,0
82,5	50,8	TRCM-32xx	57,1	66,8	22,3	38,1	25,4	19,0	42,9	114,3	SAE #12	19,0	50,8	44,4	19,0
101,6	63,5	TRCM-40xx	76,2	79,5	25,4	50,8	35,0	25,4	52,3	127,0	SAE #12	22,3	50,8	44,4	19,0

* D = Distance across plunger wrench flats.

** 254 and 305 mm models are rated at only 276 bar.

Bore diameter	Rod diameter	Model number	KK2	L	LB	LR	M	MM	MR	NA	P	V	W	XC	Y	ZC	kg
38,1	25,4	TRCM-15xx	3/4"-16	19,0	127,0	16,0	12,7	25,4	16,7	24,6	54,1	12,7	25,4	171,4	60,4	184,1	***
50,8	35,0	TRCM-20xx	1"-14	31,7	133,3	28,7	19,0	35,0	23,8	34,0	73,1	9,6	25,4	190,5	66,8	209,5	***
63,5	44,4	TRCM-25xx	1-1/4"-12	31,7	136,6	28,7	19,0	44,4	23,8	43,1	76,2	12,7	31,7	200,1	73,1	219,2	***
82,5	50,8	TRCM-32xx	1-1/2"-12	38,1	158,7	31,7	25,4	50,8	30,2	49,5	91,1	9,6	31,7	228,6	78,4	254,0	***
101,6	63,5	TRCM-40xx	1-7/8"-12	54,1	168,4	47,7	35,0	63,5	35,0	62,2	98,5	9,6	35,0	257,3	84,0	292,1	***

*** For product weights, please reference the price list or contact Enerpac customer service for more information.

Force: 39 - 280 kN

Stroke: 50,8 - 304,8 mm

Pressure: 35 - 350 bar

E Cilindros Atirantados

F Vérins à tirants

D Zugankerzylinder

Options

Accessories

93 ▶



ZW Series Pumps

114 ▶



VP Series Valves

136 ▶



Fittings

194 ▶

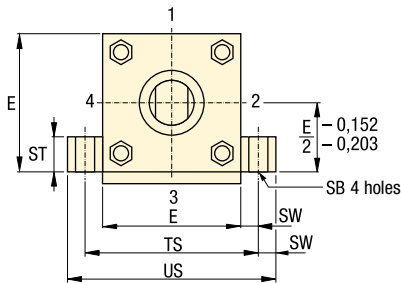

Ease of installation

- Foot mount cylinders provide simplest mounting option with just four bolt holes required
- Standard key mount is included ensuring proper mounting and adding rigidity
- NFPA style MS2
- Compact mounting fits in tight spaces where other cylinders cannot

TRFM models Foot Mount

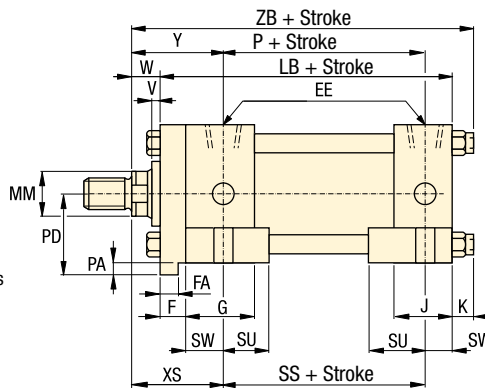
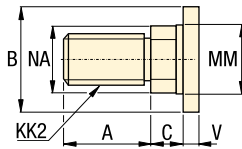

Shown: TRFM-1506



TR series foot mount

Enerpac foot mount 350 bar Tie Rod cylinders provide a high quality positioning solution using a minimal amount of space.

Important

Some custom options may require reduction of working pressure or special installation considerations. Contact Enerpac Technical Service to discuss your application.

Special rod ends

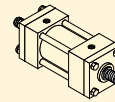

Double rod ends

- Available on all models except clevis mounts
- The two rod ends can be different on the same cylinder

Dimensions in mm []

Bore diameter	Rod diameter	Model number	A	B	C	D*	E	EE	F	FA	G	J	K	KK2	LB	MM
38,10	25,40	TRFM-15xx	28,70	38,10	12,70	22,35	63,5	SAE #10	9,65	7,87-7,92	44,45	38,10	12,70	3/4"-16	127,00	25,4
50,80	35,05	TRFM-20xx	41,40	50,80	16,00	28,70	76,20	SAE #10	16,00	14,22-14,27	44,45	38,10	16,00	1"-14	133,35	35,05
63,50	44,45	TRFM-25xx	50,80	60,45	19,05	38,10	88,90	SAE #10	16,00	14,22-14,27	44,45	38,10	16,00	1-1/4"-12	136,65	44,45
82,55	50,80	TRFM-32xx	57,15	66,80	22,35	42,93	114,3	SAE #12	19,05	17,37-17,45	50,80	44,45	19,05	1-1/2"-12	158,75	50,80
101,60	63,50	TRFM-40xx	76,20	79,50	25,40	52,32	127,00	SAE #12	22,35	20,55-20,62	50,80	44,45	19,05	1-7/8"-12	168,40	63,50

* D = Distance across plunger wrench flats.

Bore diameter	Rod diameter	Model number	NA	P	PA	PD	SB	SS	ST	SU	SW	TS	US	V	W	XS	Y	ZB	kg
38,10	25,40	TRFM-15xx	24,64	73,15	4,82	36,58	11,18	98,55	12,7	23,88	9,65	82,55	101,60	12,70	25,40	44,45	60,45	165,10	***
50,80	35,05	TRFM-20xx	34,04	73,15	7,87	45,97	14,22	92,20	19,05	31,75	12,7	101,60	127,00	9,65	25,40	54,10	66,80	174,75	***
63,50	44,45	TRFM-25xx	43,18	76,2	7,87	52,32	20,57	85,85	25,40	39,62	17,53	123,95	158,75	12,70	31,75	65,02	73,15	184,15	***
82,55	50,80	TRFM-32xx	49,53	91,19	9,65	66,80	20,57	104,90	25,40	39,62	17,53	149,35	184,15	9,65	31,75	68,33	78,49	209,55	***
101,60	63,50	TRFM-40xx	62,23	98,55	11,18	74,68	26,93	101,60	31,75	50,80	22,35	171,45	215,90	9,65	35,05	79,50	84,07	222,25	***

*** For product weights, please reference the price list or contact Enerpac customer service for more information.

Shown: TRFL-3206



TR series flange mount
Enerpac flange mount 350 bar Tie Rod cylinders provide the most rigid mounting ensuring long life and high accuracy on your machine.

Extra strong

- Flange mount is part of the cylinder end cap, providing maximum strength and rigidity
- Allows length of cylinder to be mounted inside the machine
- NFPA style ME5
- Simple four bolt mounting pattern makes installation easy
- Mounting is best suited for tension applications

Force: 39 - 280 kN

Stroke: 50,8 - 304,8 mm

Pressure: 35 - 350 bar

E Cilindros Atirantados

F Vérins à tirants

D Zugankerzylinder

Options

Accessories  [86](#)

ZW Series Pumps  [114](#)

VP Series Valves  [136](#)

Fittings  [194](#)

TRFL models Flange Mount

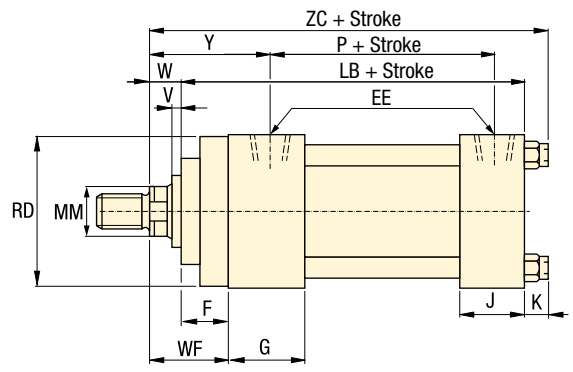
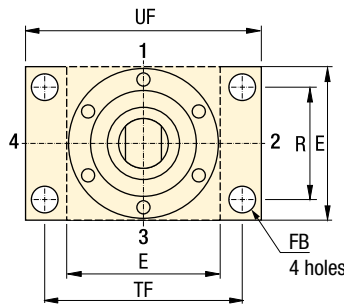
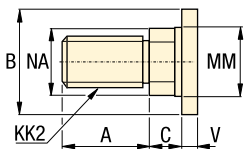

Special rod ends

Rod boots

- Rod boots are made from neoprene coated fabric
- Impervious to oil grease and water
- Rated for temperatures from 7,8 °C to 93,3 °C

Metallic wipers

- Recommended in applications where contaminants tend to cling to the rod surface
- Available on all rod diameters

Dimensions in mm [$\pm 0,05$]

Bore diameter	Rod diameter	Model number	A	B	C	D*	E	EE	F	FB	G	J	K	KK2
38,10	25,40	TRFL-15xx	28,70	38,10	12,70	22,35	63,50	SAE #10	9,6	11,1	44,45	38,10	12,70	3/4"-16
50,80	35,05	TRFL-20xx	41,40	50,80	16,00	28,70	76,20	SAE #10	16,0	14,2	44,45	38,10	16,0	1"-14
63,50	44,45	TRFL-25xx	50,80	60,45	19,05	38,10	88,90	SAE #10	16,0	14,2	44,45	38,10	16,0	1-1/4"-12
82,55	50,80	TRFL-32xx	57,15	66,80	22,35	42,9	114,30	SAE #12	19,05	17,5	50,80	44,45	19,0	1-1/2"-12
101,60	63,50	TRFL-40xx	76,20	79,5	25,40	52,3	127	SAE #12	22,35	17,5	50,80	44,45	19,0	1-7/8"-12

* D = Distance across plunger wrench flats.

Bore diameter	Rod diameter	Model number	LB	MM	NA	P	R	RD	TF	UF	V	W	WF	Y	ZB	
38,10	25,40	TRFL-15xx	127,0	25,4	24,6	73,15	41,40	-	87,38	107,95	12,70	25,40	35,05	60,45	165,10	***
50,80	35,05	TRFL-20xx	133,3	35,0	34,0	73,15	52,07	-	104,90	130,30	9,65	25,40	41,40	66,80	174,75	***
63,50	44,45	TRFL-25xx	136,6	44,4	43,18	76,20	64,77	-	117,60	143,00	12,70	31,75	47,75	73,15	184,15	***
82,55	50,80	TRFL-32xx	158,7	50,8	49,53	91,19	82,55	101,60	149,35	181,10	9,65	31,75	50,80	78,49	209,55	***
101,60	63,50	TRFL-40xx	168,4	63,5	62,23	98,55	97,03	114,30	162,05	193,80	9,65	35,05	57,15	84,07	222,25	***

*** For product weights, please reference the price list or contact Enerpac customer service for more information.

For high production applications

- Fit any style of Enerpac tie-rod cylinder
- Rod eyes and rod clevises
 - Required for proper mounting of TRCM series cylinders
 - Pivot pins supplied separately
- Pivot pins for rod eyes and clevises
 - Provided with cotter pins
 - Must be ordered separately
- Linear alignment coupler
 - Prevents binding caused by misalignment
 - Reduces rod seal and bearing wear

Fittings dimensions in mm []

From	To	Model number	A	B	C	D
SAE #10	3/8" NPT	FZ2077	33,2	25,4	SAE #10	3/8" NPT
SAE #12	3/8" NPT	FZ2078	25,4	31,7	SAE #12	3/8" NPT
SAE #10	SAE #6	FZ2079	32,0	25,4	SAE #10	SAE #6
SAE #12	SAE #6	FZ2080	24,4	31,7	SAE #12	SAE #6

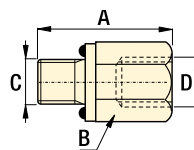

TRRE-15, TRCC-15, TRPP-15, TRAC-15



 Enerpac 350 bar Tie-Rod cylinder accessories allow you to complete your design making installation on your machine a simple project.

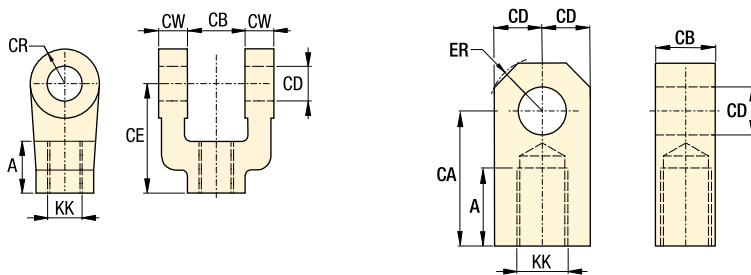

Rod Clevis and Rod Eye dimensions in mm []

Rod clevis model number	Rod eye model number	Maximum tension load kN	KK	A	CA	CB	CD	CE	CR	CW	ER	Clevis Pin
TRRC-15	TRRE-15	55	3/4"-16	28,7	52,3	31,7	19,0	60,4	19,0	16,0	23,8	TRPP-15
TRRC-20	TRRE-20	90,9	1"-14	41,4	71,3	38,1	25,4	79,5	25,4	19,0	28,7	TRPP-20
TRRC-25	TRRE-25	135,6	1-1/4"-12	50,8	87,3	50,8	35,0	104,9	35,0	25,4	39,6	TRPP-25
TRRC-32	TRRE-32	220	1-1/2"-12	57,1	101,6	63,5	44,4	114,3	41,4	31,7	47,7	TRPP-32
TRRC-40	TRRE-40	311,8	1-7/8"-12	76,2	127,0	63,5	50,8	139,7	50,8	31,75	50,8	TRPP-40

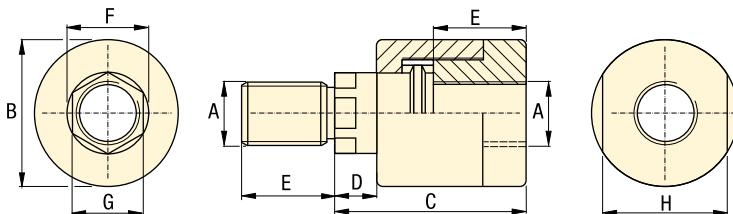

Linear Alignment Coupler in mm []

Model number	Maximum tension load kN	A	B	C	D	E	F	G	H
TRAC-15	37,8	3/4"-16	44,4	58,6	12,7	28,7	24,6	22,3	38,1
TRAC-20	71,1	1"-14	63,5	74,6	12,7	41,4	35,0	29,4	57,1
TRAC-25	86,7	1-1/4"-12	63,5	74,6	12,7	41,4	35,0	29,4	57,1
TRAC-32	149	1-1/2"-12	82,5	111,2	20,5	57,1	44,45	38,1	76,2
TRAC-40	266,9	1-7/8"-12	95,2	138,1	22,3	76,2	50,8	47,7	88,9