

System

System Components

From the simplest to the most complex hydraulic system, Enerpac's system components help you complete your design. Gauges, pressure switches, couplers and hoses are simple but necessary items for any hydraulic system, and Enerpac can provide the full range.









Technical support

- Safety instructions
- Basic hydraulic information
- Advanced hydraulic technology
- FMS (Flexible Machining Systems) technology
- Conversion charts and hydraulic symbols

 197 ▶

components

	▼ series	▼ page	
Pressure switches	IC, PB PSCK	188	
Digital pressure gauges	DG	189	
Pressure gauges	G	190	
Gauge accessories	GA, GS NV, FM	191	
Manifolds, couplers, hoses, tubing	A, AH/R HLS, H, T	192	
High pressure filters, hydraulic oil	FL, HF	193	
High pressure fittings	BFZ, FZ	194-196	

Shown: PSCK-8, IC-51



Enerpac remote mounted pressure switches monitor the hydraulic system to determine any change of pressure. The signal can then be used to control the pump, or other peripheral devices.

IC-series

The IC-series electrical pressure switches provide pressure readings for monitoring and/or control of hydraulic system pressure in workholding systems.

Reliable electrical control of hydraulic power

- Compact design minimizes space requirements on fixture
- Switch is easily adjustable to meet system requirements

IC series

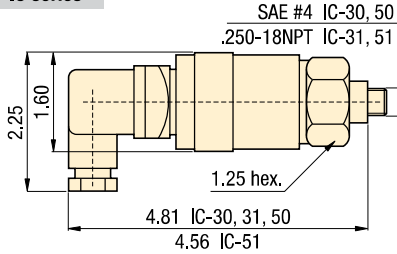

PSCK-8, 9

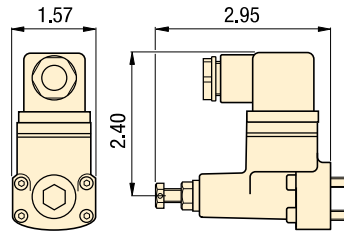

mounting dimensions

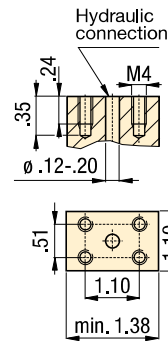

PB-4

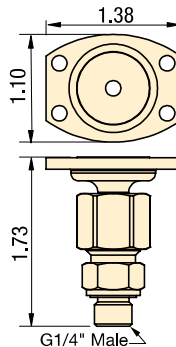

Pressure: 500-7500 psi

Accuracy: 2%

- (E)** Presostatos
- (F)** Pressostats
- (D)** Druckschalter



Options

Fittings

194 ▶



Gauges

190 ▶



Important

Do not exceed the maximum pressure.

Integrated in your hydraulic system, the pressure switch can be used to automate your clamping cycles.



Product selection

Adjustable pressure range	Electrical specifications	Model number	Deadband	Switch point repeatability	Oil port	
psi	at 50/60 Hz		psi	% of range		lb
▼ Electrical pressure switches						
500-3500	125 VAC @ 5 A	IC-30	100 - 500	+ /-2	SAE #4	1.0
500-3500	125 VAC @ 5 A	IC-31	100 - 500	+ /-2	.250-18 NPT	1.0
3000-7500	125 VAC @ 5 A	IC-50	250 - 800	+ /-2	SAE #4	1.0
3000-7500	125 VAC @ 5 A	IC-51	250 - 800	+ /-2	.250-18 NPT	1.0
1450-5000	115 VAC @ 2 A	PSCK-8	250 - 800	+ /-2	Manifold mount	0.8
290-3045	115 VAC @ 2 A	PSCK-9	250 - 800	+ /-2	Manifold mount	0.8
-	-	PB-4	-	-	G 1/4"	.25

Pressure: 0-20,000 psi

Accuracy: ± 0.25%

Voltage: 3 VDC (battery)

- E** Manómetros digitales
- F** Manomètres digitaux
- D** Digitale Manometer

Options

Fittings

194 ▶



Gauge adaptors

190 ▶



Important

Do not exceed the maximum pressure.

Gauges can be easily installed into the hydraulic system using GA-3 gauge adaptor.

191 ▶

Protective cover included

Fits over face of gauge for protection in harsh environments.

Easy and precise pressure monitoring

DGR-2

- Rated for system pressure up to 20,000 psi
- Displays in multiple units: psi, bar, mPA, kg/cm² (user selectable)
- Zero reset – ensures that gauge reads actual system pressure
- Batteries included, condition indicator on readout
- IP65 rated case design
- Shut off selectable – menu driven
- UL listed, CE and RoHS compliant

Shown: DGR-2



DGR-18

▶ Enerpac digital pressure gauges offer greater accuracy and are easier to read than conventional dial gauges, greatly enhancing your ability to monitor and control hydraulic system pressure.

DGR-2 Remote Operation

Battery operated for additional flexibility. Includes maximum and minimum pressure capture.

Back-lit Readout

Back-lit readout allows easy reading in less than ideal lighting.

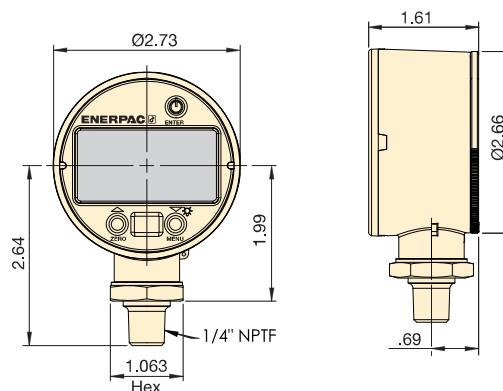

Product selection

Pressure rating		Model	Pressure rating		Pressure rating		Pressure rating		lbs
psi			bar	MPa	Kg/cm ²				
Range	Resolution		Range	Resolution	Range	Resolution	Range	Resolution	
0-20,000	1	DGR-2	0-1380	0.1	0-140	0.01	0-1400	0.1	0.5

Shown: GS-2, G-2512L, GS-3



Enerpac gauges provide a safe and inexpensive monitoring system for your hydraulic circuit

Highly reliable and accurate pressure sensing

- ± 1.5% accuracy of full scale
- All pressure sensing parts sealed and dampened by glycerine for long life
- Includes safety blow-out disk and pressure equalizing membrane to prevent overpressurization
- Copper alloy, coiled safety Bourdon tube for 1000 psi and higher
- Dual psi and bar scale readings, 2.5 inch gauge face

Gauge accessories for easy installation

- Needle valves providing positive shut-off
- 303 stainless steel stem (NV-251)
- Snubber valves to control pressure surges between gauge and hydraulic system
- Gauge adaptors – male end screws into pump or cylinder, female port accepts hose or coupler, the third port is for gauge connection
- FM-25NG for panel mounting of 2.50 inch diameter gauges

Product selection

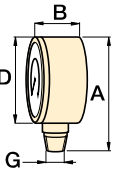
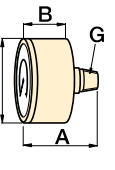
Pressure gauge mounting style	Pressure range		Model number	PSI graduation		Bar graduation		A in	B in	D in	G
	psi	bar		Major psi	Minor psi	Major bar	Minor bar				
▼ Pressure gauge - Lower mount											
	0-100	0-7	G-2509L	10	2	1	0,01	3.31	1.46	2.50	1/4" NPT
	0-160	0-11	G-2510L	10	2	1	0,02	3.31	1.46	2.50	1/4" NPT
	0-200	0-14	G-2511L	50	5	1	0,02	3.31	1.46	2.50	1/4" NPT
	0-300	0-20	G-2512L	50	5	5	0,05	3.31	1.46	2.50	1/4" NPT
	0-600	0-40	G-2513L	100	10	10	1	3.31	1.46	2.50	1/4" NPT
	0-1000	0-70	G-2514L	100	20	10	1	3.31	1.46	2.50	1/4" NPT
	0-2000	0-140	G-2515L	500	50	10	2	3.31	1.46	2.50	1/4" NPT
	0-3000	0-200	G-2516L	500	50	50	5	3.31	1.46	2.50	1/4" NPT
	0-6000	0-400	G-2517L	1000	100	100	10	3.31	1.46	2.50	1/4" NPT
	0-10,000	0-700	G-2535L	2000	200	100	10	3.31	1.46	2.50	1/4" NPT
	0-1000	0-70	G-2514SL	100	20	10	1	3.66	1.23	2.50	SAE#4
	0-3000	0-200	G-2516SL	500	50	50	5	3.66	1.23	2.50	SAE#4
	0-6000	0-400	G-2517SL	1000	100	100	10	3.66	1.23	2.50	SAE#4
	0-10,000	0-700	G-2535SL	2000	200	100	10	3.66	1.23	2.50	SAE#4
	▼ Pressure gauge - Rear mount										
	0-1000	0-70	G-2531R	100	20	10	1	2.48	1.46	2.50	1/4" NPT
	0-6000	0-400	G-2534R	1000	100	100	10	2.48	1.46	2.50	1/4" NPT
	0-10,000	0-700	G-2537R	2000	200	100	10	2.48	1.46	2.50	1/4" NPT
	0-1000	0-70	G-2531SR	100	20	10	1	2.46	1.23	2.50	SAE #4
	0-3000	0-200	G-2533SR	500	50	50	5	2.46	1.23	2.50	SAE #4
	0-6000	0-400	G-2534SR	1000	100	100	10	2.46	1.23	2.50	SAE #4
	0-10,000	0-700	G-2537SR	2000	200	100	10	2.46	1.23	2.50	SAE #4
	0-1000	0-70	1531R	100	20	10	1	1.99	0.98	1.50	1/8" NPT
	0-3000	0-200	1533R	500	100	50	10	1.99	0.98	1.50	1/8" NPT
	0-6000	0-400	1534R	1000	100	100	10	1.99	0.98	1.50	1/8" NPT
	0-10,000	0-700	1537R	2000	200	100	10	1.99	0.98	1.50	1/8" NPT

Collet-Lok® product line
 Swing clamps
 Work supports
 Linear clamps
 Power sources
 Valves
 Pallet components
 System components

Pressure: 0-10,000 psi

Accuracy: 1.5% /full scale

Gauge face: ϕ 2.5 inch

(E) Manómetros

(F) Manomètres

(D) Manometer

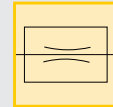
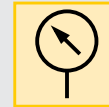

GA-1

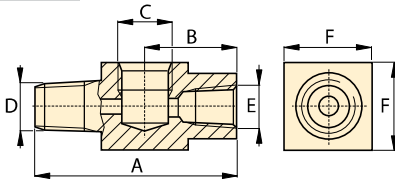

GA-2, -3, -4

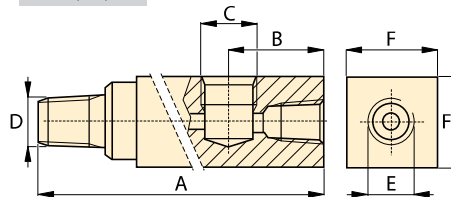

GA-918

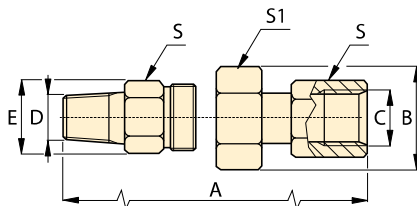

GS-2, -3

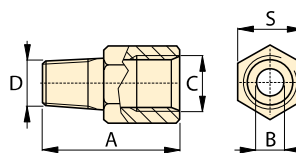

NV-251, V-91

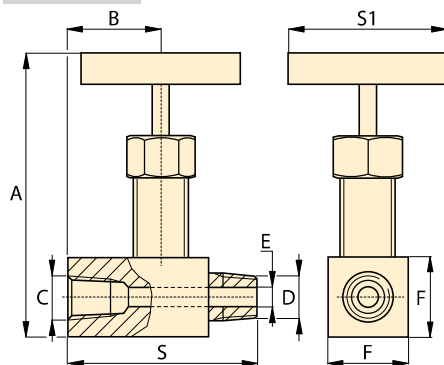

FM-25NG

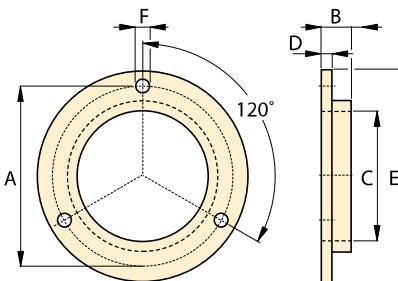

Product dimensions in inches []

Gauge port NPT	Max. pressure psi	Model number	Dimensions							
			A	B	C	D	E	F	S	S1
▼ Gauge adaptors										
1/2"	10,000	GA-1	2.81	1.24	1/2"NPT	3/8"NPT	3/8"NPT	1.25	-	-
1/2"	10,000	GA-2	6.10	1.38	1/2"NPT	3/8"NPT	3/8"NPT	1.25	-	-
1/4"	10,000	GA-3	5.25	1.38	1/4"NPT	3/8"NPT	3/8"NPT	1.25	-	-
1/2"	10,000	GA-4	4.38	1.38	1/2"NPT	1/4"NPT	3/8"NPT	1.25	-	-
▼ Swivel gauge adaptor										
1/2"	10,000	GA-918	2.25	1.72	1/2"NPT	1/2"NPT	1.30	-	1.13	1.50
▼ Gauge shut-off valves										
1/4"	10,000	NV-251	2.25	1.14	1/4"NPT	1/4"NPT	.17	.75	2.25	2.50
1/2"	10,000	V-91	3.50	1.25	1/2"NPT	1/2"NPT	.19	1.25	2.50	2.50
▼ Gauge snubber valves										
1/4"	5000	GS-2	1.63	.018	1/4"NPT	SAE #4	-	-	.75	-
1/4"	5000	GS-3	1.63	.018	1/4"NPT	G1/4"	-	-	.75	-
▼ Flange mounting for panel mounting of G series gauges										
-	-	FM-25NG	2.95	.17	2.51	.07	3.35	.14	-	-

Options

Hoses and couplers

192 ▶



Digital gauges

189 ▶



Pressure switches

188 ▶



V-10 Auto Damper® valve

157 ▶



Important

Do not exceed maximum pressure.

Gauge snubbers or needle valves are recommended for high cycle applications.

Do not keep gauges under permanent pressure. The use of shut-off valves is recommended.

For basic system set-up information, refer to our "Yellow Pages" section.

202 ▶

Manifolds, couplers, hoses, tubing

Shown: HLS, HF, AH, AR, FL, T, A-series



Use genuine Enerpac manifolds, couplers, hoses and tubings to connect your workholding cylinders or fixtures to the hydraulic power source.

A series, Manifolds

For multiple hydraulic line connections at one central location directing oil to or from a pressure source.

AH/AR series, Couplers

Quick disconnect low leakage couplers for easy connection of hydraulic circuits.

HLS series, Hoses

High pressure hydraulic hoses, featuring a heavy-duty protective plastic coating.

T-series, Tubing

High pressure steel tubing, available in 5 ft. lengths.

Manifolds

- Easy to connect
- Mounting holes on all models

Couplers

- Spee-D-Coupler® design allows cylinder to be connected and disconnected in seconds
- For more safety: couplers cannot be connected or disconnected while under hydraulic pressure

Hydraulic hoses and tubings

- Heavy-duty coating for abrasion resistance
- Resistant against mineral based hydraulic oil as well as water glycols
- High pressure steel tubing for permanent installations

Important

Do not exceed the maximum pressure.

Inspect hoses and tubing frequently and replace as required.

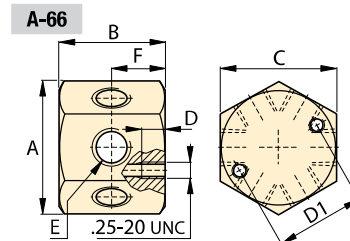
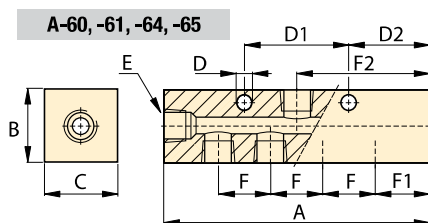
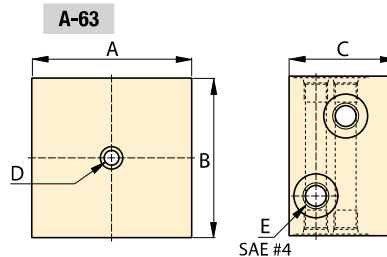

Manifolds dimensions in inches [mm]

Number of ports	Model number	A	B	C	D	D1	D2	E	F	F1	F2	⚖️ lbs
2 x 4	A-63	3.00	3.00	2.00	.25	-	-	SAE #4	-	-	-	2.0
5	A-60	3.50	1.25	1.25	.28	1.50	1.00	SAE #4	1.50	1.00	1.75	1.0
7	A-61	6.50	1.25	1.25	.28	1.50	1.25	SAE #4	1.00	1.25	3.25	1.4
7	A-64	7.00	1.25	1.25	.25	3.00	1.25	.375-18 NPT	1.50	1.25	3.50	3.3
7	A-65	14.5	1.25	1.25	.25	8.00	1.25	.375-18 NPT	4.00	1.25	7.25	6.1
6	A-66	2.30	1.63	2.00	.52	1.50	-	.375-18 NPT	-	-	-	1.8

Couplers

AH-650

Male coupler half
.250-18 NPT

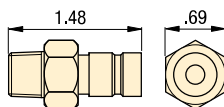

AH-652

Male coupler half
G1/4" BSPP

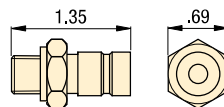

AH-654

Male coupler half
SAE #4 .437-20 UNF

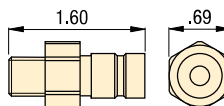

AR-650

Female coupler half
.250-18 NPT

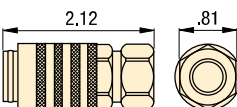

Hoses

Length ft	Model number	Internal diameter in	Maximum pressure psi
▼ 1/4", 37° flare			
1	HLS-512	.19	5000
2	HLS-524	.19	5000
3	HLS-536	.19	5000
4	HLS-548	.19	5000
5	HLS-560	.19	5000
10	HLS-5120	.19	5000
▼ 3/8" NPT			
3	H-9203	.25	10,000
6	H-9206	.25	10,000
10	H-9210	.25	10,000

Tubing

Length ft	Model number	Internal diameter in	External diameter in	Max. pressure psi
5	T-2560	.152	.25	5000

Options

Fittings

194 ▶



Collet-Lok® product line
 Swing clamps
 Work supports
 Linear clamps
 Power sources
 Valves
 Pallet components
 System components

High-pressure filters

- Keep your hydraulic system clean
- Pleated stainless steel wire mesh screen construction provides large filter area in a compact size
- Rated for full system pressure up to 5000 psi
- Bi-directional design allows filtration of oil in either flow direction
- Two piece body construction for easy replacement of filter elements
- High flow rates are obtainable with a minimum pressure drop
- Threaded port connections on each end simplify installation

Hydraulic oil

- Ensures effective lubricity
- Protects essential parts

Filtration

20 micron filter provides the longest service life before element replacement

10 micron filter recommended for more sensitive hydraulic components

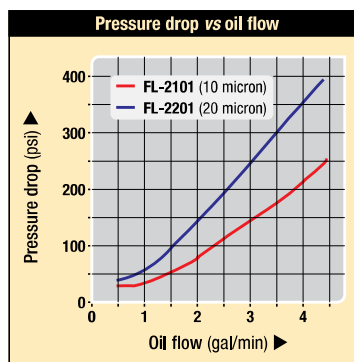

FL series

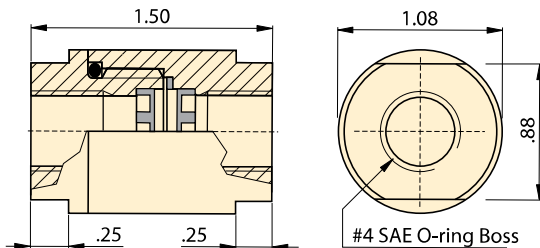

High in line pressure filters

Model number	Filtration		Filter element set	lbs
	Nominal	Absolute		
FL-2101	10	25	FL-2101K	.4
FL-2201	20	40	FL-2201K	.4

Hydraulic oil

Contents	Model number	Specifications	
		genuine Enerpac hydraulic oil	
Gal			
.25	HF-100	0 °F	<12,000 S.U.S
1	HF-101	100 °F	150/165 S.U.S
5	HF-102	210 °F	42/45 S.U.S
55	HF-104	Flash, C.O.C.	400°F
		Pour point	-25°F
		Aniline point	210/220 °F

Note: Viscosity index: 100 min

www.enerpacwh.com

- E** Mangueras, Filtros Acoplamiento, Aceite
- F** Flexibles, Filtres Raccords, Huile
- D** Schläuche, Filter Kupplungen, Öl

High-pressure filters

Compact in line high pressure filters prevent chips and debris that have entered the hydraulic fluid system from damaging hydraulic system components.

Hydraulic oil

Use only genuine Enerpac hydraulic oil to guarantee optimal performance and long life of your hydraulic equipment.

Options

Fittings

194 ▶



Important

Do not exceed the maximum pressure.

Hydraulic power is distributed by manifolds and transported by hoses and tubing.

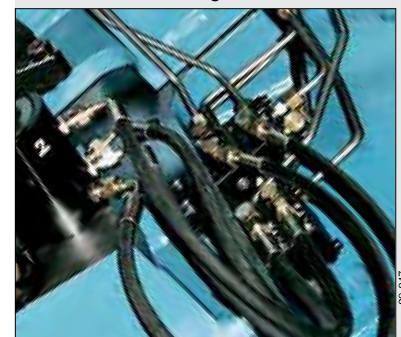

High Pressure Fittings *Selection & dimensions*

Shown: FZ-2052, FZ-2054, FZ-2023



Fitting are used to connect all cylinders, components, power sources, tubes, gauges and hoses in a hydraulic system. Enerpac fittings provide flexible, safe and leak-free connections.

Proper connection for hydraulic components

- Male and female NPT, SAE, BSPP threaded fittings in common sizes allow easy connection of all components.
- BFZ and FZ-1000 models are 10,000 psi maximum pressure
- FZ-2000 models are 5000 psi maximum pressure

Product selection

From	To	Max. pressure psi	Model number	Dimensions in inches			
				A	B	C	D
▼ Adapters							
Female		Male					
1/4" NPT	1/8" NPT	10,000	FZ-1642	1.21	3/4"	1/8"-27 NPT	1/4"-18 NPT
3/8" NPT	1/4" NPT	10,000	FZ-1055	1.44	7/8"	1/4"-18 NPT	3/8"-18 NPT
1/2" NPT	1/4" NPT	10,000	FZ-1633	1.69	1-1/8"	1/4"-18 NPT	1/2"-14 NPT
1/2" NPT	3/8" NPT	10,000	FZ-1634	1.69	1-1/8"	3/8"-18 NPT	1/2"-14 NPT
▼ Reducers							
Female		Male					
1/4" NPT	3/8" NPT	10,000	FZ-1630	.86	3/4"	1/4"-18 NPT	3/8"-18 NPT
1/4" NPT	1/2" NPT	10,000	FZ-1661	1.11	7/8"	1/4"-18 NPT	1/2"-14 NPT
SAE #6	SAE #8	5000	FZ-2029	1.38	1-1/16"	9/16"-18	3/4"-16
▼ NPT Male Nipples							
1/4" NPT	1/4" NPT	10,000	FZ-1608	1.45	5/8"	1/4"-18 NPT	1/4"-18 NPT
3/8" NPT	3/8" NPT	10,000	FZ-1617	1.45	3/4"	3/8"-18 NPT	3/8"-18 NPT
3/8" NPT	3/8" NPT	10,000	FZ-1619	2.00	3/4"	3/8"-18 NPT	3/8"-18 NPT
3/8" NPT	G1/4"	10,000	BFZ-305	1.42	3/4"	3/8"-18 NPT	G1/4"-19
▼ NPT Female Connectors							
1/4" NPT	1/4" NPT	10,000	FZ-1605	1.13	3/4"	1/4"-18 NPT	1/4"-18 NPT
3/8" NPT	1/4" NPT	10,000	FZ-1615	1.13	7/8"	3/8"-18 NPT	1/4"-18 NPT
3/8" NPT	3/8" NPT	10,000	FZ-1614	1.13	7/8"	3/8"-18 NPT	3/8"-18 NPT
1/2" NPT	3/8" NPT	10,000	FZ-1625	1.50	1-1/8"	1/2"-14 NPT	3/8"-18 NPT
▼ NPT Elbows							
1/4" NPT	1/4" NPT	10,000	FZ-1638	.88	3/4"	1/4"-18 NPT	1/4"-18 NPT
3/8" NPT	3/8" NPT	10,000	FZ-1610	1.02	7/8"	3/8"-18 NPT	3/8"-18 NPT
▼ NPT Tee							
1/4" NPT	1/4" NPT	10,000	FZ-1637	1.76	3/4"	1/4"-18 NPT	1/4"-18 NPT
3/8" NPT	3/8" NPT	10,000	FZ-1612	2.04	7/8"	3/8"-18 NPT	3/8"-18 NPT
▼ NPT Cross							
3/8" NPT	3/8" NPT	10,000	FZ-1613	2.04	7/8"	3/8"-18 NPT	3/8"-18 NPT

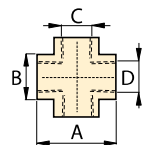
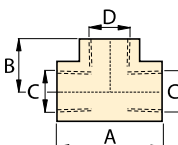
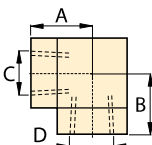
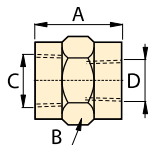
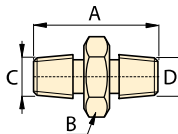
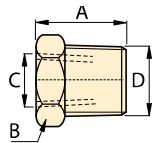
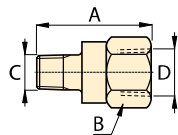

Multiple hydraulic line connections are easily installed with Enerpac fittings and manifolds.



Collet-Lok® product line
Swing clamps
Work supports
Linear clamps
Power sources
Valves
Pallet components
System components

Product selection

From	To	Max. pressure psi	Model number	Dimensions in inches			
				A	B	C	D

▼ Adapters

Male	Female	Max. pressure psi	Model number	A	B	C	D
1/8" NPT	SAE #4	5000	FZ-2075	1.21	11/16"	1/8"-27 NPT	1/4"-18 NPT
1/4" NPT	SAE #4	5000	FZ-2042	1.31	11/16"	1/4"-18 NPT	7/16"-20
1/4" NPT	G1/4"	10,000	BFZ-16411	1.38	3/4"	1/4"-18 NPT	G1/4"
SAE #4	1/8" NPT	5000	FZ-2008	1.00	9/16"	7/16"-20	1/8"-27 NPT
SAE #4	1/4" NPT	5000	FZ-2007	1.16	3/4"	7/16"-20	1/4"-18 NPT
SAE #2	SAE #4	5000	FZ-2022	1.03	11/16"	5/16"-24	7/16"-20
SAE #6	1/4" NPT	5000	FZ-2056	1.16	3/4"	9/16"-18	1/4"-18 NPT
SAE #8	1/4" NPT	5000	FZ-2067	1.13	7/8"	3/4"-16	1/4"-18 NPT
SAE #8	3/8" NPT	5000	FZ-2069	1.28	7/8"	3/4"-16	3/8"-18 NPT
G 1/8"	1/8" NPT	5000	FZ-2055	.97	5/8"	G 1/8"-28	1/8"-27 NPT
G 1/8"	1/4" NPT	5000	FZ-2060	1.28	3/4"	G 1/8"-28	1/4"-18 NPT
G 1/8"	#4 SAE	5000	FZ-2066	1.00	11/16"	G 1/8"-28	7/16"-20
G 1/4"	1/4" NPT	5000	FZ-2023	1.28	3/4"	G 1/4"-19	1/4"-18 NPT
G 1/4"	#4 SAE	5000	FZ-2065	1.11	3/4"	G 1/4"-19	7/16"-20

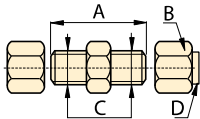
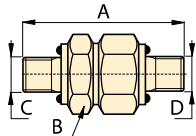
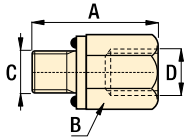

▼ Straight union

SAE #4	SAE #4	5000	FZ-2005	1.27	9/16"	7/16"-20	7/16"-20
SAE #6	SAE #6	5000	FZ-2028	1.41	11/16"	9/16"-18	9/16"-18
SAE #8	SAE #8	5000	FZ-2040	1.56	7/8"	3/4"-16	3/4"-16

▼ Straight union to tube ends

ø.25	ø.25	5000	FZ-2033*	1.38	1/2"	7/16"-20	ø.25
ø.25	ø.25	5000	FZ-2013**	2.03	1/2"	7/16"-20	ø.25

▼ Adaptors to tube end

Male	Tube size	Max. pressure psi	Model number	A	B	C	D
1/8" NPT	ø.25	5000	R-1054*	1.22	1/2"	1/8"-27 NPT	ø.25
1/4" NPT	ø.25	5000	FZ-2020*	1.42	9/16"	1/4"-18 NPT	ø.25
1/4" NPT	ø.375	5000	FZ-2072*	1.43	5/8"	1/4"-18 NPT	ø.375
1/4" NPT	ø.25	5000	FZ-2012**	1.32	9/16"	1/4"-18 NPT	ø.25
3/8" NPT	ø.25	5000	FZ-2061*	1.44	3/4"	3/8"-18 NPT	ø.25
3/8" NPT	ø.375	5000	FZ-2068*	1.44	3/4"	3/8"-18 NPT	ø.375
SAE #2	ø.25	5000	FZ-2025*	1.02	9/16"	5/16"-24	ø.25
SAE #4	ø.25	5000	FZ-2019*	1.23	9/16"	7/16"-20	ø.25
SAE #4	ø.25	5000	FZ-2001**	1.13	9/16"	7/16"-20	ø.25
SAE #6	ø.25	5000	FZ-2059*	1.28	11/16"	9/16"-18	ø.25
SAE #8	ø.25	5000	FZ-2039*	1.38	7/8"	3/4"-16	ø.25
SAE #8	ø.375	5000	FZ-2070*	1.38	7/8"	3/4"-16	ø.375
G1/8"	ø.25	5000	FZ-2053*	1.18	14 mm	G1/8"-28	ø.25
G1/4"	ø.25	5000	FZ-2054*	1.37	19 mm	G1/4"-19	ø.25
G1/4"	ø.375	5000	FZ-2064*	1.38	19 mm	G1/4"-19	ø.375

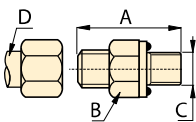

▼ Elbow to tube end

Male	Tube size	Max. pressure psi	Model number	A	B	C	D
1/8" NPT	ø.25	5000	FZ-2074*	0.78	7/16"	1/8"-27 NPT	ø.25
1/4" NPT	ø.25	5000	FZ-2073*	1.09	9/16"	1/4"-18 NPT	ø.25
1/4" NPT	ø.25	5000	FZ-2076**	1.09	9/16"	1/4"-18 NPT	ø.25
1/4" NPT	ø.375	5000	FZ-2081*	1.09	9/16"	1/4"-18 NPT	ø.375
3/8" NPT	ø.25	5000	FZ-2082*	1.22	3/4"	3/8"-18 NPT	ø.25
3/8" NPT	ø.375	5000	FZ-2083*	1.22	3/4"	3/8"-18 NPT	ø.375
SAE #2	ø.25	5000	FZ-2024*	0.92	7/16"	5/16"-24	ø.25
SAE #4	ø.25	5000	FZ-2035*	1.03	9/16"	7/16"-20	ø.25
SAE #4	ø.25	5000	FZ-2002**	1.03	9/16"	7/16"-20	ø.25
SAE #8	ø.375	5000	FZ-2071*	1.45	7/8"	3/4"-16	ø.375
G1/8"	ø.25	5000	FZ-2051*	1.03	14mm	G1/8"-28	ø.25
G1/4"	ø.25	5000	FZ-2052*	1.25	19mm	G1/4"-19	ø.25
ø.25	ø.25	5000	FZ-2014**	0.89	9/16"	ø.25	ø.25

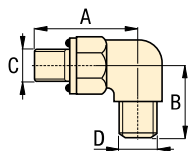

*Flared
**Flareless

Pressure: 0-10,000 psi

Threads: NPT, SAE, BSPP

For tubing: .25 in/.375 in/8mm

- (E) Acoplamiento
- (F) Raccords
- (D) Verschraubungen

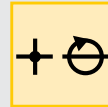

Options

Gauges

□ 190 ▶



Manifolds, couplers, hoses, tubing

□ 192 ▶



Important

Do not exceed the maximum pressure.

Use fittings and tubing in high cycle applications and areas having excessive heat or weld splatter.

To seal NPT threads use anaerobic thread sealers or Teflon paste. Apply Teflon tape one thread from the end of the fitting, to prevent it from winding up in the hydraulic system.

High pressure hydraulic fittings allow connection of many components with minimum effort.



Pressure: 0-5000 psi

Threads: NPT, SAE, BSPP

For tubing: .25 in/.375 in/8mm

E Acoplamientos

F Raccords

D Verschraubungen



Options

Manifolds, couplers, hoses, tubing

192 ▶



Important

Do not exceed maximum pressure.

Use fittings and tubing in high cycle applications and areas having excessive heat or weld splatter.

High pressure fittings enable the design of hydraulic systems to meet a variety of applications.



99-000

Product selection

From	To	Max. pressure	Model number	Dimensions in inches			
				A	B	C	D

▼ Swivel banjo BSPP to tube

Male Tube size

G1/4"	ø 8mm	10,000	BFZ-307**	1.14	19mm	G1/4"-19	ø 8mm
-------	-------	--------	-----------	------	------	----------	-------

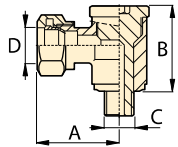

▼ Swivel T-banjo BSPP to tube

Male Tube size

G 1/4"	ø 8mm	10,000	BFZ-309**	1.14	19mm	G 1/4"-19	ø 8mm
--------	-------	--------	-----------	------	------	-----------	-------

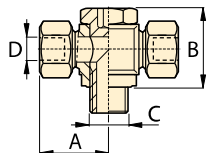

▼ Union tee

ø.25	ø.25	5000	FZ-2021*	1.78	9/16"	7/16"-20	ø.25
ø.25	ø.25	5000	FZ-2015**	1.78	9/16"	7/16"-20	ø.25

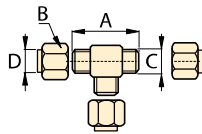

▼ Branch tee

Male Tube size

SAE #4	ø.25	5000	FZ-2036*	1.78	9/16"	7/16"-20	ø.25
SAE #4	ø.25	5000	FZ-2004**	1.78	9/16"	7/16"-20	ø.25

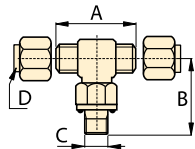

▼ Union cross

ø.25	ø.25	5000	FZ-2034*	1.78	9/16"	7/16"-20	ø.25
ø.25	ø.25	5000	FZ-2016**	1.78	9/16"	7/16"-20	ø.25

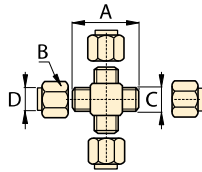

▼ SAE Plug

SAE #4	5000	FZ-2006	.11	.56	7/16"-20		
SAE #6	5000	FZ-2003	.19	.69	9/16"-18		

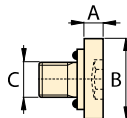

▼ SAE Hex Plug

SAE #8	5000	FZ-2041	.80	7/8"	3/4"-16		
--------	------	---------	-----	------	---------	--	--

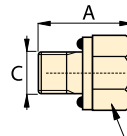

▼ Nut and Sleeve for Tubing

ø.25	5000	FZ-2037*	.62	9/16"	37°	ø.25	
------	------	----------	-----	-------	-----	------	--

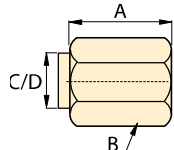

▼ Cap for Tubing

ø.25	5000	FZ-2038*	.62	9/16"	37°	ø.25	
ø.25	5000	FZ-2017**	.60	9/16"	ø.25	ø.25	
ø.375	5000	FZ-2011*	.73	11/16"	37°	ø.375	

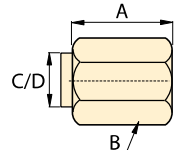

*Flared

**Flareless