

L2622 Rev A 10/04

Index:

English	1-5
Français	N/A
Deutsch	N/A
Italiano	N/A
Español	N/A
Nederlands	N/A
Portuguese	N/A
日本語	N/A

Repair Parts Sheets for this product are available from the Enerpac web site at www.enerpac.com, or from your nearest Authorized Enerpac Service Center or Enerpac Sales office.

1.0 IMPORTANT RECEIVING INSTRUCTIONS

Visually inspect all components for shipping damage. Shipping damage is not covered by warranty. If shipping damage is found, notify carrier at once. The carrier is responsible for all repair and replacement costs resulting from damage in shipment.

SAFETY FIRST

2.0 SAFETY ISSUES



Read all instructions, warnings and cautions carefully. Follow all safety precautions to avoid personal injury or property damage during system operation. Enerpac cannot be responsible for damage or injury resulting from unsafe product use, lack of maintenance or incorrect product and/or system operation. Contact Enerpac when in doubt as to the safety precautions and operations. If you have never been trained on high-pressure hydraulic safety, consult your distribution or service center for a free Enerpac Hydraulic safety course.

Failure to comply with the following cautions and warnings could cause equipment damage and personal injury.

A **CAUTION** is used to indicate correct operating or maintenance procedures and practices to prevent damage to, or destruction of equipment or other property.

A **WARNING** indicates a potential danger that requires correct procedures or practices to avoid personal injury.

A **DANGER** is only used when your action or lack of action may cause serious injury or even death.



WARNING: Wear proper personal protective gear when operating hydraulic equipment.



WARNING: Stay clear of loads supported by hydraulics. A cylinder, when used as a load lifting device, should never be used as a load holding device.

After the load has been raised or lowered, it must always be blocked mechanically.



DANGER: To avoid personal injury keep hands and feet away from cylinder and workpiece during operation.



WARNING: Do not exceed equipment ratings. Never attempt to lift a load weighing more than the capacity of the cylinder. Overloading causes equipment failure and possible personal injury. The cylinders are designed for a max. pressure of 350 bar [5,000 psi]. Do not connect a jack or cylinder to a pump with a higher pressure rating.



DANGER: Never set the relief valve to a higher pressure than the maximum rated pressure of the pump. Higher settings may result in equipment damage and/or personal injury. Do not remove relief valve.



WARNING: The system operating pressure must not exceed the pressure rating of the lowest rated component in the system. Install pressure gauges in the system to monitor operating pressure. It is your window to what is happening in the system.



CAUTION: Avoid damaging hydraulic hose. Avoid sharp bends and kinks when routing hydraulic hoses. Using a bent or kinked hose will cause severe back-pressure. Sharp bends and kinks will internally damage the hose leading to premature hose failure.



Do not drop heavy objects on hose. A sharp impact may cause internal damage to hose wire strands. Applying pressure to a damaged hose may cause it to rupture.



IMPORTANT: Do not lift hydraulic equipment by the hoses or swivel couplers. Use the carrying handle or other means of safe transport.



CAUTION: Keep hydraulic equipment away from flames and heat. Excessive heat will soften packings and seals, resulting in fluid leaks. Heat also weakens hose materials and packings. For optimum performance do not expose equipment to temperatures of 65 °C [150 °F] or higher. Protect hoses and cylinders from weld spatter.



DANGER: Do not handle pressurized hoses. Escaping oil under pressure can penetrate the skin, causing serious injury. If oil is injected under the skin, see a doctor immediately.



WARNING: Only use hydraulic cylinders in a coupled system. Never use a cylinder with unconnected couplers. If the cylinder becomes extremely overloaded, components can fail catastrophically causing severe personal injury.



IMPORTANT: Hydraulic equipment must only be serviced by a qualified hydraulic technician. For repair service, contact the Authorized ENERPAC Service Center in your area. To protect your warranty, use only ENERPAC oil.



WARNING: Immediately replace worn or damaged parts by genuine ENERPAC parts. Standard grade parts will break causing personal injury and property damage. ENERPAC parts are designed to fit properly and withstand high loads.

3.0 INSTALLATION

The Enerpac link clamp can be installed with the clamp arm in one of three different locations. The clamps can be mounted to the fixture using either the threaded body or the supplied mounting bolts. Oil can be supplied to the clamp using either the threaded hydraulic ports on the flange or via the O-ring ports on the underside of the flange. The sections that follow provide detailed mounting instructions and should be reviewed before attempting to install the clamps on the fixture.

3.1 Clamp Arm Location

The arm and linkage can be positioned in any of three different positions as shown in Figure 1 below. The anchor post threads into the top flange of the cylinder in any of the three threaded holes. Thread the anchor post into the flange until it bottoms out, then turn the post back up to 1/2 turn in order to line up the pivot pin hole perpendicular to the desired clamp direction (Figure 2). Make sure that the hole in the plunger is lined up parallel to the hole in the anchor post.

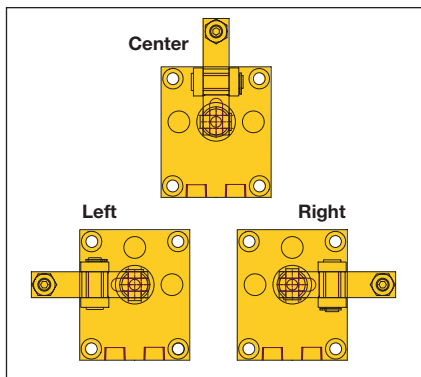

Figure 1

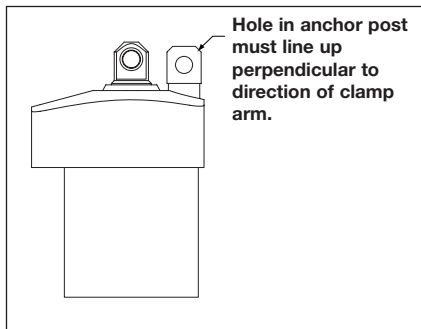

Figure 2

Line up the two (2) links with the hole in the anchor post. Insert one (1) of the long pivot pins through the links and the anchor post. Secure the pivot pin in place using two (2) of the supplied E-clips (Figure 3).

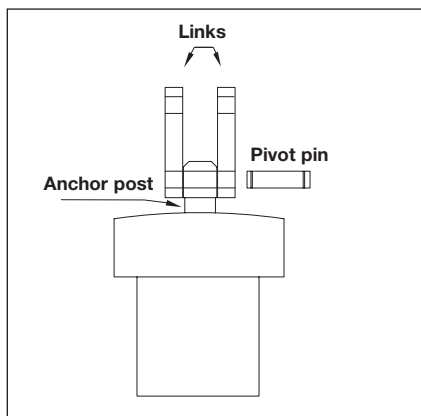

Figure 3

3.2 Arm Attachment

Place the clamp arm over the plunger end, lining up the pivot pin holes. The clamp arm should extend between the two links previously installed. Insert the supplied short pivot pin through the arm and the plunger, securing the parts together with the supplied E-clips (Figure 4).

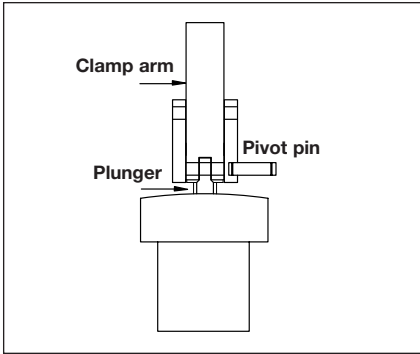

Figure 4

Then, insert the second long pivot pin through the top holes on the links and through the top hole on the clamp arm, securing it with the last two supplied E-clips (Figure 5).

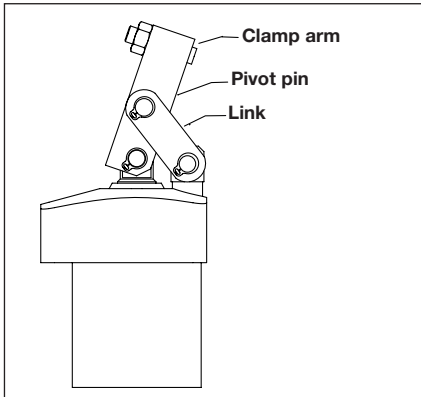

Figure 5

3.3 Mountings

Cylinder Mounting

Enerpac link clamps can be mounted using either the top flange and the supplied mounting bolts; or through the use of the body thread on the cylinder and a jam nut.

Note: mounting the cylinders using the body threads prevents plumbing the cylinders through the manifold ports on the underside of the flange. The only way to utilize this plumbing method is to flange mount the cylinder.

Flange Mounting

Flange mounting requires the machining of a thru-hole in the fixture plate or mounting block and mounting threads for the four bolts (Figure 6).

See Table 1 below.

Align the cylinder in the proper orientation to provide clamping force to the part and then install the mounting bolts and tighten per the chart below. Failure to tighten the mounting bolts properly can result in damage to the cylinder and premature failure of the clamp.

Threaded Body Mounting

Mounting the cylinder using the body threads requires a clearance hole machined in the fixture plate and the installation of a jam nut to secure the cylinder in place. The clearance hole should be sized according to the dimensions in Figure 6.

The fixture plate can also be machined to matching internal threads as long as the

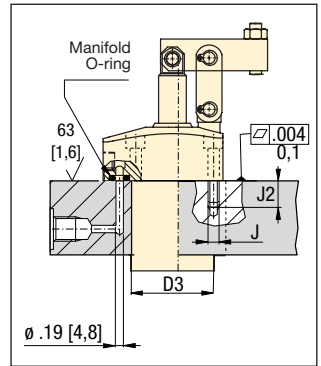

Figure 6

Table 1

Pull ¹⁾ force lbs	Fixture hole Ø D3	Mounting thread J UNF	Min. depth J2	Manifold O-ring ²⁾ ARP No. or Inside Ø x thickness
700	1.885	.250-28	0.65	-010
1800	2.510	.312-24	0.75	-010
2700	3.135	.312-24	0.75	-010
4300	3.515	.375-24	0.88	-010
6300	4.140	.500-20	0.94	-010

1) With standard clamp arm.

2) Polyurethane, 92 Durometer

Note: Mounting bolts and O-rings included.

plate is designed to withstand full clamping capacity. A jam nut is still required in this case to maintain the clamping orientation. The jam nut should be installed on the inside of the fixture plate for most secure mounting.

3.4 Oil Connection

The cylinder can be plumbed using either the hydraulic ports on the side of the flange, or the manifold O-ring ports on the underside of the flange. The manifold ports can only be used when the cylinder is flange mounted using the four mounting bolts as shown in Figure 6.

Hydraulic Fittings

Enerpac link clamps are supplied with either SAE O-ring ports or BSPP ports in the side of the flange. Single acting cylinders require only one hydraulic port. Unlike many other cylinders, single acting Enerpac link clamps do not require the use of a vent port. Connect the oil supply to this port using fittings rated for a minimum of 5000 psi (350 bar) only.

Double-acting cylinders require two ports to operate. The port marked "A" should be connected to the clamp line of the circuit. The port marked "B" should be connected to the unclamp side of the circuit. Again, be sure to use fittings and tubing rated for a minimum of 5000 psi (350 bar) working pressure.

Manifold ports

Enerpac link clamps can also be plumbed using the manifold ports on the underside of the flange. The clamps are supplied from the factory with small cap screw and copper gasket installed in these ports (Figure 7). Remove these items before installation. The manifold ports require the use of O-rings as face seals between the cylinder flange and the fixture plate. These O-rings are supplied with the clamp, typically in a small plastic bag along with the mounting bolts and the documentation. Install these O-rings (only one O-ring required for single acting cylinders) into the seal grooves on the underside of the mounting flange (Figure 7).

Before installation, the O-rings should be coated with a small amount of hydraulic oil to prevent damage during operation. Mount the clamps using the installation instructions in section 3.3. Remember that the cylinders must be flange mounted when using the manifold porting method.

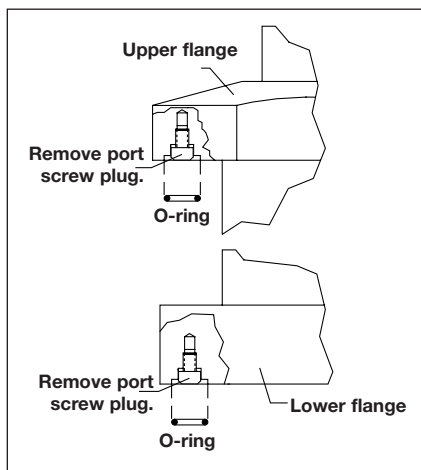

Figure 7

4.0 OPERATION

Enerpac link clamps operate on hydraulic pressure from 500 to 5000 psi (35-350 bar). This oil pressure is supplied via an external pump plumbed through a circuit of valves to the link clamps and other clamping elements on the fixture. Single acting cylinders only require one hydraulic line to provide clamping force, and use an internal spring to retract the clamp arm when pressure is removed. Double acting cylinders require two hydraulic lines; one line provides pressure to advance the arm and clamp the part; the other line provides pressure to push the arm back and unclamp the part. Either manual, air or electrically operated valves are used to direct oil to one port or another.

5.0 MAINTENANCE

1. Use only Enerpac oil with these cylinders. The use of any other oil may invalidate your warranty.
2. Dynamic hydraulic seals need periodic replacement due to normal wear and tear. A regularly scheduled maintenance inspection plan will help prevent unnecessary interruptions in production due to seal wear.
3. The clamp linkage can be damaged or broken due to mis-loaded parts or excessive contamination build up. Any clips or pins that appear damaged or worn should be replaced immediately.
4. All maintenance should be done by a qualified hydraulic service technician. Enerpac has a global service center network that can provide repair and maintenance services if needed.

6.0 TROUBLE-SHOOTING GUIDE

PROBLEM	POSSIBLE CAUSE/SOLUTION
Cylinder plunger will not advance.	Control valve not open or damaged. Couplers or fittings not properly connected. Pump is not developing flow or pressure. Linkage is not attached properly. Linkage is bound by either misalignment or built up contamination.
Cylinder advances in spurts.	Control valve not open or damaged. Couplers or fittings not properly connected. Pump is malfunctioning. Linkage is bound by either misalignment or built up contamination. Air in hydraulic system.
Cylinder advances but does not hold pressure or provide clamp force.	Control valve damaged. Couplers or fittings leaking. Pump is malfunctioning. Internal seals are damaged and need replacement. Cylinder bore or plunger are damaged and need replacement. Clamp arm is not properly contacting part. Adjust contact screw.
Cylinder leaks oil.	Internal seals are damaged and need replacement. Cylinder bore or plunger are damaged and need replacement. If cylinder is manifold mounted, O-rings could be damaged or pinched and need replacement.
Cylinder will not retract or retracts slowly.	Control valve not open or damaged. Couplers or fittings not properly connected. Pump is malfunctioning. Linkage is bound by either misalignment or built up contamination. Air in hydraulic system. Restrictions in return line. Check all installed accessories such as filters for proper operation.

Enerpac Worldwide Locations

Africa

ENERPAC Middle East FZE
P.O. Box 18004
Jebel Ali, Dubai
United Arab Emirates
Tel: +971 (0)4 8872686
Fax: +971 (0)4 8872687

Australia

ENERPAC, Actuant Australia Ltd.
Block V Unit 3
Regents Park Estate
391 Park Road
Regents Park NSW 2143
(P.O. Box 261) Australia
Tel: +61 297 438 988
Fax: +61 297 438 648

Brazil

Power Packer do Brasil Ltda.
Rua dos Inocentes, 587
04764-050 - Sao Paulo (SP)
Tel: +55 11 5687 2211
Fax: +55 11 5686 5583
Toll Free in Brazil:
Tel: 0800 891 5770
vendasbrasil@enerpac.com

Canada

Actuant Canada Corporation
6615 Ordan Drive, Unit 14-15
Mississauga, Ontario L5T 1X2
Tel: +1 905 564 5749
Fax: +1 905 564 0305
Toll Free:
Tel: +1 800 268 4987
Fax: +1 800 461 2456
Technical Inquiries:
techservices@enerpac.com

China

Actuant China Ltd.
1F, 269 Fute N. Road
Waigaoqiao Free Trade Zone
Pudong New District
Shanghai, 200 131 China
Tel: +86 21 5866 9099
Fax: +86 21 5866 7156

Actuant China Ltd. (Beijing)
709A Xin No. 2
Diyang Building
Dong San Huan North Rd.
Beijing City, 100028 China
Tel: +86 10 845 36166
Fax: +86 10 845 36220

Central and Eastern Europe

ENERPAC B.V.
Storkstraat 25
P.O. Box 269, 3900 AG Veenendaal
The Netherlands
Tel: +31 318 535 936
Fax: +31 318 535 951

✦ **e-mail:** info@enerpac.com

France

ENERPAC
Une division de ACTUANT s.a.
B.P. 200
Parc d'Activités
du Moulin de Massy
F-91882 Massy CEDEX France
Tel: +33 1 601 368 68
Fax: +33 1 692 037 50

Germany, Austria, Switzerland, Russia, Greece and CIS (excl. Caspian Sea Countries) ENERPAC Applied Power GmbH

P.O. Box 300113
D-40401 Düsseldorf
Germany
Tel: +49 211 471 490
Fax: +49 211 471 49 28

India

ENERPAC Hydraulics (India) Pvt. Ltd.
Plot No. A/571
MIDC, TTC Industrial Area
Mahape-400 701
Navi Mumbai, India
Tel: +91 22 2778 1472
Fax: +91 22 2778 1473

Italy

ENERPAC S.p.A.
Via Canova 4
20094 Corsico (Milano)
Tel: +39 02 4861 111
Fax: +39 02 4860 1288

Japan

Applied Power Japan Ltd.
1-1-11, Shimomae
Toda-shi, Saitama Pref.
Japan 335-0016
Tel: +81 484 30 1055
Fax: +81 484 30 1066

The Netherlands, Belgium, Luxembourg, Sweden, Denmark, Norway, Finland,

Baltic States

ENERPAC B.V.
Storkstraat 25
P.O. Box 269
3900 AG Veenendaal
The Netherlands
Tel: +31 318 535 911
Fax: +31 318 525 613
+31 318 535 848

Technical Inquiries Europe:

techsupport.europe@enerpac.com

✦ **internet:** www.enerpac.com

Singapore

Enerpac Asia Pte. Ltd.
25 Serangoon North Ave. 5
#03-01 Keppel Digihub
Singapore 554914
Thomson Road, P.O. Box 114
Singapore 915704
Tel: +65 64 84 5108
+65 64 84 3737
1800 363 7722
Fax: +65 64 84 5669
Technical Inquiries:
sales@enerpac.com.sg

South Korea

Actuant Korea Ltd.
3Ba 717, Shihwa Industrial Complex,
Jungwang-Dong, Shihung-Shi, Kyunggi-Do
Republic of Korea 429-450
Tel: +82 31 434 4506
Fax: +82 31 434 4507

Spain, Portugal

ENERPAC
C/San José Artesano 8 Pol. Ind.
28108 Alcobendas
(Madrid) Spain
Tel: +34 91 661 11 25
Fax: +34 91 661 47 89

Middle East, Turkey , Caspian Sea

ENERPAC Middle East FZE
P.O. Box 18004
Jebel Ali, Dubai
United Arab Emirates
Tel: +971 (0)4 8872686
Fax: +971 (0)4 8872687

United Kingdom, Ireland

ENERPAC Ltd., P.O. Box 33
New Romney, TN28 8QF
United Kingdom
Tel: +44 01797 363 639
Fax: +44 01527 585 500

USA, Latin America and Caribbean

ENERPAC
P.O. Box 3241
6100 N. Baker Road
Milwaukee, WI 53209 USA
Tel: +1 262 781 6600
Fax: +1 262 783 9562

User inquiries:

+1 800 433 2766

Distributor inquiries/orders:

+1 800 558 0530

Technical Inquiries:

techservices@enerpac.com

All Enerpac products are guaranteed against defects in workmanship and materials for as long as you own them. For your nearest authorized Enerpac Service Center, visit us at www.enerpac.com