

Specifications

Units: Imperial Metric

Maximum Operating Pressure (psi)	10,150
Capacity Class (tonnage)	60
Maximum Cylinder Capacity Advance (tons)	66.81
Maximum Cylinder Capacity Retract (tons)	29.65
Stroke (in)	5.91
Collapsed Height A (in)	13.62
Extended Height B (in)	19.52
Return Type	Double-Acting, Hydraulic Return
Plunger Type	Hollow
Material	Aluminum
Cylinder Effective Area Advance (in ²)	13.17
Cylinder Effective Area Retract (in ²)	5.84
Oil Capacity Advance (in ³)	77.72
Oil Capacity Retract (in ³)	34.5
Surface Treatment	Anodized
Coupler	CR400 Coupler
Weight (lbs)	48.8

Dimensions

Units: Imperial Metric

Collapsed Height A (in)	13.62
Extended Height B (in)	19.52
Outside Diameter D (in)	7.09
Cylinder Bore Diameter E (in)	5.12
Plunger Diameter F (in)	4.33
Base to Advance Port H (in)	1.88
Saddle Diameter J1 (in)	3.61
Saddle Protrusion from Plunger K (in)	0.5
Plunger Internal Thread O (in)	2 3/4"-16 UN
Plunger Thread Length P (in)	0.79
Base Mounting Holes Bolt Circle U (in)	6.3
Base Mounting Holes Thread V	M6
Center Hole Diameter Y (in)	2.13
Base Mounting Holes Thread Depth Z (in)	0.47

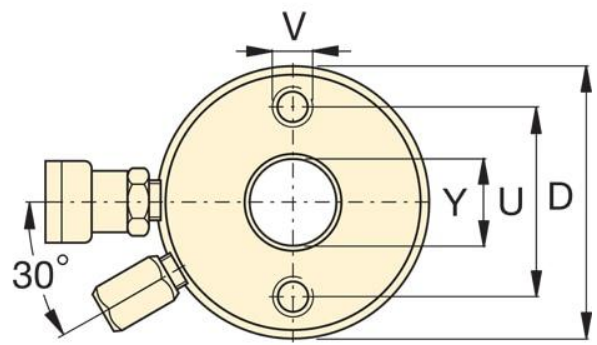
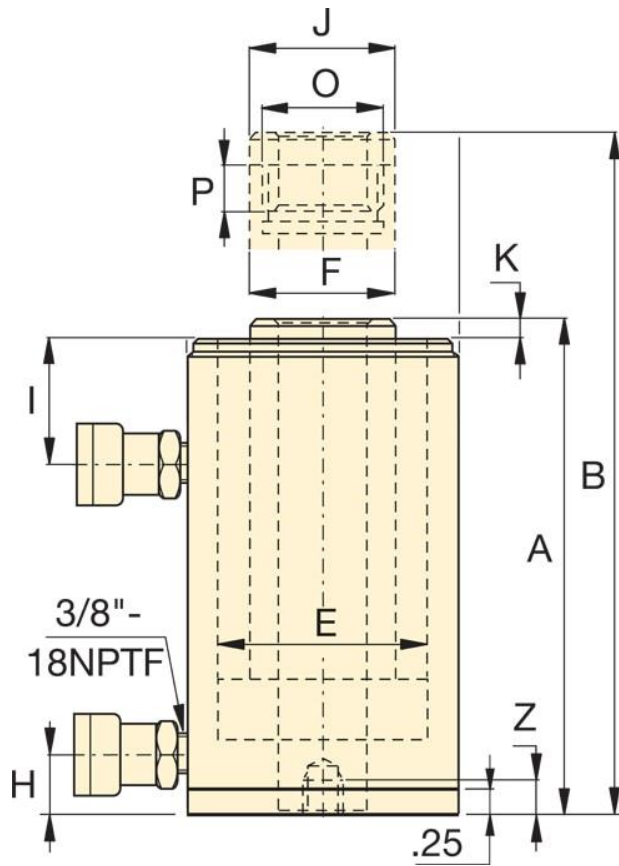

Dimensions shown in inches.