

## Specifications

Units: **Imperial** Metric

Maximum Operating Pressure (psi)	10,000
Capacity (imperial tons)	68
Maximum Material Hardness	HRc 43
Pump Power Source	Electric Pump
Cutter Power Source	Electric
Maximum Material Diameter (in)	1.38
Maximum Material Tensile Strength (psi)	89,900
Weight (lbs)	106

## Dimensions

Units: **Imperial** Metric

Dimension A (in)	22.3
Dimension B (in)	8.4
Dimension C (in)	10.2

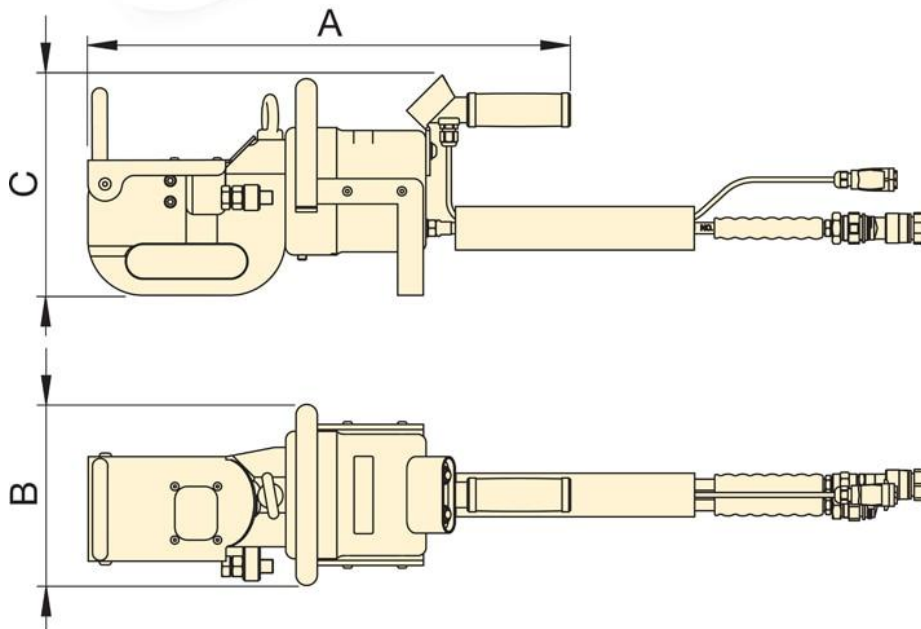

Drawings are for guidance purposes only, exact tool configurations vary by model.