



2525 GARDNER ROAD, BROADVIEW, IL 60155
 1.800.323.9114 • Outside U.S. 1.708.865.1500
 www.tksimplex.com



G4 POWER PUMP

Reference # - 54739

Rev. - A

Date - 1109

CONTENTS

<i>Receiving Instructions and Warranty Statement</i>	1
<i>Safe and Correct Use</i>	2-3
<i>Technical Specifications</i>	3
<i>Working Pressure</i>	3
<i>Install Vent Plug</i>	3
<i>Adding Oil</i>	3
<i>Install Hydraulic Connections</i>	4
<i>Electrical</i>	4
<i>Connecting Hydraulic Tools or Cylinders</i>	4
<i>Pump Mounting</i>	4
<i>Control Valves</i>	5
<i>Power Control Switches</i>	5
<i>Starting the Pump for the First Time</i>	6
<i>Adjusting the External Relief Valve</i>	6
<i>Jacking Safety</i>	6
<i>After Completing the Job</i>	7
<i>Periodic Maintenance</i>	7
<i>Maintain Oil Level</i>	7
<i>Clean Oil Intake Screen</i>	7
<i>Flushing the Pump</i>	7
<i>Problem / Cause - Solutions</i>	8

- Note -

SIMPLEX has taken every care in preparing this Operational Manual that is intended as a technical guideline only. SIMPLEX accepts no liability in relation to any use or reliance made of any information in this Operational Manual. All information, illustrations and specifications in this Operational Manual are based on the latest information available at the time of publication. The right is reserved to make changes at any time without notice. Equipment operators and installers shall be responsible for ensuring that a safe working environment and safe systems of work are in place before operating the equipment.



G Series Power Pumps

G4 Series



IMPORTANT - READ CAREFULLY

This manual contains important information for the correct installation, operation and maintenance of this equipment. All persons involved in the installation, operation and maintenance of this equipment must be thoroughly familiar with the contents of this manual. To safeguard against the possibility of personal injury or property damage, follow the recommendations and instructions of this manual. Keep this manual for reference.

WARRANTY STATEMENT

SIMPLEX products are warranted to be free of defects in materials and workmanship under normal use for as long as the original purchaser owns them, subject to the guidelines and limitations listed. This warranty does not cover: *normal wear & tear, cosmetic items, abuse, overloading, alterations, improper fluid, or use in a manner for which they are not intended*. If the customer believes a product is defective, the product must be delivered, or shipped freight prepaid, to the nearest SIMPLEX Authorized Service Center for evaluation and repair.

1.0 RECEIVING INSTRUCTIONS

Important! Make sure to inspect all of the components for shipping damage. If damage is found, notify carrier at once. Shipping damage will not be covered by warranty. The carrier is responsible for all loss associated with shipping damage.

2.0 SAFETY

Make sure to read the instructions, warnings and precautions carefully. Follow any recommended safety precautions to avoid personal injury or damage to the unit. Simplex cannot be responsible for any damage or injury from unsafe use, lack of maintenance or incorrect operation. In the event any questions or concerns arise, contact SIMPLEX or a local Distributor for clarification.

The pump's maximum working pressure is 10,000 PSI (700kg/cm²). Make sure that all hydraulic equipment such as rams, hoses, etc. used with this pump are rated at 10,000 PSI (700kg/cm²) operating pressure.



If you have never been trained on high-pressure hydraulic safety, consult your distributor or service center for a free Simplex Hydraulic Safety Course.

Failure to comply with the following cautions and warnings could cause equipment damage, property damage or personal injury.

DANGER is only used when your action or lack of action may cause serious injury or even death.

WARNING indicates a potential danger that requires correct procedures or practices to avoid personal injury.

CAUTION is used to indicate correct operating or maintenance procedures and practices to prevent damage to, or destruction of equipment, or other property.

WARNING: Wear proper personal protective gear when operating hydraulic equipment.

WARNING: Stay clear of loads supported by hydraulics. A cylinder, when used as a load lifting device unless it was designed for that purpose. It should never be used as a load holding device. After the load has been raised or lowered, it must always be blocked mechanically.

WARNING: USE ONLY RIGID PIECES TO HOLD LOADS. Carefully select steel or wood blocks that are capable of supporting the load. Never use a hydraulic cylinder as a shim or spacer in any lifting or pressing application.

DANGER: To avoid personal injury, keep hands and feet away from cylinder and work-piece during operation.

WARNING: Do not exceed equipment ratings. Never attempt to lift a load weighing more than the capacity of the cylinder. Overloading causes equipment failure and possible personal injury. The cylinders are designed for a maximum pressure of 10,000 PSI (700kg/cm²). Do not connect a jack or cylinder to a pump with a higher pressure rating. Never set the relief valve to a higher pressure than the maximum rated pressure of the pump. Higher settings may result in equipment damage and/or personal injury.

WARNING: The system operating pressure must not exceed the pressure rating of the lowest rated component in the system. Install pressure gauges in the system to monitor operating pressure. It is your window to what is happening in the system.

CAUTION: Avoid damaging hydraulic hose. Avoid sharp bends and kinks when routing hydraulic hoses. Using a bent or kinked hose will cause severe back-pressure. Sharp bends and kinks will internally damage the hose, leading to premature hose failure.

Do not drop heavy objects on hose. A sharp impact may cause internal damage to hose wire strands. Applying pressure to a damaged hose may cause it to rupture.

IMPORTANT: Do not lift hydraulic equipment by the hose or swivel couplers. Use the carrying handle or other means of safe transport.

CAUTION: Keep hydraulic equipment away from flames and heat. Excessive heat will soften seals, resulting in fluid leaks. Heat also weakens hose materials. For optimum performance do not expose equipment to temperatures of 65° C (170° F) or higher. Protect hoses and cylinders from weld spatter.

DANGER: Do not handle pressurized hoses. Escaping oil under pressure can penetrate the skin, causing serious injury. If oil is injected under the skin, see a doctor immediately.

DANGER: Only use hydraulic cylinders in a coupled system. Never use a cylinder with unconnected couplers. If the cylinder becomes severely overloaded, components can fail catastrophically causing severe personal injury or death.

3.0 TECHNICAL SPECIFICATIONS

G4 Electric Series		
Voltage	115V	230V
Operating Pressure	10,000 PSI (700kg/cm ²)	
Electrical Power Source	16 Amps 115V Grounded 60 Hz	16 Amps 220V Grounded 60 Hz
Motor Rating (Induction Motor)	1.5 Hp Single Phase 16 Amps @ 10,000 psi (700kg/cm ²)	1.5 Hp Single Phase 16 Amps @ 10,000 psi (700kg/cm ²)
Flow Rate	400 cu. in./ min. @ 1,100 psi, 55 cu. in / min. @ 10,000 psi	
Maximum Operating Temperature	170 F° - (65 C°)	

4.0 WORKING PRESSURE

The pump's maximum working pressure is 10,000 PSI (700kg/cm²). Make sure that all hydraulic equipment such as rams, hoses, etc. used with this pump are rated at 10,000 PSI (700kg/cm²) operating pressure.

4.1 INSTALL VENT PLUG

Remove SHIPPING PLUG (A) and install VENT PLUG (B) into cover plate.

4.2 ADDING OIL

Remove OIL FILLER CAP (C) and add SIMPLEX Hydraulic Oil into reservoir. Oil level should not exceed 1" from the reservoir cover.

*As a "rule of thumb" oil should be visual in site window when the unit is powered down and all connected tools or cylinders are retracted.

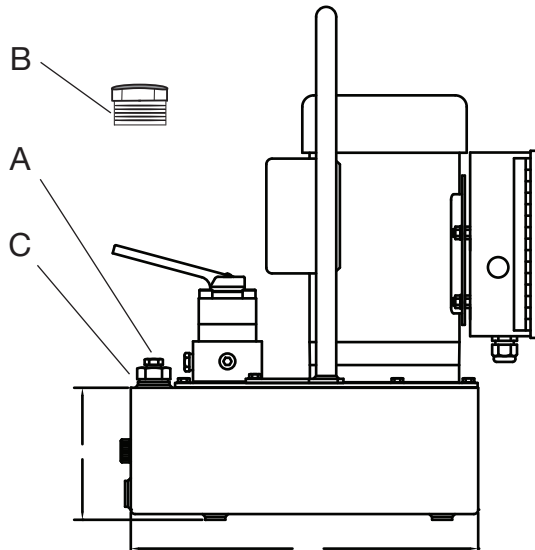

Note:
Vent Plug / Oil Fill location is applicable to the 1.5, 2.5, 5 & 10 gallon reservoirs.

One gallon models utilize the drain plug for removing and adding oil. Vent plugs are pre-installed under the shroud.

4.3 INSTALL HYDRAULIC CONNECTIONS

Use only cylinders, tools, hoses and accessories rated at 10,000 PSI (700kg/cm²). Remove the shipping plugs from the ports to connect your coupling(s) or hose(s) to manifold. Use 1.5 wraps of Teflon tape (or suitable thread sealant) on all threads, leaving the first complete thread free of tape to ensure no foreign matter enters the hydraulic circuit.

When making connections with quick disconnect couplings, make sure the couplings are fully engaged. Threaded connections such as fittings, gauges, etc. must be securely tightened and leak free.

WARNING: Loose or improperly threaded fittings can be potentially dangerous if pressurized; however, severe over tightening can cause premature thread failure. Fittings need to be tightened secure & leak free. Never hold or stand directly in line with any hydraulic connections while pressurizing. Never grab, touch or in any way come in contact with a hydraulic pressure-leak. Escaping oil can penetrate the skin and a serious injury can result.

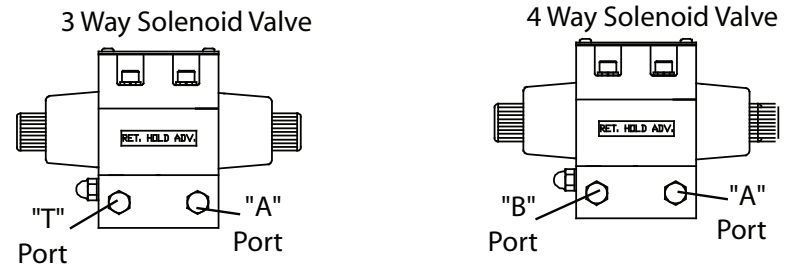
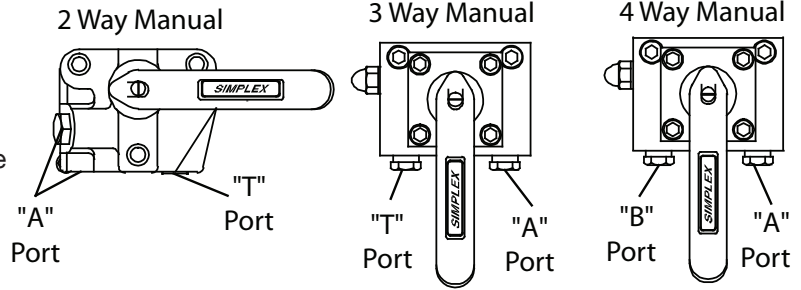

CAUTION: Do not subject the hose to potential hazards such as sharp surfaces, extreme heat or heavy impact. Do not allow the hose to kink or twist. Inspect each hose for wear before it is used.

4.4 ELECTRICAL

Check for proper electrical supply before connecting. Be sure the electrical connection is grounded. Check that your power supply agrees with the motor nameplate and/or Simplex model decal.

NOTE: MOTOR MAY SPARK. DO NOT OPERATE IN AN EXPLOSIVE ATMOSPHERE OR IN THE PRESENCE OF CONDUCTIVE LIQUIDS.

- a. Do not use a power or extension cord that is damaged or has exposed wires.
- b. All single phase motors come equipped with a three prong grounding type plug to fit the proper grounded type electrical outlet. Do not use a two prong ungrounded extension cord as the pump's motor must be grounded.

4.5 CONNECTING HYDRAULIC TOOLS OR CYLINDERS

Use only cylinders, tools, hoses and accessories rated at 10,000 PSI (700kg/cm²). When making connections with quick disconnect couplings, make sure the couplings are fully engaged. Threaded connections such as fittings, gauges, etc. must be securely tightened and leak free. Use 1.5 wraps of Teflon tape (or suitable thread sealant) on all threads, leaving the first complete thread free of tape to ensure no foreign matter enters the hydraulic circuit.

4.6 PUMP MOUNTING Refer to the chart for mounting dimensions to secure the pump to a fixed surface.

	1.5 gal.(6L)	2.5 gal.(10L)	5 gal. (20L)	10 gal. (38L)
A	15.13	17	19.6	19.6
B	1.68	2.75	4.69	4.69
C	3.57	4.37	5.03	4.69
D	1.43	1.93	2.93	2.93
E	8.75	9.75	11.75	12.25
F	1/4-20unc (4 places)	1/4-20unc (4 places)	1/4-20unc (4 places)	1/4-20unc (4 places)

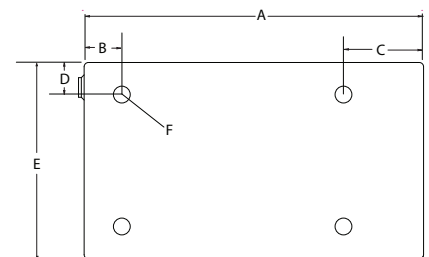

5.0 CONTROL VALVES

2-Way Valve for Single Acting Rams

- **To Advance**.....turn lever to the right.
- **To Hold**.....turn motor off and leave in advance position.
- **To Retract**.....turn lever to the left.

2 way manual valve
(handle is in the advance position)

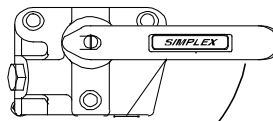

To Retract ←

3 way and 4 way manual valves
(hande is in the neutral position)

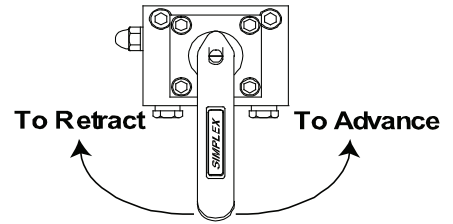

To Retract

To Advance

3-Way Manual Valve for Single Acting Rams

- **To Advance**.....push lever to the right.
- **For Neutral/Hold**.....place lever in the middle.
- **To Retract**.....push lever to the left.

3-Way Solenoid Valve for Single Acting Rams

- **To Advance**.....depress the **ADV** switch.
- **For Neutral/Hold**.....release the switch.
- **To Retract**.....depress the **RET** switch.

4-Way Manual Valve for Double Acting Rams

- **To Advance**.....push lever to the right.
- **For Neutral/Hold**.....place lever in the middle.
- **To Retract**.....push lever to the left.

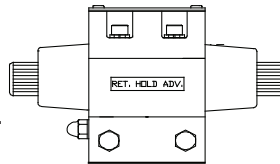

3 and 4 way solenoid valves stay in neutral position until the pendant switch is depressed.

4-Way Solenoid Valve for Double Acting Rams

- **To Advance**.....depress the **ADV** switch.
- **For Neutral/Hold**.....release switch.
- **To Retract**.....depress the **RET** switch.

.....
WARNING: Solenoid valves may not prevent load movement between shifted positions of the valve when used in systems to support live loads. Locking valves or other load holding devices may be required to prevent unintended load movement.

5.1 POWER CONTROL SWITCHES

Remote pendant or shroud switches control as follows:

Configured with motor control pendant:

- JOG** = Press and hold switch to turn motor on.
- ON** = Press switch to turn motor on.
- OFF** = Press switch to turn motor off.

Configured with motor/valve control pendant:

- ADVANCE** = Press and hold switch to activate advance coil.
- RETRACT** = Press and hold switch to activate retract coil.
- ON/OFF** = Toggles motor power on or off. Can simulate jog by holding the ADVANCE or RETRACT button + pressing the ON/OFF button.

Configured with a raised button poly-carbonate shroud switch:

- JOG** = Press and hold switch to turn motor on.
- ON** = Press switch to turn motor on.
- OFF** = Press switch to turn motor off.

NOTE: In the event multiple buttons are depressed for longer than 5 seconds, the unit is programmed to shut down. To restart, you will need to depress the motor “ON” to continue, or unplug / re-plug the unit into power supply, then depress the motor “ON” to continue.

Motor Control Pendant

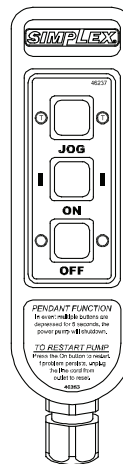

Motor / Valve Control Pendant

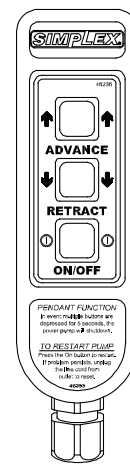

Shroud Switch



5.2 STARTING THE PUMP FOR THE FIRST TIME

1. Locate the valve control and make sure it's in the "neutral" or "open" position.
2. Locate the power switch and select to the "ON" position. Check for any leaks, repair as needed.
3. Shift the control valve to the closed, advance and retract position and look for movement in tool or cylinder. Check for any leaks, repair as needed.

Bleeding the Hydraulic System - air can be removed from the system by fully advancing and retracting the hydraulic cylinder several times with the pump elevated so its reservoir is higher than the cylinder. Single-acting cylinders should be inverted and double-acting on their side with the hydraulic couplers pointed up. When the trapped air is removed from the hydraulic circuit, the cylinder will advance and retract smoothly. Sluggish or jerky cylinder action is usually the first sign of air in the system.

Shift the lever to Advance position to activate ram or cylinder. To hold load, place lever into Neutral/Hold or turn off pump. Move lever to retract position to release load.

CAUTION: Never operate the pump at 10,000 PSI (700kg/cm²) without ram movement for more than 1 minute without shifting the control valve to neutral or turning off motor. Leaving the valve in the advance or retract position without the piston rod moving will overheat the oil.

CAUTION: Never disconnect or connect any hydraulic hoses or fittings without first unloading the ram, then unplug the electrical cord of the pump and shift, or open all hydraulic controls several times to assure that the system has been depressurized. If the system includes a gauge, double check the gauge to assure pressure has been released.

5.3 ADJUSTING THE EXTERNAL RELIEF VALVE

Pumps are preset at 10,000 PSI (700kg/cm²). To re-adjust or lower the maximum operating pressure, follow these steps below.

1. Install gauge and gauge adapter between pump and cylinder.
2. Remove Acorn Nut to expose adjusting screw.
3. Place valve lever in Neutral/Hold position and start motor.
4. Move lever to direct pump output to pressure port (Advance).
5. Insert 7/32 Allen wrench into adjusting screw in the hole on the left side of valve.
6. Turn adjusting screw clockwise to increase, or counter clockwise to decrease pressure.
7. Do not exceed 10,000 PSI (700kg/cm²).
8. Check valve setting by shifting the valve to advance and retract cylinder several times.
9. Maximum gauge reading should remain constant.

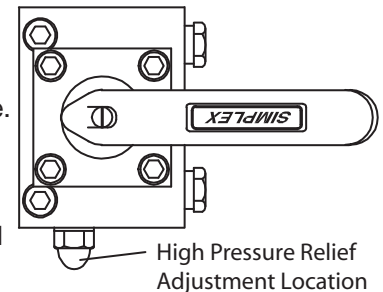

5.4 JACKING SAFETY

Know the weight you intend to lift and select a cylinder with enough capacity to provide the appropriate factor of safety. Appropriate factors of safety vary with the type of load to be lifted and number of lifting points. Prepare a lifting plan that accounts for potential changes in load factors such as; load shift, center of gravity, and stability. Choose a cylinder with at least 10% more capacity than is required by the lifting plan.

The ram should be placed on a solid foundation so that the base of the ram is fully supported. The load must be centered on the ram, or equally distributed on multiple rams. Off center loading can result in the ram slipping out and loss of the load.

Never crawl or place any part of your body under any load at any time. Insert blocking or cribbing under the load as you lift. Hydraulic rams are meant for lifting only and should not be used to support the load for any period of time.

You should obtain and be familiar with the American National Standards Institute rules that apply to hydraulic rams and jacks (ASME ANSI B30.1).

5.5 AFTER COMPLETING THE JOB

Before disconnecting hoses, fittings, etc., first be sure the ram is unloaded and retracted, then unplug the power cord and shift the hydraulic controls several times to release system pressure. Store the pump in a clean, dry area.

6.0 PERIODIC MAINTENANCE

Completely change the hydraulic oil and clean the intake screen and magnet (located in the reservoir) twice a year. If equipped, change the external oil filter twice a year (**Use Simplex oil only, Model # AO1, 1 gallon**). Change the oil more frequently when used in extremely dusty areas or when the oil has been overheated. **Using oil other than Simplex Brand may void the pump’s warranty.**

The following conditions require more frequent oil changes.

- Rigorous duty, where oil temperature may reach 150°F.
- High humidity environment and extreme changes in temperature that can result in condensation inside the reservoir.
- Dirty or dusty environments that may contaminate the oil.
- Frequent connection and disconnection of hydraulic hoses and components.

.....
WARNING: The electrical power cord must be disconnected from the electrical outlets before performing maintenance or repair procedures.

6.1 MAINTAIN OIL LEVEL

Check hydraulic oil level every 30 hours of operation (sight gauge should be completely covered in oil when all tools are retracted. Add **Simplex oil (Model # AO1 – 1 gallon)** when necessary. Oil level should be no more than 1” from top of reservoir plate – with cylinders retracted and motor off.

6.2 CLEAN OIL INTAKE SCREEN ONCE A YEAR

Loosen and remove reservoir plate bolts. Lift pump unit off the reservoir, being careful not to damage the gasket.

Applies to 1, 1.5, 2, 2.5 gallon reservoirs:

Remove the 5 Allen socket head cap screws securing the screen to the 1st stage gear pump. Care should be taken not to remove the center plate and gears. Remove and clean with nonflammable solvent, blow dry clean. Reinstall in reverse order and torque bolts to 75 inch pounds. Keep the motor and pump as clean as possible.

Applies to the 5 and 10 gallon reservoirs:

Unscrew screen from bottom of pump unit and clean with nonflammable solvent. Blow dry and reassemble. Keep areas around pump unobstructed to provide good air flow around the motor and pump. Keep the motor and pump as clean as possible.

6.3 FLUSH THE PUMP

If you suspect your pump has been contaminated or discover sludge or other deposits on internal components, you should thoroughly flush the pump. Remove the old oil from the reservoir, then thoroughly clean the reservoir and refill with a clean, nonflammable flushing oil. Reassemble the pump and motor to the reservoir. Now run the pump in no load condition for 1 or 2 minutes maximum. Unplug the pump and remove the motor and pump assembly again. Now drain the flushing oil and re-clean the inside of the reservoir. (Make sure flushing fluid is also drained from pump assembly). Refill the reservoir with Simplex hydraulic oil and reassemble the pump.

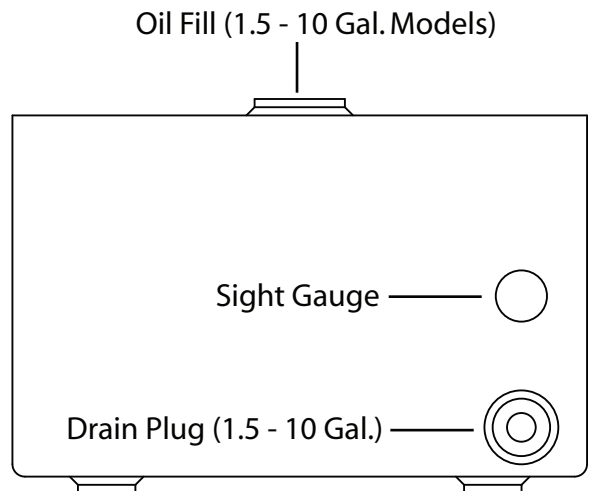

7.0 TROUBLESHOOTING

PROBLEM

CAUSE-SOLUTION

Sporadic Cylinder Action:

- Air in the hydraulic system. Bleed the hydraulic circuit.
- Check reservoir oil level.

Motor Will Not Start:

- Be sure power cord is not damaged.
- Check for tripped circuit breaker; be sure breaker is of adequate size.
- Have motor checked for proper operation.
- Have qualified electrician inspect for loose or faulty wiring or switch.

Noisy Operation:

- Air in system.
- Be sure the oil reservoir is filled to normal level.
- Check all points where air might leak into system.
- Clogged or blocked intake screen.

Pump Oil is Over Heating:

- Inspect for high pressure leakage at the pump (leaking at plug or relief valve).
- Oil level is low. Fill reservoir to normal level, or retrofit the pump with larger reservoir or heat exchanger.

Pump Runs But Will Not Pump Oil:

- Pump is not primed. Run pump a few minutes tipping from side to side.
- Inspect to make sure that external adjustable relief valve is set properly.
- Defective control valve, take to nearest Simplex Authorized Service Center for repair.
- Incorrect motor rotation, take to nearest Simplex Authorized Service Center for repair.
- Check to make sure the intake screen is not clogged. Clean if needed.
- Check oil reservoir is low. Fill as needed.
- Oil viscosity is too high. Replace with SIMPLEX oil.

Notes

Notes



2525 GARDNER ROAD, BROADVIEW, IL 60155

1.800.323.9114 • Outside U.S. 1.708.865.1500

www.tksimplex.com

**UNITED STATES HOME
OFFICE AND FACTORY**
2525 Gardner Road
Broadview, IL 60155-3719
Phone: (708) 865-1500
Fax: (708) 865-0894
Toll Free: (800) 323-9114
Email: sales@tksimplex.com
www.tksimplex.com

CANADIAN
canada@tksimplex.com

EUROPEAN
europa@tksimplex.com

ASIA & PACIFIC RIM
asiapacific@tksimplex.com

MEXICO
mexico@tksimplex.com

South & Central America
latinamerica@tksimplex.com

MIDDLE EAST
mideast@tksimplex.com

SOUTH AFRICA
southernafrica@tksimplex.com

SIMPLEX PRODUCTS ARE WARRANTED TO BE FREE OF DEFECTS IN MATERIALS AND WORKMANSHIP UNDER NORMAL USE FOR AS LONG AS THE ORIGINAL PURCHASER OWNS THEM, SUBJECT TO THE GUIDELINES AND LIMITATIONS LISTED. THIS WARRANTY DOES NOT COVER : NORMAL WEAR AND TEAR, COSMETIC ITEMS, ABUSE, OVERLOADING, ALTERATIONS. IMPROPER FLUID, OR USE IN A MANNER FOR WHICH THEY ARE NOT INTENDED. IF THE CUSTOMER BELIEVES A PRODUCT IS DEFECTIVE, THE PRODUCT MUST BE DELIVERED, OR SHIPPED FREIGHT PREPAID, TO THE NEAREST SIMPLEX AUTHORIZED SERVICE CENTER FOR EVALUATION AND REPAIR.