

Specification

Maximum Operating Pressure (psi)	10,000
Capacity Class (tonnage)	200
Maximum Cylinder Capacity Advance (tons)	223
Stroke (in)	3.94
Collapsed Height A (in)	11.34
Extended Height B (in)	15.28
Return Type	Single-Acting, Load Return
Plunger Type	Solid
Material	Steel
Cylinder Effective Area Advance (in ²)	43.95
Oil Capacity Advance (in ³)	173.02
Sideload Resistance of Maximum Capacity (percentage)	10%
Surface Treatment	Nitride
Coupler	CR400 Coupler
Weight (lbs)	231

Dimensions

Collapsed Height A (in)	11.34
Collapsed Height With Optional Tilt Saddle A1 (in)	11.97
Optional Tilt Saddle Addition To Collapsed Height A1 (in)	0.71
Optional Tilt Saddle Diameter J1 (in)	4.96
Extended Height B (in)	15.28
Outside Diameter D (in)	9.84
Cylinder Bore Diameter E (in)	7.48
Base to Advance Port H (in)	1.85
Saddle Diameter J1 (in)	5.12
Saddle Protrusion from Plunger K (in)	0.08
Saddle Maximum Tilt Angle Radius (degrees)	5
Base Mounting Holes Thread V	M12 x 1,75

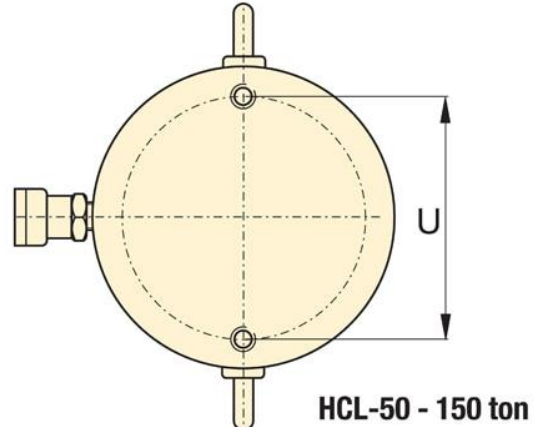
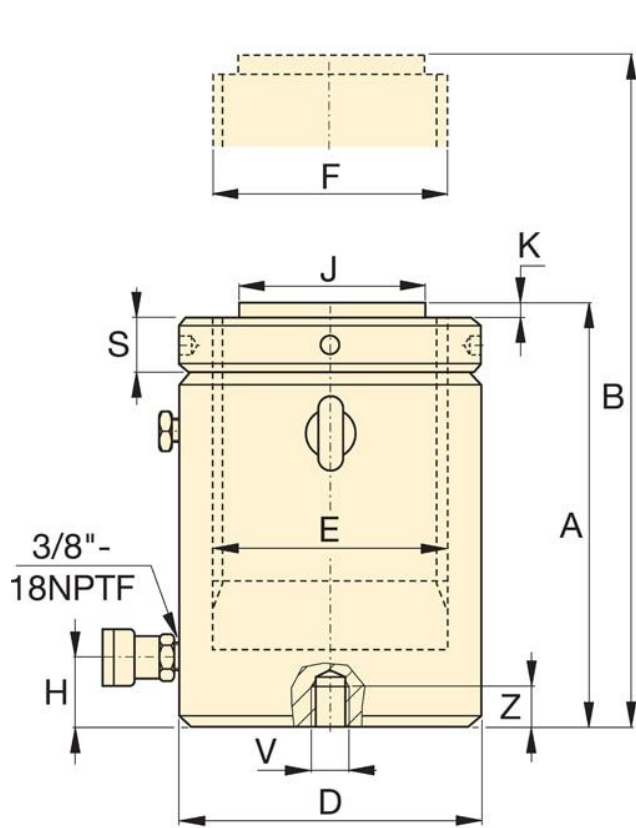

HCL-50 - 150 ton

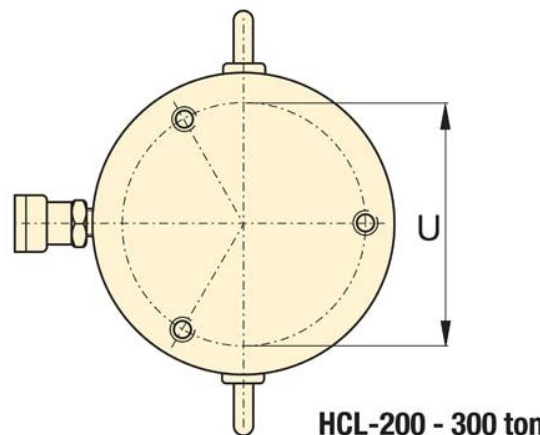

HCL-200 - 300 ton