

Enerpac offers an extensive range of dedicated tools for a variety of specific and flexible applications.

Whatever your requirement... cutting, punching, spreading or bending... you can be sure that Enerpac has the correct tool to do your job safely and efficiently.

Featuring maintenance sets, machine lifts and load skates, as well as hole punches, pipe benders and cable cutters, Enerpac has the tools to ensure that even your most demanding applications can be undertaken with the highest degree of safety and accuracy.

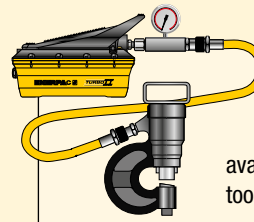

Tool-Pump Sets

Most hydraulic tools in this section are available in sets, for a perfect tool-pump match.



Hydraulic System Set-up

Check out our 'Yellow Pages' section for help on system set-ups and valving configurations.

Page: 270













Bolting Tools

More Enerpac Tools you will find in our Bolting Tools section in this catalogue.

Page: 182



Hydraulic Tools Section Overview

Capacity ton (kN)	Tool type and functions	Series		Page
2,5 - 12,5 (22 - 116)	Maintenance Sets	MS		164 ▶
35 - 50 (311 - 498)	Punch Punch-Pump Sets	MSP		168 ▶
		SP		170 ▶
16 (157)	Lifting Wedge	LW		172 ▶
8,5 - 20 (75 - 178)	Machine Lifts	SOH		173 ▶
1 - 80 (8,9 - 712)	Heavy-Duty Load Skates	ER ES ELP		174 ▶
19 - 453 litres	Industrial Storage Cases	CM		176 ▶
0,75 - 1,0 (6 - 8,9)	Hydraulic Wedgie Spread Cylinders	A WR		177 ▶
3 - 20 (26 - 178)	Hydraulic Cutterheads Cutterhead-Pump Sets	WHC WHR STC		178 ▶
3 - 20 (26 - 178)	Self-Contained Hydraulic Cutters	WMC		179 ▶
Nominal Bore ½ - 4 inch	Pipe Bender Sets	STB		180 ▶

▼ Shown: MS2-10



- All sets include Enerpac pump, hose, cylinder and gauge
- Lock-on or threaded connectors
- Complete maintenance set for almost every maintenance application.

The Universal Hydraulic Tool Box



Maintenance Sets

Enerpac Maintenance sets are a complete assortment of hydraulic powered tools. Using these sets allows you to quickly configure a unique tool to meet your most difficult jobs.

Built around the Enerpac lightweight hand pump, hose and cylinder, these sets enable you to push, pull, lift, press, straighten, spread and clamp with forces up to 12,5 ton.



More Information





For detailed information on all included attachments, see the next pages.

Page: 166



Clamping a workpiece is just one of the many applications for the Enerpac maintenance sets. ▶

▼ QUICK SELECTION CHART

Capacity using attachments* ton (kN)	Set Model Number						Number of Attachment Components	 (kg)
2,5 (22)	MS2-4	P-142	HC-7206	RC-55	GP-10S	GA-4	33	26
2,5 (22)	MSFP-5	P-142	HC-7206	RC-55	GP-10S	GA-4	24	20
5,0 (50)	MSFP-10	P-392	HC-7206	RC-106	G2535L	GA-3	23	48
5,0 (50)	MS2-10	P-392	HC-7206	RC-106	GP-10S	GA-2	35	63
12,5 (116)	MS2-20	P-392	HC-7206	RC-256	GP-10S	GA-2	13	95
5,0-12,5 (50-116)	MS2-1020	P-392	HC-7206	RC-102, -106, -256	GP-10S	GA-2	53	158

* If no attachments are being used, capacity is double these values. Maximum operating pressure is then 700 bar.

Universal Maintenance Sets



CAUTION!
When cylinders are used with maintenance set attachments or components, the maximum system pressure must be limited to half the rated pressure (350 bar).



WARNING!
Only use attachments provided with set. Non-Enerpac attachments and longer extension tubes will reduce column strength, potentially creating unsafe conditions.

MS Series



Capacity (using attachments):

2,5 - 12,5 ton

Maximum Operating Pressure:

350 bar

▼ APPLICATION EXAMPLES



MS-Series, Maintenance Sets



CAUTION! When cylinders are used with maintenance set attachments or components, the maximum system pressure must be limited to half the rated pressure (350 bar).

Note: All dimensions in millimetres.

Set Model Number	MS2-4	MSFP-5	MSFP-10	MS2-10	MS2-20	MS2-1020
Base, Collar and Plunger Attachments	2,5 ton	2,5 ton	5,0 ton	5,0 ton	12,5 ton	5,0 - 12,5 ton
Cylinder Model(s)	RC-55	RC-55	RC-106	RC-106	RC-256	RC-102, 106, 256
1	A-23	A-23	A-13	A-13	A-28	A-13, A-28
2	A-25	A-25	A-21	A-21	A-27	A-21, A-27
3	A-1034	A-1034	A-20	A-20	A-595	A-20, A-595
4	MZ-4010	MZ-4010	A-14	A-14	A-243	A-14, A-243
5	A-545	A-545	A-10	A-10	-	A-10 (2x)
6	-	-	-	A-8	-	A-8
7	A-530	A-530	A-6	A-6	-	A-6
8	MZ-4011	-	-	A-192	-	A-192
9	-	-	-	A-305	-	A-305
10	A-531	A-531	A-18	A-18	-	A-18
11	-	-	-	A-185	-	A-185
12	A-532	A-532	A-15	A-15	-	A-15
13	-	-	-	-	A-607	A-607
14	A-629	A-629	A-129	A-129	-	A-129
15	A-539	A-539	A-128	A-128	-	A-128
Chains and Attachments for Pulling Applications	2,5 ton	2,5 ton	5,0 ton	5,0 ton	12,5 ton	5,0 - 12,5 ton
16	A-558	-	-	A-132	A-238	A-132, A-238
17	-	-	-	A-5 (2x)	-	A-5 (2x)
18	A-557 (2x)	-	-	A-141 (2x)	A-218 (2x)	A-141 (2x), A-18 (2x)
Extension Tubes, Connectors and Adaptors	2,5 ton	2,5 ton	5,0 ton	5,0 ton	12,5 ton	5,0 - 12,5 ton
19	A-544	-	-	A-19 (2x)	A-242 (2x)	A-19 (2x) A-242 (2x)
20	WR-5	WR-5	WR-5	A-92	-	A-92
21	MZ-4013 (4x)	MZ-4013 (4x)	A-16 (4x)	A-16 (4x)	-	A-16 (4x)
22	MZ-4007 (3x)	MZ-4007 (3x)	MZ-1050 (3x)	MZ-1050 (2x)	-	MZ-1050 (3x)
23	MZ-4008 (2x)	-	-	MZ-1051	-	MZ-1051 (2x)
24	MZ-4009	MZ-4009	MZ-1052	MZ-1052	-	MZ-1052
25	-	-	-	A-285	-	A-285
26	A-650	-	-	-	-	-
27 Length (mm)	76	MZ-4002	MZ-4002	-	-	-
	127	MZ-4003	MZ-4003	MZ-1002	MZ-1002	-
	254	MZ-4004	MZ-4004	MZ-1003	MZ-1003	A-239
	254	-	-	-	-	A-239
	457	MZ-4005 (2x)	MZ-4005	MZ-1004	MZ-1004	A-240
	457	-	-	-	-	A-240
	584	MZ-4006	MZ-4006	-	-	-
762	-	-	MZ-1005	MZ-1005	A-241	
762	-	-	-	-	-	
28 Storage Case	CM-6	CM-6	CW-350	CW-350	CW-350	CW-750
Set Weight (kg)	26	20	48	63	95	158

Base, Collar and Plunger Attachments

1 Threaded Adaptor

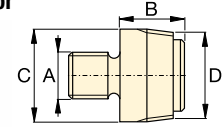

ton	Model Nr.	A	B	C	D
2,5	A-23	3/4" - 16 UN	28	26	3/4" - 14 NPT
5,0	A-13	1" - 8 UN	31	42	1 1/4" - 11 1/2 NPT
12,5	A-28	1 1/2" - 16 UN	47	69	2" - 11 1/2 NPT

2 Base Attachment

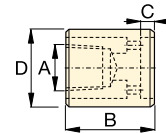

ton	Model Nr.	A	B	C	D
2,5	A-25	3/4" - 14 NPT	50	12	44
5,0	A-21	1 1/4" - 11 1/2 NPT	57	12	65
12,5	A-27	2" - 11 1/2 NPT	63	12	98

3 Collar Toe

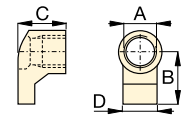

ton	Model Nr.	A	B	C	D
2,5	A-1034	1 1/2" - 16 UN	54	50	31
5,0	A-20	2 1/4" - 14 UN	80	57	57
12,5	A-595	3 5/16" - 12 UN	103	51	80

4 Flat Base

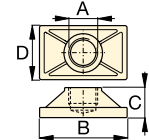

ton	Model Nr.	A	B	C	D
2,5	MZ-4010	3/4" - 14 NPT	114	31	63
5,0	A-14	1 1/4" - 11 1/2 NPT	165	35	88
12,5	A-243*	2" - 11 1/2 NPT	165	58	165

* A-243 is a round base model.

5 Threaded Connector

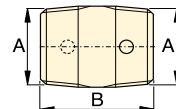

ton	Model Nr.	A	B
2,5	A-545	3/4" - 14 NPT	35
5,0	A-10	1 1/4" - 11 1/2 NPT	41

6 Lock-on Clamp Toe

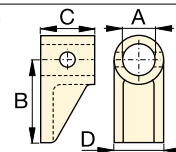

ton	Model Nr.	A	B	C	D
5,0	A-8	43	105	50	57

Universal Maintenance Sets, MS-Series

7 Threaded Plunger Toe

ton	Model Nr.	A	B	C	D
2,5	A-530	¾" - 14 NPT	57	25	33
5,0	A-6	1¼" - 11½ NPT	82	31	57

14 Wedge Head

ton	Model Nr.	A	B	C	D
2,5	A-629	¾" - 14 NPT	69	33	28
5,0	A-129	1¼" - 11½ NPT	101	50	44

20 Spreader

ton	Model Nr.	A	B	C	D
1,0	WR-5	—	223	12,8	94
1,0	A-92	2¼" - 14 UN	244	35	158

8 Collar Clamp Head

ton	Model Nr.	A	B	C	D
2,5	MZ-4011	¾" - 14 NPT	49	76	1½" - 16 UN
5,0	A-192	42	63	50	2¼" - 14 UN

15 Rubber Flex Head

ton	Model Nr.	A	B	C
2,5	A-539	¾" - 14 NPT	44	69
5,0	A-128	1¼" - 11½ NPT	86	86

21 Lock Pin

ton	Model Nr.	A	B
2,5	MZ-4013	7,9	41
5,0	A-16	11,2	82

9 Spreader Toe

ton	Model Nr.	A	B	C	D
5,0	A-305	1¼" - 11½ NPT	114	25	50

Chains and Attachments for Pulling

16 Single Chain Plate

ton	Model Nr.	A	B	C	D
2,5	A-558	1½" - 16 UN	196	39	44
5,0	A-132	2¼" - 14 UN	307	63	79
12,5	A-238	3⅝" - 12 UN	450	102	125

22 Lock-on Connector

ton	Model Nr.	A	B
2,5	MZ-4007	19	79
5,0	MZ-1050	33	127

10 Serrated Saddle

ton	Model Nr.	A	B	C
2,5	A-531	¾" - 14 NPT	27	31
5,0	A-18	1¼" - 11½ NPT	38	50

17 Double Chain Plate

ton	Model Nr.	A	B	C	D
5,0	A-5	1¼" - 11½ NPT	130	50	126

23 Male Lock-on Adaptor

ton	Model Nr.	A	B	C
2,5	MZ-4008	¾" - 14 NPT	60	19
5,0	MZ-1051	1¼" - 11½ NPT	90	33

11 Smooth Saddle

ton	Model Nr.	A	B	C
5,0	A-185	1¼" - 11½ NPT	38	50

18 Chain with Hook

ton	Model Nr.	Chain Length
2,5	A-557	1,5 metres
5,0	A-141	1,8 metres
12,5	A-218	2,4 metres

24 Female Lock-on Adaptor

ton	Model Nr.	A	B	C
2,5	MZ-4009	¾" - 14 NPT	65	19
5,0	MZ-1052	1¼" - 11½ NPT	96	33

12 90° V-Base

ton	Model Nr.	A	B	C	D
2,5	A-532	¾" - 14 NPT	38	47	25
5,0	A-15	1¼" - 11½ NPT	54	57	54

Tubes, Connectors and Adaptors

19 Pipe Coupling

ton	Model Nr.	A	B	C
2,5	A-544	¾" - 14 NPT	42	33
5,0	A-19	1¼" - 11½ NPT	49	54
12,5	A-242	2" - 11½ NPT	88	82

25 Adjustable Extension

ton	Model Nr.	A	B	C	D
5,0	A-285	1¼" - 11½ NPT	335	441	33

13 Plunger Base

ton	Model Nr.	A	B	C
12,5	A-607	2" - 11½ NPT	166	38

26 Slip-on Extension

ton	Model Nr.	A	B	C
2,5	A-650	¾" - 14 NPT	200	365

SP-Series, Lightweight Hydraulic Punch

▼ Shown: SP-35S



- 12,7 mm thick capacity through mild steel
- Round, oblong and square punches and dies are available to solve your punching applications
- Long life Enerpac single-acting, spring return design
- Durable steel case keeps tools and dies together and provides for easy carrying and storage
- CR-400 coupler included.

Much Faster than Drilling



Tool Kit SPK-10

Included with all 35 Ton punches, this tool kit is used to remove and install the punch into the head. Can be ordered as a replacement under model number **SPK-10**.



Ordering Information

The 35 ton hydraulic Punch may be ordered by itself or as a set, including a pump. A punch or die may also be ordered separately or as a matched set. Please refer to the Quick Selection Chart information on top of the next page.

▼ SP-Series, Lightweight Hydraulic Punch – Much Faster than Drilling.





▼ STANDARD PUNCHES AND DIES SELECTION CHART

Hole Shape	Imperial ¹⁾ (inch)		Metric ¹⁾ (mm)	
	Hole Size	Bolt Size	Hole Size	Bolt Size
●	0,31	1/4	7,9	–
●	0,38	5/16	9,5	M8
●	0,44	3/8	11,1	M10
●	0,53	7/16	13,5	M12
●	0,56	1/2	14,3	–
●	0,69	5/8	17,5	M16
●	0,78	–	19,8	M18
●	0,81	3/4	20,6	–
■	0,31	1/4	7,9	–
■	0,38	5/16	9,5	M8
■	0,44	3/8	11,1	M10
■	0,50	7/16	12,7	M12
■	.31 x .75	1/4	7,9 x 19	–
■	.38 x .75	5/16	9,5 x 19	M8
■	.44 x .75	3/8	11,1 x 19	M10
■	.50 x .75	7/16	12,7 x 19	M12

¹⁾ Material thickness should not exceed hole diameter.

Single-Acting, Spring Return Hydraulic Punch

▼ QUICK SELECTION CHART

* 	Punch & Die Set	Included				Model Number	 (kg)
		Pump	Hose	Gauge	Gauge Adaptor		
SP-35	Standard**	P-392	HC-7206	GP-10S	GA-2	STP-35H	25
SP-35	Standard**	PATG-1102N	HC-7206	GP-10S	GA-2	STP-35A	29
SP-35	-	-	-	-	-	SP-35	16
SP-35	Standard**	-	-	-	-	SP-35S	18
SP-35	Standard**	PUD-1100E	HC-7206	-	-	SP-35SPE	29
SP-35	Metric***	-	-	-	-	MSP-351	21
SP-35	Metric***	PUD-1100E	HC-7206	-	-	MSP-351PE	32

* Punch oil capacity: 76 cm³

Includes the following punch and die sets:

** SPD-438, SPD-688, SPD-563 and SPD-813

*** SPD-375, SPD-531, SPD-438 and SPD-688

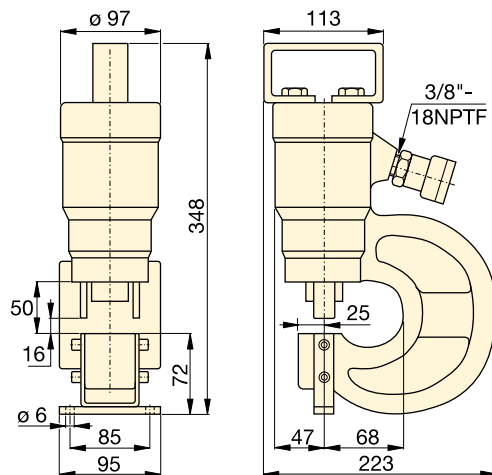

MSP SP STP Series



Capacity:

35 ton

Hole Sizes:

7,9 - 20,6 mm

Maximum Operating Pressure:

700 bar



CAUTION!

The chart below is for reference only! Maximum allowable material thickness to be punched varies with set wear.



CAUTION!

Material thickness should not exceed hole diameter.

Model Nr. Standard Punch & Die Set	Maximum allowable material thickness to be punched (mm) Material thickness should not exceed hole diameter										
	1)	2)	3)	4)	5)	6)	7)	8)	9)	10)	11)
 SPD-313	7,9	7,9	6,4	6,4	6,4	6,4	3,3	4,8	6,4	6,4	6,4
SPD-375	9,7	9,7	7,9	7,9	7,9	7,9	4,8	6,4	7,9	7,9	7,9
SPD-438	11,2	11,2	9,7	9,7	9,7	7,9	4,8	7,9	7,9	7,9	7,9
SPD-531	12,7	12,7	11,2	11,2	11,2	9,7	6,4	7,9	9,7	9,7	9,7
SPD-563	12,7	12,7	12,7	11,2	12,7	11,2	6,4	9,7	11,2	11,2	11,2
SPD-688	12,7	12,7	12,7	11,2	12,7	10,2	6,4	7,9	10,2	10,2	10,2
SPD-781	12,7	12,7	12,7	11,2	12,7	9,7	6,4	7,9	9,7	9,9	9,7
SPD-813	12,7	12,7	12,7	11,2	12,7	7,9	4,8	7,9	7,9	7,9	7,9
SPD-458	7,9	7,9	6,4	6,4	6,4	6,4	3,3	4,8	6,4	6,4	6,4
SPD-549	9,7	9,7	7,9	7,9	7,9	7,9	4,8	6,4	7,9	7,9	7,9
SPD-639	11,2	11,2	9,7	9,7	9,7	7,9	4,8	7,9	7,9	7,9	7,9
SPD-728	12,7	12,7	11,2	11,2	11,2	9,7	6,4	7,9	9,7	9,7	8,6
SPD-106	7,9	7,9	6,4	6,4	6,4	6,4	3,3	4,8	6,4	6,4	6,4
SPD-125	9,7	9,7	7,9	7,9	7,9	7,9	4,8	6,4	7,9	7,9	7,9
SPD-188	11,2	11,2	9,7	9,7	9,7	7,9	4,8	7,9	7,9	7,9	7,9
SPD-250	12,7	12,7	11,2	11,2	11,2	9,7	6,4	7,9	9,7	9,7	9,7

Steel Qualities (see table):

- 1) Mild A-7
- 2) Boiler Plate
- 3) Structural A-36
- 4) Struct Corten (ASTM A242)
- 5) Cold Rolled C-1018
- 6) Hot Rolled C-1050
- 7) Hot Rolled C-1095
- 8) Hot Rolled C-1095 Annealed
- 9) Stainless Annealed
- 10) Stainless 304 Hot Rolled
- 11) Stainless 316 Cold Rolled

▼ The hydraulic punch cuts the time spent forming holes.



SP-Series, 50 Ton Hydraulic Punch

▼ Shown: SP-50100



- Available as a complete set including electric pump and hoses
- Double-acting cylinder design for fast cycle times
- Punch and die changeover tools included
- Lifting bracket included
- Adjustable power stripper prevents movement of the metal during stripping
- CR-400 female couplers included.

Cuts the Time Spent Forming Holes



Depth Stop

For simplified repetitive punching applications an adjustable Depth Stop is available. Order model number: **SP-110**.



Foot Mounting Kit

A foot mounting kit for easy mounting of the 50 ton punch to workbench or fixture is available. Order model number: **SP-120**.



Ordering Information

The 50-ton Hydraulic Punch may be ordered by itself or as a set with an electric pump. A punch and die may be ordered as a matched set.

Please refer to the selection chart information.



◀ Save time using the 50-ton Enerpac Punch.

▼ Shown below is the 50 ton punch with SP-120 and SP-110 assembled.



50 Ton Double-Acting Hydraulic Punch

▼ QUICK SELECTION CHART PUNCH SETS

Included				Set Model Number	 (kg)
Model Number Punch*	Punch & Die Sets	Electric Pump	Hydraulic Hose (2x)		
SP-50	All **	-	-	SP-50100	116
SP-50	All **	ZE4410SE	HC-7206	SP-5000E	174

* Punch Oil Capacity:
Advance: 278 cm³
Retract: 229 cm³

** All standard sets from chart below.

SP Series



Capacity:

50 ton (490 kN)

Hole Sizes:

13,5 - 26,2 mm

Maximum Operating Pressure:

700 bar

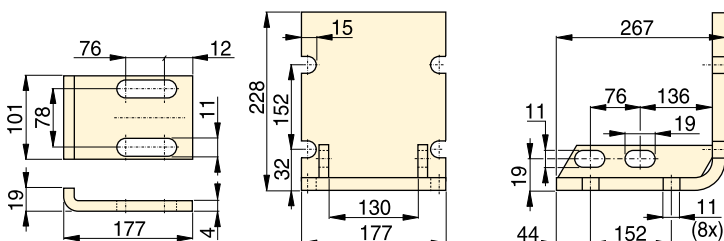

SP-110

SP-120

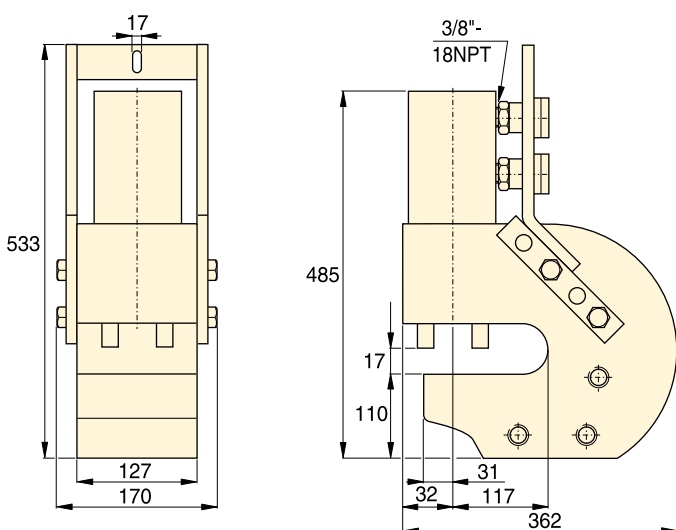

SP-50



CAUTION!

Material thickness should not exceed hole diameter.



CAUTION!

Chart below is for reference only! Maximum allowable material thickness to be punched varies with set wear.

Steel Qualities (see table below):

- 1) Mild A-7
- 2) Boiler Plate
- 3) Structural A-36
- 4) Struct Corten (ASTM A242)
- 5) Cold Rolled C-1018
- 6) Hot Rolled C-1050
- 7) Hot Rolled C-1095
- 8) Hot Rolled C-1095 Annealed
- 9) Stainless Annealed
- 10) Stainless 304 Hot Rolled
- 11) Stainless 316 Cold Rolled

▼ STANDARD PUNCH AND DIE SELECTION CHART

Hole Shape	Hole Size (mm)	Bolt Size (mm)	Model Numbers Standard Punch and Die Set	Maximum Allowable Material Thickness To Be Punched (mm)										
				1)	2)	3)	4)	5)	6)	7)	8)	9)	10)	11)
●	13,5	M12	SP-150	13,5	13,5	13,5	13,5	13,5	12,4	8,1	10,2	12,4	12,4	12,4
●	16,7	M16	SP-170	-	-	-	-	-	13,0	8,1	10,2	13,0	13,0	13,0
●	19,8	M18	SP-190	-	-	-	-	-	12,4	8,1	10,2	12,4	12,7	12,4
●	23,1	M20	SP-121	14,2	14,2	14,2	12,7	14,2	8,9	5,6	8,9	8,9	8,9	8,9
●	26,2	M24	SP-123	14,2	14,2	14,2	11,2	14,2	7,9	4,8	7,9	7,9	7,9	7,9

LW-Series, Hydraulic Vertical Lifting Wedge

▼ LW-16 with SB-2 and optional LWB-1



- Requires very small access gap of only 10 mm
- Lifting force 16 ton at 700 bar hydraulic pressure
- Each step can spread under full load
- Straight vertical lifting
- Unique interlocking wedge design: no first step bending and risk of slipping out
- Single-acting, spring return cylinder
- Lifting wedge LW-16 includes safety block SB-2
- Includes RC-Series Cylinder with CR-400 coupler.

▼ For lifting heavy equipment with minimum floor clearance the LW-16 is the ideal tool.



LW Series

Maximum Lifting Force:

16 ton (157 kN)

Lifting Stroke:

21 mm

Tip Clearance / Maximum Spread *:

10 mm / 81,5 mm

Maximum Operating Pressure:

700 bar



Power Box

Tool box with P-392 hand pump, gauge adaptor assembly, hose and LW-16.

Page: 55



Control Manifolds

Control Manifold to control two or four lifting wedges simultaneously.
AM-21 with 3 ports 3/8" NPTF
AM-41 with 5 ports 3/8" NPTF.

Page: 118

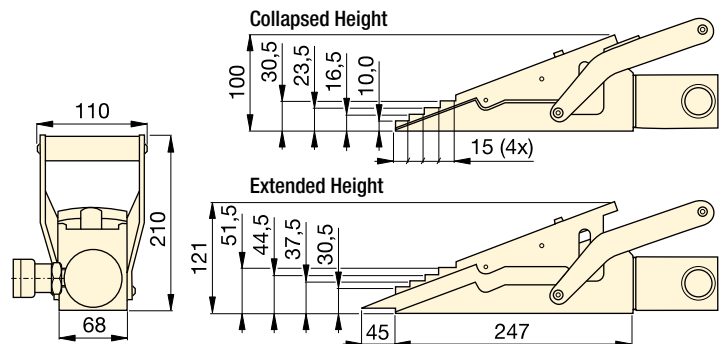
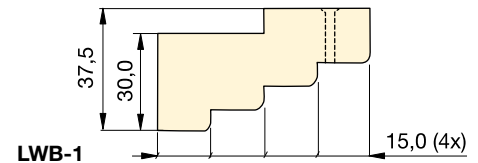

Maximum Lifting Force	Lifting Stroke	Model Number	Tip Clearance	Maximum Operating Pressure	Oil Capacity	
ton (kN)	(mm)		(mm)	(bar)	(cm ³)	(kg)
16 (157)	21	LW-16	10	700	78	9,0

Use optional stepped block LWB-1 to increase wedge lifting height by 30 mm.

* Using LWB-1.

Hydraulic Machine Lifts

▼ SOH-10-6



SOH Series

Lifting Capacity:

8,5 - 20 ton

Stroke:

136 - 157 mm

Toe Clearance:

20 mm

Maximum Operating Pressure:

700 bar

- For lifting heavy equipment with minimum available access
- Remote hydraulic pump enhances safety
- Low height lifting toe
- Precision guided to reduce friction and isolate cylinder from side-loads
- Two extendable support feet provide extra stability
- Includes RC-Series DUO Cylinder with CR-400 coupler.



RSM-Series Flat-Jac®

Low height, single acting spring-return cylinders are ideal for space restricted applications.

Page: 22



Load Skates

In combination with the Enerpac Machine Lifts we recommend Load Skates for moving heavy loads.

Page: 174

▼ Limited access under this machine makes the Enerpac hydraulic machine lift the perfect solution.

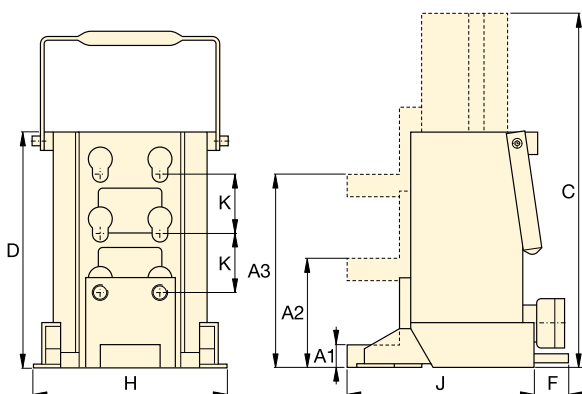

Capacity	Toe Clearance (mm)			Stroke	Model Number	Oil Capacity	Dimensions (mm)						🏋️ (kg)
	Minimum A1	Central A2	Maximum A3				Total Ext. Height C	Total Body Height D	F	H	J	K	
8,5 (75)	20	95	169	136	SOH-10-6	224	430	294	-	190	214	74	26
20 (178)	30	110	190	157	SOH-23-6	525	472	320	65	265	250	80	45

▼ Shown: Set ERS-20



- Rugged and sturdy construction for long life
- Low profile construction for increased stability
- Low rolling-resistance allows for easy transportation
- Attachable load leveling plates and swivel turntables for turning corners.

Move Heavy Loads Easily and Safely



Sets (see table) include all components necessary to handle a variety of applications.

Two **ELB-1** link-up bars, two **ERH-1** handles (875 mm long) and one **EMB-1** metal box are included.

Optional long handle **ERH-2** (1180 mm) available for 60 and 80 ton only.



Lifting Wedge and Machine Lifts

To place the Load Skates, the load must first be lifted. This can be done easily and safely using the Enerpac Lifting Wedge or Machine Lifts.

Page: 172

▼ Heavy transport using Load Skates. The machine is first lifted, using SOH-Series Enerpac Machine Lifts.



▼ Chemical tank transportation: The first few centimetres the load was lifted with RCS-Series low height cylinders and then moved on to load skates for transportation.



Heavy Duty Caterroller™ Load Skates

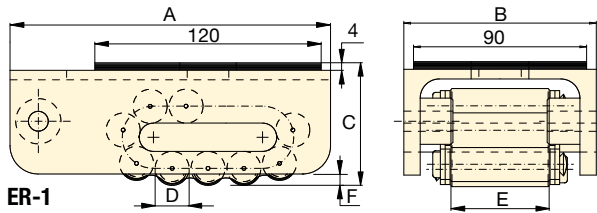

ER-1

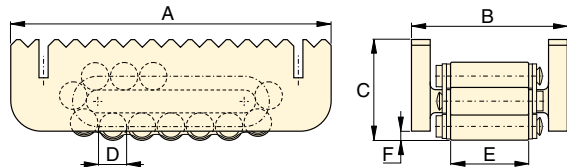

ER-10, ER-15, ER-30

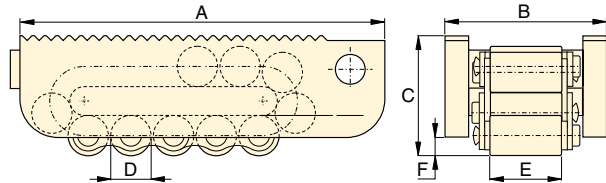

ER-60, ER-80

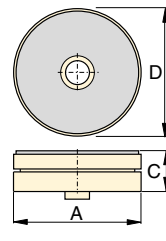

ES-1, Turntable Swivel

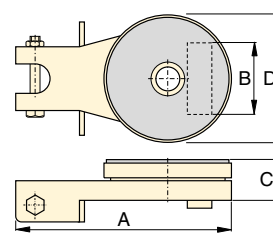

ES-10, ES-15, ES-30 Turntable Swivel

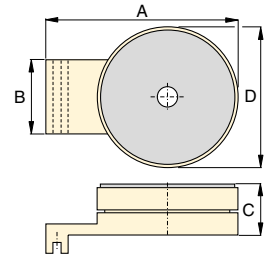

ES-60, ES-80, Turntable Swivel

**EL
ER
ES
Series**



Maximum Carrying Capacity:
80 ton (711 kN)

Load Skates may be ordered separately or as a matched set.					
Set Capacity *	Set Model Number	Load Skates (4x)	Turntable Swivels (2x)	Leveling Plates (2x)	Weight including handles and metal box (kg)
20 (178)	ERS-20	ER-10	ES-10	ELP-10	49
30 (267)	ERS-30	ER-15	ES-15	ELP-15	55
60 (533)	ERS-60	ER-30	ES-30	ELP-30	75

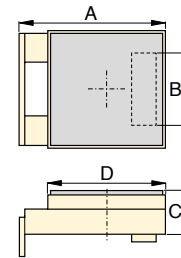

ELP-10, ELP-15, ELP-30 Levelling Plate

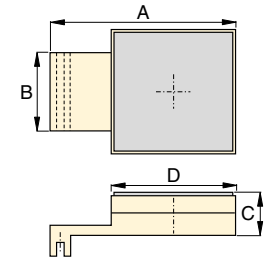

ELP-60, ELP-80 Levelling Plate

* Sets are designed to enable two skates to take full load for extra safety on uneven floor surfaces

	Capacity ton (kN)	Model Number	Dimensions (mm)						Contact Rolls per Skate	Rollers per Skate	Weight (kg)
			A	B	C	D	E	F			
Load Skates 	1 (8,9)	ER-1	170	100	65	18	51	6	4	11	3,8
	10 (89)	ER-10	210	102	66	18	51	6	5	15	5,2
	15 (133)	ER-15	220	115	75	24	60	10	4	13	7,3
	30 (267)	ER-30	270	130	92	30	68	10	4	13	13,0
	60 (533)	ER-60	380	168	125	42	76	16	4	13	31,9
Turntable Swivel 	1 (8,9)	ES-1	207	-	26	90	-	-	-	-	1,1
	10 (89)	ES-10	220	73	42	130	-	-	-	-	3,7
	15 (133)	ES-15	220	86	42	130	-	-	-	-	3,7
	30 (267)	ES-30	250	96	48	150	-	-	-	-	5,3
	60 (533)	ES-60	275	114	61	190	-	-	-	-	13,7
Levelling Plate 	10 (89)	ELP-10	149	73	42	120	-	-	-	-	3,7
	15 (133)	ELP-15	149	86	42	120	-	-	-	-	3,7
	30 (267)	ELP-30	178	96	48	130	-	-	-	-	5,3
	60 (533)	ELP-60	270	114	61	180	-	-	-	-	13,8
	80 (711)	ELP-80	350	128	61	200	-	-	-	-	18,8

▼ CM-16



- Protect your equipment from dust, water, grease and dirt
- Reduce losses on the jobsite, maintenance area or shop
- Durable steel, painted with rust-resistant primer and finished in durable enamel
- Heavy duty hinges and lifting handles
- Lockable.

▼ When not storing the lifting system, this heavy-duty storage case doubles as a work station.



CM Series

Case Size:

19 - 453 litres

Protect your Equipment



Maintenance Sets

Enerpac Maintenance sets are a complete assortment of hydraulic powered tools.

Using these sets allows you to quickly configure a unique tool to meet your most difficult jobs.

Built around the Enerpac lightweight hand pump, hose and cylinder, these sets enable you to push, pull, lift, press, straighten, spread and clamp with forces up to 12,5 ton.

Page: **164**



Hydraulic Pullers

These hydraulic pullers eliminate time-consuming and unsafe hammering, heating or prying. Damage to parts is minimized

through the use of controlled hydraulic power.

Page: **145**

Case Size (litres)	Model Number	Dimensions L x W x H (mm)	Thickness (mm)	 (kg)
19	CM-6	597 x 178 x 178	0,9	7
32	CM-1	635 x 292 x 168	0,9	8
127	CM-4	787 x 457 x 355	1,5	16
212	CM-7	1206 x 381 x 457	1,9	57
453	CM-16	1219 x 609 x 609	1,5	55

Hydraulic Wedgie and Spread Cylinders

▼ Shown clockwise from top: **WR-15, WR-5, A-92**



- **WR-5:** For use in very confined work areas
- **WR-15:** For long stroke spreading applications
- **Single-acting, spring return**
- **A-92:** Spreader attachment; threads on 10 ton RC-Series cylinders * (except RC-101).

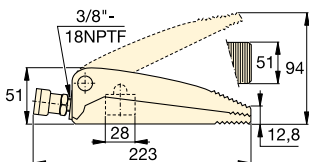

WR-5

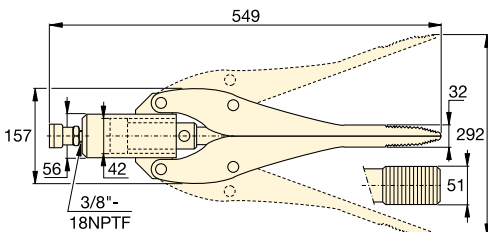

WR-15

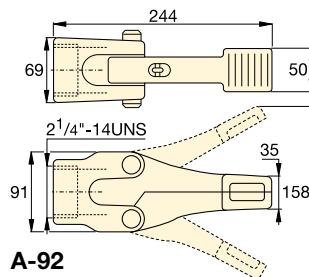

A-92

Cylinder Capacity	Tip Clearance	Model Number	Maximum Spread	Cylinder Effective Area	Oil Capacity	
ton (kN)	(mm)		(mm)	(cm ²)	(cm ³)	(kg)
1,0 (8,9)	12,8	WR-5	94	6,5	10	2,3
0,75 (6)	32,0	WR-15	292	14,5	64	11,3
1,0 (8,9)	35,0	A-92 *	158	–	–	3,6

* Maximum system pressure must be limited to half the rated pressure (350 bar).

A WR Series



Capacity:

0,75 - 1,0 ton

Tip Clearance:

12,8 - 35 mm

Maximum Spread:

94 - 292 mm

Maximum Operating Pressure:

700 bar



RC-Series Cylinders

10 ton RC-Series DUO cylinders (except RC-101) fit into A-92 Spreader Attachment.

Page: **6**



Porta Power Sets

Portable tool sets with hand pump, gauge adaptor assembly, hose and WR-5, RC-, RCS, RSM- or LW-Series cylinder.

Page: **55**



Best Match Hand Pump

To power your WR-5 and WR-15 the **P-392** hand pump is an ideal choice. Use Enerpac H700-Series hose (page 114) for hydraulic connection.

Page: **66**

▼ A WR-5 wedgie cylinder is used to loosen a bridge bearing.



WHC-Series, Hydraulic Cutterheads

▼ Shown from left to right: WHC-4000, WHC-750



WHC, WHR, STC Series

Capacity:
3 - 20 ton

Cutting Capacity:
∅ 13 - 101 mm

Maximum Operating Pressure:
700 bar

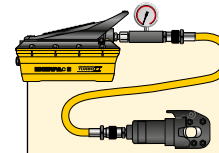

Tool-Pump Sets

Cutterheads marked with an * are available as sets (pump, tool, gauge, couplers and hose) for your ordering convenience.

Cutterhead Model Nr.	Pump Model Nr.	Set Model Number
WHC-750	P-392	STC-750H
WHC-750	P-392FP	STC-750FP
WHC-750	PATG-1102N	STC-750A
WHC-1250	P-392	STC-1250H
WHC-1250	P-392FP	STC-1250FP
WHC-1250	PATG-1102N	STC-1250A

- Single-acting, spring return on all models, except WHR-1250
- Guillotine action for smooth cutting operation
- Lifting handles on larger models for easy transport
- Carrying bag included for easy carrying and tool protection
- Ideal for use with most Enerpac pumps featuring 3-way valve or dump valve and 700 bar pressure rating (except WHR-1250, which requires 4-way valve)
- CR-400 coupler and dust cap included on all models.

▼ Steel rope is easily cut with the smooth guillotine action of an Enerpac cutterhead.



▼ Selection Chart Maximum Cutting Capacities (∅ in mm)

Cutter Head Operation	Capacity ton	Model Number	Oil Capacity (cm ³)	Length (mm)	Steel Wire Rope, Hemp-core or IWRC 6x7 6x12 6x19	Round Bar				Wire Strand				Cable		Replacement Blades (kg)	
						Copper Wire or Bar	Aluminum Wire or Bar	Soft Steel Bolts	Reinforcing Bar	Bare Copper Wire Strands	Bare Aluminum Wire Strands	ACSR	Guy Steel Wire Strands	Telephone Cable CPP	Underground Cable (Power)		
Single-Acting	4	WHC-750*	19,7	127	19	19	19	19	13	19	19	19	16	☆	☆	3,2	WCB-750
	20	WHC-1250*	134,4	279	31	31	31	31	25	31	31	31	22	☆	☆	11,3	WCB-1250
	13	WHC-2000	119,6	381	25	31	31	22	☆	50	50	50	19	☆	☆	10,4	WCB-2000
	3	WHC-3380	65,5	482	☆	☆	☆	☆	☆	76	76	☆	☆	85	85	9,1	WCB-3380
	8	WHC-4000	137,7	609	☆	☆	☆	☆	☆	89	89	☆	☆	101	101	14,5	WCB-4000
Dbl.-Act.	20	WHR-1250	122,9	419	31	31	31	31	25	31	31	31	22	☆	☆	11,8	WCB-1250

* Available in sets with P-392 Hand Pump, P-392FP Foot Pump or PATG-1102N Turbo Air Pump.

☆ Will not cut designated material

Self-Contained Hydraulic Cutters

▼ Shown from left to right: WMC-2000, WMC-750



- Rotating heads for operator convenience
- Guillotine action for smooth cutting operation
- Carrying bag included for easy carrying and tool protection
- Velcro straps to secure handles on larger models for easy carry
- Spring return for easy operation
- Light weight self-contained tool, can be used anywhere.

WMC Series



Capacity:

3 - 20 ton

Cutting Capacity:

Ø 14 - 85 mm



Replacement Blades

60-62HRc hardened replacement blades.

For Cutter Model Number	Order Blades Model Number
WMC-580	WCB-750
WMC-750	WCB-750
WMC-1000	WCB-1000
WMC-1250	WCB-1250
WMC-1580	WCB-1580
WMC-2000	WCB-2000
WMC-3380	WCB-3380



CAUTION !

A "☆" in the charts on these pages means that this hydraulic cutter is not designed to cut this size or type of material. Any attempt to do so may result in personal injury and damage to the unit and will void the warranty.

▼ Selection Chart Maximum Cutting Capacities (Ø in mm)

Capacity ton	Model Number	Length (mm)	Steel Wire Rope, Hempcore or IWRC 6x7 6x12 6x19	Round Bar				Wire Strand					Cable		Weight (kg)
				Copper Wire or Bar	Aluminum Wire or Bar	Soft Steel Bolts	Reinforcing Bar	Bare Copper Wire Strands	Bare Aluminum Wire Strands	ACSR Wire Strands	Guy Steel Wire Strands	Guy Steel Wire Strands	Telephone Cable CPP	Underground Cable (Power)	
4	WMC-580	381	16	16	16	16	10	16	16	16	14	14	☆	☆	3,6
4	WMC-750	381	17	19	19	17	13 **	19	19	19	14	14	☆	☆	3,6
20	WMC-1000 *	679	☆	19	19	19	19	☆	☆	☆	☆	☆	☆	☆	11,3
20	WMC-1250	679	31	28	31	31	22	31	31	31	22	25	☆	☆	10,4
6	WMC-1580	558	19	19	19	19	☆	38	38	38	16	16	☆	☆	6,8
13	WMC-2000	628	25	31	31	22	☆	50	50	50	19	19	☆	☆	10,9
3	WMC-3380	660	☆	☆	☆	☆	☆	46	42	76	76	☆	85	85	10,0

* Cuts 12 mm alloy chain grade 70 (type G7 transport or tie-down) or grade 80 (for overhead lifting applications)

** Low Alloy ☆ Will not cut designated material.

STB-Series, Pipe Bender Sets

▼ Shown: STB-101H



Quick, Safe and Wrinkle-free Bending



'One Shot' and 'Sweep'

One shot shoes give up to a 90° bend without resetting.





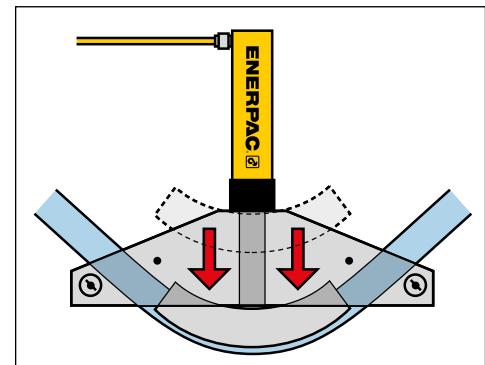



Sweep shoes are used where increasing radii are required for multiple parallel pipe installations.

- Makes smooth, wrinkle-free bends
- Sets include genuine Enerpac cylinder, hose and manual, air or electric pump
- Sets are also available without hydraulics
- Bending shoes and bending frame are lightweight, heat-treated aluminium
- All sets include sturdy steel storage case
- All sets include BZ-12091 angle indicator for accurate bending
- BZ-12377 Shoe Lock Pin included in every set
- Eject-O-Matic™ benders (STB-202 models) have double-acting cylinder to eject pipe from the bending shoe.



▲ Typical one shot bending operation.

▼ SELECTION CHART

Pipe Range Nominal Size (inch)		Bender Set Model Number	Hand Pump *	Air Pump *	Electric Pump *		Cylinder *	Hose *	Saddle *	 (kg)
One Shot	Sweep									
1/2 - 2	-	STB-101X	-	-	-	-	-	-	A-12	40
		STB-101N	-	-	-	-	RC-1010	HC-7206	A-12	48
		STB-101H	P-392	-	-	-	RC-1010	HC-7206	A-12	52
		STB-101A	-	PATG-1102N	-	-	RC-1010	HC-7206	A-12	54
		STB-101E	-	-	PUJ-1200E ²⁾	-	RC-1010	HC-7206	A-12	57
1 - 2	2 1/2 - 4	STB-221X	-	-	-	-	-	-	A-29	104
		STB-221N	-	-	-	-	RC-2510	HC-7206	A-29	119
		STB-221H	P-80	-	-	-	RC-2510	HC-7206	A-29	130
1 1/4 - 4	-	STB-202X ¹⁾	-	-	-	-	-	-	A-29	143
		STB-202N ¹⁾	-	-	-	-	RR-3014	HC-7206 (2x)	A-29	174
		STB-202E ¹⁾	-	-	-	ZU4408SE ²⁾	RR-3014	HC-7206 (2x)	A-29	212

* See corresponding sections in this catalog for more detailed specifications.

¹⁾ Eject-O-Matic™

²⁾ For 115 volt applications replace the last digit of Set Model Number and pump from 'E' to 'B'.

Pipe Bender Sets

Nominal Pipe Size (inch)	Wall Thickness (mm)	Schedule Pipe *	Pipe Bend Inside Radius (inch)	STB-101	STB-221 ø 1 - 2" One Shot	STB-202	One Shot Bending Shoe Model Number	Sweep Bending Shoe Model Number
				ø ½ - 2" One Shot	ø 2¼ - 4" Sweep	ø 1¼ - 4" One Shot		
½	2,8	40	27/8	Yes	-	-	BZ-12011	-
	3,7	80		Yes	-	-		
	4,7	160		WS	-	-		
	7,5	DEH		WS	-	-		
¾	2,9	40	4	Yes	-	-	BZ-12021	-
	3,9	80		Yes	-	-		
	5,5	160		WS	-	-		
	7,8	DEH		WS	-	-		
1	3,4	40	5½	Yes	Yes	-	BZ-12031	-
	4,5	80		Yes	Yes	-		
	6,4	160		WS	WS	-		
	9,1	DEH		-	WS	-		
1¼	3,6	40	67/16	Yes	Yes	Yes	BZ-12041	-
	4,9	80		Yes	Yes	Yes		
	6,4	160		WS	WS	Yes		
	8,7	DEH		-	WS	WS		
1½	3,7	40	7 5/16	Yes	Yes	Yes	BZ-12051	-
	5,1	80		Yes	Yes	Yes		
	7,1	160		WS	WS	Yes		
	10,2	DEH		-	WS	WS		
2	3,9	40	8 5/16	-	Yes	Yes	BZ-12061	-
	5,5	80		-	Yes	Yes		
	8,7	160		-	WS	Yes		
2½	5,2	40	9½	-	Yes	Yes	BZ-12341	BZ-12382
	7,0	80		-	WS	Yes		
	9,5	160		-	WS	Yes		
3	5,5	40	11¼	-	Yes	Yes	BZ-12351	BZ-12383
	7,6	80		-	WS	Yes		
3½	5,7	40	15½	-	Yes	Yes	BZ-12391	BZ-12384
	8,1	80		-	WS	Yes		
4	6,0	40	17¾	-	Yes	Yes	BZ-12392	BZ-12385
	8,6	80		-	-	Yes		

* Schedule Pipe: 40 = Standard; 80 = Extra Heavy; 160 = Double Extra Heavy;
DEH = Double Extra Heavy (slightly thicker than 160);
WS = Can be bent using wider spacing for swivel shoes.

STB Series



Nominal Pipe Size:

½ - 4 inch

Maximum Bending:

90°

Maximum Operating Pressure:

700 bar



All bender sets are designed to bend mild steel pipe. For other material please consult Enerpac.

Frame Assembly	Pivot Pins (2x)	Pivot Shoes (2x)	Bending Shoes included (Shoes with ³⁾ are Sweep, all other shoes are One Shot)									Bender Set Model Number	
BZ-12371	BZ-12375	BZ-12071	BZ-12011	BZ-12021	BZ-12031	BZ-12041	BZ-12051	BZ-12061	-	-	STB-101X		
												STB-101N	
													STB-101H
													STB-101A
													STB-101E
BZ-12372	BZ-12376	BZ-13401	BZ-12031	BZ-12041	BZ-12051	BZ-12061	BZ-12382 ³⁾	BZ-12383 ³⁾	BZ-12384 ³⁾	BZ-12385 ³⁾	STB-221X		
												STB-221N	
												STB-221H	
BZ-12374	BZ-12376	BZ-13401	-	BZ-12041	BZ-12051	BZ-12061	BZ-12341	BZ-12351	BZ-12391	BZ-12392	STB-202X ¹⁾		
												STB-202N ¹⁾	
												STB-202E ¹⁾	