

Shown: PLSS-121, PUSD-121



▶ Hydraulic pull cylinders utilize hydraulic pressure to hold down parts in a fixture. The guided plunger maintains orientation during the full clamping cycle, eliminating the need for an external guide. Internally threaded plunger ends accept various custom attachments to assist in the clamping process.

Enerpac offers both single- and double-acting pull cylinders, with capacities ranging from 1250 to 9600 lbs. for pulling and 2950 to 18,400 lbs. for pushing applications.

■ Hydraulic fixture with pull and swing cylinders, manifold and threaded cylinders for positioning and holding the work piece during milling process of gun breeches.



Compact and full featured design

- Guided linear plunger movement
- Compact design allows for efficient fixture layout
- Variety of mounting styles to meet design needs
- Internal plunger thread and flats across plunger top allow easy mounting of attachments
- Choice of porting styles to meet system and design requirements
- Single- and double-acting cylinders to suit a variety of hydraulic requirements

i Select your pull cylinder type:

Single acting

- The obvious choice when there are few system restrictions, and there are not many units retracting simultaneously
- Valving and plumbing is less complex

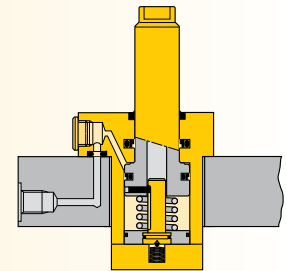

Double acting

- When greater control is required during the unclamp cycle
- When heavy attachments are being used
- When timing sequences are critical: less sensitive to system back pressures resulting from long tube lengths or numerous components being retracted at the same time

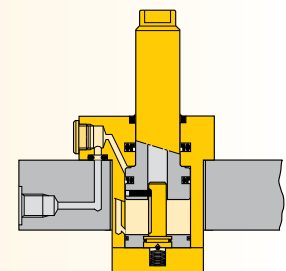

i Select your mounting method:

PU series, Upper flange mounting

- Flexible design allows for manifold or threaded oil port connection
- Fixture hole does not require tight tolerances
- Easy installation with only 3 or 4 mounting bolts

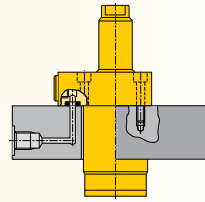

60 ▶

PL series, Lower flange mounting

- Flexible design allows for manifold or threaded port connection
- No fixture hole required
- Easy installation with only 3 or 4 mounting bolts

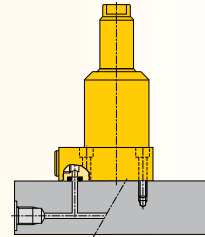

62 ▶

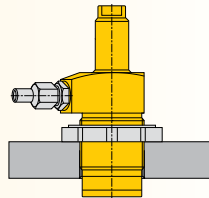

PT series, Threaded body mounting

- Body thread for precise cylinder height positioning
- Threaded oil port connection
- Can be threaded directly into the fixture and secured in position by means of standard flange nuts



64 ▶

globe Product selection

Cylinder capacity		Stroke	Upper flange	Lower flange	Threaded body
lbs		in			
Pull	Push				
▼ Single acting					
Model number					
1250	-	.89	PUSS-51	PLSS-51	PTSS-51
2950	-	1.10	PUSS-121	PLSS-121	PTSS-121
▼ Double acting					
Model number					
1400	2950	.89	PUSD-51	PLSD-51	PTSD-51
2475	6300	.87	PUSD-92	PLSD-92	PTSD-92
3150	6150	1.10	PUSD-121	PLSD-121	PTSD-121
9600	18,400	1.20	PUSD-351	PLSD-351	PTSD-351

Note: - Call Enerpac to order models with metric thread and BSPP port connections.
- Pull forces for single-acting cylinders reduced due to spring force.

www.enerpacwh.com

Pull force: 1250-9600 lbs

Push force: 2950-18,400 lbs

Stroke: 0.87-1.20 inch

Pressure: 500-5000 psi

E Cilindros de tracción

F Verins traction

D Zugzylinder

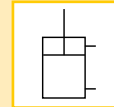
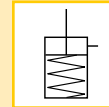

lightbulb Options

Accessories

86 ▶



Collet-Lok® push cylinders

18 ▶



Work supports

43 ▶



Swing cylinders

22 ▶



Sequence valves

152 ▶



Pull cylinders - Upper flange models

Shown: PUSS-51, PUSD-121



PU series

Upper flange pull cylinders are designed for integrated manifold mounting solutions.

Hydraulic connections are made through SAE or BSPP oil connection or the standard integrated O-ring ports.

Oil connection

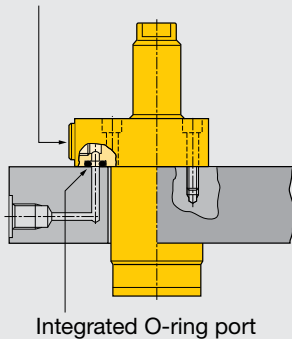

Integrated O-ring port

■ Enerpac upper flange pull cylinders in a fixture for gun breech production.



Minimal mounting height

...when space is at a premium

- Guided linear plunger movement
- Flexible design allows for manifold or threaded port connection
- Low profile mounting style allows body to be below mounting surface
- Internal plunger thread allows easy mounting of attachments
- Simple mounting preparation
- Easy to machine fixture hole: does not require tight tolerances
- Easy assembly: 3 or 4 mounting bolts
- Double oil connection: threaded port or manifold mount

Product selection

Cylinder capacity		Stroke	Model number	Cylinder effective area		Oil capacity	
lbs Pull	lbs Push	in		in ² Pull	in ² Push	in ³ Pull	in ³ Push
▼ Single acting							
1250	–	.89	PUSS-51	.28	–	.25	–
2950	–	1.10	PUSS-121	.63	–	.70	–
▼ Double acting							
1400	2950	.89	PUSD-51	.28	.59	.25	.53
2475	6300	.87	PUSD-92	.49	1.25	.42	1.08
3150	6150	1.10	PUSD-121	.63	1.23	.70	1.40
9600	18,400	1.20	PUSD-351	1.92	3.68	2.27	4.35

Note: - Call Enerpac to order models with BSPP oil connections.
- Pull forces for single-acting cylinders reduced due to spring force.

Dimensions in inches []

Model number	A	B	C1	D	D1	D2	E	E1	F	H
				∅			∅	∅		
▼ Single acting										
PUSS-51	5.07	4.18	0.98	1.37	2.13	2.25	0.63	0.59	0.51	0.55
PUSS-121	6.31	5.21	1.00	1.87	2.62	2.88	0.87	0.82	0.68	0.61
▼ Double acting										
PUSD-51	5.07	4.18	0.98	1.37	2.13	2.25	0.63	0.59	0.51	0.55
PUSD-92	5.43	4.57	0.98	1.88	2.76	2.13	0.98	0.93	0.70	0.49
PUSD-121	6.31	5.21	1.00	1.87	2.62	2.88	0.87	0.82	0.68	0.61
PUSD-351	8.04	6.83	0.98	3.14	3.94	3.50	1.50	1.42	1.13	0.49

Installation dimensions in inches

Pull force lbs	Fixture hole Ø D3	Mounting thread J UNF	Min. depth J2	Manifold O-ring ¹⁾ ARP numbers or Inside Ø x thickness
1400	1.39	.250-28	.65	568-011
2475	1.93	M6	.59	.17 x .139
3150	1.89	.312-24	.80	568-011
9600	3.06	.375-24	.74	.17 x .139

¹⁾ O-ring material: polyurethane, 92 Durometer

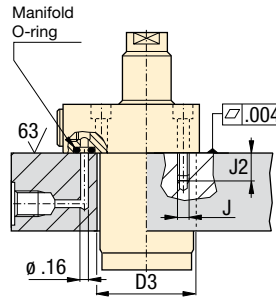

-51, 121

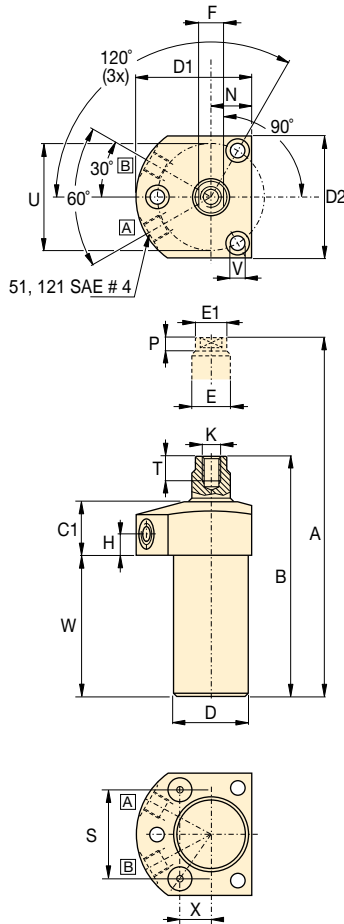

-92, 351

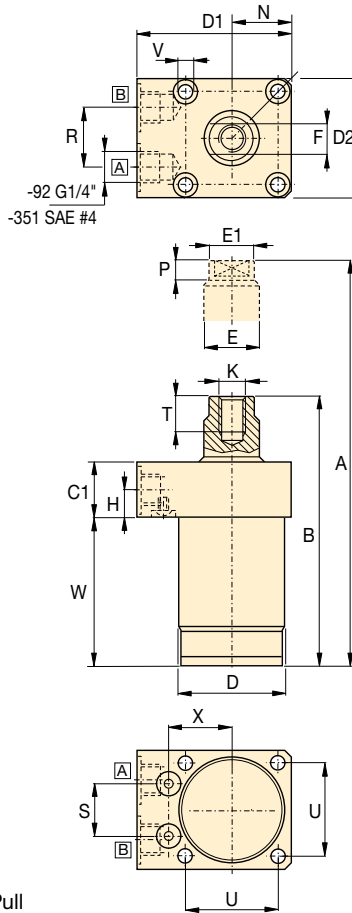

- Pull force: 1250-9600 lbs**
- Push force: 2950-18,400 lbs**
- Stroke: .87-1.20 inch**
- Pressure: 500-5000 psi**

- E Cilindros de tracción**
- F Verins traction**
- D Zugzylinder**

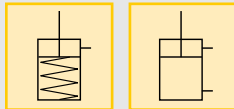

Options

Accessories 86 ▶

Collet-Lok® push cylinders 18 ▶

Swing cylinders 22 ▶

Sequence valves 152 ▶

Important

Single-acting cylinders can be vented through the manifold port.

The upper flange pull cylinder has a bolt pattern which is identical to its lower flange equivalent, enabling interchangeability.

In case there is a risk of machining coolants and debris being inhaled via the breather vent, it is recommended to pipe this port to an area outside the fixture that is protected from machining coolants and debris.

	K	N	P	R	S	T	U	V	W	X	lbs	Model number
								Ø				
												Single acting ▼
	.312-24 UNF	0.75	0.23	-	1.614	0.62	1.97	0.27	2.60	0.565	2.5	PUSS-51
	.500-20 UNF	0.99	0.37	-	2.048	0.75	2.50	0.35	3.38	0.717	3.5	PUSS-121
												Double acting ▼
	.312-24 UNF	0.75	0.23	-	1.614	0.62	1.97	0.27	2.60	0.565	2.5	PUSD-51
	M10 x 1.50	1.04	0.41	1.02	0.934	0.63	1.65	0.26	2.99	1.128	4.4	PUSD-92
	.500-20 UNF	0.99	0.37	-	2.048	0.75	2.50	0.35	3.38	0.717	3.5	PUSD-121
	M16 x 2.00	1.71	0.51	1.02	1.356	1.22	2.76	0.43	3.80	1.637	12.3	PUSD-351

Pull cylinders - Lower flange models

Shown: PLSS-51, PLSS-121



PL series

The lower flange cylinders are designed for integrated manifold mounting solutions. Hydraulic connections are made through SAE or BSPP oil connection or the standard integrated O-ring ports.

Oil connection

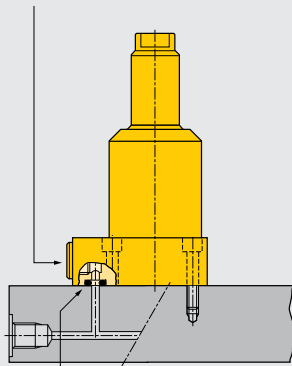

Integrated O-ring port

Minimal mounting height

...when space is at a premium

- Guided linear plunger movement
- Flexible design allows for manifold or threaded port connection
- Low profile mounting style allows body to be below mounting surface
- Internal plunger thread allows easy mounting of attachments
- Easiest mounting preparation in the line
- Easy to machine fixture hole: does not require tight tolerances
- Easy assembly: 3 or 4 mounting bolts
- Double oil connection: threaded port or manifold mount

Product selection

Cylinder capacity		Stroke	Model number	Cylinder effective area		Oil capacity	
lbs Pull	Push	in		in ² Pull	Push	in ³ Pull	Push
▼ Single acting							
1250	-	.89	PLSS-51	.28	-	.25	-
2950	-	1.10	PLSS-121	.63	-	.70	-
▼ Double acting							
1400	2950	.89	PLSD-51	.28	.59	.25	.53
2475	6300	.87	PLSD-92	.49	1.25	.42	1.08
3150	6150	1.10	PLSD-121	.63	1.23	.70	1.40
9600	18,400	1.20	PLSD-351	1.92	3.68	2.27	4.35

Note: - Call Enerpac to order models with BSPP oil connections.
- Pull forces for single-acting cylinders reduced due to spring force.

Dimensions in inches []

Model number	A	B	C1	D	D1	D2	E	E1	F	H
				∅			∅	∅		
▼ Single acting										
PLSS-51	5.07	4.18	0.98	1.37	2.13	2.25	0.63	0.59	0.51	0.55
PLSS-121	6.31	5.21	1.00	1.87	2.62	2.88	0.87	0.82	0.68	0.61
▼ Double acting										
PLSD-51	5.07	4.18	0.98	1.37	2.13	2.25	0.63	0.59	0.51	0.55
PLSD-92	5.43	4.57	0.98	1.88	2.76	2.13	0.98	0.93	0.7	0.49
PLSD-121	6.31	5.21	1	1.87	2.62	2.88	0.87	0.82	0.68	0.61
PLSD-351	8.04	6.83	0.98	3.14	3.94	3.5	1.5	1.42	1.13	0.49

Installation dimensions in inches

Pull force lbs	Mounting thread J UNF	Minimum depth J2	Manifold O-ring ¹⁾ ARP numbers or inside Ø x thickness
1400	.250-28	.65	568-011
2475	M6	.59	.17 x .139
3150	.312-24	.80	568-011
9600	.375-24	.74	.17 x .139

¹⁾ O-ring material: polyurethane, 92 Durometer

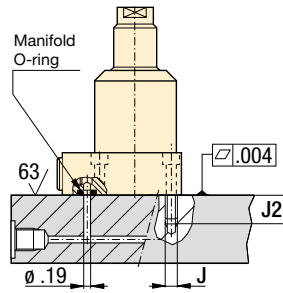

-51, -121

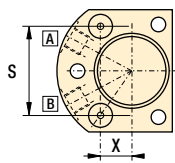
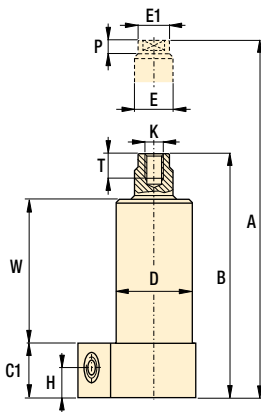
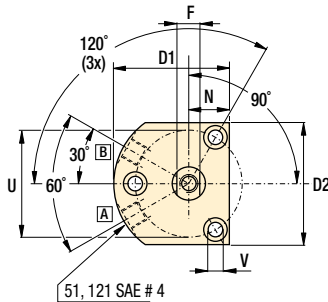

[A] = Pull
[B] = Push (venting)

-92, -351

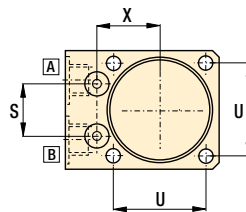
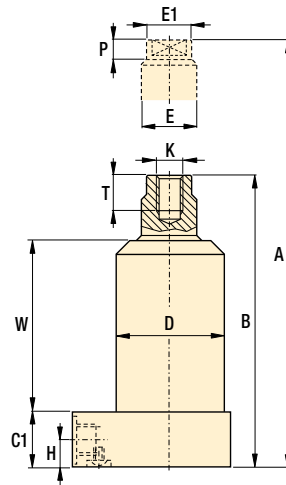
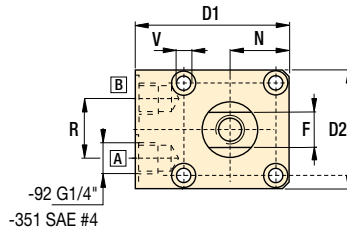

- Pull force: 1250-9600 lbs**
- Push force: 2950-18,400 lbs**
- Stroke: .86-1.20 inch**
- Pressure: 500-5000 psi**

- E Cilindros de tracción**
- F Verins traction**
- D Zugzylinder**

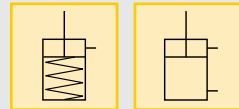

Options

Accessories  86 ▶

Collet-Lok® push cylinders  18 ▶

Swing cylinders  22 ▶

Sequence valves  152 ▶

Important

Single-acting cylinders can be vented through the manifold port.

The lower flange pull cylinder has a bolt pattern which is identical to its upper flange equivalent, enabling interchangeability.

In case there is a risk of machining coolants and debris being inhaled via the breather vent, it is recommended to pipe this port to an area outside the fixture that is protected from machining coolants and debris.

	K	N	P	R	S	T	U	V	W	X	Model number	
											lbs	
Single acting ▼												
	.312-24 UNF	0.75	0.23	-	1.614	0.62	1.97	0.27	2.60	0.565	2.5	PLSS-51
	.500-20 UNF	0.99	0.37	-	2.048	0.75	2.50	0.35	3.38	0.717	3.5	PLSS-121
Double acting ▼												
	.312-24 UNF	0.75	0.23	-	1.614	0.62	1.97	0.27	2.60	0.565	2.5	PLSD-51
	M10 x 1.50	1.04	0.41	1.02	0.934	0.63	1.65	0.26	2.99	1.128	4.4	PLSD-92
	.500-20 UNF	0.99	0.37	-	2.048	0.75	2.50	0.35	3.38	0.717	3.5	PLSD-121
	M16 X 2.00	1.71	0.51	1.02	1.356	1.22	2.76	0.43	3.80	1.637	12.3	PLSD-351

Pull cylinders - Threaded body models

Shown: PTSS-51, PTSD-121



PT-series

The threaded body pull cylinders can be bolted to the fixture.

This allows easy installation or removal of the unit and does not require machined fixture holes.

The cylinder is adjusted to the appropriate height, and then locked in place using a flange nut (□86).

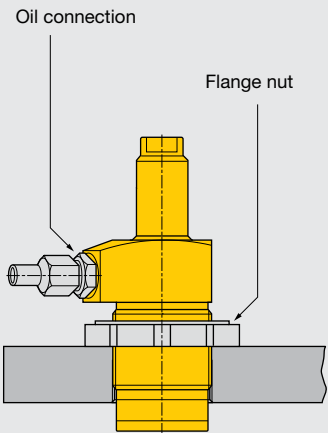

■ Threaded body pull cylinder with modified clamp arm, mounted on a frame-straightening fixture.



Threaded directly into the fixture

...can be secured at any height

- Guided linear plunger movement
- Threaded port connection
- Internal plunger thread allows easy mounting of attachments
- Simple mounting preparation
- Easy installation and removal
- Greatest flexibility in fixture design

Product selection

Cylinder capacity		Stroke in	Model number	Cylinder effective area		Oil capacity	
lbs Pull	Push			in ² Pull	Push	in ³ Pull	Push
▼ Single acting							
1250	–	.89	PTSS-51	.28	–	.25	–
2950	–	1.10	PTSS-121	.63	–	.70	–
▼ Double acting							
1400	2950	.89	PTSD-51	.28	.59	.25	.53
2475	6300	.87	PTSD-92	.49	1.25	.42	1.08
3150	6150	1.10	PTSD-121	.63	1.23	.70	1.40
9600	18,400	1.20	PTSD-351	1.92	3.68	2.27	4.35

Note: - Call Enerpac to order models with BSPP oil connections.
- Pull forces for single-acting cylinders reduced due to spring force.

Dimensions in inches []

Model number	A	B	C1	D	D1	D2	E
				Thread			Ø
▼ Single acting							
PTSS-51	5.07	4.18	0.98	1.375-18 UNEF	1.88	1.49	0.63
PTSS-121	6.31	5.22	1.00	1.875-16 UN	2.38	2.00	0.87
▼ Double acting							
PTSD-51	5.07	4.18	0.98	1.375-18 UNEF	1.88	1.49	0.63
PTSD-92	5.12	4.25	1.19	M48 x 1,5	2.47	1.90	0.98
PTSD-121	6.31	5.22	1.00	1.875-16 UN	2.38	2.00	0.87
PTSD-351	7.72	6.52	1.26	3.125-16 UN	3.48	3.15	1.50

Installation dimensions in inches

Pull force lbs	Fixture hole thread size D3
1400	1.375-18 UNEF
2475	M48 x 1.5
3150	1.875-16 UNF
9600	3.125-16 UN

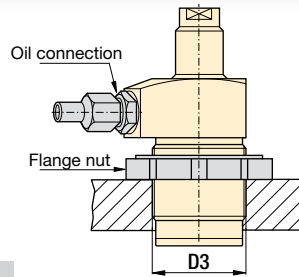

-51, 121

-92, -351

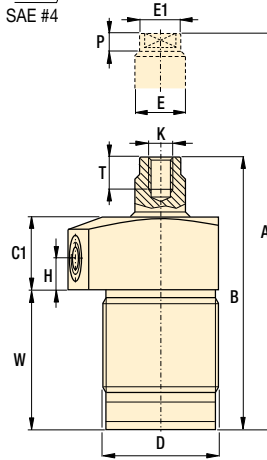
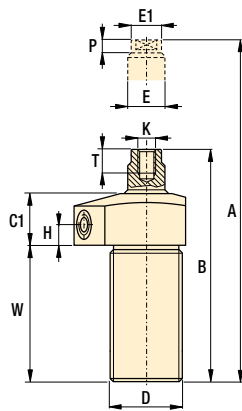
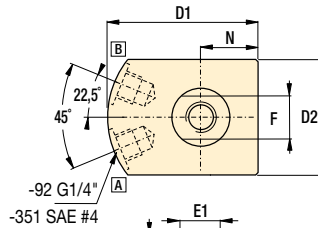
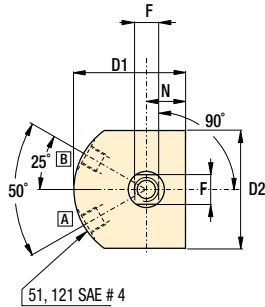

A = Pull
B = Push (venting)

Accessory chart

Model number	Mounting flange Sold separately 87 ▶	Flange nut Sold separately 86 ▶	Yoke Sold separately
--------------	--	---------------------------------------	-------------------------

▼ Single acting

PTSS-51	MF-351	FN-351	Y3121
PTSS-121	MF-481	FN-811	

▼ Double acting

PTSD-51	MF-351	FN-351	Y3121
PTSD-92	MF-482	FN-482	
PTSD-121	MF-481	FN-481	
PTSD-351	MF-801	FN-801	

	E1	F	H	K	N	P	T	W	lbs	Model number
	∅									
										Single acting ▼
	.59	.51	.38	.313-24 UNF	.75	.23	.62	2.60	2.5	PTSS-51
	.82	.68	.38	.500-20 UNF	1.00	.38	.75	3.38	3.5	PTSS-121
										Double acting ▼
	.59	.51	.38	.313-24 UNF	.75	.23	.62	2.60	2.5	PTSD-51
	.93	.70	.51	M10 x 1.5	.95	.41	.63	2.47	4.4	PTSD-92
	.82	.68	.38	.500-20 UNF	1.00	.38	.75	3.38	3.5	PTSD-121
	1.42	1.13	.51	M16 x 2.0	1.57	.51	1.22	3.22	10.4	PTSD-351

- Pull force: 1250-9600 lbs**
- Push force: 2950-18,400 lbs**
- Stroke: .87-1.20 inch**
- Pressure: 500-5000 psi**

- E** Cilindros de tracción
- F** Verins traction
- D** Zugzylinder

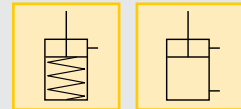

Options

- Accessories** 86 ▶
- Collet-Lok® swing cylinders** 18 ▶
- Swing cylinders** 22 ▶
- Sequence valves** 152 ▶

Important

Single-acting cylinders can be vented through the manifold port.

In case there is a risk of machining coolants and debris being inhaled via the breather vent, it is recommended to pipe this port to an area outside the fixture that is protected from machining coolants and debris.

Threaded cylinders *Application & selection*

Shown: CST-9381, CST-571, CST-18251, CDT-18131, CDT-40251



▶ Threaded cylinders are designed for workpiece positioning, holding and ejecting applications where space is at a premium. Double-acting models are also suited to manufacturing applications, such as production punching.

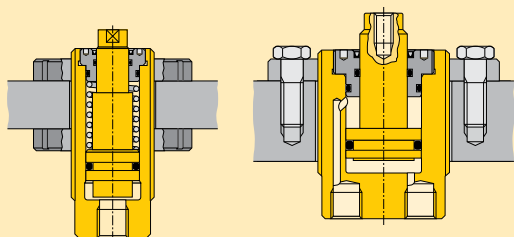

Accessory chart

Body thread D	Mounting flange Sold Separately 87 ▶	Flange nut Sold Separately 86 ▶	Plunger thread K	Contact bolt Sold Separately 86 ▶
0.500-20 UN	MF-121	FN-121	#6-32 UN	BS-21
0.750-16 UN	MF-201	FN-201	#8-32 UN	BS-41
1.000-12 UN	MF-251	FN-251	0.250-28 UN	BS-61
1.313-16 UN	MF-331	FN-331	0.313-24 UN	BS-81
1.625-16 UN	MF-421	FN-421	0.375-16 UN	BS-91
1.875-16 UN	MF-481	FN-481	0.500-13 UN	BS-101
2.125-16 UN	MF-551	FN-551		
2.500-16 UN	MF-651	FN-651		

■ Threaded cylinder, mounted with horizontal bracket to position the workpiece against the stops. Enerpac swing cylinders are then activated to clamp the work piece before machining operations begin.



High clamping forces in a compact body

- Minimum cylinder diameter combined with maximized clamping forces
- Threaded body allows fine positioning and easy installation
- Internal plunger wipers allow maintenance-free, high-cycle performance
- Center-tapped plungers will hold workpiece contact buttons
- Single-acting models with spring return simplify hydraulic tubing requirements
- Double-acting models are recommended for high-cycle applications

Product selection

Cylinder capacity at 5000 psi lbs	Stroke in	Model number	Effective area in ²		Oil capacity in ³		
			push	pull	push	pull	
▼ Single acting							
380	–	0.24	CST-271	0.08	–	0.02	–
380	–	0.36	CST-2101	0.08	–	0.03	–
380	–	0.52	CST-2131	0.08	–	0.04	–
980	–	0.27	CST-471	0.20	–	0.05	–
980	–	0.50	CST-4131	0.20	–	0.10	–
980	–	0.76	CST-4191	0.20	–	0.15	–
980	–	0.98	CST-4251	0.20	–	0.19	–
980	–	1.49	CST-4381	0.20	–	0.29	–
1950	–	0.28	CST-971	0.39	–	0.11	–
1950	–	0.52	CST-9131	0.39	–	0.20	–
1950	–	0.76	CST-9191	0.39	–	0.29	–
1950	–	1.04	CST-9251	0.39	–	0.38	–
1950	–	1.52	CST-9381	0.39	–	0.58	–
3950	–	0.51	CST-18131	0.79	–	0.40	–
3950	–	0.98	CST-18251	0.79	–	0.78	–
3950	–	1.49	CST-18381	0.79	–	1.18	–
3950	–	1.97	CST-18501	0.79	–	1.56	–
6110	–	0.59	CST-27151	1.22	–	0.72	–
6110	–	0.98	CST-27251	1.22	–	1.20	–
6110	–	1.97	CST-27501	1.22	–	2.40	–
8800	–	0.58	CST-40131	1.76	–	0.90	–
8800	–	1.05	CST-40251	1.76	–	1.73	–
8800	–	1.56	CST-40381	1.76	–	2.63	–
8800	–	2.03	CST-40501	1.76	–	3.46	–
▼ Double acting							
3900	2330	0.51	CDT-18131	0.77	0.46	0.40	0.24
3900	2330	0.98	CDT-18251	0.77	0.46	0.78	0.46
3900	2330	1.50	CDT-18381	0.77	0.46	1.18	0.70
3900	2330	1.97	CDT-18501	0.77	0.46	1.52	0.91
6110	4080	0.57	CDT-27151	1.22	0.82	0.72	0.48
6110	4080	0.97	CDT-27251	1.22	0.82	1.20	0.81
6110	4080	1.96	CDT-27501	1.22	0.82	2.40	1.61
8800	5870	0.51	CDT-40131	1.76	1.17	0.90	0.60
8800	5870	0.99	CDT-40251	1.76	1.17	1.73	1.15
8800	5870	1.50	CDT-40381	1.76	1.17	2.63	1.75
8800	5870	1.97	CDT-40501	1.76	1.17	3.46	2.30

Note: - Seal material: Buna-N, Polyurethane.
- Minimum operating pressure for single-acting models (to overcome return spring force) is 580 psi.

CST-271, -2101, -2131

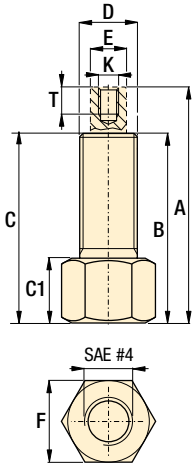

Other CST models

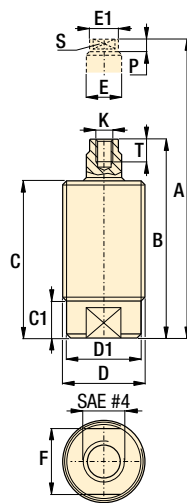

CDT models

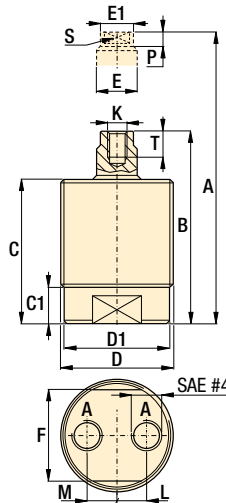

Force: 380-8800 lbs

Stroke: 0.24-2.03 inch

Pressure: 580-5000 psi

- E** Cilindros roscados
- F** Vérins corps filetés
- D** Einschraubzylinder

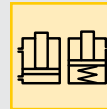

Options

Accessories

86 ▶



Product dimensions in inches []

Model number	A Ext. height	B Retr. height	C	C1	D ø	D1 ø	E ø	E1 ø	F	K thread	L Retr.	M Ext.	P	S	T	lbs
▼ Single acting																
CST-271	1.89	1.65	1.61	0.59	.500-20 UNF	-	0.19	-	0.63	#6-32 UNC	-	-	-	-	0.20	0.2
CST-2101	2.13	1.77	1.74	0.61	.500-20 UNF	-	0.19	-	0.63	#6-32 UNC	-	-	-	-	0.20	0.3
CST-2131	2.55	2.03	2.03	0.61	.500-20 UNF	-	0.19	-	0.63	#6-32 UNC	-	-	-	-	0.20	0.3
CST-471	2.14	1.87	1.71	0.37	.750-16 UNF	0.69	0.27	-	0.62	#8-32 UNC	-	-	0.16	0.25	0.28	0.4
CST-4131	2.71	2.21	2.05	0.37	.750-16 UNF	0.69	0.27	-	0.62	#8-32 UNC	-	-	0.16	0.25	0.28	0.3
CST-4191	3.38	2.62	2.46	0.37	.750-16 UNF	0.69	0.27	-	0.62	#8-32 UNC	-	-	0.16	0.25	0.28	0.4
CST-4251	3.95	2.97	2.81	0.37	.750-16 UNF	0.69	0.27	-	0.62	#8-32 UNC	-	-	0.16	0.25	0.28	0.5
CST-4381	5.76	4.27	4.11	0.37	.750-16 UNF	0.69	0.27	-	0.62	#8-32 UNC	-	-	0.16	0.25	0.28	0.7
CST-971	2.54	2.26	2.03	0.32	1.000-12 UNF	0.88	0.39	-	0.79	.250-28 UNF	-	-	0.15	0.32	0.39	0.6
CST-9131	3.02	2.50	2.28	0.32	1.000-12 UNF	0.88	0.39	-	0.79	.250-28 UNF	-	-	0.15	0.32	0.39	0.7
CST-9191	3.87	3.11	2.89	0.32	1.000-12 UNF	0.88	0.39	-	0.79	.250-28 UNF	-	-	0.15	0.32	0.39	0.8
CST-9251	4.46	3.42	3.21	0.32	1.000-12 UNF	0.88	0.39	-	0.79	.250-28 UNF	-	-	0.15	0.32	0.39	0.9
CST-9381	5.63	4.11	3.91	0.32	1.000-12 UNF	0.88	0.39	-	0.79	.250-28 UNF	-	-	0.15	0.32	0.39	1.0
CST-18131	3.26	2.75	2.50	0.49	1.313-16 UN	1.22	0.63	0.59	1.06	.313-24 UNF	-	-	0.26	0.50	0.47	1.2
CST-18251	4.50	3.52	3.27	0.49	1.313-16 UN	1.22	0.63	0.59	1.06	.313-24 UNF	-	-	0.26	0.50	0.47	1.3
CST-18381	5.76	4.27	4.02	0.49	1.313-16 UN	1.22	0.63	0.59	1.06	.313-24 UNF	-	-	0.26	0.50	0.47	1.5
CST-18501	6.87	4.90	4.65	0.49	1.313-16 UN	1.22	0.63	0.59	1.06	.313-24 UNF	-	-	0.26	0.50	0.47	1.7
CST-27151	3.46	2.87	2.62	0.54	1.625-16 UN	1.52	0.71	0.67	1.38	.375-16 UNC	-	-	0.26	0.57	0.47	1.4
CST-27251	4.66	3.68	3.43	0.54	1.625-16 UN	1.52	0.71	0.67	1.38	.375-16 UNC	-	-	0.26	0.57	0.47	2.0
CST-27501	7.71	5.74	5.49	0.54	1.625-16 UN	1.52	0.71	0.67	1.38	.375-16 UNC	-	-	0.26	0.57	0.47	2.9
CST-40131	3.52	2.94	2.70	0.43	1.875-16 UN	1.79	0.78	0.75	1.63	.500-13 UNC	-	-	0.31	0.67	0.47	2.2
CST-40251	4.78	3.73	3.48	0.43	1.875-16 UN	1.79	0.78	0.75	1.63	.500-13 UNC	-	-	0.31	0.67	0.47	2.6
CST-40381	6.49	4.93	4.69	0.43	1.875-16 UN	1.79	0.78	0.75	1.63	.500-13 UNC	-	-	0.31	0.67	0.47	3.3
CST-40501	7.44	5.41	5.16	0.43	1.875-16 UN	1.79	0.78	0.75	1.63	.500-13 UNC	-	-	0.31	0.67	0.47	3.9
▼ Double acting																
CDT-18131	3.19	2.68	2.42	0.63	1.875-16 UN	1.73	0.63	0.59	1.61	.313-24 UNF	0.53	0.39	0.26	0.50	0.47	2.4
CDT-18251	4.21	3.23	2.97	0.63	1.875-16 UN	1.73	0.63	0.59	1.61	.313-24 UNF	0.53	0.39	0.26	0.50	0.47	2.9
CDT-18381	5.18	3.68	3.43	0.63	1.875-16 UN	1.73	0.63	0.59	1.61	.313-24 UNF	0.53	0.39	0.26	0.50	0.47	3.4
CDT-18501	6.12	4.15	3.90	0.63	1.875-16 UN	1.73	0.63	0.59	1.61	.313-24 UNF	0.53	0.39	0.26	0.50	0.47	3.9
CDT-27151	3.37	2.80	2.54	0.67	2.125-16 UN	2.02	0.71	0.67	1.87	.375-16 UNC	0.65	0.39	0.26	0.62	0.47	2.6
CDT-27251	4.20	3.23	2.97	0.67	2.125-16 UN	2.02	0.71	0.67	1.87	.375-16 UNC	0.65	0.39	0.26	0.62	0.47	3.1
CDT-27501	6.17	4.21	3.96	0.67	2.125-16 UN	2.02	0.71	0.67	1.87	.375-16 UNC	0.65	0.39	0.26	0.62	0.47	4.1
CDT-40131	3.60	3.09	2.78	0.70	2.500-16 UN	2.38	0.86	0.83	2.25	.500-13 UNC	0.80	0.39	0.31	0.67	0.59	4.0
CDT-40251	4.55	3.56	3.25	0.70	2.500-16 UN	2.38	0.86	0.83	2.25	.500-13 UNC	0.80	0.39	0.31	0.67	0.59	4.6
CDT-40381	5.57	4.07	3.76	0.70	2.500-16 UN	2.38	0.86	0.83	2.25	.500-13 UNC	0.80	0.39	0.31	0.67	0.59	5.6
CDT-40501	6.89	4.92	4.61	0.70	2.500-16 UN	2.38	0.86	0.83	2.25	.500-13 UNC	0.80	0.39	0.31	0.67	0.59	6.6

Shown: WRT-22, CYDA-15, WMT-39



▶ **Threaded cylinders for workpiece positioning, holding and ejecting applications where space is at a premium. The advance and retract mode of double-acting models allow installation of clamping accessories to the plunger for pull and push action. Cylinders can be mounted with horizontal bracket to position the workpiece against the stops. Ideal for supporting or positioning a part.**

Fine positioning and convenient installation

...can be fixtured into manual strap or bridge clamp assemblies

- Maximum clamping force in a compact design
- Threaded body allows exact positioning and easy installation
- Center-tapped plungers allow a variety of attachments
- Single-acting spring return models simplify hydraulic tubing requirements
- Double-acting models are ideal for applications requiring powered pulling or fast automated control
- Removable base allows CYDA-15 to be threaded into a custom manifold

i Single or Double acting

Single acting

- The obvious choice when there are few system restrictions, and there are not many units retracting simultaneously
- Fewer valving requirements which results in a less complex circuit

Double acting

- Used when greater control is required during the unclamp cycle
- When timing sequences are critical
- Less sensitive to system back pressures, resulting from long tube lengths or numerous components being retracted at the same time

globe Product selection

Cylinder capacity at maximum pressure	Stroke		Model number	Effective area		Oil capacity		Operating pressure
	lbs	in		in ²	in ³			
	push	pull		push	pull	push	pull	
▼ Single acting								
3900	–	.50	WRT-21	.79	–	.39	–	150-5000
3900	–	1.00	WRT-22	.79	–	.79	–	150-5000
▼ Double acting								
1200	600	1.56	CYDA-15	.41	.20	.62	.31	150-3000
3900	2700	.47	WMT-39	.79	.54	.39	.27	150-5000
3900	2700	.98	WMT-40	.79	.54	.79	.54	150-5000

Note: - Seal material CYDA-15: Buna-N, Polyurethane
 - Seal material WMT and WRT series: Buna-N, Polyurethane, Teflon.

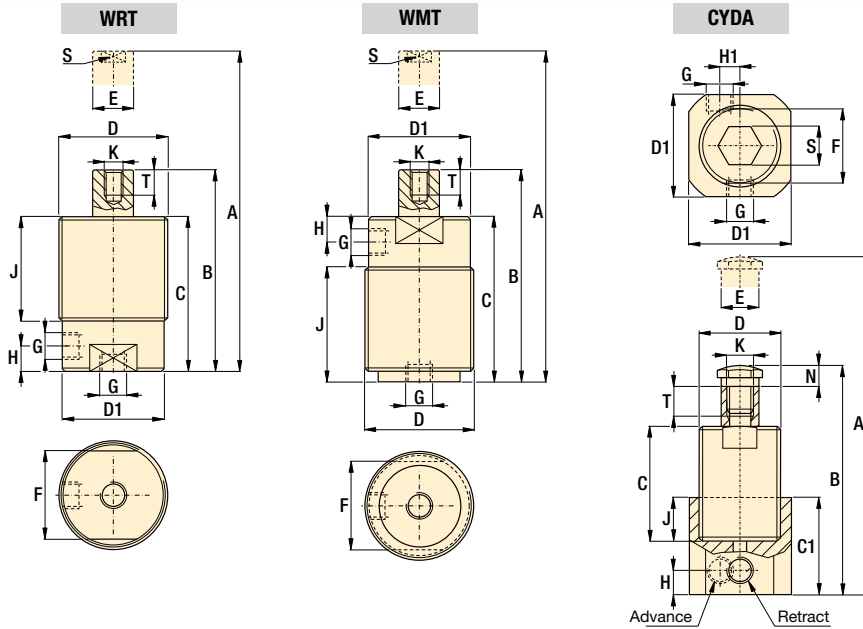

Force: 1200-3900 lbs
Stroke: .47-1.56 inch
Pressure: 150-5000 psi

- E** Cilindros roscados
- F** Vérins corps filetés
- D** Einschraubzylinder

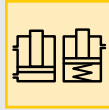

Manifold dimensions using CYDA-15 without base (Cylinder Capacity 1200 lbs)

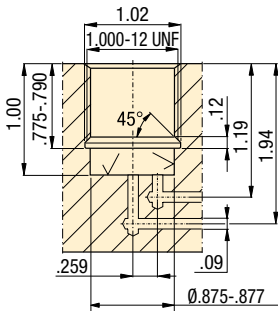

✓ Surface roughness must be 63 micro-inches

Accessory chart

Body Thread	Mounting Flange	Flange Nut	Plunger Thread	Contact Bolt
D	Sold separately [87 ▶]	Sold separately [86 ▶]	K	Sold separately [86 ▶]
1.000-12 UN	MF-251	FN-251	0.250-28 UN	BS-61
1.375-18 UN	MF-351	FN-351	0.313-24 UN	BS-81

Product dimensions in inches []

Model number	A	B	C	C1	D	D1	E	F	G	H	H1	J	K	N	S	T	lbs
					UN	ø	ø						UNF				
▼ Single acting																	
WRT-21	3.75	3.25	2.95	-	1.375-18 UNEF	1.23	.75	1.06	SAE #2	.62	-	2.0	.250-28	-	.50	.32	1.2
WRT-22	4.75	3.75	3.45	-	1.375-18 UNEF	1.23	.75	1.06	SAE #2	.62	-	2.5	.250-28	-	.50	.32	1.4
▼ Double acting																	
CYDA-15	5.98	4.42	3.15	1.75	1.000-12 UNF	1.25	.50	.87	.125-27 NPT	.38	.20	1.00	.313-24	.31	.50	.41	1.2
WMT-39	3.74	3.27	2.99	-	1.375-18 UNEF	1.30	.56	1.06	.125-27 NPT	.73	-	2.05	.250-28	-	.47	.39	1.0
WMT-40	4.76	3.78	3.50	-	1.375-18 UNEF	1.30	.56	1.06	.125-27 NPT	.73	-	2.56	.250-28	-	.47	.39	1.2

Options

Cylinder accessories

[86 ▶]



Important

Apply Loctite 222 or equivalent to threads and torque CYDA-15 in cavity to 72-96 in-lbs. Cavity must be designed to withstand hydraulic forces.

Manifold cylinders *Application & selection*

Shown: CSM-10131, CSM-571, CSM-18251



▶ These compact, fixture-integrated cylinders are designed for workpiece positioning, holding and ejecting applications where space is at a premium. No exposed tubing.

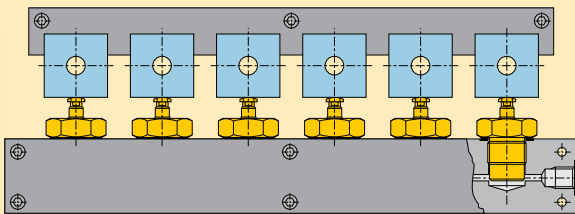

Six CSM series manifold cylinders are used to clamp piston blocks for machining. The hydraulic flow to the cylinders is side-ported in order to minimize the required manifold thickness.

■ Threaded cylinders are used here to position engine manifolds for drilling, tapping and mill finish.



Compact, fixture-integrated positioning and holding

- Design eliminates the need for fittings and tubing, minimizing space requirements and facilitating easy removal of chips and dirt
- Minimal cylinder height enables extremely compact fixture designs
- High-strength bodies and internal plunger wipers allow maintenance-free, high cycle performance
- Center-tapped plungers will hold workpiece contact buttons
- Standard SAE bodies make manifold cavity preparation easy

i Manifold mount

Manifold cylinders are designed to be screwed directly into a manifold or fixture. Enerpac's manifold cylinders feature SAE dimensions, enabling the use of standard SAE porting tools for easy cavity preparation. An SAE O-ring, included with each cylinder, provides an effective seal between the cylinder and manifold.

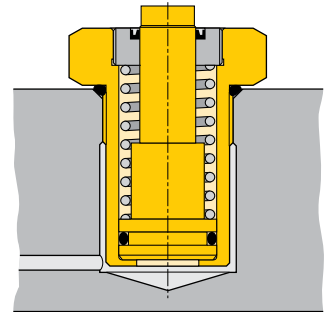

Product selection

Cylinder capacity at 5000 psi	Stroke	Model number	Effective area	Oil capacity
			in ²	in ³
380 lbs	0.28 in	CSM-271	0.08	0.02
380	0.51	CSM-2131	0.08	0.04
1190	0.28	CSM-571	0.24	0.07
1190	0.51	CSM-5131	0.24	0.12
2590	0.28	CSM-1071	0.50	0.14
2590	0.51	CSM-10131	0.50	0.26
2590	0.75	CSM-10191	0.50	0.38
3900	0.51	CSM-18131	0.79	0.40
3900	0.98	CSM-18251	0.79	0.77
6110	0.59	CSM-27151	1.22	0.72
6110	0.98	CSM-27251	1.22	1.20

Note: - Seal material: Buna-N, Polyurethane.

Installation dimensions in inches []

Model number	D Thread SAE	D2 min. ϕ	H max.	J1 min.	L min.
CSM-271	SAE#6 (9/16"-18 UN)	0.97	0.064	0.50	.96
CSM-2131	SAE#6 (9/16"-18 UN)	0.97	0.064	0.50	1.45
CSM-571	SAE#10 (7/8"-14 UN)	1.34	0.094	0.66	1.20
CSM-5131	SAE#10 (7/8"-14 UN)	1.34	0.094	0.66	1.53
CSM-1071	SAE#12 (1-1/16"-12 UN)	1.63	0.094	0.75	1.20
CSM-10131	SAE#12 (1-1/16"-12 UN)	1.63	0.094	0.75	1.44
CSM-10191	SAE#12 (1-1/16"-12 UN)	1.63	0.094	0.75	2.05
CSM-18131	SAE#16 (1-5/16"-12 UN)	1.91	0.125	0.75	1.57
CSM-18251	SAE#16 (1-5/16"-12 UN)	1.91	0.125	0.75	2.34
CSM-27151	SAE#20 (1-5/8"-12 UN)	2.27	0.125	0.80	1.66
CSM-27251	SAE#20 (1-5/8"-12 UN)	2.27	0.125	0.80	2.38

Installation dimensions

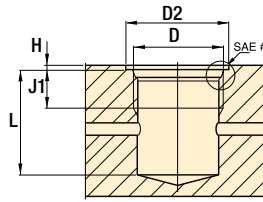

- Force: 380-6110 lbs**
- Stroke: .28-.98 inch**
- Pressure: 580-5000 psi**

- E Cilindros para colector**
- F Vérins pour bloc foré**
- D Einbauszylinder**



Note: - O-rings included. For additional cavity machining information, refer to SAE standards for straight internal thread, O-ring boss, or call Enerpac's Technical Service Department.

Accessory chart

Plunger Thread K	Contact Bolt \square 86 ▶
#6-32 UN	BS-21
#8-32 UN	BS-41
0.313-24 UN	BS-81
0.375-16 UN	BS-91

CSM-271, -2131

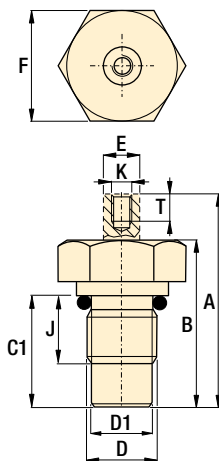

other models

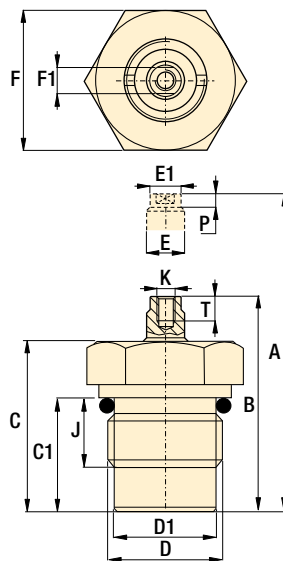

Product dimensions in inches []

Model number	A Ext. height	B Retr. height	C	C1	D thread	D1 ϕ	E ϕ	E1 ϕ	F	F1	J	K thread	P	T	lbs
CSM-271	1.61	1.33	-	0.91	.563-18 UN	0.47	0.19	-	0.75	-	0.48	#6-32 UN	-	0.19	0.2
CSM-2131	2.22	1.71	-	1.40	.563-18 UN	0.47	0.19	-	0.75	-	0.47	#6-32 UN	-	0.19	0.3
CSM-571	2.02	1.74	1.57	1.14	.875-14 UN	0.69	0.31	0.27	1.06	0.25	0.55	#8-32 UN	0.16	0.28	0.4
CSM-5131	2.58	2.07	1.91	1.48	.875-14 UN	0.69	0.31	0.27	1.06	0.25	0.55	#8-32 UN	0.16	0.28	0.6
CSM-1071	2.15	1.87	1.65	1.14	1.062-12 UN	0.94	0.47	0.43	1.25	0.35	0.59	.312-24 UN	0.22	0.32	1.1
CSM-10131	2.65	2.14	1.89	1.38	1.062-12 UN	0.94	0.47	0.43	1.25	0.35	0.59	.312-24 UN	0.22	0.31	1.3
CSM-10191	3.50	2.75	2.50	1.99	1.062-12 UN	0.94	0.47	0.43	1.25	0.35	0.63	.312-24 UN	0.22	0.31	1.4
CSM-18131	2.87	2.36	2.11	1.52	1.312-12 UN	1.17	0.63	0.59	1.61	0.50	0.79	.312-24 UN	0.26	0.47	1.1
CSM-18251	4.11	3.13	2.87	2.28	1.312-12 UN	1.18	0.63	0.59	1.61	0.50	0.79	.312-24 UN	0.26	0.47	1.3
CSM-27151	3.13	2.54	2.31	1.60	1.625-12 UN	1.52	0.71	0.67	2.17	0.57	0.79	.375-16 UN	0.26	0.47	1.50
CSM-27251	4.25	3.27	3.04	2.33	1.625-12 UN	1.52	0.71	0.67	2.17	0.57	0.79	.375-16 UN	0.26	0.47	2.00

Options

Accessories
Contact bolts \square 86 ▶

Important

Tighten manifold cylinders according to specifications in the instruction sheet.

Return springs in single-acting cylinders should not be used to pull back heavy attachments.

Block cylinders *Application & selection*

Shown: CDB-10162, CDB-70502, CSB-18252



▶ Block cylinders are used for punching, pressing, riveting and bending applications. In general, these cylinders are used for moving, positioning, lifting, opening and closing.

Versatile, all purpose cylinder

- Six clamping capacities enable you to choose the right size for your application
- Variety of strokes, to meet design needs
- Double acting and Single acting (spring return), allows selection of cylinder that best conforms to your hydraulic system
- Oil connection alternatives: cylinders incorporate both manifold mount and plumbed options to meet your fixturing needs
- Compact cylinder design does not require large amounts of space on your fixture
- Integral wiper ring, keeps contaminants out of cylinder to extend life

i Select your block cylinder type:

CSB series, Single acting

- Internal threaded plunger
- Manifold O-ring ports
- Black oxide base
- Hard chrome-plated plunger
- BSPP oil port
- Strong return spring
- Filtered vent plug

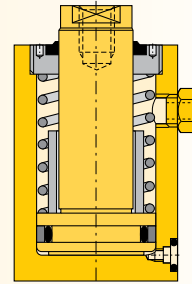

CDB series, Double acting

- Internal threaded plunger
- Manifold O-ring ports
- Black oxide base
- Hard chrome-plated plunger
- BSPP oil port

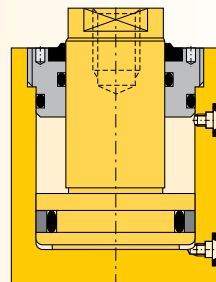

■ The versatile Enerpac block cylinders, fixture mounted for clamping applications.

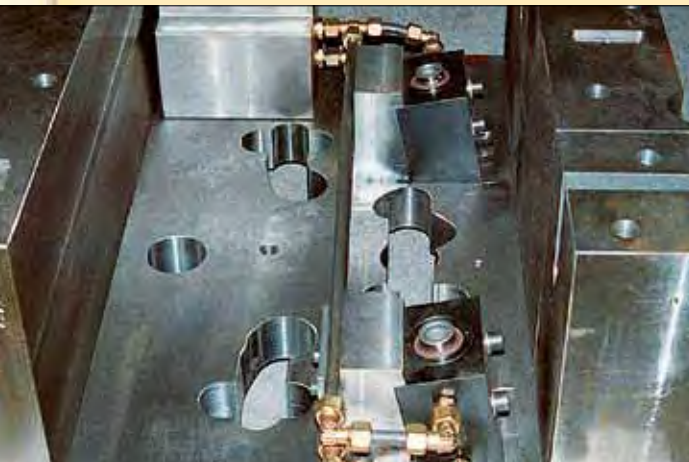

i Application example

Block cylinder positions workpiece against fixed point with further clamping coming from an Enerpac swing cylinder.

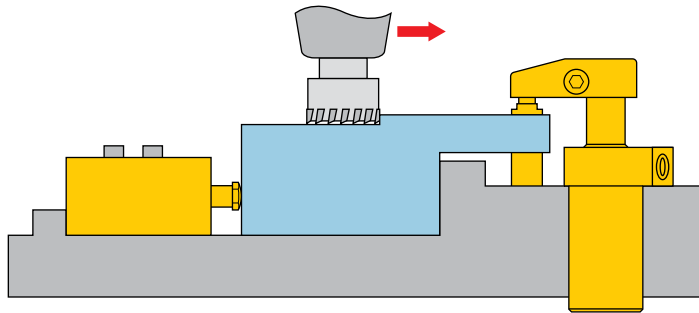

Force: 2400-60,850 lbs
Stroke: .59-2.20 inch
Pressure: 580-5000 psi

- E** Cilindros tipo bloque
- F** Vérins cube
- D** Blockzylinder



g Accessory chart

Plunger Thread K	Contact Bolt □86 ▶
M6 X 1,0	BS-62
M8 X 1,25	BS-82
M16 X 2,0	BS-16
M20 X 2,5	BS-20
M30 X 3,5	BS-30
M36 X 4,0	BS-36

g Product selection

Piston Ø	Rod Ø	Clamping force at 5000 psi		Stroke	Model number	Cylinder effective area		Cylinder oil capacity		Minimum spring return force	
		push	pull			push	pull	push	pull	lbs	lbs
in	in	lbs		in		in ²		in ³		lbs	
						push	pull	push	pull	lbs	lbs
▼ Single acting											
.78	.47	2400	-	.71	CSB-10182	.48	-	.35	-	24	2.6
.98	.63	3800	-	.98	CSB-18252	.76	-	.75	-	35	4.0
1.57	.98	9750	-	.98	CSB-40252	1.95	-	1.92	-	85	5.9
1.97	1.26	15,200	-	.98	CSB-70252	3.04	-	3.00	-	96	9.7
▼ Double acting											
.78	.47	2400	1550	.59	CDB-10162	.48	.31	.31	.20	-	2.0
.78	.47	2400	1550	1.38	CDB-10362	.48	.31	.69	.44	-	2.6
.98	.63	3800	2250	.79	CDB-18202	.76	.45	.60	.35	-	2.9
.98	.63	3800	2250	1.97	CDB-18502	.76	.45	1.50	.90	-	4.0
1.57	.97	9750	4900	.98	CDB-40252	1.95	.98	1.92	.96	-	4.2
1.57	.97	9750	4900	1.97	CDB-40502	1.95	.98	3.83	1.93	-	5.7
1.97	1.26	15,200	9000	.98	CDB-70252	3.04	1.80	3.00	1.77	-	7.1
1.97	1.26	15,200	9000	1.97	CDB-70502	3.04	1.80	5.99	3.54	-	9.5
3.15	1.97	38,900	23,700	.98	CDB-180252	7.80	4.74	7.66	4.67	-	20.5
3.15	1.97	38,900	23,700	1.97	CDB-180502*	7.80	4.74	15.33	9.34	-	25.4
3.93	2.48	60,850	36,650	2.20	CDB-280562*	12.17	7.33	26.83	16.18	-	40.1

* This product is made to order. Please contact Enerpac for delivery information before specifying in your design.

Block cylinders *Application & selection*

Shown: CDB-10162, -70502, CSB-18252



CDB, CSB series

These compact block cylinders are easily mounted in horizontal or vertical position for a range of special tooling applications.

They can be used for positioning, clamping, pushing, pressing or punching operations. The plunger has an internal thread to accommodate accessories such as contact bolts.

Block cylinder used for punching applications.



CDB-10162, -18202, -40252, -70252, -180252

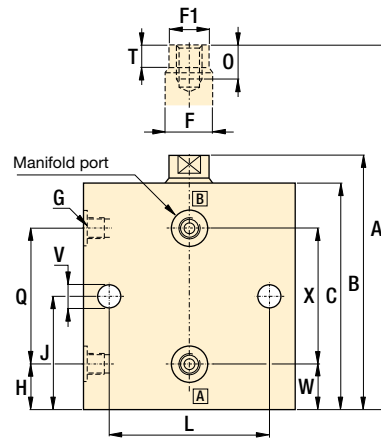
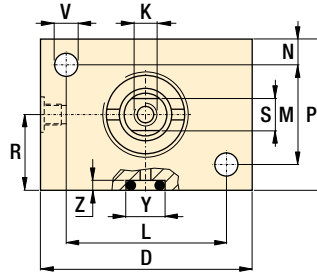

All other models

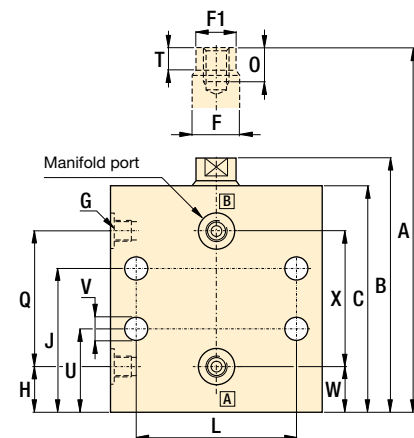
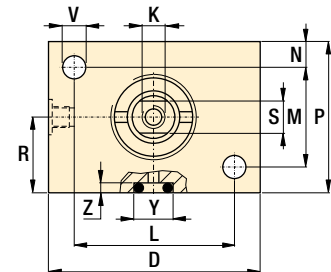

Dimensions in inches []

Model number	A	B	C	D	F	F1	G	H	J	K	L	M
					ø	ø				ø		
▼ Single acting												
CSB-10182	3.94	3.23	2.91	2.36	.47	.43	G1/8"	.47	1.75	M6 x 1,0	1.77	.98
CSB-18252	4.92	3.94	3.62	2.56	.63	.59	G1/8"	.47	2.24	M8 x 1,25	1.97	1.18
CSB-40252	5.13	4.15	3.66	3.15	.98	.94	G1/8"	.39	2.26	M16 x 2,0	2.36	1.38
CSB-70252	5.63	4.65	4.09	3.94	1.26	1.22	G1/4"	.54	2.52	M20 x 2,5	3.15	1.77
▼ Double acting												
CDB-10162	3.03	2.44	2.15	2.36	.47	.43	G1/8"	.47	.96	M6 x 1,0	1.77	.98
CDB-10362	4.61	3.23	2.93	2.36	.47	.43	G1/8"	.47	1.75	M6 x 1,0	1.77	.98
CDB-18202	3.54	2.76	2.44	2.56	.63	.59	G1/8"	.47	1.06	M8 x 1,25	1.97	1.18
CDB-18502	5.91	3.94	3.62	2.56	.63	.59	G1/8"	.47	2.24	M8 x 1,25	1.97	1.18
CDB-40252	4.13	3.15	2.68	3.15	.97	.94	G1/8"	.37	1.26	M16 x 2,0	2.36	1.38
CDB-40502	6.11	4.15	3.67	3.15	.97	.94	G1/8"	.39	2.26	M16 x 2,0	2.36	1.38
CDB-70252	4.53	3.54	2.99	3.94	1.26	1.22	G1/4"	.53	1.42	M20 x 2,5	3.15	1.77
CDB-70502	6.61	4.65	4.09	3.94	1.26	1.22	G1/4"	.54	2.52	M20 x 2,5	3.15	1.77
CDB-180252	5.16	4.17	3.50	5.51	1.97	1.93	G1/4"	.59	1.63	M30 x 3,5	4.33	3.15
CDB-180502*	7.28	5.31	4.65	5.51	1.97	1.93	G1/4"	.47	2.78	M30 x 3,5	4.33	3.15
CDB-280562*	8.19	5.98	5.22	6.69	2.48	2.44	G1/4"	.70	3.05	M36 x 4,0	5.31	3.54

* This product is made to order. Please contact Enerpac for delivery information before specifying in your design.

i Installation instructions

When operating above 2000 psi in applications as shown in the figure below, provide cylinder back-up using a support to eliminate shear loads on the mounting bolts.

Manifold mounting

When hydraulic connections are made through the standard integrated O-ring ports as shown in figure, the sealing surface must have a roughness of 63 micro-inches.

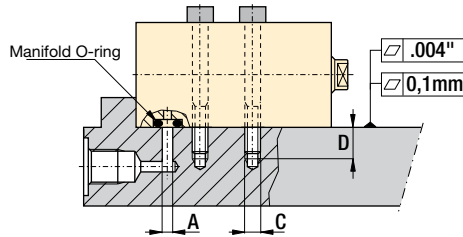

Single-acting cylinders

If the risk of machining coolants or debris being entering via the breather vent (port B) exists, it is recommended that this port be connected to a clean, remote termination point.

A Installation dimensions in inches []

Clamping capacity	Oil channel diameter	Mounting thread	Min. thread length	Torque (bolt type 12.9 DIN 912)	Manifold O-ring ¹⁾	
					Inside Ø x thickness	ARP No.
lbs	A	mm C	D	Ft.lbs		
2400	.20	M6	.43	13	.31 x .06	568-011
3800	.20	M8	.51	30	.31 x .06	568-011
9750	.20	M10	.63	63	.31 x .06	568-011
15,200	.20	M12	.75	107	.31 x .06	568-011
38,900	.31	M16	.94	260	.38 x .09	568-110
60,850	.31	M20	1.10	498	.38 x .09	568-110

¹⁾ Manifold O-rings included

N	O	P	Q	R	S	T	U	V	W	X	Y	Z	Model number
min.													
													Single acting ▼
.30	.39	1.57	1.77	.79	.35	.22	.96	.27	.47	1.77	.44	.05	CSB-10182
.30	.49	1.77	2.36	.89	.51	.24	1.06	.35	.47	2.36	.44	.05	CSB-18252
.39	.98	2.17	2.46	1.08	.87	.37	1.07	.42	.39	2.46	.44	.05	CSB-40252
.41	1.18	2.60	2.63	1.30	1.06	.43	1.15	.49	.60	2.57	.44	.05	CSB-70252
													Double acting ▼
.30	.39	1.57	.98	.79	.35	.22	-	.27	.47	.98	.44	.05	CDB-10162
.30	.39	1.57	1.77	.79	.35	.22	.96	.27	.47	1.77	.44	.05	CDB-10362
.30	.49	1.77	1.18	.89	.51	.24	-	.35	.47	1.18	.44	.05	CDB-18202
.30	.49	1.77	2.36	.89	.51	.24	1.06	.35	.47	2.36	.44	.05	CDB-18502
.39	.98	2.17	1.48	1.08	.87	.37	-	.42	.37	1.48	.44	.05	CDB-40252
.39	.98	2.17	2.46	1.08	.87	.37	1.07	.42	.39	2.46	.44	.05	CDB-40502
.41	1.18	2.60	1.54	1.30	1.06	.43	-	.49	.49	1.57	.44	.05	CDB-70252
.41	1.18	2.60	2.63	1.30	1.06	.43	1.15	.49	.60	2.57	.44	.05	CDB-70502
.59	1.77	4.33	1.79	2.17	1.61	.57	-	.67	.61	1.77	.56	.07	CDB-180252
.59	1.77	4.33	3.05	2.17	1.61	.57	1.20	.67	.77	2.76	.56	.07	CDB-180502*
.69	1.97	4.92	3.16	2.46	1.97	.67	1.48	.83	.71	3.15	.56	.07	CDB-280562*

* This product is made to order. Please contact Enerpac for delivery information before specifying in your design.

Force: 2400-60,850 lbs

Stroke: .59-2.20 inch

Pressure: 580-5000 psi

- E** Cilindros tipo bloque
- F** Vérins cube
- D** Blockzylinder



! Important

Linear cylinder support is required at operating pressures above 2000 psi. Follow the instructions on this page.

i Options

Contact bolts 86 ▶

Fittings 194 ▶

Pressure gauges 190 ▶

High pressure filters 193 ▶

Pull down clamps *Application & selection*

Shown: ECM-20, ECH-202, ECM-5, ECH-52



Enerpac pull down clamps are designed to allow unobstructed top face machining. Independent horizontal and vertical movement achieves high lateral and pull down forces to hold the workpiece firmly down against the machine table or fixture. The pull down forces are approximately 33% of the clamping force.

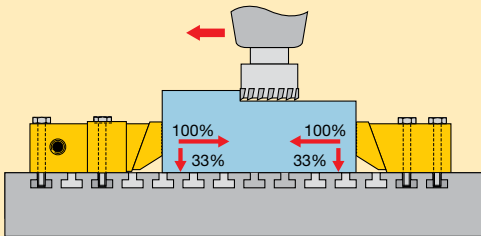

The pull down clamps can be permanently mounted using the supplied mounting bolts. Optional T-nuts can be used for adapting to varying workpiece sizes.

■ Enerpac hydraulic pull down clamps and their mechanical counter parts used to manufacture tie-rod cylinder end caps.



Low profile clamp

.....for unobstructed top face machining

- Independent horizontal and vertical movement for a true pull down effect
- Compact size and low height allows more flexible and economic mounting than comparable dedicated vise
- Manifold and BSPP porting
- Investment high-alloy cast, heat-treated clamping jaw and plunger
- Contamination resistant design for low maintenance, removable guard for chip removal
- Oil ports on both sides for mounting flexibility
- Optional mechanical counter hold provides pull down on end stop for large parts
- Mounting bolts included for ease of installation

i Pull down clamp operation

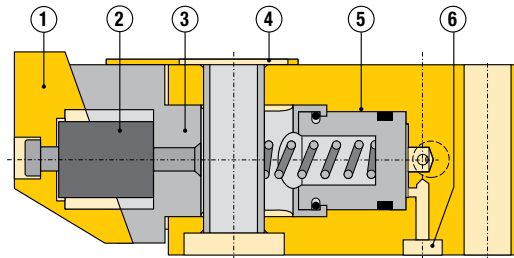

The moveable jaw ① and the flexible connection design ② allows lateral movement and eliminate any bending moment. Roller finished cylinder bore ③ improves seal life. The removable guard ④ prevents the entry of chips and allows easy cleaning. Heat treated, centerless ground plunger ⑤ for extremely close tolerances and long life. The clamps feature both manifold mount ⑥ and plumbed oil connection.

globe Product selection

Lateral clamping force at 5000 psi	Pull down force at 5000 psi	Stroke	Model number	Effective area	Oil capacity	Mounting bolts ¹⁾ (included)
lbs	lbs	in		in ²	in ³	mm
870	290	.20	ECH-52	.18	.03	M8 x 45
3900	1300	.31	ECH-202	.78	.24	M12 x 80

Holding force	For pull down clamp model number	Model number	Mounting bolts included ¹⁾ number	Replaceable ribbed jaws model
lbs			mm	
870	ECH-52	ECM-5	M8 x 35	ECJR-5
3900	ECH-202	ECM-20	M12 x 65	ECJR-20

¹⁾ Torque M8 with 18 Ft.lbs, M12 with 63 Ft.lbs. The use of T-nuts requires longer bolts.

Collet-Lok® product line
Swing clamps
Work supports
Linear clamps

i Pull down force

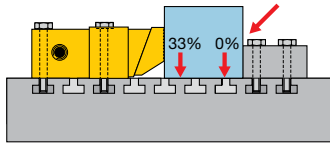

Fixed stop set-up

A very workable set-up for workpieces that are not larger or wider than twice the width of the edge clamp. The pull down force of the hydraulic actuated edge clamp is sufficient to pull down and hold the product during actual machining.

The mounting surface must extend out under the jaw.

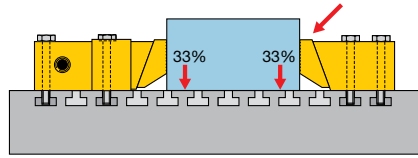
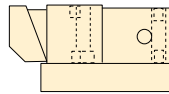

Counter hold set-up

For workpieces larger than twice the width of the edge clamp used, it is recommended to install a mechanical counter hold. The counter hold also produces a pull down force equal to 1/3 of the lateral force of the hydraulic edge clamp applied. In this way the grip on the workpiece is very tight. Another advantage of this set-up is the repeated accuracy of machining results.

ECH-52, -202

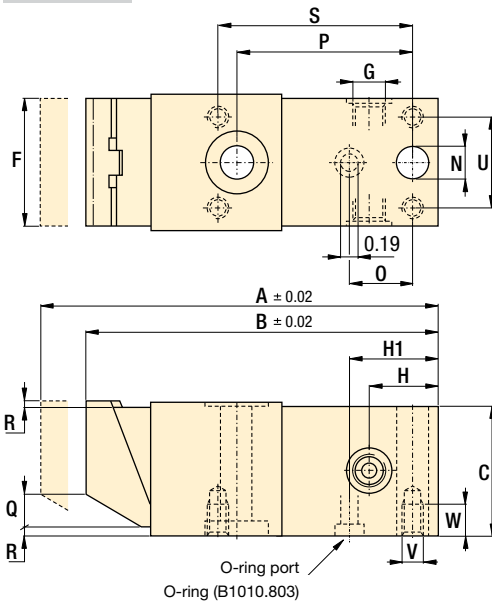

ECM-5, -20

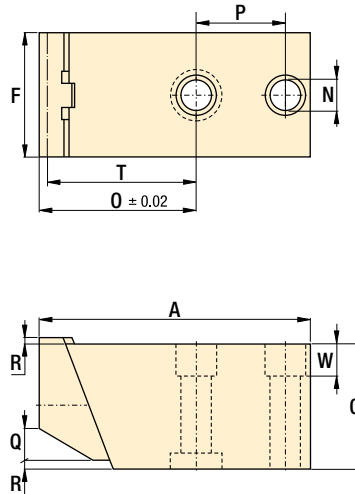

A Product dimensions in inches [\varnothing]

Model number	A	B	C	F	G	H	H1	N	O	P	Q	R	S	T	U	V	W	lbs
	mm																	
▼ Hydraulic pull down clamps																		
ECH-52	4.14	3.94	1.18	1.18	G1/8"	.75	.74	.33	.46	2.09	.12	.08	2.32	-	.87	M5 x 0,8	.24	1.5
ECH-202	5.62	5.31	1.97	1.97	G1/4"	.98	.93	.49	.54	2.64	.55	.12	2.91	-	1.42	M8 x 1,25	.47	5.5
▼ Mechanical counter holds																		
ECM-5	3.11	-	1.18	1.18	-	-	-	.33	1.65	1.02	.12	.08	-	1.61	-	-	.31	1.3
ECM-20	4.02	-	1.97	1.97	-	-	-	.49	2.36	1.18	.55	.12	-	2.32	-	-	.51	4.1

- Force: 870-3900 lbs
- Stroke: .20-.31 inch
- Pressure: 225-5000 psi
- E** Garras de empuje oblicuo
- F** Crampons plaqueurs
- D** Niederzugspanner

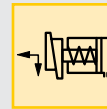

i Options

- Fittings** 194 ▶
- Threaded cylinders** 66 ▶
- Positive clamping cylinders** 80 ▶

! Important

Do not allow the clamping jaw to extend below the lower surface of the clamp body.

Hollow plunger cylinders *Application & selection*

Shown: HCS-20, RWH-121, RWH-202



▶ These cylinders are regularly used for upgrading mechanical clamping to faster and easier hydraulic clamping. Other typical applications include production pressing, punching and crimping operations.

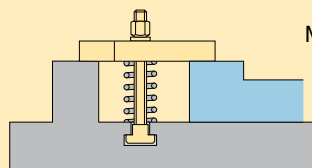

Mechanical set-up

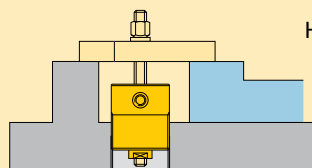

Hydraulic set-up

Traditional mechanical elements in a clamping fixture are replaced by a hollow plunger hydraulic cylinder.

■ Two Enerpac RWH-121 hollow cylinders mounted at the back side of a fixture.

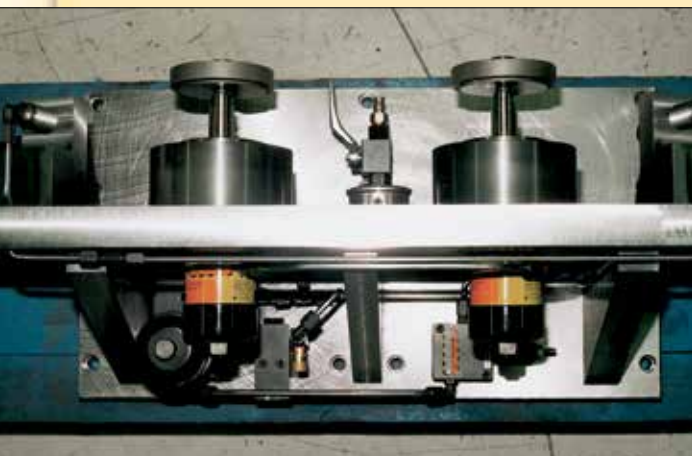

For high force push and pull applications on and around the fixture

- Load can be attached to either end of the cylinder, providing a choice of push or pull actions - both realizing full cylinder capacity
- Very high cylinder capacities contained within small dimensions allow compact fixture designs
- Spring return operation allows for easy unloading of the workpiece
- Threaded collars and base mounting holes allow mounting flexibility, including table-top surfaces and T-slots
- Nickel-plated plungers, plunger wipers and internal venting prevent corrosion and support longer operation life on all HCS models
- The CY series hollow plunger cylinders can be manifold mounted (except for CY-1254-25)

Product selection

Cylinder capacity ¹⁾	Stroke	Center hole diameter	Model number	Effective area	Oil capacity	Operating pressure
				in ²	in ³	psi
2610	0.25	0.39	CY1254-25	0.87	0.22	3000
4000	0.33	0.53	MRH-20	1.33	0.41	3000
4000	0.33	0.53	RWH-20	1.33	0.41	3000
4000	0.33	0.53	RWH-20T	1.33	0.41	3000
4830	0.40	0.42	HCS-20*	0.96	0.38	5000
7410	0.31	0.77	CY2129-25¹⁾	2.47	0.77	3000
7410	0.63	0.77	CY2129-5¹⁾	2.47	1.56	3000
12,660	0.48	0.51	HCS-50*	2.52	1.19	5000
13,320	0.63	0.89	CY2754-5	4.44	2.80	3000
13,800	0.32	0.77	MRH-120	2.76	0.86	5000
13,800	0.32	0.77	QDH-120	2.76	0.86	5000
13,800	0.32	0.77	RWH-120	2.76	0.86	5000
13,800	1.02	0.77	RWH-121	2.76	2.76	5000
18,180	0.56	0.67	HCS-80*	3.63	1.99	5000
23,500	0.52	1.06	RWH-200	4.74	2.37	5000
23,500	2.02	1.06	RWH-202	4.74	9.48	5000
25,490	0.63	0.83	HCS-110*	5.06	3.19	5000
36,000	0.50	1.31	RWH-300	7.22	3.60	5000
36,000	1.00	1.31	RWH-301	7.22	7.22	5000
36,000	2.49	1.31	RWH-302	7.22	18.00	5000

¹⁾ At maximum operating pressure. **Note:** Seal material Buna-N, Polyurethane, Teflon.

* This product is made to order. Please contact Enerpac for delivery information before specifying in your design.

i Optional Heat Treated Hollow Saddles

Saddle type	Cylinder model number	Saddle model No.	Saddle Dimensions (in)		
			A	B	C
Threaded hollow	RWH-200, 202	HP-2015	2.11	1 - 8	.38
	RWH-300, 301, 302	HP-3015	2.49	1¼ - 7	.38

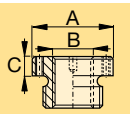

Smooth hollow saddles are standard on all RWH 20 and 30 ton models (12 ton models are not equipped with saddles).

MRH-20, 120

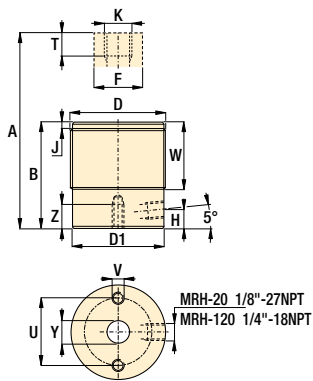

RWH-20, 120, 121, QDH-20

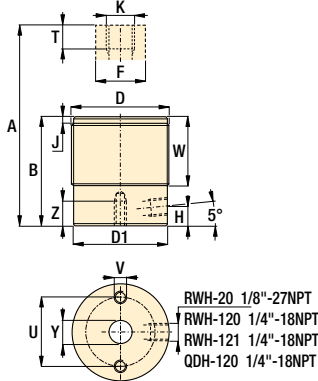

other RWH model

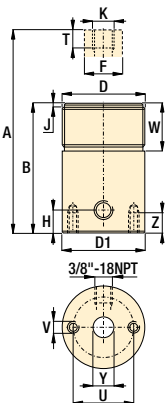

CY models

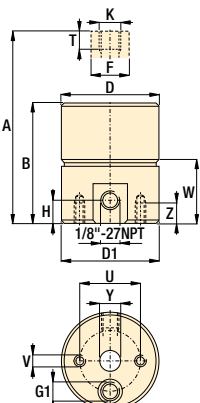

HCS models

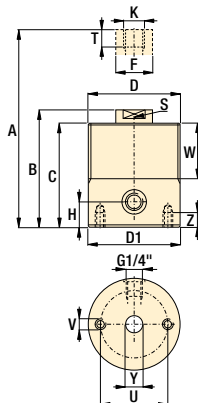

A Product dimensions in inches []

Model number	A	B	C	D	D1	F	H	J	K	S	T	U	V	W	Y	Z	lbs
CY1254-25	2.25	2.00	-	Ø 1.75	1.75	0.56	0.29	-	.375-16 UNC	-	0.62	1.25	.250-20 UNC	0.97	Ø 0.39	0.38	1.0
MRH-20	2.39	2.06	-	M48 X 1.5	1.77	1.00	0.28	0.12	Ø .53	-	0.88	1.38	M6 X 1.0	1.50	Ø 0.50	0.25	1.3
RWH-20	2.39	2.06	-	1.875-16 UN	1.79	1.00	0.28	0.12	Ø .53	-	0.87	1.38	.250-20 UNC	1.50	.500-20 UNF	0.25	1.4
RWH-20T	2.39	2.06	-	1.875-16 UN	1.79	1.00	0.28	0.12	.500-20 UNF	-	0.49	1.38	.250-20 UNC	1.50	Ø 0.53	0.25	1.4
HCS-20	3.43	2.93	2.60	M58 X 1.5	2.28	0.71	0.43	-	M10 X 1.5	0.55	1.01	1.57	M6 X 1.0	1.57	Ø 0.42	0.39	2.4
CY2129-25¹⁾	2.31	2.00	-	Ø 2.63	2.50	1.13	0.31	-	.750-10 UNC	-	1.13	1.75	.375-16 UNC	0.80	Ø 0.77	0.34	2.5
CY2129-5¹⁾	3.36	2.73	-	Ø 2.63	2.50	1.13	0.31	-	.750-10 UNC	-	1.13	1.75	.375-16 UNC	1.54	Ø 0.77	0.44	3.0
HCS-50	3.80	3.32	2.95	M65 X 1.5	2.56	1.10	0.55	-	M12 X 1.75	0.87	0.95	1.77	M8 X 1.25	1.77	Ø 0.51	0.47	3.3
CY2754-5	3.63	3.00	-	Ø 3.5	3.13	1.25	0.44	-	.875-9 UNC	-	1.25	2.12	.375-16 UNC	1.61	Ø 0.89	0.44	6.0
MRH-120	2.54	2.20	-	M70 X 1.5	2.76	1.38	0.39	0.19	M18 X 1.5	-	0.60	2.00	M6 X 1.0	0.68	Ø 0.77	0.25	3.1
QDH-120	2.54	2.22	-	2.750-16 UN	2.75	1.38	0.39	0.19	.750-10 UNC	-	0.62	2.00	.312-18 UNC	0.68	Ø 0.77	0.25	3.0
RWH-120	2.54	2.22	-	2.750-16 UN	2.75	1.38	0.39	0.19	.750-16 UNF	-	0.61	2.00	.312-18 UNC	0.68	Ø 0.77	0.25	3.1
RWH-121	4.24	3.22	-	2.750-16 UN	2.75	1.38	0.53	0.19	.750-16 UNF	-	0.73	2.00	.312-18 UNC	0.68	Ø 0.77	0.25	4.8
HCS-80	4.31	3.75	3.35	M75 X 1.5	2.95	1.26	0.67	-	M16 X 2.0	0.94	1.27	2.17	M8 X 1.25	1.97	Ø 0.67	0.47	5.1
RWH-200	5.39	4.88	-	3.875-12 UN	3.88	2.12	0.75	0.19	Ø 1.06	-	0.88	3.25	.375-16 UNC	1.50	Ø 1.06	0.38	13.6
RWH-202	8.39	6.37	-	3.875-12 UN	3.88	2.12	0.75	0.19	Ø 1.06	-	0.88	3.25	.375-16 UNC	1.50	Ø 1.06	0.38	17.0
HCS-110	4.74	4.11	3.66	M90 X 2.0	3.54	1.57	0.75	-	M20 X 2.5	1.26	1.44	2.56	M10 X 1.5	2.36	Ø 0.83	0.59	7.9
RWH-300	5.52	5.02	-	4.500-12 UN	4.49	2.54	0.85	0.19	Ø 1.31	-	0.88	3.62	.375-16 UNC	1.66	Ø 1.31	0.62	19.0
RWH-301	6.52	5.52	-	4.500-12 UN	4.49	2.54	0.85	0.19	Ø 1.31	-	0.88	3.62	.375-16 UNC	1.66	Ø 1.31	0.62	21.5
RWH-302	9.52	7.03	-	4.500-12 UN	4.49	2.54	0.85	0.19	Ø 1.31	-	0.88	3.62	.375-16 UNC	1.66	Ø 1.31	0.62	24.0

¹⁾ For these models G1 = manifold and .125-27 NPTF

Force: 2610-36,000 lbs

Stroke: .25-2.49 inch

Pressure: 800-5000 psi

- E** Cilindros de émbolo hueco
- F** Vérins a piston creux
- D** Hohlkolbenzylinder

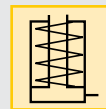

i Options

Flange nuts

86 ▶



! Important

Use Grade 8 (DIN12.9) bolt quality or better for pulling. Use Grade B7 (DIN10.9) threaded rod quality or better for pulling applications.

RWH cylinders can be used up to 10,000 psi maximum working pressure (except RWH-20 and RWH120).

Positive clamping cylinder *Application & selection*

Shown: MRS-1, MRS-1001, MRS-5001



▶ These cylinders are designed for prolonged clamping applications in moveable machine parts, tools, fixtures, pallets and workpieces.

The mechanical clamping force of this cylinder is ideal for FMS applications. Hydraulic pressure is used to release the workpiece and is not required to maintain the clamping force on the workpiece. Internal high strength springs produce the required clamping force.

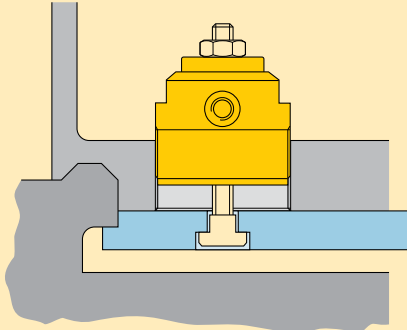

■ When pressure is released, the Enerpac MRS cylinders clamp the workpiece by pushing it against the frame that is attached to the fixture.

Ideal for palletized applications

- Heavy disk springs maintain the clamping force - hydraulic pressure is used for release
- Single-acting design allows easy setup of hydraulic system
- Hollow plunger design allows easy retrofit for mechanical clamping
- Custom buttons can be fitted into the plunger for clamping directly against a workpiece
- Threaded body allows easy cylinders mounting directly into fixture plate
- Internal threaded plunger allows accessories to be used easily for retrofit applications

i Positive clamping operation

The applied clamping force is determined by how far the cylinder's plunger is being retracted when engaging contact with the workpiece (referred to as the effective clamping stroke).

Use the diagrams on the next page as a guide to your fixture set-up. Note that in order to load and unload the workpiece, the plunger must be retracted somewhat further than the effective clamping stroke.

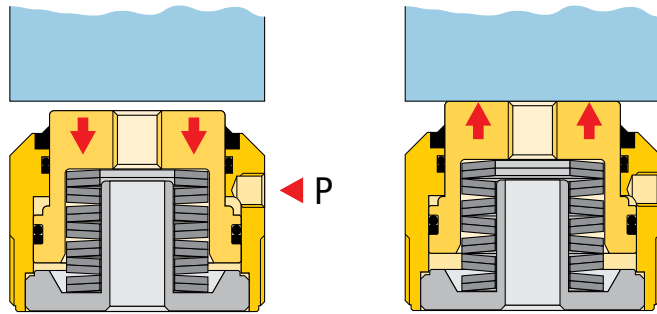

Hydraulic pressure applied

- Plunger retracts
- Work piece is released
- New work piece is loaded

Hydraulic pressure released

- Springs apply force
- Workpiece is clamped
- Machining can take place

Product selection

Cylinder capacity at 5000 psi	Effective clamping stroke	Model number	Required operating pressure ¹⁾	Max. tensioning stroke	Oil capacity
lbs	in		psi	in	in ³
2700	.09	MRS-1	5000	.09	.05
6000	.09	MRS-2	5000	.09	.26
11,500	.09	MRS-5	5000	.09	.50
1900	.10	MRS-1001	2000	.20	.54
3700	.10	MRS-2001	2700	.20	.73
5800	.10	MRS-3001	2600	.20	1.22
8500	.12	MRS-5001	3400	.22	1.35

¹⁾ Minimum operating pressure to fully retract the plunger.
Note: Seal material Buna-N, Polyurethane.

Collet-Lok® product line
Swing clamps
Work supports
Linear clamps

Stroke/force diagrams for MRS-1001, -2001, -3001, -5001

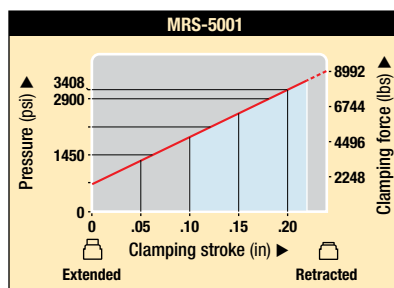
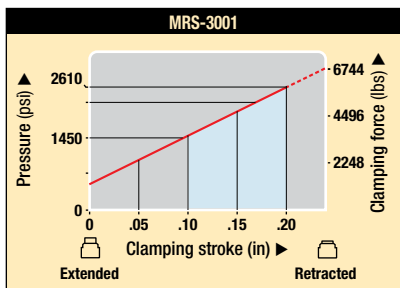
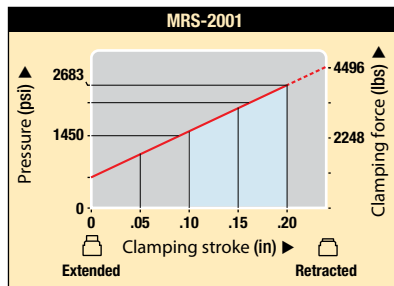
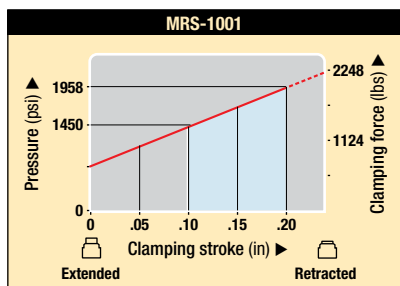

■ = Suggested Clamping Range

MRS-1, 2, 5

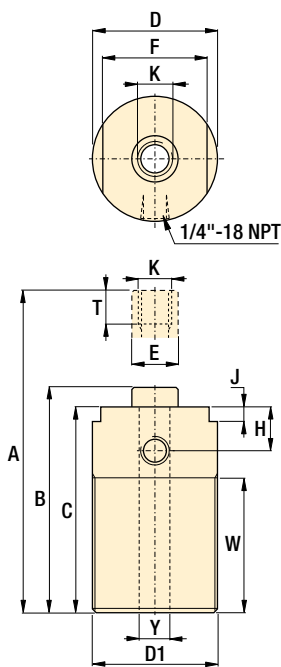

other MRS models

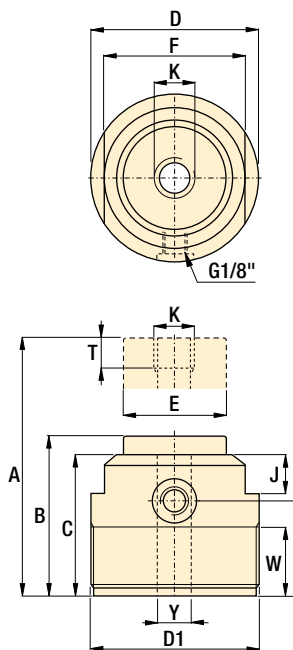

Product dimensions in inches []

Model number	A	B	C	D	D1	E	F	H	J	K	T	W	Y	lbs
MRS-1	3.35	3.26	3.11	1.42	M36 x 1,5	.50	1.18	.71	.24	M8 x 1,25	1.42	1.97	.35	1.1
MRS-2	3.54	3.46	3.31	1.89	M48 x 1,5	.68	1.57	.79	.28	M10 x 1,50	1.50	1.97	.43	2.0
MRS-5	4.92	4.83	4.69	2.36	M60 x 2,0	.87	1.97	.83	.28	M16 x 2,0	1.57	3.35	.67	4.0
MRS-1001	2.44	2.24	2.09	2.56	M65 x 1,5	1.57	2.17	1.38	.59	M12 x 1,75	.79	.98	.51	2.6
MRS-2001	2.56	2.36	2.24	3.15	M80 x 2,0	2.16	2.56	1.50	.59	M16 x 2,0	.79	1.14	.67	4.6
MRS-3001	2.91	2.72	2.60	3.74	M95 x 2,0	2.36	3.15	1.81	.67	M20 x 2,5	.79	1.46	.83	6.6
MRS-5001	3.78	3.56	2.66	3.74	M95 x 2,0	2.36	3.15	1.81	.67	M20 x 2,5	.79	1.46	.83	7.7

- Force: 1900-11,500 lbs
- Stroke: .09-.22 inch
- Pressure: 2000-5000 psi

- E** Cilindros de amarre
- F** Vérins de bridage positif
- D** Federspannzylinder



Options

Contact bolts 86 ▶

Flange nuts 86 ▶

Collet-Lok® work supports 16 ▶

Important

Be sure to refer to the force/stroke chart when selecting cylinders for an application. Piece parts with a large variation at the clamping point may be prone to having variations in clamping force.

Depending on the cycle usage of the application and amount of deflection, the internal disk springs may need to be replaced at scheduled intervals.

Universal cylinders - Single acting *Application & selection*

Shown: RW-50, RW-104



Used when high cylinder forces or long strokes are required in a confined area. Can handle a wide range of production tooling applications.

Block and cylindrical models

Cylindrical models

- Long stroke
- Flexible in fixture design
- Variety of attachments

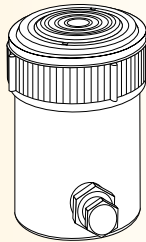

Block models

- Easily mounted
- Compact design

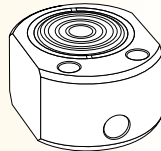

■ Enerpac RW-101 cylinders used in a high pressure toggle style clamping set-up.



Heavy-duty cylinders

...handle a variety of applications

- High pressure design when additional force is required
- Long stroke lengths in a compact design, well suited for welding applications
- Collar mounting threads and base mounting holes allow flexible mounting options
- Cylinders are provided with hardened saddles for additional plunger protection
- Snap-in saddles are easily removed for adapting to different plunger devices
- Chrome plated plunger with bronze upper and lower bearing provides a long cylinder life

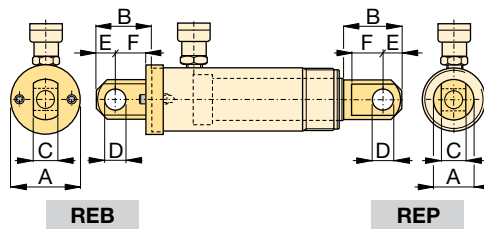

Type	Model number	Clevis eye dimensions (in)						Pin to pin* in
		A	B	C	D	E	F	
Base ¹⁾	REB-5	1.75	1.88	.56	.63	.63	1.00	2.37
	REB-10	2.50	2.63	1.00	.88	1.00	1.38	3.07
Plunger	REP-5	1.13	1.62	.56	.63	.63	.75	—
	REP-10	1.69	2.43	1.00	.88	1.00	1.13	—

* Pin to Pin- REB and REP Clevises fitted. Add cylinder stroke length.
¹⁾ Mounting screws are included.

Product selection

Cylinder capacity at 5000 psi	Stroke	Model number	Effective area	Oil capacity	Operating pressure
▼ Block models					
4970	0.62	RW-41	0.99	0.62	85-8000
4970	0.62	RW-50	0.99	0.62	600-10,000
4970	0.59	MRW-50F	0.99	0.62	85-10,000
4970	0.59	MRW-50M	0.99	0.62	85-10,000
▼ Cylindrical models					
4970	1.01	RW-51	0.99	0.99	600-10,000
4970	3.17	RW-53	0.99	2.97	600-10,000
4970	5.17	RW-55	0.99	4.95	600-10,000
11,180	0.99	RW-101	2.23	2.23	600-10,000
11,180	2.18	RW-102	2.23	4.75	600-10,000
11,180	4.18	RW-104	2.23	9.21	600-10,000
11,180	6.11	RW-106	2.23	13.67	600-10,000
11,180	10.13	RW-1010	2.23	22.59	600-10,000

Note: Seal material Buna-N, Polyurethan.

Collet-Lok® product line
Swing clamps
Work supports
Linear clamps

99_051

RW-41

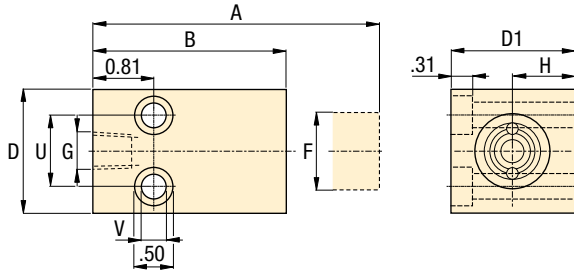

RW-50

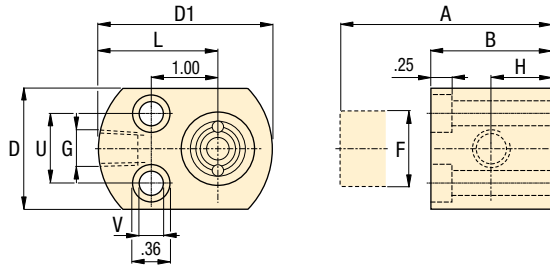

MRW-50F

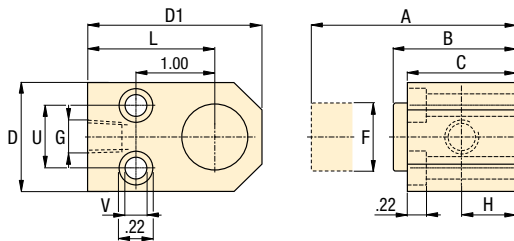

MRW-50M

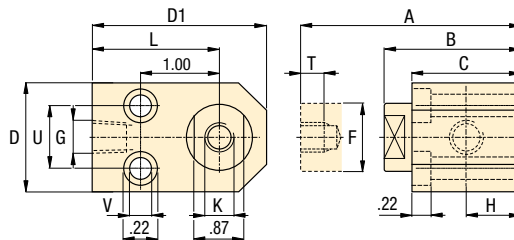

RW-series

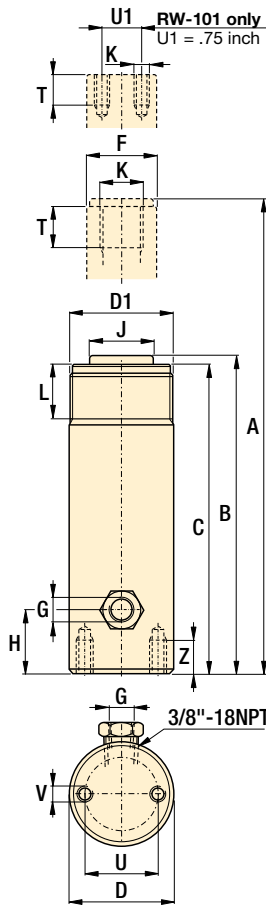

Force: 4970-11,180 lbs

Stroke: .59-10.13 inch

Pressure: 600-5000 psi

- E** Cilindros universales
- F** Vérins universels
- D** Universelle Linearzylinder



Options

Cylinder accessories

86 ▶



Important

These cylinders are intended for medium cycle applications. The return spring is intended for retracting the plunger and heavy devices should not be attached to it.

Plungers should be shielded in welding applications to prevent splatter from sticking to chrome plating.

Do not use these cylinders continuously at full stroke or damage to return spring may result.

Product dimensions in inches []

Model number	A	B	C	D	D1	F	G	H	J	K	L	T	U	V	Z	lbs
▼ Block models																
RW-41	3.18	2.56	-	1.62	1.62	1.00	.250-18	0.81	-	-	-	-	1.00	0.35	-	1.8
RW-50	2.24	1.62	-	1.62	2.32	1.00	.375-18	0.75	-	-	1.50	-	1.12	0.22	-	1.8
MRW-50F	2.20	1.61	1.61	1.62	2.56	1.00	.375-18	0.81	-	-	1.75	-	1.12	0.22	-	1.8
MRW-50M	2.60	2.01	1.61	1.62	2.56	1.00	.375-18	0.81	-	M8x1,25	1.75	0.24	1.12	0.22	-	1.8
▼ Cylindrical models																
RW-51	5.42	4.41	4.09	1.50	1.500-16 UN	1.00	.250-18	0.75	1	.750-16 UNF	1.18	0.61	1.00	.250-20 UNC	0.55	2.1
RW-53	9.73	6.56	6.25	1.50	1.500-16 UN	1.00	.250-18	0.75	1	.750-16 UNF	1.18	0.61	1.00	.250-20 UNC	0.55	3.1
RW-55	13.74	8.57	8.25	1.50	1.500-16 UN	1.00	.250-18	0.75	1	.750-16 UNF	1.18	0.61	1.00	.250-20 UNC	0.55	3.9
RW-101	4.53	3.54	3.41	2.25	2.250-14 UNS	1.50	.250-18	0.75	-	#10-24 UNC	1.15	0.24	1.56	.312-18 UNC	0.49	3.8
RW-102	6.97	4.79	4.53	2.25	2.250-14 UNS	1.50	.250-18	0.75	1.38	1.000-8 UNC	1.15	0.68	1.56	.312-18 UNC	0.49	4.9
RW-104	10.97	6.79	6.53	2.25	2.250-14 UNS	1.50	.250-18	0.75	1.38	1.000-8 UNC	1.15	0.68	1.56	.312-18 UNC	0.49	7.0
RW-106	15.82	9.71	9.5	2.25	2.250-14 UNS	1.50	.250-18	0.75	1.38	1.000-8 UNC	1.15	0.68	1.56	.312-18 UNC	0.49	9.6
RW-1010	23.88	13.75	13.50	2.25	2.250-14UN	1.50	.250-18	0.75	1.38	1.000-18UN	1.13	0.75	1.56	.312-18un	0.50	13.8

Universal cylinders - Double acting *Application & selection*

Shown: RD-2510, RD-96, RD-256, RD-41, RD-166



Used when high cylinder forces with a powered return stroke is required in a confined area.

Cylinders can push or pull a workpiece into position and the threaded plunger allows adapting standard clevis attachments.

Clamping application using Enerpac RD cylinders (with clevis eye attachments on both ends) for their high pressure capability and mounting flexibility.

Collet-Lok® product line
Swing clamps
Work supports
Linear clamps

Heavy-duty cylinders

...provide push as well as pull forces

- High pressure design when additional force is required for push or pull applications
- Long strokes in a compact design are well suited for custom toggle style clamping
- Various features for mounting
- Threaded plunger allows a wide range of mounting adapter devices
- Chrome plated plunger provides a long cylinder life

Optional cylinder attachments

For added cylinder flexibility, a selection of interchangeable mountings is available to fit plunger or cylinder threads.



Foot mounting

Mounts onto cylinder collar thread. Retainer nut included. Mounting screws not included.



Flange mounting

Mounts onto cylinder collar thread. Retainer nut included. Mounting screws not included.



Retainer nut

Locking foot or flange mountings. Mounts onto cylinder base or collar threads. Included with foot and flange mountings.



Clevis eye

Threads onto plunger or base.

Product selection

Cylinder capacity at 5000 psi	Stroke		Model number	Effective area		Oil capacity	
	in			in ²		in ³	
	push lbs	pull		push	pull	push	pull
3900	1720	1.11	RD-41	.79	.34	.89	.40
3900	1720	3.11	RD-43	.79	.34	2.47	1.10
3900	1720	6.11	RD-46	.79	.34	4.84	2.10
9000	4910	1.15	RD-91	1.77	.98	2.00	1.10
9000	4910	3.15	RD-93	1.77	.98	5.54	3.00
9000	4910	6.15	RD-96	1.77	.98	10.88	6.00
9000	4910	10.15	RD-910	1.77	.98	17.94	9.90
15,500	8300	6.24	RD-166	3.15	1.66	19.67	10.40
15,500	8300	10.24	RD-1610	3.15	1.66	32.26	17.00
24,500	10,750	6.30	RD-256	4.92	2.15	30.73	13.40
24,500	10,750	10.28	RD-2510	4.92	2.15	50.40	22.00



98_049

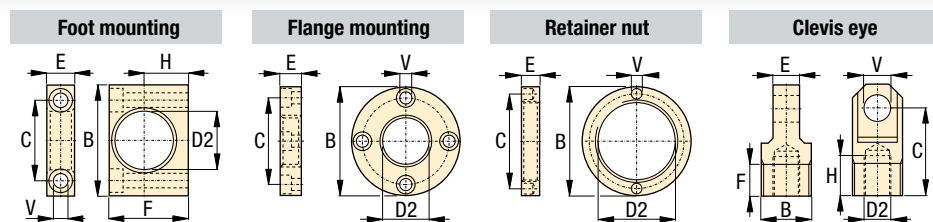

Cylinder attachments in inches []

Cylinder capacity at		D2	Model number	B	C	E	F	H	V	lbs
5000 psi	10,000 psi									
lbs	lbs									
▼ Foot mounting with retainer nut										
3900	7800	1.38	AD-141	3.00	2.00	0.75	2.25	1.25	0.41	0.9
9000	18,000	2.00	AD-171	4.00	2.88	1.00	3.25	1.75	0.53	2.6
15,500	31,000	2.63	AD-181	5.00	3.75	1.38	4.00	2.06	0.78	6.4
24,500	49,000	3.25	AD-191	6.25	4.62	1.75	4.88	2.50	1.03	9.9
▼ Flange mounting with retainer nut										
3900	7800	1.38	AD-142	3.88	3.09	0.75	-	-	0.41	2.2
9000	18,000	2.00	AD-172	4.75	3.88	1.00	-	-	0.41	4.6
15,500	31,000	2.63	AD-182	5.63	4.56	1.38	-	-	0.53	8.4
24,500	49,000	3.25	AD-192	6.50	5.34	1.75	-	-	0.66	13.2
▼ Retainer nut										
3900	7800	1.375-12 UNF	AD-143	2.25	1.81	0.38	-	-	0.25	0.2
9000	18,000	2.000-12 UN	AD-173	3.00	2.50	0.50	-	-	0.27	0.7
15,500	31,000	2.625-16 UN	AD-183	3.63	3.13	0.75	-	-	0.27	1.3
24,500	49,000	3.250-16 UN	AD-193	4.25	3.75	1.00	-	-	0.27	1.8
▼ Clevis eye										
3900	7800	.500-20 UNF	AD-150	1.125-20 UN	2.06	0.62	0.75	0.94	0.63	0.5
9000	18,000	.750-16 UNF	AD-151	1.688-18 UNF	2.25	1.00	1.00	0.94	0.75	1.3
15,500	31,000	1.125-12 UNF	AD-152	2.187-16 UNS	3.06	1.25	1.00	1.19	1.00	2.9
24,500	49,000	1.500-12 UNF	AD-153	2.750-16 UN	3.06	1.50	1.00	1.06	1.25	4.6

Force: 3900-24,500 lbs

Stroke: 1.11-10.28 inch

Pressure: 500-10,000 psi

- E** Cilindros universales
- F** Vérins universels
- D** Universelle Linearzylinder



Options

Cylinder accessories

86 ▶

Important

Be certain that the mounting devices can handle forces in the push and pull direction.

RD series cylinders are designed for a maximum operating pressure of 10,000 psi.

When applying 10,000 psi cylinder capacities double as well.

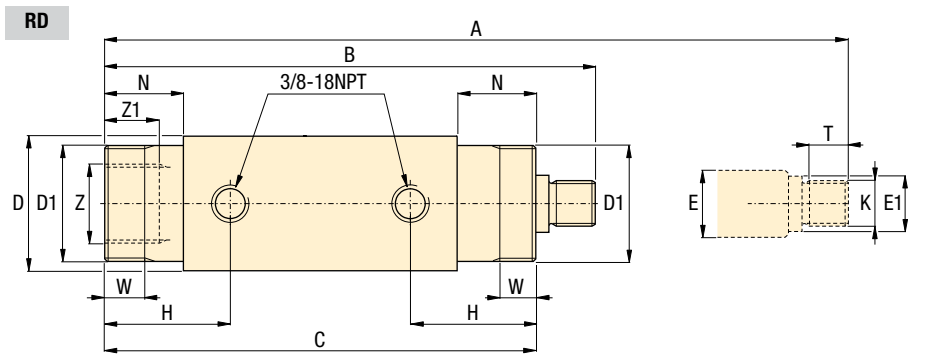

Product dimensions in inches []

Model number	A	B	C	D	D1	E	E1	H	K	N	T	W	Z	Z1	lbs
					UN				UN				UN		
RD-41	8.41	7.30	6.39	2.00	1.375-12	0.75	0.69	1.85	.500-20	1.14	0.76	0.43	1.125-20	0.47	4.8
RD-43	12.41	9.30	8.39	2.00	1.375-12	0.75	0.69	1.85	.500-20	1.14	0.76	0.43	1.125-20	0.47	6.4
RD-46	18.41	12.30	11.39	2.00	1.375-12	0.75	0.69	1.85	.500-20	1.14	0.76	0.43	1.125-20	0.47	9.0
RD-91	9.93	8.78	7.81	2.50	2.000-12	1.00	0.94	2.27	.750-16	1.50	0.77	0.56	1.688-18	0.63	9.0
RD-93	13.93	10.78	9.81	2.50	2.000-12	1.00	0.94	2.27	.750-16	1.50	0.77	0.56	1.688-18	0.63	11.0
RD-96	19.93	13.78	9.81	2.50	2.000-12	1.00	0.94	2.27	.750-16	1.50	0.77	0.56	1.688-18	0.63	14.0
RD-910	27.93	17.78	16.81	2.50	2.000-12	1.00	0.94	2.27	.750-16	1.50	0.77	0.56	1.688-18	0.63	19.0
RD-166	21.57	15.33	14.13	3.00	2.625-16	1.37	1.26	2.90	1.125-12	2.12	1.00	0.88	2.187-16	1.00	22.0
RD-1610	29.57	19.33	18.13	3.00	2.625-16	1.37	1.26	2.90	1.125-12	2.12	1.00	0.88	2.187-16	1.00	29.0
RD-256	22.98	16.68	15.63	3.54	3.250-16	1.87	1.77	3.50	1.500-12	2.76	0.90	1.12	2.750-16	0.99	36.0
RD-2510	30.95	20.67	19.61	3.54	3.250-16	1.87	1.77	3.50	1.500-12	2.76	0.90	1.12	2.750-16	0.99	46.0

Cylinder accessories

Shown: Cylinder accessories



These accessories are provided so that you can effectively position, mount and actuate Enerpac hydraulic cylinders according to your specific fixturing or production applications.

Enerpac worksupport locked in position using an FN series self-locking flange nut.



For optimum mounting and fixture flexibility

...to match specific applications

- **Contact bolts**
Allow cylinders to act as a datum point in your clamping applications, and protect the piston when cylinders are used for pushing applications
- **Cylindrical flange nuts**
For mounting threaded body cylinders in any position
- **Mounting brackets**
For bolting cylinders to suit the application

All BS Models

FN-121, 201, 251

FN-48, 55, 65, 80

All Other FN Models

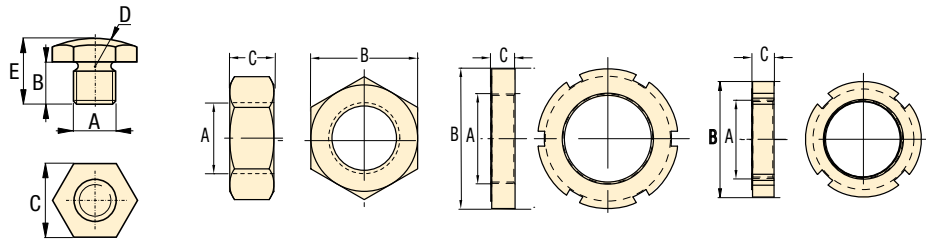

Product dimensions in inches [D]

A	Model number	B	C	D	E	A	Model number	B	C
thread		rad.				thread			
▼ Spherical contact bolts									
#6-32 UNC	BS-21	.20	.25	.24	.35	0.500-20 UNF	FN-121	0.75	0.31
#8-32 UNC	BS-41	.28	.31	.31	.43	M12 x 1,5	FN-122	1.10	0.24
M4 x 0,7	BS-42	.28	.31	.31	.43	0.750-16 UNF	FN-201	1.13	0.42
.250-28 UNF	BS-61	.31	.44	.44	.55	M20 x 1,5	FN-202	1.12	0.31
M6 x 1,0	BS-62	.31	.44	.44	.55	1.000-12 UNF	FN-251	1.50	0.55
.313-24 UNF	BS-81	.39	.56	.55	.67	1.125-16 UN	FN-281	1.75	0.39
M8 x 1,25	BS-82	.39	.55	.55	.67	M28 x 1,5	FN-282	1.97	0.39
.375-16 UNC	BS-91	.39	.63	.63	.67	1.250-16 UN	FN-301	1.88	0.39
.500-13 UNC	BS-101	.39	.69	.67	.71	M30 x 1,5	FN-302	1.97	0.39
M10 x 1,5	BS-102	.26	.67	.91	.43	1.313-16 UN	FN-331	1.88	0.25
M16 x 2,0	BS-162	.47	.87	.87	.94	1.375-18 UNF	FN-351	1.88	0.25
M20 x 2,5	BS-202	.47	.94	.87	.94	M35 x 1,5	FN-352	2.17	0.43
▼ Jam nuts									
						1.625-16 UN	FN-421	2.25	0.31
						M42 x 1,5	FN-422	2.44	0.47
						1.875-16 UN	FN-481	2.50	0.51
						M48 x 1,5	FN-482	2.95	0.51
						2.125-16 UN	FN-551	3.13	0.38
						M55 x 1,5	FN-552	3.15	0.51
						2.500-16 UN	FN-651	3.25	0.39
						M65 x 1,5	FN-652	3.74	0.55
						3.125-16 UN	FN-801	4.13	0.51
						M80 x 2,0	FN-802	4.53	0.63

Product dimensions in inches [D]

A	Model number	B	C	D	E	F	H	J
thread		ϕ						
▼ Yoke								
.313-24 UNF	Y-3121	.50	.31	.31	1.25	.63	.50	1.56

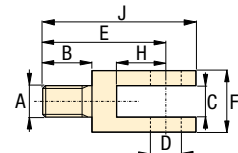

MF and AW-51 models

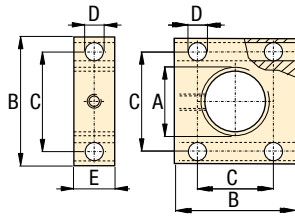

other AW models

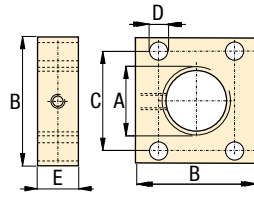

- E** Accesorios de cilindro
- F** Accessoires pour vérins
- D** Zubehör für Zylinder

Product dimensions in inches []

A thread	Model number	B	C	D ø	E
-------------	-----------------	---	---	--------	---

▼ Mounting flanges – Rectangular

1.375-18 UNEF	AW-5	1.75	1.34	0.27	0.50
1.500-16 UN	AW-51	2.25-2.75	1.62-2.12	0.41	1.00
1.875-16 UN	AW-89	2.25	1.77	0.33	1.00
2.500-16 UN	AW-19	3.25	2.17	0.35	0.98
3.125-16 UN	AW-90	3.75x4.75	2.38x3.50	0.64	1.25
0.500-20 UNF	MF-121	1.50	1.00	0.27	1.00
M12 x 1,5	MF-122	1.57	0.98	0.25	0.98
0.750-16 UNF	MF-201	2.25	1.50	0.40	1.50
M20 x 1,5	MF-202	2.56	1.77	0.40	1.57
1.000-12 UNF	MF-251	2.50	1.75	0.40	1.50
1.125-16 UN	MF-281	2.75	2.00	0.40	1.50
M28 x 1,5	MF-282	2.95	1.97	0.40	1.57
1.313-16 UN	MF-331	3.00	2.25	0.40	1.50
1.375-18 UNEF	MF-351	3.00	2.25	0.40	1.50
M35 x 1,5	MF-352	3.15	2.24	0.40	1.57
1.625-16 UN	MF-421	3.25	2.50	0.40	1.50
M42 x 1,5	MF-422	3.54	2.48	0.40	1.57
1.875-16 UN	MF-481	3.50	2.75	0.40	1.50
M48 x 1,5	MF-482	3.74	2.76	0.40	1.57
2.125-16 UN	MF-551	4.00	3.00	0.46	1.75
M55 x 1,5	MF-552	4.33	3.23	0.47	1.77
2.500-16 UN	MF-651	4.50	3.50	0.46	1.75
M65 x 1,5	MF-652	4.53	3.50	0.47	1.77
3.125-16 UN	MF-801	5.00	4.00	0.46	1.75
M80 x 2,0	MF-802	5.31	4.25	0.47	1.77

AW-53, -121

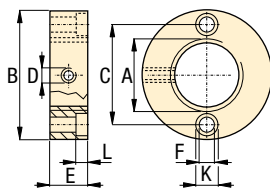

AW-102

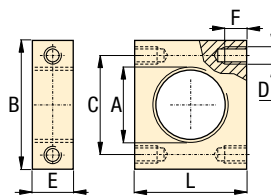

Product dimensions in inches []

A thread	Model number	B ø	C	D thread	E ø	F ø	K ø	L
-------------	-----------------	--------	---	-------------	--------	--------	--------	---

▼ Mounting flanges – Cylindrical

1.500-16 UN	AW-53	2.88	2.25	.250-20 UNC	.75	.28	.41	0.31
2.750-16 UN	AW-121	4.50	3.63	.250-20 UNC	.75	.34	.50	.38

▼ Mounting flanges – Rectangular

2.250-14 UNS	AW-102	4.00	3.00	.438-20 UNF	1.25	.62	–	3.25
--------------	---------------	------	------	-------------	------	-----	---	------

5000 psi Tie Rod Cylinders

Shown: TRFM-1506, TRFL-3210 and TRCM-3206



Enerpac 5000 psi Tie Rod cylinders provide a variety of mounting options for pushing and positioning workpieces and fixtures on a machine. Enerpac tie rod cylinders are designed to the highest industry standards to provide long life and worry-free performance in the most demanding applications.

Performance tested design features at 5000 psi

- Rod seal (1) uses spring loaded multiple lip vee rings, a supporting bronze bearing ring bushing and a double lip wiper
- Piston seal (2) combines two bi-directional sealing cast iron piston rings with two block vee seals with back-up rings
- Hardened chrome plated piston rod (3) resists scoring and corrosion, assuring maximum life
- Steel tubing barrel (4), honed to a fine finish assures superior sealing, minimum friction and maximum seal life
- Rod bushing and seals can be serviced by merely removing the retainer plate (5) on most models

Tie Rod cylinder construction

- 1 Rod Seal
- 2 Piston Seal
- 3 Piston Rod
- 4 Barrel
- 5 Retainer Plate

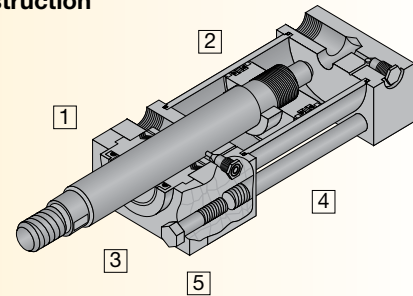

Tie Rod cylinder mounting styles

Clevis Mount – TRCM Series

- NFPA style MP1
- Allows cylinder to pivot
- Requires provision for pivoting on rod end

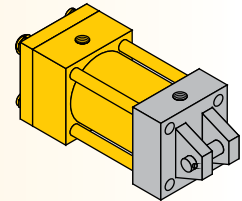

Foot mount – TRFM series

- NFPA style MS2
- Allows easy mounting with only four bolts
- Backup key included in design to ensure long life

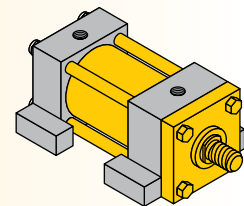

Flange mount – TRFL series

- NFPA style ME5
- Allows cylinder length to be buried in machine
- Strongest, most rigid mount

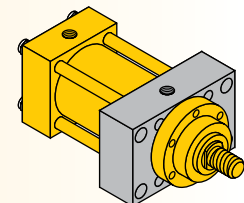

Standard bore sizes

Bore diameter in	Rod diameter in	Capacity at 5000 psi		Effective area	
		Push lbs	Pull lbs	Push in ²	Pull in ²
1.50	1.00	8,850	4,900	1.77	0.98
2.00	1.38	15,700	8,300	3.14	1.66
2.50	1.75	24,550	12,500	4.91	2.50
3.25	2.00	41,500	25,800	8.30	5.16
4.00	2.50	62,850	38,300	12.57	7.66

Additional bore sizes

Bore diameter in	Rod diameter in	Capacity at 5000 psi	
		Push lbs	Pull lbs
5.00	3.50	98,170	50,060
6.00	4.00	141,400	78,550
7.00	5.00	192,400	94,220
8.00	5.50	251,400	132,600

Contact Enerpac for ordering information on additional bore sizes.

Collet-Lok® product line
Swing clamps
Work supports
Linear clamps

98-037

Product selection

Piston diameter	Rod diameter	Stroke	Clevis mount	Foot mount	Flange mount
in	in	in			
1.50	1.00	2	TRCM-1502	TRFM-1502	TRFL-1502
1.50	1.00	4	TRCM-1504	TRFM-1504	TRFL-1504
1.50	1.00	6	TRCM-1506	TRFM-1506	TRFL-1506
1.50	1.00	10	TRCM-1510*	TRFM-1510	TRFL-1510
1.50	1.00	12	TRCM-1512*	TRFM-1512	TRFL-1512
2.00	1.38	2	TRCM-2002	TRFM-2002	TRFL-2002
2.00	1.38	4	TRCM-2004	TRFM-2004	TRFL-2004
2.00	1.38	6	TRCM-2006	TRFM-2006	TRFL-2006
2.00	1.38	10	TRCM-2010	TRFM-2010	TRFL-2010
2.00	1.38	12	TRCM-2012	TRFM-2012	TRFL-2012
2.50	1.75	2	TRCM-2502	TRFM-2502	TRFL-2502
2.50	1.75	4	TRCM-2504	TRFM-2504	TRFL-2504
2.50	1.75	6	TRCM-2506	TRFM-2506	TRFL-2506
2.50	1.75	10	TRCM-2510	TRFM-2510	TRFL-2510
2.50	1.75	12	TRCM-2512	TRFM-2512	TRFL-2512
3.25	2.00	2	TRCM-3202	TRFM-3202	TRFL-3202
3.25	2.00	4	TRCM-3204	TRFM-3204	TRFL-3204
3.25	2.00	6	TRCM-3206	TRFM-3206	TRFL-3206
3.25	2.00	10	TRCM-3210	TRFM-3210	TRFL-3210
3.25	2.00	12	TRCM-3212	TRFM-3212	TRFL-3212
4.00	2.50	2	TRCM-4002	TRFM-4002	TRFL-4002
4.00	2.50	4	TRCM-4004	TRFM-4004	TRFL-4004
4.00	2.50	6	TRCM-4006	TRFM-4006	TRFL-4006
4.00	2.50	10	TRCM-4010	TRFM-4010	TRFL-4010
4.00	2.50	12	TRCM-4012	TRFM-4012	TRFL-4012

Cushions are available for all cylinder models. Cushions slow down heavy loads prior to end of stroke, preventing damage to the cylinder of the machine. To add cushions to your Enerpac Tie Rod cylinder, simply add the letter "C" to the end of any model number. Note: the addition of cushions does not affect the outside dimensions of the cylinder.

* These models are only rated to 4000 psi due to constraints on the mechanical properties of the rod.

Custom build your Tie Rod cylinder

TR	CM	15	12	C
1	2	3	4	5
1 Product Type TR = Tie Rod		3 Bore Diameter 15 = 1.5" 20 = 2.0" 25 = 2.5" 32 = 3.25" 40 = 4.0"	4 Stroke 02 = 2" 04 = 4" 06 = 6" 10 = 10" 12 = 12"	5 Cushions Blank = None C = Cushions both ends

Seal and repair kits

Seal kits include piston, rod and barrel seals. Repair kits include seal kit plus rod bushing and rear bearing ring.

Product dimensions in inches

Bore diameter in	Rod diameter in	Seal kit	Repair kit
1.50	1.00	TR15SK	TR15RK
2.00	1.38	TR20SK	TR20RK
2.50	1.75	TR25SK	TR25RK
3.25	2.00	TR32SK	TR32RK
4.00	2.50	TR40SK	TR40RK

Force: 8850-62,850 lbs.

Stroke: 2-12 inches

Pressure: 500-5000 psi

- E** Cilindros Atirantados
- F** Vérins à tirants
- D** Zugankerzylinder

Options

Accessories  93 ▶

ZW Series Pumps  114 ▶

VP Series Valves  136 ▶

Fittings  194 ▶

Important

Consult individual product selection pages for application and installation criteria specific to each mounting style. If you are unsure of an application, contact Enerpac directly.

Enerpac can provide many other tie rod cylinders in a wide variety of mounting styles, bore and stroke sizes. Contact Enerpac directly and talk to our Custom Products group for a quotation.

Shown: TRCM-3204



TR series clevis mount

Enerpac clevis mount 5000 psi Tie Rod cylinders provide for motion in two axis, increasing the range of motion on your machine with only one cylinder.

Special rod ends

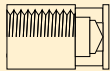

- Either internal or external threads available
- Custom designs to match your tooling requirements

Flexibility of motion

- Clevis mount cylinders include pivot pin for mounting in your machine
- Standard rod eyes and rod clevises available for each bore size.
- NFPA style MP1
- Designed to carry shear loads
- Pivot pins should be carried by rigidly held bearings and closely fit for the entire length of the pin

TRCM models Clevis mount

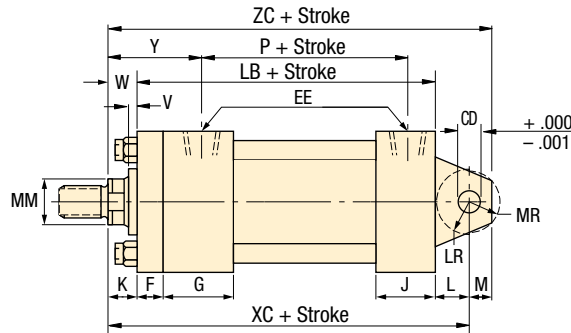
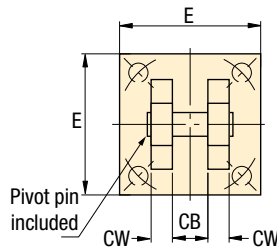

Force: 8850-62,850 lbs.

Stroke: 2-12 inches

Pressure: 500-5000 psi

E Cilindros Atirantados

F Vérins à tirants

D Zugankerzylinder

Options

Accessories

93 ▶



ZW Series Pumps

114 ▶



VP Series Valves

136 ▶



Fittings

194 ▶



Dimensions in inches []

Bore diameter	Rod diameter	Model number	A	B	C	CB	CD	CW	D*	E	EE	F	G	J	K
1.50	1.00	TRCM-15xx**	1.13	1.50	0.50	0.75	0.50	0.50	0.88	2.50	SAE #10	0.38	1.75	1.50	0.50
2.00	1.38	TRCM-20xx	1.63	2.00	0.63	1.25	0.75	0.63	1.13	3.00	SAE #10	0.63	1.75	1.50	0.63
2.50	1.75	TRCM-25xx	2.00	2.38	0.75	1.25	0.75	0.63	1.50	3.50	SAE #10	0.63	1.75	1.50	0.63
3.25	2.00	TRCM-32xx	2.25	2.63	0.88	1.50	1.00	0.75	1.69	4.50	SAE #12	0.75	2.00	1.75	0.75
4.00	2.50	TRCM-40xx	3.00	3.13	1.00	2.00	1.38	1.00	2.06	5.00	SAE #12	0.88	2.00	1.75	0.75

* D = Distance across plunger wrench flats.

** 10 and 12 inch models are rated at only 4000 psi.

Bore diameter	Rod diameter	Model number	KK2	L	LB	LR	M	MM	MR	NA	P	V	W	XC	Y	ZC	lbs
1.50	1.00	TRCM-15xx	3/4"-16	0.75	5.00	0.63	0.50	1.00	0.66	0.97	2.13	0.50	1.00	6.75	2.38	7.25	***
2.00	1.38	TRCM-20xx	1"-14	1.25	5.25	1.13	0.75	1.38	0.94	1.34	2.88	0.38	1.00	7.50	2.63	8.25	***
2.50	1.75	TRCM-25xx	1-1/4"-12	1.25	5.38	1.13	0.75	1.75	0.94	1.70	3.00	0.50	1.25	7.88	2.88	8.63	***
3.25	2.00	TRCM-32xx	1-1/2"-12	1.50	6.25	1.25	1.00	2.00	1.19	1.95	3.59	0.38	1.25	9.00	3.09	10.00	***
4.00	2.50	TRCM-40xx	1-7/8"-12	2.13	6.63	1.88	1.38	2.50	1.38	2.45	3.88	0.38	1.38	10.13	3.31	11.50	***

*** For product weights, please reference the price list or contact Enerpac customer service for more information.

Collet-Lok® product line
Swing clamps
Work supports
Linear clamps

Force: 8850-62,850 lbs.

Stroke: 2-12 inches

Pressure: 500-5000 psi

E Cilindros Atirantados

F Vérins à tirants

D Zugankerzylinder

Options

Accessories

93 ▶



ZW Series Pumps

114 ▶



VP Series Valves

136 ▶



Fittings

194 ▶

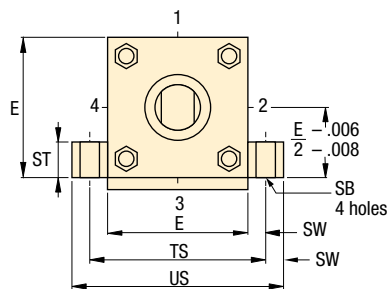

Ease of installation

- Foot mount cylinders provide simplest mounting option with just four bolt holes required
- Standard key mount is included ensuring proper mounting and adding rigidity
- NFPA style MS2
- Compact mounting fits in tight spaces where other cylinders cannot

TRFM models Foot Mount

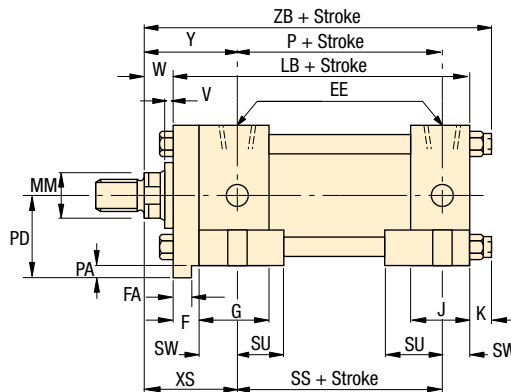
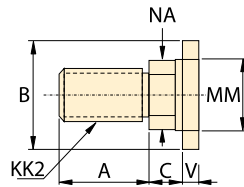

Dimensions in inches []

Bore diameter	Rod diameter	Model number	A	B	C	D*	E	EE	F	FA	G	J	K	KK2	LB	MM
1.50	1.00	TRFM-15xx	1.13	1.50	0.50	0.88	2.50	SAE #10	0.38	0.310-0.312	1.75	1.50	0.50	3/4"-16	5.00	1.00
2.00	1.38	TRFM-20xx	1.63	2.00	0.63	1.13	3.00	SAE #10	0.63	0.560-0.562	1.75	1.50	0.63	1"-14	5.25	1.38
2.50	1.75	TRFM-25xx	2.00	2.38	0.75	1.50	3.50	SAE #10	0.63	0.560-0.562	1.75	1.50	0.63	1-1/4"-12	5.38	1.75
3.25	2.00	TRFM-32xx	2.25	2.63	0.88	1.69	4.50	SAE #12	0.75	0.684-0.687	2.00	1.75	0.75	1-1/2"-12	6.25	2.00
4.00	2.50	TRFM-40xx	3.00	3.13	1.00	2.06	5.00	SAE #12	0.88	0.809-0.812	2.00	1.75	0.75	1-7/8"-12	6.63	2.50

* D = Distance across plunger wrench flats.

Bore diameter	Rod diameter	Model number	NA	P	PA	PD	SB	SS	ST	SU	SW	TS	US	V	W	XS	Y	ZB	
1.50	1.00	TRFM-15xx	0.97	2.88	0.19	1.44	0.44	3.88	0.50	0.94	0.38	3.25	4.00	0.50	1.00	1.75	2.38	6.50	***
2.00	1.38	TRFM-20xx	1.34	2.88	0.31	1.81	0.56	3.63	0.75	1.25	0.50	4.00	5.00	0.38	1.00	2.13	2.63	6.88	***
2.50	1.75	TRFM-25xx	1.70	3.00	0.31	2.06	0.81	3.38	1.00	1.56	0.69	4.88	6.25	0.50	1.25	2.56	2.88	7.25	***
3.25	2.00	TRFM-32xx	1.95	3.59	0.38	2.63	0.81	4.13	1.00	1.56	0.69	5.88	7.25	0.38	1.25	2.69	3.09	8.25	***
4.00	2.50	TRFM-40xx	2.45	3.88	0.44	2.94	1.06	4.00	1.25	2.00	0.88	6.75	8.50	0.38	1.38	3.13	3.31	8.75	***

*** For product weights, please reference the price list or contact Enerpac customer service for more information.

Shown: TRFM-1506



TR series foot mount

Enerpac foot mount 5000 psi Tie Rod cylinders provide a high quality positioning solution using a minimal amount of space.

Important

Some custom options may require reduction of working pressure or special installation considerations. Contact Enerpac Technical Service to discuss your application.

Special rod ends

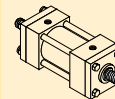

Double rod ends

- Available on all models except clevis mounts
- The two rod ends can be different on the same cylinder

98-037

Linear cylinders

Power sources

Valves

Pallet components

System components

Yellow pages

Shown: TRFL-3206



TR series flange mount
Enerpac flange mount 5000 psi Tie Rod cylinders provide the most rigid mounting ensuring long life and high accuracy on your machine.

Extra strong

- Flange mount is part of the cylinder end cap, providing maximum strength and rigidity
- Allows length of cylinder to be mounted inside the machine
- NFPA style ME5
- Simple four bolt mounting pattern makes installation easy
- Mounting is best suited for tensioning applications

Force: 8850-62,850 lbs.

Stroke: 2-12 inches

Pressure: 500-5000 psi

E Cilindros Atirantados

F Vérins à tirants

D Zugankerzylinder

Options

Accessories

86 ▶



ZW Series Pumps

114 ▶



VP Series Valves

136 ▶



Fittings

194 ▶



TRFL models Flange Mount

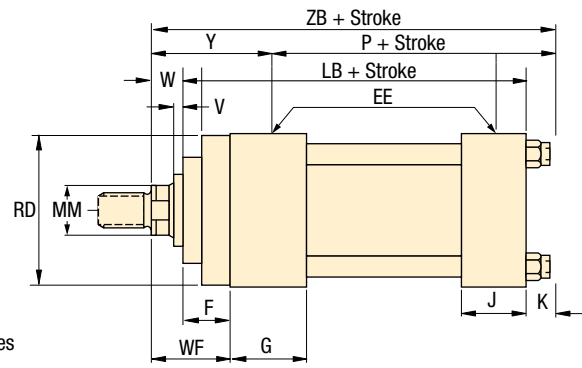
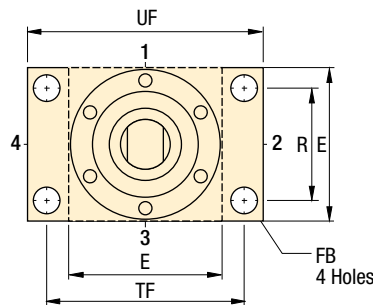
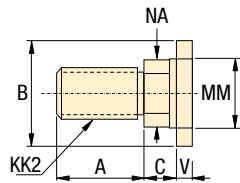

Special rod ends

Rod boots

- Rod boots are made from neoprene coated fabric
- Impervious to oil grease and water
- Rated for temperatures from 0° F to 200° F

Metallic wipers

- Recommended in applications where contaminants tend to cling to the rod surface
- Available on all rod diameters

Dimensions in inches []

Bore diameter	Rod diameter	Model number	A	B	C	D*	E	EE	F	FB	G	J	K	KK2
1.50	1.00	TRFL-15xx	1.13	1.50	0.50	0.88	2.50	SAE #10	0.38	0.44	1.75	1.50	0.50	3/4"-16
2.00	1.38	TRFL-20xx	1.63	2.00	0.63	1.13	3.00	SAE #10	0.63	0.56	1.75	1.50	0.63	1"-14
2.50	1.75	TRFL-25xx	2.00	2.38	0.75	1.50	3.50	SAE #10	0.63	0.56	1.75	1.50	0.63	1-1/4"-12
3.25	2.00	TRFL-32xx	2.25	2.63	0.88	1.69	4.50	SAE #12	0.75	0.69	2.00	1.75	0.75	1-1/2"-12
4.00	2.50	TRFL-40xx	3.00	3.13	1.00	2.06	5.00	SAE #12	0.88	0.69	2.00	1.75	0.75	1-7/8"-12

* D = Distance across plunger wrench flats.

Bore diameter	Rod diameter	Model number	LB	MM	NA	P	R	RD	TF	UF	V	W	WF	Y	ZB	lbs
1.50	1.00	TRFL-15xx	5.00	1.00	0.97	2.88	1.63	-	3.44	4.25	0.50	1.00	1.38	2.38	6.50	***
2.00	1.38	TRFL-20xx	5.25	1.38	1.34	2.88	2.05	-	4.13	5.13	0.38	1.00	1.63	2.63	6.88	***
2.50	1.75	TRFL-25xx	5.38	1.75	1.70	3.00	2.55	-	4.63	5.63	0.50	1.25	1.88	2.88	7.25	***
3.25	2.00	TRFL-32xx	6.25	2.00	1.95	3.59	3.25	4.00	5.88	7.13	0.38	1.25	2.00	3.09	8.25	***
4.00	2.50	TRFL-40xx	6.63	2.50	2.45	3.88	3.82	4.50	6.38	7.63	0.38	1.38	2.25	3.31	8.75	***

*** For product weights, please reference the price list or contact Enerpac customer service for more information.

Collet-Lok® product line
Swing clamps
Work supports
Linear clamps

For high production applications

- Fit any style of Enerpac tie-rod cylinder
- Rod eyes and rod clevises
 - Required for proper mounting of TRCM series cylinders
 - Pivot pins supplied separately
- Pivot pins for rod eyes and clevises
 - Provided with cotter pins
 - Must be ordered separately
- Linear alignment coupler
 - Prevents binding caused by misalignment
 - Reduces rod seal and bearing wear

Shown: RRE-15, TRCC-15, TRPP-15, TRAC-15



Fittings dimensions in inches [D]

From	To	Model number	A	B	C	D
SAE #10	3/8" NPT	FZ2077	1.31	1.00	SAE #10	3/8" NPT
SAE #12	3/8" NPT	FZ2078	1.00	1.25	SAE #12	3/8" NPT
SAE #10	SAE #6	FZ2079	1.26	1.00	SAE #10	SAE #6
SAE #12	SAE #6	FZ2080	1.00	1.25	SAE #12	SAE #6

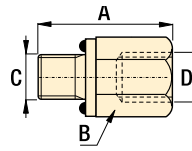

Enerpac 5000 psi Tie-Rod cylinder accessories allow you to complete your design making installation on your machine a simple project.

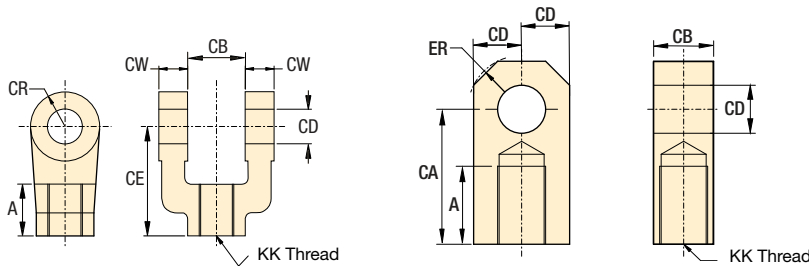

Rod Clevis and Rod Eye dimensions in inches [D]

Rod clevis model number	Rod eye model number	Maximum tension load lbs	KK	A	CA	CB	CD	CE	CR	CW	ER	Clevis Pin
TRRC-15	TRRE-15	12,372	3/4"-16	1.13	2.06	1.25	0.75	2.38	0.75	0.63	0.94	TRPP-15
TRRC-20	TRRE-20	20,433	1"-14	1.63	2.81	1.50	1.00	3.13	1.00	0.75	1.13	TRPP-20
TRRC-25	TRRE-25	30,483	1-1/4"-12	2.00	3.44	2.00	1.38	4.13	1.38	1.00	1.56	TRPP-25
TRRC-32	TRRE-32	49,479	1-1/2"-12	2.25	4.00	2.50	1.75	4.50	1.63	1.25	1.88	TRPP-32
TRRC-40	TRRE-40	70,095	1-7/8"-12	3.00	5.00	2.50	2.00	5.50	2.00	1.25	2.00	TRPP-40

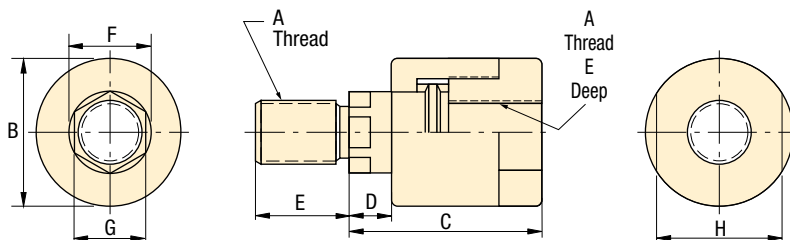

Linear Alignment Coupler in inches [D]

Model number	Maximum tension load lbs	A	B	C	D	E	F	G	H
TRAC-15	8500	3/4"-16	1.75	2.31	0.50	1.13	0.97	0.88	1.50
TRAC-20	16,000	1"-14	2.50	2.94	0.50	1.63	1.38	1.16	2.25
TRAC-25	19,500	1-1/4"-12	2.50	2.94	0.50	1.63	1.38	1.16	2.25
TRAC-32	33,500	1-1/2"-12	3.25	4.38	0.81	2.25	1.75	1.50	3.00
TRAC-40	60,000	1-7/8"-12	3.75	5.44	0.88	3.00	2.00	1.88	3.50