

Pull cylinders - Threaded body models

Shown: PTSS-51, PTSD-121



PT-series

The threaded body pull cylinders can be bolted to the fixture. This allows easy installation or removal of the unit and does not require machined fixture holes.

The cylinder is adjusted to the appropriate height, and then locked in place using a flange nut (□86).

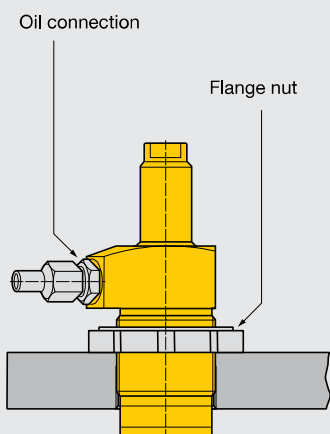

■ Threaded body pull cylinder with modified clamp arm, mounted on a frame-straightening fixture.



Threaded directly into the fixture

...can be secured at any height

- Guided linear plunger movement
- Threaded port connection
- Internal plunger thread allows easy mounting of attachments
- Simple mounting preparation
- Easy installation and removal
- Greatest flexibility in fixture design

Product selection

Cylinder capacity		Stroke in	Model number	Cylinder effective area		Oil capacity	
lbs Pull	Push			in ² Pull	Push	in ³ Pull	Push
▼ Single acting							
1250	–	.89	PTSS-51	.28	–	.25	–
2950	–	1.10	PTSS-121	.63	–	.70	–
▼ Double acting							
1400	2950	.89	PTSD-51	.28	.59	.25	.53
2475	6300	.87	PTSD-92	.49	1.25	.42	1.08
3150	6150	1.10	PTSD-121	.63	1.23	.70	1.40
9600	18,400	1.20	PTSD-351	1.92	3.68	2.27	4.35

Note: - Call Enerpac to order models with BSPP oil connections.
- Pull forces for single-acting cylinders reduced due to spring force.

Dimensions in inches []

Model number	A	B	C1	Thread			E Ø
				D	D1	D2	
▼ Single acting							
PTSS-51	5.07	4.18	0.98	1.375-18 UNEF	1.88	1.49	0.63
PTSS-121	6.31	5.22	1.00	1.875-16 UN	2.38	2.00	0.87
▼ Double acting							
PTSD-51	5.07	4.18	0.98	1.375-18 UNEF	1.88	1.49	0.63
PTSD-92	5.12	4.25	1.19	M48 x 1,5	2.47	1.90	0.98
PTSD-121	6.31	5.22	1.00	1.875-16 UN	2.38	2.00	0.87
PTSD-351	7.72	6.52	1.26	3.125-16 UN	3.48	3.15	1.50

Installation dimensions in inches

Pull force lbs	Fixture hole thread size D3
1400	1.375-18 UNEF
2475	M48 x 1.5
3150	1.875-16 UNF
9600	3.125-16 UN

-51, 121

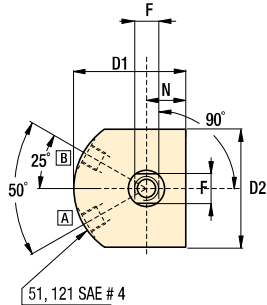

-92, -351

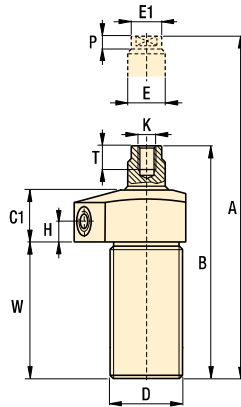
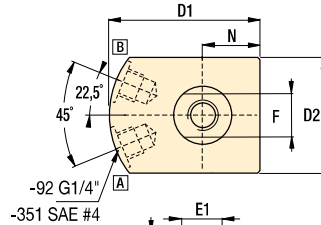

[A] = Pull
[B] = Push (venting)

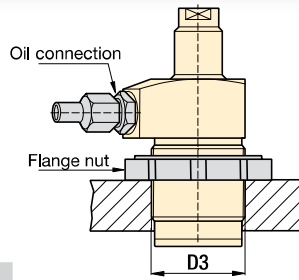
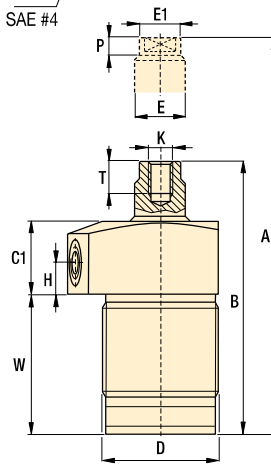

Pull force: 1250-9600 lbs
Push force: 2950-18,400 lbs
Stroke: .87-1.20 inch
Pressure: 500-5000 psi

- E** Cilindros de tracción
- F** Verins traction
- D** Zugzylinder

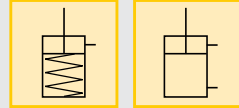

Accessory chart

Model number	Mounting flange Sold separately [87]	Flange nut Sold separately [86]	Yoke Sold separately
--------------	--	---------------------------------------	-------------------------

▼ Single acting

PTSS-51	MF-351	FN-351	Y3121
PTSS-121	MF-481	FN-811	

▼ Double acting

PTSD-51	MF-351	FN-351	Y3121
PTSD-92	MF-482	FN-482	
PTSD-121	MF-481	FN-481	
PTSD-351	MF-801	FN-801	

	E1	F	H	K	N	P	T	W	Weight lbs	Model number
	∅									
										Single acting ▼
	.59	.51	.38	.313-24 UNF	.75	.23	.62	2.60	2.5	PTSS-51
	.82	.68	.38	.500-20 UNF	1.00	.38	.75	3.38	3.5	PTSS-121
										Double acting ▼
	.59	.51	.38	.313-24 UNF	.75	.23	.62	2.60	2.5	PTSD-51
	.93	.70	.51	M10 x 1.5	.95	.41	.63	2.47	4.4	PTSD-92
	.82	.68	.38	.500-20 UNF	1.00	.38	.75	3.38	3.5	PTSD-121
	1.42	1.13	.51	M16 x 2.0	1.57	.51	1.22	3.22	10.4	PTSD-351

Options

Accessories
[86]

Collet-Lok® swing cylinders
[18]

Swing cylinders
[22]

Sequence valves
[152]

Important

Single-acting cylinders can be vented through the manifold port.

In case there is a risk of machining coolants and debris being inhaled via the breather vent, it is recommended to pipe this port to an area outside the fixture that is protected from machining coolants and debris.