

# Power sources

## Power sources

Whether you need to run your parts once a day or 24 hours a day, Enerpac has the power source to help you get the job done. Power sources range from simple manual pumps to air operated, to fully customizable electric motor driven units.

With a wide variety of accessories to choose from, Enerpac power units are easily the most versatile and reliable in the industry.



















## Technical support

Refer to the “Yellow Pages” of this catalog for:

- Safety instructions
- Basic hydraulic information
- Advanced hydraulic technology
- FMS (Flexible Machining Systems) technology
- Conversion charts and hydraulic symbols

 197 ▶

	▼ series	▼ page	
Choosing a Pump		96 - 97	
Turbo II air-hydraulic pumps	PA	98 - 101	
Air-hydraulic pumps	ZAJ	102	
Air-hydraulic pumps	PA	103	
Air-hydraulic boosters	AHB, B	104 - 105	
Air valves and accessories	VA, VR RFL	106 - 107	
Economy electric pumps	WU	108 - 109	
Electric submerged pumps and ordering matrix	WE	110 - 113	
Electric pumps and ordering matrix	ZW	114 - 117	
Return line filter kit and heat exchanger kits	ZPF, ZHE	118 - 119	
Level/temp switch and pressure transducer	ZLS ZPT, ZPS	120	
Valve manifold	ZW	121	
Pallet coupling pumps	ZW	122 - 123	
Continuous connection pumps	ZW	124 - 125	
Single station D03 pumps	ZW	126 - 127	
Electric driven workholding pump	ZW5	128 - 131	
Hand pumps	P, SP	132	
Enerpac system solutions		133	

# Choosing a pump

Flow rate: 40-640 in<sup>3</sup>/min

Pressure: 960-10,000 psi

Reservoir: Up to 10 gal

## Options

### Manual valves



▣ 143, 148-151 ▶

### Electric valves



▣ 136-142 ▶

### Air operated valves



▣ 140 ▶

## Important

231 cubic inches = 1 US gal.

61 cubic inches = 1 liter

1 US gallon = 3.785 liters

## Select your pump type

### Air operated pump

Best choice for medium circuits with intermittent or medium duty applications. Air operated pumps have lower flow rates than electric pumps, but are more economical.

▣ 98-103 ▶



### Air hydraulic booster

Best choice for small circuits with intermittent or medium-duty applications. Air hydraulic boosters provide a single shot of oil to your circuit at high pressure.

▣ 104-105 ▶



### Economy electric operated pump

The Economy pump is best suited to power small to medium size fixtures. Its lightweight and compact design makes it ideal for applications which require easy transport of the pump. The universal motor works well on long extension cords.

▣ 108-109 ▶



### Electric submerged pump

Enerpac two stage electric submerged pumps are a quiet, economical workholding power source. Submerged in oil the motor stays cooler when used on an intermittent basis.

▣ 110-113 ▶



### Electric operated pump

Best choice for large circuits with medium or high-duty applications. Electric operated pumps have the highest flow rates available and can be configured with many different accessories.

▣ 114-131 ▶



## Select your pump options

### Reservoir size

Choose a reservoir size that holds enough oil to fill all of your lines, manifolds and cylinders, with enough reserve for future needs. Each Enerpac cylinder has an oil capacity listed on its product page, and each power unit has a reservoir capacity listed.

### Valve type

Directional valves allow you control over what portion of the circuit receives oil. Valves can be operated manually, by electric solenoid or by air pilot pressure. Multiple valves can be used with one power unit to control multiple circuits.

### Accessories

For increased automation, electric pumps can be outfitted with additional accessories, including pressure switches, level switches, and control pendants. These options can either be factory installed or added to an existing power unit in the future.

## **i** Factors to consider when choosing a pump

- ? Is an air or electric pump preferred
- ? How frequently will the pump cycle
- ? Are there size constraints where the pump would be mounted
- ? What is the oil volume of the clamps actuated together in each group
- ? Is there an accumulator? What is the oil volume
- ? Are there sequence valves? What is the setting of the first one
- ? Are the control valves to be controlled by the machine controller

Flow: 40-640 in<sup>3</sup>/min

Pressure: 5000 psi max

Reservoir: up to 10 gallons

## ENERPAC Workholding Pump Comparison Chart

### **i** What flow is right for you?

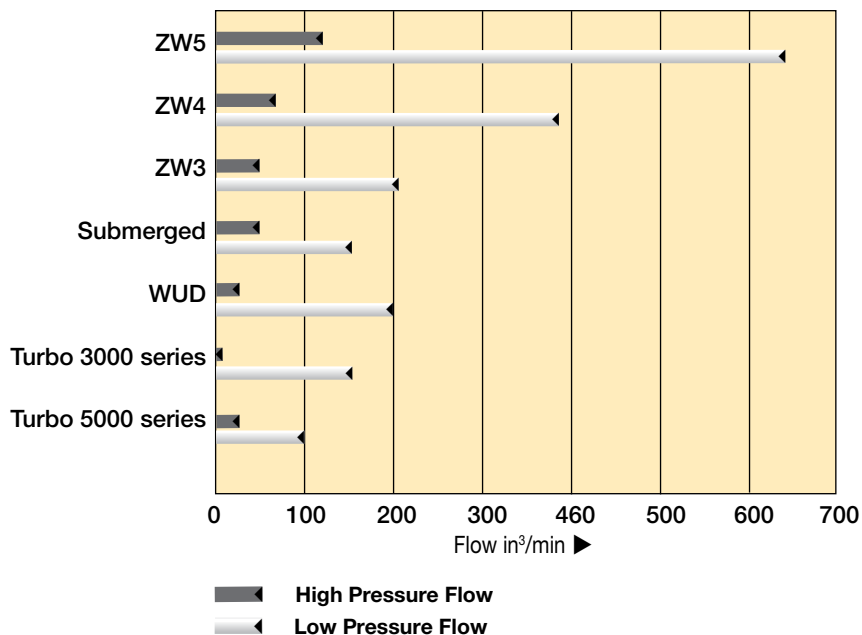

Type of pump	High pressure flow (in <sup>3</sup> /min)	Low pressure flow (in <sup>3</sup> /min)
ZW5	120	640
ZW4	60	380
ZW3	40	205
Submerged	40	150
WUD	20	200
Turbo 3000 series	5	150
Turbo 5000 series	20	100

Shown: PAMG-5402NB, PACG-3102NB, PATG-3102NB, PATG-5105NB



**Turbo II air hydraulic pumps generate the hydraulic pressure you need using the air pressure you have available. The Air Saver Piston reduces air consumption and operating costs.**

They are ideal for providing the power and speed desired in simple clamping circuits. Turbo II air-hydraulic pumps are best suited to medium and lower cycle applications. At only 75 dBA, the Turbo II series helps to keep noise level to a minimum.

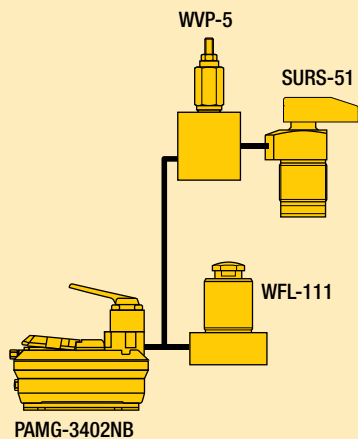

## Quick and powerful hydraulic supply in an economical air-powered unit

- On-demand stall-restart operation maintains system pressure, providing clamping security
- External adjustable pressure relief valve (behind sight glass)
- Internal pressure relief valve provides overload protection
- Reduced noise level to 75 dBA
- Operating air pressure: 50-125 psi – enables pump to start at low air pressure\*\*
- Reinforced heavy-duty lightweight reservoir for applications in tough environments
- Five valve mounting options provide flexibility in setup and operation
- Fully serviceable air motor assembly

## Select the required output

### 3000 series

- Hydraulic to air ratio: 45:1

### 5000 series

- Hydraulic to air ratio: 60:1

**\*\* NOTE:** From 50-125 psi air inlet pressure. Performance is significantly diminished below 50 psi. Performance may vary compared to listed values due to seal friction, internal pressure drops and manufacturing tolerances. Be sure to allow some flexibility on air inlet pressure.

## Output oil flow vs pressure

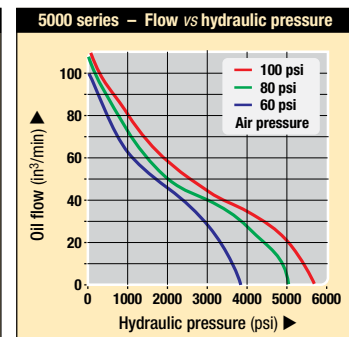
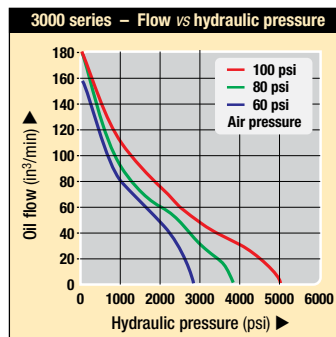

Collet-Lok® product line  
 Swing clamps  
 Work supports  
 Linear clamps  
 Power sources

 **Select the required output:**

**PATG series**

- Momentary air inlet treadle for operation of single-acting cylinders
- Provides advance, hold and retract functions

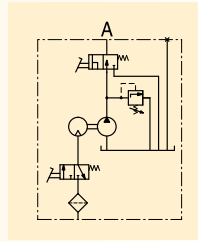

**PACG series**

- Momentary or continuous air inlet treadle
- A remote valve is required for operation of cylinders

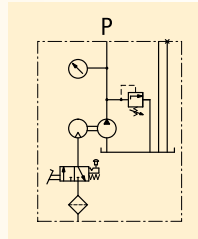

**PASG series**

- Momentary or continuous air inlet treadle
- Suitable for mounting any single- or double-acting valve with a DO3 mounting configuration
- Available with multiple valve manifold (2-gallon only)

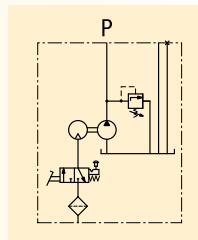

**PAMG series**

- Momentary or continuous air inlet treadle
- Manual 4-way, 3-position, tandem center valve for single- or double-acting operation

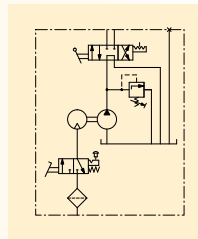

**PARG series**

- Includes 15 ft. air pendant for remote control of single-acting cylinders
- Provides advance, hold and retract functions

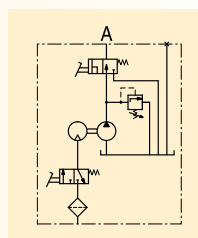

Oil Flow: 180 in<sup>3</sup>/min

Pressure: 5000 psi max

Sound level: 75 dBA

Air: 12 scfm

Reservoir: 70-462 in<sup>3</sup>

- E** Bombas hidroneumáticas
- F** Pompes hydro-pneumatiques
- D** Lufthydraulische pumpen

 **Options**

Gauges and accessories

 190 ▶



Regulator-filter-lubricator

 106,158 ▶



 **Important**

**For high cycle applications electric pumps are recommended.**





Shown: PACG30S8S-WM10



## 2 Gallon Turbo Pump

The 2 gallon Turbo pump models feature a drawn steel reservoir with an oil level sight glass. Choose from models with a P & T manifold for use with remote mount valves, a single station D03 manifold, the standard treadle or manual 4 way valve models. The PARG series uses an air operated pendant to control the pump functions. Or build a system pump with multiple Enerpac VP valve series, VP03 series or VSS/VST series D03 mount valves. The VMMD series D03 Manual valves can also be used.

All dimensions in inches.

- 1 Auxiliary vent/tank fill port
- 2 Hydraulic output
- 3 Gauge mounting port
- 4 Swivel air input with filter
- 5 Filtered permanent tank vent
- 6 Adjustable pressure relief valve
- 7 Air pendant air input

## Product selection

Description	Model numbers 3000 series	Model numbers 5000 series	Usable oil capacity <sup>2)</sup>		Air pressure range	Air consumption	
			horizontal mount	vertical mount			
	180 in <sup>3</sup> min <sup>-1</sup> )	120 in <sup>3</sup> min <sup>-1</sup> )	in <sup>3</sup>	in <sup>3</sup>	psi	scfm	lbs
<b>▼ Factory supplied valves</b>							
Hand/foot 3-way	PATG-3102NB	PATG-5102NB	127	70	50-125	12	19
Hand 4-way	PAMG-3402NB	PAMG-5402NB	127	70	50-125	12	25
Remote 3-way pendant	PARG-3102NB	PARG-5102NB	127	70	50-125	12	23
<b>▼ User supplied valves</b>							
Remote mount	PACG-3002SB	PACG-5002SB	127	70	50-125	12	19
Pump mount, single DO3 Valve	PASG-3002SB	PASG-5002SB	127	70	50-125	12	19

## 1/2 Gallon reservoir

### PATG series

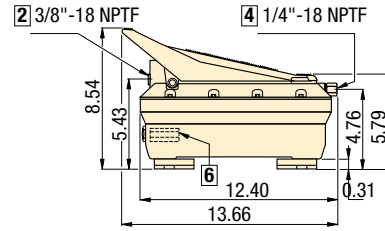
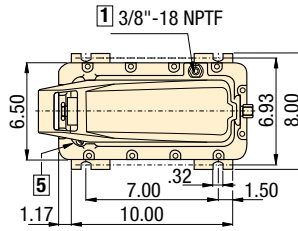

### PACG series

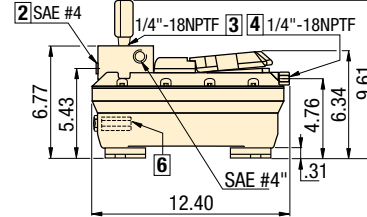
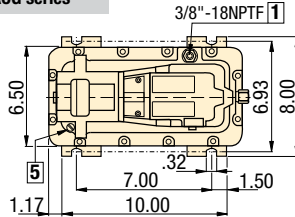

PACG series include pressure gauge G-2517L.

### PASG series

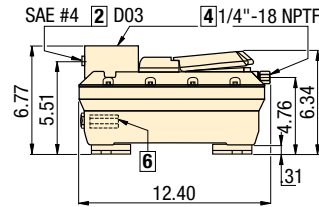
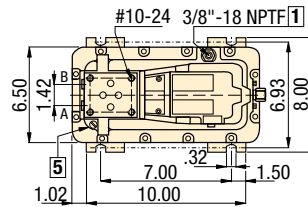

### PAMG series

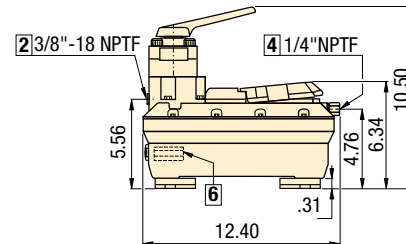
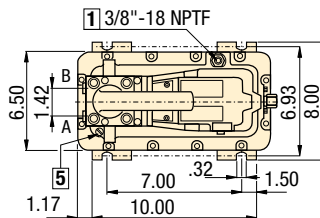

### PARG series

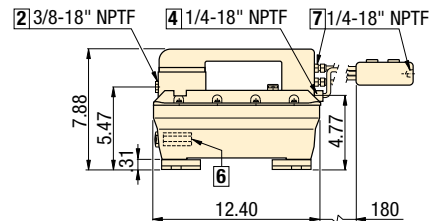
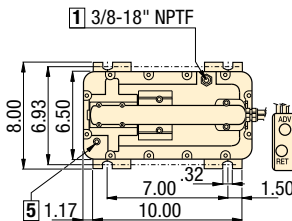

<sup>1)</sup> At 0 psi hydraulic and 100 psi air pressure.  
<sup>2)</sup> Turbo air-hydraulic pumps are also available with 305 in<sup>3</sup> reservoir. To order replace 2 in model number with 5.

Collet-Lok® product line  
Swing clamps  
Work supports  
Linear clamps  
Power sources

**2-Gallon reservoir**

All models

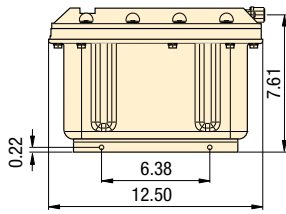

PACG series

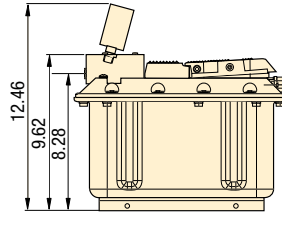

PACG with MB2 or MB4

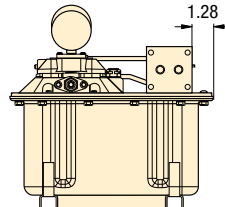
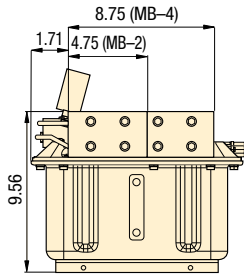

PAMG series

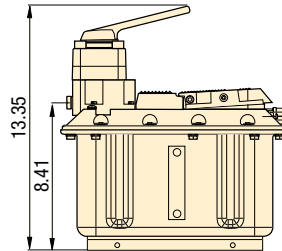

PACG with WM10

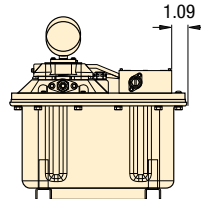
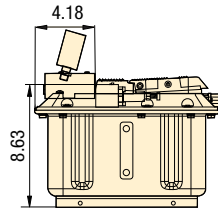

PASG series

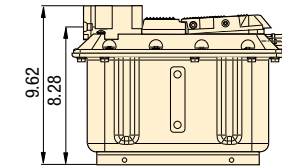

PARG series

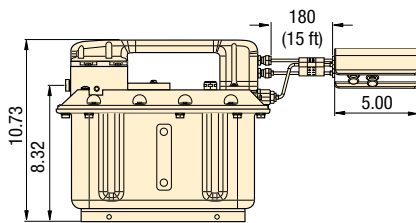

PATG series

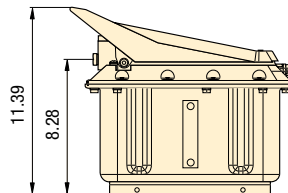

Oil Flow: 180 in<sup>3</sup>/min

Pressure: 5000 psi max

Sound level: 75 dBA

Air: 12 scfm

Reservoir: 70-462 in<sup>3</sup>

- E** Bombas hidroneumáticas
- F** Pompes hydro-pneumatiques
- D** Lufthydraulische pumpen

**Options**

Gauges and accessories

190 ▶



Regulator-filter-lubricator

106,158 ▶



**Product selection**

Description	Model numbers 3000 series	Model numbers 5000 series	Usable oil capacity	Air pressure range	Air consumption	
	180 in <sup>3</sup> min <sup>1)</sup>	120 in <sup>3</sup> min <sup>1)</sup>	in <sup>3</sup>	psi	scfm	lbs
<b>▼ Factory supplied valves</b>						
Hand/foot 3-way	PATG-31S8N	PATG-51S8N	462	50-125	12	54
Hand 4-way	PAMG-34S8N	PAMG-54S8N	462	50-125	12	60
Remote 3-way pendant	PARG-31S8N	PARG-51S8N	462	50-125	12	58
<b>▼ User supplied valves</b>						
Remote mount	PACG-30S8S	PACG-50S8S	462	50-125	12	54
Pump mount, Single DO3 Valve	PASG-30S8S	PASG-50S8S	462	50-125	12	54
Pump mount, Two DO3 Valves	PACG-30S8S-MB2	PACG-50S8S-MB2	462	50-125	12	58
Pump mount, Four DO3 Valves	PACG-30S8S-MB4	PACG-50S8S-MB4	462	50-125	12	61
Pump mount, (1-8) VP Valves	PACG-30S8S-WM10	PACG-50S8S-WM10	462	50-125	12	56

<sup>1)</sup> At 0 psi hydraulic and 100 psi air pressure.



Shown: ZAJ-06505S2C



## ZAJ-065 series air driven pump

These heavy-duty air driven pumps are well suited for use in production applications.

Available with a P & T manifold for use with remote mounted VP, VP03, VSS or VST zero leakage class valves, or with either single or dual pump mounted 2-position/3-way Normally Closed valves 24 VDC solenoid valves.

## Heavy-duty Air Powered Pump

- Suited for use in production applications
- 1-gallon steel reservoir with sight glass, mounting flange

Flow: 124 in<sup>3</sup>/min at 100 psi  
62 in<sup>3</sup>/min at 2000 psi

Pressure: 5000 psi max

- Ⓔ Bombas hidroneumáticas
- Ⓕ Pompes hydro-pneumatiques
- Ⓖ Lufthydraulische pumpen

### ZAJ-06505M1

Pressure and tank manifold for use with remote mounted valves.

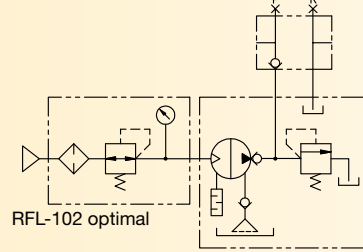

### ZAJ-06505S1C

2-position/3-way normally closed solenoid valve for use with single-acting circuits.

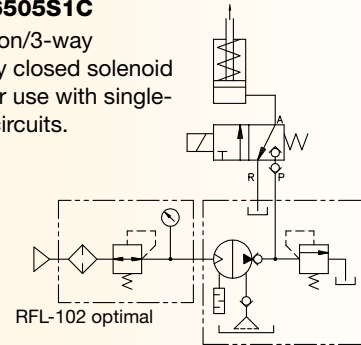

### ZAJ-06505S2C

Dual 2 position/3 way normally closed solenoid valves for use with double-acting circuits.

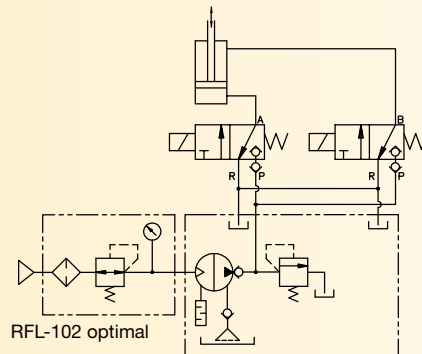

### ZAJ-06505S2C

Dual 2 position/3 way normally closed solenoid valves for use with two independent single-acting circuits.

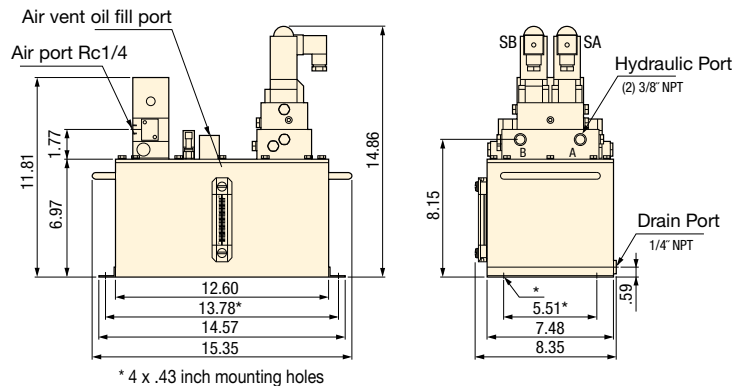
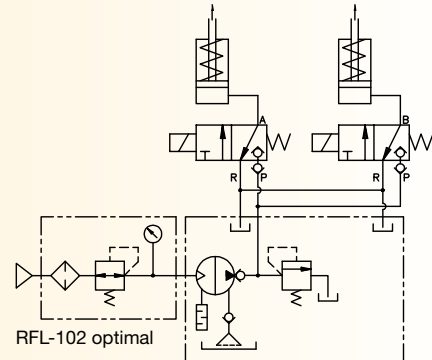

Supplied valving	Valve solenoid voltage	Model number	Air pressure range	Oil ports	Air consumption
					scfm lbs
Pressure and tank manifold	—	<b>ZAJ-06505M1</b>	15-100	3/8" NPT	18 49
Single 2 pos./3 way solenoid valve	24 VDC	<b>ZAJ-06505S1C</b>	15-100	3/8" NPT	18 49
Dual 2 pos./3 way solenoid valve	24 VDC	<b>ZAJ-06505S2C</b>	15-100	3/8" NPT	18 49

Max. flow: 60-120 in<sup>3</sup>/min

Pressure: 5000 psi max

Air: 12 scfm

Reservoir: 36.6 in<sup>3</sup>

- E** Bombas hidroneumáticas
- F** Pompes hydro-pneumatiques
- D** Lufthydraulische pumpen

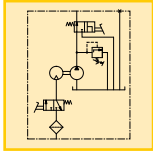

## Portable air hydraulic power

- Patented air saver design - minimal air usage for lower cost operation
- Quiet internal air muffler 80 dBa
- 360° swivel oil and air fittings for easier system setup
- External adjustable relief valve
- Built-in 3-way, 2-position valve provides advance-retract cycle operation for single-acting cylinders

Shown: PA-135, -136



## Options

**Regulator-filter-lubricator**

106,158 ▶



**Fittings**

194 ▶

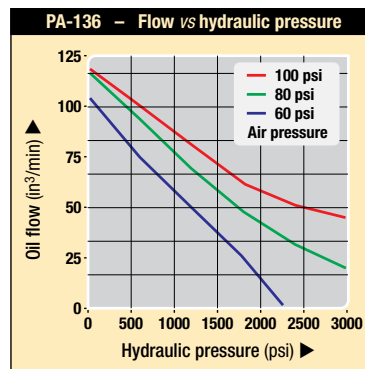
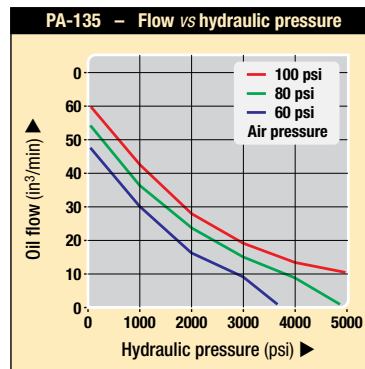
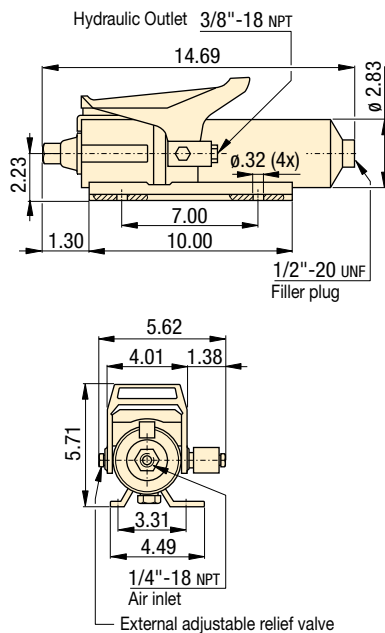

## Product selection

Usable oil capacity	Max. oil flow <sup>1)</sup>	Max. hydraulic pressure	Model number	Valve function	Air pressure range	Air consumption	
in <sup>3</sup>	in <sup>3</sup> /min	psi			psi	scfm	lbs
36.6	60	5000	PA-135	Advance/Retract	60-100	12	14.3
36.6	120	3000	PA-136	Advance/Retract	60-100	12	14.3

<sup>1)</sup> At 0 psi hydraulic pressure.

Note: Seal material: Buna-N, Teflon, Polyurethane.

[www.enerpacwh.com](http://www.enerpacwh.com)

## PA series

Compact, lightweight, air driven power source. Treadle start on pump activates pump operation. Best choice for single-acting cylinders.

These PA series air hydraulic pumps operate in all positions. Here, a PA-135 is mounted vertically to a clamping fixture.



# Air hydraulic boosters *Application & selection*

Shown: AHB-46, B-5003, B-3006



## **AHB and B series boosters**

Large effective area of air piston allows compressed air to generate high output hydraulic pressure.

## For high production applications

- High speed operation
- Extended service life
- Constant hydraulic output
- Large oil delivery per stroke allows quick filling of cylinders for clamping or punching

### AHB series boosters

- Fiberglass wound air chamber eliminates possibility of rust due to moisture in air system
- Designed for fully automated production applications
- Double-acting, one-shot, high speed operation of air piston

### B series boosters

- One-shot spring return
- Steel and cast iron construction
- Built-in stroke sensor for automatic cycle operation  
30 VDC switch closes 1 inch before end of full air piston stroke
- Internal self-bleeding  
Automatically purges air from system when booster piston is at highest point in circuit

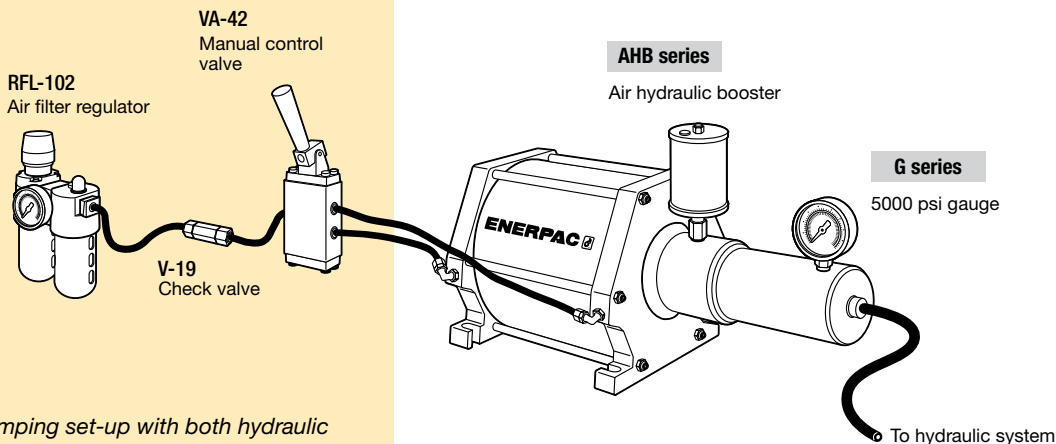

■ In an automated clamping set-up with both hydraulic and pneumatic components, AHB series boosters are used as a power source for the hydraulic system.

## **i** Hydraulic system schematics

Complete power systems eliminate the guesswork of selecting valves and other system components. Plug in your 15 to 115 psi shop air line and connect your hydraulic components for a total system.

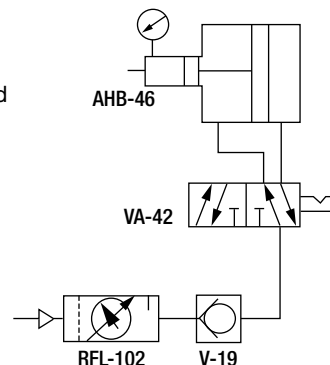

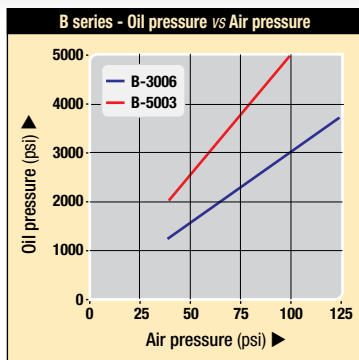
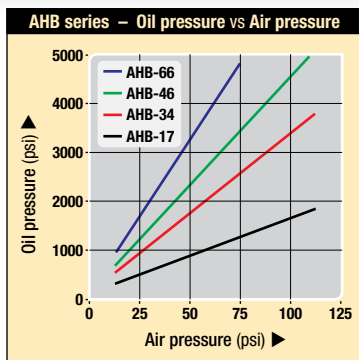

**AHB series**

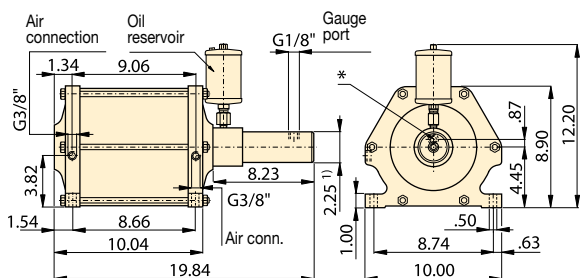

<sup>1)</sup> Ø 2.83\* for model AHB-17  
 \* Oil connection (G1/4")  
 \*\*\* Adapter to 3/8" NPT air connection is included.  
 NOTE: FZ-2060 Adaptor available for gauge port.

**B series**

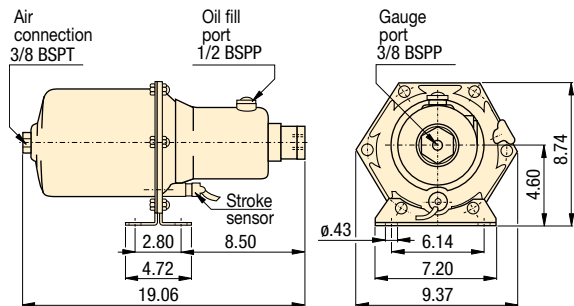

**Selection chart**

Oil pressure		Oil volume per stroke in <sup>3</sup>	Air to oil pressure ratio	Model number	Air consumption per cycle <sup>1)</sup> ft <sup>3</sup> at 85 psi air	Air piston diameter in	Hydraulic piston diameter in	Hydraulic stroke in	Air operating pressure psi	🏋️ lbs
at 75 psi air pressure	at 100 psi air pressure									
<b>▼ AHB series</b>										
1200	1600	18.0	1:16	<b>AHB-17</b>	2.2	8.00	2.00	5.71	15-115	41.4
2550	3460	8.5	1:34	<b>AHB-34</b>	2.2	8.00	1.38	5.71	15-115	37.2
3450	4600	6.1	1:46	<b>AHB-46</b>	2.2	8.00	1.18	5.71	15-115	36.1
4800	-	4.5	1:64	<b>AHB-66</b>	2.2	8.00	1.00	5.71	15-75	35.4
<b>▼ B series</b>										
2250	3000	6.2	1:30	<b>B-3006</b>	.95	7.10	1.22	5.20	40-125	31.0
3750	5000	3.7	1:50	<b>B-5003</b>	.95	7.10	.94	5.20	40-125	31.0

<sup>1)</sup> One cycle = advance + retract stroke.  
 Note: Seal material: Buna-N, Polyurethane.

- Ratio: 1:16-1:64
- Pressure: 1600-5000 psi
- Oil flow: 3.7-18.0 in<sup>3</sup>/stroke
- Air: .95-2.2 scfm/cycle

- E** Multiplicadores
- F** Multiplicateurs
- D** Druckübersetzer

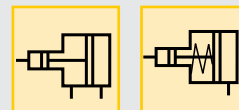

**Options**

**Air valves**  
 106,158 ▶

**Regulator-filter-lubricator**  
 106,158 ▶

**Fittings**  
 194 ▶

**Important**

**Boosters can provide high oil flow rates based on the volume of in-coming air. Do not exceed the flow rate requirements of the components being used.**

**For vertical mounting of booster, an elbow fitting is recommended for the oil reservoir.**

Shown: VA-42, VAS-42



## Air valves

Enerpac's line of directional air valves and accessories complete your workholding system. Used to control air operated hydraulic units, they increase your productivity and efficiency.

### Application

VA-series directional air valves provide either manual or electric control to air operated hydraulic units. Accessories such as rapid exhaust, check valves, silencers and regulators complete the air control system.

- Accessory valves provide greater safety and more efficient clamping cycles
- Recommended for use with all air powered units
- Directional valves to control booster and pump air supply
- Remote air valve permits either hand or foot operation

## Important

**Valving help**  
See Basic System Set-up and Valve information in our "Yellow Pages".

## To control and regulate air supply

### VA-42 Manual operated air valve 5-way, 2-position

- For control of boosters
- Viton seals standard

### VAS-42 Solenoid operated air valve 5-way, 2-position

- For control of pump and boosters air supply
- Viton seals standard
- Solenoid: 120 VAC, 50/60Hz  
Amperage: inrush .11 Amps, holding .07 Amps
- Maximum cycle rate: 600 cycles per minute

### VR-3 Rapid exhaust valve

- Enables booster to advance and retract faster
- Instantly exhaust air supply from booster to atmosphere

### V-19 Air check valve

- Prevent rapid drop of air pressure to the booster in the event of sudden loss of input air

### RFL-102 Regulator-Filter-Lubricator

- Regulates air pressure
- Filter air input
- Lubricates air motors with a fine oil vapor mist
- Maximum air flow 48 scfm

### HV-1000A Air pilot holding valve

- Holds fluid under pressure offering independent control of different branches of the same fixture
- Valve can control the pilot air and the booster in sequence
- Max. oil flow 305 in<sup>3</sup>/min
- Works with the VA-42 four-way air valve and a booster

### QE-375 Muffler

- Use with VR-3 or VAS/VA-42
- Reduces noise level of exhaust air from pump

## Product selection

Maximum pressure psi	Model number
<b>▼ Air valves</b>	
30-150	VA-42
30-150	VAS-42
0-100	VR-3
0-100	V-19
<b>▼ Holding Valve</b>	
0-100	HV-1000A*
<b>▼ Accessories</b>	
0-125	RFL-102
0-125	QE-375

\* Maximum hydraulic pressure: 3000 psi.



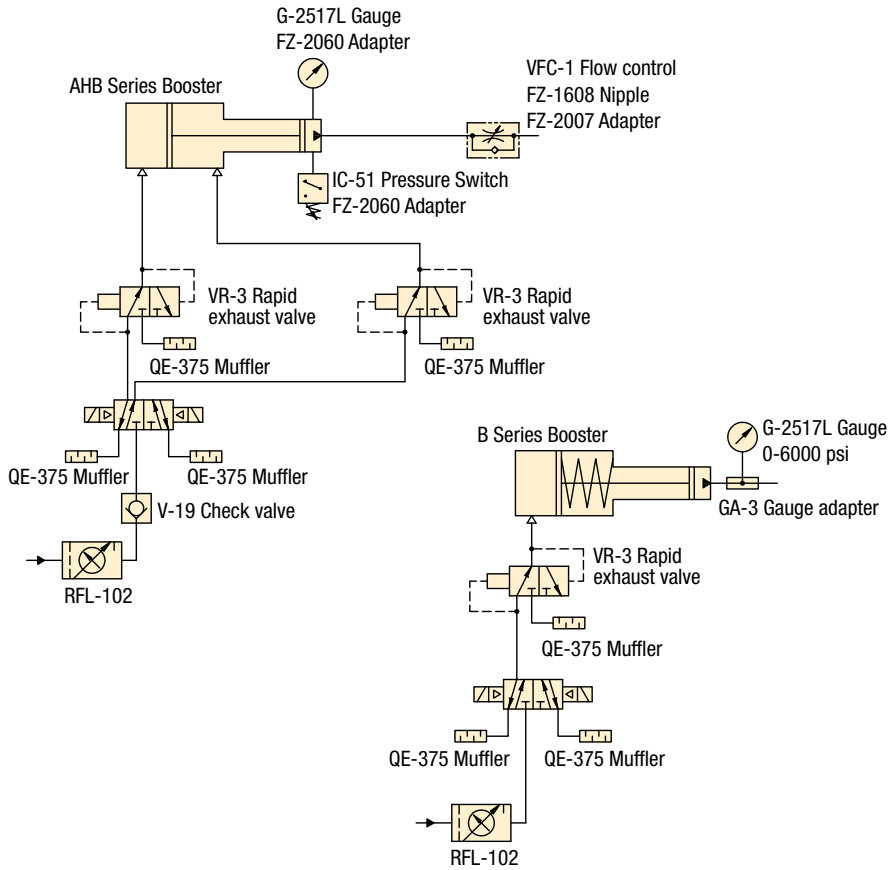

**VR-3**

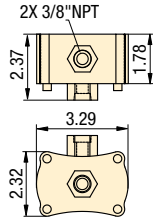

**RFL-102**

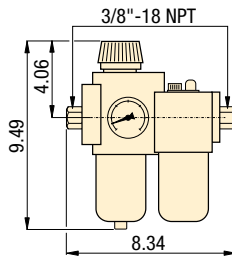

**VA-42**

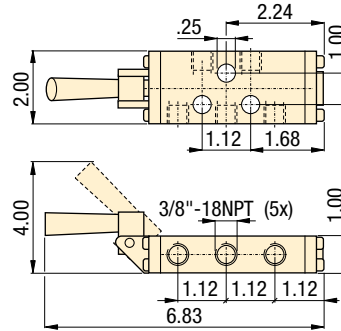

**V-19**

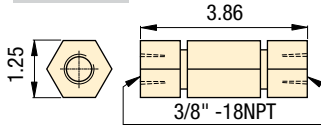

**VAS-42**

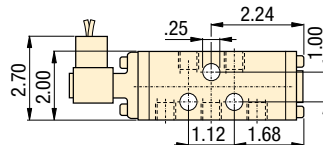

**QE-375**

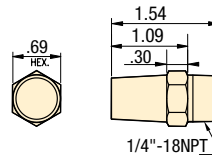

**HV-1000A**

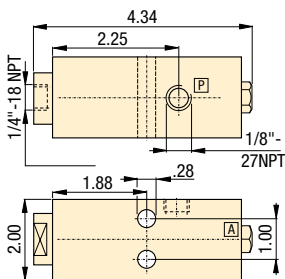

**Air Pressure: 0-150 psi**

- E** Válvulas de aire
- F** Valves à air
- D** Luftventile

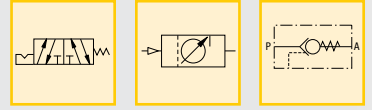

## Options

**Gauges and adaptors**

190 ▶



**Hoses**

192 ▶



**Fittings**

194 ▶



## Important

**Valving help**  
See Basic System Set-up and Valve information in our "Yellow Pages".

197 ▶



Shown: WUD-1301B



The Economy pump is best suited to power small to medium size fixtures. Its lightweight and compact design makes it ideal for applications which require easy transport of the pump. The universal motor works well on long extension cords.

## Heavy on performance, light on weight

- Lightweight and compact design, 26 lbs
- Large easy-carry handle for maximum portability
- Two-speed operation reduces cycle times for improved productivity
- 115 VAC 50/60- or 220 VAC 50/60-cycle universal motor will operate on voltage as low as 60 volts
- 24 VDC remote motor control, 10-ft length for operator safety
- Starts under full load
- High strength molded shroud with integral handle, protects motor from contamination and damage
- Designed for intermittent duty cycle

### WUD-1100 series

- Provides advance/auto-retract of single-acting cylinders
- 10-foot pendant controls motor and valve operation
- Use with AP500

### WUD-1300 series

- Provides advance/hold/retract of single-acting cylinders
- 10-foot pendant controls motor and valve operation
- Ideal for applications requiring remote valve operation
- Use with ACBS22 or ACBS202

## Product selection

Model number	Used with cylinder	Pressure rating (psi)	
		1st stage	2nd stage
<b>WUD-1100B</b>	single-acting	200	5,000
<b>WUD-1101B</b>	single-acting	200	5,000
<b>WUD-1100E</b>	single-acting	200	5,000
<b>WUD-1101E</b>	single-acting	200	5,000
<b>WUD-1300B</b>	single-acting	200	5,000
<b>WUD-1301B</b>	single-acting	200	5,000
<b>WUD-1300E</b>	single-acting	200	5,000
<b>WUD-1301E</b>	single-acting	200	5,000

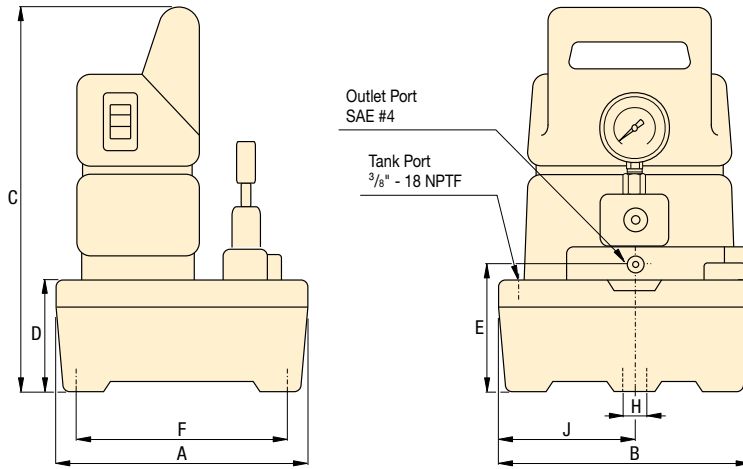
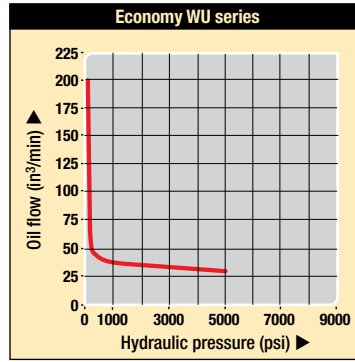

- Flow: 25 in<sup>3</sup>/min
- Pressure: 5000 psi max
- Motor: .5 hp
- Reservoir: 0.5-1 gallon

- E** Bombas eléctricas
- F** Centrale hydraulique
- D** Tauchpumpe

## Standard equipment

### Gauge, filter and pressure switch



Pumps are supplied with a manifold mounted 6000 psi gauge for convenient reading of pump pressure.

A filter at the pressure port helps to protect the pump from contamination.

A manifold mounted adjustable pressure switch provides control of the pump shut-off pressure.

## Product dimensions in inches [ ]

Usable oil capacity	Model number	A	B	C	D	E	F	H	J	
gal										lbs
.50	<b>WUD-1100B</b>	9.62	9.62	14.25	4.00	4.72	8.00	.40	5.25	26
1.0	<b>WUD-1101B</b>	14.50	12.18	14.72	4.15	5.12	12.74	.40	5.62	35
.50	<b>WUD-1100E</b>	9.62	9.62	14.25	4.00	4.72	8.00	.40	5.25	26
1.0	<b>WUD-1101E</b>	14.50	12.18	14.72	4.15	5.12	12.74	.40	5.62	35
.50	<b>WUD-1300B</b>	9.62	9.62	14.25	4.00	4.72	8.00	.40	5.25	26
1.0	<b>WUD-1301B</b>	14.50	12.18	14.72	4.15	5.12	12.74	.40	5.62	35
.50	<b>WUD-1300E</b>	9.62	9.62	14.25	4.00	4.72	8.00	.40	5.25	26
1.0	<b>WUD-1301E</b>	14.50	12.18	14.72	4.15	5.12	12.74	.40	5.62	35

	Output flow rate		Valve type	Current draw	Motor voltage	Sound level	Model number
	1st stage	2nd stage					
	200	25	Dump*	9.5	115	85	<b>WUD-1100B</b>
	200	25	Dump*	9.5	115	85	<b>WUD-1101B</b>
	200	25	Dump*	9.5	220	85	<b>WUD-1100E</b>
	200	25	Dump*	9.5	220	85	<b>WUD-1101E</b>
	200	25	Dump and Hold	9.5	115	85	<b>WUD-1300B</b>
	200	25	Dump and Hold	9.5	115	85	<b>WUD-1301B</b>
	200	25	Dump and Hold	9.5	220	85	<b>WUD-1300E</b>
	200	25	Dump and Hold	9.5	220	85	<b>WUD-1301E</b>

\* Electric dump valve for auto-retract of cylinders.

# Electric submerged pumps

Shown: WEM-1401B



## WE series

Enerpac two stage electric submerged pumps are a quiet, economical workholding power source. Submerged in oil the motor stays cooler when used on an intermittent basis.

## Best performance for mid-range cylinders

- Reduce cycle times for improved productivity
- Two-speed pump unit provides rapid cylinder advance
- Submerged dual voltage induction motor, runs cooler and quieter (60-70 dBA)
- Available with heat exchanger for higher duty cycle applications
- Externally adjustable relief valve – no need to open pump when reducing pressure
- Reservoir mounting holes for easy mounting to fixed surface
- Full length side tube for easy monitoring of oil level
- Auxiliary return port, eliminates the need for a separate adapter

## Select your pump type

### WED-series with dump valve

- For use when load holding is not required
- Ideal for palletized workholding for single acting circuits
- Motor is on only during work cycle

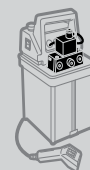

### WEJ-series with remote jog

- Manual valve control
- Motor can be turned on and off by remote pendant for jogging capability



### WEM-series with manual valve

- Manual valve control
- Manual motor control
- Simple and economical solution to your workholding power source needs



### WER-series with remote actuated solenoid

- Solenoid directional with shear seal design
- Remote valve operation



### WES/WET-series with pressure switch

- Pressure switch turns motor on and off
- Used when pressure must be maintained over a period of time
- With pressure gauge



Pressure switch specifications: - Classification NEMA 1  
 - Pressure range: IC-51: 3000-7500 psi  
 IC-31: 500-3500 psi

Flow: 40 in<sup>3</sup>/min

Pressure: 5,000 psi max

Motor: .5 hp

Reservoir: 1.5 gal

**E** Bombas eléctricas

**F** Centrale hydraulique

**D** Tauchpumpe

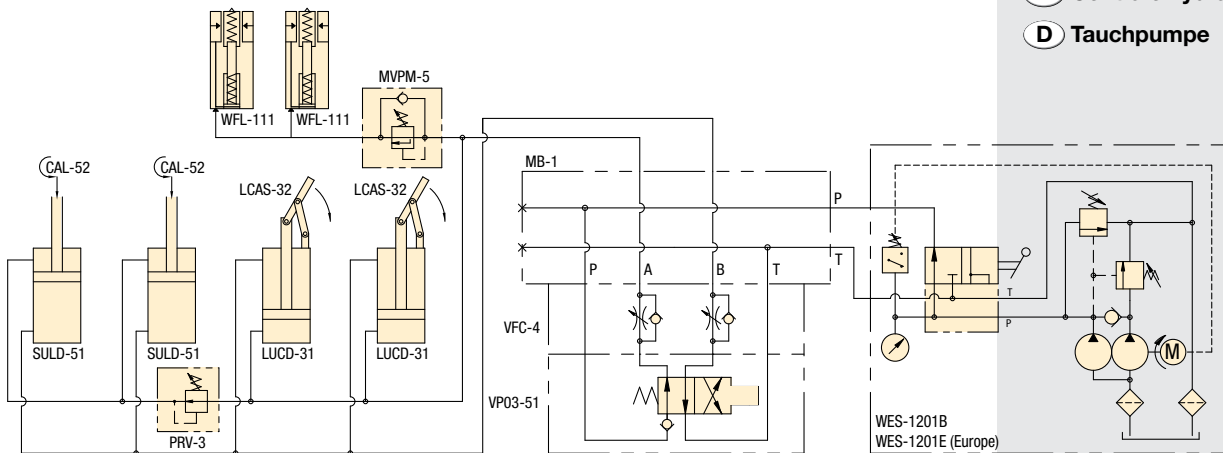
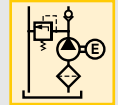

Used with cylinder	Valve function	Valve type	Model number	Motor voltage 50/60 Hz	Heat exchanger
Single-Acting	Advance / Retract	Dump	<b>WED-1101B</b>	115V	
Single-Acting	Advance / Retract	Dump	<b>WED-1101E</b>	230V	
Single-Acting	Advance / Retract	Jog	<b>WEJ-1201B</b>	115V	
Single-Acting	Adv. / Hold / Retr.	Jog	<b>WEJ-1301B</b>	115V	
Double-Acting	Adv. / Hold / Retr.	Jog	<b>WEJ-1401B</b>	115V	
Single-Acting	Advance / Retract	Manual 3/2	<b>WEM-1201B</b>	115V	
Single-Acting	Advance / Retract	Manual 3/2	<b>WEM-1201D</b>	115V	●
Single-Acting	Advance / Retract	Manual 3/2	<b>WEM-1201E</b>	230V	
Single-Acting	Advance / Retract	Manual 3/2	<b>WEM-1201F</b>	230V	●
Single-Acting	Adv. / Hold / Retr.	Manual 3/3	<b>WEM-1301B</b>	115V	
Single-Acting	Adv. / Hold / Retr.	Manual 3/3	<b>WEM-1301F</b>	230V	●
Double-Acting	Adv. / Hold / Retr.	Manual 4/3	<b>WEM-1401D</b>	115V	●
Double-Acting	Adv. / Hold / Retr.	Manual 4/3	<b>WEM-1401E</b>	230V	
Single-Acting	Adv. / Hold / Retr.	Solenoid	<b>WER-1301B</b>	115V	
Single-Acting	Adv. / Hold / Retr.	Solenoid	<b>WER-1301D</b>	115V	●
Single-Acting	Adv. / Hold / Retr.	Solenoid	<b>WER-1301E</b>	230V	
Double-Acting	Adv. / Hold / Retr.	Solenoid	<b>WER-1401B</b>	115V	
Double-Acting	Adv. / Hold / Retr.	Solenoid	<b>WER-1401D</b>	115V	●
Double-Acting	Adv. / Hold / Retr.	Solenoid	<b>WER-1401F</b>	230V	●
Single-Acting	Advance / Retract	Manual 3/2	<b>WES-1201B</b>	115V	
Single-Acting	Advance / Retract	Manual 3/2	<b>WET-1201B</b>	115V	
Single-Acting	Adv. / Hold / Retr.	Manual 3/3	<b>WES-1301B</b>	115V	
Single-Acting	Adv. / Hold / Retr.	Manual 3/3	<b>WES-1301E</b>	230V	
Double-Acting	Adv. / Hold / Retr.	Manual 4/3	<b>WES-1401B</b>	115V	
Double-Acting	Adv. / Hold / Retr.	Manual 4/3	<b>WES-1401E</b>	230V	

## Options

**G-series pressure gauges**

☐ 190 ▶



**FL-series high-pressure filters**

☐ 193 ▶



**FZ-series fittings**

☐ 194 ▶



**HF-series hydraulic oil**

☐ 193 ▶



## ! Important

Oil should be replaced every 500 working hours to ensure long life. Change filters when changing oil or 4 times a year whichever comes first.

Heat exchanger cools oil in pumps used in higher duty cycle applications.

Output flow rate should be matched to hydraulic components used in the system.

# WE-Series, Submerged Electric Pumps

Shown: WEM-1401B



## WER series

Enerpac submerged motor pumps are available in a wide range of configurations to fit any requirement.

◀ For full features see page 110.

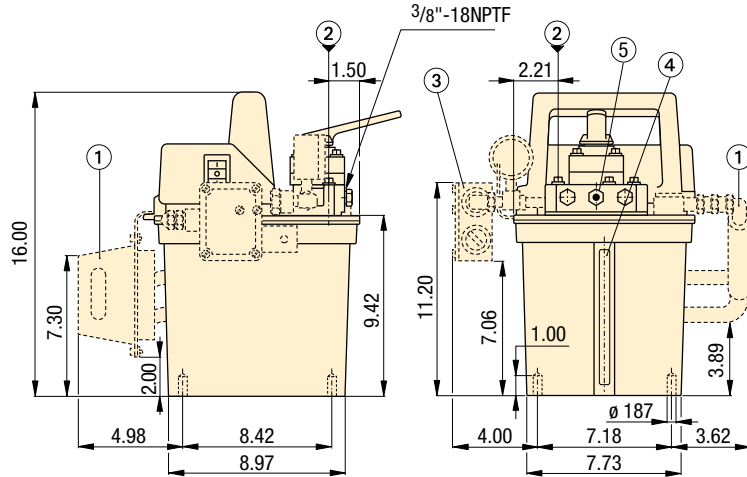
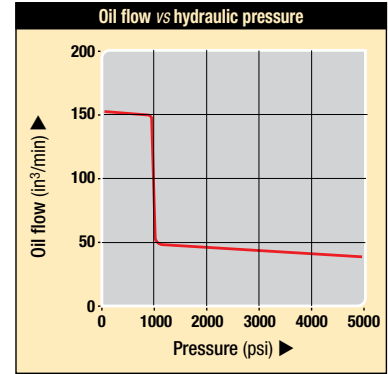

Dimensions shown in inches.

- ① Heat Exchanger (optional for all models)
- ② Fill Port
- ③ Pressure Switch (WES-Series, optional for other models)
- ④ Oil Level Indicator
- ⑤ Adjustable Relief Valve

## Product selection

Motor voltage	Motor capacity	Amperage draw	Maximum oil flow**		Pressure rating		Usable oil capacity	Adjustable relief valve	Weight
			1st stage	2nd stage	1st stage	2nd stage			
50/60 Hz 1 ph	hp	amps	1st stage	2nd stage	1st stage	2nd stage	gal	psi	lbs
115V-1ph	.50	13.5	150	40	1000	5000	1.5	1000 - 5000	63 <sup>1)</sup>
230V-1ph	.50	6.75	150	40	1000	5000	1.5	1000 - 5000	63 <sup>1)</sup>

<sup>1)</sup> Weight for WES and WET models is 83 lbs.

\*\* All flow data at 60 Hz, 50 Hz data will be 5/6 th this number.

 Custom build your submerged pump

▼ This is how a submerged pump model number is built up:

If the submerged pump that would best fit your application cannot be found in the chart on page 111, you can easily build your custom submerged pump here.



**1 Product Type**

**W** = Workholding Pump

**2 Motor Type**

**E** = Electric motor

**3 Pump Type**

**D** = Dump

**J** = Jog

**M** = Manual

**R** = Remote (solenoid)

**S** = Pressure switch (IC-51)

**T** = Pressure switch (IC-31)

**4 Pump Series**

**1** = .5 hp 10,000 psi

**5 Valve Type**

**0** = No valve (WER only)

**1** = Dump

**2** = 3-way, 2-position, normally open

**3** = 3-way, 3-position, tandem center

**4** = 4-way, 3-position, tandem center

**5** = Custom VE-series valve (WER only)

See example 2 below.

**6 Reservoir Capacity**

**01** = 1.5 gallon

**7 Motor Voltage and Heat Exchanger**

**B** = 115 V, 1 Ph, 50/60 Hz

**D** = 115 V, 1 Ph, 50/60 Hz with heat exchanger

**E** = 230 V, 1 Ph, 50/60 Hz

**F** = 230 V, 1 Ph, 50/60 Hz with heat exchanger

**I** = 230 V, 1 Ph, 60 Hz\*

\* To order WER models, for 60 Hz applications, replace the "E" suffix for "I".

Ordering example 1



Examples

**Model number:**

**WER-1301B**

The **WER-1301B** is a .5 hp, 5,000 psi, submerged electric pump, with 1.5 gallon usable oil capacity, a 3-way, 3-position modular, remote solenoid valve (VEF-series) and a 115 V, 1 Phase, 50/60 Hz motor.

**Model number:**

**WER-1501B- VED15000D**

The **WER-1501B** is a .5 hp, 5,000 psi, submerged electric pump, with 1.5 gallon usable oil capacity. The valve, model **VED15000D** is a 115 V, 60 Hz solenoid valve. (For details and options for all VE-series valves see pages 146-147.)

Flow: 40 in<sup>3</sup>/min

Pressure: 5,000 psi max

Motor: .5 hp

Reservoir: 1.5 gal

**E** Bombas eléctricas

**F** Centrale hydraulique

**D** Tauchpumpe

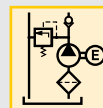

 Important

**WER series pumps use the VE-series valves shown on page 146. WER-13 series uses VEF-series valve. WER-14 series uses VEC-series valve.**

**WES series pumps use IC-51 pressure switch, adjustable from 3000-7500 psi.**

**WET series pumps use IC-31 pressure switch, adjustable from 500-3500 psi.**



Shown: ZW5020HB-FT21



## The standard for workholding applications

- Features Z-Class high-efficiency pump design; higher oil flow and by-pass pressure, cooler running and requires 18% less current than comparable pumps
- Totally enclosed, fan cooled industrial electric motors supply extended life and stand up to harsh industrial environments
- Multiple valve and reservoir configurations provide application specific models to match the most demanding workholding applications
- High-strength, molded electrical enclosure protects electronics, power supplies and LCD readout from coolant and contamination

**Z-Class electric pumps are designed for use in the harshest manufacturing environments. The pumps provide reliable and durable performance in a wide variety of configurations.**

### Basic configurations

All pumps listed in this chart include LCD electrical box, 5 gallon reservoir, return line filter and either 0-6000 psi pressure gauge or pressure transducer (solenoid valve models). For additional options, see the complete pump matrix on page 117.

	Pump type	Valve/manifold type	Motor voltage
			50/60 Hz
<b>ZW-Series with manifold</b> <ul style="list-style-type: none"> <li>• Used when supplying pressure to multiple valve circuits</li> <li>• Valves must be supplied separately</li> </ul>		Pressure and tank ports	230 VAC, 3 ph
		Single station DO3	230 VAC, 3 ph
		Enerpac VP-series	230 VAC, 3 ph
		Two station DO3	230 VAC, 3 ph
		Four station DO3	230 VAC, 3 ph
<b>ZW-Series with pallet coupling valve</b> <ul style="list-style-type: none"> <li>• Provides momentary pressure and flow to fixture</li> <li>• Ideal for pallet disconnect systems</li> </ul>		4-way, 3-pos. solenoid operated	115 VAC, 1 ph
		4-way, 3-pos. solenoid operated	230 VAC, 3 ph
		4-way, 3-pos. solenoid operated	460 VAC, 3 ph
<b>ZW-Series with continuous connection valve</b> <ul style="list-style-type: none"> <li>• Provides solenoid control of one single or double-acting circuit</li> <li>• Control valve supplied with integrated pilot operated check to ensure positive pressure holding</li> </ul>		4-way, 3-pos. solenoid operated	115 VAC, 1 ph
		4-way, 3-pos. solenoid operated	230 VAC, 3 ph
		4-way, 3-pos. solenoid operated	460 VAC, 3 ph
<b>ZW-Series with manual valve</b> <ul style="list-style-type: none"> <li>• Provides manual control of one single or double-acting circuit</li> <li>• Control valve supplied with center holding function to ensure positive position holding</li> </ul>		4-way, 3-pos. manually operated	115 VAC, 1 ph
		4-way, 3-pos. manually operated	230 VAC, 3 ph
		4-way, 3-pos. manually operated	460 VAC, 3 ph

## Output oil flow and current draw

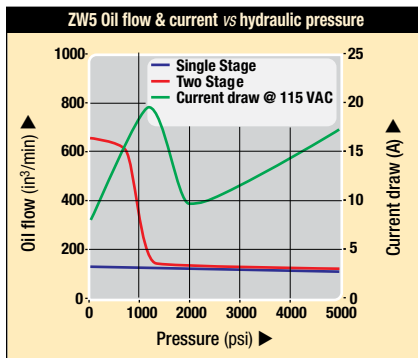
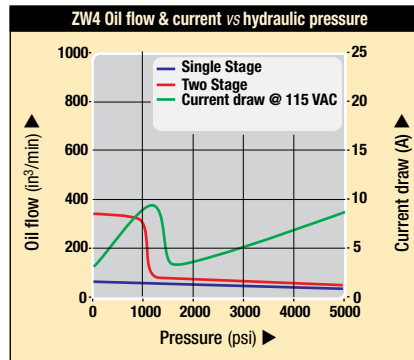
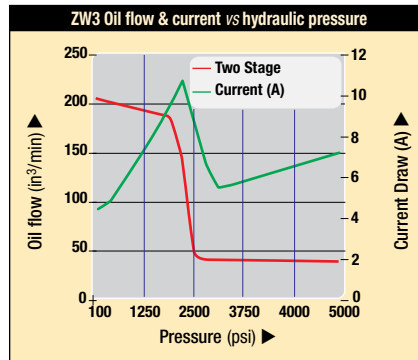

**ZW3 Series**  
Output oil flow at 5000  
psi 40 in<sup>3</sup>/min

LCD Electric Model Number

ZW3020HG-FG01  
ZW3020HG-FG11  
ZW3020HG-FG12  
ZW3020HG-FG21  
ZW3020HG-FG41

ZW3420DB-FT  
ZW3420DG-FT  
ZW3420DJ-FT

ZW3420FB-FT  
ZW3420FG-FT  
ZW3420FJ-FT

ZW3420LB-FG  
ZW3420LG-FG  
ZW3420LJ-FG

**ZW4 Series**  
Output oil flow at 5000  
psi 60 in<sup>3</sup>/min

LCD Electric Model Number

ZW4020HG-FG01  
ZW4020HG-FG11  
ZW4020HG-FG12  
ZW4020HG-FG21  
ZW4020HG-FG41

ZW4420DB-FT  
ZW4420DG-FT  
ZW4420DJ-FT

ZW4420FB-FT  
ZW4420FG-FT  
ZW4420FJ-FT

ZW4420LB-FG  
ZW4420LG-FG  
ZW4420LJ-FG

**ZW5 Series**  
Output oil flow at 5000  
psi 120 in<sup>3</sup>/min

LCD Electric Model Number

ZW5020HG-FG01  
ZW5020HG-FG11  
ZW5020HG-FG12  
ZW5020HG-FG21  
ZW5020HG-FG41

ZW5420DB-FT  
ZW5420DG-FT  
ZW5420DJ-FT

ZW5420FB-FT  
ZW5420FG-FT  
ZW5420FJ-FT

ZW5420LB-FG  
ZW5420LG-FG  
ZW5420LJ-FG

Flow rate: 40-120 in<sup>3</sup>/min

Pressure: 5000 psi max

Motor: 1.0 & 1.5 hp

Reservoir: 2-10 gal

- E** Bombas eléctricas
- F** Centrale hydraulique
- D** Tauchpumpe

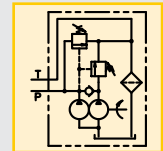
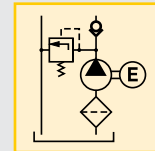

### Important

All Z-Class electric pumps are CSA and CE compliant.



LCD electrical package is required for pumps utilizing electric valves, or optional accessories such as the pressure transducer, level switch, pressure switch or heat exchanger.

Single-stage pumps provide constant flow throughout the entire pressure range via a radial piston pump. Two-stage pumps provide high flow via a gear pump until the bypass pressure is reached. At pressures above the bypass setting, the radial piston pump provides flow to the maximum pressure.



## Custom build your pump

▼ This is how a ZW series Model number is built:

<b>Z</b>	<b>W</b>	<b>4</b>	<b>0</b>	<b>20</b>	<b>H</b>	<b>G</b>	<b>-FG</b>	<b>01</b>
1	2	3	4	5	6	7	8	9
Product Type	Motor Type	Flow Group	Valve Type	Usable Oil Capacity	Valve Operation	Voltage	Options	Manifold Options

### 1 Product type

**Z** = Z-Class Pump

### 2 Motor type

**W** = Workholding Electric

### 3 Flow group

**3** = 40 in<sup>3</sup>/min

**4** = 60 in<sup>3</sup>/min

**5** = 120 in<sup>3</sup>/min

### 4 Valve type

**0** = No valve or valve manifold

**2** = 3-way, 2-position, manual valve

**3** = 3-way, 3-position, manual valve

**4** = 4-way, 3-position, manual or solenoid valve

**6** = 3-way, 3-position, tandem center w/P.O. check (manual only)

**8** = 4-way, 3-position, tandem center w/P.O. check (manual only)

### 5 Usable oil capacity

**8** = 8 Liters (2 gallon)

**10** = 10 Liters (2.5 gallon)

**20** = 20 Liters (5 gallon)

**40** = 40 Liters (10 gallon)

### 6 Valve operation

**D** = Solenoid valve (pallet coupling) with pendant and LCD (valve type **4**)

**F** = Solenoid valve (continuous connection) with pendant and LCD (valve type **4**)

**G** = Valve manifold without LCD (valve type **0**)

**H** = Valve manifold with LCD (valve type **0**)

**L** = Manual valve with LCD (without pendant, valve type **2, 3, 4, 6** or **8**)

**M** = Manual valve without LCD (valve type **2, 3, 4, 6** or **8**)

**N** = No valve, without LCD (valve type **0**)

**W** = No valve with LCD (valve type **0**)

### 7 Power supply

Single Phase

**B** = 115V, 1 ph, 50-60 Hz<sup>3</sup>

**E** = 208-240V, 1 ph, 50-60 Hz  
European plug

**I** = 208-240V, 1 ph, 50-60 Hz  
USA plug

Three Phase

**M** = 190-200V, 3 ph, 50/60 Hz

**G** = 208-240V, 3 ph, 50/60 Hz

**W** = 380-415V, 3 ph, 50/60 Hz

**K** = 440V, 3 ph, 50/60 Hz

**J** = 460-480V, 3 ph, 50/60 Hz

**R** = 575V, 3 ph, 50/60 Hz

### 8 Options<sup>2</sup>

**F** = Return line filter, 25 micron

**G** = 0-6000 psi pressure gauge, 21/2"<sup>5</sup>

**H** = Heat exchanger<sup>4</sup>

**L** = Level/temperature switch<sup>4</sup>

**N** = No handles (lifting eyes only)<sup>2</sup>

**P** = Pressure switch<sup>4</sup>

**R** = Roll bars

**S** = Single stage

**T** = Pressure transducer<sup>4</sup>

**U** = Foot switch<sup>4</sup>

### 9 Manifold options<sup>5</sup> (Pump types G and H only)

**01** = Pressure & tank porting manifold

**11** = Single station D03

**12** = VP series manifold

**13** = Single station CETOP

**21** = 2 station D03

**22** = 2 station CETOP

**41** = 4 station D03

**42** = 4 station CETOP

<sup>1</sup> Options should be specified in alphabetical order.

<sup>2</sup> Unless specified, all pumps are supplied with reservoir handles.

<sup>3</sup> 115 volt pumps are supplied with CE and CSA approved 15 amp plug for intermittent use. 20 A circuit recommended for frequent full pressure use.

<sup>4</sup> These options require LCD electrical package.

<sup>5</sup> Pressure gauge not available on pump models with pressure transducer. Pressure transducer provides digital pressure readout on LCD display.

<sup>6</sup> Pressure switch option is only used as input to a customer control. It is not used with the LCD electrical package.

Flow: 40-120 in<sup>3</sup>/min

Pressure: 5000 psi max

Motor: 1.0 & 1.5 hp

Reservoir: 2.0-10 gal.

**E** Bombas eléctricas

**F** Centrale hydraulique

**D** Modulare Spannumpme

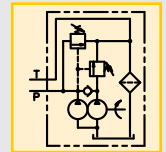
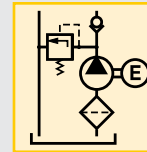

## Example

**ZW4020GB-FGS21** is a 60 in<sup>3</sup>/min, single-stage pump with a 2 station D03 manifold, standard electric without LCD, 5 gallon reservoir, 115 volt, 50/60 Hz motor, return line filter and 0-6000 psi pressure gauge.

**ZW4410DJ-T** is a 60 in<sup>3</sup>/min, 2-stage pump with a pallet de-coupling valve, LCD electrical box, 2.5 gallon reservoir, 460-480 volt 3-phase motor and pressure transducer.

**ZW5040HJ-FGL01** is a 120 in<sup>3</sup>/min, 2-stage pump with a pressure and tank manifold, LCD electrical box, 10 gallon reservoir, 460-480 volt 3-phase motor, return line filter, 0-6000 psi pressure gauge and level and temperature shutdown switch.

## Example

The **ZW5810LG-FT** is a 120 in<sup>3</sup>/min, 2-stage pump with a manual 4-way, 3 position tandem center valve, integrated P.O. check, LCD electrical box, 2.5 gallon reservoir, 208-240 volt 3-phase motor, return line filter and pressure transducer.

Shown: ZPF



### ZPF series

The oil filter kit removes contaminants from the return oil flow before allowing it back into the reservoir, reducing component damage.

## Extend life of hydraulic components

...increase system reliability

- 25 micron nominal filter cleans oil to increase system life
- Internal bypass valve to prevent damage if the filter is dirty
- All installation components included
- Kit assembles quickly and easily to Enerpac pump and manifold
- Maintenance indicator included

Filtration: 25 micron

Pressure: max. 200 psi

Max. flow: 12.0 GPM

**E** Filtro

**F** Filtre

**D** Filter

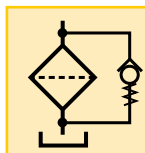

### Options

PF-25 replacement filter element



For best performance, replace filter element on a regular basis. Change filters when changing oil or four times a year, whichever comes first.

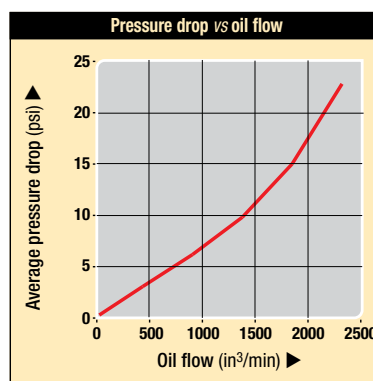

### Product selection

Nominal filtration	Model number	Maximum pressure	Maximum oil flow	Bypass pressure setting	Filter gauge service indicator	
micron		psi	gpm	psi		lbs
25	<b>ZPF</b>	200	12.0	25	✓	3.2

Collet-Lok® product line  
 Swing clamps  
 Work supports  
 Linear clamps  
 Power sources

**Transfer: 900 Btu/h**

**Pressure: max. 300 psi**

**Voltage: 24V**

- E** Intercambiador de calor
- F** Échangeur de chaleur
- D** Wärmetauscher

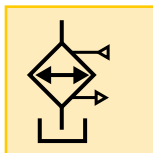

## Extends system life

- Electrical connector factory installed
- All installation components included
- Stabilizes oil temperature at a maximum of 130° F at 70° F ambient temperature
- Stabilizes oil viscosity, increasing oil life and reduces wear of pump and other hydraulic components

Shown: ZHE-E10



### ZHE series

Heat exchanger removes heat from the return oil to provide cooler operation.

### Important

#### ZHE- Series Heat Exchangers

Heat exchanger stabilizes oil temperature at 130° F at 70° F ambient temperature. Thermal transfer at 5 GPM and 70° F ambient temperature: 900 Btu/hour.

**Do not exceed maximum oil flow of 7.0 GPM and maximum pressure of 300 psi. Not suitable for water-glycol or high water based fluids.**

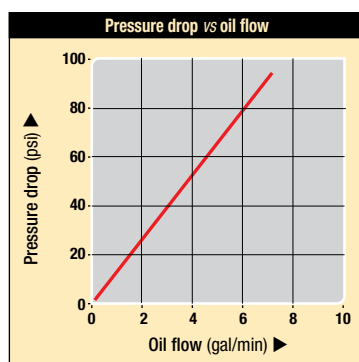

## Product selection

Voltage	Model number	Thermal transfer*		Amperage draw	Maximum pressure	Maximum oil flow	
		Btu/h	kJoule				
24 VDC	<b>ZHE-E10</b>	900	950	.95	300	7.0	9.0

\*At 0.5 g/min and ambient temperature of 70° F.



Shown: ZLS-U4



## ZLS series

Oil level indicator for pump reservoir. If the pump is mounted in a remote area that does not provide visual access to the external oil level sight glass, the level/temp switch will turn off the pump before internal damage can occur due to cavitations.

## Electronic level/temp switch for feedback on pump oil level

- Drop-in design allows for easy installation to pump reservoir
- Electrical connector included
- Built-in thermal sensing provides feedback on oil temperature
- Senses low oil level in pump reservoir

Temp. set point: 175 °F

Voltage: 24 VDC

- (E) Indicador del nivel/temp.
- (F) Interrupteur de niveau/temp.
- (D) Ölstand/Temperaturschalter



## Product Selection

Fixed temperature signal	Model number	Voltage	Thermostat rating setting	Maximum pressure	
°F			Amps	psi	lbs
175	ZLS-U4	24 VDC	2.6	150	0.11

Shown: ZPT-U4, ZPS-W4



## ZPT/ZPS series

ZPT pressure transducer provides constant pressure monitoring for automated pump control. ZPS can be used to provide a pressure signal to an external control.

## Control your pump, monitor pressure

### ZPT pressure transducer

- More durable than analog gauges (against mechanical and hydraulic shock)
- More accurate than analog gauges (0.5% full scale)
- Calibration can be fine tuned for certification
- “Auto-mode” provides automatic pressure make-up
- Display pressure in psi, bar or MPa

### ZPS-E3 pressure switch

- Includes glycerin filled gauge, G2536L
- Can be used to provide pressure input to customer provided controls
- Not to be used with LCD control
- For pressure based input to the LCD control, use the ZPT-U4 transducer

Pressure: 50-10,000 psi

Voltage: 115 VAC / 24 VDC

- (E) Presión transductor
- (F) Pressostats
- (D) Druckschalter

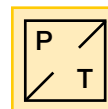
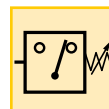

## Product Selection

Adjustable pressure range	Electrical specification	Model number	Accuracy (full scale)	Deadband	
psi				psi	lbs
50-10,000	4-20 mA	ZPT-U4	0.5%	50	0.3
500-10,000	115 VAC/ 24 VDC N.O.	ZPS-W4	2%	115-550	2.7

▼ Mechanical adjustment

Note: Electrical harness included with kit. ZPS-W4 includes 0-6000 psi pressure gauge.

## Important

The pressure transducer is factory installed in the “A” port on pumps supplied with valves, and in the “P” port on models with manifolds.

**Pressure: 5000 psi**

**Stations: 1-4 valves horizontal**

**Stations: 1-8 valves vertical**

- E** Colectores
- F** Manifolds
- D** Verkettungsblöcke

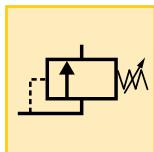

## Increased flexibility for complex systems

- Manifolds provide hydraulic connection to remote or pump mounted valves
- Used when multiple valves are required for controlling several independent circuits
- Available for 2 and 4 station DO3 as well as Enerpac VP series mounting
- Pressure and tank porting manifold available for use with remote valve sticks
- Manifolds include integrated relief valve for system pressure control

Shown: MB-2, -4



**▶** Manifolds allow the use of multiple valves powered by a single hydraulic pump. Manifolds are available factory installed on your Z-Class workholding power unit, or separately for future system upgrades.

### Option 01

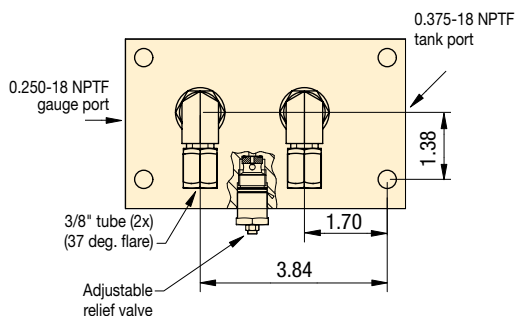

### Option 12

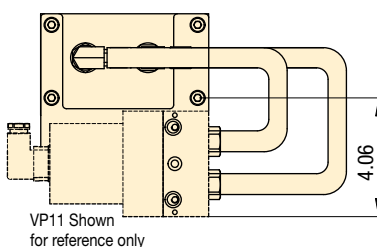

### Option 21, 41

VMMD-001 Shown for reference only

Option 21 has two valve stations  
Option 41 has four valve stations

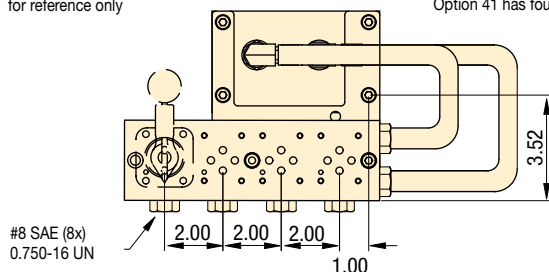

## Product Selection

Valve mounting pattern	Option code (see page 117)	Number of stations	Coverplate model number
Porting manifold, SAE ports	01	-	-
Enerpac VP Series	12	1-8	-
2 station DO3	21	2	MC-1
4 station DO3	41	4	MC-1
2 station CETOP3	22	2	MC-3
4 station CETOP3	42	4	MC-3

## Options

**Pressure transducer**

▶120▶



**Level switch**

▶120▶



■ *Enerpac porting manifold provides pressure and tank line to remote mounted valve stack on a machining center.*



Shown: ZW4420DB-FT



**The new Enerpac Pallet Coupling Pump provides three modes of operation:**

### Manual mode

Pump runs as long as operator holds down pendant button.

### AUTO mode *without timer*

Pump runs until user-adjustable pressure setting is reached.

### AUTO mode *with timer*

Pump runs until pressure setting is reached, and adjustable timer runs out.

## Automatic pressure control for palletized fixtures

- Programmable clamp and unclamp pressure settings increase automation capability
- Programmable dwell settings ensure desired pressure level is maintained on large circuits or circuits with accumulators
- Low-voltage pendant features sealed switches and operates at 15 VDC for improved operator safety
- Backlit LCD provides pump usage information, hour and cycle counts

## Example Circuits

- Double-acting circuit

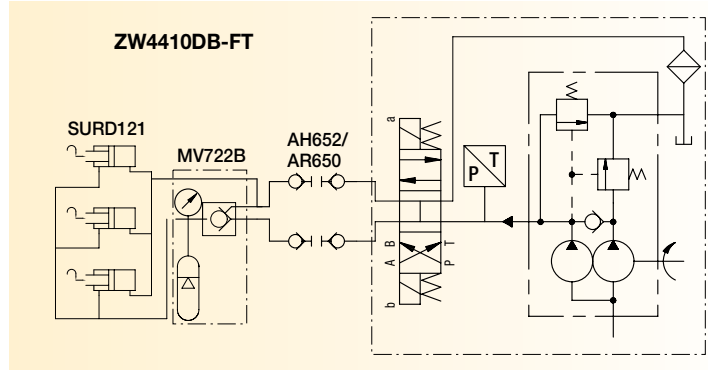

- Single-acting circuit

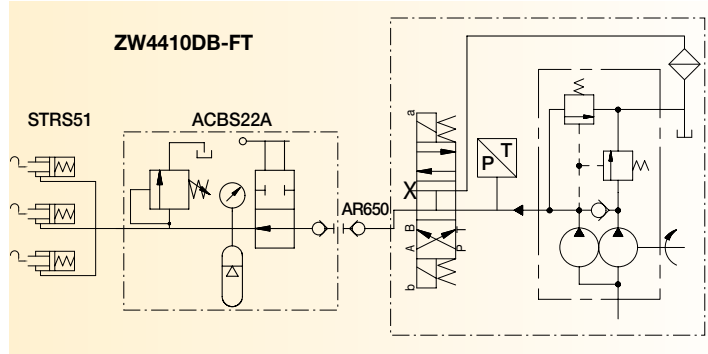

■ **ZW5410DB-FT** used to connect and disconnect a palletized fixture.

## Product selection

Output flow rate @ max. pressure	Motor size	Motor voltage	Model number	Pressure range	Sound level	Usable oil capacity	
						gal	lbs
in <sup>3</sup> /min	hp			psi	dBA		
40	1.0	115-1-60	<b>ZW3408DB-FT</b>	1000-5000	75	2	115
		115-1-60	<b>ZW3410DB-FT</b>				
		230-1-60	<b>ZW3408DI-FT</b>				
		230-1-60	<b>ZW3410DI-FT</b>				
60	1.0	115-1-60	<b>ZW4410DB-FT</b>	1000-5000	75	2.5	120
		230-3-60	<b>ZW4410DG-FT</b>				
		460-3-60	<b>ZW4410DJ-FT</b>				
120	1.5	115-1-60	<b>ZW5410DB-FT</b>	1000-5000	75	2.5	130
		230-3-60	<b>ZW5410DG-FT</b>				
		460-3-60	<b>ZW5410DJ-FT</b>				



Collet-Lok® product line  
Swing clamps  
Work supports  
Linear clamps  
Power sources

## **i** Operation – pallet coupling pump

### Manual mode

Motor and pump operate only when operator presses and holds the up (or down) arrow on the pendant. When button is released, pressure in the hoses is relieved.

### AUTO mode

With DWELL timer set equal to zero, operator starts the motor by pressing and holding the up (or down) arrow on the pendant. Pump builds to pressure on the clamp (or unclamp) circuit until it reaches customer programmed setting. The motor immediately turns off and pressure in the hoses is relieved.

With DWELL timer set greater than zero, operator starts the motor by pressing the up (or down) arrow on the pendant. Once the pump reaches the programmed setting, the DWELL timer starts. When the timer runs out, the motor stops and pressure in the hoses is relieved.

Flow: 40-120 in<sup>3</sup>/min

Pressure: 5000 psi max

Motor: 1.0 or 1.5 hp

Reservoir: 2.0-10.0 gal

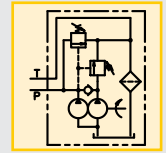
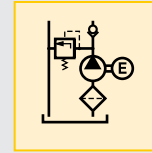

## **i** Output oil flow and current draw

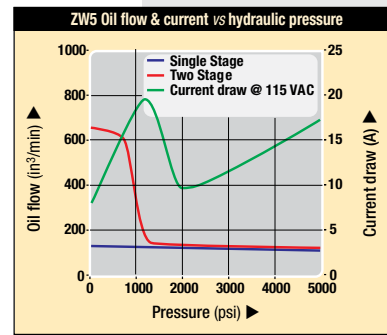
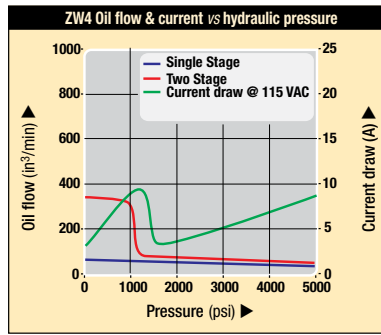
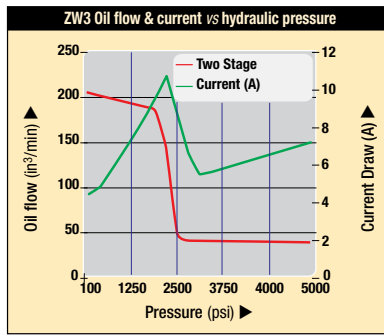

2.5, 5, 10 gallon

2 gallon

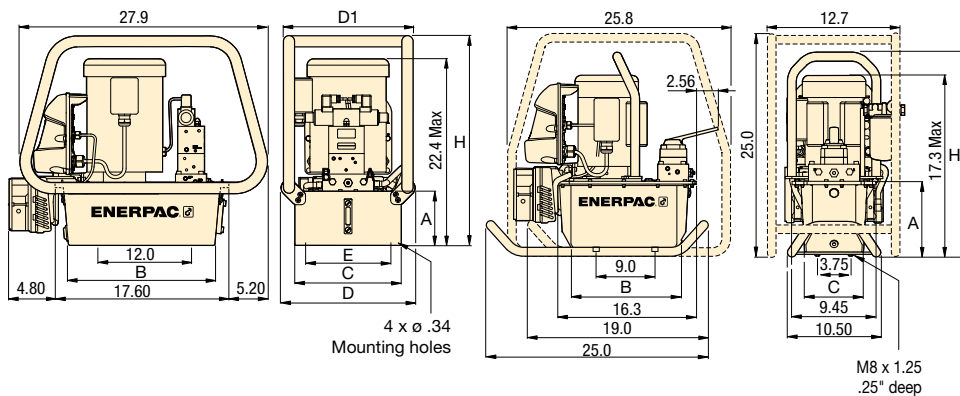

## **!** Important

Enerpac recommends a pressure differential of no less than 200 psi for most applications. If you believe your application requires a tighter differential, please contact us directly.

For complete ordering matrix of all factory-installed options see page 117.

## **A** Product dimensions in inches [ ]

Usable oil capacity	Modelo number	A	B	C	D	D1	E	H	lbs		
									ZW3	ZW4	ZW5
gal											
2.0	ZWxx08xx	8.1	11.0	8.1	—	—	—	22.6	93	93	103
2.5	ZWxx10xx	6.1	16.5	12.0	15.1	14.6	11.0	23.6	107	107	115
5.0	ZWxx20xx	7.1	16.5	16.6	19.7	19.2	15.6	24.6	134	134	142
10.0	ZWxx40xx	10.6	15.7	19.9	22.7	22.5	18.9	28.1	184	184	192

## **i** Options

Heat exchanger

119 ▶



Level switch

120 ▶



Pressure transducer

120 ▶



Return line filter

118 ▶





# Continuous connection pumps *Application & selection*

Shown: ZW4420FB-FT



**The new Enerpac Continuous Connection Pump provides two modes of operation:**

### Manual mode

Pump runs continuously, building pressure as long as operator holds down pendant button.

### AUTO mode

Pump runs continuously, maintaining user-set pressure window on clamp circuit as long as necessary.

## Automatic pressure control for continuous connection fixtures

- Programmable pressure setting allows pump to maintain system pressure continuously
- Includes pilot operated check valve ensuring pressure is maintained in circuit
- Z-Class high-efficiency pump design; featuring higher oil flow and by-pass pressure than comparable pumps
- High-strength, molded electrical enclosure protects electronics, power supplies and LCD readout from harsh industrial environments

## Example Circuits

- Double-acting circuit

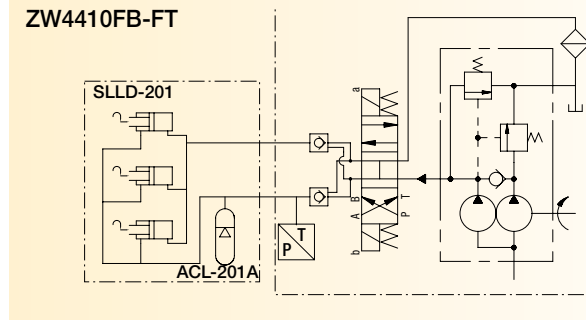

- Single-acting circuit

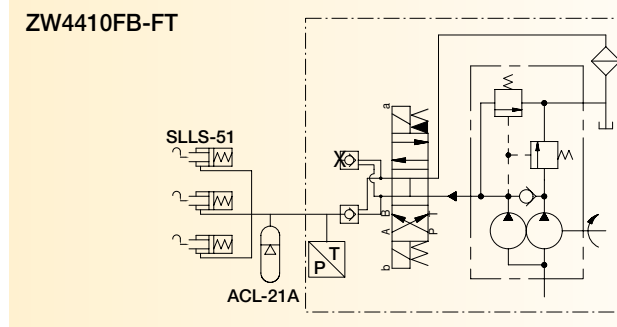

■ **ZW5410FB-FT** used to control clamping cycle on a horizontal machining center.



## Product selection

Output flow rate @ max. pressure	Motor size	Motor voltage	Model number	Pressure range	Sound level	Usable oil capacity	
						gal	lbs
in <sup>3</sup> /min	hp			psi	dBA		
40	1.0	115-1-60	<b>ZW3408FB-FT</b>	1000-5000	75	2	115
		115-1-60	<b>ZW3410FB-FT</b>				
		230-1-60	<b>ZW3408FI-FT</b>				
		230-1-60	<b>ZW3410FI-FT</b>				
60	1.0	115-1-60	<b>ZW4410FB-FT</b>	1000-5000	75	2.5	120
		230-3-60	<b>ZW4410FG-FT</b>				
		460-3-60	<b>ZW4410FJ-FT</b>				
120	1.5	115-1-60	<b>ZW5410FB-FT</b>	1000-5000	75	2.5	130
		230-3-60	<b>ZW5410FG-FT</b>				
		460-3-60	<b>ZW5410FJ-FT</b>				

## **i** Operation – continuous connection pump

### Manual mode

The operator turns the pump motor on, and then presses and holds the up arrow on the pendant. When the button is released, the valve shifts to neutral, but pressure is maintained in the clamp circuit by the pilot-operated check valve. When the operator presses and holds the down arrow on the pendant, pressure in the clamp circuit will release, and the fixture will unclamp.

### AUTO mode

The operator turns the pump motor on, and then presses and holds the up arrow on the pendant. When the customer-programmed HI PRESS setting is reached, the valve shifts to neutral, but pressure is maintained in the clamp circuit by the pilot-operated check valve. If pressure drops below the LO PRESS setting, the valve will re-activate and build pressure in the clamp circuit again. The pump will maintain this cycle until the operator presses and holds the down arrow on the pendant. When the down arrow is pressed, pressure in the clamp circuit will release, and the fixture will unclamp.

Flow: 40-120 in<sup>3</sup>/min

Pressure: 5000 psi max

Motor: 1.0 or 1.5 hp

Reservoir: 2.0-10.0 gal

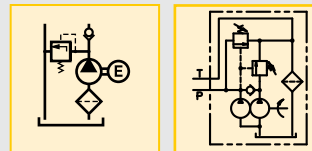

## **i** Output oil flow and current draw

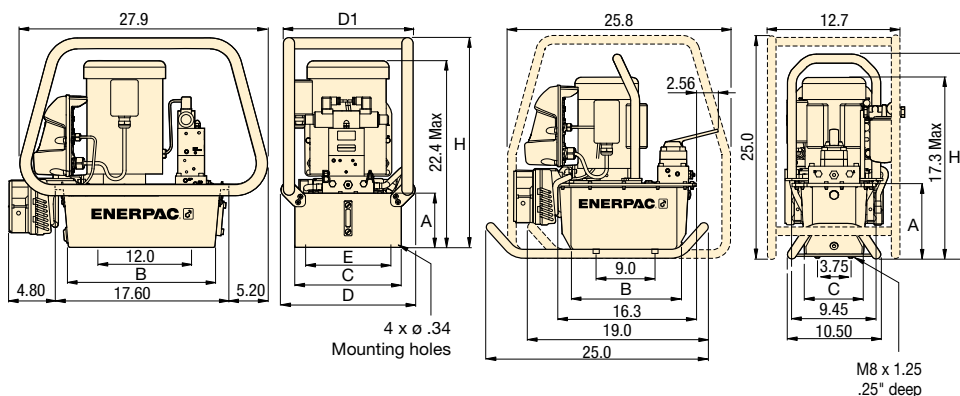
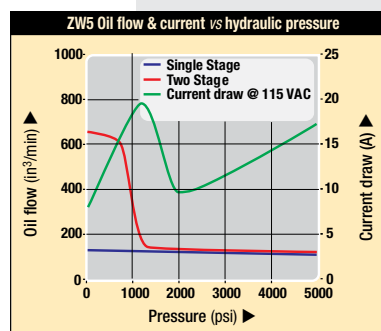
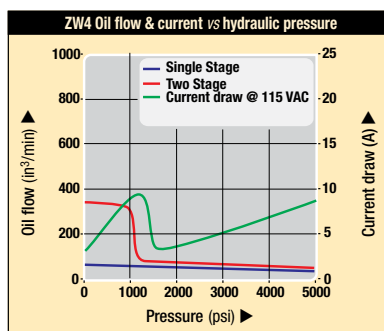
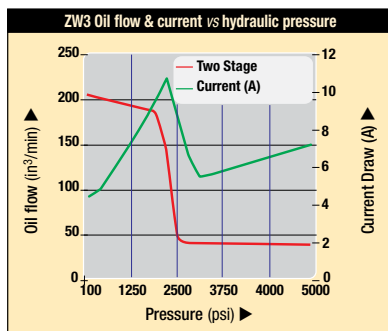

## **!** Important

Enerpac recommends a pressure differential of no less than 200 psi for most applications. If you believe your application requires a tighter differential, please contact us directly.

For complete ordering matrix of all factory-installed options see page 117.

## **A** Product dimensions in inches [ ]

Usable oil capacity	Modelo number	A	B	C	D	D1	E	H	lbs		
									ZW3	ZW4	ZW5
gal											
2.0	ZWxx08xx	8.1	11.0	8.1	—	—	—	22.6	93	93	103
2.5	ZWxx10xx	6.1	16.5	12.0	15.1	14.6	11.0	23.6	107	107	115
5.0	ZWxx20xx	7.1	16.5	16.6	19.7	19.2	15.6	24.6	134	134	142
10.0	ZWxx40xx	10.6	15.7	19.9	22.7	22.5	18.9	28.1	184	184	192



Shown: ZW4010GB-11



## Industry standard mounting for electric or manual valves

- Highly efficient design provides increased flow rates, reduced heat generation and a decrease in power consumption
- Extensive list of accessories including
  - Heat exchanger
  - Roll-bars
  - Pressure transducer
  - Level and temperature switches
- Replaceable piston check-valves increase service life of major pump components
- Optional backlit LCD provides pump usage information, hour and cycle counts
- Also available with 2 station and 4 station manifolds

Pump accepts any industry standard D03 style directional valve. Also available with 2 station and 4 station manifolds.

## Important

Be aware of leakage rates of any valve installed on an Enerpac pump. Many standard spool valves have excessive leakage rates at higher pressures that can limit the performance of the electric pump. Be sure to consult Enerpac if you are unsure of your choice of valve.

■ **ZW5020HB-F11** with customer installed valve used to provide pressure to a clamping fixture.



## Product selection

Output flow rate @ max. pressure	Motor size	Motor voltage	Model number	Pressure range	Sound level	Usable oil capacity	
in <sup>3</sup> /min	hp			psi	dBA	gal	lbs
40	1.0	115-1-60	<b>ZW3008GB-11</b>	1000-5000	75	2	115
		115-1-60	<b>ZW3010GB-11</b>		75	2.5	134
		230-1-60	<b>ZW3008GI-11</b>		75	2	115
		230-1-60	<b>ZW3010GI-11</b>		75	2.5	134
60	1.0	115-1-60	<b>ZW4010GB-11</b>	1000-5000	75	2.5	120
		230-3-60	<b>ZW4010GG-11</b>				
		460-3-60	<b>ZW4010GJ-11</b>				
120	1.5	115-1-60	<b>ZW5010GB-11</b>	1000-5000	75	2.5	130
		230-3-60	<b>ZW5010GG-11</b>				
		460-3-60	<b>ZW5010GJ-11</b>				

Collet-Lok® product line  
 Swing clamps  
 Work supports  
 Linear clamps  
 Power sources

### **i** Operation – single station D03 pumps

The Single Station D03 pumps are supplied without the standard LCD electrical control. This configuration is intended to be used with user supplied controls. Control requirements include: Motor Starter or Contactor, and remote control of the pump mounted valve. Typical applications include: Special Machines and CNC Machines where the control of the pump and valve will be done by PLC or machine control.

The use of the ZPF Return Line Filter is recommended. If the pump is to be run at pressure at a relief valve setting, the ZHE-E10 Heat Exchanger is also recommended. For monitoring of the oil level and temperature, use the ZLS-U4 Level/Temp Switch. For pump shutdown at pressure, the ZPS-W4 Pressure Switch Kit can provide an input to the customer supplied controls. As these accessories are designed to be used with the standard Enerpac LCD control, the customer assumes responsibility to adapt the standard leads to their controls.

**Flow: 40-120 in<sup>3</sup>/min**

**Pressure: 5000 psi max**

**Motor: 1.0 or 1.5 hp**

**Reservoir: 2.0-10.0 gal**

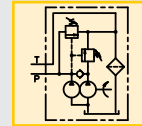
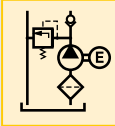

### **!** Important

**Enerpac recommends a pressure differential of no less than 200 psi for most applications. If you believe your application requires a tighter differential, please contact us directly.**

**For complete ordering matrix of all factory-installed options see page 117.**

### **i** Output oil flow and current draw

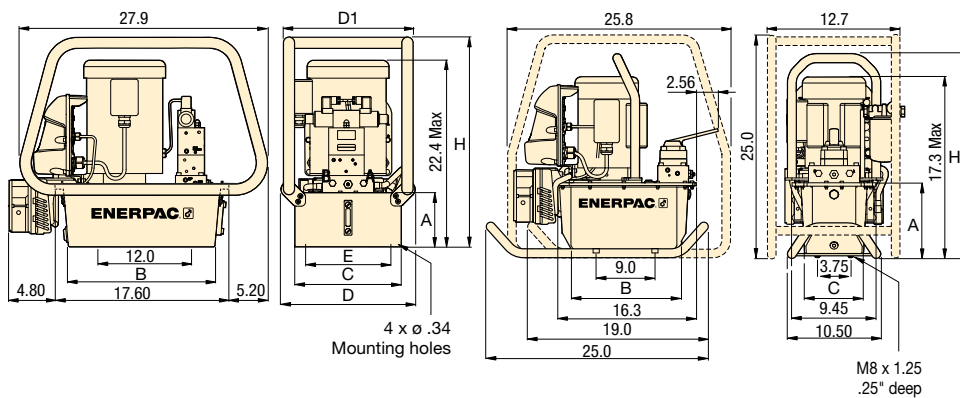
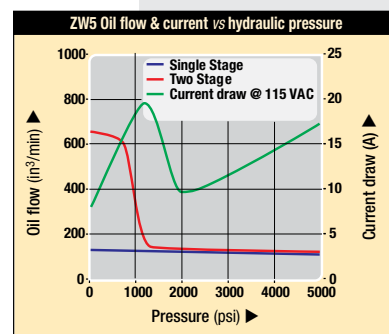
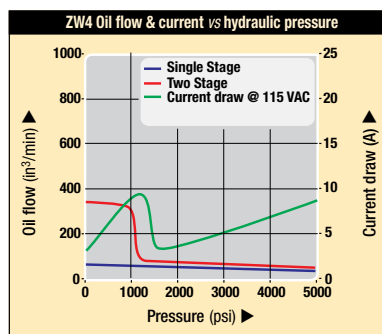
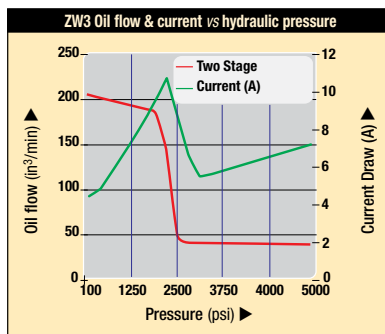

### **i** Options

**Heat exchanger**  [119](#)

**Level switch**  [120](#)

**Pressure transducer**  [120](#)

**Return-line filter**  [118](#)

**VP03 solenoid valves**  [141](#)

**VMM series manual valves**  [143](#)

### **A** Product dimensions in inches [ ]

Usable oil capacity	Modelo number	A	B	C	D	D1	E	H	lbs		
									ZW3	ZW4	ZW5
gal											
2.0	ZWxx08xx	8.1	11.0	8.1	—	—	—	22.6	93	93	103
2.5	ZWxx10xx	6.1	16.5	12.0	15.1	14.6	11.0	23.6	107	107	115
5.0	ZWxx20xx	7.1	16.5	16.6	19.7	19.2	15.6	24.6	134	134	142
10.0	ZWxx40xx	10.6	15.7	19.9	22.7	22.5	18.9	28.1	184	184	192

Shown: ZW5111SWE100



▶ Enerpac's workholding pump unit features an innovative range of zero leakage, poppet design, directional valves. With the modular valve design, various independent single-acting or double-acting circuits can be realized.

## Application

These advanced workholding pumps, operating at maximum 5000 psi hydraulic pressure, are highly suitable for production tooling applications – offering the optimum in terms of compact size for required oil flow and pressure rating and customization to your specific needs.

Enerpac electric pump used in conjunction with swing cylinders, work supports, directional valves, control valves and sequence valves can provide a complete clamping solution. The pressure switch allows the unit to be fully automated.

## Customize to your needs

- Various models including electric controls and pressure switch
- Stackable to 8 VP-series valve stations high
- Customer adjustable relief valve
- Glycerine dampened pressure gauge G-2517L on pumps with VP-series valves
- 230/460/3/50/60 Hz 1.5 hp motor

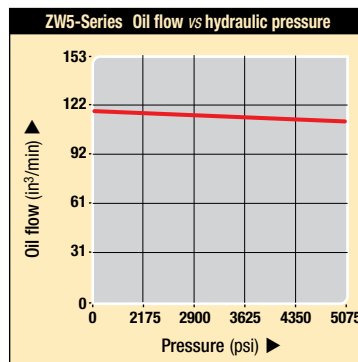

## Product selection

Oil flow rate	Pressure range	Voltage and current	Usable oil capacity <sup>2)</sup>	Valve models included	Model number	lbs
in <sup>3</sup> /min	psi	V @ A	gal.			
<b>▼ With manifold for VP-series modular valves, no electric controls</b>						
120	1450-5000	230 @ 4.8	2.5	–	ZW5VPSEE100	143
120	1450-5000	460 @ 2.4	2.5	–	ZW5VPSJE100	143
<b>▼ With manifold for CETOP 03 valves, no electric controls</b>						
120	1450-5000	230 @ 4.8	2.5	–	ZW5C03SEE100	143
120	1450-5000	460 @ 2.4	2.5	–	ZW5C03SJE100	143
<b>▼ For 2x single-acting circuits</b>						
120	1450-5000	230 @ 4.8	2.5	1x VP-41	ZW5141SEE100	170
120	1450-5000	460 @ 2.4	2.5	1x VP-41	ZW5141SJE100	170
<b>▼ For 1x double-acting circuits + isolating valve <sup>1)</sup> for A-port</b>						
120	1450-5000	230 @ 4.8	2.5	1x VP-11	ZW5111SEE100	170
120	1450-5000	460 @ 2.4	2.5	1x VP-11	ZW5111SJE100	170
<b>▼ For 2x double-acting circuits + isolating valves <sup>1)</sup> for all A-ports</b>						
120	1450-5000	230 @ 4.8	2.5	2x VP-11	ZW5211SEE100	176
120	1450-5000	460 @ 2.4	2.5	2x VP-11	ZW5211SJE100	176

<sup>1)</sup> Isolating valve is pressure switch PSCK-8.

<sup>2)</sup> ZW5-series pumps comes standard with 2 gallon reservoir. (1, 2, 5 or 10 gallon reservoir is optional).

**ZW5-series** Shown: ZW5211SEE100 with standard 10 litres reservoir

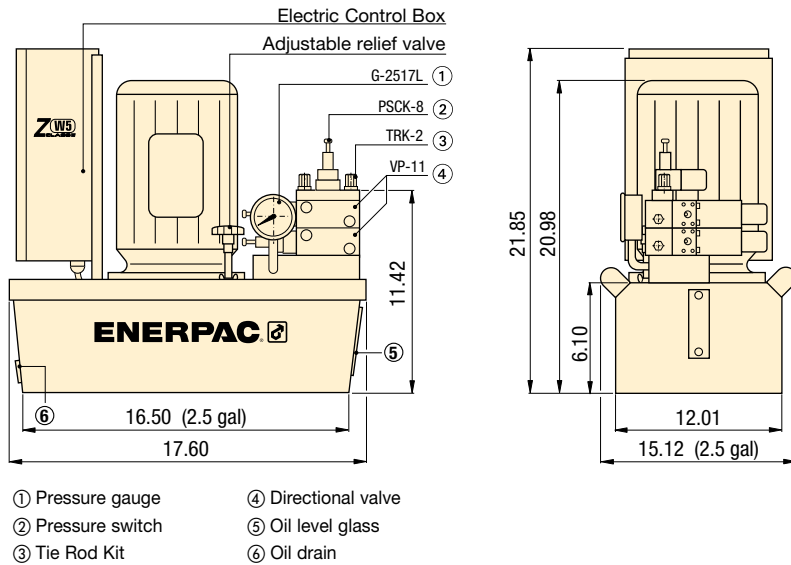

- Flow:** 120 in<sup>3</sup>/min
- Pressure:** 1450-5000 psi
- Motor:** 1.5 hp
- Reservoir:** 1-10 gallon

- (E)** Bombas eléctricas
- (F)** Centrale hydraulique
- (D)** Modulare Spannumppe

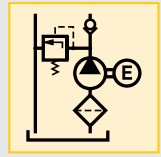

**Options**

**VP-series, modular valves**  
  
 136 ▶

**VFC-3 flow control valve (VP series)**  
  
 137

**Pressure switches**  
  
 188 ▶

**Hoses and couplers**  
  
 192 ▶

**High-pressure filters**  
  
 193 ▶

**Fittings**  
  
 194 ▶

**Product selection**

Pump series	Voltage	Phase	Continuous operation at 5000 psi	Motor capacity	Motor speed	Motor protection class	Sound Level
	Volt			hp	RPM		dBa
ZW5....	230	1	50%	1.5	1725	IP54	75
ZW5.....	460	3	50%	1.5	1725	IP54	75

**Valve options**

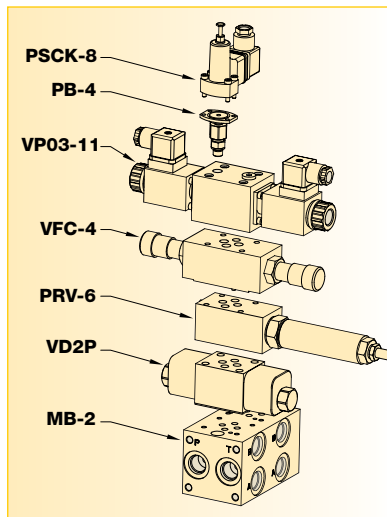
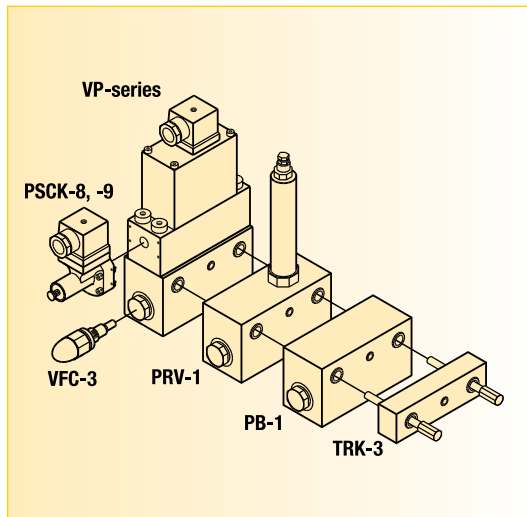

See page 136 for VP-series valves and available options.

See page 141 for VP03-series valves and available options.

Power Sources  
Valves  
Pallet Components  
System Components  
Yellow pages

Shown: ZW5111SWE100



## ZW5 series

These advanced workholding pumps, operating at maximum 5000 psi hydraulic pressure, are highly suitable for production tooling applications – offering the optimum in terms of compact size for required oil flow and pressure rating and customization to your specific needs.

### Application

Enerpac electric pump used in conjunction with swing cylinders, work supports, directional valves, control valves and sequence valves can provide a complete clamping solution. The pressure switch allows the unit to be fully automated.

■ Enerpac VP-series valves stackbuilt on ZW5211SJE100. The pressure switch PSCK-8 is mounted directly onto the endplate of Tie Rod Kit TRK-2.



## ZW5VPSEE100 with manifold for VP-series or CETOP 03 valves, without electric controls and gauge

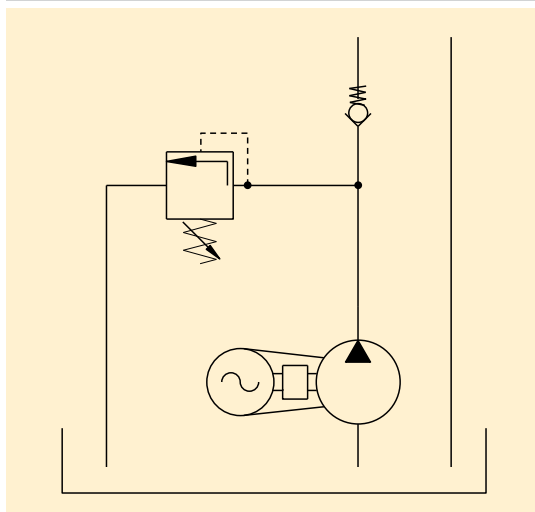

### Basic pumps

Customize to your needs with the Enerpac VP-series valves and options or choose your own D03 valve.

## ZW5111SEE100 For 1x Double-Acting circuit and Isolating Valve for A-port

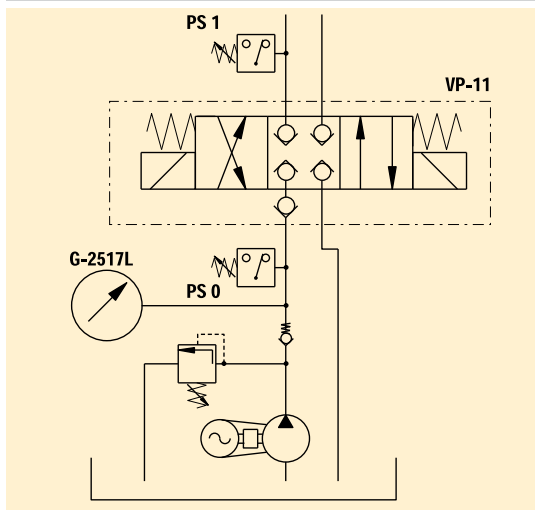

### Isolating valves

For applications where clamping pressure has to be maintained, isolating valves are an economic and safe solution.

The pressure switch (PS 1) switches in the hydraulic line to the cylinder actuates the valve with a closed center position and isolates the circuit when the preset pressure has been reached. In case of pressure drop the switch opens the valve to compensate.

For some particular applications, i.e., when a workpiece has to be positioned and clamped with different forces, you can set different isolating valve pressures for the independent circuits.

## ZW5141SEE100 For 2x Single-Acting circuits

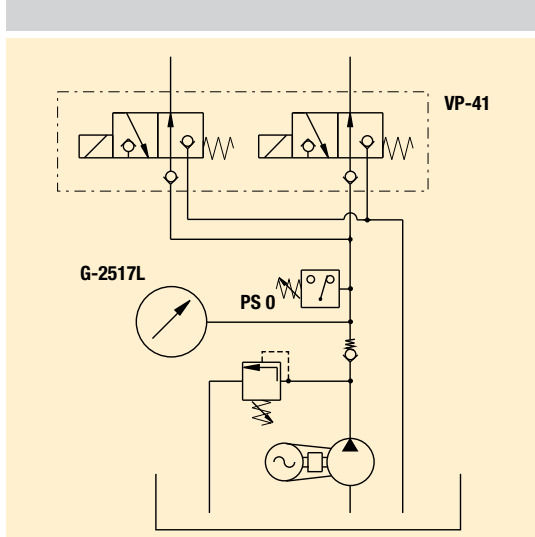

Pressure switch (PS 0) switches the motor off at maximum pressure; in case of pressure drop due to activating circuits, the motor restarts.



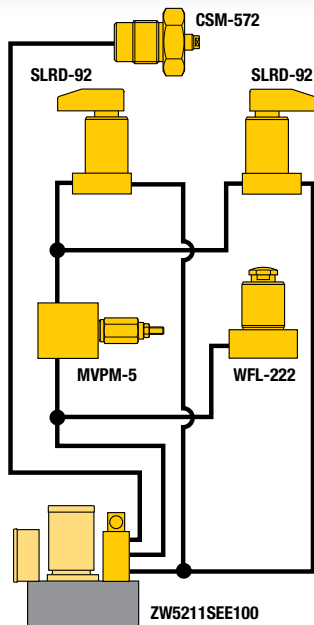

**ZW5211SEE100 for 2x Double-Acting circuit and Isolating Valve for all A-ports**

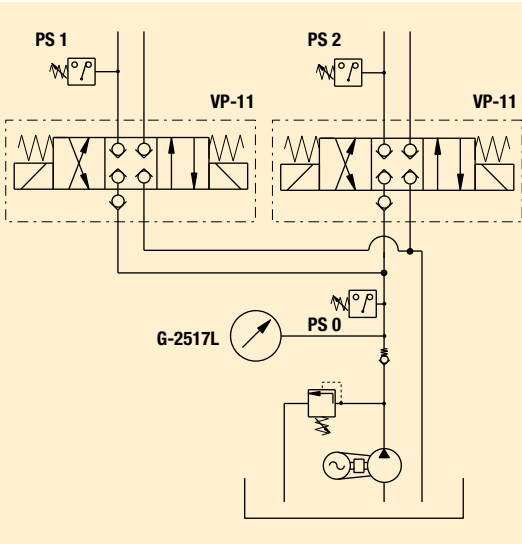

**Application example**

Building the right workholding system for a specific production tooling requirement is best achieved by observing the Basic System Set-up in our “Yellow Pages” (☐202 ▶).

**Electric Scheme**

Shown the electric scheme of the ZW5211SJE100 (460 volt) for two double-acting circuits and isolating valves (pressure switches) in both A-lines.

**ZW5211SJE100**

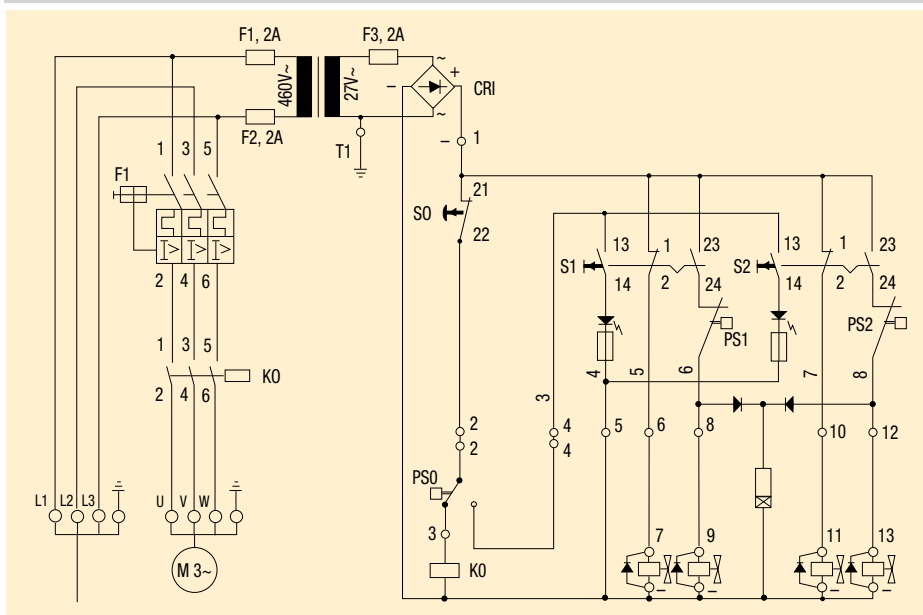

- Flow: 120 in<sup>3</sup>/min
- Pressure: 1450-5000 psi
- Motor: 1.5 hp
- Reservoir: 1-10 gallon

- E** Bombas eléctricas
- F** Centrale hydraulique
- D** Modulare Spannumpme

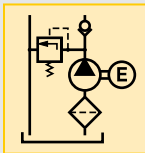

**Options**

**Sequence valves** 

☐152 ▶

**Flow control valves** 

☐155 ▶

**Hoses and couplers** 

☐192 ▶

**High pressure filters** 

☐193 ▶

**Hydraulic oil** 

☐193 ▶

**Fittings** 

☐194 ▶

**VP-series valve options** 

☐136 ▶

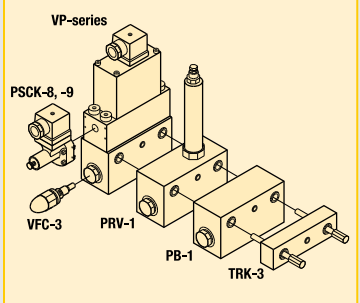



Shown: SP-621, P-51, P-142



## P series

Single and two-speed hand operated pumps for operation of single-acting cylinders.

### SP-621 Screw pump

Single speed non-vented, internally sealed screw pump to operate single-acting cylinders. Can be mounted in any position and used to operate a single fixture. The piston is screwed into the pump, forcing the oil in the hydraulic system.

## Exclusively from Enerpac

...to power single-acting cylinders

- Internal pressure relief valve (except SP-621) prevents over-pressurization
- Two speed operation reduces handle strokes by as much as 78% over single speed pumps
- Low handle effort minimizes operator fatigue
- Compact size – enables easy conversion of manual fixtures to hydraulic power

Flow: .055-.25 in<sup>3</sup>/stroke

Pressure: 3000-10,000 psi

Reservoir: 6.2-55 in<sup>3</sup>

**E** Bombas manuales

**F** Pompes à main

**D** Handpumpen



## Options

### Fittings

194 ▶



### Hoses

192 ▶



### Hydraulic oil

193 ▶



## Important

**P-141, P-142 and P-202 are designed for a maximum operating pressure of 10,000 psi.**

SP-621

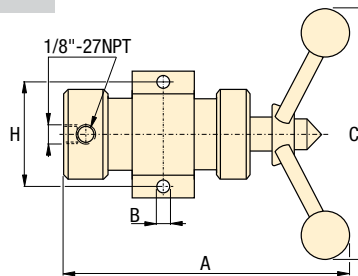

P-51

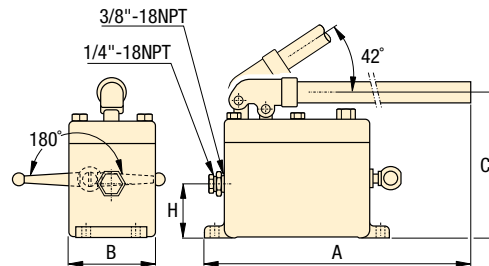

P-141, -142, -202

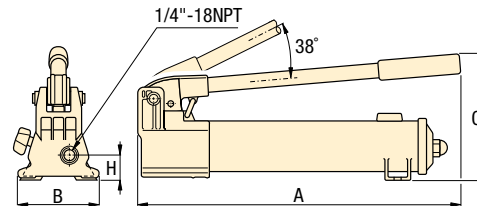

## Product selection

Maximum hydraulic pressure	Usable oil capacity	Model number	Pressure rating		Oil volume per stroke		Piston stroke	Maximum handle effort	Dimensions (inches)				Weight
			psi	psi	1st stage	2nd stage			A	B	C	H	
psi	in <sup>3</sup>		1st stage	2nd stage	1st stage	2nd stage	in	lbs	A	B	C	H	lbs
<b>▼ Single speed</b>													
3000	6.2	SP-621	–	3000	–	<sup>1)</sup>	<sup>1)</sup>	60 <sup>2)</sup>	10.10	.41	12.40	2.81	7.0
3000	50	P-51	–	3000	–	.25	1.00	61	26.00	3.63	6.31	2.25	12.0
10,000	20	P-141	–	10,000	–	.055	.50	72	13.25	3.75	5.63	1.13	4.5
<b>▼ Two speed</b>													
5000	20	P-142	200	10,000	.221	.055	.50	78	13.25	3.75	5.63	1.13	4.5
5000	20	P-142-5000	200	5,000	.221	.055	.50	78	13.25	3.75	5.63	1.13	4.5
10,000	55	P-202	200	10,000	.221	.055	.50	63	20.06	3.75	5.69	1.13	7.5

1) Handle travel of SP-621 is 2.50 inches; 25 handle rotations displace 6.2 in<sup>3</sup> of oil.  
2) Handle effort on SP-621 is 60 ft.lbs at 3000 psi.

Collet-Lok® product line  
Swing clamps  
Work supports  
Linear clamps  
Power sources

## Air Powered Pump with Manual Valve

This system uses a PASG5002SB Turbo II air powered pump with a VMMD-001 manual valve to control a fixture circuit with single acting swing clamps and work supports. A VDP-1 check module in the valve stack locks the pressure in the system. A WVP-5 sequence valve delays the actuation of the works support until the swing clamp is clamped.

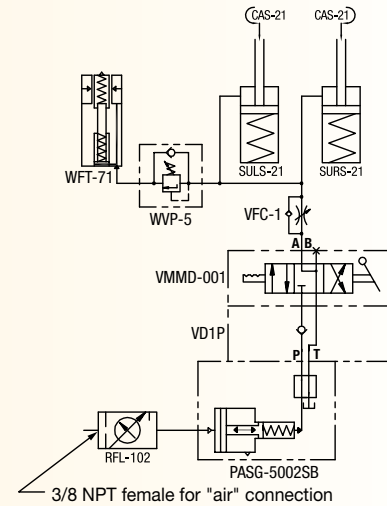

## Air Powered Pump with Dual Solenoid Valves

This system uses a PACG30S8S-MB2 Two gallon Turbo II air powered pump with two VP03-11 solenoid valves to control two independent fixture circuits with double acting swing clamps and work supports. Flow controls in the valve stack provide control of the cylinder actuation speed. Sequence valves delay the actuation of the work supports until the swing clamps are clamped.

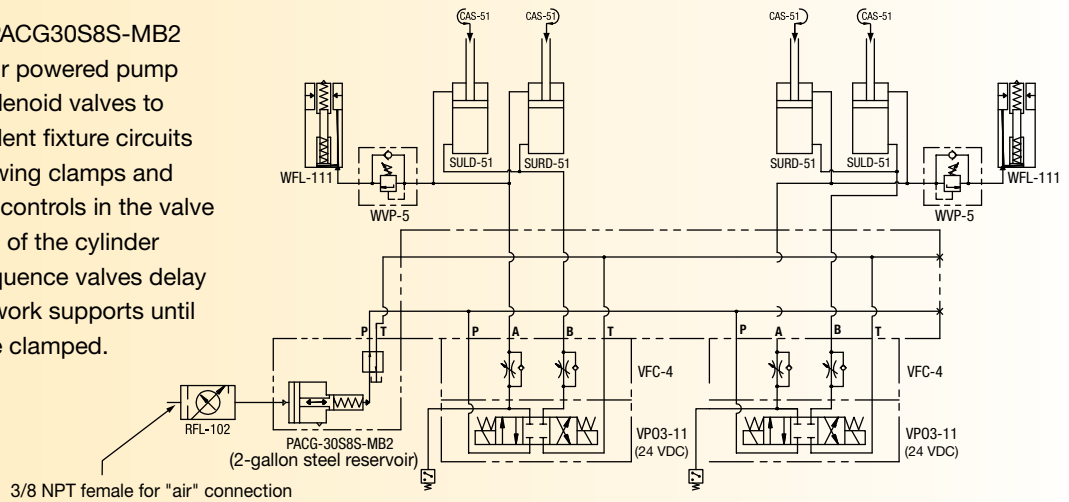

## Electric Pump with Dual Solenoid Valves

This system uses a ZW3020HB-FT12 electric pump and two VP-11 solenoid valves to control two independent fixture circuits with double acting swing clamps and work supports. Flow controls mounted in the valves provide control of the cylinder actuation speed. Pressure switches on the "clamp" circuit can provide confirmation of clamping pressure. Sequence valves delay the actuation of the work supports until the swing clamps are clamped.

