

Specification

Units:

Imperial

Metric

Maximum Operating Pressure (psi)	10,000
Cylinder Compatability	Single-acting
Reservoir Capacity (in ³)	61
Usable Oil Capacity (in ³)	61
Maximum Flow at Rated Pressure	15 in ³ /min
Output Flow Rate (in ³ /min) No Load	120
Output Flow Rate Load (in ³ /min)	15
Valve Function	Advance / Hold / Retract
Valve Operation	Manual
Valve Type	3-way, 3-position
Power Source	Air
Air Pressure Range (psi)	30 - 125
Air Consumption (scfm)	10 - 35
Weight (lbs)	19.4

Dimension

Units:

Imperial

Metric

Dimension H1 (in)	5.98
-------------------	------

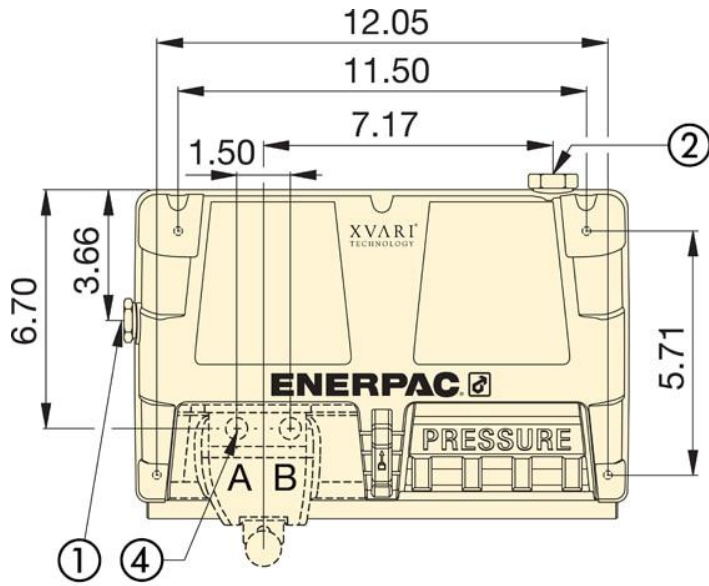

- ① 3/8"-18 NPTF Oil Outlet
- ② 1/4"-18NPTF Air Inlet
- ③ 4/3 Optional Control Valve
- ④ 3/8"-18 NPTF Oil Outlet

