

# Quick Setup

Before using the projector, make sure you read the safety instructions in the online *User's Guide*.

## Connect the projector

Choose from the following connections. See the sections below or the online *User's Guide* for details.

### Computer

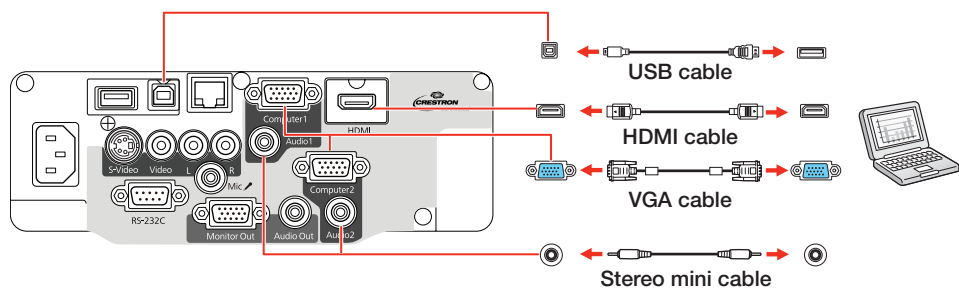

### USB port

Connect the square end of a USB cable to the projector's **USB-B** (square) port. Connect the flat end of the cable to any USB port on your computer.

**Windows® XP or later:** After turning on the projector, follow the on-screen instructions to install the Epson® USB Display software (**EMP\_UDSE.EXE**; only on first connection). If the software screen does not display automatically, open **My Computer** or **Computer**, then double-click **EPSON\_PJ\_UD**.

**OS X 10.5.8 or higher:** After turning on the projector, the setup folder for USB Display appears in the Finder. Double-click **USB Display Installer** and follow the on-screen instructions to install the Epson USB Display software (only on first connection).

### Computer port

Connect one end of a VGA cable to the projector's **Computer1** or **Computer2** ports, and the other end to your computer's  monitor port. If you are using a laptop, switch it to external display (see "Troubleshooting"). You can also connect an audio cable.

### HDMI port

Connect one end of an HDMI cable to the projector's **HDMI** port and the other end to an HDMI port on your computer.

### Wired network

You can connect the projector to your network using an Ethernet cable. See "Project over a wired network" for instructions.

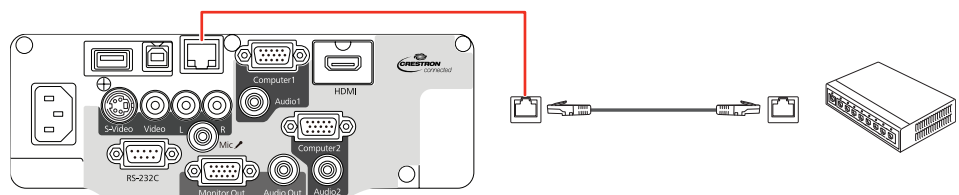

### Video device

Connect multiple video devices and use the **Source Search** button on the projector or remote control to switch between them.

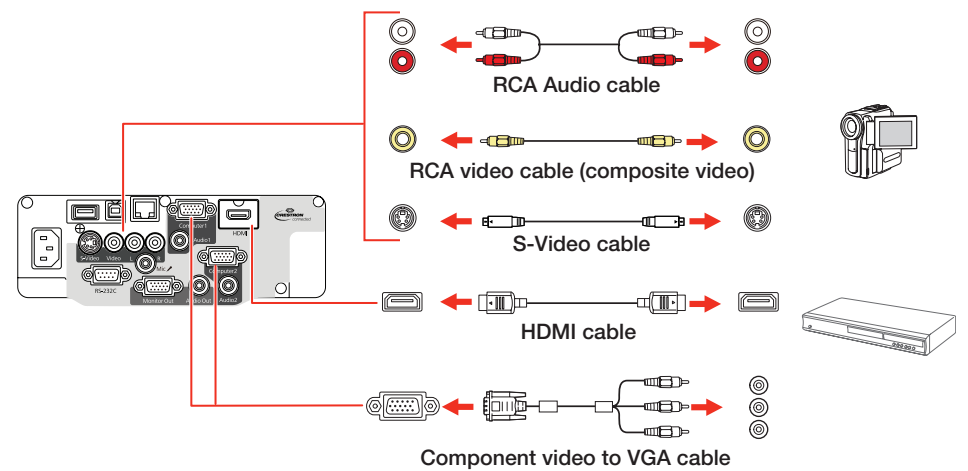

### Camera, USB device, or Epson DC-06 document camera

Connect a digital camera, USB flash drive, USB storage device, or Epson DC-06 document camera to the projector's **USB-A** (flat) port.

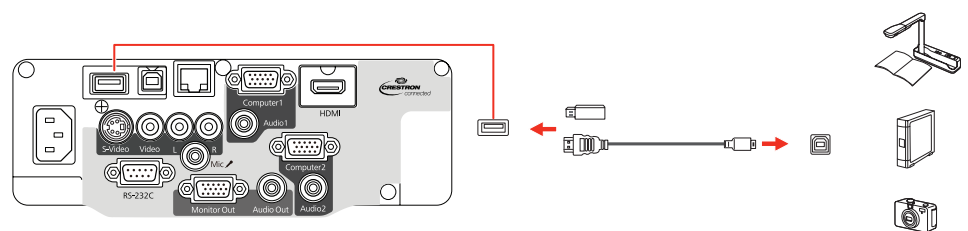

If you connect a digital camera, USB flash drive, or USB storage device, you can use the projector's PC Free feature. You can also connect other Epson document cameras to the projector. See the online *User's Guide* for details.

## Turn on your equipment

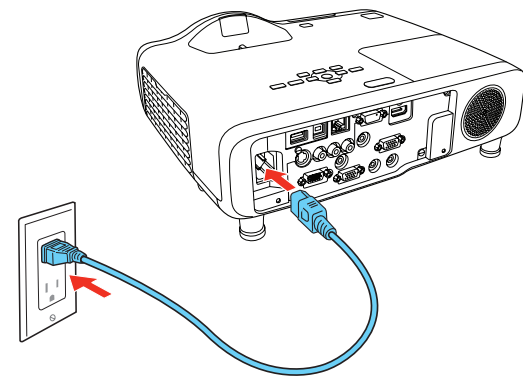

- 1 Turn on your computer or video source.
- 2 Plug in the projector. The  power light on the projector turns blue.

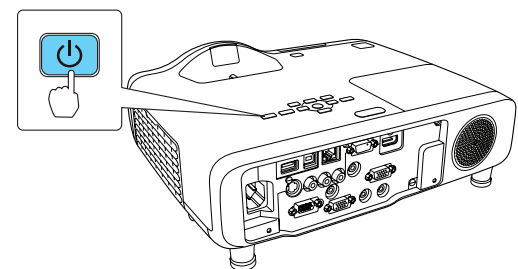

- 3 Press the  power button on the projector or remote control. The projector beeps, and the Status light flashes blue and then stays on.



**Note:** To shut down the projector, press the  power button twice, then unplug it. You don't have to wait for the projector to cool down.

- 4 The default language of the menu system is English. To select another language, press the **Menu** button on the projector or remote control. Select **Extended** and press . Select **Language** and press . Select your language and press . Press the **Menu** button to exit the menu system.



# Adjust the image

- 1 If you don't see an image, press the **Source Search** button on the projector or the remote control to select the image source.

**Note:** If you still see a blank screen or have other display problems, see the troubleshooting tips on the back of this sheet.

- 2 To raise the image, press the foot release button and lift the front of the projector. Release the button to lock the foot in position.

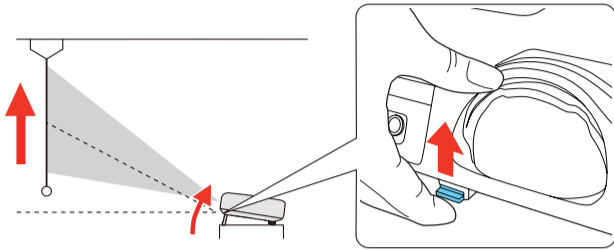



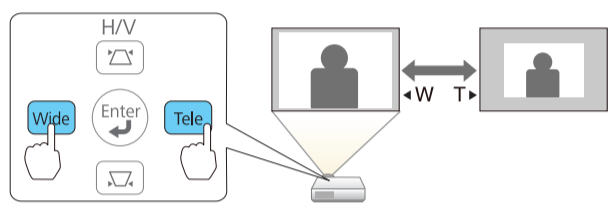



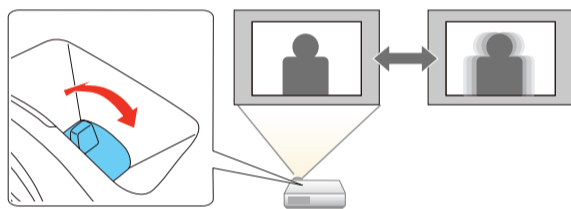

- 3 Press the **Wide** or **Tele** buttons on the projector to reduce or enlarge the image.



- 4 Turn the focus ring to sharpen the image.



- 5 If your image looks like  or , you may have placed the projector off to one side of the screen at an angle. Place the projector directly in front of the center of the screen, facing the screen squarely. If you can't move the projector, press the  or  button on the projector to open the keystone correction menu then use the **Wide** or **Tele** buttons to correct the image.

- 6 If your image looks like  or , you can press the  or  button on the projector to correct it.

# Using the remote control

Make sure the batteries are installed as shown (two AA batteries).

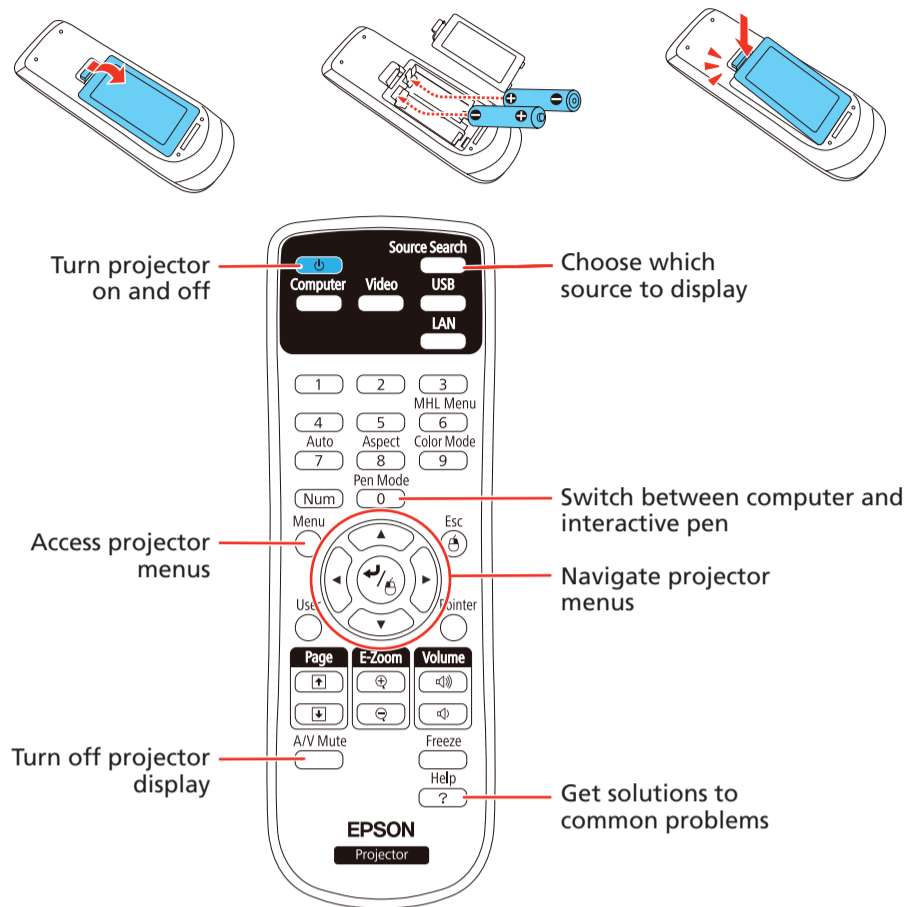

For more information on using the remote control, see the online *User's Guide*.

# Project wirelessly from a computer

Follow the steps here to connect the projector over a wireless network. You will need the optional wireless LAN module (part number V12H418P12).

- 1 To install the optional wireless LAN module, first remove the screw as shown.

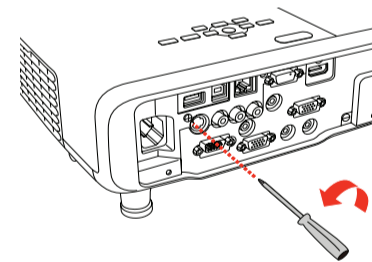

- 2 Connect the wireless LAN module to the **USB-A** (flat) port.

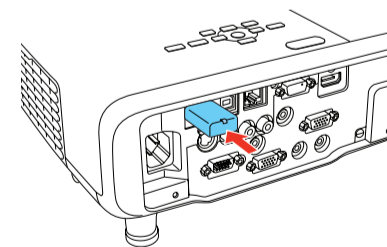

- 3 To configure your projector for wireless projection, do one of the following:

- If you're using the optional Quick Wireless Connection USB key (Windows only, part number V12H005M09), press the **LAN** button on the remote control. When you see SSID and IP address information on the screen, remove the wireless LAN module and connect the key to the projector's **USB-A** port. Look for the displayed message, remove the key, and connect it to a USB port on your computer. Follow your computer's on-screen instructions to install the driver, then reconnect the wireless LAN module to the projector's **USB-A** port. For details, see the online *User's Guide*.
- If you're not using the key, continue with step 4.



- 4 Attach the wireless LAN module cover and secure it using the screw you removed.

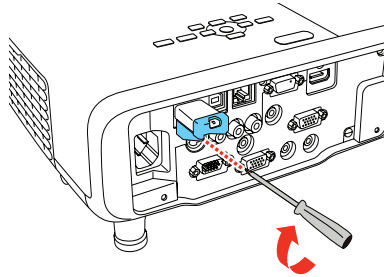

- 5 Press the **Menu** button on the remote control, select the **Network** menu, and press  $\leftarrow/\rightarrow$ .

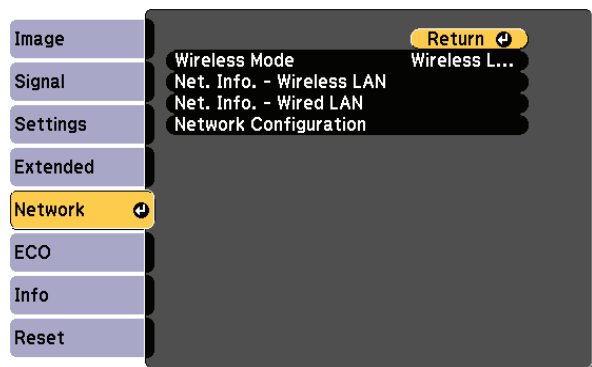

- 6 Choose **Network Configuration** and press  $\leftarrow/\rightarrow$ .

- 7 Select the **Wireless LAN** menu and press  $\leftarrow/\rightarrow$ .

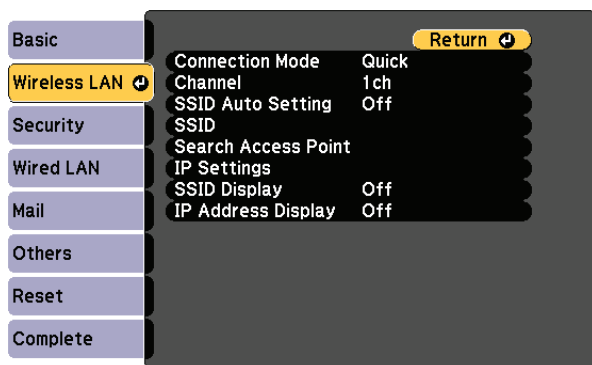

- 8 Choose **Connection Mode**, press  $\leftarrow/\rightarrow$ , select **Quick** (for a direct connection to a computer, tablet, or smartphone) or **Advanced** (for a connection to a router or access point), then press  $\leftarrow/\rightarrow$  again. When you're finished, press **Esc** to return to the Wireless LAN menu.

- 9 If you chose the Advanced connection mode, select **Search Access Point**, press  $\leftarrow/\rightarrow$  and select your network from the list. If your network does not appear on the list, select **SSID**, press  $\leftarrow/\rightarrow$  and enter your network name (SSID) on the screen that appears.

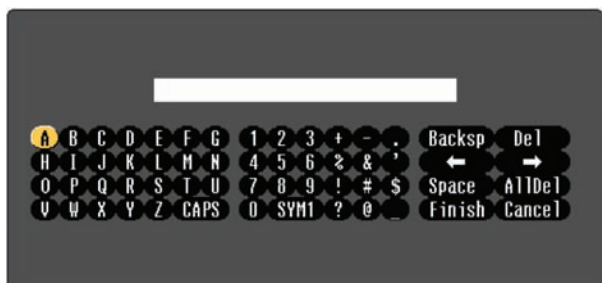

- To select a number or character, use the arrow buttons on the remote control to highlight it, then press  $\leftarrow/\rightarrow$ .
- To switch between uppercase and lowercase letters, select **CAPS** and press  $\leftarrow/\rightarrow$ .
- To change the displayed symbols, select **SYM1** or **SYM2** and press  $\leftarrow/\rightarrow$ .

When you're finished entering the SSID, select **Finish** and press  $\leftarrow/\rightarrow$ .

- 10 If you chose the Advanced connection mode, select **IP settings** and press  $\leftarrow/\rightarrow$ .

If your network assigns addresses automatically, turn on **DHCP**. If not, turn off **DHCP** and enter the projector's **IP Address**, **Subnet Mask**, and **Gateway Address**, as needed.

To enter numbers, use the arrow buttons on the remote control to highlight a number, then press  $\leftarrow/\rightarrow$ . When you're finished entering an address, highlight **Finish**, then press  $\leftarrow/\rightarrow$ . Press **Esc**.

- 11 To prevent the SSID and IP address from appearing on the network standby screen, set the **SSID Display** and **IP Address Display** settings to **Off**.

- 12 When you're finished selecting settings in the Wireless LAN menu, press **Esc**.

- 13 If you are connecting the projector to a secure network, select the **Security** menu and press  $\leftarrow/\rightarrow$ . Then select settings and press **Esc** when you're finished.

- 14 Select **Complete** and press  $\leftarrow/\rightarrow$ , then select **Yes** and press  $\leftarrow/\rightarrow$  again to save your settings.

- 15 See "Install network software" for additional instructions.

## Project over a wired network

Follow the steps here to configure your projector for your wired network using the projector's menu system.

- 1 Plug in and turn on the projector.

- 2 Press the **Menu** button on the remote control, select the **Network** menu, and press  $\leftarrow/\rightarrow$ .

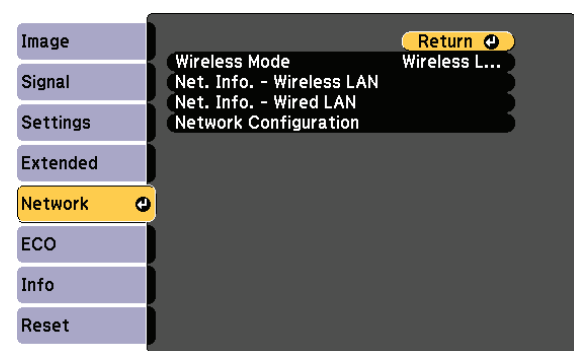

- 3 Select **Network Configuration** and press  $\leftarrow/\rightarrow$ .

- 4 Select the **Basic** menu and press  $\leftarrow/\rightarrow$ .

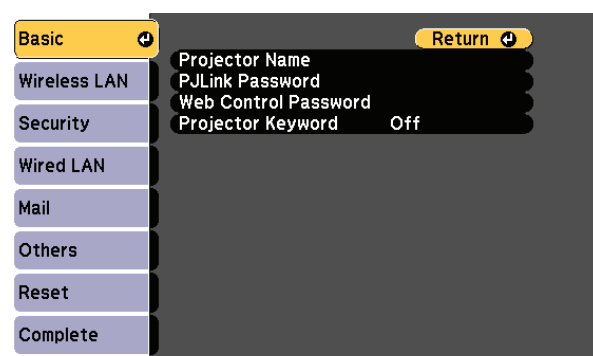

- 5 Select the **Projector Name** setting and enter a name (up to 16 characters long) to identify your projector over the network.

Use the displayed keyboard to enter characters. Press the arrow buttons on the remote control to highlight the characters and press  $\leftarrow/\rightarrow$  to select them.

**Note:** See the online User's Guide for information on adding passwords.

- 6 Select the **Wired LAN** menu and press  $\leftarrow/\rightarrow$ .

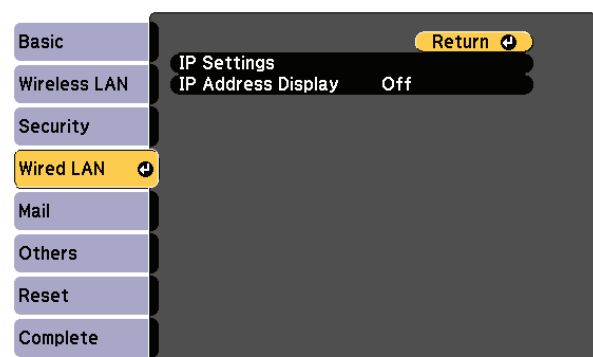

- 7 Choose **IP Settings** and press  $\leftarrow/\rightarrow$ .

- 8 If your network assigns addresses automatically, turn on the **DHCP** setting. If not, turn off the **DHCP** setting and enter the projector's **IP Address**, **Subnet Mask**, and **Gateway Address**, as needed. Then press **Esc**.
- 9 To prevent the IP address from appearing on the network standby screen, set the **IP Address Display** setting to **Off**.
- 10 When you are finished, select **Complete** and press  $\swarrow/\text{6}$ , then press  $\swarrow/\text{6}$  again to save your settings.
- 11 Press the **Menu** button to exit the menu system.
- 12 See "Install network software" for additional instructions.

## Install network software

### Computer

Install the EasyMP® Network Projection software on each computer that will project over the network. Use the CD labeled *Epson Projector Software* to install the program.

For instructions on installing and using your network software, click the icon on your desktop to access the online *EasyMP Network Projection Operation Guide* (requires an Internet connection). If you don't see the EasyMP Network Projection Guide icon, you can install it from the projector CD or go to the Epson website, as described on the right.

To monitor and control your projector over the network, download and install the EasyMP Monitor software and manual from the Epson support web site. You can install a link to the downloads page from the projector CD or go to the Epson website, as described on the right.

### Mobile device

To project from an iOS or Android™ device, download and install the Epson iProjection™ app. Visit [epson.com/projectorapp](http://epson.com/projectorapp) (U.S.) or [epson.ca/projectorapp](http://epson.ca/projectorapp) (Canada) for more information.



## Troubleshooting

If you see a blank screen or the **No signal** message after turning on your computer or video device, check the following:

- Make sure the Status light on the projector is blue and not flashing.
- Press the **Source Search** button on the projector or the remote control to switch to the correct image source, if necessary.
- If you're using a Windows laptop, press the function key on your keyboard that lets you display on an external monitor. It may be labeled **CRT/LCD** or have an icon such as  $\text{L}/\text{O}$ . You may have to hold down the **Fn** key while pressing it (such as **Fn + F7**). Wait a moment for the display to appear.
- If you're using a Mac laptop, open **System Preferences** and select **Displays**. Click the **Arrangement** tab and select the **Mirror Displays** checkbox.

## Where to get help

### Manuals

For more information about using the projector, click the icons on your desktop to access the online manuals (requires an Internet connection). If you don't have icons to the manuals, you can install them from the projector CD or go to the Epson website, as described below.

### Telephone support services

To use the Epson® PrivateLine® Support service, call (800) 637-7661. This service is available for the duration of your warranty period. You may also speak with a support specialist by calling (562) 276-4394 (U.S.) or (905) 709-3839 (Canada).

Support hours are 6 AM to 8 PM, Pacific Time, Monday through Friday, and 7 AM to 4 PM, Pacific Time, Saturday. Days and hours of support are subject to change without notice. Toll or long distance charges may apply.

### Internet support

Visit [epson.com/support](http://epson.com/support) (U.S.) or [epson.ca/support](http://epson.ca/support) (Canada) for solutions to common problems. You can download utilities and documentation, get FAQs and troubleshooting advice, or e-mail Epson.

### Registration

Register today to get product updates and exclusive offers. You can use the CD included with your projector or register online at [epson.com/webreg](http://epson.com/webreg).

## Optional accessories

For a list of optional accessories, see the online *User's Guide*.

You can purchase screens or other accessories from an Epson authorized reseller. To find the nearest reseller, call 800-GO-EPSON (800-463-7766). Or you can purchase online at [epsonstore.com](http://epsonstore.com) (U.S. sales) or [epson.ca](http://epson.ca) (Canadian sales).

**EPSON®**  
EXCEED YOUR VISION



EPSON, PowerLite, and EasyMP are registered trademarks, Epson iProjection is a trademark, and EPSON Exceed Your Vision is a registered logomark of Seiko Epson Corporation. PrivateLine is a registered trademark of Epson America, Inc.

Mac and OS X are trademarks of Apple Inc., registered in the U.S. and other countries.

General Notice: Other product names used herein are for identification purposes only and may be trademarks of their respective owners. Epson disclaims any and all rights in those marks.

This information is subject to change without notice.

© 2014 Epson America, Inc., 8/14  
Printed in XXXXXX

CPD-41698