

Quick Setup

Before using the projector, make sure you read the safety instructions in the online *User's Guide*.

Note: Your product may differ from the illustrations on this sheet, but the instructions are the same.

Note: Not all products are available in all regions.

Contents

Make sure your projector box included all of these parts:

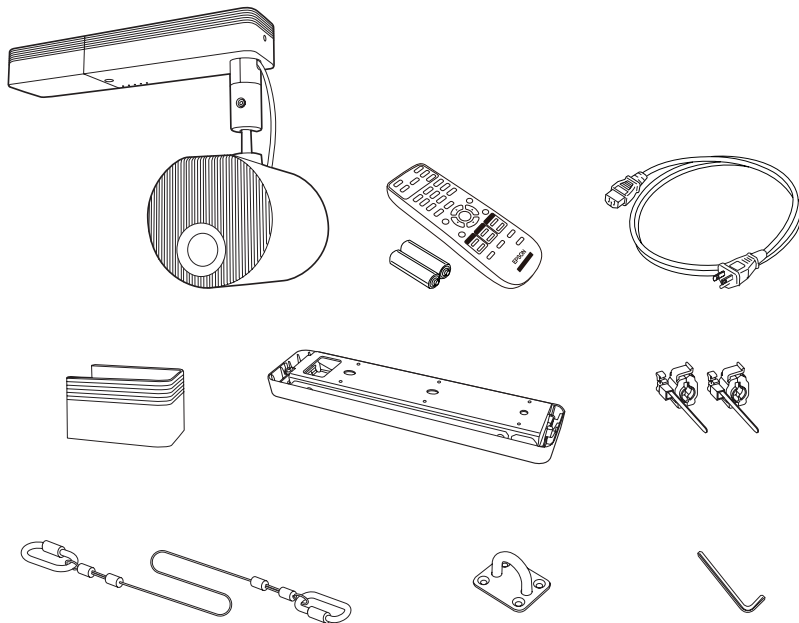

Installation options

You can install your projector in the following ways:

- Mounted on a wall or ceiling using the direct mount (included)
- Mounted on a lighting track using the optional lighting track mount: ELPMB66W (White)/ELPMB66B (Black)
- Mounted on a table or floor using the optional floor stand: ELPMB55W (White)/ELPMB55B (Black)

Note: To purchase optional mounts or other accessories, see "Optional accessories." For more information about the mounts, see the *Installation Manual that came with the mount or the online User's Guide*.

Connect the projector

Choose from the following connections. See the sections below or the online *User's Guide* for details.

Note: For information about connecting sensors or other external devices, see the online *User's Guide*.

Wired network

Connect the projector to your network using an Ethernet cable. See "Setting up a wired connection" for more information.

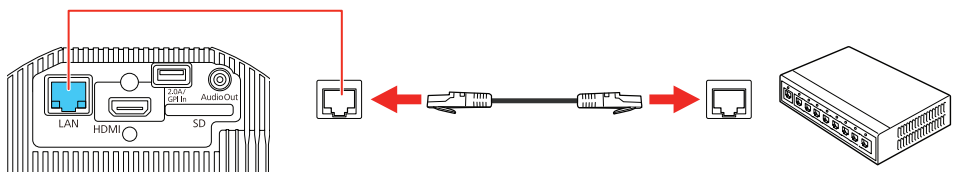

Computer or video device

Connect one end of an HDMI cable to the projector's **HDMI** port and the other end to an HDMI port on your computer or video device.

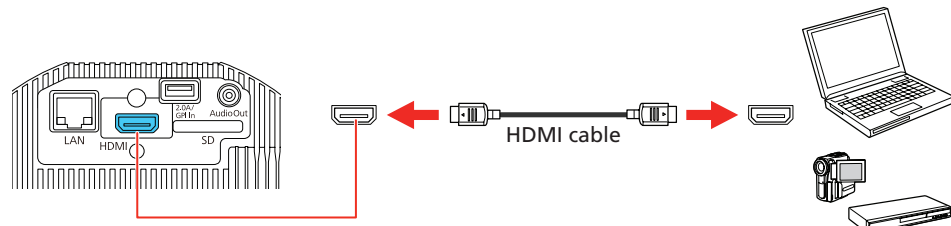

External speakers

Connect one end of a 3.5 mm stereo mini-jack audio cable to the projector's **Audio Out** port and the other end to your powered external speakers.

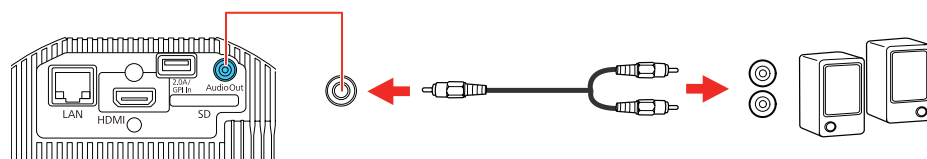

Using the remote control

Install the batteries as shown (two AA batteries).

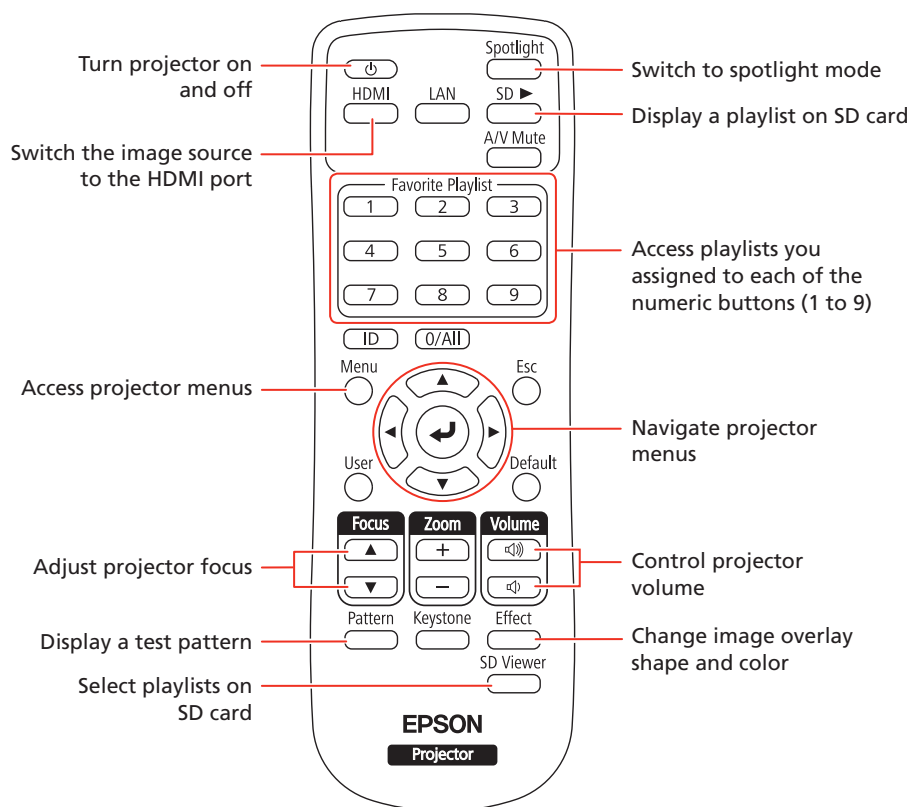
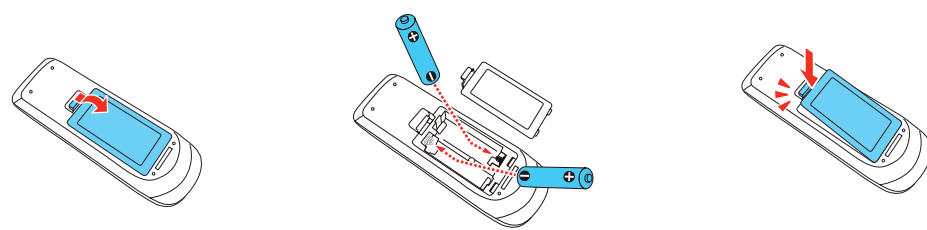



For more information on using the remote control, see the online *User's Guide*.

Turn on your equipment

Note: Your connection method may vary depending on your setup.

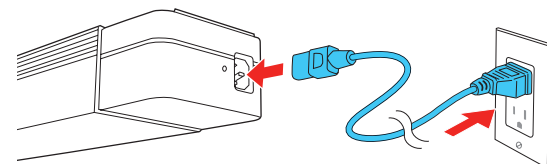
- 1 Connect your computer, video equipment, or insert an SD card.
- 2 Make sure the power cord is connected and plugged into an electrical outlet.



3 Press the  power button on the projector or remote control. The Status light flashes blue and then stays on.

Note: To shut down the projector, press the  power button twice.

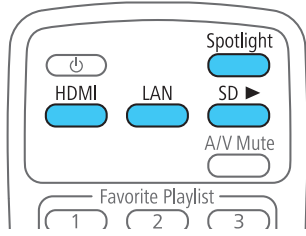

4 If you don't see an image, press one of the input source buttons on the remote control to select the image source.

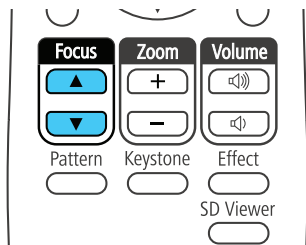

Note: If you still see a blank screen or have other display problems, see the troubleshooting tips on the back of this sheet.

5 If you need to focus the image, press the focus buttons on the remote control.



6 The default language of the menu system is English. To select another language, press the **Menu** button on the remote control. Select **Extended** and press . Select **Language** and press . Select your language and press . Press the **Menu** button to exit the menu system.

Setting up a wireless connection

Follow these steps to set up the projector for a wireless network connection.

Note: For more information about using the projector on a network, see the online User's Guide.

1 Press the **Menu** button on the remote control, select the **Network** menu, then press .

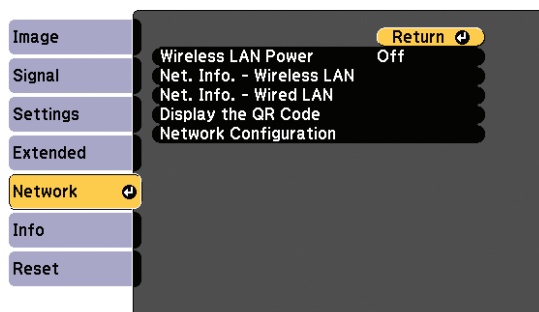

2 Select **On** as the **Wireless LAN Power** setting.

3 Select **Network Configuration** and press .

4 Select the **Basic** menu and press .

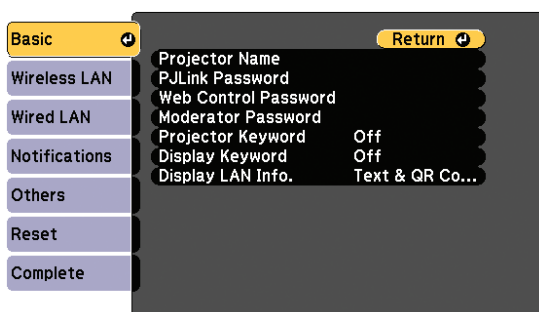

5 Select the basic options as necessary and press .

6 Select the **Wireless LAN** menu and press .

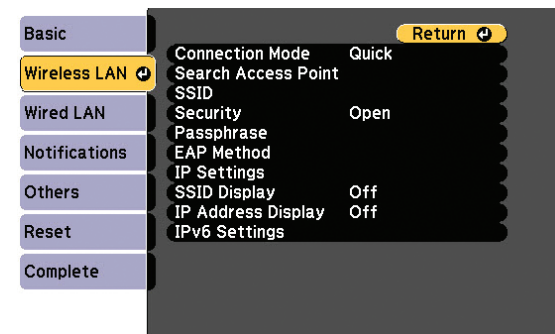

7 Select one of the following as the **Connection Mode** setting:

- **Quick** for a direct connection to a computer, tablet, or smartphone.
- **Advanced** to connect your projector to a wireless router or access point.

8 Select any other settings on the Wireless LAN menu as necessary. See the online *User's Guide* for details.

9 When you are finished, select **Complete** and press , then press .

10 Press the **Menu** button to exit the menu system.

Install the optional software

Download and install optional software to perform various tasks wirelessly, such as uploading content, monitoring or controlling your projector, and projecting from multiple computers.

You can download the optional software and its manuals from the Epson website, as described in "Where to get help."

Setting up a wired connection

Follow these steps to set up the projector for a wired network connection.

Note: For more information about using the projector on a network, see the online User's Guide.

1 Press the **Menu** button on the remote control, select the **Network** menu, then press .

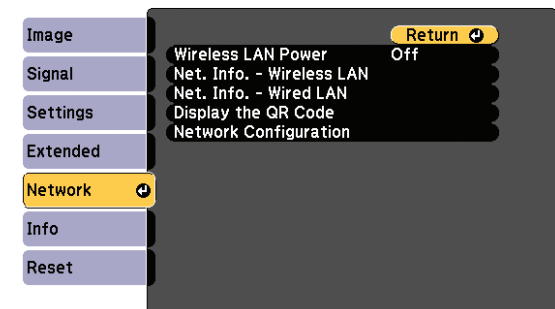

2 Select **Network Configuration** and press .

3 Select the **Basic** menu and press .

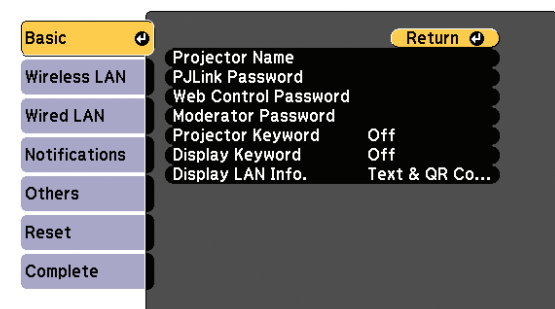

4 Select the basic options as necessary and press .

- 5 Select the **Wired LAN** menu and press ↵.

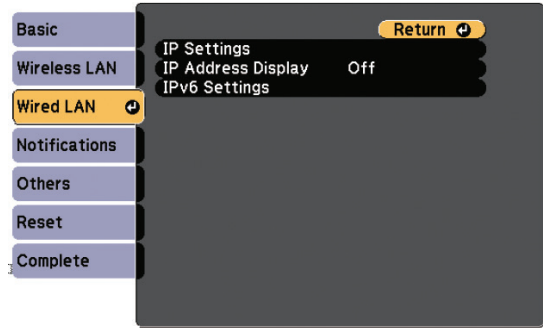

- 6 Choose **IP Settings** and press ↵.
- 7 If your network assigns addresses automatically, make sure the **DHCP** setting is on. If not, make sure **DHCP** is off and enter the projector's **IP Address**, **Subnet Mask**, and **Gateway Address**, as needed. Then press **Esc**.
- 8 To prevent the IP address from appearing on the network standby screen, set the **IP Address Display** setting to **Off**.
- 9 When you are finished, select **Complete** and press ↵, then press ↵ again to save your settings.
- 10 Press the **Menu** button to exit the menu system.

Using web remote

You can use a standard web browser to control the projector through the network. A virtual remote control on your computer screen lets you perform many of the same functions as you can with the physical remote control.

- 1 Open your web browser and enter the IP address of the projector you want to monitor in the browser's address bar.

If you're not sure what the IP address of the projector is, turn the projector on and select **Net. Info. - Wired LAN** or **Net. Info. - Wireless LAN** from the Network menu to display the IP address of the projector. (Do not enter the leading zeroes.)
- 2 Enter **EPSONWEB** as the user name and **admin** as the default password, then click **OK**. The Epson® Web Control menu opens.

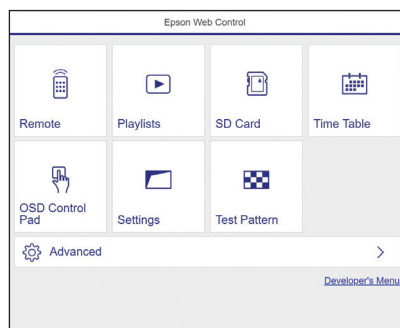

- 3 Select **Remote**. If you see a login screen, enter **EPSONREMOTE** as the user name and **guest** as the password.
- 4 Use the on-screen buttons to operate the projector, as you would using the remote control.

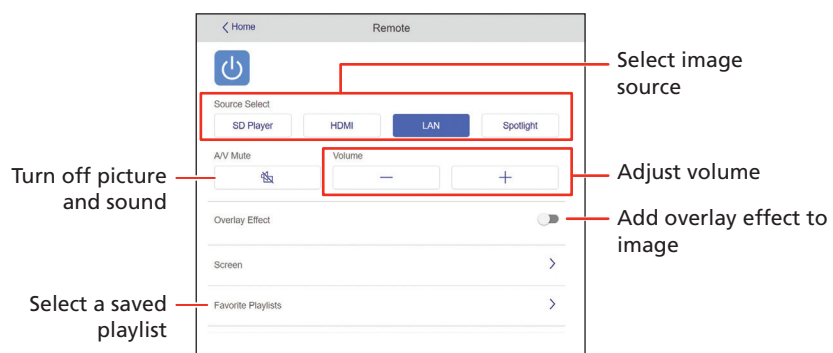

Using the Epson iProjection app

You can project wirelessly from a mobile device (iOS, Android™, or Chromebook™) using the Epson iProjection™ app and a QR code.

- 1 Scan the following QR code to download and install the Epson iProjection app.



- 2 If you connected the projector to a network wirelessly, make sure to connect your mobile device to the same network.
- 3 Press the **Menu** button on the remote control, select the **Network** menu, and select **Display the QR Code** to display a QR code.
- 4 Start Epson iProjection on your mobile device.
- 5 Use the QR code reader feature to read the QR code displayed.

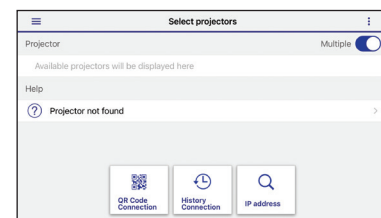

- 6 Follow the app instructions to connect your device to the projector.

For more information on setting up and using this app, visit www.epson.com/iprojection (U.S.) or www.epson.ca/iprojection (Canada), or www.latin.epson.com/iprojection (Caribbean).

Managing content

You can manage content from your computer using the Epson Projector Content Manager software, or over the network using a web browser (Epson Web Control) or the Epson iProjection app.

Note: An SD card is required for managing content.

	Epson Projector Content Manager	Web Browser/ Epson iProjection
Create and edit playlists and apply effects and filters	√	√
Create custom filters	√	
Create and edit timetable	√	
Save project on an SD card	√	
Convert video files	√	
Upload video and picture files over a network	√	√
Control projector over a network		√

Using the Content Manager software

The Epson Projector Content Manager software allows you to add images and movies to playlists and save them directly to an SD card. You can easily project your playlist content by inserting the SD card into your projector's card slot. You can also save your project to an SD card inserted in a networked projector.

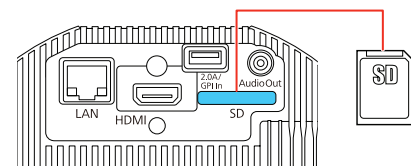

Note: Download and install the Epson Projector Content Manager software from your product's support page (see "Where to get help"). For more information, see the online Epson Projector Content Manager Operation Guide or the online User's Guide.

Troubleshooting

If you see a blank screen or the **No signal** message after turning on your computer or video device, check the following:

- Make sure the Status light on the projector is blue and not flashing.
- Make sure all necessary cables are securely connected, or that the SD card is inserted correctly, and the power is on for the projector and connected video sources.
- Press one of the source buttons (**Spotlight**, **HDMI**, **LAN**, or **SD**) on the remote control to switch to the correct image source, if necessary.
- Press the **A/V Mute** button on the remote control to see if the image was temporarily turned off.
- Make sure the image being projected is not completely black (only when projecting computer images).
- For images projected with Windows® Media Center, reduce the screen size from full screen mode.
- For images projected from applications using Microsoft® DirectX®, turn off DirectX functions.
- If you're using a Windows laptop, press the function key on your keyboard that lets you display on an external monitor. It may be labeled **CRT/LCD** or have an icon such as . You may have to hold down the **Fn** key while pressing it (such as **Fn + F7**). Wait a moment for the display to appear.

On Windows 7 or later, hold down the Windows key and press **P** at the same time, then click **Duplicate**.

- If you're using a Mac laptop, open **System Preferences** and select **Displays**. Click the **Arrangement** tab and select the **Mirror Displays** checkbox.

Registration

Register today to get product updates and exclusive offers. You can register online at www.epson.com/webreg.

Where to get help

Manuals

For more information about using the projector, see the online manuals. You can view or download the manuals from the Epson website, as described below.

Internet support services

Visit www.epson.com/support (U.S.) or www.epson.ca/support (Canada) and search for your product to download software and utilities, view manuals, get FAQs and troubleshooting advice, or contact Epson.

Telephone support

To use the Epson PrivateLine® Support service, call (800) 637-7661. This service is available for the duration of your warranty period. You may also speak with a support specialist by calling (562) 276-4394 (U.S.) or (905) 709-3839 (Canada).

Support hours are 6 AM to 8 PM, Pacific Time, Monday through Friday, and 7 AM to 4 PM, Pacific Time, Saturday. Days and hours of support are subject to change without notice. Toll or long distance charges may apply.

Optional accessories

For a list of optional accessories, see the online *User's Guide*.

You can purchase screens or other accessories from an Epson authorized reseller. To find the nearest reseller, call 800-GO-EPSON (800-463-7766). Or you can purchase online at www.epsonstore.com (U.S. sales) or www.epsonstore.ca (Canadian sales).

EPSON
EXCEED YOUR VISION



EPSON and LightScene are registered trademarks, EPSON Exceed Your Vision is a registered logomark, and Epson iProjection is a trademark of Seiko Epson Corporation.

PrivateLine is a registered trademark of Epson America, Inc.

Windows is a registered trademark of Microsoft Corporation in the United States and/or other countries.

Mac is a trademark of Apple Inc., registered in the U.S. and other countries.

Android and Chromebook are trademarks of Google Inc.

General Notice: Other product names used herein are for identification purposes only and may be trademarks of their respective owners. Epson disclaims any and all rights in those marks.

This information is subject to change without notice.

© 2020 Epson America, Inc., 10/20

CPD-60188