

Quick Setup

Before using the projector, make sure you read the safety instructions in the online *User's Guide*.

Connect the projector

Before you can connect to the projector, you need to remove the screws and the cable cover.

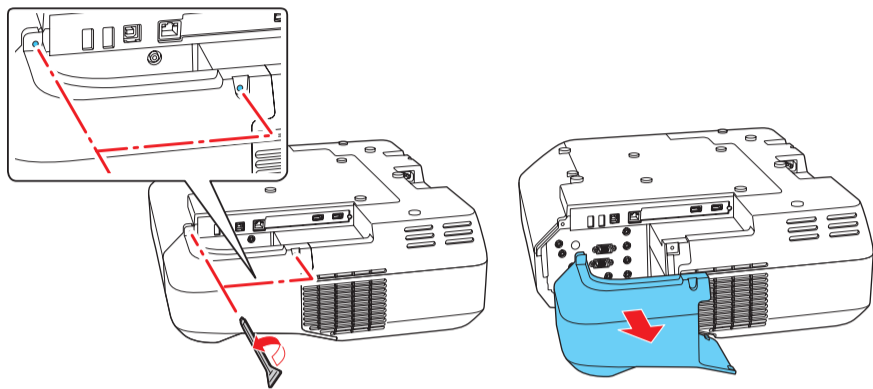

Computer

Choose from the following connections. See the sections below or the online *User's Guide* for details.

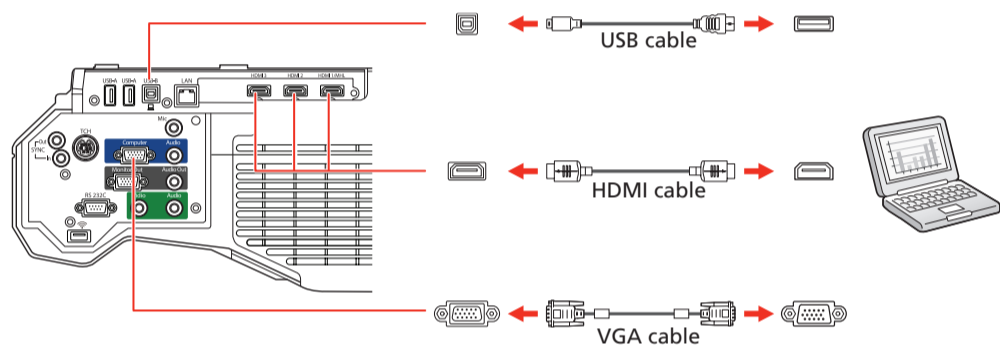

HDMI port

Connect one end of an HDMI cable to one of the projector's **HDMI** ports and the other end to an HDMI port on your computer.

Computer port

Connect one end of a VGA cable to the projector's **Computer** port, and the other end to your computer's  monitor port. If you are using a laptop, switch it to external display (see "Troubleshooting"). You can also connect an audio cable.

USB port

Connect the square end of a USB cable to the projector's **USB-B** (square) port. Connect the flat end of the cable to any USB port on your computer.

Windows® Vista or later: After turning on the projector, follow the on-screen instructions to install the Epson® USB Display software (**EMP_UDSE.EXE**; only on first connection). If the software screen does not display automatically, open **My Computer**, **Computer**, or **This PC**, then double-click **EPSON_PJ_UD**.

OS X 10.7.x or higher: After turning on the projector, the setup folder for USB Display appears in the Finder. Double-click **USB Display Installer** and follow the on-screen instructions to install the Epson USB Display software (only on first connection).

External monitor and speakers

You can connect an external monitor and external speakers to your projector to enhance your presentations. See the online *User's Guide* for details.

Wired network

Connect the projector to your network using an Ethernet cable. See "Project over a network" for more information.

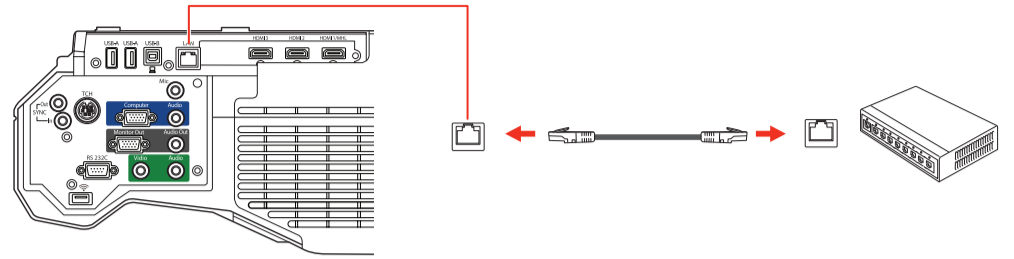

Note: To connect the projector to a wireless network, you must install the optional Epson Wireless LAN Module (ELPAP10). To purchase the Epson Wireless LAN Module or other accessories, see "Optional accessories." For more information, see the online *User's Guide*.

Microphone

Connect a dynamic microphone to the **Mic** port, using a 3.5 mm mini-jack cable.

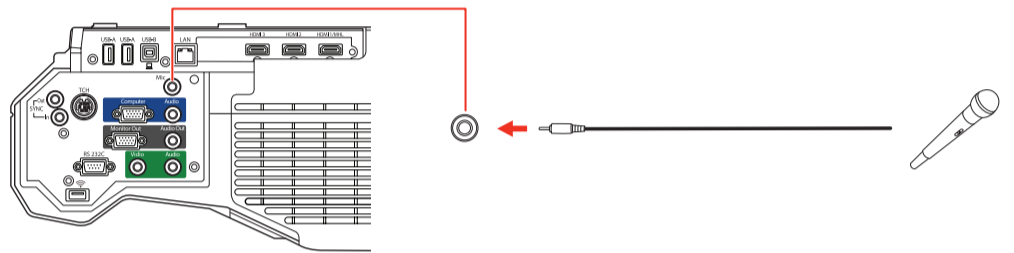

Video device

Connect multiple video devices and use the **Source Search** button on the projector or remote control to switch between them. For more information on playing sound through the projector, see the online *User's Guide*.

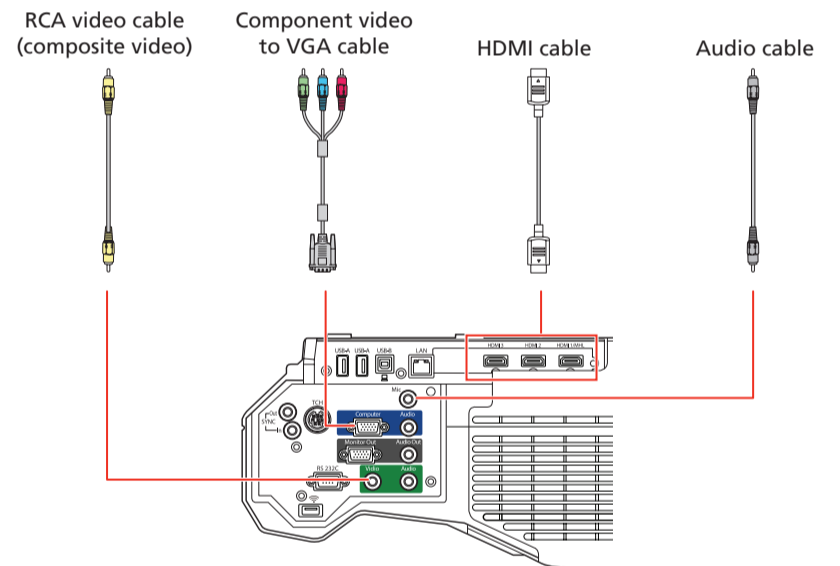

Mobile media device

Connect tablets, smartphones, and other devices that support the MHL™ standard to the **HDMI 1/MHL** port.

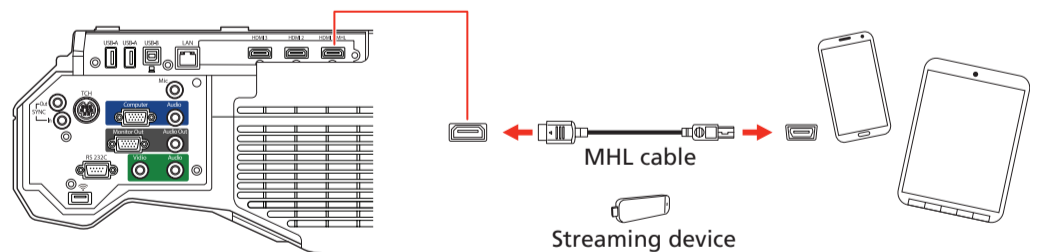

Some devices may require an adapter or may not require an MHL cable. Not all features or functions may be supported. Check your device's documentation for more information.

Touchboards

205 Westwood Ave, Long Branch, NJ 07740
 Phone: 866-94 BOARDS (26273) / (732)-222-1511
 Fax: (732)-222-7088 | E-mail: sales@touchboards.com



413508700

Camera, USB device, or document camera

Connect a digital camera, USB flash drive, USB storage device, or Epson DC-07 document camera to the projector's **USB-A** (flat) port.

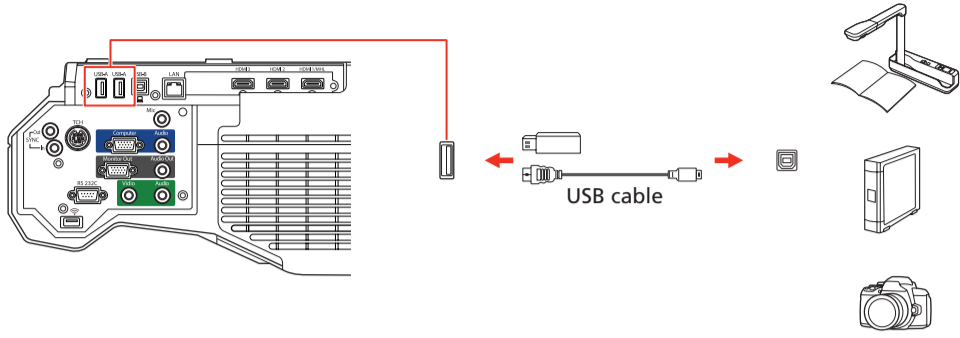

If you connect a digital camera, USB flash drive, or USB storage device, you can use the projector's PC Free feature. You can also connect other Epson document cameras to the projector. See the online *User's Guide* for details.

Using the remote control

Install the batteries as shown (two AA batteries).

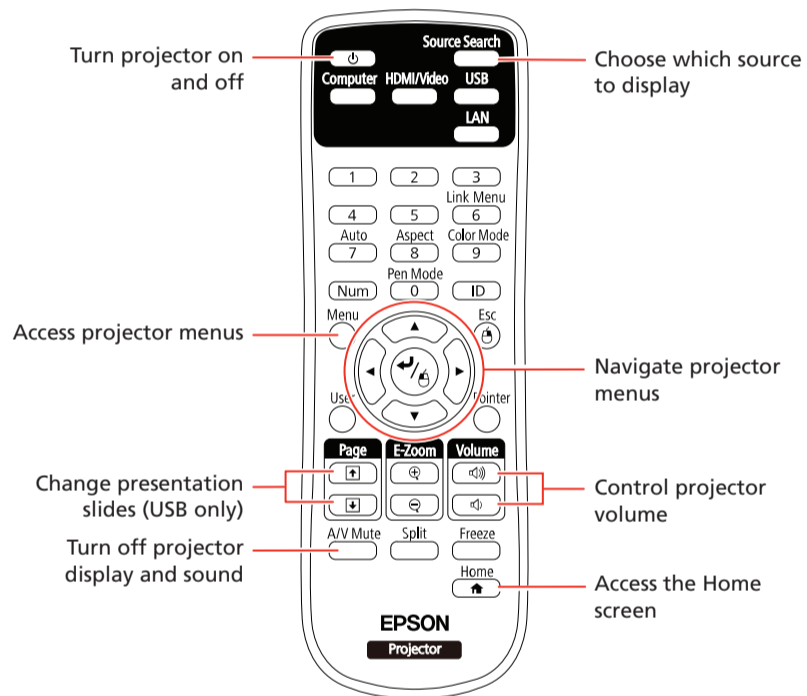
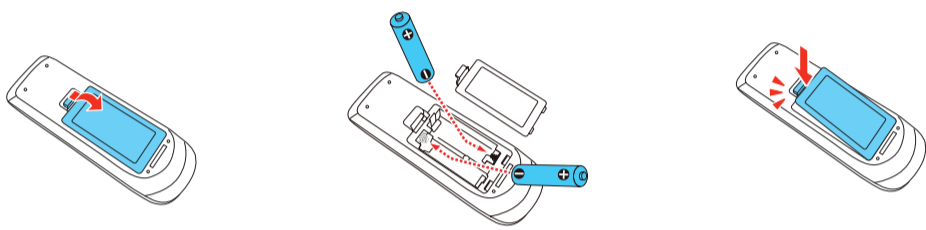

For more information on using the remote control, see the online *User's Guide*.

Turn on your equipment

- 1 Turn on your computer or video source.
- 2 Make sure the power cord is connected and plugged into an electrical outlet.

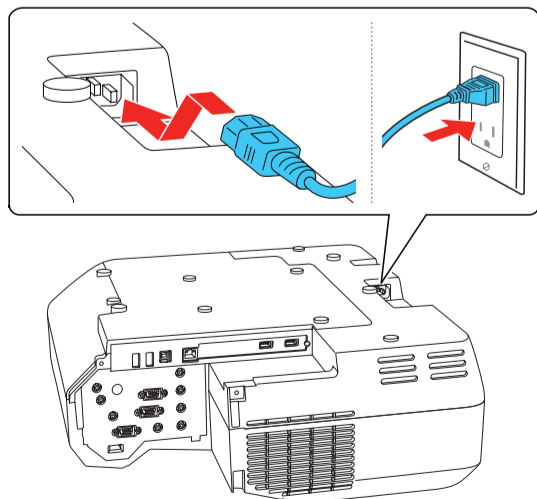

- 3 Press the power button on the projector or remote control. The projector beeps, and the Status light flashes blue and then stays on.

Note: To shut down the projector, press the power button twice.

- 4 If you don't see an image, press the **Source Search** button on the remote control to select the image source.

Note: If you still see a blank screen or have other display problems, see the troubleshooting tips on the back of this sheet.

- 5 If you need to focus the image, first slide the switch on the side of the projector to open the air filter cover. Then raise or lower the focus lever to sharpen the image.

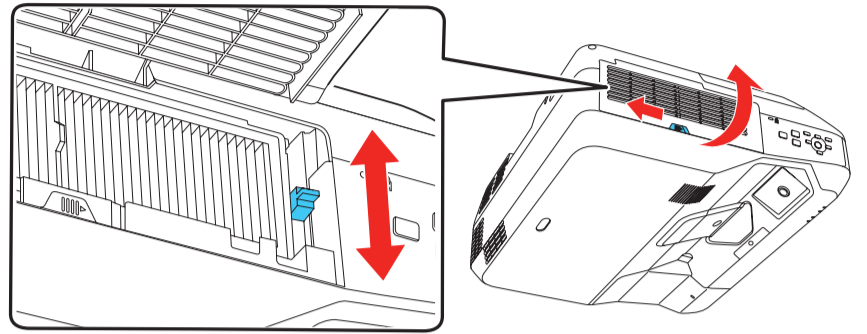

- 6 Use the arrow buttons on the remote control to highlight any of the options on the Home screen, then press \leftarrow/\rightarrow to select it. You can display a QR code, switch between projection sources, and quickly access various adjustment options from this screen.

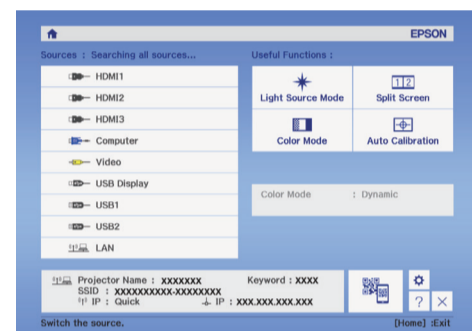

- 7 The default language of the menu system is English. To select another language, press the **Menu** button on the remote control. Select **Extended** and press \leftarrow/\rightarrow . Select **Language** and press \leftarrow/\rightarrow . Select your language and press \leftarrow/\rightarrow . Press the **Menu** button to exit the menu system.

Wired network configuration

Follow the steps here to configure your projector for your wired network using the projector's menu system.

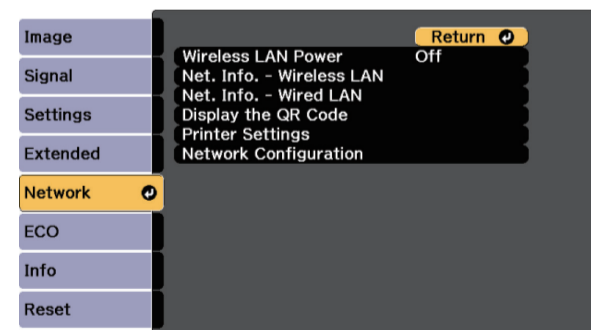

Note: To connect the projector to a wireless network, you need the optional wireless LAN module (part number ELPAP10). For more information about using the projector on a network, see the online *User's Guide*.

- 1 Press the **Menu** button on the remote control, select the **Network** menu, then press \leftarrow/\rightarrow .

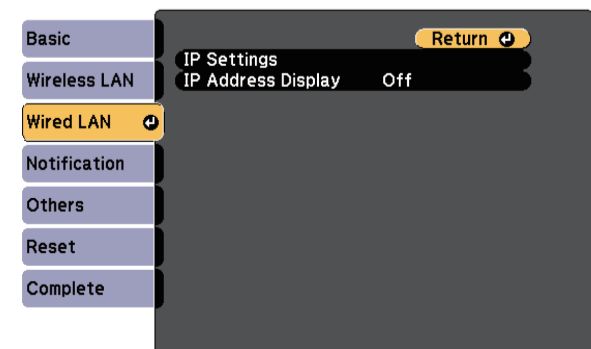

- 2 Choose **Network Configuration** and press \leftarrow/\rightarrow .
- 3 Select the **Wired LAN** menu and press \leftarrow/\rightarrow .



- 4 Choose **IP Settings** and press .
- 5 If your network assigns addresses automatically, make sure the **DHCP** setting is on. If not, make sure DHCP is off and enter the projector's **IP Address, Subnet Mask, and Gateway Address**, as needed. Then press **Esc**.
- 6 When you are finished, select **Complete** and press , then press  again to save your settings.
- 7 Press the **Menu** button to exit the menu system.

Install the optional software

Download the Epson iProjection™ software and manual from your product's support page (see "Where to get help") and install the program on each computer that will project over the network.

To monitor and control your projector over the network, download and install the Epson Projector Management software (Windows only) and manual from your product's support page (see "Where to get help").

Project over a network

If you need to configure the projector for a wired network, see "Wired network configuration" on the front of this sheet.

- 1 Press the **LAN** button on the remote control. You see this screen:



- 2 Start Epson iProjection on your computer.

Windows 10: Select  > **EPSON Projector** > **Epson iProjection Ver X.XX**.

Windows 8.x: Navigate to the **Apps** screen and select **Epson iProjection Ver. X.XX**.

Other versions of Windows: Select  or **Start > Programs** or **All Programs > EPSON Projector > Epson iProjection > Epson iProjection Ver X.XX**.

OS X: Double-click the **Epson iProjection** icon in the Applications folder.

- 3 Select **Advanced Connection Mode** and click **OK**.

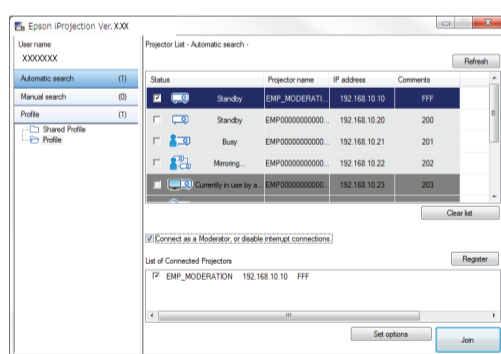

- 4 Select the projector you want to connect to, then click **Join**.

If you don't see the projector you want, click the **Automatic search** button to find the projector automatically, click the **Manual search** button to enter the projector's IP address, or click the **Profile** button to find the projector based on a previously saved profile.

- 5 If you see a message asking for a keyword, enter the four digits that appear on the LAN standby screen and click **OK**.

Your computer image is projected, with a floating toolbar:



When you're done presenting, click **Disconnect All** on the toolbar.

Projecting from a mobile device

You can project wirelessly from a mobile device (iOS, Android™, or Chromebook™) using the Epson iProjection™ app and a QR code.

- 1 Use the following QR code to download and install the Epson iProjection app.



- 2 If you connected the projector to a network wirelessly, make sure to connect your mobile device to the same network.
- 3 Press the **LAN** button on the remote control to display a QR code on the projector screen.
- 4 Start Epson iProjection on your mobile device.
- 5 Use the QR code reader feature to read the QR code displayed.

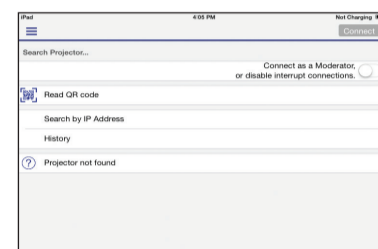

- 6 Follow the app instructions to connect your device to the projector.

For more information on setting up and using this app, visit www.epson.com/projectorapp (U.S.) or www.epson.ca/projectorapp (Canada).

Using web remote

You can use a standard web browser to control the projector through the network. A "virtual remote control" on your computer screen lets you perform many of the same functions as you can with the physical remote control.

- 1 Open your web browser and enter the IP address of the projector you want to monitor in the browser window.

If you're not sure what the IP address of the projector is, turn the projector on and select **Net. Info. - Wired LAN** or **Net. Info. - Wireless LAN** from the Network menu to display the IP address of the projector. (Do not enter the leading zeroes.)

- 2 Enter **EPSONWEB** as the default user name and **admin** as the default password, then click **OK**.

- 3 From the Projector Control menu, select **Web Remote**. Use the on-screen buttons to operate the projector, as you would using the remote control.

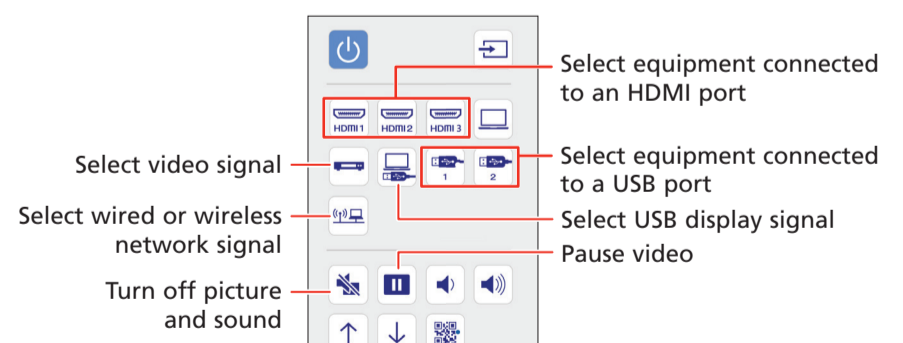

Troubleshooting

If you see a blank screen or the **No signal** message after turning on your computer or video device, check the following:

- Make sure the Status light on the projector is blue and not flashing.
- Press the **Source Search** button on the projector or the remote control to switch to the correct image source, if necessary.
- Press the **Home** button on the projector or remote control to verify the source input and settings.
- On Windows® 7 or later, hold down the Windows key and press **P** at the same time, then click **Duplicate**.
- If you're using a Windows laptop, press the function key on your keyboard that lets you display on an external monitor. It may be labeled **CRT/LCD** or have an icon such as . You may have to hold down the **Fn** key while pressing it (such as **Fn + F7**). Wait a moment for the display to appear.
- If you're using a Mac laptop, open **System Preferences** and select **Displays**. Click the **Arrangement** tab and select the **Mirror Displays** check box.

Where to get help

Manuals

For more information about using the projector, see the online manuals. You can view or download the manuals from the Epson website, as described below.

Internet support services

Visit www.epson.com/support (U.S.) or www.epson.ca/support (Canada) and search for your product to download software and utilities, view manuals, get FAQs and troubleshooting advice, or contact Epson.

Telephone support

To use the Epson PrivateLine® Support service, call (800) 637-7661. This service is available for the duration of your warranty period. You may also speak with a support specialist by calling (562) 276-4394 (U.S.) or (905) 709-3839 (Canada).

Support hours are 6 AM to 8 PM, Pacific Time, Monday through Friday, and 7 AM to 4 PM, Pacific Time, Saturday. Days and hours of support are subject to change without notice. Toll or long distance charges may apply.

Registration

Register today to get product updates and exclusive offers. You can register online at www.epson.com/webreg.

Optional accessories

For a list of optional accessories, see the online *User's Guide*.

You can purchase screens or other accessories from an Epson authorized reseller. To find the nearest reseller, call 800-GO-EPSON (800-463-7766). Or you can purchase online at www.epsonstore.com (U.S. sales) or www.epson.ca (Canadian sales).

Touchboards

205 Westwood Ave, Long Branch, NJ 07740
Phone: 866-94 BOARDS (26273) / (732)-222-1511
Fax: (732)-222-7088 | E-mail: sales@touchboards.com

EPSON®
EXCEED YOUR VISION



EPSON and PowerLite are registered trademarks, Epson iProjection is a trademark, and EPSON Exceed Your Vision is a registered logomark of Seiko Epson Corporation. PrivateLine is a registered trademark of Epson America, Inc.

Mac and OS X are trademarks of Apple Inc., registered in the U.S. and other countries.

Android is a trademark of Google Inc.

General Notice: Other product names used herein are for identification purposes only and may be trademarks of their respective owners. Epson disclaims any and all rights in those marks.

This information is subject to change without notice.

© 2017 Epson America, Inc., 8/17