



Pro L2000UNL/L20002UNL User's Guide

Contents

Pro L20000UNL/L20002UNL User's Guide	11
Introduction to Your Projector	12
Projector Features.....	12
Additional Components	13
Additional Projector Software and Manuals	14
Optional Equipment and Replacement Parts.....	15
Warranty and Registration Information	16
Notations Used in the Documentation	17
Where to Go for Additional Information	17
Projector Part Locations	17
Projector Parts - Front/Top	18
Projector Parts - Side/Rear	19
Projector Parts - Base.....	20
Projector Parts - Interface Ports	21
Projector Parts - Control Panel	23
Projector Parts - Remote Control.....	24
Setting Up the Projector	27
Projector Placement.....	27
Projector Setup and Installation Options	29
Installing the Projector in a Mount.....	30
Protecting the Built-in Camera.....	32
Projection Distance.....	32
Projector Connections	33
Connecting to Video Sources	34
Connecting to an HDMI Video Source	34
Connecting to a Component-to-BNC Video Source	35
Connecting to a Component Video Source	35
Connecting to an SDI Video Source.....	36
Connecting to Computer Sources.....	37
Connecting to a Computer for VGA Video.....	37

Connecting to a Computer for HDMI Video	38
Connecting to a Computer for DVI-D Video	38
Connecting to a Computer for 5 BNC Video.....	39
Connecting to a Computer for DisplayPort Video.....	39
Connecting to an HDBaseT Transmitter	40
Connecting to an External Computer Monitor.....	41
Attaching and Removing a Lens.....	42
Attaching a Lens	42
Removing a Lens	47
Installing Batteries in the Remote Control	48
Using the Projector on a Network	51
Wired Network Projection.....	51
Connecting to a Wired Network	51
Selecting Wired Network Settings	52
Wireless Network Projection	55
Using a QR Code to Connect a Mobile Device	55
Using Quick Wireless Connection (Windows).....	57
Selecting Wireless Network Settings Manually.....	58
Wireless LAN Menu Settings	61
Selecting Wireless Network Settings in Windows	63
Selecting Wireless Network Settings on Mac	64
Setting Up Wireless Network Security	64
Setting Up Projector Network E-Mail Alerts	66
Network Projector E-mail Alert Messages	68
Selecting Other Network Settings.....	68
Setting a Static IP Address on the LCD Screen.....	70
Controlling a Networked Projector Using a Web Browser	71
Web Control Options	73
Viewing an Image Capture of the Displayed Image from a Remote Location	79
Using Crestron Connected	83
Setting Up Crestron Connected.....	84
Controlling a Networked Projector Using Crestron Connected	85
Art-Net Channel Definitions.....	87

Registering a Digital Certificate on the Projector	92
Importing a Web Server Certificate Using the Projector Menus	92
Registering Digital Certificates from a Web Browser	94
Digital Certificate Types	95
Using Basic Projector Features	97
Turning On the Projector	97
Turning Off the Projector	99
Selecting the Language for the Projector Menus	101
Adjusting the Image Height	102
Resizing the Image with the Zoom Button	103
Focusing the Image Using the Focus and Distortion Buttons	103
Setting the Screen Type	105
Adjusting the Image Position Using Lens Shift	106
Adjusting the Image Position Using Screen Position	109
Displaying a Test Pattern	109
Image Shape	110
Correcting Image Shape with H/V Keystone	110
Correcting Image Shape with Quick Corner	112
Correcting Image Shape with Curved Surface	114
Correcting Image Shape with Corner Wall	119
Correcting Image Shape with Point Correction	122
Selecting an Image Source	124
Remote Control Operation	126
Projection Modes	127
Changing the Projection Mode Using the Remote Control	127
Changing the Projection Mode Using the Menus	128
Image Aspect Ratio	129
Changing the Image Aspect Ratio	129
Available Image Aspect Ratios	130
Color Mode	131
Changing the Color Mode	131
Available Color Modes	132
Adjusting the Brightness	132

Constant Brightness Usage Hours	134
Adjusting Luminance Controls.....	136
Adjusting Gamma.....	138
Setting the Date and Time.....	140
Date and Time Settings	141
Adjusting Projector Features	142
Shutting Off the Picture Temporarily	142
Stopping Video Action Temporarily	143
Projector Security Features.....	144
Password Security Types	144
Setting a Password	145
Selecting Password Security Types.....	146
Entering a Password to Use the Projector.....	147
Saving a User's Logo Image to Display.....	148
Locking the Projector's Lens Settings and Buttons.....	150
Unlocking the Projector's Buttons	152
Locking the Remote Control Buttons	152
Installing a Security Cable	154
Projecting Two Images Simultaneously.....	154
Input Sources for Split Screen Projection	156
Using Advanced Image Adjustment Features	156
Using Frame Interpolation	157
Creating Image Presets.....	159
Using MPEG Noise Reduction.....	160
Adjusting Scaled Resolution Images (Super-resolution)	161
Adjusting Detail Enhancement	162
Adjusting the Color Convergence (Panel Alignment).....	163
Adjusting the Color Tone (Color Uniformity)	165
Running Light Source Calibration	167
Using Multiple Projectors	169
Multiple Projector Adjustment Overview.....	169
Projector Identification System for Multiple Projector Control.....	171
Setting the Projector ID.....	171

Setting the Remote Control ID	172
Tiling Images into One Image	173
Configuring Tiling Automatically.....	173
Configuring Tiling Manually.....	176
Blending the Image Edges	178
Adjusting the Black Level	180
Matching Tint and Brightness (Screen Matching)	184
Matching the Screens Automatically.....	185
Matching the Screens Manually	186
Scaling an Image.....	188
Enabling Protocol Emulation	189
Saving Settings to Memory and Using Saved Settings	190
Saving a Scheduled Event	192
Viewing Scheduled Events	194
Editing a Scheduled Event.....	195
Copying Menu Settings Between Projectors	196
Saving Settings to a USB Flash Drive.....	197
Transferring Settings from a USB Flash Drive	198
Saving Settings to a Computer	200
Transferring Settings from a Computer	201
Adjusting the Menu Settings	204
Using the Projector's Menus.....	204
Image Quality Settings - Image Menu	206
Input Signal Settings - Signal Menu.....	210
Projector Feature Settings - Settings Menu.....	214
Projector Setup Settings - Extended Menu.....	218
Projector Network and Camera Settings - Network Menu	225
Projector Information Display - Info Menu	227
Event ID Code List.....	230
Projector Reset Options - Reset Menu	231
Maintaining and Transporting the Projector	233
Projector Maintenance	233
Cleaning the Lens.....	233

Cleaning the Projector Case.....	234
Air Filter and Vent Maintenance	234
Cleaning the Air Filters and Air Intake Vents.....	235
Replacing the Air Filters.....	239
Replacing the Remote Control Batteries	242
Transporting the Projector.....	244
Solving Problems	247
Projection Problem Tips	247
Projector Light Status	248
Viewing Projector Status Information	253
Projector Status Display Messages.....	255
Using the Projector Help Displays	260
Solving Image Problems	261
Solutions When No Image Appears.....	261
Solutions When "No Signal" Message Appears.....	262
Displaying From a PC Laptop	263
Displaying From a Mac Laptop	264
Solutions When "Not Supported" Message Appears	264
Solutions When Only a Partial Image Appears	264
Solutions When the Image is Not Rectangular	265
Solutions When the Image Contains Noise or Static	266
Solutions When the Image is Fuzzy or Blurry	266
Solutions When the Image Brightness or Colors are Incorrect	267
Solutions When Automatic Adjustments are not Applied Correctly.....	268
Solving Projector or Remote Control Operation Problems	269
Solutions to Projector Power or Shut-Off Problems	269
Solutions to Remote Control Problems.....	270
Solutions to Password Problems	271
Solving Network Problems	272
Solutions When Wireless Authentication Fails	272
Solutions When You Cannot Access the Projector Through the Web	273
Solutions When the Image Contains Static During Network Projection	274
Solutions When Network Alert E-Mails are Not Received.....	274

Where to Get Help.....	274
Technical Specifications	276
General Projector Specifications	276
Projector Light Source Specifications.....	277
Remote Control Specifications	278
Projector Dimension Specifications.....	278
Projector Electrical Specifications	278
Projector Environmental Specifications.....	279
Projector Safety and Approvals Specifications.....	280
Safety and Approvals Specifications for Latin America	280
Supported Video Display Formats.....	281
Notices	285
Recycling.....	285
Important Safety Information	285
Important Safety Instructions.....	285
Laser Safety Information	289
Laser Safety Labels	289
Hazard Distance (HD)	293
Typical Setup Configurations (U.S. Only)	296
List of Safety Symbols (corresponding to IEC60950-1 A2).....	298
Manufacturer and Importer Address.....	302
FCC Compliance Statement.....	303
Binding Arbitration and Class Waiver	303
Trademarks	306
Copyright Notice.....	307
A Note Concerning Responsible Use of Copyrighted Materials.....	308
Copyright Attribution	308

Pro L20000UNL/L20002UNL User's Guide

Welcome to the Pro L20000UNL/L20002UNL *User's Guide*.

For a printable PDF copy of this guide, [click here](#).

Introduction to Your Projector

Refer to these sections to learn more about your projector and this manual.

[Projector Features](#)

[Notations Used in the Documentation](#)

[Where to Go for Additional Information](#)

[Projector Part Locations](#)

Projector Features

The Pro L20000UNL and Pro L20002UNL projectors include these special features:

Bright, high-resolution projection system

- Up to 20000 lumens of brightness (white light output and color light output)

Note: Color brightness (color light output) and white brightness (white light output) will vary depending on usage conditions. Color light output measured in accordance with IDMS 15.4; white light output measured in accordance with ISO 21118.

- Native resolution of 1920 × 1200 pixels (WUXGA)

Flexible connectivity

- Wired and wireless network support for projection, monitoring, and control via remote network computer
- Variety of connection methods for a computer or video device including HDMI, BNC, DVI-D, SDI, and HDBaseT
- Ports for connecting an external monitor

Easy-to-use setup and operation features

- Interchangeable bayonet lens options available
- Project images side by side from two separate input sources
- Create one large seamless display when projecting from multiple projectors using Edge Blending
- Epson's Instant Off and Direct Power On features for quick setup and shut down
- Support for Crestron Connected and Art-Net network monitoring systems

- Network message broadcast system to project timely messages to all networked projectors (Windows only)

[Additional Components](#)

[Additional Projector Software and Manuals](#)

[Optional Equipment and Replacement Parts](#)

[Warranty and Registration Information](#)

Parent topic: [Introduction to Your Projector](#)

Related concepts

[Projector Part Locations](#)

[Projector Connections](#)

[Using Multiple Projectors](#)

[Using Crestron Connected](#)

Related topics

[Using the Projector on a Network](#)

Additional Components

Depending on how you plan to use the projector, you may need to obtain additional components.

Note: To connect a Mac that does not include a compatible video output port, you need to obtain an adapter that allows you to connect to an input port on the projector. Contact Apple for compatible adapter options. To connect a smartphone or tablet, you may need to obtain an adapter that allows you to connect to the projector. This allows you to mirror your smartphone or tablet screens, watch movies, and more. Contact your device manufacturer for compatible adapter options.

Unless listed as available from Epson in this table, see your local computer or electronics dealer for purchase information.

Signal or connection type	Additional component necessary
Component video	Component-to-BNC or D-sub, 15-pin, component-to-VGA video cable or adapter Available for purchase from Epson or an authorized Epson reseller.

Signal or connection type	Additional component necessary
HDMI	HDMI cable Available for purchase from Epson or an authorized Epson reseller. You also need a splitter that supports HDMI signals (commercially available).
VGA	VGA computer cable Available for purchase from Epson or an authorized Epson reseller. If you want to connect the projector using a splitter, you also need a splitter that supports VGA signals (commercially available) and a second VGA computer cable.
BNC	VGA-to-5-BNC cable or adapter Available for purchase from Epson or an authorized Epson reseller.
DVI-D	Compatible DVI-D cable
HDBaseT	Compatible 100Base-TX LAN cable
SDI	Compatible BNC video cable
DisplayPort	Compatible DisplayPort cable (with optional DisplayPort interface board installed)

Parent topic: [Projector Features](#)

Related concepts

[Projector Connections](#)

Related references

[Optional Equipment and Replacement Parts](#)

Additional Projector Software and Manuals

After connecting and setting up the projector, install the projector software as necessary. You may need to install it from a software CD, if included, or download the software and manuals as necessary.

You can install the projector software programs listed here and view their manuals for instructions on using them.

Note: If you still need help after checking this manual and the sources listed here, you can use the Epson PrivateLine Support service to get help fast. For details, see "Where to Get Help."

Projector software	Manual	Description
Epson Projector Management (Windows only)	<i>Epson Projector Management Operation Guide</i>	Lets you monitor and control your projector through the network. You can download the latest software and documentation from the Epson web site. Go to epson.com/support (U.S.) or epson.ca/support (Canada) and select your projector.
Epson iProjection (Windows/Mac)	<i>Epson iProjection Operation Guide (Windows/Mac)</i>	Lets you project the computer screens of users over a network. You can download the latest software and documentation from the Epson web site. Go to epson.com/support (U.S.) or epson.ca/support (Canada) and select your projector.
Epson Projector Professional Tool (Windows only)	<i>Epson Projector Professional Tool Operation Guide</i>	Lets you manage multiple Epson projectors simultaneously You can download the latest software and documentation from the Epson web site. Go to epson.com/support (U.S.) or epson.ca/support (Canada) and select your projector.
—	<i>Open Source Software License</i>	You can download this document from the Epson web site. Go to epson.com/support (U.S.) or epson.ca/support (Canada) and select your projector.

Parent topic: [Projector Features](#)

Optional Equipment and Replacement Parts

You can purchase screens, other optional accessories, and replacement parts from an Epson authorized reseller. To find the nearest reseller, call 800-GO-EPSON (800-463-7766) in the U.S. or 800-807-7766 in Canada. Or you can purchase online at epsonstore.com (U.S. sales) or epsonstore.ca (Canadian sales).

Epson offers the following optional accessories and replacement parts for your projector:

Option or part	Part number
Air filter (ELPAF58)	V13H134A58
HDBaseT Transmitter (ELPHD01)	V12H547020
HDMI/DVI-D interface board (ELPIF01)	V12H917F01
DisplayPort interface board (ELPIF03)	V12H916F01
Remote control cable set (ELPKC28)	V12H005C28
Ultra short-throw lens (ELPLX02)	V12H004X02
White ultra short-throw lens (ELPLX02W)	V12H004Y02
Short-throw zoom lens (ELPLU04)	V12H004U04
Wide-throw zoom lens (ELPLW06)	V12H004W06
Wide-throw zoom lens (ELPLW08)	V12H004W08
Middle-throw zoom lens (ELPLM15)	V12H004M0F
Middle-throw zoom lens (ELPLM10)	V12H004M0A
Middle-throw zoom lens (ELPLM11)	V12H004M0B
Long throw zoom lens (ELPLL08)	V12H004L08
Epson Stacking and Rigging Frame (ELPMB57)	V12H989A01

Parent topic: [Projector Features](#)

Warranty and Registration Information

Your projector comes with a basic warranty that lets you project with confidence. For details, see the warranty that came with your projector.

In addition, Epson offers free Extra Care Road Service. In the unlikely event of an equipment failure, you won't have to wait for your unit to be repaired. Instead, Epson will ship you a replacement unit anywhere in the United States, Canada, or Puerto Rico. See the Extra Care Road Service brochure for details.

Note: Availability varies by region.

Register your product online at this site: epson.com/webreg.

Registering also lets you receive special updates on new accessories, products, and services.

Parent topic: [Projector Features](#)

Notations Used in the Documentation

Follow the guidelines in these notations as you read your documentation:

- **Warnings** must be followed carefully to avoid bodily injury.
- **Cautions** must be observed to avoid damage to your equipment.
- **Notes** contain important information about your projector.
- **Tips** contain additional projection information.

Parent topic: [Introduction to Your Projector](#)

Where to Go for Additional Information

Need quick help on using your projector? Here's where to look for help:

- epson.com/support (U.S.), epson.ca/support (Canada), or epson.com.jm/support (Caribbean)

View FAQs (frequently asked questions) and e-mail your questions to Epson technical support 24 hours a day.

- If you still need help after checking this manual and any other sources listed here, you can use the Epson PrivateLine Support service to get help fast. For details, see "Where to Get Help."

Parent topic: [Introduction to Your Projector](#)

Related references

[Where to Get Help](#)

Related topics

[Solving Problems](#)

Projector Part Locations

Check the projector part illustrations to learn about the parts on your projector.

[Projector Parts - Front/Top](#)

[Projector Parts - Side/Rear](#)

[Projector Parts - Base](#)

[Projector Parts - Interface Ports](#)

[Projector Parts - Control Panel](#)

[Projector Parts - Remote Control](#)

Parent topic: [Introduction to Your Projector](#)

Projector Parts - Front/Top

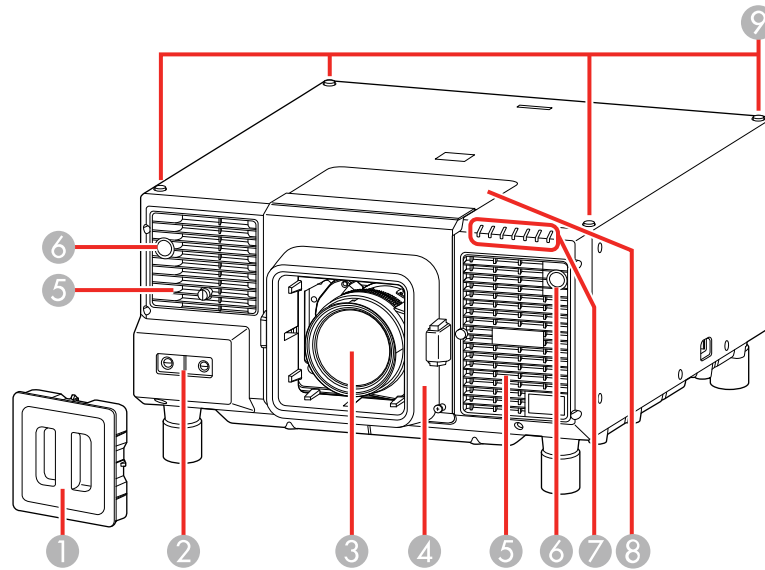

- 1 Cap for lens cover
- 2 Built-in camera
- 3 Projection lens
- 4 Lens cover
- 5 Air filter covers
- 6 Remote receivers
- 7 Status lights
- 8 Replacement lens cover (for certain lenses)
- 9 Holes for optional mounting

Parent topic: [Projector Part Locations](#)

Related topics

[Attaching and Removing a Lens](#)

Projector Parts - Side/Rear

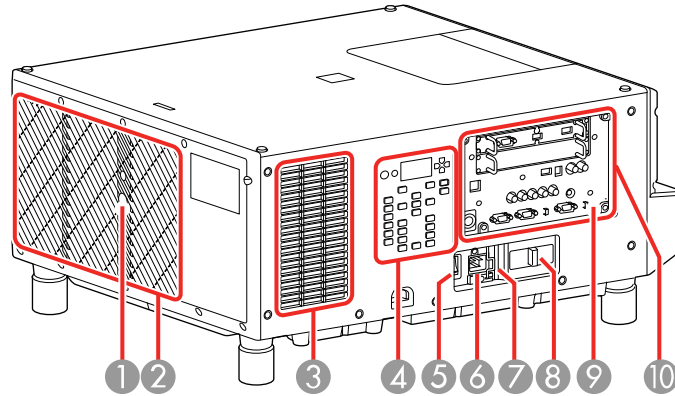

- 1 Remote receiver
- 2 Exhaust vent
- 3 Air intake vent
- 4 Control panel
- 5 Power switch
- 6 AC inlet
- 7 Power cord holder
- 8 Built-in camera protection plate
- 9 Kensington security slot
- 10 Interface ports

Parent topic: [Projector Part Locations](#)

Related tasks

[Installing the Projector in a Mount](#)

Projector Parts - Base

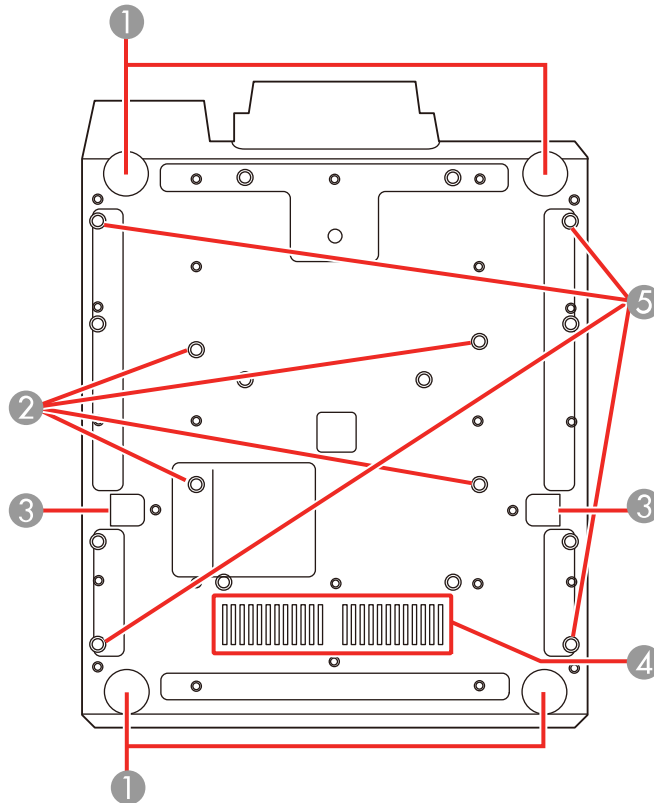

- 1 Projector feet
- 2 Ceiling mounting holes
- 3 Drop-prevention wire installation points
- 4 Air intake vent
- 5 Transportation eye bolt holes

Parent topic: [Projector Part Locations](#)

Related tasks

[Installing a Security Cable](#)

[Transporting the Projector](#)

Projector Parts - Interface Ports

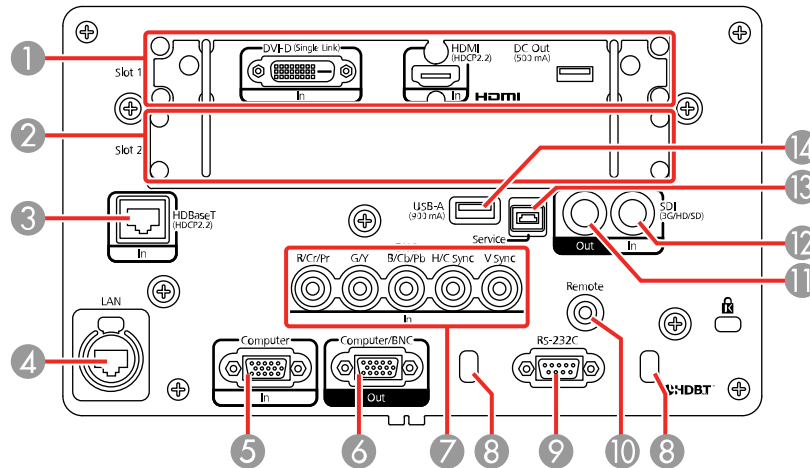

- 1 **Slot 1** for installing an interface board (HDMI/DVI-D interface board described below)
- 2 **Slot 2** for installing an optional DisplayPort interface board (described below)
- 3 **HDBaseT** port
- 4 **Network LAN** port
- 5 **Computer In** port
- 6 **Computer/BNC Out** port
- 7 **BNC In** ports
- 8 **Cable clip** slot
- 9 **RS-232C** port
- 10 **Remote** port
- 11 **SDI Out** port
- 12 **SDI In** port

13 **Service port**

14 **USB-A port**

HDMI/DVI-D Interface Board

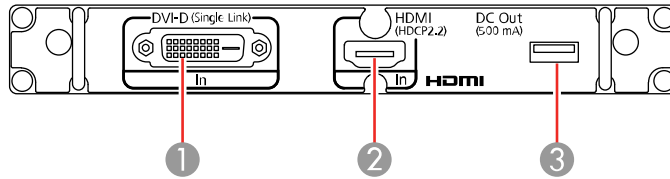

1 **DVI-D In port**

2 **HDMI In port**

3 **DC Out port**

Optional DisplayPort Interface Board

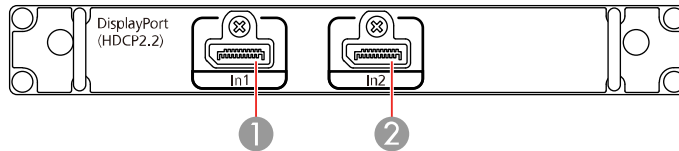

1 **DisplayPort In1 port**

2 **DisplayPort In2 port**

Caution: Do not attempt to install or remove your projector's interface board. Static electricity or other interference may damage the projector or cause it to malfunction. Contact Epson to have an interface board installed or removed.

Parent topic: [Projector Part Locations](#)

Related references

[Optional Equipment and Replacement Parts](#)

Projector Parts - Control Panel

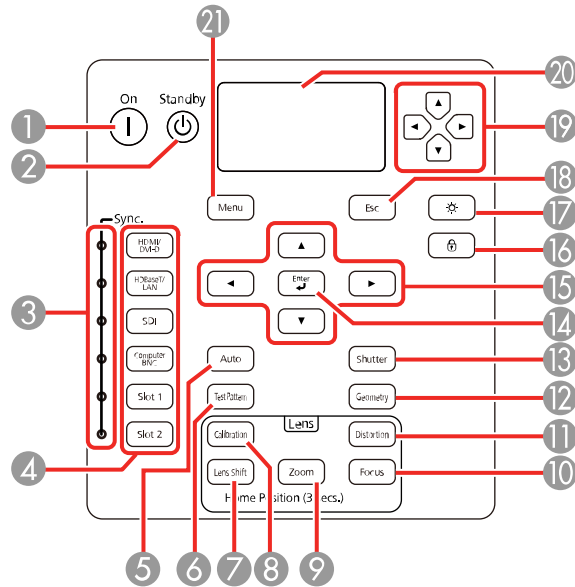

- 1 **On** button (turns on the projector)
- 2 **Standby** button (turns off the projector)
- 3 **Sync.** lights (indicate the selected image source)
- 4 **Sync.** buttons (select an image source)
- 5 **Auto** button (automatically adjusts computer images)
- 6 **Test Pattern** button (displays a test pattern)
- 7 **Lens Shift** button (adjusts the image position)
- 8 **Calibration** button (starts lens calibration)
- 9 **Zoom** button (changes the image size)
- 10 **Focus** button (adjusts the image focus)
- 11 **Distortion** button (corrects image distortion)
- 12 **Geometry** button (adjusts the image shape)

- 13 **Shutter** button (turns input signal on or off temporarily)
- 14 **Enter** button (selects options)
- 15 Arrow buttons (move through on-screen options; adjust the focus, zoom, and lens shift)
- 16 Lock button (displays the Control Panel Lock screen)
- 17 Light button (lights up the control panel buttons and LCD screen temporarily)
- 18 **Esc** button (cancels/exits functions)
- 19 Arrow buttons (select LCD screen settings)
- 20 LCD screen (displays projector status information)
- 21 **Menu** button (accesses projector menu system)

Parent topic: [Projector Part Locations](#)

Projector Parts - Remote Control

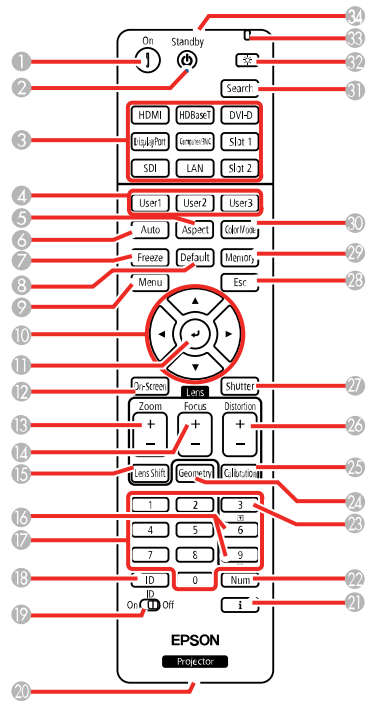

- 1 **On** button (turns on the projector)
- 2 **Standby** button (turns off the projector)
- 3 Source buttons (select an image source)
- 4 **User1**, **User2**, and **User3** buttons (open menu assigned by user)
- 5 **Aspect** button (selects the image aspect ratio)
- 6 **Auto** button (automatically adjusts computer images)
- 7 **Freeze** button (stops video action)
- 8 **Default** button (resets settings to their default values in the projector menu system)
- 9 **Menu** button (accesses projector menu system)
- 10 Arrow buttons (move through on-screen options and move pointer)
- 11 Enter button (selects options)
- 12 **On-Screen** button (displays or hides the on-screen menus or messages)
- 13 **Zoom** button (changes the image size)
- 14 **Focus** button (adjusts the image focus)
- 15 **Lens Shift** button (adjusts the image position)
- 16 Page up and down buttons (scroll through image files when projecting from a computer over a network connection, or change the displayed test pattern)
- 17 Numeric buttons (enter numbers)
- 18 **ID** button (hold down and use numeric keys to select projector to control)
- 19 **ID** switch (selects control of one or all projectors from the remote control)
- 20 Remote port (connects to a remote control cable)
- 21 **i** button (displays the Info menu)
- 22 **Num** button (hold down and use numeric keys to enter numbers)
- 23 **Test Pattern** button (displays a test pattern)
- 24 **Geometry** button (corrects image shape)
- 25 **Calibration** button (starts lens calibration)
- 26 **Distortion** button (corrects image distortion)
- 27 **Shutter** button (turns signal on or off temporarily)

- 28 **Esc** button (cancels/exits functions and moves to previous menu levels)
- 29 **Memory** button (saves and applies presets)
- 30 **Color Mode** button (selects display modes)
- 31 **Search** button (searches for connected sources)
- 32 Light button (lights up the remote control buttons temporarily)
- 33 Indicator light (lights up when the remote control is in use)
- 34 Remote control signal emitter (emits remote control signals)

Parent topic: [Projector Part Locations](#)

Setting Up the Projector

Follow the instructions in these sections to set up your projector for use.

[Projector Placement](#)

[Projector Connections](#)

[Attaching and Removing a Lens](#)

[Installing Batteries in the Remote Control](#)

Projector Placement

You can place the projector on almost any flat surface to project an image.

You can also install the projector in a ceiling mount if you want to use it in a fixed location.

Keep these considerations in mind as you select a projector location:

- Place the projector on a sturdy, level surface or install it using a compatible mount.
- Install the projector at any angle. There is no vertical or horizontal limit to how the projector can be installed.

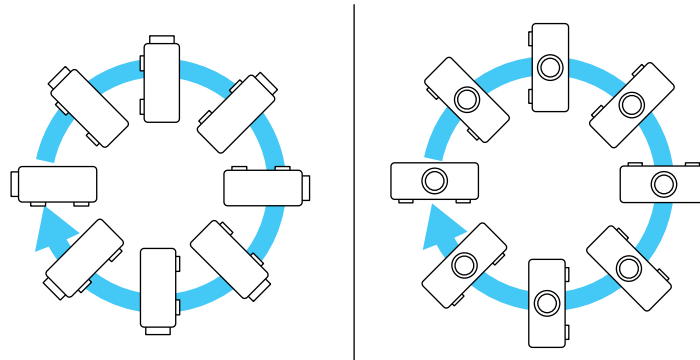

- Leave plenty of space around and under the projector for ventilation as described here, and do not place it on top of or next to anything that could block the vents.
- Place the projector parallel to the screen.
- Position the projector within reach of a grounded electrical outlet or extension cord.

Caution: Be sure to leave the following amount of space around the projector to avoid blocking the air exhaust and intake vents.

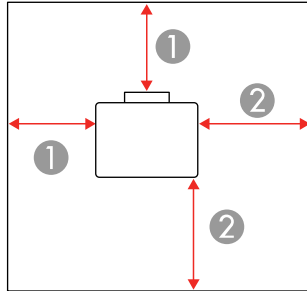

- 1 7.87 inches (20 cm)
- 2 19.7 inches (50 cm)

Caution: If you are setting up the projector with the intake vent facing down or placing the projector in a mount, be sure to leave the following amount of space around the projector.

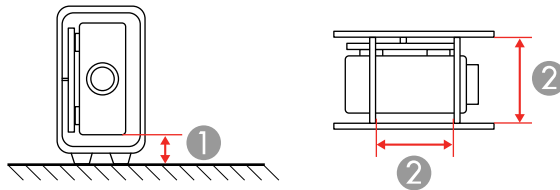

- 1 3.9 inches (10 cm)
- 2 7.87 inches (20 cm)

Note: When setting up multiple projectors, leave the following amount of space between the projectors.

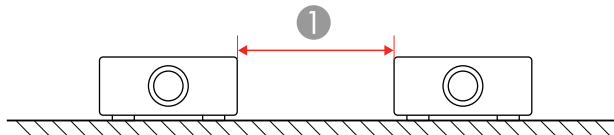

- 1 19.7 inches (50 cm)

If you are stacking multiple projectors, follow these guidelines:

- Do not stack more than two projectors.
- Tilt the projectors only within the extendable range of the feet.
- Make sure all of the projector's feet sit firmly on the projector below.

[Projector Setup and Installation Options](#)

[Installing the Projector in a Mount](#)

[Protecting the Built-in Camera](#)

[Projection Distance](#)

Parent topic: [Setting Up the Projector](#)

Projector Setup and Installation Options

You can set up or install your projector in the following ways:

Front

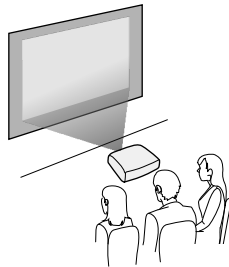

Rear

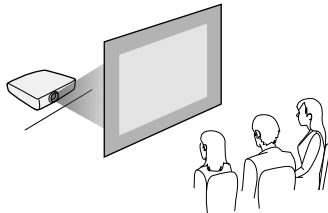

Front ceiling

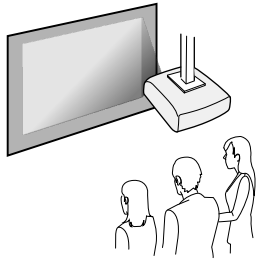

Rear ceiling

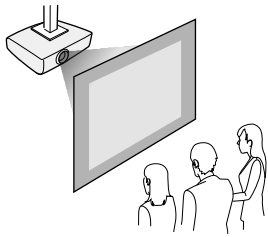

If you project from the ceiling or from the rear, select the correct **Projection** setting and, if necessary, adjust the **OSD Rotation** setting.

Parent topic: [Projector Placement](#)

Related references

[Projector Setup Settings - Extended Menu](#)

Installing the Projector in a Mount

When installing the projector in an optional mount, follow these guidelines:

- When using a ceiling or portrait mount, use commercially available M6 screws (up to a depth of 1.06 inches [27 mm]) to attach the mount to the projector at these four points:

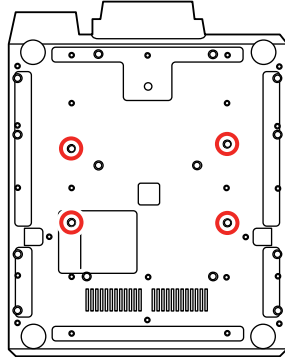

- When using a clamp to attach the projector to an aluminum truss, use commercially available M6 screws (up to a depth of 1.06 inches [27 mm]) to attach the clamp to at least four points on the projector. You can use any of these points on the projector to accommodate the distance between the screw holes and the center of the aluminum truss pipe.

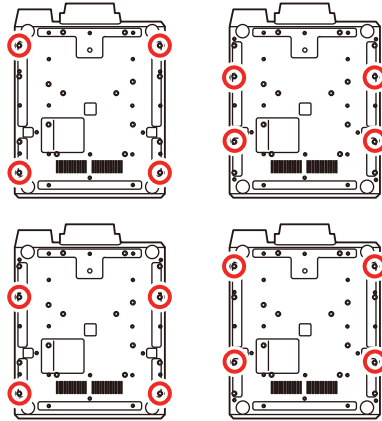

Caution: Make sure to attach a commercially available drop-prevention wire that supports weights of at least 220 lb (100 kg) to secure the projector to the mount to prevent it from falling. Make sure there is no slack in the wire and that it is securely attached to the two connection points on the bottom of the projector.

Parent topic: [Projector Placement](#)

Related references

[Projector Parts - Side/Rear](#)

Protecting the Built-in Camera

If you use the projector near other devices that emit laser beams, install the protective plate over the built-in camera to protect it from interference.

Remove the protective plate from its storage area on the side of the projector and place it over the built-in camera on the front of the projector. When you finish, remove the protective plate from the camera and return it to its storage area.

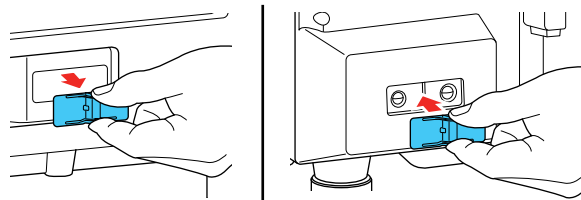

Parent topic: [Projector Placement](#)

Related references

[Projector Parts - Front/Top](#)

Projection Distance

The distance at which you place the projector from the screen determines the approximate size of the image. The image size increases the farther the projector is from the screen, but can vary depending on the zoom factor, aspect ratio, and other settings.

Use the tables here to determine approximately how far to place the projector from the screen based on the installed lens and the size of the projected image. (Conversion figures may have been rounded up or down.)

You can also use the projector Throw Distance Calculator at epson.com/support (U.S.) or epson.ca/support (Canada).

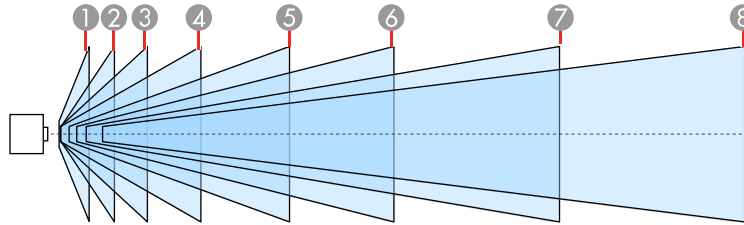

Number	Lens	Screen size	Projection distance
1	ELPLX02 ELPLX02W	100 to 1000 inches (254 to 2540 cm)	29.1 to 302.8 inches (74 to 769 cm)
2	ELPLU04	60 to 1000 inches (152.4 to 2540 cm)	31.5 to 670.0 inches (80 to 1702 cm)
3	ELPLW08		42.9 to 1039.0 inches (109 to 2639 cm)
4	ELPLW06		58.7 to 1395.3 inches (149 to 3544 cm)
5	ELPLM15		78.3 to 2190.2 inches (199 to 5563 cm)
6	ELPLM10		120.5 to 3183.5 inches (306 to 8086 cm)
7	ELPLM11		175.2 to 4648.4 inches (445 to 11807 cm)
8	ELPLL08		261.4 to 6367.7 inches (664 to 16174 cm)

Note: If the screen is larger than 500 inches (1270 cm), fine text and images may not display clearly.

Parent topic: [Projector Placement](#)

Related references

[Optional Equipment and Replacement Parts](#)

Projector Connections

See these sections to connect the projector to a variety of projection sources.

Caution: If you will use the projector at altitudes above 4921 feet (1500 m), turn on **High Altitude Mode** to ensure the projector's internal temperature is regulated properly.

- [Connecting to Video Sources](#)
- [Connecting to Computer Sources](#)
- [Connecting to an HDBaseT Transmitter](#)
- [Connecting to an External Computer Monitor](#)

Parent topic: [Setting Up the Projector](#)

Related references

[Projector Setup Settings - Extended Menu](#)

Connecting to Video Sources

Follow the instructions in these sections to connect video devices to the projector.

- [Connecting to an HDMI Video Source](#)
- [Connecting to a Component-to-BNC Video Source](#)
- [Connecting to a Component Video Source](#)
- [Connecting to an SDI Video Source](#)

Parent topic: [Projector Connections](#)

Connecting to an HDMI Video Source

If your video source has an HDMI port, you can connect it to the projector using an optional HDMI cable. The HDMI connection provides the best image quality.

1. Connect the HDMI cable to your video source's HDMI output port.
2. Connect the other end to the projector's **HDMI In** port on the HDMI/DVI-D board in slot 1. If you are connecting an optical HDMI cable, you must also connect the cable's USB power connector to the **DC Out** port on the board.

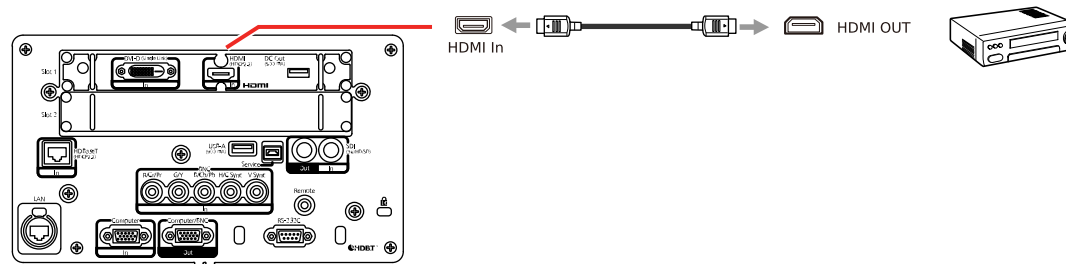

Note: Depending on the length and performance quality of the HDMI cable, images may not display correctly. For best results, use a cable that conforms to the HDMI standard.

Parent topic: [Connecting to Video Sources](#)

Connecting to a Component-to-BNC Video Source

If your video source has component video ports, you can connect it to the projector using an optional component-to-BNC video cable. Depending on your component ports, you may need to use an adapter cable along with a component video cable.

1. Connect the component connectors to your video source's color-coded component video output ports, usually labeled **Y**, **Pb**, **Pr** or **Y**, **Cb**, **Cr**. If you are using an adapter, connect these connectors to your component video cable.
2. Connect the BNC connectors to the projector's **R/Cr/Pr**, **G/Y**, **B/Cb/Pb** ports.

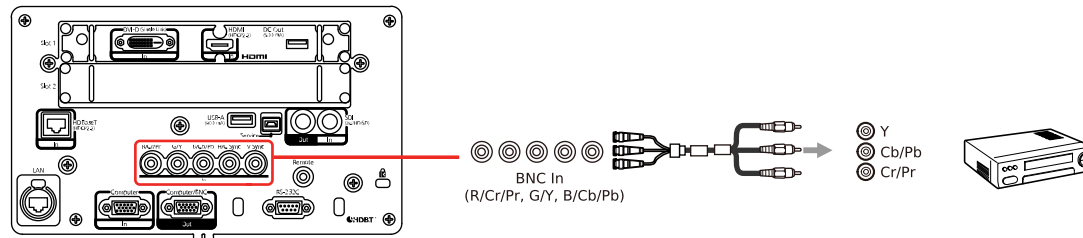

Parent topic: [Connecting to Video Sources](#)

Connecting to a Component Video Source

If your video source has component video ports, you can connect it to the projector using an optional component-to-VGA video cable. Depending on your component ports, you may need to use an adapter cable along with a component video cable.

1. Connect the component connectors to your video source's color-coded component video output ports, usually labeled **Y**, **Pb**, **Pr** or **Y**, **Cb**, **Cr**. If you are using an adapter, connect these connectors to your component video cable.

2. Connect the VGA connector to the **Computer In** port on the projector.

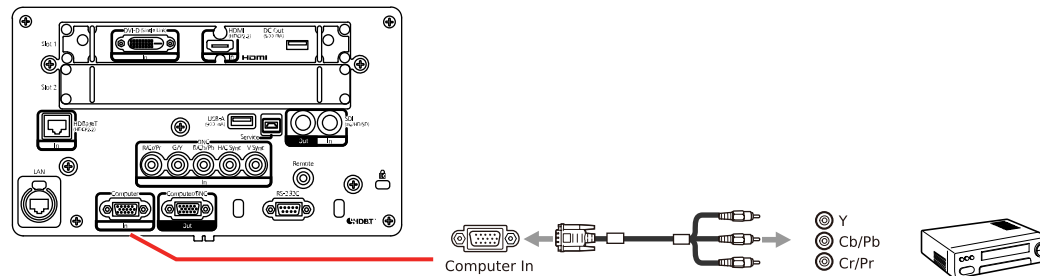

3. Tighten the screws on the VGA connector.

If your image colors appear incorrect, you may need to change the **Input Signal** setting in the projector's Signal menu.

Parent topic: [Connecting to Video Sources](#)

Related references

[Input Signal Settings - Signal Menu](#)

Connecting to an SDI Video Source

If your video source has an SDI port, you can connect it to the projector using an optional BNC video cable.

1. Connect the BNC video cable to your video source's SDI output port.
2. Connect the other end to the projector's **SDI In** port.

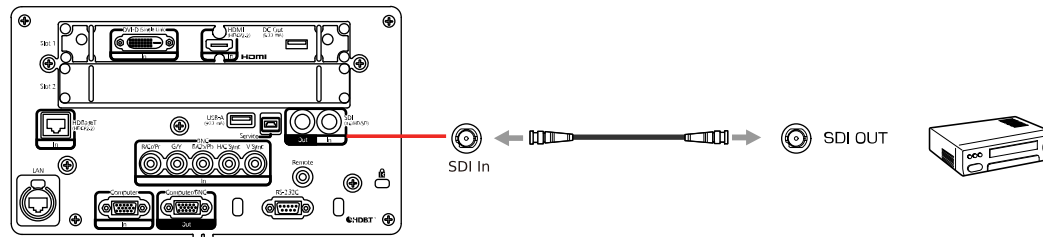

Note: Select the signal for the **SDI In** port in the **SDI Settings** in the Extended menu.

Parent topic: [Connecting to Video Sources](#)

Related references

[Projector Setup Settings - Extended Menu](#)

Connecting to Computer Sources

Follow the instructions in these sections to connect a computer to the projector.

[Connecting to a Computer for VGA Video](#)

[Connecting to a Computer for HDMI Video](#)

[Connecting to a Computer for DVI-D Video](#)

[Connecting to a Computer for 5 BNC Video](#)

[Connecting to a Computer for DisplayPort Video](#)

Parent topic: [Projector Connections](#)

Connecting to a Computer for VGA Video

You can connect the projector to your computer using a VGA computer cable.

Note: To connect a Mac that does not include a compatible video output port, you need to obtain an adapter that allows you to connect to an input port on the projector. Contact Apple for compatible adapter options. To connect a smartphone or tablet, you may need to obtain an adapter that allows you to connect to the projector. This allows you to mirror your smartphone or tablet screens, watch movies, and more. Contact your device manufacturer for compatible adapter options.

1. If necessary, disconnect your computer's monitor cable.
2. Connect the VGA computer cable to your computer's monitor port.
3. Connect the other end to the **Computer In** port on the projector.

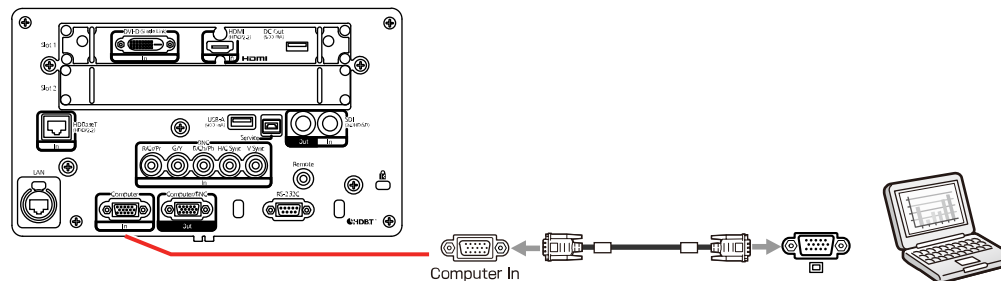

4. Tighten the screws on the VGA connector.

Parent topic: [Connecting to Computer Sources](#)

Connecting to a Computer for HDMI Video

If your computer has an HDMI port, you can connect it to the projector using an optional HDMI cable.

Note: To connect a Mac that does not include a compatible video output port, you need to obtain an adapter that allows you to connect to an input port on the projector. Contact Apple for compatible adapter options. To connect a smartphone or tablet, you may need to obtain an adapter that allows you to connect to the projector. This allows you to mirror your smartphone or tablet screens, watch movies, and more. Contact your device manufacturer for compatible adapter options.

1. Connect the HDMI cable to your computer's HDMI output port.
2. Connect the other end to the projector's **HDMI In** port on the HDMI/DVI-D board in slot 1. If you are connecting an optical HDMI cable, you must also connect the cable's USB power connector to the **DC Out** port on the board.

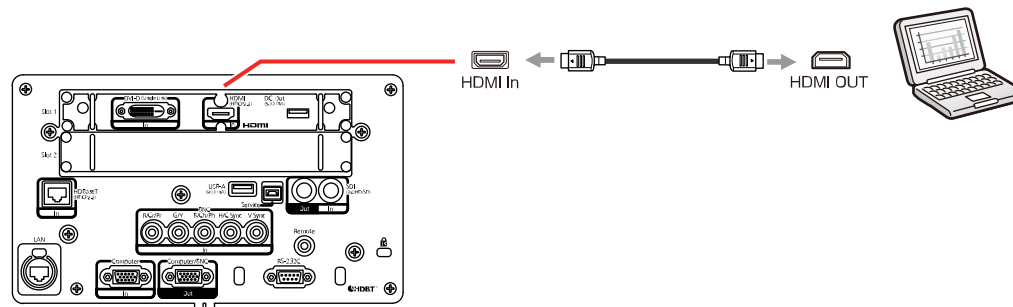

Note: Depending on the length and performance quality of the HDMI cable, images may not display correctly. For best results, use a cable that conforms to the HDMI standard.

Parent topic: [Connecting to Computer Sources](#)

Connecting to a Computer for DVI-D Video

If your computer has a DVI-D connector, you can connect it to the projector using an optional DVI-D cable.

1. Connect the DVI-D cable to your computer's DVI-D connector.

2. Connect the other end to the projector's **DVI-D In** port on the HDMI/DVI-D interface board in slot 1.

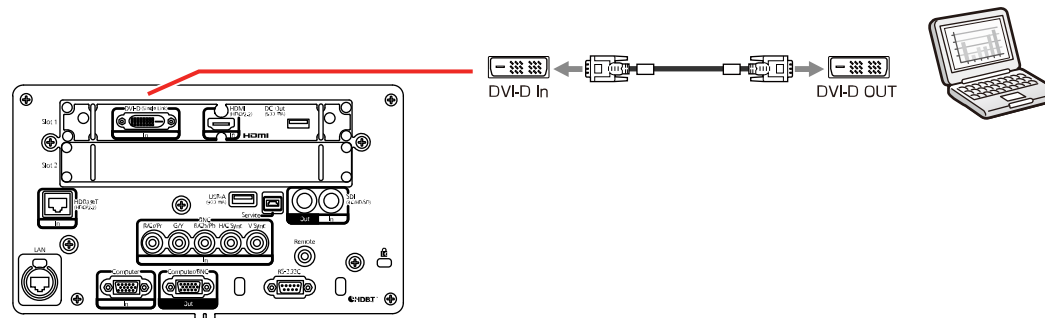

Parent topic: [Connecting to Computer Sources](#)

Connecting to a Computer for 5 BNC Video

You can connect the projector to your computer using an optional VGA-to-5-BNC cable.

1. Connect the VGA connector to your computer's monitor port.
2. Connect the 5 BNC connectors to the projector's **BNC In** ports.

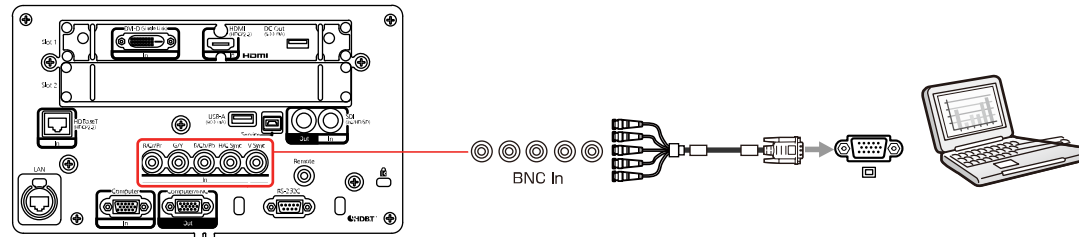

Parent topic: [Connecting to Computer Sources](#)

Connecting to a Computer for DisplayPort Video

If your computer has a DisplayPort connector, you can connect it to the projector using an optional DisplayPort cable. You must have installed the optional DisplayPort interface board in slot 2 to provide a DisplayPort connection.

1. Connect the DisplayPort cable to your computer's DisplayPort connector.

2. Connect the other end to the projector's **DisplayPort In** port on the optional DisplayPort interface board in slot 2.

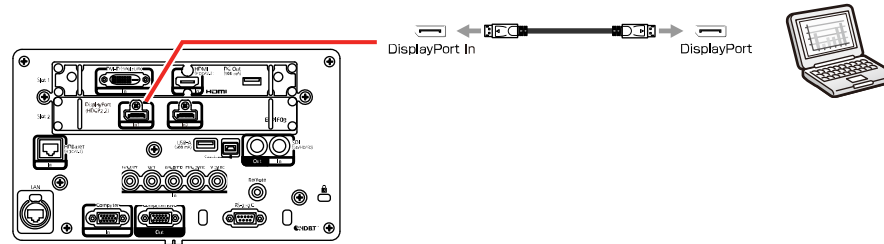

Parent topic: [Connecting to Computer Sources](#)

Related references

[Optional Equipment and Replacement Parts](#)

Connecting to an HDBaseT Transmitter

To send an HDMI or RS-232C signal over a long distance, you can connect the projector to an optional HDBaseT transmitter using a 100Base-TX network cable. This is useful when you want to send a signal to or control the projector from a remote location, such as in a hall or event site, since you can use a network cable up to 328 feet (100 m) in length. To ensure proper data transmission, use a Category 6 STP cable or better.

1. Turn off the projector and HDBaseT transmitter.

Note: Make sure the projector and HDBaseT transmitter are turned off when connecting or disconnecting a network cable between the two devices.

2. Connect one end of the network cable to the **HDBaseT** port on the transmitter.
3. Connect the other end to the projector's **HDBaseT** port.

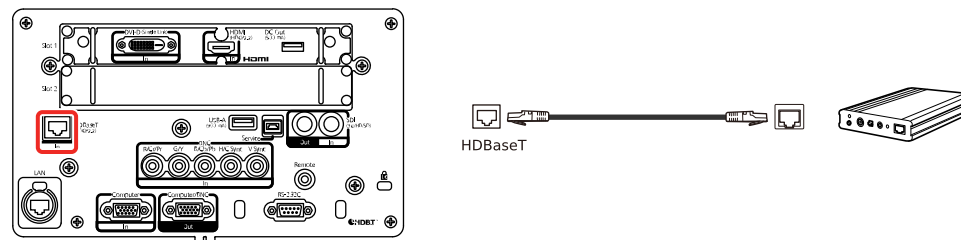

Note: See the documentation that came with the HDBaseT transmitter for instructions on connecting it to your video device or computer.

4. Turn on the projector and HDBaseT transmitter.

Note: To enable communication from the Ethernet and serial ports on the transmitter, select **On** as the **Control Communications** setting in the projector's Extended menu. Turning on this setting disables the projector's **LAN**, **RS-232C**, and **Remote** ports. If you connected an Extron XTP transmitter or switcher to the projector's **HDBaseT** port, select **On** as the **Extron XTP** setting in the projector's Extended menu.

Parent topic: [Projector Connections](#)

Related references

[Projector Setup Settings - Extended Menu](#)

Connecting to an External Computer Monitor

If you connected a computer to the projector's **Computer In** or **BNC In** ports, or a video source to the projector's **SDI In** port, you can also connect an external monitor to the projector. This lets you see your presentation on the external monitor even when the projected image is not visible.

1. Make sure your computer or video source is connected to the projector's **Computer In**, **BNC In**, or **SDI In** port.

2. Connect the external monitor's cable to your projector's **Computer/BNC Out** (for computer or BNC sources) or **SDI Out** (for SDI sources) port.

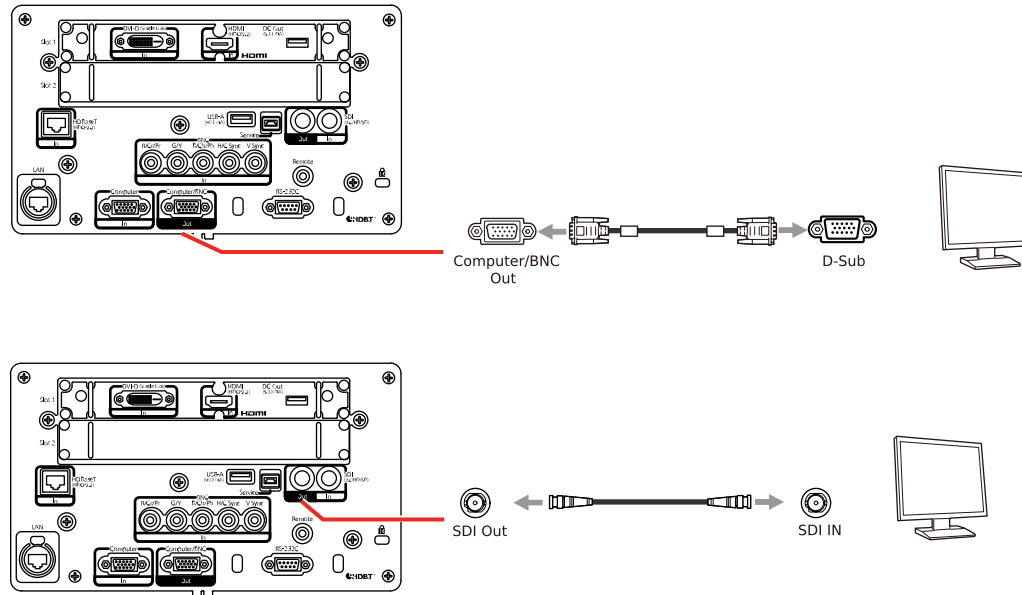

Parent topic: [Projector Connections](#)

Attaching and Removing a Lens

Follow the instructions in these sections to attach or remove a compatible lens.

[Attaching a Lens](#)

[Removing a Lens](#)

Parent topic: [Setting Up the Projector](#)

Attaching a Lens

You can attach a compatible lens to the projector.

Warning: Turn off the projector and unplug its power cord before attaching or removing a lens; otherwise you could receive an electric shock.

1. Turn off the projector and unplug the power cord.

Caution: Avoid touching the lens with your bare hands to prevent fingerprints on or damage to the lens surface. Make sure the front of the projector is not facing up when you attach the lens. This prevents dirt or dust from entering the projector and lowering the projection quality.

2. Use your hand to loosen the screw securing the lens cover to the projector.

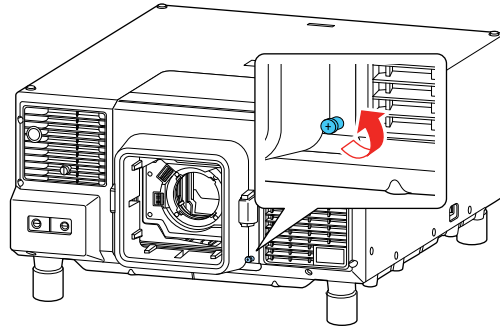

3. Press the buttons on the sides of the lens cover and pull the lens cover off the projector.
4. If you are attaching the ELPLX02 or ELPLX02W lens, loosen the screws securing the lens replacement cover on top of the projector and slide the cover off as shown.

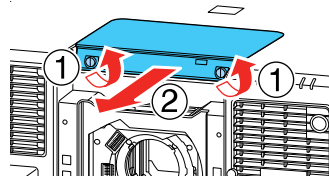

5. If the lens lock lever is in the **Lock** position, release the lock lever. Pull the black lever up (1), pinch the metal tab against the lever, move it toward the **Release** position until it stops (2), and then push the black lever in as shown (3).

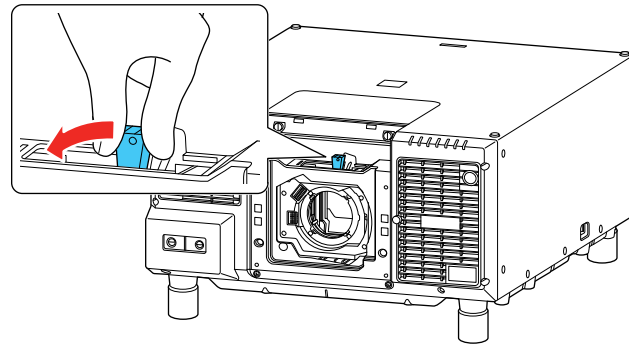
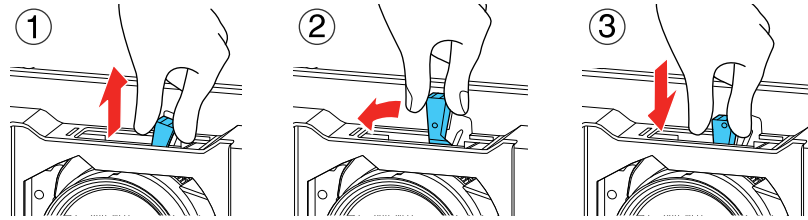

6. If the lens has a cap covering its narrower end, remove the cap and store it for use if you remove the lens later.

7. Position the lens so the white circle is on top and insert the lens straight into the projector's lens socket.

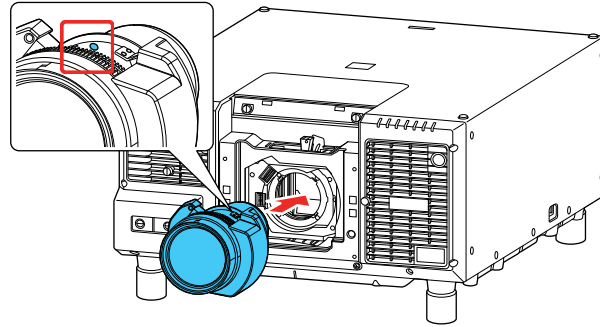

8. Hold the lens firmly as you lock the lens in place. Pull the black lever up (1), pinch the metal tab against the lever, move it toward the **Lock** position until it stops (2), and then push the black lever in as shown (3).

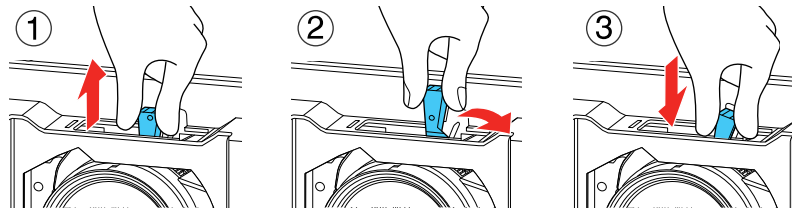
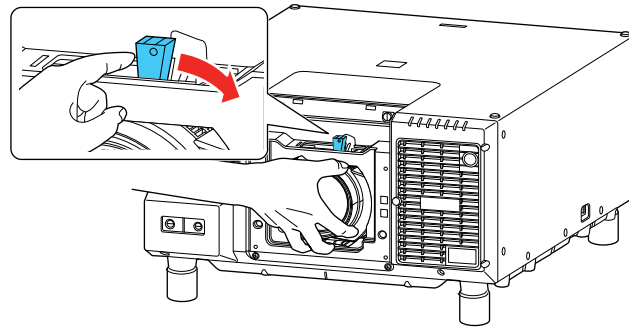

9. Replace the lens cover as shown.

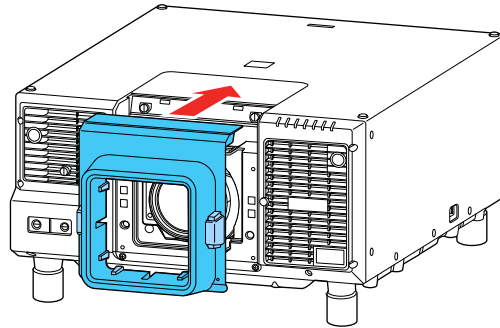

10. Tighten the screw to secure the lens cover to the projector.

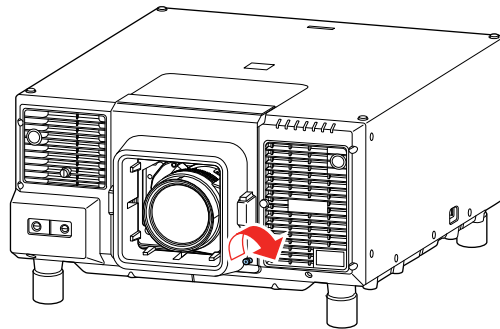

11. Do one of the following:

- If you attach a lens that is different from the previous lens, you see a message to calibrate the lens the next time you turn on the projector. Select **Yes** to calibrate the lens.
- If you remove and attach the same lens, press and hold the **Default** button on the remote control for at least 3 seconds or select **Lens Calibration** in the Extended menu to calibrate the lens.

Lens calibration takes up to 3 minutes to complete. When calibration is finished, the lens returns to its previous position.

Caution: If you see a message that lens calibration failed, turn off the projector, unplug the power cord, remove the lens, and reinstall it. If you continue to see an error message, contact Epson.

Parent topic: [Attaching and Removing a Lens](#)

Related references

[Projector Setup Settings - Extended Menu](#)

Removing a Lens

You can remove a lens to replace it with a different lens.

Warning: Turn off the projector and unplug its power cord before attaching or removing a lens; otherwise you could receive an electric shock.

Caution: Remove the lens only when necessary and make sure the front of the projector is not facing up when you remove the lens. This prevents dirt or dust from entering the projector and lowering the projection quality. Avoid touching the lens with your bare hands to prevent fingerprints on or damage to the lens surface.

1. Center the lens using the **Lens Shift** button.
2. Turn off the projector and unplug the power cord.

Warning: Wait about 30 minutes after turning off the projector before removing the lens. Touching the lens immediately after projecting or turning off the projector may cause burns.

3. Use your hand to loosen the screw securing the lens cover to the projector.

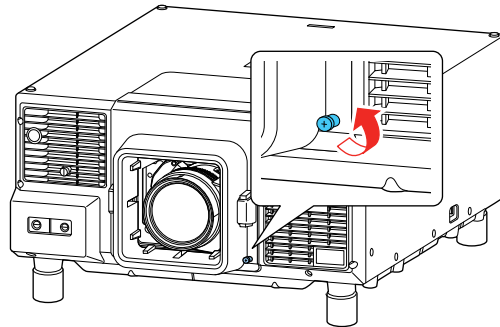

4. Press the buttons on the sides of the lens cover and pull the lens cover off the projector.
5. Hold the lens firmly as you release the lens lock. Pull the black lever up (1), pinch the metal tab against the lever, move it toward the **Release** position until it stops (2), and then push the black lever in as shown (3).

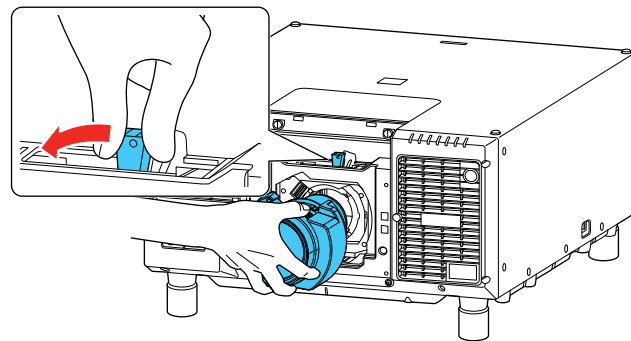
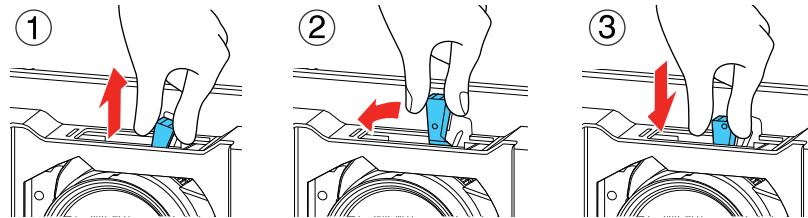

6. Remove the lens from the projector.
7. If you are not attaching a different lens right away, replace the lens cover and lens cover cap to protect the projector.

Parent topic: [Attaching and Removing a Lens](#)

Related tasks

[Adjusting the Image Position Using Lens Shift](#)

Installing Batteries in the Remote Control

The remote control uses the two AA batteries that came with the projector.

Caution: Use only the type of batteries specified in this manual. Do not install batteries of different types, or mix new and old batteries.

1. Remove the battery cover.

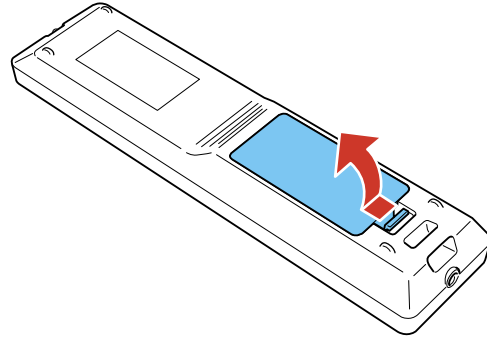

2. Insert the batteries with the + and – ends facing as shown.

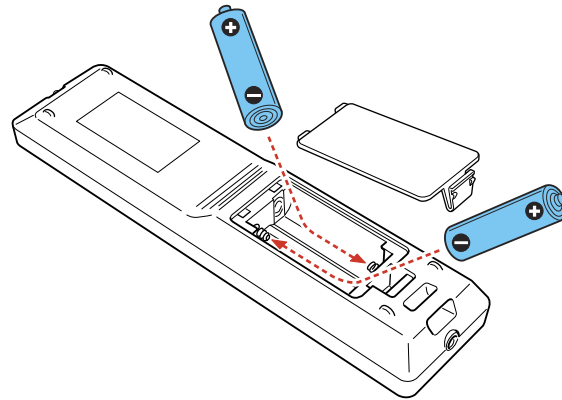

Warning: Make sure the batteries are inserted in the correct positions. If the batteries are not inserted correctly, they could explode or leak, causing a fire, injury, or damage to the product.

3. Replace the battery cover and press it down until it clicks into place.

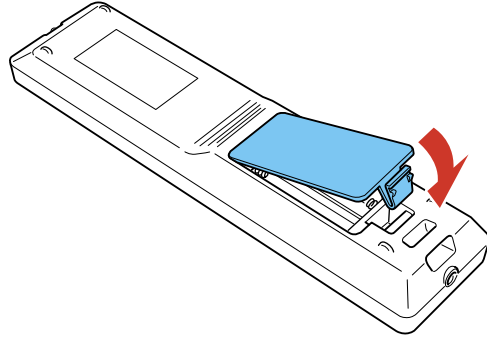

Warning: Dispose of used batteries according to local regulations. Do not expose batteries to heat or flame. Keep batteries out of the reach of children; they are choking hazards and are very dangerous if swallowed.

Parent topic: [Setting Up the Projector](#)

Using the Projector on a Network

Follow the instructions in these sections to set up your projector for use on a network.

[Wired Network Projection](#)

[Wireless Network Projection](#)

[Setting Up Projector Network E-Mail Alerts](#)

[Selecting Other Network Settings](#)

[Setting a Static IP Address on the LCD Screen](#)

[Controlling a Networked Projector Using a Web Browser](#)

[Using Crestron Connected](#)

[Art-Net Channel Definitions](#)

[Registering a Digital Certificate on the Projector](#)

Wired Network Projection

You can project through a wired network. To do this, you connect the projector to your network with an Ethernet cable, and then set up your projector and computer for network projection.

After connecting and setting up the projector, install the projector software. You may need to install it from a software CD, if included, or download the software and manuals as necessary.

Note: If your projector is connected via a LAN (Ethernet) cable to a network that includes a wireless access point, you can connect to the projector wirelessly through the access point using the Epson network software.

[Connecting to a Wired Network](#)

[Selecting Wired Network Settings](#)

Parent topic: [Using the Projector on a Network](#)

Related references

[Additional Projector Software and Manuals](#)

Connecting to a Wired Network

To connect the projector to a wired local area network (LAN), use a 100Base-TX or 10Base-T network cable. You can also connect a commercially available etherCON LAN cable. To ensure proper data transmission, use a Category 5 shielded cable or better.

1. Connect one end of the network cable to your network hub, switch, or router.
2. Connect the other end of the cable to the projector's **LAN** port.

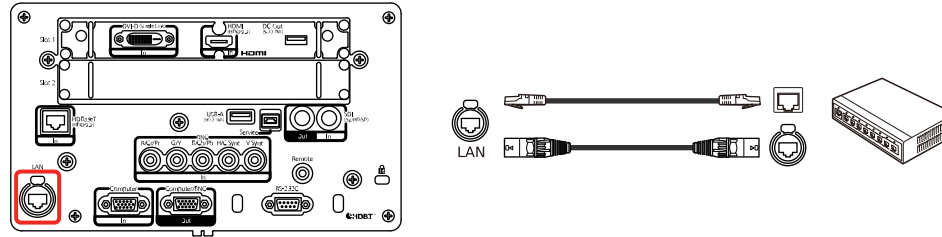

Parent topic: [Wired Network Projection](#)

Selecting Wired Network Settings

Before you can project from computers on your network, you must select the network settings for the projector using its menu system.

Note: Make sure you already connected the projector to your wired network using the **LAN** port.

1. Turn on the projector.
2. Press the **Menu** button.
3. Select the **Network** menu and press **Enter**.

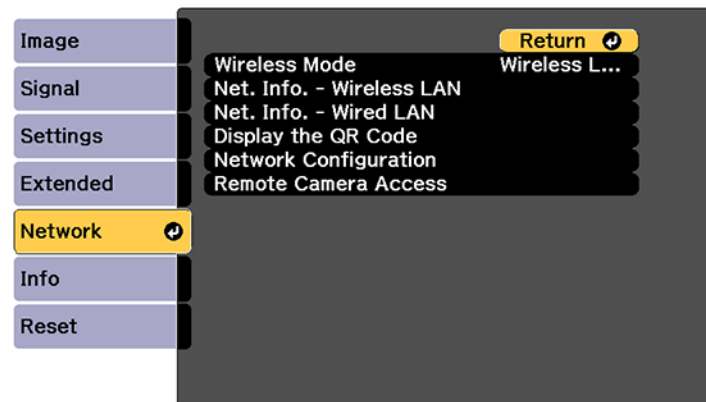

4. Select **Network Configuration** and press **Enter**.
5. Select the **Basic** menu and press **Enter**.

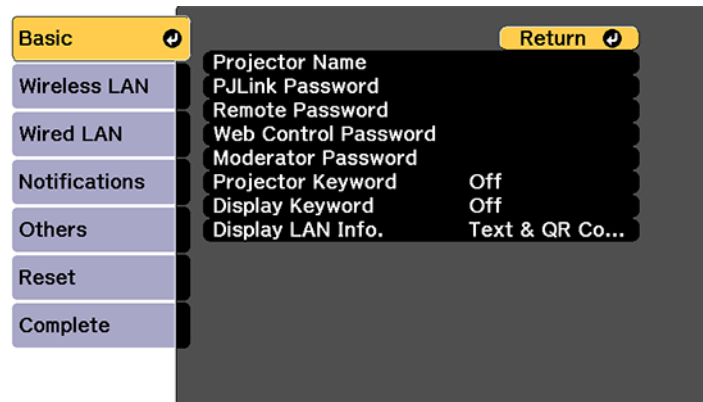

6. Select the following basic options as necessary:
 - **Projector Name** lets you enter a name up to 16 alphanumeric characters long to identify the projector over the network.
 - **PJLink Password** lets you enter a password up to 32 alphanumeric characters long for using the PJLink protocol for projector control.
 - **Remote Password** lets you enter a password up to 8 alphanumeric characters long for accessing the Remote screen in Epson Web Control. (Default user name is **EPSONREMOTE**; default password is **guest**.)
 - **Web Control Password** lets you enter a password up to 8 alphanumeric characters long for accessing Epson Web Control. (Default user name is **EPSONWEB**; default password is **admin**.)
 - **Moderator Password** lets you enter a password up to 4 numbers long for accessing the projector as a moderator with the Epson iProjection (Windows/Mac) software or the Epson iProjection app.
 - **Projector Keyword** lets you turn on a security password to prevent access to the projector by anyone not in the room with it. The projector displays a random keyword that you must enter from a computer using the Epson iProjection (Windows/Mac) software or an iOS or Android device, or on a Chromebook, using the Epson iProjection app.
 - **Display Keyword** lets you display a keyword on the projected image when accessing the projector from a computer using the Epson iProjection (Windows/Mac) software or an iOS or Android device, or on a Chromebook, using the Epson iProjection app.

- **Display LAN Info** lets you select how the projector displays network information. You can select an option to display a QR code that lets you quickly connect your iOS or Android devices using the Epson iProjection app.

Note: Use the displayed keyboard to enter the name, passwords, and keyword. Press the arrow buttons on the remote control to highlight characters and press **Enter** to select them.

7. Select the **Wired LAN** menu and press **Enter**.

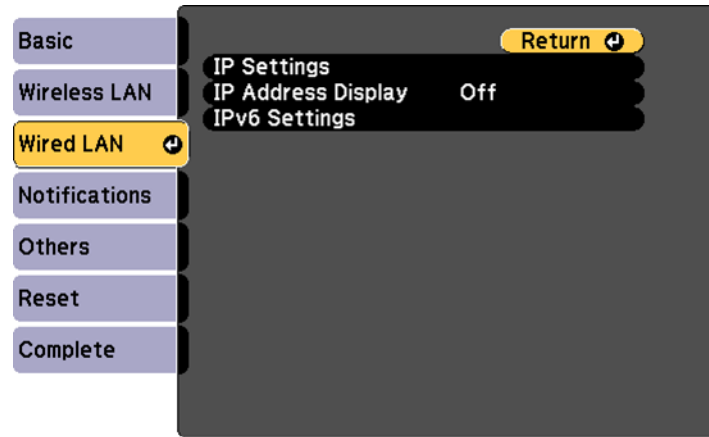

8. Select your IP Settings as necessary:
 - If your network assigns addresses automatically, turn on the **DHCP** setting.
 - If you must set addresses manually, turn off **DHCP** and enter the projector's **IP Address**, **Subnet Mask**, and **Gateway Address** as needed.

Note: To highlight the numbers you want from the displayed keyboard, press the arrow buttons on the remote control. To select a highlighted number, press **Enter**.

9. To prevent display of the IP address on the standby screen, turn off **IP Address Display**.
10. To connect the projector to the network using IPv6, select **On** as the **IPv6 Settings** option. Then select the **Auto Configuration** and **Use Temporary Address** settings as necessary.
11. When you finish selecting settings, select **Complete** and follow the on-screen instructions to save your settings and exit the menus.

Parent topic: [Wired Network Projection](#)

Wireless Network Projection

You can project over a wireless network. To do this, you must set up your projector and computer for wireless projection.

To connect wirelessly to your projector, configure the connection using the projector's Network menus.

After connecting and setting up the projector, install the projector software. You may need to install it from a software CD, if included, or download the software and manuals as necessary.

Note: If your projector is connected via a LAN cable to a network that includes a wireless access point, you can connect to the projector wirelessly through the access point using the Epson network software.

[Using a QR Code to Connect a Mobile Device](#)

[Using Quick Wireless Connection \(Windows\)](#)

[Selecting Wireless Network Settings Manually](#)

[Selecting Wireless Network Settings in Windows](#)

[Selecting Wireless Network Settings on Mac](#)

[Setting Up Wireless Network Security](#)

Parent topic: [Using the Projector on a Network](#)

Related references

[Additional Projector Software and Manuals](#)

Using a QR Code to Connect a Mobile Device

After you select the wireless network settings for your projector, you can display a QR code on the screen and use it to connect a mobile device using the Epson iProjection app.

Note: Make sure you have installed the latest version of Epson iProjection on your device. Visit epson.com/iprojection (U.S.) or epson.ca/iprojection (Canada) for more information.

1. Press the **Menu** button.

2. Select the **Network** menu and press **Enter**.

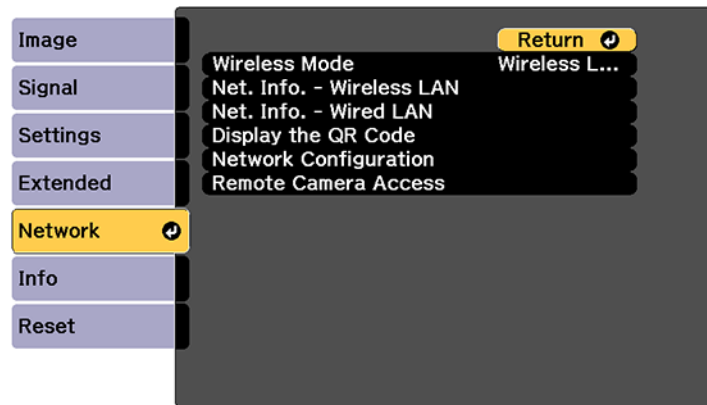

3. Select **Network Configuration** and press **Enter**.
4. Select the **Basic** menu and press **Enter**.

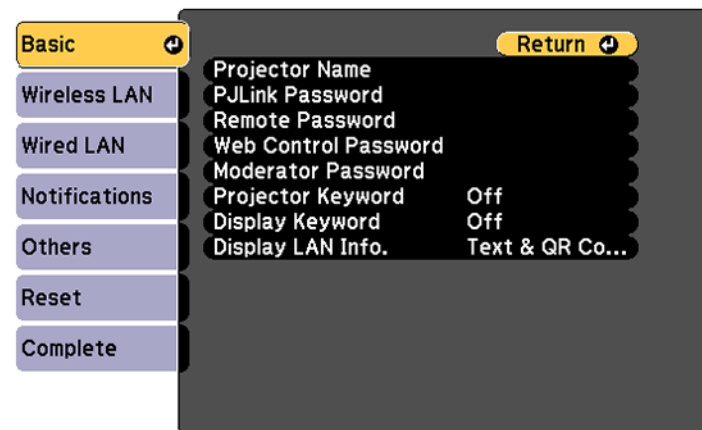

5. Set the **Display LAN Info** setting to **Text & QR Code**.
6. Select **Complete** and follow the on-screen instructions to save your settings and exit the menus.

7. Do one of the following:
 - Press the **LAN** button on the remote control.
 - Select **Display the QR Code** in the projector's Network menu.

Your projector displays the QR code on the projection surface.

Note: If you do not see the QR code after pressing the **LAN** button, press **Enter** to display it.

8. Start Epson iProjection on your mobile device.
9. Use the QR code reader feature to read the QR code and connect your device to the projector. Visit epson.com/iprojection (U.S.) or epson.ca/iprojection (Canada) for instructions.

Parent topic: [Wireless Network Projection](#)

Related references

[Additional Projector Software and Manuals](#)

Using Quick Wireless Connection (Windows)

You can create a Quick Wireless Connection USB Key to quickly connect the projector to a Windows computer wirelessly. Then you can project your presentation and remove the key when you are done.

Note: A USB flash drive is not included with your projector.

1. Create a Quick Wireless Connection USB Key with a USB flash drive and the Epson iProjection (Windows) software.

Note: See the online *Epson iProjection Operation Guide* for instructions.

2. Turn on the projector.
3. Press the **LAN** button on the remote control.
The LAN standby screen is displayed.
4. Verify the SSID and IP address.
5. Insert the USB key into the projector's **USB-A** port.
You see a projected message that the network information update is complete.
6. Remove the USB key.

7. Insert the USB key into a USB port on your computer.

Note: In Windows Vista, if you see the AutoPlay window, select **Run MPPLaunch.exe**, then select **Allow** on the next screen.

8. Follow the on-screen instructions to install the Epson iProjection software.

Note: If you see a Windows Firewall message, click **Yes** to disable the firewall. You need administrator authority to install the software. If it is not installed automatically, double-click **MPPLaunch.exe** in the USB key.

After a few minutes, your computer image is displayed by the projector. If it does not appear, press the **LAN** or **Source Search** button on your remote control or restart your computer.

9. Run your presentation as necessary.
10. When you finish projecting wirelessly, select the **Safely Remove Hardware** option in the Windows taskbar, then remove the USB key from your computer.

Note: You can share the USB key with other computers without disconnecting your computer. You may need to restart your computer to reactivate your wireless LAN connection.

Parent topic: [Wireless Network Projection](#)

Related references

[Additional Projector Software and Manuals](#)

[Projector Parts - Interface Ports](#)

Selecting Wireless Network Settings Manually

Before you can project from your wireless network, you must select the network settings for the projector using its menu system.

1. Turn on the projector.
2. Press the **Menu** button.

3. Select the **Network** menu and press **Enter**.

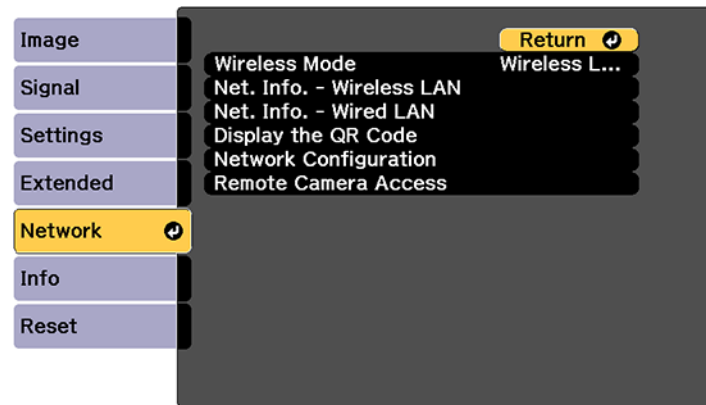

4. Make sure the **Wireless Mode** setting is set to **Wireless LAN On**.
5. Select **Network Configuration** and press **Enter**.
6. Select the **Basic** menu and press **Enter**.

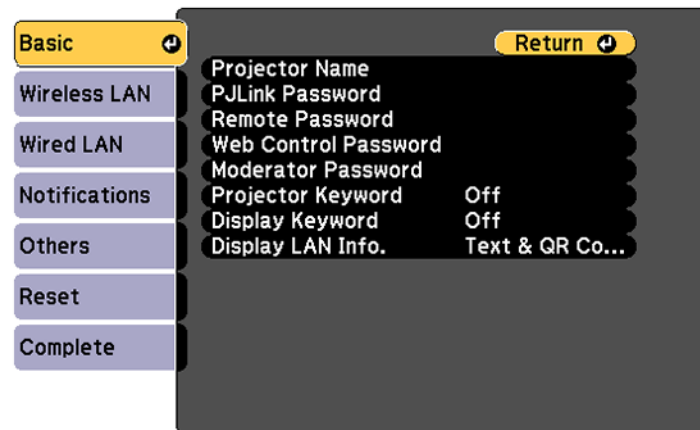

7. Select the following basic options as necessary:
 - **Projector Name** lets you enter a name up to 16 alphanumeric characters long to identify the projector over the network.

- **PJLink Password** lets you enter a password up to 32 alphanumeric characters long for using the PJLink protocol for projector control.
- **Remote Password** lets you enter a password up to 8 alphanumeric characters long for accessing the Remote or Basic Control screen in the Epson Web Control. (Default user name is **EPSONREMOTE**; default password is **guest**.)
- **Web Control Password** lets you enter a password up to 8 alphanumeric characters long for accessing the projector over the web. (Default user name is **EPSONWEB**; default password is **admin**.)
- **Moderator Password** lets you enter a password up to 4 numbers long for accessing the projector as a moderator with the Epson iProjection (Windows/Mac) software or the Epson iProjection app.
- **Projector Keyword** lets you turn on a security password to prevent access to the projector by anyone not in the room with it. The projector displays a random keyword that you must enter from a computer using the Epson iProjection (Windows/Mac) software or an iOS or Android device, or on a Chromebook, using the Epson iProjection app.
- **Display Keyword** lets you display a keyword on the projected image when accessing the projector from a computer using the Epson iProjection (Windows/Mac) software or an iOS or Android device, or on a Chromebook, using the Epson iProjection app.
- **Display LAN Info** lets you select how the projector displays network information. You can select an option to display a QR code that lets you quickly connect your iOS or Android devices with the Epson iProjection app.

Note: Use the displayed keyboard to enter the name, passwords and keyword. Press the arrow buttons on the remote control to highlight characters and press **Enter** to select them.

- Select the **Wireless LAN** menu and press **Enter**.

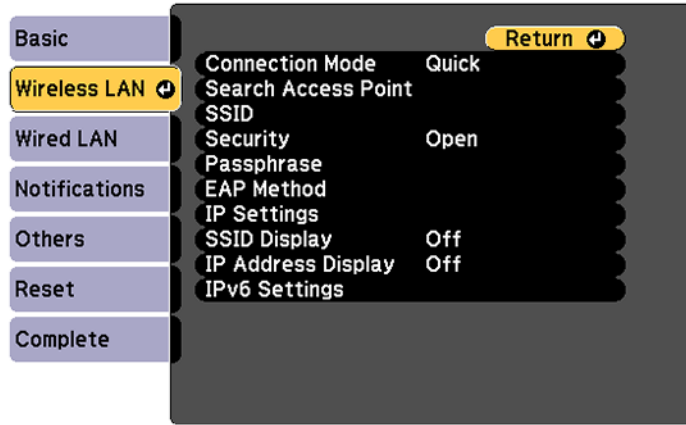

- Select the settings on the **Wireless LAN** menu as necessary for your network.
- When you finish selecting settings, select **Complete** and follow the on-screen instructions to save your settings and exit the menus.

After you complete the wireless settings for your projector, you need to select the wireless network on your computer, or iOS or Android device.

[Wireless LAN Menu Settings](#)

Parent topic: [Wireless Network Projection](#)

Wireless LAN Menu Settings

Setting	Options	Description
Connection Mode	Quick Advanced	Selects the type of wireless connection: Quick: lets you connect to multiple smartphones, tablets, or computers directly Advanced: lets you connect to multiple smartphones, tablets, or computers via a wireless network access point

Setting	Options	Description
Search Access Point	To Search View	Search for available wireless network access points in Advanced connection mode
SSID	Up 32 alphanumeric characters	Sets the SSID (network name) of the wireless LAN system the projector is connecting to
Security	Open WPA2-PSK WPA/WPA2-PSK WPA2-EAP WPA/WPA2-EAP	Selects the type of wireless security used in the wireless network (some options are only available when the Connection Mode setting is set to Advanced)
Passphrase	Between 8 to 63 alphanumeric characters	Enter a paraphrase for the wireless network
EAP Method	EAP Type User name Password Client Certificate Verify Server Cert. CA certificate RADIUS Serv.Name	Sets the EAP settings for WPA2-EAP and WPA/WPA2-EAP security
Channel	1ch 6ch 11ch	In Quick connection mode, selects the frequency band (channel) used by the wireless LAN

Setting	Options	Description
IP Settings	DHCP IP Address Subnet Mask Gateway Address	Turns on DHCP if your network assigns addresses automatically; set to Off to manually enter the network's IP Address , Subnet Mask , and Gateway Address (some options are only available when the Connection Mode setting is set to Advanced)
SSID Display	On Off	Selects whether to display the SSID on the network standby screen
IP Address Display	On Off	Selects whether to display the IP address on the network standby screen
IPv6 Settings	IPv6 Auto Configuration Use Temporary Address	Selects the IPv6 settings when you connect the projector to the network using IPv6

Parent topic: [Selecting Wireless Network Settings Manually](#)

Selecting Wireless Network Settings in Windows

Before connecting to the projector, select the correct wireless network on your computer.

1. To access your wireless utility software, access the Desktop and double-click the network icon on the Windows taskbar.
2. Do one of the following:
 - If your projector is set up on an existing network (Advanced mode), select the network name (SSID).
 - If your projector is configured for Quick mode, select the projector's SSID.
3. Click **Connect**.

Parent topic: [Wireless Network Projection](#)

Selecting Wireless Network Settings on Mac

Before connecting to the projector, select the correct wireless network on your Mac.

1. Click the AirPort icon on the menu bar at the top of the screen.
2. Make sure AirPort is turned on, then do one of the following:
 - If your projector is set up on an existing network (Advanced mode), select the network name (SSID).
 - If your projector is configured for Quick mode, select the projector's SSID.

Parent topic: [Wireless Network Projection](#)

Setting Up Wireless Network Security

You can set up security for your projector to use on a wireless network. Set up one of the following security options to match the settings used on your network:

- WPA2-PSK (Advanced and Quick connection mode)
- WPA2-EAP (Advanced mode)
- WPA/WPA2-PSK (Advanced connection mode)
- WPA/WPA2-EAP (Advanced connection mode)

Note: Contact your network administrator for guidance on entering the correct information.

1. If you want to set up WPA2-EAP or WAP/WAP2-EAP security, make sure your digital certificate file is compatible with projector registration and placed directly on a USB storage device.
2. Press the **Menu** button.

3. Select the **Network** menu and press **Enter**.

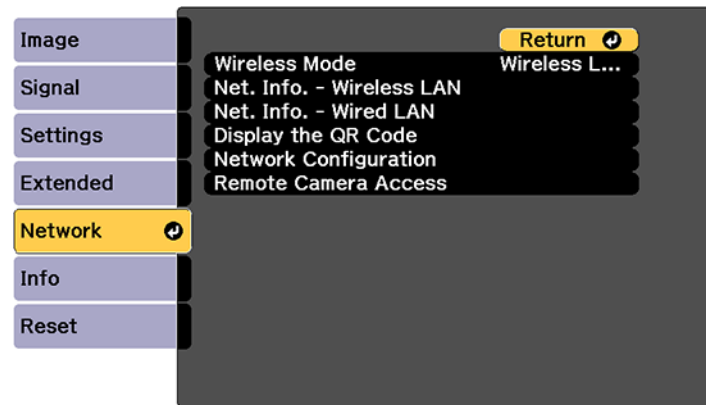

4. Select **Network Configuration** and press **Enter**.
5. Select the **Wireless LAN** menu and press **Enter**.
6. Set the **Security** setting to match your network settings.
7. Do one of the following depending on the network security setting you selected:
 - **WPA2-PSK** or **WPA/WPA2-PSK**: Select **Complete** and follow the on-screen instructions to save your settings and exit the menus. Skip the remaining steps.
 - **WPA2-EAP** or **WPA/WPA2-EAP**: Select **EAP Method** and press **Enter**.

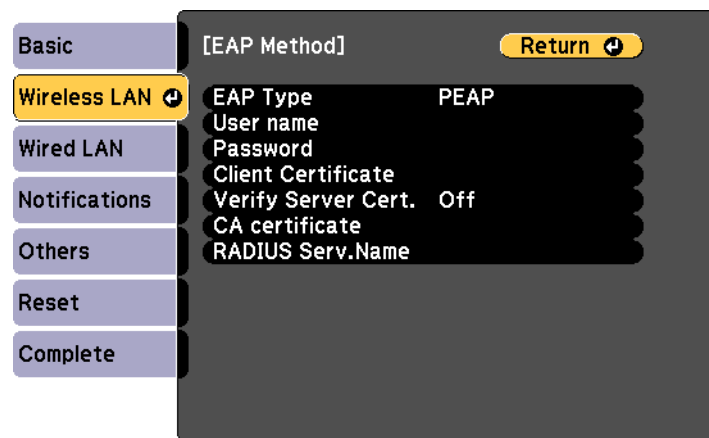

8. Select your authentication protocol as the **EAP Type** setting.
9. To import your certification, select the certificate type (either **Client Certificate** or **CA certificate**) and press **Enter**.

Note: You can also register a digital certificate from your web browser. Make sure to register just once or the certificate may not install correctly.

10. Select **Register** and press **Enter**.
11. Follow the on-screen instructions to connect a USB storage device to the projector's **USB-A** port.
12. Press **Enter** to display the certificate list.
13. Select the certificate to import from the displayed list.
You see a message to enter the certificate password.
14. Enter a password and press **Enter**.
You see a completion message after the certificate is imported.
15. Set the following EAP settings as necessary:
 - **User name** lets you enter a user name up to 64 alphanumeric characters long. To enter more than 32 characters, use your web browser.
 - **Password** lets you enter a password up to 64 alphanumeric characters long when using the PEAP, EAP-FAST, or LEAP protocols. To enter more than 32 characters, use your web browser.
 - **Verify Server Cert.** lets you select whether or not to verify the server certificate when a CA certificate has been set.
 - **RADIUS Serv.Name** lets you enter the server name to be verified.
16. When you finish selecting settings, select **Complete** and follow the on-screen instructions to save your settings and exit the menus.

Parent topic: [Wireless Network Projection](#)

Related references

[Wireless LAN Menu Settings](#)

Setting Up Projector Network E-Mail Alerts

You can set up the projector to send you an e-mail alert over the network if there is a problem with the projector.

1. Press the **Menu** button.

2. Select the **Network** menu and press **Enter**.
3. Select **Network Configuration** and press **Enter**.
4. Select the **Notifications** menu and press **Enter**.

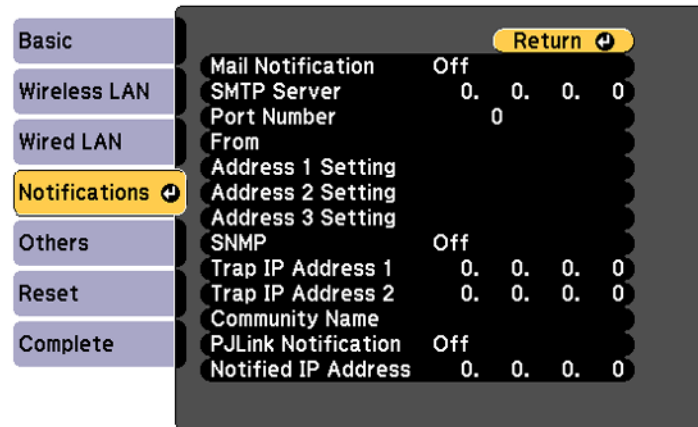

5. Turn on **Mail Notification**.
6. Enter the IP address for the **SMTP Server** setting.

Note: Do not use these addresses: 127.x.x.x or 224.0.0.0 through 255.255.255.255 (where x is a number from 0 to 255).

7. Select a number for the SMTP server **Port Number** setting, from 1 to 65535 (default is 25).
8. Enter the sender's email address as the **From** setting.
9. Choose an **Address Setting** field, enter the e-mail address, and select or deselect the alerts you want to receive there. Your e-mail address can be up to 32 alphanumeric characters long. Repeat for up to three addresses.
10. If you are using the PLink protocol for projector control, turn on the **PLink Notification** setting and enter the IP address where you want to receive PLink notifications as the **Notified IP Address** setting.
11. When you finish selecting settings, select **Complete** and follow the on-screen instructions to save your settings and exit the menus.

Note: If a critical problem causes a projector to shut down, you may not receive an e-mail alert.

[Network Projector E-mail Alert Messages](#)

Parent topic: [Using the Projector on a Network](#)

Network Projector E-mail Alert Messages

When a problem occurs with a networked projector, and you selected to receive e-mail alerts, you receive an e-mail containing the following information:

- The email address entered as the **From** setting
- **Epson Projector** on the subject line
- The name of the projector experiencing a problem
- The IP address of the affected projector
- Detailed information about the problem

Note: If a critical problem causes a projector to shut down, you may not receive an e-mail alert.

Parent topic: [Setting Up Projector Network E-Mail Alerts](#)

Selecting Other Network Settings

You can select optional network settings on the Others menu.

1. Press the **Menu** button.
2. Select the **Network** menu and press **Enter**.
3. Select **Network Configuration** and press **Enter**.

4. Select the **Others** menu and press **Enter**.

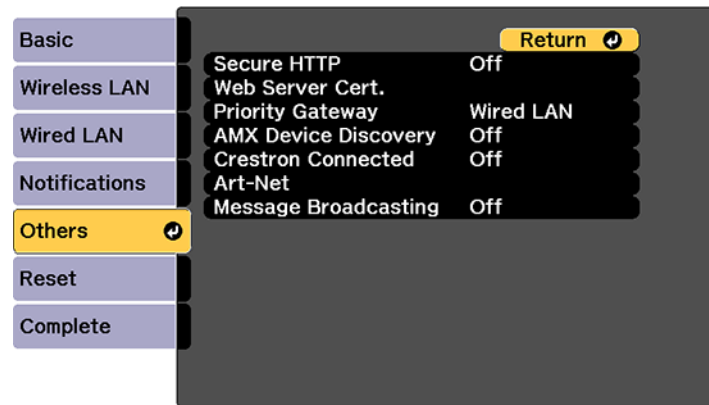

5. If you want to use the Secure HTTP protocol to encrypt communication when using Web Control, turn on the **Secure HTTP** setting and import the web server certificate using the **Web Server Cert.** setting.
6. Select the **Priority Gateway** setting for your network.
7. If your network environment uses an AMX controller, turn on the **AMX Device Discovery** setting to allow the projector to be detected.
8. If your network environment uses a Crestron Connected controller, turn on the **Crestron Connected** setting to allow the projector to be detected.

Note: Enabling Crestron Connected disables the Message Broadcasting feature in the Epson Projector Management software (Windows only).

9. If you want to control the projector using Art-Net (an Ethernet communication protocol based on TCP/IP), turn on the **Art-Net** setting.
10. If you want this projector to receive broadcasted messages over the network, turn on the **Message Broadcasting** setting. Administrators can broadcast messages over the network using the Epson Projector Management software (Windows only).
11. When you finish selecting settings, select **Complete** and follow the on-screen instructions to save your settings and exit the menus.

Parent topic: [Using the Projector on a Network](#)

Related concepts

[Using Crestron Connected](#)

Related references

[Art-Net Channel Definitions](#)

[Additional Projector Software and Manuals](#)

Setting a Static IP Address on the LCD Screen

You can set a static IP address on the projector's LCD screen while the projector is in standby mode. This lets you set the address without needing to project anything.

1. Press the **Menu** button on the projector or remote control.
2. Select the **Extended** menu and press **Enter**.

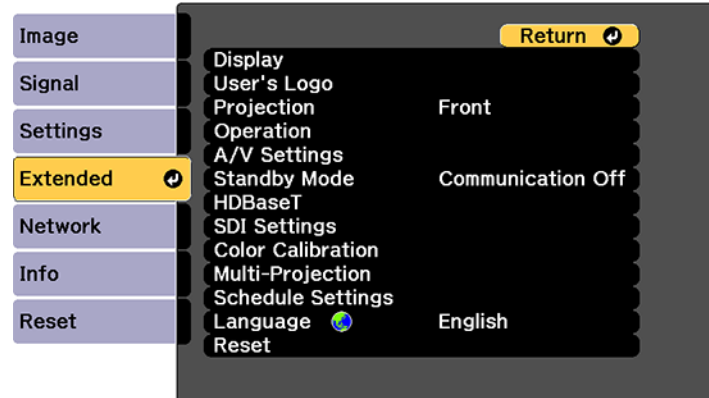

3. Select the **A/V Settings > A/V Output**, select **Always On**, and press **Enter**.
4. Select **Standby Mode**, select **Communication On**, and press **Enter**.
5. Press the **Menu** button to exit the menu system.
6. Turn off the projector, connect it to a wired LAN, and turn on the power using the power switch.
7. Hold down the **HDBaseT/LAN** button on the projector control panel for at least three seconds.

You see the static IP setting menu:

```
Start
IP Setting
```

8. Press the **Enter** button on the projector control panel, press the down arrow button to select **OFF** as the **DHCP** setting, and press **Enter** again.
9. Use the up and down arrow buttons as necessary to change the IP address values. Use the left and right arrow buttons to move the cursor to the next or previous number position. When you finish, press **Enter**.

```
IP Address
192. 168. 100. 100
```

Note: You can also enter the numbers using the numeric buttons on the remote control.

10. Repeat the last step to enter the subnet mask and gateway address, if necessary, and press **Enter**.
11. Press **Enter** to select **Finish** and return to the status information screen.

Parent topic: [Using the Projector on a Network](#)

Related references

[Projector Parts - Control Panel](#)

Related tasks

[Selecting Wired Network Settings](#)

Controlling a Networked Projector Using a Web Browser

Once you have connected your projector to your network, you can select projector settings and control projection using a compatible web browser. This lets you access the projector remotely.

Note: The web setup and control features support Microsoft Internet Explorer 11.0 or later, Microsoft Edge, Google Chrome, and Safari on networks that do not use a proxy server for connection. You cannot select all of the projector menu settings or control all projector functions using a web browser.

Note: If you set Standby Mode to **Communication On**, you can use a web browser to select settings and control projection even if the projector is in standby mode.

1. Make sure the projector is turned on.
2. Start your web browser on a computer or device connected to the network.
3. Type the projector's IP address into the browser's address box and press the computer's **Enter** key.

Note: You may need to log in to access some of the options on the Web Control screen. If you see a log in window, enter your user name and password. (The default user name is **EPSONWEB** and the default password is **admin**.)

You see the Epson Web Control screen.

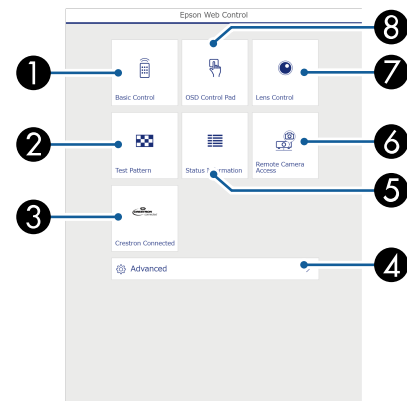

- 1 Select **Basic Control** to control the projector remotely.
- 2 Select **Test Pattern** to display a test pattern
- 3 Select **Crestron Connected** to open the menu (if you enabled Crestron Connected in the **Network > Others** menu)
- 4 Select **Advanced** to open the advanced menu screen.
- 5 Select **Status Information** to view the projector's status.
- 6 Select **Remote Camera Access** to take an image capture of the displayed image from a remote location

- 7 Select **Lens Control** to adjust the lens (focus, zoom, and lens shift).
 - 8 Select **OSD Control Pad** to change the projector's menu settings.
4. Select the option corresponding to the projector function you want to control.

[Web Control Options](#)

[Viewing an Image Capture of the Displayed Image from a Remote Location](#)

Parent topic: [Using the Projector on a Network](#)

Related tasks

[Selecting Other Network Settings](#)

Web Control Options

Basic Control

Note: If the Remote Password is set to **On**, you need to enter your user name and password. (The default username is **EPSONREMOTE** and the default password is **guest**).

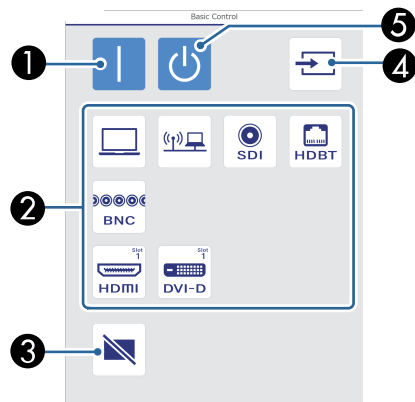

- 1 Turns on the projector (power on)
- 2 Input source selection controls
- 3 Turns off the image temporarily
- 4 Searches for sources

5 Turns off the projector (standby)

OSD Control Pad

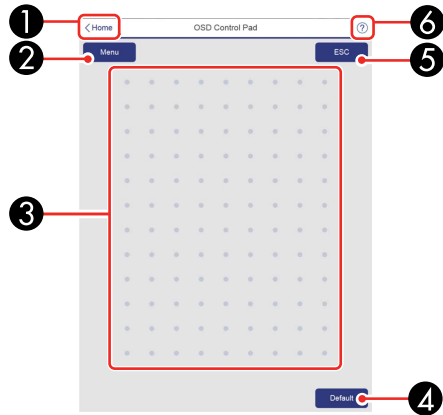

- 1 Returns to the Home screen
- 2 Displays the projector's setting menus
- 3 Use your finger or mouse to navigate the menus
- 4 Returns settings to their default values
- 5 Returns to the previous menu (if this doesn't work, select Home)
- 6 Displays help topics

Note: You cannot change some settings using Epson Web Control.

Lens Control

Focus/Distortion screen

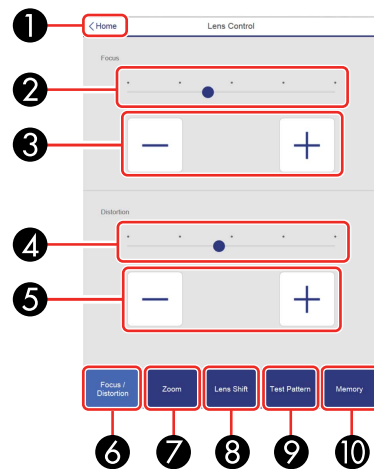

Note: Depending on the currently installed lens, this screen may look different.

- 1 Returns to the Home screen
- 2 Focus adjustment slider
- 3 Focus adjustment buttons
- 4 Distortion adjustment slider
- 5 Distortion adjustment buttons
- 6 Displays the Focus/Distortion screen
- 7 Displays the Zoom screen
- 8 Displays the Lens Shift screen
- 9 Displays the Test Pattern screen
- 10 Displays the Memory screen

Zoom screen

Note: Zoom is not available for the ELPLX02 and ELPLX02W lenses.

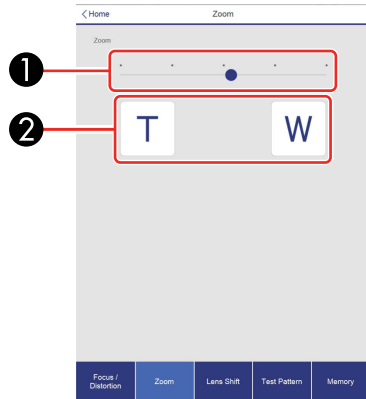

Note: Depending on the currently installed lens, this screen may look different.

- 1 Zoom adjustment slider
- 2 Zoom adjustment buttons

Lens Shift screen

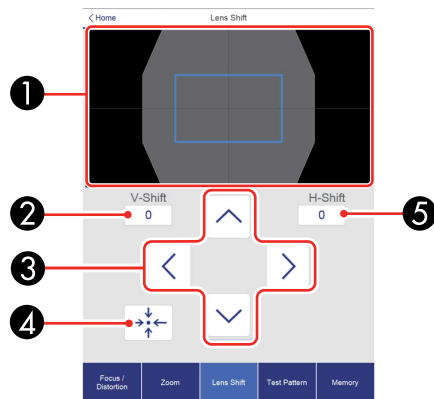

Note: Depending on the currently installed lens, this screen may look different.

- 1 The blue square displays the current image position and the red square displays the new image position
- 2 Displays the vertical image position; select to change the value
- 3 Moves the image position up, down, left, or right
- 4 Moves the lens to the home position
- 5 Displays the horizontal image position; select to change the value

Test Pattern screen

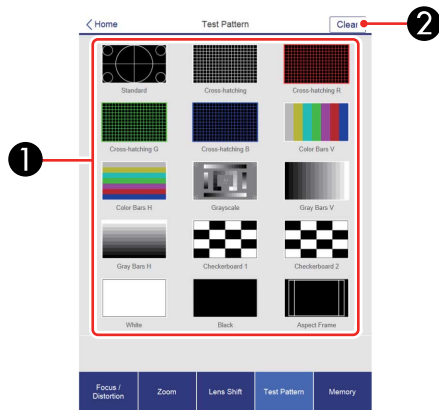

- 1 Displays available test patterns; select to project a test pattern
- 2 Turns off test pattern display

Memory screen

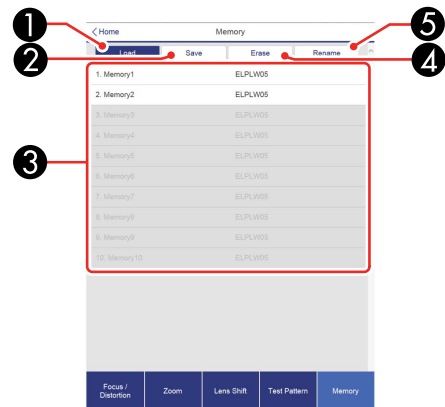

- 1 Overwrites your current settings with saved settings
- 2 Saves your current settings to memory
- 3 Displays a list of saved memories
- 4 Erases a saved memory
- 5 Renames a saved memory

Status Information screen



- 1 Returns to the Home screen
- 2 Displays a list of monitored settings
- 3 Displays the setting status
- 4 Select to view different status information

Remote Camera Access screen

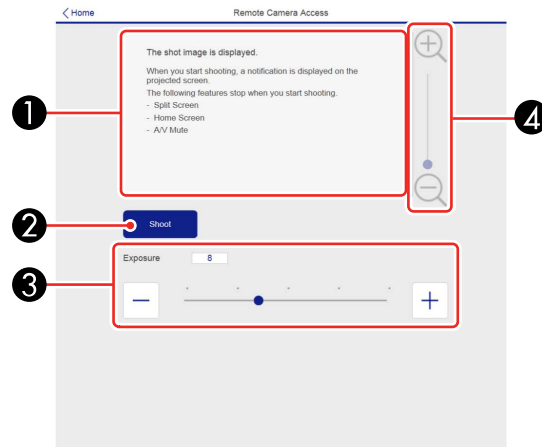

- 1 Displays the image you captured using the **Shoot** button
- 2 Takes a picture of the projected image using the camera on the front of the projector
- 3 Adjusts the image exposure
- 4 Zooms in or out on the image you captured

Parent topic: [Controlling a Networked Projector Using a Web Browser](#)

Related tasks

[Viewing an Image Capture of the Displayed Image from a Remote Location](#)

Viewing an Image Capture of the Displayed Image from a Remote Location

You can take an image capture of the projected image and view it from a remote location using the projector's built-in camera.

Note the following when using this feature:

- This feature is not supported with the ELPLX02 or ELPLX02W lens.
 - This feature is not supported when performing the following functions: Tiling, Tiling Assist, Screen Matching, Color Calibration, Lens Calibration, Message Broadcasting in the Epson Projector Management software.
 - Using this feature cancels the following functions: Split Screen, Shutter, on-screen display (when the message is hidden).
1. Hold down the **Freeze** button on the remote control for about five seconds or until you see this menu.

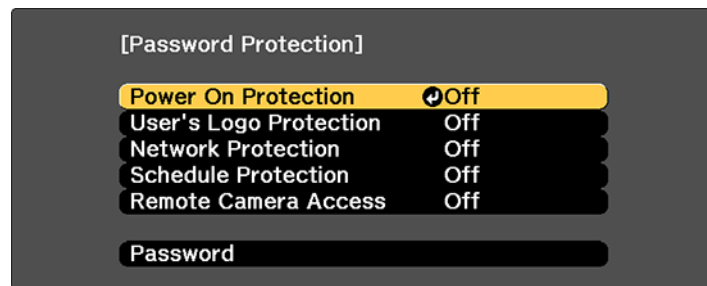

2. Make sure the **Remote Camera Access** setting is set to **Off**, then exit the menu.
3. Press the **Menu** button.
4. Select the **Network** menu and press **Enter**.

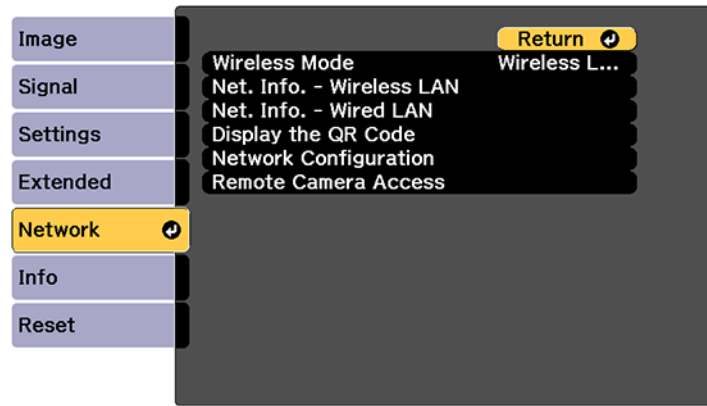

5. Select **Network Configuration** and select the **Others** menu.
6. Make sure the **Secure HTTP** setting is enabled and return to the Network menu.
7. Select **Remote Camera Access** and press **Enter**.

You see a screen like this:

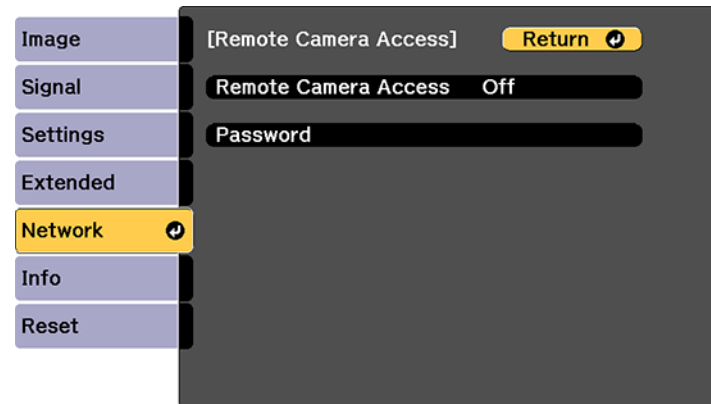

8. Select **On** as the **Remote Camera Access** setting.
9. Select the **Password** setting and enter a password up to 32 alphanumeric characters long.

Note: Do not use these characters in the password: * (asterisk), : (colon), or a space character.

10. Open a web browser on a computer or mobile device connected to the projector over a network connection.
11. Enter the projector's IP address in your browser's address box to connect to Epson Web Control.

You see a screen like this:

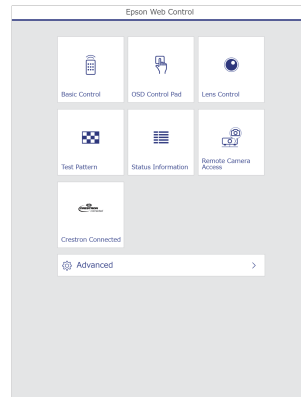

Note: You can view the projector's IP address by selecting **Net. Info. - Wireless LAN** or **Net. Info. - Wired LAN** on the Network menu.

12. Select **Remote Camera Access**.

Note: You may need to log in to access some of the options on the Epson Web Control screen. If you see a log in window, enter your user name and password. (The default user name is **EPSONWEB** and the default password is **admin**.)

13. Click **Shoot** to take a capture of the projected image. (You cannot capture warning or caution messages.)

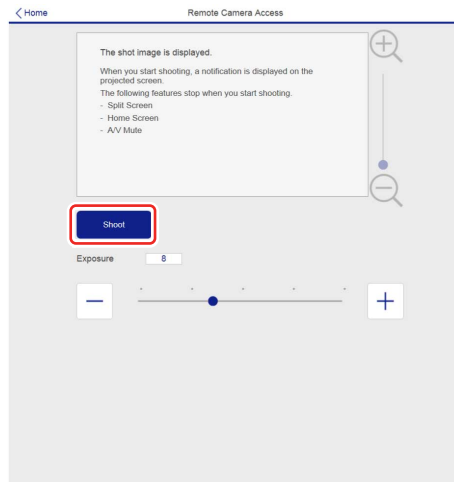

Note: If you see a password screen, enter the password you selected for remote camera access. You cannot perform any projector operations during shooting other than turning off the projector.

The projector displays a message on the projection screen for several seconds while it takes an image capture. When finished, the captured image is displayed in the area above the **Shoot** button.

Parent topic: [Controlling a Networked Projector Using a Web Browser](#)

Using Crestron Connected

If you are using the Crestron Connected network monitoring and control system, you can set up your projector for use on the system. Crestron Connected lets you control and monitor your projector using a web browser.

Note: You cannot use the Message Broadcasting feature in the Epson Projector Management software when you use Crestron Connected.

For additional information on Crestron Connected, contact Crestron.

[Setting Up Crestron Connected](#)

[Controlling a Networked Projector Using Crestron Connected](#)

Parent topic: [Using the Projector on a Network](#)

Related references

[Additional Projector Software and Manuals](#)

Setting Up Crestron Connected

To set up your projector for monitoring and control using a Crestron Connected system, make sure your computer and projector are connected to the network.

Note: If you want to use the Crestron Connected system when the projector is turned off, you need to adjust the **Standby Mode** settings in the Extended menu.

1. Press the **Menu** button.
2. Select the **Network** menu and press **Enter**.
3. Select **Network Configuration** and press **Enter**.
4. Select the **Others** menu and press **Enter**.

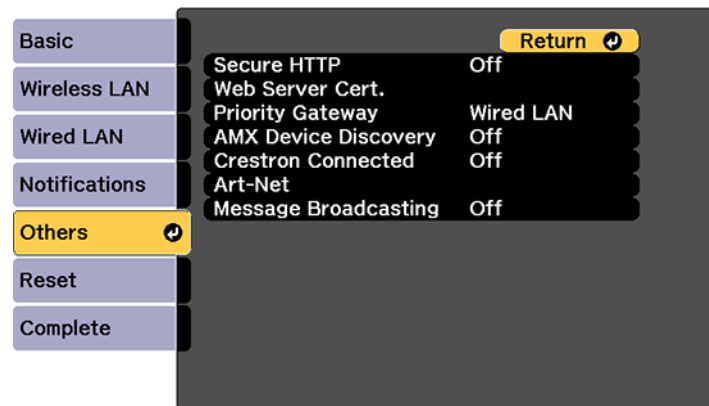

5. Set the **Crestron Connected** setting to **On** to allow the projector to be detected.

Note: Enabling Crestron Connected disables the Message Broadcasting feature in the Epson Projector Management software.

6. Turn off the projector, then turn it on again to enable the setting.

Parent topic: [Using Crestron Connected](#)

Related references

[Projector Setup Settings - Extended Menu](#)

Controlling a Networked Projector Using Crestron Connected

Once you have set up your projector to use Crestron Connected, you can control and monitor projection using a compatible web browser.

1. Start your web browser on a computer connected to the network.
2. Type the projector's IP address into the browser's address box and press the computer's **Enter** key.

You see the Epson Web Control screen:

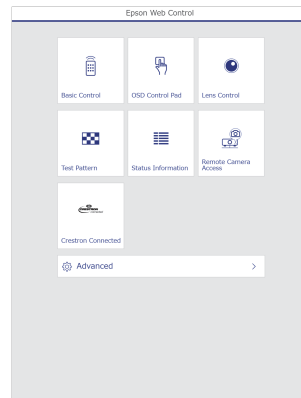

3. Select **Crestron Connected**.

You see a screen like this:



Note: Sources in the image above vary depending on ports available on your product.

4. Select the input source that you want to control in the Sources List box. You can scroll through available sources using the up and down arrows in the box.
5. To control projection remotely, click the on-screen buttons that correspond to the projector's remote control buttons. You can scroll through button options at the bottom of the screen.

Note: These on-screen buttons do not directly correspond to the projector's remote control buttons:

- **OK** acts as the **Enter** button
- **Menu** displays the projector's menu

6. To view information about the projector, click the **Info** tab.
7. To change projector, Crestron, and password settings, click the **Tools** tab, select settings on the displayed screen, and click **Send**.
8. When you finish selecting settings, click **Exit** to exit the program.

Parent topic: [Using Crestron Connected](#)

Art-Net Channel Definitions

Art-Net is an Ethernet communication protocol based on the TCP/IP protocol. You can control the projector by using a DMX controller or an application system.

The following table lists the channel definitions used to control the projector in Art-Net.

Begin by setting channel 13 to **Can control**.

Note: When controlling the projector using Art-Net and performing operations from the remote control or control panel, settings made by the DMX controller or application software may not be applied to the projector correctly or may differ from the projector's actual status. If you want to apply control for multiple channels to the projector, set Channel 13 to **Cannot control** before you make any other settings. Then set Channel 13 to **Can control** after setting multiple channels. You can then control the projector without changing the setting for Channel 13.

Channel/Function	Operation	Parameters	Description
1 Adjusting light (dimming)	0% to 100%	0 to 255	Adjusts the image brightness (default is 0)
2 Shutter control	Shutter closed Non-operational Shutter open	0 to 63 64 to 191 192 to 255	Closes and opens the shutter (default is 128)

Channel/Function	Operation	Parameters	Description
3 Switch source	Non-operational	0 to 23, 32 to 47, 64 to 71, 88 to 127, 144 to 167, 184 to 255	Switches to the specified source (default is 0)
	HDBaseT	24 to 31	
	SDI	48 to 55	
	Computer	56 to 63	
	BNC	72 to 79	
	LAN	80 to 87	
	Slot 1-1*	128 to 135	
	Slot 1-2*	136 to 143	
	Slot 2-1*	168 to 175	
	Slot 2-2*	176 to 183	
4 Lens position	Non operational	0 to 31, 64 to 255	Shifts the lens to the home position (default is 0)
	Move to home position	32 to 63	
5 Horizontal lens shift	(+) Lens adjustment	Movement - large: 0 to 31 Movement - medium: 32 to 63 Movement - small: 64 to 95	Shifts the lens horizontally by the amount of shift specified (default is 128)
	Non-operational	96 to 159	
	(-) Lens adjustment	Movement - small: 160 to 191 Movement - medium: 192 to 223 Movement - large: 224 to 255	

Channel/Function	Operation	Parameters	Description
6 Vertical lens shift	(+) Lens adjustment	Movement - large: 0 to 31 Movement - medium: 32 to 63 Movement - small: 64 to 95	Shifts the lens vertically by the amount of shift specified (default is 128)
	Non-operational	96 to 159	
	(-) Lens adjustment	Movement - small: 160 to 191 Movement - medium: 192 to 223 Movement - large: 224 to 255	
7 Electronic zoom	(+) Lens adjustment	Movement - large: 0 to 31 Movement - medium: 32 to 63 Movement - small: 64 to 95	Zooms using the specified amount of movement (default is 128)
	Non-operational	96 to 159	
	(-) Lens adjustment	Movement - small: 160 to 191 Movement - medium: 192 to 223 Movement - large: 224 to 255	

Channel/Function	Operation	Parameters	Description
8 Electronic focus	(+) Lens adjustment	Movement - large: 0 to 31 Movement - medium: 32 to 63 Movement - small: 64 to 95	Performs electronic focus using the specified amount of movement (default is 128)
	Non-operational	96 to 159	
	(-) Lens adjustment	Movement - small: 160 to 191 Movement - medium: 192 to 223 Movement - large: 224 to 255	
9 Electronic distortion	(+) Lens adjustment	Movement - large: 0 to 31 Movement - medium: 32 to 63 Movement - small: 64 to 95	Corrects distortion using the specified amount of movement (default is 128)
	Non-operational	96 to 159	
	(-) Lens adjustment	Movement - small: 160 to 191 Movement - medium: 192 to 223 Movement - large: 224 to 255	

Channel/Function	Operation	Parameters	Description
10 Load lens memory	Non-operational	0 to 15, 176 to 255	Loads the specified lens memory (default is 0)
	Load lens memory 1	16 to 31	
	Load lens memory 2	32 to 47	
	Load lens memory 3	48 to 63	
	Load lens memory 4	64 to 79	
	Load lens memory 5	80 to 95	
	Load lens memory 6	96 to 111	
	Load lens memory 7	112 to 127	
	Load lens memory 8	128 to 143	
	Load lens memory 9	144 to 159	
	Load lens memory 10	160 to 175	
11 Power control	Power off	0 to 63	Turns the projector power on or off (default is 128)
	Non-operational	64 to 191	
	Power on	192 to 255	
12 Geometry correction	Off	0 to 15	Performs geometry correction (default is 255)
	H/V-Keystone	16 to 31	
	Quick Corner	32 to 47	
	Point Correction	48 to 63	
	Curved Surface	64 to 79	
	Corner Wall	80 to 95	
	Load geometry correction memory 1	96 to 111	Loads a geometry correction memory (default is 255)
	Load geometry correction memory 2	112 to 127	
	Load geometry correction memory 3	128 to 143	
	Non-operational	144 to 175	

Channel/Function	Operation	Parameters	Description
13 Lock	Cannot control	0 to 127	Enables/disables Art-Net operations (default is 0)
	Can control	128 to 255	
14 Freeze	Non-operational	0 to 31, 96 to 159, 224 to 255	Pauses or resumes image display (default is 128)
	Freeze off	32 to 95	
	Freeze on	160 to 223	

* The slot number of the interface board followed by the port number from left to right on the interface board

Parent topic: [Using the Projector on a Network](#)

Related tasks

[Selecting Other Network Settings](#)

Registering a Digital Certificate on the Projector

Follow the instructions here if you need to install a digital certificate on the projector to provide security for your presentation files.

Note: You can register a digital certificate over a network or from a connected USB device. However, be sure to register just once from either a USB device or network, or the certificate may not install correctly.

[Importing a Web Server Certificate Using the Projector Menus](#)

[Registering Digital Certificates from a Web Browser](#)

[Digital Certificate Types](#)

Parent topic: [Using the Projector on a Network](#)

Importing a Web Server Certificate Using the Projector Menus

You can create your web server certificate and import it using the projector menus and a USB flash drive.

Note: You can also register digital certificates from your web browser. Make sure to only register once, or the certificate may not install correctly.

1. Make sure your digital certificate file is compatible with projector registration and saved in the root directory of the USB flash drive.
2. Press the **Menu** button on the remote control.
3. Select the **Network** menu and press **Enter**.
4. Select the **Network Configuration** setting and press **Enter**.
5. Select the **Others** menu and press **Enter**.

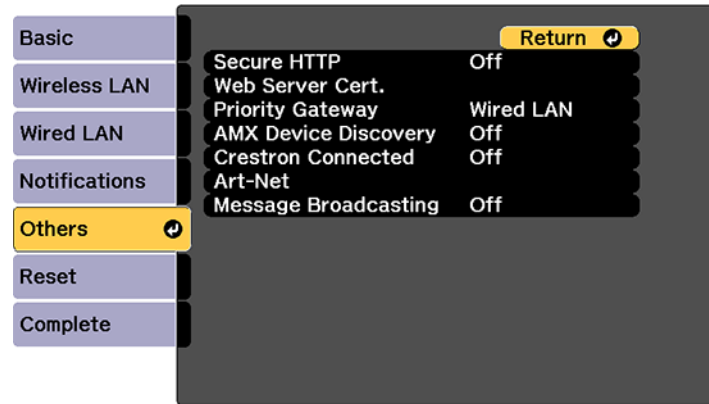

6. Select **On** as the **Secure HTTP** setting.
7. Select the **Web Server Cert.** setting and press **Enter**.
8. Select **Register** and press **Enter**.
9. Insert a USB flash drive into the projector's **USB-A** port.
10. Press **Enter** to display the certificate list.
11. Select the certificate you want to import from the displayed list.
A message is displayed prompting you to enter the password for the certificate.
12. Enter the password and press **Enter**.

The certificate is imported and a completion message appears.

Parent topic: [Registering a Digital Certificate on the Projector](#)

Related references

[Digital Certificate Types](#)

Registering Digital Certificates from a Web Browser

You can register the digital certificates on the projector for wireless LAN authentication.

1. Make sure your digital certificate file is compatible with projector registration.
2. Make sure the projector is turned on.
3. Start your web browser on a computer or mobile device connected to the network.
4. Type the projector's IP address into the browser's address box and press the computer's **Enter** key.

You see the Web Control screen:

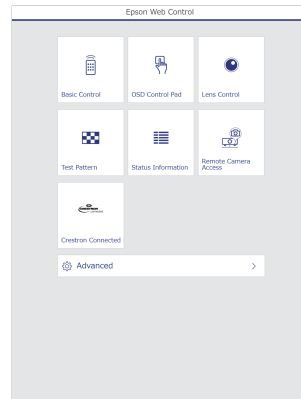

5. Select **Advanced**.

Note: You may need to log in to access some of the options on the Web Control screen. If you see a log in window, enter your user name and password. (The default user name is **EPSONWEB** and the default password is **admin**.)

6. Under **Network**, select **Certificate**.
7. Click the **Choose File** button, select the certificate file, and click **Open**.
8. Enter a password in the **Password** box and click **Send**.
9. When you finish registering the certificate, click **Apply** to finalize your changes and complete the registration.

Parent topic: [Registering a Digital Certificate on the Projector](#)

Related references

[Digital Certificate Types](#)

Digital Certificate Types

You can register these types of digital certificates.

Client Certificate (PEAP-TLS/EAP-TLS)

Specification	Description
Format	PKCS#12
Extension	PFX/P12
Encryption	RSA
Hashes	MD5/SHA-1/SHA-256/SHA-384/SHA-512
Key length	512/1024/2048/4096 bit
Password	Up to 32 alphanumeric characters; required

CA Certificate (PEAP/PEAP-TLS/EAP-TLS/EAP-FAST)

Specification	Description
Format	X509v3
Extension	DER/CER/PEM
Encryption	RSA
Hashes	MD5/SHA-1/SHA-256/SHA-384/SHA-512
Key length	512/1024/2048/4096 bit
Encoding	BASE64/Binary

Web Server Certificate (Secure HTTP)

Specification	Description
Format	PKCS#12
Extension	PFX/P12
Encryption	RSA

Specification	Description
Hashes	MD5/SHA-1/SHA-256/SHA-384/SHA-512
Key length	512/1024/2048/4096 bit
Common name	Network host name
Organization	Optional
Password	Up to 32 alphanumeric characters; required

Note: You can set a password of up to 64 characters if you use a web browser to enter the text.

Parent topic: [Registering a Digital Certificate on the Projector](#)

Using Basic Projector Features

Follow the instructions in these sections to use your projector's basic features.

[Turning On the Projector](#)

[Turning Off the Projector](#)

[Selecting the Language for the Projector Menus](#)

[Adjusting the Image Height](#)

[Resizing the Image with the Zoom Button](#)

[Focusing the Image Using the Focus and Distortion Buttons](#)

[Setting the Screen Type](#)

[Adjusting the Image Position Using Lens Shift](#)

[Adjusting the Image Position Using Screen Position](#)

[Displaying a Test Pattern](#)

[Image Shape](#)

[Selecting an Image Source](#)

[Remote Control Operation](#)

[Projection Modes](#)

[Image Aspect Ratio](#)

[Color Mode](#)

[Adjusting the Brightness](#)

[Adjusting Luminance Controls](#)

[Adjusting Gamma](#)

[Setting the Date and Time](#)

Turning On the Projector

Turn on the computer or video equipment you want to use before you turn on the projector so it can display the image source.

Note: Install a circuit breaker for 13 A to 20 A to the wiring that supplies power to the projector and do not connect any other devices to that wiring.

1. Connect the power cord to the projector's power inlet. Flip the power cable holder over the plug as shown.

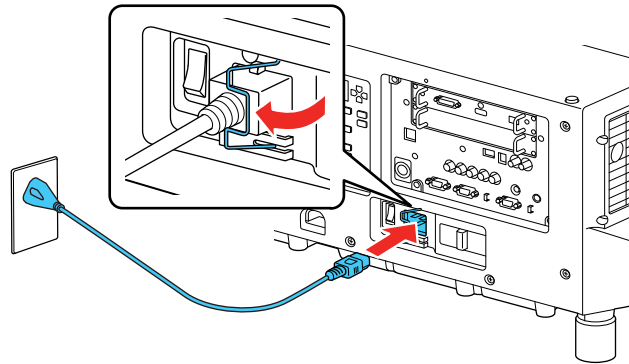

Note: If you connected the projector using the 100 V power cord, the image brightness is reduced to approximately 55% of the brightness achievable with the 220 V power cord and the Laser light flashes orange. For optimal performance, connect the 220 V power cord that came with the projector. You cannot access the **Light Source Mode**, **Estimated Remains**, or **Light Source Calibration** menu settings when connected using the 100 V power cord.

2. Plug the power cord into an electrical outlet.
3. Turn on the power switch on the side of the projector.

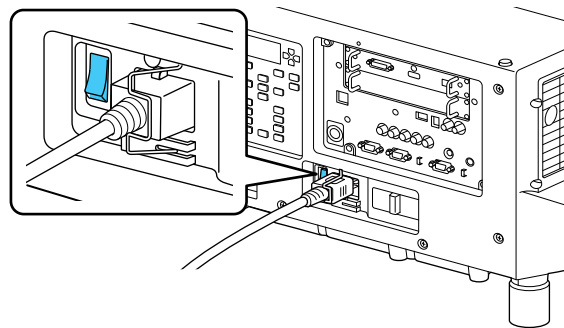

The projector's On/Standby light flashes briefly and then turns blue. This indicates that the projector is receiving power.

Note: With **Direct Power On** turned on, the projector turns on as soon as you plug it in.

4. Press the **On** button on the projector or remote control to turn on the projector.

The projector beeps and the Status light flashes blue as the projector warms up. After about 30 seconds, the Status light stops flashing and turns blue.

Warning: Never look into the projector lens when the laser is on. This can damage your eyes and is especially dangerous for children and pets.

Caution: Make sure no objects are blocking the light from the projector lens. Objects blocking the lens for an extended time can melt and light that is reflected back into the lens can cause the projector to malfunction.

If you do not see a projected image right away, try the following:

- Make sure the lens cap is off.
- Turn on the connected computer or video device.
- Insert a DVD or other video media and press the play button, if necessary.
- Press the **Search** button on the remote control to detect the video source, or press one of the source buttons on the remote control or projector.

Parent topic: [Using Basic Projector Features](#)

Related references

[Projector Setup Settings - Extended Menu](#)

Related tasks

[Turning Off the Projector](#)

Turning Off the Projector

Before turning off the projector, shut down any computer connected to it so you can see the computer display during shutdown.

Note: Turn off this product when not in use to prolong the life of the projector. Laser life will vary depending upon mode selected, environmental conditions, and usage. Brightness decreases over time.

1. Press the **Standby** button on the projector or remote control.

The projector displays a shutdown confirmation screen.



2. Press the **Standby** button on the projector or remote control again. (To leave it on, press any other button.)

The projector beeps twice, the laser turns off, and the Status light turns off.

Note: With Epson's Instant Off technology, there is no cool-down period so you can pack up the projector for transport right away (if necessary).

3. Turn off the power using the power switch on the side of the projector.

The On/Standby light turns off.

4. To transport or store the projector, make sure the Status light is off, then unplug the power cord. (If necessary, flip open the power cable holder first.)

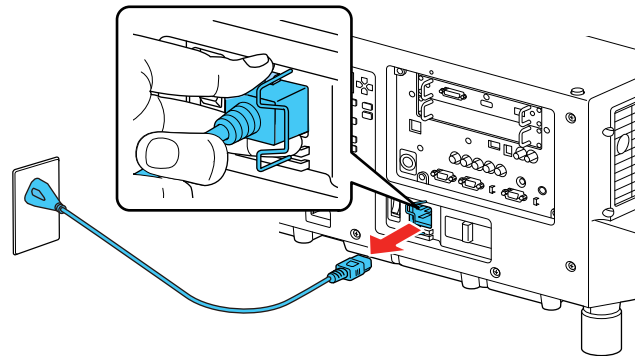

Note: If you use the projector continuously for more than 24 hours, or regularly turn it off by shutting off the power outlet, schedule periodic **Light Source Calibration** events in the Extended menu schedule settings.

Parent topic: [Using Basic Projector Features](#)

Related references

[Projector Setup Settings - Extended Menu](#)

Related tasks

[Turning On the Projector](#)

[Saving a Scheduled Event](#)

Selecting the Language for the Projector Menus

If you want to view the projector's menus and messages in another language, you can change the Language setting.

1. Turn on the projector.
2. Press the **Menu** button.
3. Select the **Extended** menu and press **Enter**.

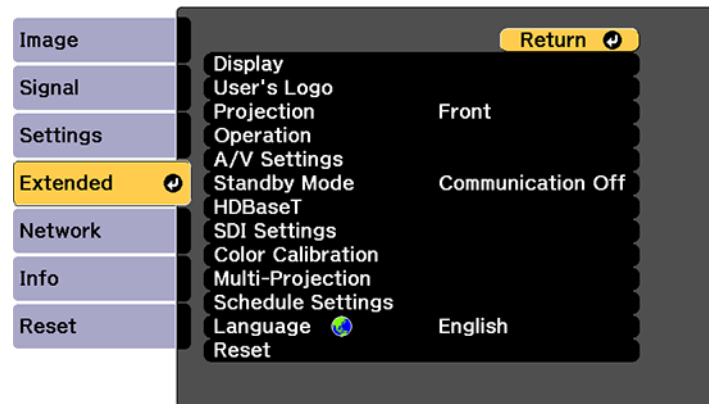

4. Select the **Language** setting and press **Enter**.
5. Select the language you want to use and press **Enter**.
6. Press **Menu** or **Esc** to exit the menus.

Adjusting the Image Height

If you are projecting from a table or other flat surface, and the image is too high or low, you can adjust the image height using the projector's adjustable feet.

1. Turn on the projector and display an image.
2. To adjust the image height, or the projector's horizontal and vertical tilt, rotate the front or rear feet to extend or retract them.

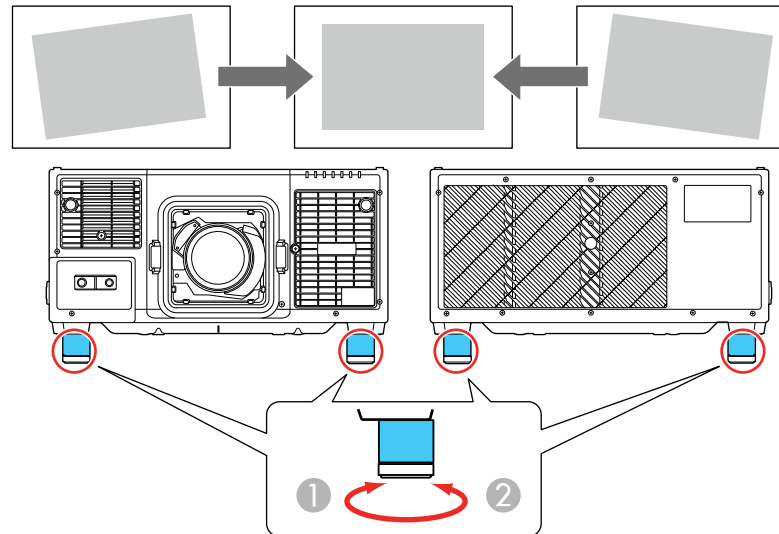

- 1 Extend the feet
- 2 Retract the feet

Note: You can adjust the projector's tilt up to 2°. You can also detach the feet or extend them up to 1.1 inches (28 mm) before they detach.

If the projected image is unevenly rectangular, you need to adjust the image shape.

Related concepts

[Image Shape](#)

Resizing the Image with the Zoom Button

You can adjust the size of the image using the zoom buttons.

Note: Wait 30 minutes after turning on the projector before setting the focus, zoom, and lens shift for maximum accuracy.

1. Turn on the projector and display an image.
2. Press the **Zoom** button on the control panel.

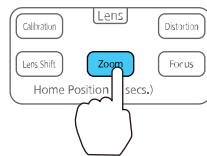

3. Press the left or right arrow buttons to resize the image.
4. Press the **Esc** button when finished.

Note: You can also press the **Zoom +** or **-** buttons on the remote control to adjust the size of the image.

Parent topic: [Using Basic Projector Features](#)

Focusing the Image Using the Focus and Distortion Buttons

You can adjust the sharpness of the projected image using the focus and distortion buttons.

Note: Wait 30 minutes after turning on the projector before setting the focus, zoom, and lens shift for maximum accuracy.

1. Turn on the projector and display an image.

Note: If you are projecting from multiple projectors that differ in brightness, display a grayscale test pattern to adjust the focus for best results.

2. Press the **Focus** button on the control panel.

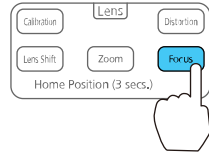

3. Do one of the following depending on the type of lens you have installed:

- **Non-short-throw zoom lens:** Press the left and right arrow buttons to adjust the focus and press the **Esc** button when finished. Skip the rest of these steps.
- **Short-throw zoom lens:** Press the left and right arrow buttons to focus the image around the center of the lens. You may see a message prompting you to correct the image distortion. Continue with the next steps.

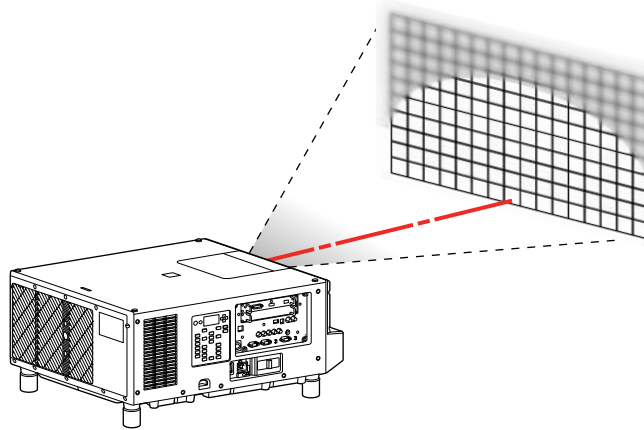

4. Press the **Distortion** button on the control panel.

5. Press the left and right arrow buttons to focus the image in the surrounding area.

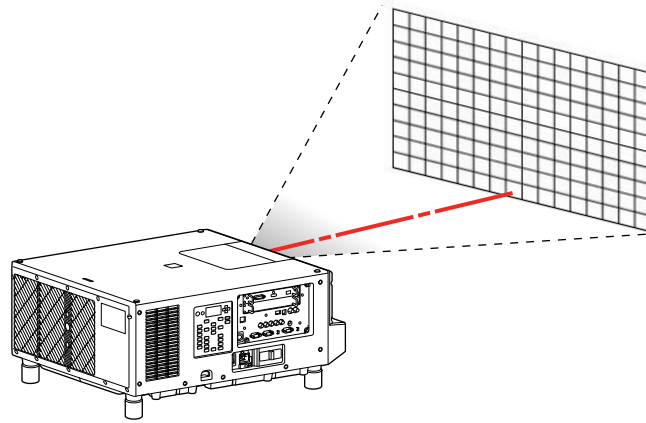

Note: You can also adjust image distortion using the **Focus +** or **-** and **Distortion +** or **-** buttons on the remote control.

6. If the center becomes out of focus again, repeat steps 2 and 3.

If you still cannot correct the focus, press the **Calibration** button on the remote control to calibrate the lens, then try focusing again.

Parent topic: [Using Basic Projector Features](#)

Related tasks

[Displaying a Test Pattern](#)

Setting the Screen Type

You can use the Screen Type setting to match the aspect ratio of the displayed image to the screen you are using.

Note: The Screen Type setting is not supported by the Message Broadcasting feature in the Epson Projector Management software.

1. Turn on the projector and display an image.
2. Press the **Menu** button.
3. Select the **Extended** menu and press **Enter**.

4. Select **Display > Screen > Screen Type**.

You see this screen:

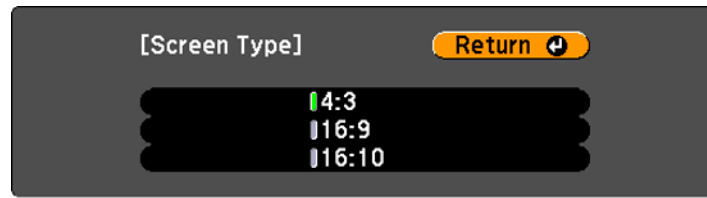

5. Select your screen's aspect ratio and press **Enter**.
6. Press the **Menu** button to exit.
7. Adjust the aspect ratio for the projected image, if necessary.

Parent topic: [Using Basic Projector Features](#)

Related concepts

[Image Aspect Ratio](#)

Adjusting the Image Position Using Lens Shift

If you cannot install the projector directly in front of the screen, you can adjust the position of the projected image using the lens shift feature.

Note: Wait 30 minutes after turning on the projector before setting the focus, zoom, and lens shift for maximum accuracy.

1. Turn on the projector and display an image.

2. Press the **Lens Shift** button on the control panel or remote control.

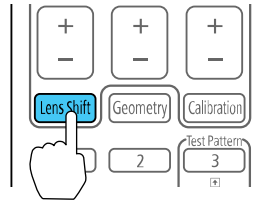
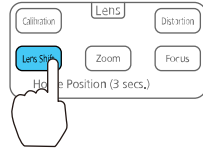

3. Press the arrow buttons on the remote control or the control panel to adjust the position of the projected image as necessary.

Note: When adjusting the image height, position the image lower than where you want it to be and then move it up. This will help prevent the image from moving down after adjustment.

Here are the lens shift ranges for the optional lenses:

ELPLU04/ELPLW06/ELPLW08/ELPLM10/ELPLM11/ELPLM15/ELPLL08

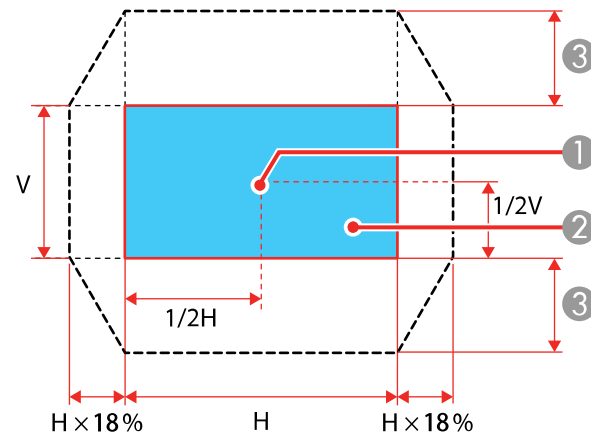

- 1 Center of lens
- 2 Projected image when lens shift is set to the home position
- 3 Maximum motion range: $V \times 60\%$

ELPLX02/ELPLX02W

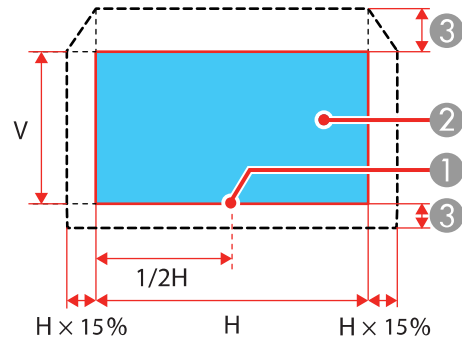

- 1 Center of lens
- 2 Projected image when lens shift is set to the home position
- 3 Maximum motion range: Up $V \times 20\%$, Down $V \times 5\%$

Note: You cannot move the image vertically when the lens is shifted horizontally all the way.

4. When you are finished, press the **Esc** button on the control panel or remote control.

Note: The image is clearest when the lens is at the home position. To move the lens to the home position, press and hold the **Lens Shift** button on the remote control or control panel for at least three seconds. Set the **A/V Output** setting in the Extended menu to **Always On** so you can move the lens to the home position even when the projector is in standby mode.

Parent topic: [Using Basic Projector Features](#)

Related references

[Projector Setup Settings - Extended Menu](#)

Adjusting the Image Position Using Screen Position

You can adjust the image position if there are margins between the edge of the image and the projected screen frame.

Note: You cannot adjust the screen position if the **Screen Type** setting is set to **16:10**.

1. Turn on the projector and display an image.
2. Press the **Menu** button.
3. Select the **Extended** menu and press **Enter**.
4. Select **Display > Screen > Screen Position**.
5. Use the arrow buttons on the remote control or projector to adjust the position of the image.

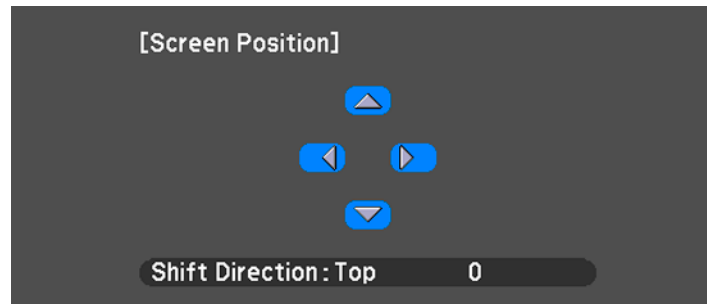

6. When you are finished, press the **Menu** button.

Parent topic: [Using Basic Projector Features](#)

Related tasks

[Setting the Screen Type](#)

Displaying a Test Pattern

You can display a test pattern to adjust the projected image without connecting a computer or video device.

Note: The test pattern's shape is determined by the **Screen Type** setting. Be sure to set the correct screen type before adjusting with the test pattern.

1. Turn on the projector.
2. Press the **Test Pattern** button on the remote control or control panel.
3. Press the left or right arrow button on the remote control, or press **Enter** on the control panel to cycle through the available test patterns.
4. Adjust the image as necessary.
5. Press the **Esc** button to clear the test pattern.

Parent topic: [Using Basic Projector Features](#)

Related tasks

[Setting the Screen Type](#)

Image Shape

You can project an evenly rectangular image by placing the projector directly in front of the center of the screen and keeping it level. If you place the projector at an angle to the screen, or tilted up or down, or off to the side, you may need to correct the image shape for the best display quality.

[Correcting Image Shape with H/V Keystone](#)

[Correcting Image Shape with Quick Corner](#)

[Correcting Image Shape with Curved Surface](#)

[Correcting Image Shape with Corner Wall](#)

[Correcting Image Shape with Point Correction](#)

Parent topic: [Using Basic Projector Features](#)

Correcting Image Shape with H/V Keystone

You can use the projector's **H/V Keystone** setting to correct the shape of an image that is unevenly rectangular on the sides.

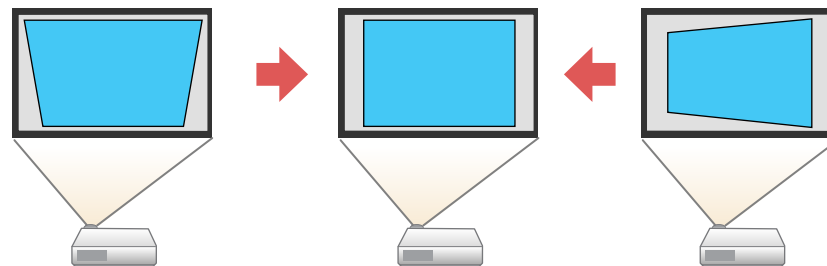

Note: You cannot combine H/V Keystone correction with other image shape correction methods.

1. Turn on the projector and display an image.
2. Press the **Geometry** button on the projector control panel or remote control.
3. Select the **H/V-Keystone** setting and press **Enter**. Then press **Enter** again.

You see the H/V-Keystone adjustment screen:



Note: You can also access the **H/V Keystone** setting by pressing the **Menu** button and selecting **Geometry Correction** on the Settings menu.

4. Use the arrow buttons on the projector or the remote control to select between vertical and horizontal keystone or balance correction and to adjust the image shape as necessary.

V-Keystone

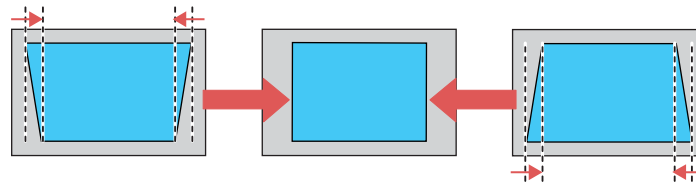

V-Balance

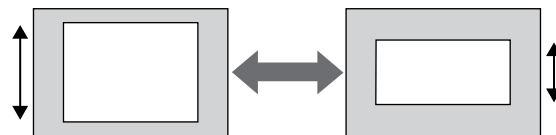

H-Keystone

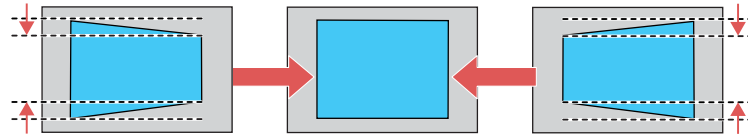

H-Balance

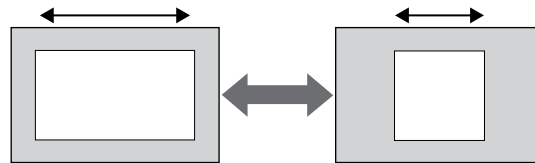

5. When you are finished, press the **Menu** button.
After correction, your image may be slightly smaller.

Parent topic: [Image Shape](#)

Related references

[Projector Feature Settings - Settings Menu](#)

Correcting Image Shape with Quick Corner

You can use the projector's Quick Corner setting to correct the shape and size of an image that is unevenly rectangular on all sides.

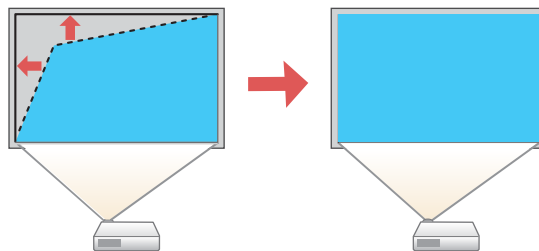

1. Turn on the projector and display an image.
2. Press the **Geometry** button on the projector control panel or remote control.
3. Select **Quick Corner** and press **Enter**.

You see the Quick Corner adjustment screen:

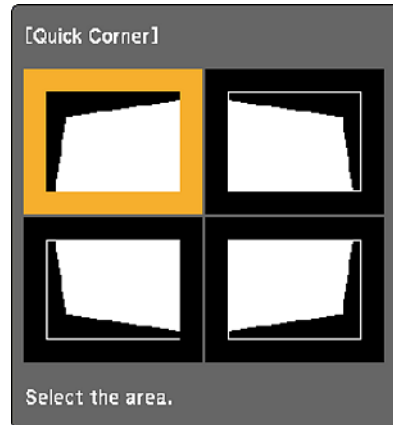

Note: You can also access the **Quick Corner** setting by pressing the **Menu** button and selecting **Geometry Correction** on the Settings menu.

4. Use the arrow buttons on the projector or remote control to select the corner of the image you want to adjust. Then press **Enter**.
5. Press the arrow buttons to adjust the image shape as necessary.

Note: To reset your adjustments, press and hold the **Esc** button for at least 2 seconds to display a reset screen. Then select **Yes** and press **Enter**.

6. When you are finished, press the **Menu** button.

Parent topic: [Image Shape](#)

Related references

[Projector Feature Settings - Settings Menu](#)

Correcting Image Shape with Curved Surface

You can use the projector's Curved Surface setting to adjust the shape of an image projected on a curved surface.

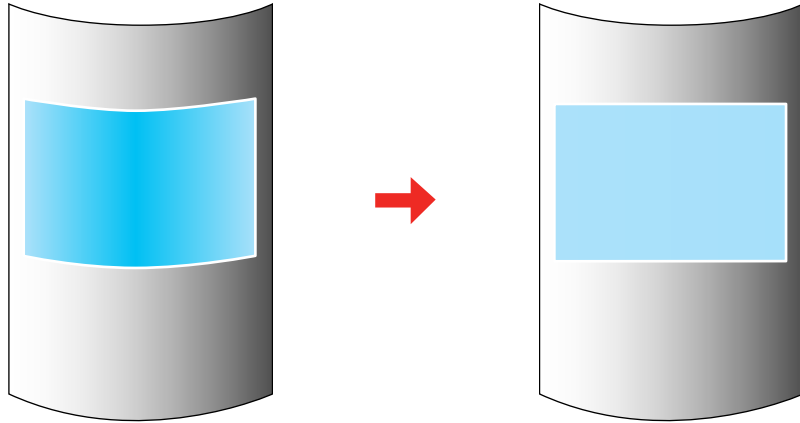

Note: For the best results, project from the front of the screen onto a surface with a uniform arc radius and with the lens in the home position.

1. Turn on the projector and display an image.
2. Press the **Geometry** button on the projector control panel or remote control.
3. Select the **Curved Surface** setting and press **Enter**. If you see a confirmation message, press **Enter** again.

You see this screen:

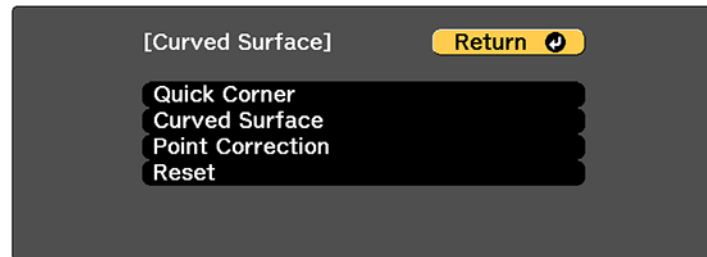

Note: You can also access the **Curved Surface** setting by pressing the **Menu** button and selecting **Geometry Correction** on the Settings menu.

4. Select **Curved Surface** again and press **Enter**.
5. Select the **Correct Shape** setting and press **Enter**.

You see a screen like this:

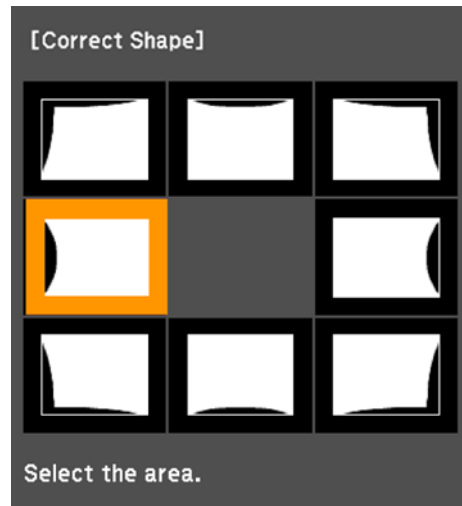

6. Use the arrow buttons on the projector or the remote control to select the area you want to adjust. Then press **Enter**.
7. Use the arrow buttons on the projector control panel or remote control to adjust the image shape.

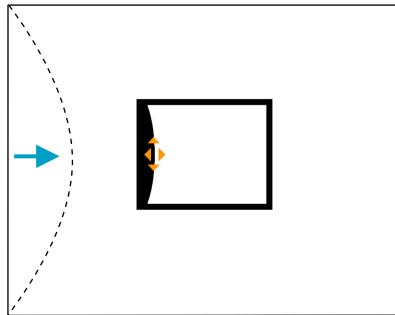

Note: If the adjustment triangle turns gray, you cannot adjust the shape any further in that direction.

8. Press the **Esc** button to return to the Curved Surface menu screen.
9. Repeat the previous three steps as necessary to adjust other image areas.

If the image expands or contracts, continue with the next steps to adjust the linearity.

Note: To reset your adjustments, press and hold the **Esc** button for at least 2 seconds to display a reset screen. Then select **Yes** and press **Enter**.

10. Press the **Esc** button.

You see this screen:

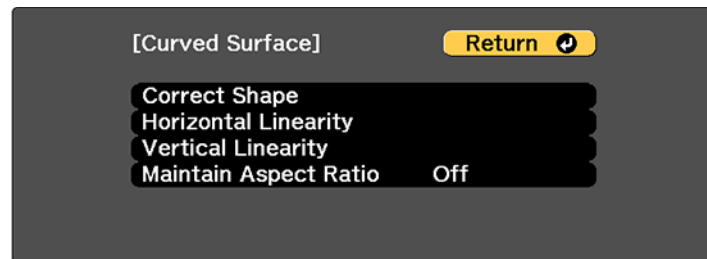

11. To compensate for expansion or contraction while maintaining the image aspect ratio, select **Maintain Aspect Ratio** and set it to **On**.
12. Select one of the following to adjust the linearity:
 - **Horizontal Linearity:** Adjusts horizontal expansion or contraction.
 - **Vertical Linearity:** Adjusts vertical expansion or contraction.
13. Use the arrow buttons to select a displayed line to use as a baseline and press **Enter**.
The selected baseline flashes orange and white.

14. Adjust the linearity by doing one of the following:

- Press the left arrow button to contract the distance between the lines closest to the baseline.

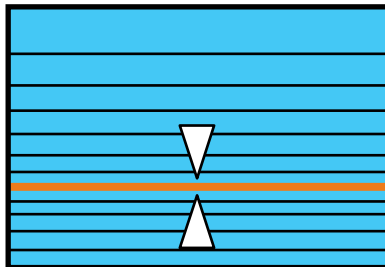
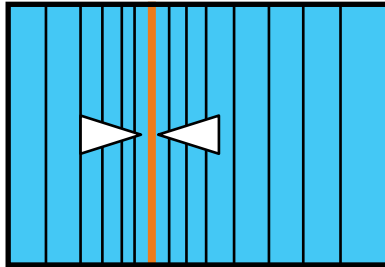

- Press the right arrow button to expand the distance between the lines closest to the baseline.

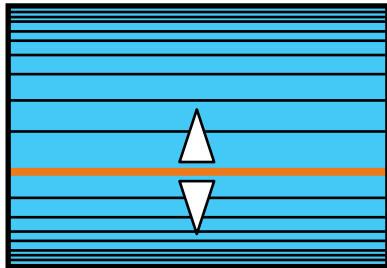
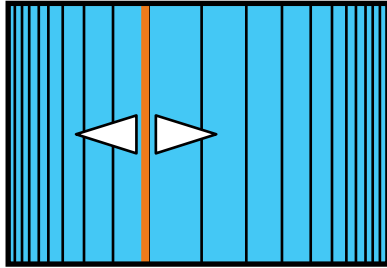

15. When you are finished, press the **Menu** button.

Note: If necessary, you can adjust the image tilt using the **Quick Corner** setting, then fine-tune your adjustments using the **Point Correction** setting.

Parent topic: [Image Shape](#)

Related references

[Projector Feature Settings - Settings Menu](#)

Related tasks

[Correcting Image Shape with Quick Corner](#)

[Correcting Image Shape with Point Correction](#)

Correcting Image Shape with Corner Wall

You can use the projector's Corner Wall setting to adjust the shape of an image projected on a surface with right angles, such as a rectangular pillar or the corner of a room.

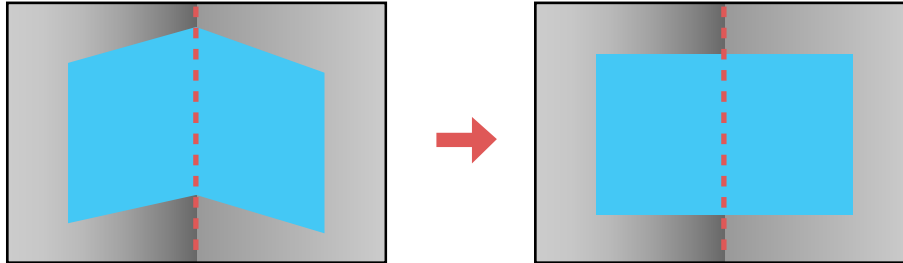

Note: For the best results, project from the front of the screen onto a right-angled surface. The image may not be evenly focused throughout even after performing the steps here.

1. Turn on the projector and display an image.
2. Press the **Geometry** button on the projector control panel or remote control.
3. Select the **Corner Wall** setting and press **Enter**.

Note: If you see a confirmation message, press **Enter**.

You see this screen:

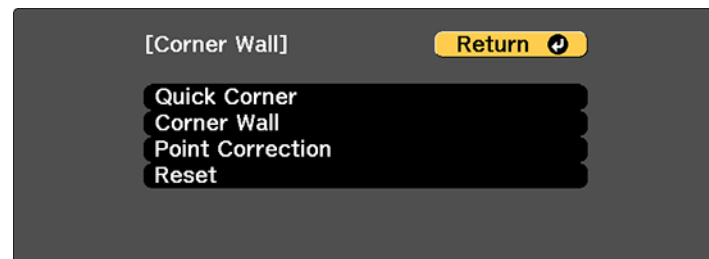

4. Select **Corner Wall** again and press Enter.
5. Select the **Corner Type** setting and press **Enter**.

6. Select one of the following:

- **Horizontal Corner** when the surfaces line up horizontally

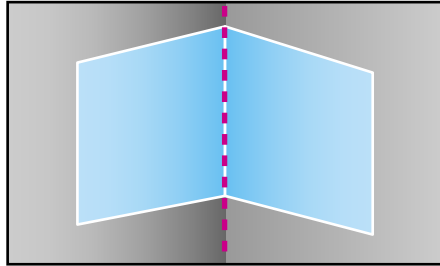

- **Vertical Corner** when the surfaces line up vertically

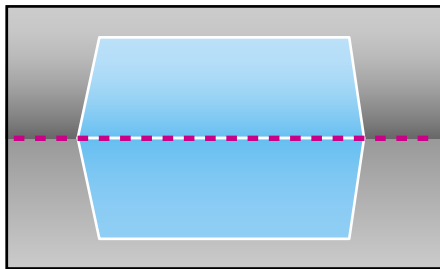

7. Press the **Esc** button to return to the Corner Wall menu screen.

8. Select the **Correct Shape** setting and press **Enter**.

9. Adjust the projector's position and use lens shift to center the image over the point where the two surfaces meet. (The rest of these steps show Horizontal Corner as the selected Corner Type but the steps are the same for Vertical Corner.)

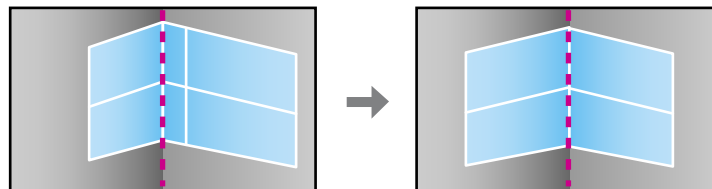

Note: You can press **Enter** to show or hide the image and grid to check the results.

10. Press the arrow buttons on the projector or the remote control to select the area you want to adjust. Then press **Enter**.

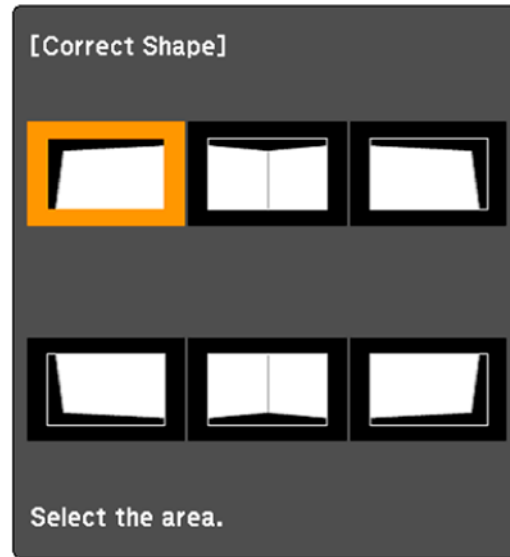

- For horizontal corners, adjust the top area using the lowest point (1) as your reference. Adjust the lower area using the highest point (2) as your reference.

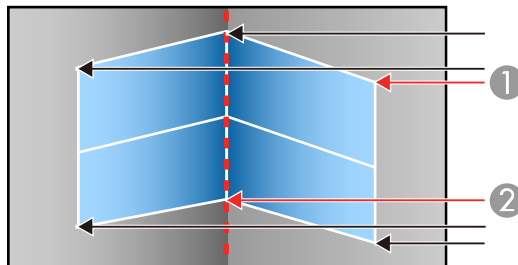

- For vertical corners, adjust the left and right areas using the points nearest the center of the image as your reference points.

11. Press the arrow buttons on the projector or remote control to adjust the image shape.

Note: To reset your adjustments, press and hold the **Esc** button for at least 2 seconds to display a reset screen. Then select **Yes**.

12. Repeat the previous two steps as necessary to adjust other image areas.

13. If the image expands or contracts, press the **Esc** button to return to the Corner Wall screen so you can adjust the linearity.

14. When you are finished, press the **Menu** button.

Note: If necessary, you can adjust the image tilt using the **Quick Corner** setting, then fine-tune your adjustments using the **Point Correction** setting.

Parent topic: [Image Shape](#)

Related tasks

[Correcting Image Shape with Quick Corner](#)

[Correcting Image Shape with Point Correction](#)

Correcting Image Shape with Point Correction

You can use the projector's Point Correction feature to fine-tune the image shape using points on a grid. This is useful for adjusting overlapping areas in multiple projected images that do not line up correctly.

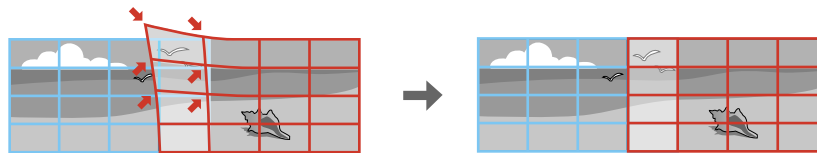

Note: You can move the points on the grid between 0.5 to 32 pixels in any direction.

1. Turn on the projector and display an image.
2. Press the **Geometry** button on the projector control panel or remote control.
3. Select the **Point Correction** setting and press **Enter**.

Note: If you see a confirmation message, press **Enter**.

4. Select the **Point Correction** setting again and press **Enter**.

You see this screen:

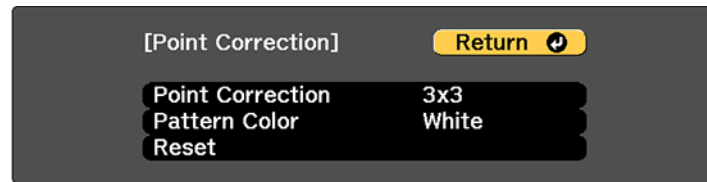

5. Select the **Point Correction** setting and press **Enter**.
6. Select the number of grid lines to display and press **Enter**.

Note: If you need to change the color of the grid lines, select the **Pattern Color** setting and select a suitable color.

7. Press the arrow buttons on the projector or remote control to move to the point on the grid that you want to adjust. Then press **Enter**.

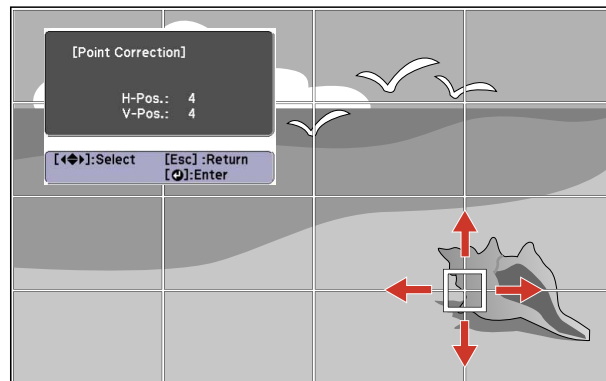

8. Press the arrow buttons to correct the image shape in all necessary directions.

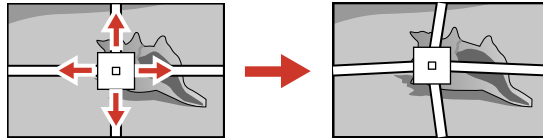

Note: You can press **Enter** to show or hide the image and grid to check the results.

9. Press **Esc** to return to the previous screen and select another point to correct, if necessary.
10. When you are finished, press the **Menu** button.

Note: If necessary, you can fine-tune your image adjustments using the **Quick Corner** setting.

Parent topic: [Image Shape](#)

Related tasks

[Correcting Image Shape with Quick Corner](#)

Selecting an Image Source

If you connected multiple image sources to the projector, such as a computer and DVD player, you may want to switch from one image source to the other.

1. Make sure the connected image source you want to use is turned on.
2. For video image sources, insert a DVD or other video media and press its play button, if necessary.
3. Do one of the following:
 - Press the **Search** button on the remote control until you see the image from the source you want.

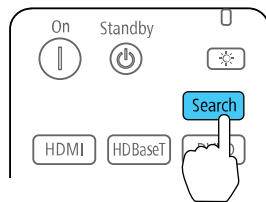

- Press the button for the source you want on the remote control. If there is more than one port for that source, press the button again to cycle through the sources.

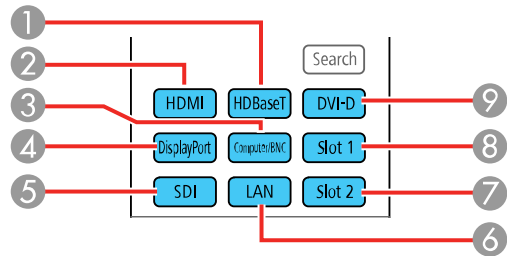

- 1 HDBaseT port source
- 2 HDMI source
- 3 Computer or BNC port source
- 4 DisplayPort source (if optional DisplayPort interface board is installed)
- 5 SDI port source
- 6 Network source
- 7 Input ports on the optional interface board in Slot 2
- 8 Input ports on the interface board in Slot 1
- 9 DVI-D source

- Press the button for the source you want on the projector control panel. If there is more than one port for that source, press the button again to cycle through the sources.

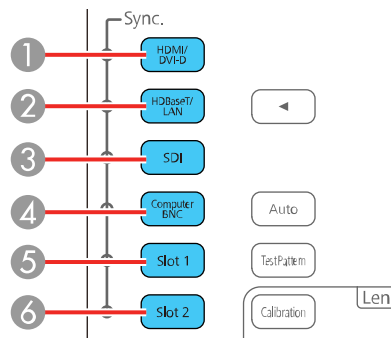

- 1 HDMI or DVI-D source
- 2 HDBaseT port or network source
- 3 SDI port source
- 4 Computer or BNC port source
- 5 Input ports on the interface board in Slot 1
- 6 Input ports on the optional interface board in Slot 2

The **Sync.** light on the control panel turns on for the currently selected input source.

Parent topic: [Using Basic Projector Features](#)

Remote Control Operation

The remote control lets you control the projector from almost anywhere in the room, up to 98.4 feet (30 m) away. You can point it at the front or rear of the projector.

Make sure that you aim the remote control at the projector's receivers within the angles listed here.

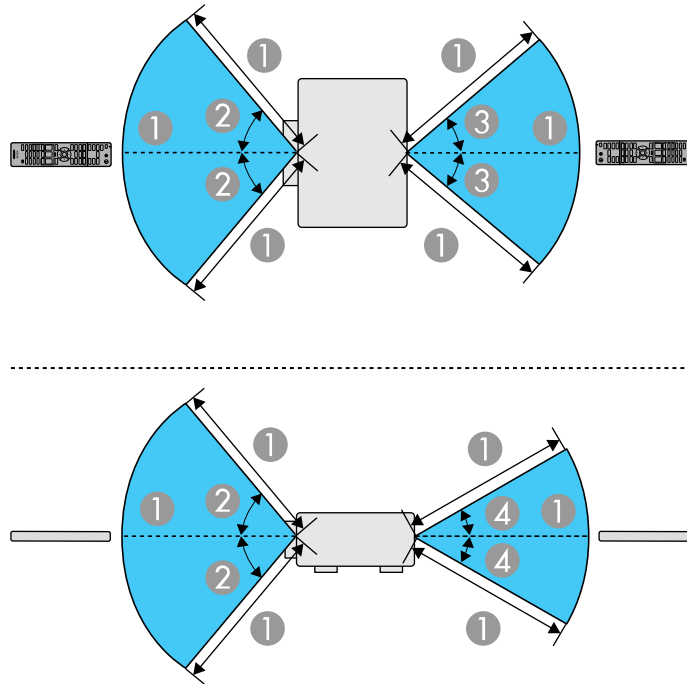

- 1 98.4 feet (30 m)
- 2 50°
- 3 40°
- 4 30°

Note: Avoid using the remote control in conditions with bright fluorescent lights or in direct sunlight, or the projector may not respond to commands. If you will not use the remote control for a long time, remove the batteries.

Parent topic: [Using Basic Projector Features](#)

Related tasks

[Replacing the Remote Control Batteries](#)

Projection Modes

Depending on how you positioned the projector, you may need to change the projection mode so your images project correctly.

- **Front** (default setting) lets you project from a table in front of the screen.
- **Front/Ceiling** flips the image over top-to-bottom to project upside-down from a ceiling or wall mount.
- **Rear** flips the image horizontally to project from behind a translucent screen.
- **Rear/Ceiling** flips the image over top-to-bottom and horizontally to project from the ceiling and behind a translucent screen.

[Changing the Projection Mode Using the Remote Control](#)

[Changing the Projection Mode Using the Menus](#)

Parent topic: [Using Basic Projector Features](#)

Changing the Projection Mode Using the Remote Control

You can change the projection mode to flip the image over top-to-bottom.

1. Turn on the projector and display an image.

2. Hold down the **Shutter** button on the remote control for 5 to 10 seconds.

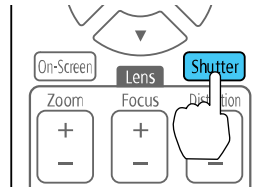

The image disappears briefly and reappears flipped top-to-bottom.

3. To change projection back to the original mode, hold down the **Shutter** button for 5 to 10 seconds again.

Parent topic: [Projection Modes](#)

Changing the Projection Mode Using the Menus

You can change the projection mode to flip the image over top-to-bottom and/or left-to-right using the projector menus.

1. Turn on the projector and display an image.
2. Press the **Menu** button.
3. Select the **Extended** menu and press **Enter**.

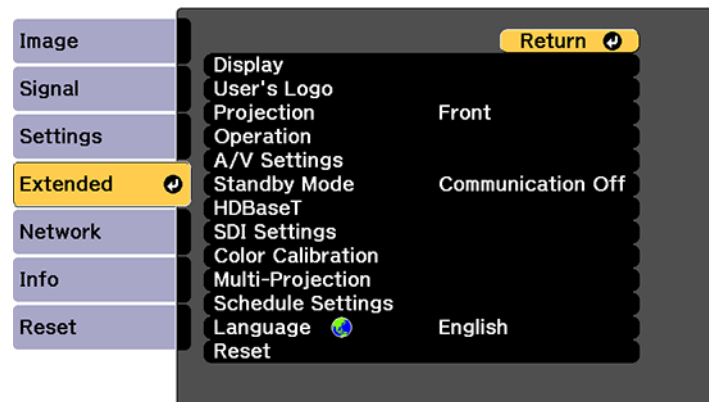

4. Select the **Projection** setting and press **Enter**.

5. Select a projection mode and press **Enter**.
6. Press **Menu** or **Esc** to exit the menus.

Parent topic: [Projection Modes](#)

Image Aspect Ratio

The projector can display images in different width-to-height ratios called aspect ratios. Normally the input signal from your video source determines the image's aspect ratio. However, for certain images you can change the aspect ratio to fit your screen by pressing a button on the remote control.

If you always want to use a particular aspect ratio for a certain video input source, you can select it using the projector's menus.

[Changing the Image Aspect Ratio](#)

[Available Image Aspect Ratios](#)

Parent topic: [Using Basic Projector Features](#)

Related references

[Input Signal Settings - Signal Menu](#)

Changing the Image Aspect Ratio

You can change the aspect ratio of the displayed image to resize it.

Note: Set the **Screen Type** setting in the projector's Extended menu before changing the aspect ratio.

1. Turn on the projector and switch to the image source you want to use.
2. Press the **Aspect** button on the remote control.

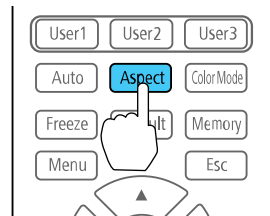

The shape and size of the displayed image changes, and the name of the aspect ratio appears briefly on the screen.

- To cycle through the available aspect ratios for your input signal, press the **Aspect** button repeatedly.

Note: If you are projecting from a computer and parts of the image are cut off, set the **Resolution** setting to **Wide** or **Normal** in the Signal menu.

Parent topic: [Image Aspect Ratio](#)

Related references

[Available Image Aspect Ratios](#)

[Input Signal Settings - Signal Menu](#)

Related tasks

[Setting the Screen Type](#)

Available Image Aspect Ratios

You can select the following image aspect ratios, depending on the selected Screen Type setting and the input signal from your image source.

Note: Black bands and cropped or stretched images may project in certain aspect ratios, depending on the aspect ratio and resolution of your input signal.

Aspect ratio setting	Description
Auto	Automatically sets the aspect ratio according to the input signal.
Normal	Displays images in the same aspect ratio of the input signal.
4:3	Displays images at a 4:3 aspect ratio.
16:9	Displays images at a 16:9 aspect ratio.
Full	Displays images using the full size of the projection area, but does not maintain the aspect ratio.
H-Zoom V-Zoom	Displays images using the full width (H-Zoom) or full height (V-Zoom) of the projection area and maintains the aspect ratio of the image. Areas that exceed the edges of the projected screen are not projected.
Native	Displays images as is (aspect ratio and resolution are maintained). Areas that exceed the edges of the projected screen are not projected.

Parent topic: [Image Aspect Ratio](#)

Related tasks

[Setting the Screen Type](#)

Color Mode

The projector offers different Color Modes to provide optimum brightness, contrast, and color for a variety of viewing environments and image types. You can select a mode designed to match your image and environment, or experiment with the available modes.

If you always want to use a particular color mode for a certain video input source, you can select it using the projector menus.

[Changing the Color Mode](#)

[Available Color Modes](#)

Parent topic: [Using Basic Projector Features](#)

Related references

[Image Quality Settings - Image Menu](#)

Changing the Color Mode

You can change the projector's Color Mode using the remote control to optimize the image for your viewing environment.

1. Turn on the projector and switch to the image source you want to use.
2. If you are projecting from a DVD player or other video source, insert a disc or other video media and press the play button, if necessary.
3. Press the **Color Mode** button on the remote control to change the Color Mode.

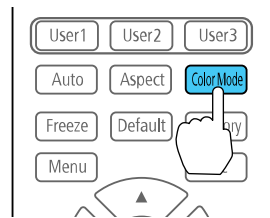

The image appearance changes and the name of the Color Mode appears briefly on the screen.

4. To cycle through all the available Color Modes for your input signal, press the **Color Mode** button repeatedly.

Parent topic: [Color Mode](#)

Related references

[Available Color Modes](#)

Available Color Modes

You can set the projector to use these Color Modes, depending on the input source you are using:

Color Mode	Description
Dynamic	Best for projecting in a bright room
Presentation	Best for color presentations in a bright room
Natural	Best for projecting still pictures such as photos
Cinema	Best for movies projected in a dark room
BT.709	Best for watching digital TV or Blu-ray discs; produces images that conform to the ITU-R BT.709 standard
DICOM SIM*	Best for projecting X-ray photographs and other medical images
Multi-Projection	Best for projecting from multiple projectors (reduces the color tone difference between images)

* Available only when inputting RGB signals

Note: The **DICOM SIM** Color Mode is for reference purposes only and should not be used to make medical diagnoses.

Parent topic: [Color Mode](#)

Adjusting the Brightness

You can adjust the brightness of your projector's light source.

1. Turn on the projector and switch to the image source you want to use.
2. Press the **Menu** button.

3. Select the **Settings** menu and press **Enter**.

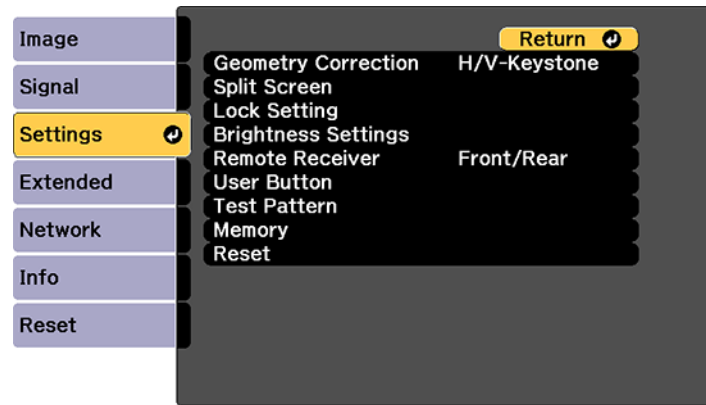

4. Select the **Brightness Settings** setting and press **Enter**.
5. Select the **Light Source Mode** setting and press **Enter**.
6. Select one of the following options:
 - **Normal**: Sets brightness to the maximum level (ideal for conference rooms, auditoriums, and lecture halls)
 - **Quiet**: Sets brightness to 70% and reduces fan noise (ideal for libraries, theaters, museums, and art galleries)
 - **Extended**: Sets brightness to 70% and extends the life expectancy of the light source (ideal for darker environments with ambient light, such as museums and art galleries, where a reduced maintenance cycle is desired)
 - **Custom**: Allows you to select a custom brightness level between 30 to 100%
7. If you selected **Custom**, select **Brightness Level** from the Brightness Settings screen and use the left and right arrow buttons to select the brightness.
8. If you selected **Custom** and want to maintain consistent brightness, turn on the **Constant Brightness** setting.

Note: If you turn on **Constant Brightness**, you cannot change the **Light Source Mode** and **Brightness Level** settings. If you turn off **Constant Brightness**, the **Brightness Level** setting changes according to the status of the light source.

9. Press **Menu** or **Esc** to exit the menus.

Note: If you use the projector continuously for more than 24 hours, or regularly turn it off by shutting off the power outlet, schedule periodic **Light Source Calibration** events from the Extended menu. Otherwise, the **Constant Brightness** setting may not work properly.

[Constant Brightness Usage Hours](#)

Parent topic: [Using Basic Projector Features](#)

Related references

[Projector Setup Settings - Extended Menu](#)

Related tasks

[Saving a Scheduled Event](#)

Constant Brightness Usage Hours

If you turn on the **Constant Brightness** setting, the number of hours the projector can maintain constant brightness is displayed as the **Estimated Remains** setting.

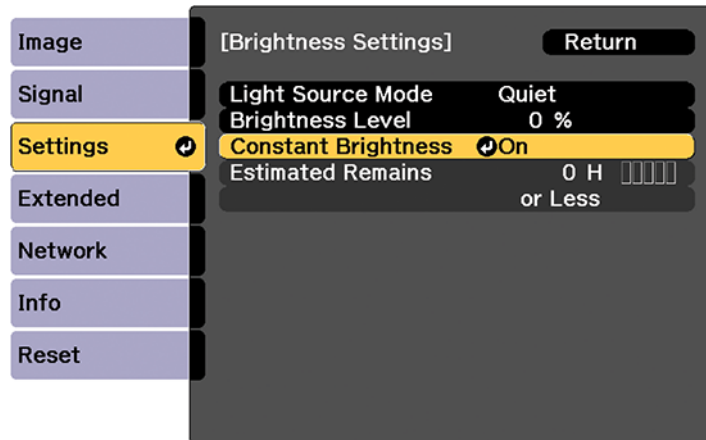

Display level	Estimated remaining hours
	10000 or more hours

Display level	Estimated remaining hours
█	8000 to 9999 hours
█	6000 to 7999 hours
█	4000 to 5999 hours
█	2000 to 3999 hours
█	0 to 1999 hours

Light source life span

The estimated life span of the light source varies depending on the **Brightness Level** setting and whether the **Constant Brightness** setting is on or off.

Constant Brightness off

Brightness Level setting	Hours
100%	20000 hours
90%	36000 hours
80%	41000 hours
70%	43000 hours
60%	46000 hours
50%	57000 hours
40%	75000 hours
30%	103000 hours

Constant Brightness on

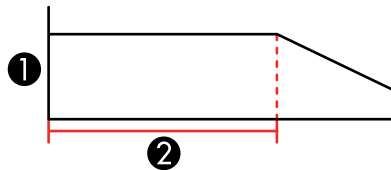

1 Brightness level

2 Time the projector can maintain constant brightness (approximate)

Brightness Level setting	Hours
85%	7000 hours
80%	15000 hours
70%	25000 hours
60%	35000 hours
50%	47000 hours
40%	66000 hours
30%	95000 hours

Note: The light source usage hours vary depending upon environmental conditions and usage. The hours listed here are an approximate and are not guaranteed. You may need to replace parts in the projector sooner than the estimated light source operation time. If **Constant Brightness** is turned on, and you have exceeded the usage hours listed here, you may not be able to select a high **Brightness Level** setting.

Parent topic: [Adjusting the Brightness](#)

Adjusting Luminance Controls

You can turn on the **Dynamic Contrast** setting to automatically optimize the image luminance. This improves the image contrast based on the brightness of the content you project. You can also set the light source to turn off automatically after a certain time period while projecting at a specific brightness level.

1. Turn on the projector and switch to the image source you want to use.
2. Press the **Menu** button.

3. Select the **Image** menu and press **Enter**.

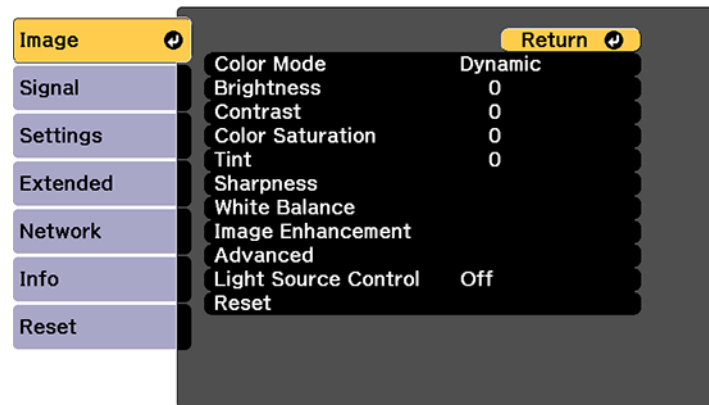

4. Select the **Light Source Control** setting and press **Enter**.

You see this screen:

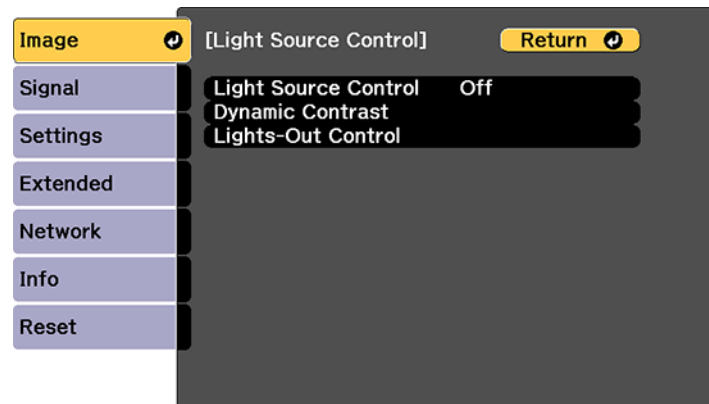

5. Select the **Light Source Control** setting, choose one of the following options, and press **Enter**:
 - **Off**: Turns off light source control.
 - **Dynamic Contrast**: Automatically adjusts the amount of light according to the brightness of the image.

- **Lights-Out Control:** Automatically turns off the light after a certain time has elapsed while projecting at the specified video level.
6. Press the **Esc** button.
 7. If you selected **Dynamic Contrast** as the **Light Source Control** setting, select the **Dynamic Contrast** setting, choose one of the following options, and press **Enter**:
 - Select the **Response Speed** setting and select either **Normal** (to adjust brightness at the standard speed) or **High Speed** (to adjust brightness as soon as the scene changes).
 - Select the **Black Level** setting and select the black level you want to project when the brightness level of the image signal is zero. (If you select **0%**, the light source turns off.)
 8. If you selected **Lights-Out Control** as the **Light Source Control** setting, select the **Lights-Out Control** setting, choose one of the following options, and press **Enter**:
 - Select the **Light-Out Signal Level** setting and select the brightness level for the current video signal. If the brightness level exceeds this level, the light source turns off automatically and then turns back on immediately.
 - Select the **Lights-Out Timer** setting and select the amount of time before the light source automatically turns off.
 9. Press **Menu** to exit the menus.

Parent topic: [Using Basic Projector Features](#)

Adjusting Gamma

You can adjust the gamma to improve differences in halftone brightness that vary depending on the connected device.

Note: Project a still image to adjust the gamma; you cannot adjust it properly when projecting a movie or other moving video. Medical images may not reproduce correctly depending on your operating environment and screen.

1. Turn on the projector and switch to the image source you want to use.
2. Press the **Menu** button.
3. Select the **Image** menu and press **Enter**.
4. Select **Advanced**, select the **Gamma** setting, and press **Enter**.

You see a screen like this:

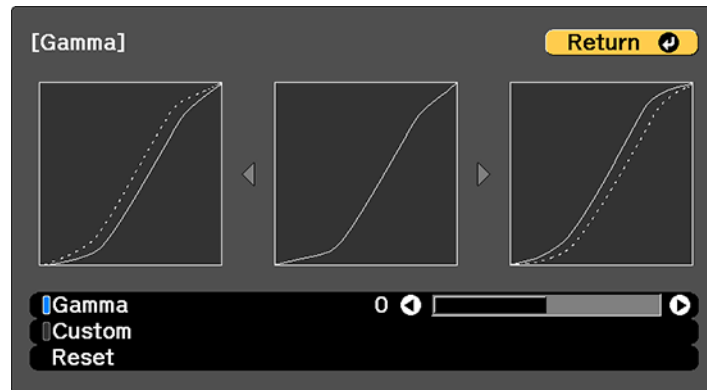

5. Use the arrow buttons to adjust the value of the **Gamma** setting as follows:
 - To brighten darker areas of the image, select higher gamma values. (Color saturation in the lighter areas may become weaker.)
 - To reduce overall image brightness and sharpen the image, select lower gamma values.
 - If you are projecting using **DICOM SIM** as the **Color Mode** setting, adjust the gamma according to the projection width. If it is less than 150 inches (3.81 m) wide, select a smaller value; if it is wider, select a larger value.
6. To adjust specific tones in the gamma using a graph, select the **Custom** setting and press **Enter**.

You see a screen like this:

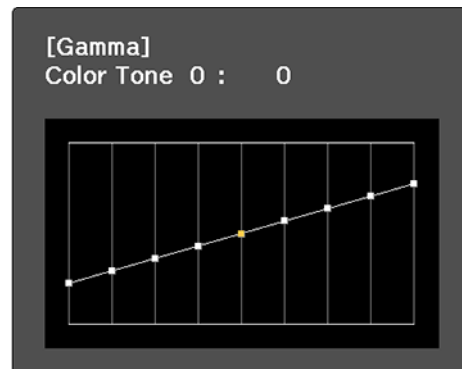

7. Press the left or right arrow button to select the tone you want to change, then press the up or down arrow button to adjust the tone and press **Enter**.
8. Press **Menu** to exit the menus.

Parent topic: [Using Basic Projector Features](#)

Setting the Date and Time

You can set the date and time for the projector.

Note: If the **Schedule Protection** setting in the Password Protection screen is enabled, you cannot change the date and time settings.

1. Press the **Menu** button.
2. Select the **Extended** menu and press **Enter**.
3. Select the **Operation** setting and press **Enter**.
4. Select the **Date & Time** setting and press **Enter**.

You see a screen like this:

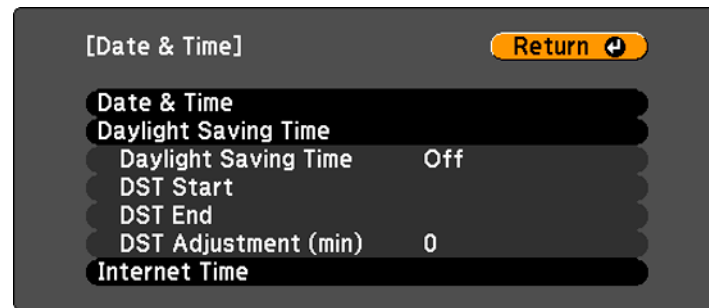

5. Select your date and time settings. Then select **Set** and press **Enter** to confirm your changes.
6. When you are finished, press the **Menu** button to exit.

[Date and Time Settings](#)

Parent topic: [Using Basic Projector Features](#)

Related concepts

[Password Security Types](#)

Date and Time Settings

Settings	Options	Description
Date & Time	Date Time Time Difference (UTC)	Adjusts the projector's date and time settings Date and Time: sets the date and time Time Difference (UTC): sets the time difference from Coordinated Universal Time
Daylight Saving Time	Daylight Saving Time DST Start DST End DST Adjustment (min)	Adjusts the daylight saving time settings Daylight Saving Time: enables or disables daylight saving time DST Start and DST End: sets the date and time to start or end daylight saving time DST Adjustment (min): sets the difference between standard and daylight saving time
Internet Time	Internet Time Internet Time Server	Automatically adjusts the time through an Internet connection Internet Time: turn on this setting to update the date and time automatically through an Internet time server Internet Time Server: sets the IP address for the Internet time server

Parent topic: [Setting the Date and Time](#)

Adjusting Projector Features

Follow the instructions in these sections to use your projector's feature adjustments.

[Shutting Off the Picture Temporarily](#)

[Stopping Video Action Temporarily](#)

[Projector Security Features](#)

[Projecting Two Images Simultaneously](#)

[Using Advanced Image Adjustment Features](#)

[Using Multiple Projectors](#)

[Enabling Protocol Emulation](#)

[Saving Settings to Memory and Using Saved Settings](#)

[Saving a Scheduled Event](#)

[Copying Menu Settings Between Projectors](#)

Shutting Off the Picture Temporarily

You can temporarily turn off the projected picture if you want to redirect your audience's attention during a presentation. Any video action continues to run, however, so you cannot resume projection at the point that you stopped it.

Note: If the picture is off for more than 2 hours, the power automatically turns off. You can disable the **Shutter Timer** setting in the Extended Menu to turn off this feature.

1. Press the **Shutter** button on the projector's control panel or remote control to temporarily stop projection.

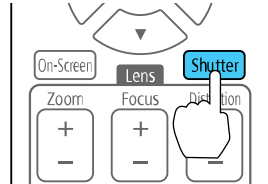
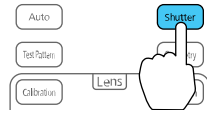

2. To turn the picture back on, press the **Shutter** button again.

Note: To fade the image in and out when you press the **Shutter** button, turn on the **Fade-out** and **Fade-in** settings in the Extended menu. If you selected **Shutter** as the **Shutter Release** setting in the Extended menu, you can still control the projector while the shutter feature is active.

Parent topic: [Adjusting Projector Features](#)

Related references

[Projector Setup Settings - Extended Menu](#)

Stopping Video Action Temporarily

You can temporarily stop the action in a video or computer presentation and keep the current image on the screen. Any video action continues to run, however, so you cannot resume projection at the point that you stopped it.

1. Press the **Freeze** button on the remote control to stop the video action.

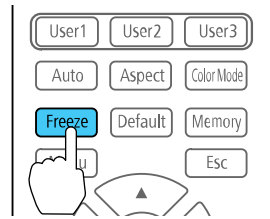

2. To restart the video action in progress, press **Freeze** again.

Parent topic: [Adjusting Projector Features](#)

Projector Security Features

You can secure your projector to deter theft or prevent unintended use by setting up the following security features:

- Password security to prevent the projector from being turned on, and prevent changes to the startup screen and other settings.
- Button lock security to block operation of the projector using the buttons on the control panel or remote control.
- Security cabling to physically cable the projector in place.

[Password Security Types](#)

[Locking the Projector's Lens Settings and Buttons](#)

[Locking the Remote Control Buttons](#)

[Installing a Security Cable](#)

Parent topic: [Adjusting Projector Features](#)

Password Security Types

You can set up these types of password security using one shared password:

- **Power On Protection** password prevents anyone from using the projector without first entering a password.
- **User's Logo Protection** password prevents anyone from changing the custom screen the projector can display when it turns on. The presence of the custom screen discourages theft by identifying the projector's owner.

- **Network Protection** password prevents anyone from changing the network settings in the projector menus.
- **Schedule Protection** password prevents anyone from changing the projector's time or schedule settings.
- **Remote Camera Access** password prevents anyone from changing the projector's **Remote Camera Access** settings in the Network menu.

Note: Additional security measures are available for the Remote Camera Access feature. Contact Epson for details.

[Setting a Password](#)

[Selecting Password Security Types](#)

[Entering a Password to Use the Projector](#)

[Saving a User's Logo Image to Display](#)

Parent topic: [Projector Security Features](#)

Setting a Password

To use password security, you must set a password.

Note: The default password is set to **0000**.

1. Hold down the **Freeze** button on the remote control for about five seconds or until you see this menu.

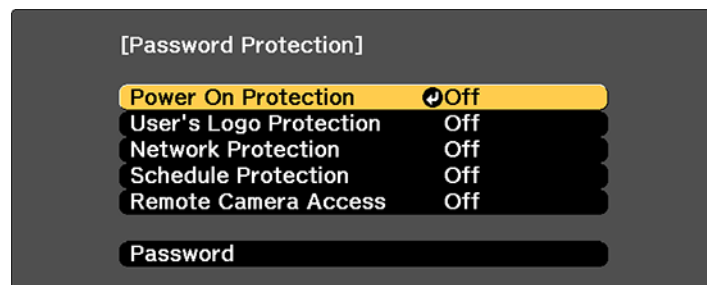

2. Press the down arrow to select **Password** and press **Enter**.
You see the prompt "Change the password?".

3. Select **Yes** and press **Enter**.
4. Press and hold down the **Num** button on the remote control and use the numeric buttons to set a four-digit password.

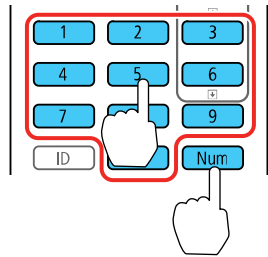

The password displays as **** as you enter it. Then you see the confirmation prompt.

5. Enter the password again.
You see the message "Password accepted."
6. Press **Esc** to return to the menu.
7. Make a note of the password and keep it in a safe place in case you forget it.

Parent topic: [Password Security Types](#)

Selecting Password Security Types

After setting a password, you see this menu, allowing you to select the password security types you want to use.

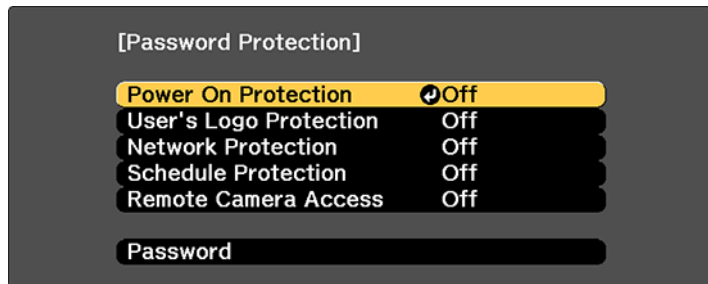

If you do not see this menu, hold down the **Freeze** button on the remote control for about five seconds or until the menu appears.

- To prevent unauthorized use of the projector, select **Power On Protection**, press **Enter**, select **On**, press **Enter** again, and press **Esc**.
- To prevent changes to the User's Logo screen or related display settings, select **User's Logo Protection**, press **Enter**, select **On**, press **Enter** again, and press **Esc**.
- To prevent changes to network settings, select **Network Protection**, press **Enter**, select **On**, press **Enter** again, and press **Esc**.
- To prevent changes to the projector's time or schedule settings, select **Schedule Protection**, press **Enter**, select **On**, press **Enter** again, and press **Esc**.
- To prevent changes to the projector's **Remote Camera Access** settings in the Network menu, select **Remote Camera Access**, press **Enter**, select **On**, press **Enter** again, and press **Esc**.

Note: Be sure to keep the remote control in a safe place; if you lose it, you will not be able to enter the password required to use the projector.

Parent topic: [Password Security Types](#)

Entering a Password to Use the Projector

If a password is set up and a **Power On Protection** password is enabled, you see a prompt to enter a password whenever you turn on the projector.

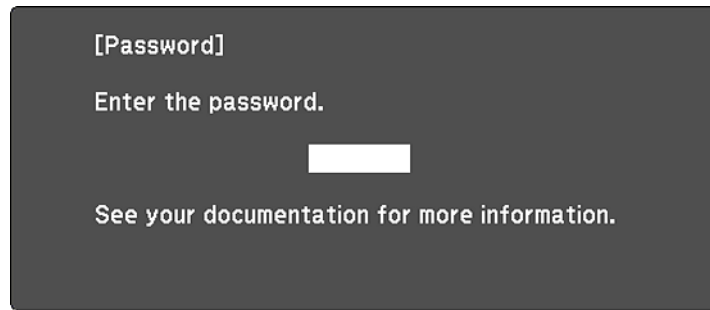

[0-9] :Enter

You must enter the correct password to use the projector.

1. Press and hold down the **Num** button on the remote control while you enter the password using the numeric buttons.

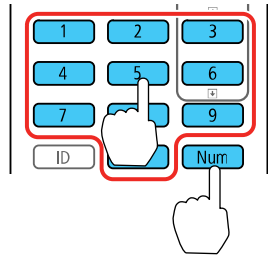

Note: The default password is **0000**.

The password screen closes.

2. If the password is incorrect, the following may happen:
 - You see a "wrong password" message and a prompt to try again. Enter the correct password to proceed.
 - If you have forgotten the password, make note of the **Request Code: xxxxx** number that appears on the screen and contact Epson Support.
 - If you enter an incorrect password three times in succession, you see a message telling you that the projector is locked. After the message is displayed for 5 minutes, the projector enters standby mode. Unplug the projector, plug in the power cord, and turn on the projector. You see a prompt to enter the password.
 - If you continue to enter an incorrect password many times in succession, the projector displays a request code and a message to contact Epson Support. Do not attempt to enter the password again. When you contact Epson Support, provide the displayed request code and proof of ownership for assistance in unlocking the projector.

Parent topic: [Password Security Types](#)

Related references

[Where to Get Help](#)

Saving a User's Logo Image to Display

You can transfer an image to the projector and then display it whenever the projector turns on. You can also display the image when the projector is not receiving an input signal or when you temporarily stop projection (using the Shutter feature). This transferred image is called the User's Logo screen.

The image you select as the User's Logo can be a photo, graphic, or company logo, which is useful in identifying the projector's owner to help deter theft. You can prevent changes to the User's Logo by setting up password protection for it.

Note: When you copy the menu settings from one projector to another using the batch setup feature, the user logo is also copied. Do not include any information in the user logo that you do not want to share between multiple projectors.

1. Display the image you want to project as the User's Logo.
2. Press the **Menu** button, select the **Extended** menu, and press **Enter**.

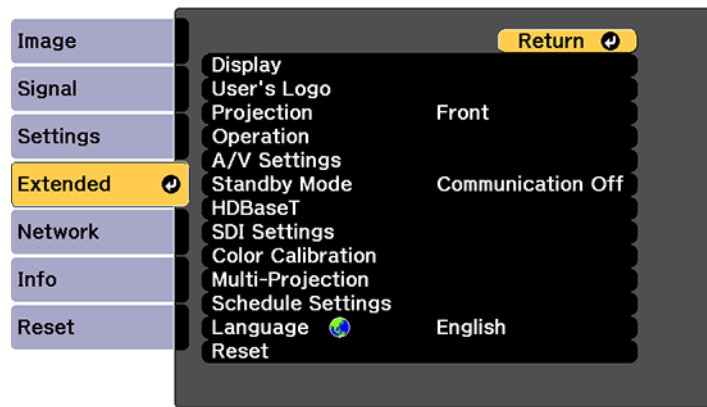

3. Select the **User's Logo** setting and press **Enter**.
4. Select **Start Setting** and press **Enter**.
You see a prompt asking if you want to use the displayed image as a user's logo.
5. Select **Yes** and press **Enter**.
6. Select the capture size and press **Enter**.
7. Use the arrow buttons on the remote control or control panel to surround the image area you want to use as the User's Logo and press **Enter**.
You see a prompt asking if you want to select this image area.
8. Select **Yes** and press **Enter**. (If you want to change the selected area, select **No**, press **Enter**, and repeat the last step.)
You see the User's Logo zoom factor menu.

9. Select a zoom percentage and press **Enter**.
You see a prompt asking if you want to save the image as the User's Logo.
 10. Select **Yes** and press **Enter**.
You see a completion message.
 11. Press **Esc** to exit the message screen.
 12. Select the **Extended** menu and press **Enter**.
 13. Select **Display** and press **Enter**.
 14. Select when you want to display the User's Logo screen:
 - To display it whenever there is no input signal, select **Display Background** and set it to **Logo**.
 - To display it whenever you turn the projector on, select **Startup Screen** and set it to **On**.
- To prevent anyone from changing the User's Logo settings without first entering a password, set a password and enable User's Logo security.

Parent topic: [Password Security Types](#)

Related tasks

[Saving Settings to Memory and Using Saved Settings](#)

Locking the Projector's Lens Settings and Buttons

You can lock the buttons on the projector's control panel to prevent anyone from using the projector. You can also lock the zoom, focus, and lens shift settings to prevent them from being adjusted.

Note: You can use the remote control to control the projector when the control panel buttons are locked.

1. Press the **Menu** button.

2. Select the **Settings** menu and press **Enter**.

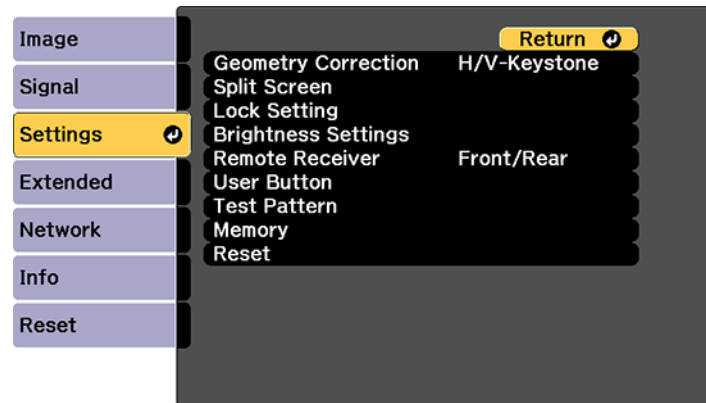

3. Select the **Lock Setting** setting and press **Enter**.

Note: You can also press the lock button on the control panel to display the Control Panel Lock screen.

4. Select one of these lock types and press **Enter**:

- To lock the zoom, focus, and lens shift settings, select **Lens Lock**.
- To lock all buttons, select **Control Panel Lock > Full Lock**.
- To lock all buttons except the power button, select **Control Panel Lock > Partial Lock**.

Note: A message is displayed on the screen if any control panel buttons are pressed while this setting is enabled.

You see a confirmation prompt.

5. Select **Yes** and press **Enter**.
6. Restart the projector for the lock settings to take effect.

[Unlocking the Projector's Buttons](#)

Parent topic: [Projector Security Features](#)

Related tasks

[Locking the Remote Control Buttons](#)

Unlocking the Projector's Buttons

If the projector's control panel buttons have been locked, hold the **Enter** or  lock button on the projector's control panel for seven seconds to unlock them. You can also use the remote control to set the **Control Panel Lock** setting to **Off** in the Settings menu.

If the remote control buttons have been locked, hold the **i** button on the remote control for 5 seconds to unlock them.

Parent topic: [Locking the Projector's Lens Settings and Buttons](#)

Related references

[Projector Feature Settings - Settings Menu](#)

[Projector Parts - Remote Control](#)

Related tasks

[Locking the Remote Control Buttons](#)

Locking the Remote Control Buttons

You can lock some of the buttons on the remote control.

To lock the remote control buttons related to lens operation, turn on the **Lens Lock** setting in the Settings menu.

To lock the remote control buttons shown here, press and hold the **i** button on the remote control for approximately 5 seconds. (To unlock the buttons, press and hold the **i** button again for approximately 5 seconds.)

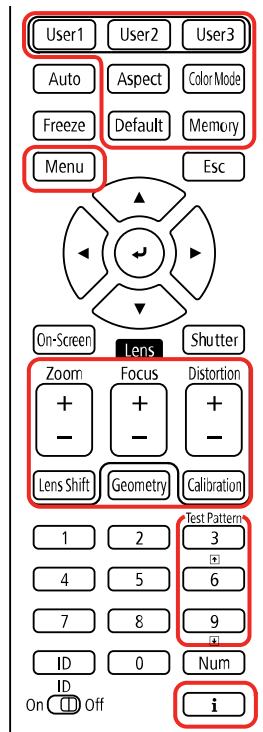

Note: If you lock the remote control buttons, you can still reset the **Remote Receiver** setting in the Settings menu to the default settings.

Parent topic: [Projector Security Features](#)

Related references

[Projector Feature Settings - Settings Menu](#)

Related tasks

[Locking the Projector's Lens Settings and Buttons](#)

Installing a Security Cable

You can install two types of security cables on the projector to deter theft.

- Use the security slot on the projector to attach a Kensington lock. See your local computer or electronics dealer for purchase information.
- Use both of the drop-prevention wire attachment points to connect a wire to the projector that supports a weight of at least 220.5 lb (100 kg). Secure the wire to the wall, ceiling, or projector mount without leaving any slack in the wire. Check any installation instructions included with the wire.

Parent topic: [Projector Security Features](#)

Related references

[Projector Parts - Side/Rear](#)

[Projector Parts - Base](#)

Projecting Two Images Simultaneously

You can use the split screen feature to simultaneously project two images from different image sources next to each other. You can control the split screen feature using the projector menus.

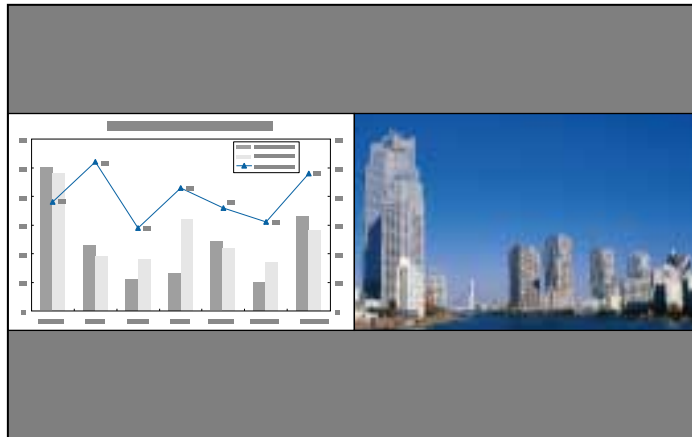

Note: While you use the split screen feature, other projector features may not be available and some settings may be automatically applied to both images. You cannot project from the same input source onto both sides (left and right) of the screen. You also cannot use split screen with certain input source combinations.

1. Press the **Menu** button.
2. Select the **Settings** menu and press **Enter**.

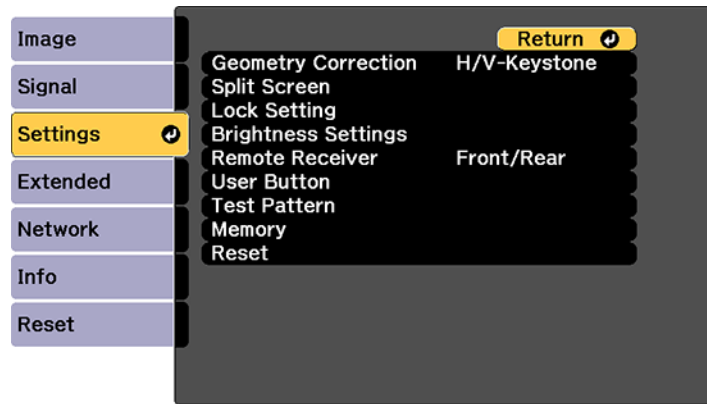

3. Select **Split Screen** and press **Enter**.
4. Press the **Menu** button.

You see this screen:

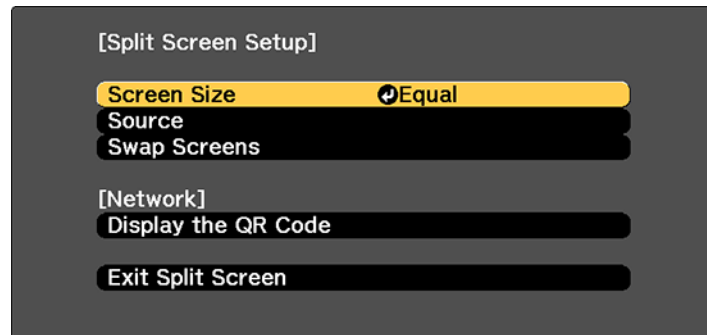

5. To select an input source for the other image, select the **Source** setting, press **Enter**, select the input source, select **Execute**, and press **Enter**. (You can also change image sources, if necessary.)
6. To switch the images, select the **Swap Screens** setting and press **Enter**.

- To change the image sizes, select the **Screen Size** setting, press **Enter**, select a sizing option, press **Enter**, and press **Menu** to exit.

Note: Depending on the video input signals, the images may not appear at the same size even if you choose the **Equal** setting.

- To exit the split screen feature, select **Exit Split Screen** or press the **Esc** button.

[Input Sources for Split Screen Projection](#)

Parent topic: [Adjusting Projector Features](#)

Input Sources for Split Screen Projection

You can choose from the input source combinations listed here for split screen projection.

Note: If you installed the optional DisplayPort interface board, you also cannot choose the port 1 and port 2 input sources for split screen projection.

Left Screen	Right Screen						
	HDMI	HDBaseT	DVI-D	SDI	Computer	BNC	LAN
HDMI	—	✓	—	✓	✓	✓	✓
HDBaseT	✓	—	✓	✓	✓	✓	✓
DVI-D	—	✓	—	✓	✓	✓	✓
SDI	✓	✓	✓	—	—	—	—
Computer	✓	✓	✓	—	—	—	—
BNC	✓	✓	✓	—	—	—	—
LAN	✓	✓	✓	—	—	—	—

Parent topic: [Projecting Two Images Simultaneously](#)

Related references

[Projector Parts - Interface Ports](#)

Using Advanced Image Adjustment Features

Follow the instructions in these sections to use your projector's advanced image adjustments.

Using Frame Interpolation
Creating Image Presets
Using MPEG Noise Reduction
Adjusting Scaled Resolution Images (Super-resolution)
Adjusting Detail Enhancement
Adjusting the Color Convergence (Panel Alignment)
Adjusting the Color Tone (Color Uniformity)
Running Light Source Calibration

Parent topic: Adjusting Projector Features

Using Frame Interpolation

You can use the projector's Frame Interpolation feature to smooth fast-moving video by comparing consecutive image frames and inserting an intermediate image frame between them.

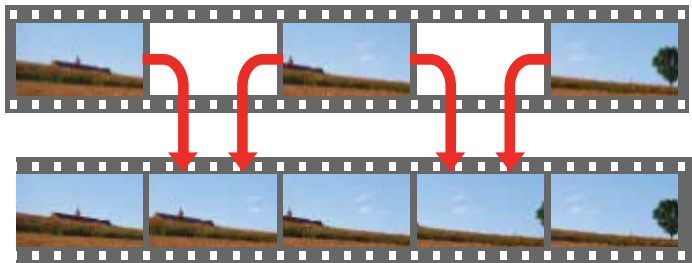

You cannot use this feature in any of the following conditions:

- The input signal exceeds 1920 in horizontal resolution
- You selected **V-Zoom** as the **Aspect** setting
- You turned on the **Edge Blending** or **Scale** settings

1. Press the **Menu** button.

You see a screen like this:

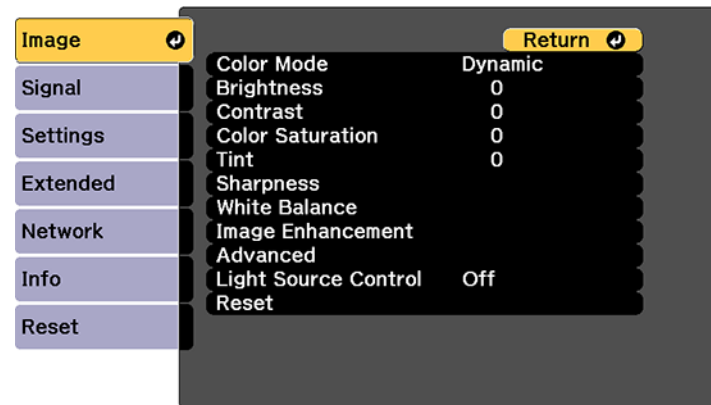

2. Select the **Image Enhancement** setting and press **Enter**.
3. Select the **Frame Interpolation** setting and press **Enter**.

You see a screen like this:

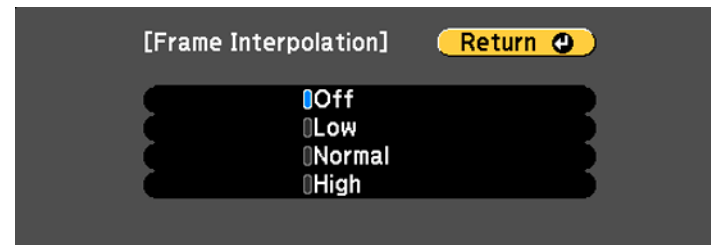

4. Select the level of interpolation and press **Enter**.
5. When you are finished, press the **Menu** button.

Note: If your resulting images contain noise, turn off the **Frame Interpolation** setting.

Parent topic: [Using Advanced Image Adjustment Features](#)

Creating Image Presets

You can quickly optimize your projected image by selecting image adjustment settings and saving them as a preset you can reuse later.

You can save the following settings in a preset:

- Frame Interpolation
- Deinterlacing
- Noise Reduction
- MPEG Noise Reduction
- Super-resolution
- Detail Enhancement

1. Press the **Menu** button.

You see a screen like this:

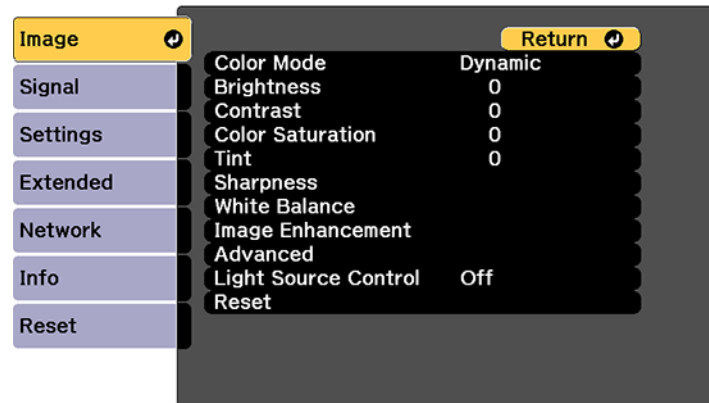

2. Select the **Image Enhancement** setting and press **Enter**.

3. Select the **Image Preset Mode** setting and press **Enter**.

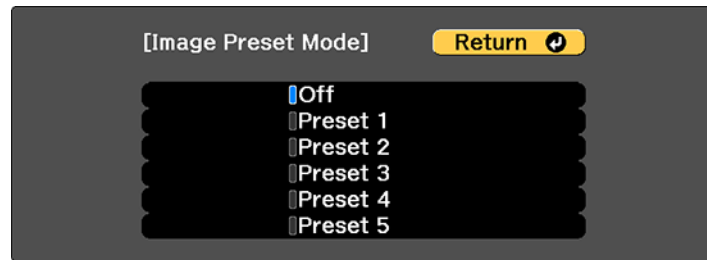

4. Select one of the presets and press **Enter**.

Note: If you select a previously used preset, your new adjustments overwrite the old ones.

5. Press **Esc** to return to the Image Enhancement menu.

6. Fine-tune the following settings:

- Frame Interpolation
- Deinterlacing
- Noise Reduction
- MPEG Noise Reduction
- Super-resolution
- Detail Enhancement

7. Press **Menu** or **Esc** to exit the menus.

The currently selected **Image Preset Mode** will be updated with the current settings.

Parent topic: [Using Advanced Image Adjustment Features](#)

Using MPEG Noise Reduction

If you are projecting MPEG movies, you can reduce dots and block noise by adjusting the **MPEG Noise Reduction** setting.

You cannot use this feature if the input signal exceeds 1920 horizontal resolution.

1. Press the **Menu** button.

You see a screen like this:

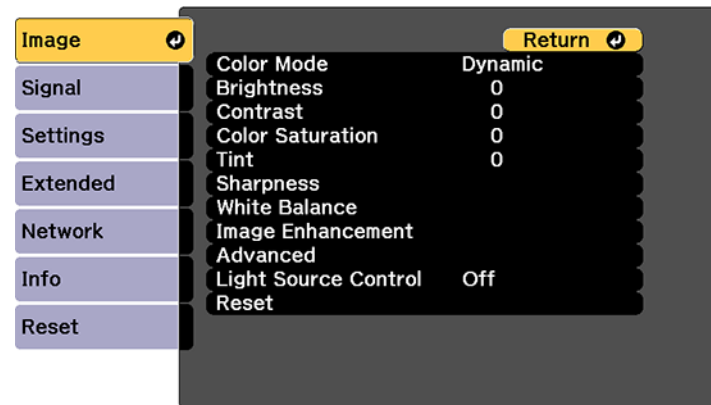

2. Select the **Image Enhancement** setting and press **Enter**.
3. Select the **MPEG Noise Reduction** setting and press **Enter**.

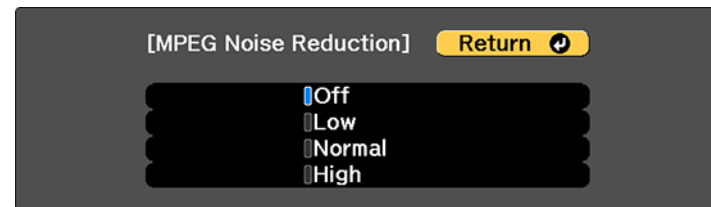

4. Select the level of noise reduction and press **Enter**.
5. Press **Menu** or **Esc** to exit the menus.

Parent topic: [Using Advanced Image Adjustment Features](#)

Adjusting Scaled Resolution Images (Super-resolution)

You can sharpen blurry, low-resolution images that had their resolution scaled up for projection using the **Super-resolution** setting.

1. Turn on the projector and switch to the image source you want to use.
2. Press the **Menu** button.

You see a screen like this:

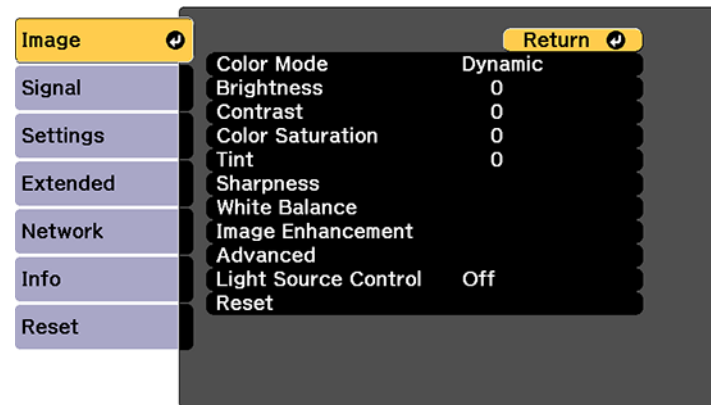

3. Select the **Image Enhancement** setting and press **Enter**.
4. Select the **Super-resolution** setting and press **Enter**.

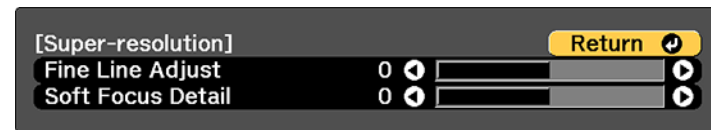

5. Adjust each of the following options as necessary:
 - **Fine Line Adjust** to enhance fine details such as hair and fabric patterns
 - **Soft Focus Detail** to enhance the outline, background, and main parts of an image

Note: Higher values increase the intensity of the effect.

6. Press **Menu** or **Esc** to exit the menus.

Parent topic: [Using Advanced Image Adjustment Features](#)

Adjusting Detail Enhancement

You can enhance the contrast in detailed areas of an image to create a more textured look.

1. Turn on the projector and switch to the image source you want to use.

2. Press the **Menu** button.

You see a screen like this:

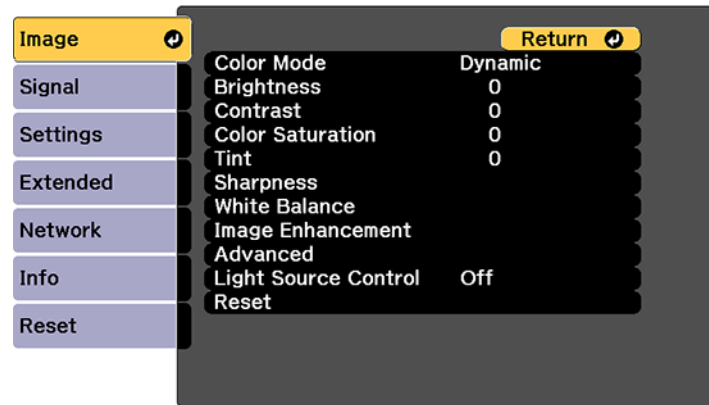

3. Select the **Image Enhancement** setting and press **Enter**.
4. Select the **Detail Enhancement** setting and press **Enter**.
5. Adjust each of the following options as necessary:
 - **Strength** to adjust the image contrast
 - **Range** to adjust the enhanced area of the image

Note: Higher values increase the intensity of the effect. Depending on the image, you may notice a highlight at the border between colors; if so, select lower values.

6. Press **Menu** or **Esc** to exit the menus.

Parent topic: [Using Advanced Image Adjustment Features](#)

Adjusting the Color Convergence (Panel Alignment)

You can use the Panel Alignment feature to manually adjust the color convergence (the alignment of the red and blue colors) in the projected image.

Note: You can adjust only the red or blue color convergence. Green is the standard color panel and cannot be adjusted.

1. Turn on the projector.
2. Press the **Menu** button.
3. Select the **Extended** menu and press **Enter**.
4. Select the **Display** setting and press **Enter**.

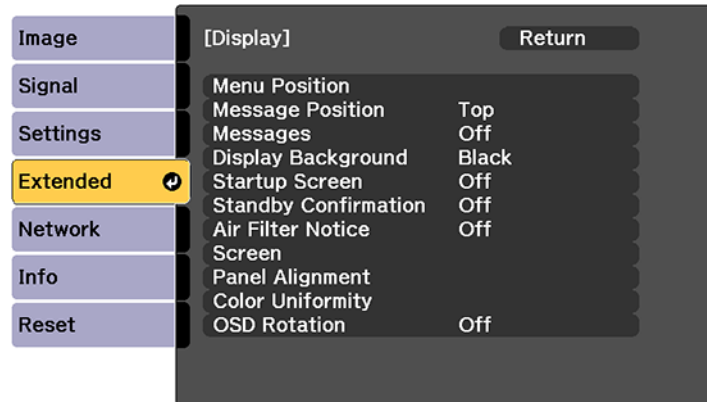

5. Select the **Panel Alignment** setting and press **Enter**.
6. Select the **Panel Alignment** setting again and press **Enter**.
7. Select **On** and press **Enter**.
8. Press **Esc** to return to the previous screen.
9. Select the **Select Color** setting and choose one of the following:
 - **R** to adjust the red color convergence.
 - **B** to adjust the blue color convergence.
10. Press **Esc** to return to the previous screen.
11. Select the **Pattern Color** setting and press **Enter**.
12. Select the pattern you want to use and press **Enter**.
13. Press **Esc** to return to the previous screen.
14. Select **Start Adjustments** and press **Enter**.

You see this screen:

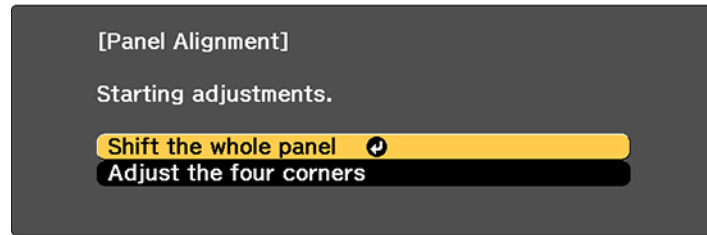

15. First, select **Shift the whole panel** to adjust the entire panel and press **Enter**.
16. Use the arrow buttons on the remote control to adjust the whole panel and press **Enter**.
17. Next, select **Adjust the four corners** to make finer adjustments and press **Enter**.
18. Use the arrow buttons on the remote control to adjust the color alignment of the color you selected for the **Select Color** setting and press **Enter**.
19. When you are finished adjusting each corner of the screen, press **Enter**.
20. Do one of the following:
 - If your projector's panel alignment is now correct, select **Exit** and press **Enter** to return to the Panel Alignment menu.
 - If your projector needs additional panel alignment, select **Select intersection and adjust** and press **Enter** to continue making adjustments.

Parent topic: [Using Advanced Image Adjustment Features](#)

Adjusting the Color Tone (Color Uniformity)

You can use the Color Uniformity feature to manually adjust the color tone balance in the projected image.

1. Press the **Menu** button.

2. Select the **Extended** menu and press **Enter**.

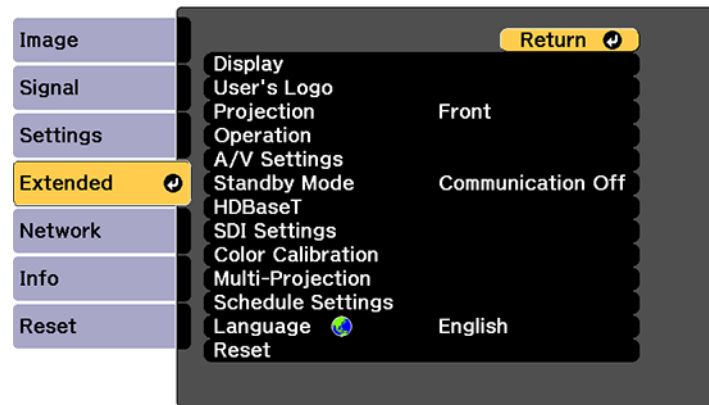

3. Select the **Display** setting and press **Enter**.
4. Select the **Color Uniformity** setting and press **Enter**.

You see this screen:

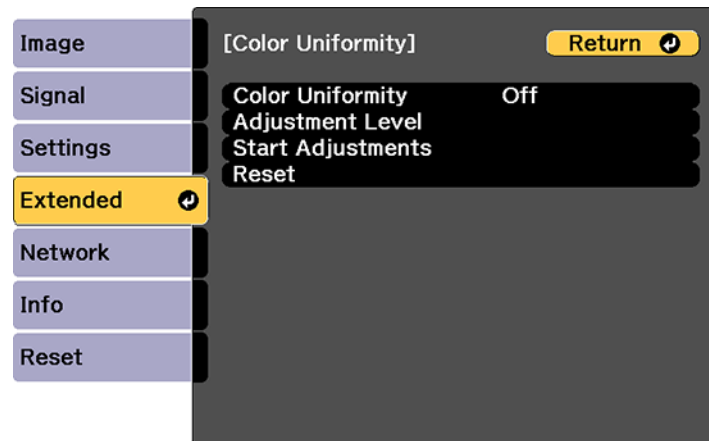

5. Press **Enter** and select **On**.
6. Press **Esc**.

7. Select the **Adjustment Level** setting and press **Enter**.
8. Press the right and left arrow buttons to adjust the level, and press **Esc**.
9. Select the **Start Adjustments** setting and press **Enter**.

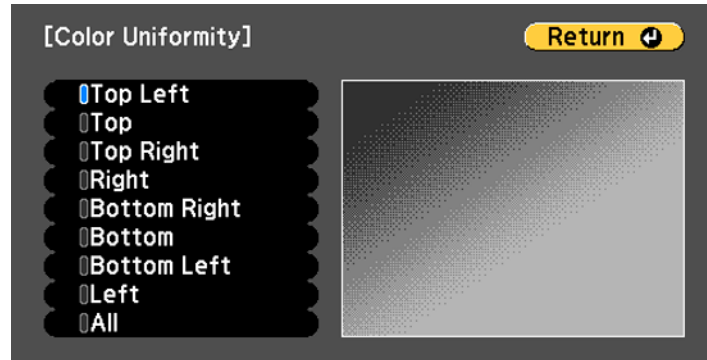

10. Select the area of the screen that you want to adjust and press **Enter**.

Note: Adjust the outer areas first, then adjust the entire screen.

11. Select the color (**Red, Green, or Blue**) you want to adjust, and use the left arrow button to weaken the color tone and the right arrow button to strengthen the color tone.
12. Press **Esc**.
13. Repeat steps 10 and 11 for each area you want to adjust.
14. Repeat steps 7 to 11 for each adjustment level.
15. When you are finished, press the **Menu** button.

Parent topic: [Using Advanced Image Adjustment Features](#)

Running Light Source Calibration

Light source calibration automatically adjusts any difference between the white balance and the brightness level of the light source. You should perform light source calibration every 100 hours of projector usage. You can also schedule automatic calibration or run the light source calibration manually using the menus.

Automatic light source calibration may not start in the following conditions:

- Within 30 minutes of turning on the projector.
- When using the Shutter feature or within 30 minutes of releasing the shutter.
- When using direct power shutdown.
- When you have used the projector continuously for over 24 hours.

Note: To perform a light source calibration, the projector must have been on for at least 30 minutes and the projector brightness must not be automatically dimmed due to high temperatures.

1. Press the **Menu** button.
2. Select the **Reset** menu and press **Enter**.

You see a screen like this:

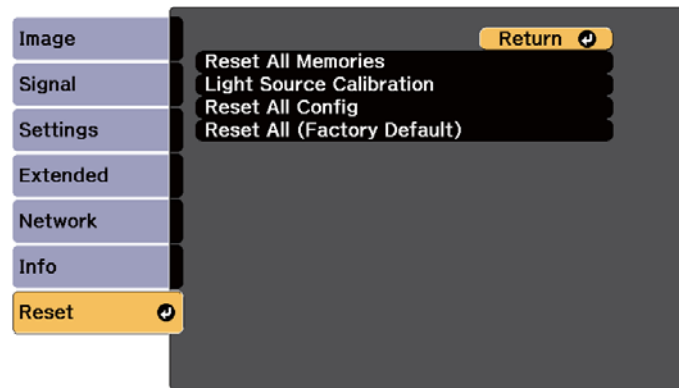

3. Select **Light Source Calibration** and press **Enter**.
4. Select any of the following:
 - To run the light source calibration now, select **Run Now**.
 - To automatically run the light source calibration every 100 hours of projector usage, select **Run Periodically**.
 - To schedule automatic calibration, select **Schedule Settings**.

- **Last Run** displays the last time the projector performed a calibration.

Note: If you use the projector continuously for more than 24 hours or use direct shutdown regularly, select **Schedule Settings** to schedule calibration of the light source periodically.

5. When you are finished, select **Return** and press the **Enter** button to return to the Reset menu.

Parent topic: [Using Advanced Image Adjustment Features](#)

Related tasks

[Turning On the Projector](#)

[Turning Off the Projector](#)

[Stopping Video Action Temporarily](#)

Using Multiple Projectors

You can combine the projected images from two or more projectors to create one large image. Follow the instructions in these sections to set up and project from multiple projectors.

[Multiple Projector Adjustment Overview](#)

[Projector Identification System for Multiple Projector Control](#)

[Tiling Images into One Image](#)

[Blending the Image Edges](#)

[Adjusting the Black Level](#)

[Matching Tint and Brightness \(Screen Matching\)](#)

[Scaling an Image](#)

Parent topic: [Adjusting Projector Features](#)

Multiple Projector Adjustment Overview

If you are combining images from multiple projectors on a network (up to 15), you can assign one projector as the "master" and automatically adjust all the images to match the "master" image. If the projectors are not connected to a network, you can match each projector's images manually.

Note: Make sure all networked projectors are connected using LAN cables, have their **DHCP** setting turned on, and have been assigned an IP address. Also disable Sleep Mode on each projector so they do not turn off during adjustment.

1. Turn on all the projectors.

2. To select a master projector for automatic adjustment, select **Custom** for the **Light Source Mode** setting and set the **Brightness Level** setting to the maximum value for all projectors. The projector with the darkest projected image is the master projector.
3. Do one of the following:
 - For automatic adjustment, set an ID for the master projector and the remote control.
 - For manual adjustment, set an ID for each projector and the remote control.
4. Adjust each projector's physical position and angle to the screen.
5. Do one of the following:
 - For automatic adjustment, configure tiling automatically.
 - For manual adjustment, configure tiling manually.
6. Adjust the image aspect ratio for each projector.
7. Adjust the position of the image for each projector using lens shift.
8. Adjust the zoom and focus for each projector.
9. Adjust small differences in the images using the **Point Correction** setting.
10. Adjust the edges of the images using the **Edge Blending** and **Black Level** settings.
11. Adjust the brightness and tint of the images using the **Screen Matching** setting.
12. Select sections of the images using the **Scale** setting.

Parent topic: [Using Multiple Projectors](#)

Related concepts

[Wired Network Projection](#)

[Projector Identification System for Multiple Projector Control](#)

Related references

[Projector Feature Settings - Settings Menu](#)

Related tasks

[Changing the Image Aspect Ratio](#)

[Adjusting the Image Position Using Lens Shift](#)

[Resizing the Image with the Zoom Button](#)

[Focusing the Image Using the Focus and Distortion Buttons](#)

[Correcting Image Shape with Point Correction](#)

[Blending the Image Edges](#)

[Adjusting the Black Level](#)

[Scaling an Image](#)

Related topics

[Tiling Images into One Image](#)

[Matching Tint and Brightness \(Screen Matching\)](#)

Projector Identification System for Multiple Projector Control

You can operate multiple projectors using one remote control for more elaborate presentations. To do this, you assign an identification number to each projector and to the remote control. Then you can operate all the projectors at once or individually.

[Setting the Projector ID](#)

[Setting the Remote Control ID](#)

Parent topic: [Using Multiple Projectors](#)

Setting the Projector ID

If you want to control multiple projectors from a remote control, give each projector a unique ID.

1. Press the **Menu** button.
2. Select the **Extended** menu and press **Enter**.
3. Select the **Multi-Projection** setting and press **Enter**.
4. Select **Projector ID** and press **Enter**.

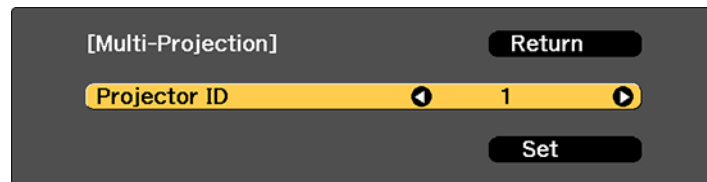

5. Press the left or right arrow buttons on the remote control to select the identification number you want to use for the projector. Then select **Set** and press **Enter**.

Repeat these steps for all the other projectors you want to operate from one remote control.

Note: To temporarily display the projector's ID number on the screen, hold down the **i** button and press the **ID** button.

Parent topic: [Projector Identification System for Multiple Projector Control](#)

Setting the Remote Control ID

The remote control's ID is set to **0** by default so it can operate any compatible projector. If you want to set the remote control to operate only a particular projector, you need to set the remote control's ID to match the projector's ID.

1. Turn on the projector you want the remote control to operate with exclusively.
2. Set the remote control **ID** switch to **On**.

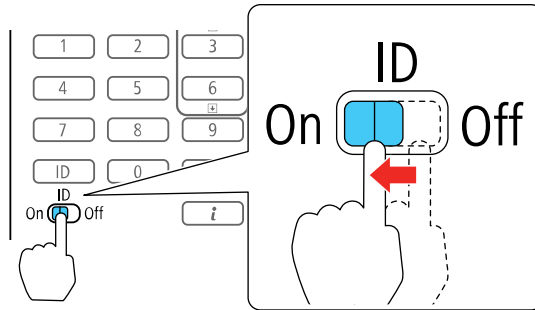

3. Hold down the **ID** button on the remote control while you press the numeric button that matches the projector's ID. (Enter a two-digit number, such as **01** for projector ID 1.) Then release the buttons.

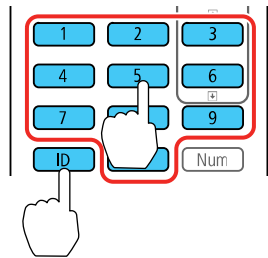

Note: To temporarily display the projector's ID on the screen, press the **i** button and press the **ID** button. If the batteries are left out of the remote control for an extended period, the remote control ID returns to its default setting.

Parent topic: [Projector Identification System for Multiple Projector Control](#)

Related concepts

[Image Shape](#)

Related references

[Additional Projector Software and Manuals](#)

Tiling Images into One Image

You can project the same image from up to nine projectors to create one large image using the Tiling feature.

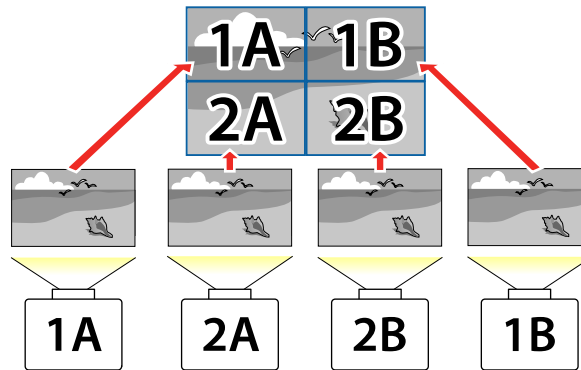

Note: Before tiling, make sure the displayed images from your projectors are rectangular, correctly sized, and focused.

Note: You can automatically adjust the tiling using the Tiling Assist feature in the Epson Projector Professional Tool software available for download from the Epson website.

[Configuring Tiling Automatically](#)

[Configuring Tiling Manually](#)

Parent topic: [Using Multiple Projectors](#)

Configuring Tiling Automatically

If your projectors are on a network and you have identified a master projector, you can configure tiling automatically.

1. Turn on the projector.

Note: Make sure nothing is blocking the built-in camera on the front of the projector.

2. Press the **Menu** button.
3. Select the **Extended** menu and press **Enter**.
4. Select **Multi-Projection** and press **Enter**.

You see this screen:

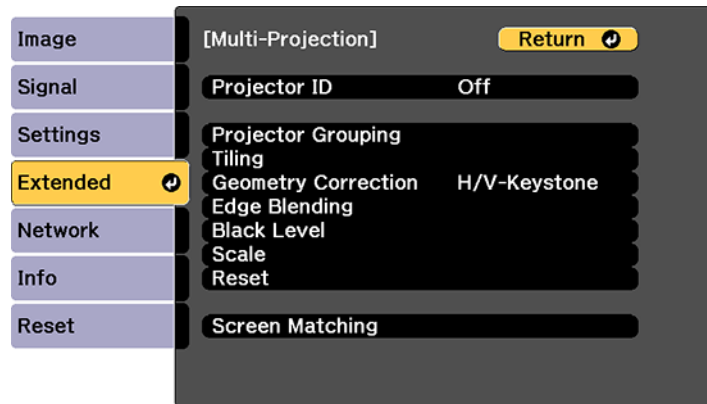

5. Select **Projector Grouping** and press **Enter**.

You see a screen like this:

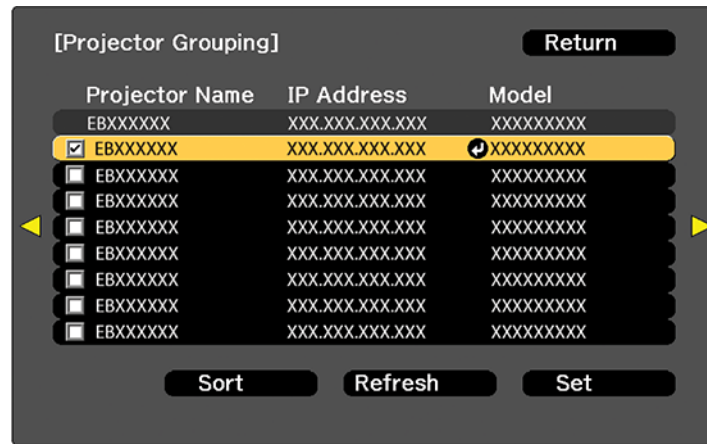

6. Press the up or down arrow buttons to highlight a projector and press **Enter** to place a checkmark next to each projector you want to use for tiling. Then select **Set** and press **Enter**.
7. Select **Tiling** and press **Enter**.
8. Select **Tiling** again and press **Enter**.

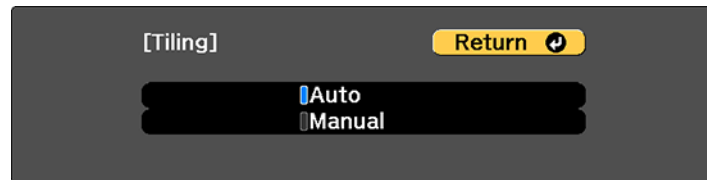

9. Select **Auto** and press **Esc**.
10. Select **Location Setup** and press **Enter**.
The projected images are positioned automatically.
11. When you see the message to assign projector IDs, select **Yes**.

When setup is complete, you see a screen like this:



Note: If any of the images are not positioned correctly, set up tiling manually instead.

12. Select the input signal to display an image.

After performing the steps here, adjust the images for any gaps and differences in color.

Note: Do not change any of the projector names or IP addresses, or the images will not be adjusted automatically.

Parent topic: [Tiling Images into One Image](#)

Related tasks

[Configuring Tiling Manually](#)

Configuring Tiling Manually

If your projectors are not on a network or you were unsuccessful tiling the images automatically, you can configure tiling manually.

1. Turn on the projector.
2. Press the **Menu** button.
3. Select the **Extended** menu and press **Enter**.

4. Select **Multi-Projection > Tiling > Layout**.



5. Select the number of rows and columns you are setting up as the **Row** and **Column** settings. Then select **Set** and press **Enter**.
6. Repeat the previous steps with each projector you are setting up before continuing with the next step.
7. Select **Location Setup** and press **Enter**.



8. Select the position of each projected image as follows:
 - **Row Order** to layout the screens from top to bottom in sequential order, starting with **1** at the top

- **Column Order** to layout the screens from left to right, starting with **A** on the left

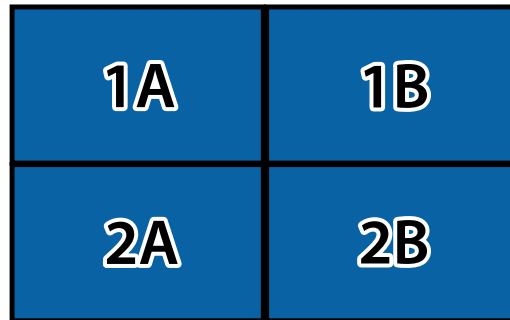

9. Repeat the previous step with each projector you are setting up before continuing with the next step.
10. Select the input signal to display an image.

After performing the steps here, adjust the images for any gaps and differences in color.

Parent topic: [Tiling Images into One Image](#)

Related tasks

[Configuring Tiling Automatically](#)

Blending the Image Edges

You can use the projector's Edge Blending feature to create a seamless image from multiple projectors.

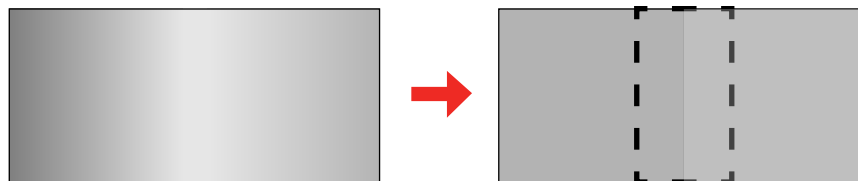

Note: Before performing Edge Blending, set the **Color Mode** setting to **Multi-Projection** to make more precise adjustments.

1. Press the **Menu** button.
2. Select the **Extended** menu and press **Enter**.

3. Select the **Multi-Projection** setting and press **Enter**.
4. Select the **Edge Blending** setting and press **Enter**.

You see this screen:

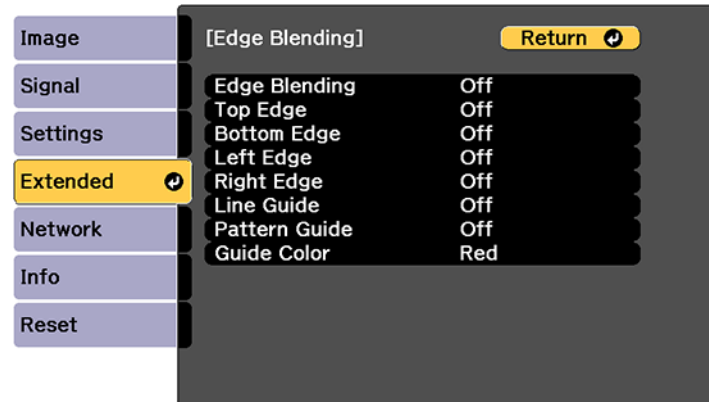

5. Turn on the **Edge Blending**, **Line Guide**, and **Pattern Guide** settings.

Note: If the projected guide is unclear, try changing the **Guide Color** setting.

6. Select the edge you want to blend on each projector and press **Enter**.

You see a screen like this:

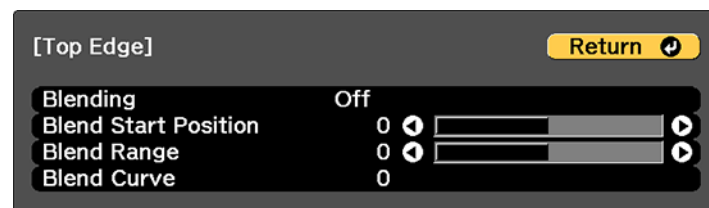

7. Select the **Blending** setting and select **On**.
8. Press **Esc** to return to the previous screen.
9. Select the **Blend Start Position** setting and adjust the point where edge blending begins.

10. Select the **Blend Range** setting and use the arrow buttons to select the width of the blended area so that the displayed guides are at the edges of the overlapping area between the two images.
11. Select the **Blend Curve** setting and select a gradient for the shaded area on the projectors.
12. Press **Esc** to go back to the previous screen.
13. When the edges are blended, turn off the **Line Guide** and **Pattern Guide** settings on each projector to check the final settings.
14. When you are finished, press the **Menu** button.

Parent topic: [Using Multiple Projectors](#)

Related tasks

[Changing the Color Mode](#)

Adjusting the Black Level

When two images overlap, the overlapping area can appear differently from the areas that do not overlap. You can use the projector's Black Level setting to make the difference less noticeable.

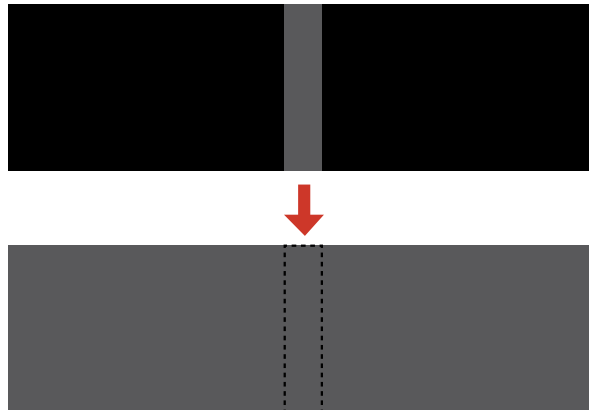

Note: You may not be able to adjust the black levels correctly if the **Geometry Correction** settings are set too high. The brightness and tone of the overlapping areas may differ from the rest of the image even after adjusting the black level.

1. Press the **Menu** button.
2. Select the **Extended** menu and press **Enter**.

3. Select the **Multi-Projection** setting and press **Enter**.
4. Select the **Black Level** setting and press **Enter**.

You see this screen:

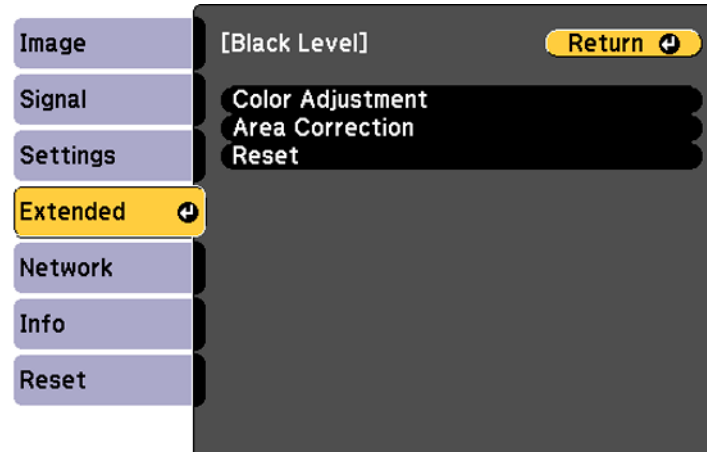

5. Select the **Color Adjustment** setting and press **Enter**.

You see a screen based on the **Top Edge**, **Bottom Edge**, **Right Edge**, and **Left Edge** settings you selected for the **Edge Blending** setting.

Note: The **Color Adjustment** setting is automatically adjusted when selecting **Start Auto Adjustment** in the Screen Matching screen.

6. Select the area you want to adjust and press **Enter**.

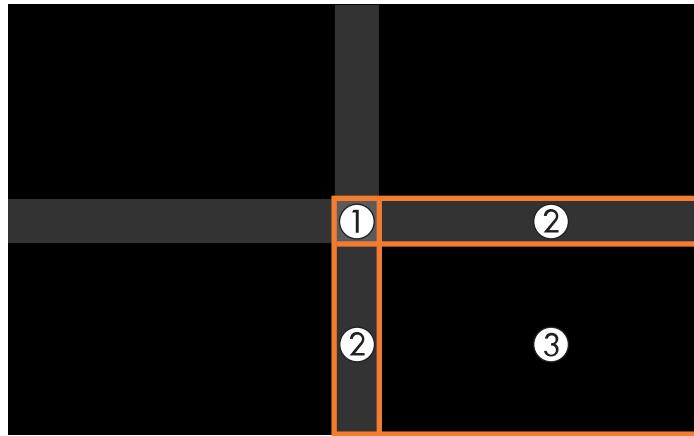

Note: The area you selected is displayed in orange. Adjust overlapping areas starting with the brightest areas first. For example, adjust area 2 to match area 1, then adjust area 3 to match area 2.

7. Adjust the brightness and tone of the areas that do not overlap to match the areas that overlap using the displayed adjustment sliders.



8. Repeat the previous two steps as needed until all areas match.
9. If the tone of some areas do not match, you can adjust them using the **Area Correction** setting. Continue with the next step. Otherwise, press the **Menu** button to exit.
10. Press the **Esc** button to return to the Black Level screen.
11. Select the **Area Correction** setting and press **Enter**.
12. Select the **Start Adjustments** setting and press **Enter**.

You see a screen with boundary lines indicating areas that are overlapping. The boundary lines are based on the **Top Edge**, **Bottom Edge**, **Right Edge**, and **Left Edge** settings you selected for the **Edge Blending** setting.

13. Use the arrow buttons to select a boundary line of the area you want to adjust and press **Enter**.
The selected line is displayed in orange.



14. Use the arrow buttons to adjust the boundary line position and press the **Enter** button.
15. Use the arrow buttons to select an adjustment point and press the **Enter** button.
The selected point turns orange.

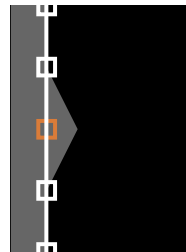

16. Use the arrow buttons to move the point.

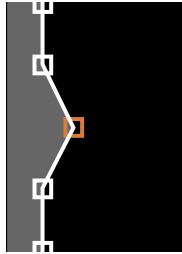

17. To move another point, press the **Esc** button and repeat the previous two steps.

18. To move another boundary line, press the **Esc** button repeatedly until you can select a boundary line.

19. When you are finished, press the **Esc** button until you see a confirmation message. Select **Yes** and press **Enter** to return to the Black Level screen.

20. When you are finished, press the **Menu** button.

Note: Changing the **Top Edge**, **Bottom Edge**, **Right Edge**, or **Left Edge** settings resets the **Black Level** setting to its default value.

Parent topic: [Using Multiple Projectors](#)

Related references

[Projector Feature Settings - Settings Menu](#)

Related topics

[Matching Tint and Brightness \(Screen Matching\)](#)

Matching Tint and Brightness (Screen Matching)

You can adjust the tint and brightness of multiple projectors so they match better. You can also schedule automatic adjustments to the tint and brightness.

Note: Wait 30 minutes after turning on the projector before using the Screen Matching feature and darken the room for maximum accuracy. Brightness decreases over time, so you may need to perform Screen Matching again to correct large differences in brightness.

[Matching the Screens Automatically](#)

[Matching the Screens Manually](#)

Parent topic: [Using Multiple Projectors](#)

Related tasks

[Saving a Scheduled Event](#)

Matching the Screens Automatically

You can automatically correct the brightness and tint for multiple projectors based on the brightness and tint settings you selected for the master projector.

Before you start, make sure of the following:

- Select **Multi-Projection** for the **Color Mode** setting and adjust the **Brightness, Contrast, Color Saturation, Tint, White Balance**, and **Advanced** settings in the Image menu, as necessary, on the master projector.
- You are projecting on a matte white diffusion screen that is flat and even.
- The projected image is between 100 to 300 inches (254 to 762 cm) and is rectangular after tiling.
- All the projectors are connected to a network and the **Location Setup** setting has been configured.
- Nothing is blocking the built-in camera on the front of each projector.
- The projected images do not overlap or have gaps between them.
- The projectors are installed parallel to the screen.
- The Blend Range setting is set between 15 to 45%.
- All the projectors are the same model.

Note: Auto adjustment is not available for the following lenses: ELPLX02, ELPLX02W, ELPLU04, or ELPLL08. After auto adjustment, the movement range for lens shift is reduced.

1. Press the **Menu** button.
2. Select the **Extended** menu and press **Enter**.
3. Select the **Multi-Projection** setting and press **Enter**.

4. Select the **Screen Matching** setting and press **Enter**.

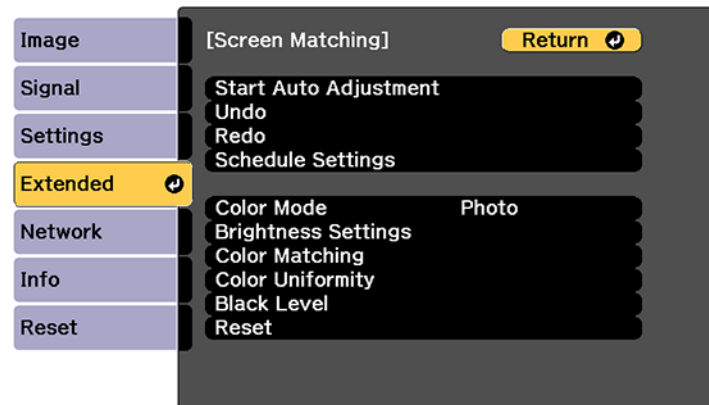

5. Select **Start Auto Adjustment** press **Enter**.

Select **Yes** when a message appears. When adjustment starts, you see an adjustment pattern. Adjustment is complete when you see a displayed image.

After automatic adjustment, the **Color Uniformity** and **Color Matching** settings are returned to their default values, and the **Light Source Control** setting is turned off. You may have to adjust the **Blend Curve** setting manually if it was not set correctly during automatic adjustment.

Parent topic: [Matching Tint and Brightness \(Screen Matching\)](#)

Related references

[Image Quality Settings - Image Menu](#)

[Projector Parts - Front/Top](#)

Related tasks

[Changing the Color Mode](#)

[Configuring Tiling Automatically](#)

[Blending the Image Edges](#)

Matching the Screens Manually

You can manually correct the brightness and tint for multiple projectors.

1. Press the **Menu** button.
2. Select the **Extended** menu and press **Enter**.

3. Select the **Multi-Projection** setting and press **Enter**.
4. Select the **Screen Matching** setting and press **Enter**.
5. Select the **Color Matching** setting and press **Enter**.

You see this screen:

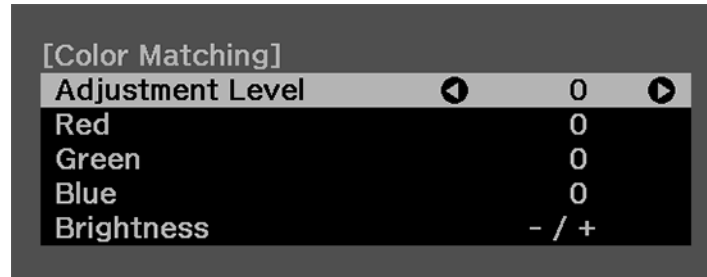

6. Press the left or right arrow buttons to select a value for the **Adjustment Level** setting.

Note: There are eight adjustment levels ranging from white to black and you can adjust each level individually.

7. Press the left or right arrow buttons to adjust the color tone for the **Red**, **Green**, and **Blue** settings.
8. Press the left or right arrow buttons to adjust the **Brightness** setting.
9. Repeat the previous three steps as necessary to adjust each adjustment level.
10. Press the **Esc** button to return to the previous screen.

Parent topic: [Matching Tint and Brightness \(Screen Matching\)](#)

Scaling an Image

You can project the same image from multiple projectors and use the Scale feature to crop and combine them into one large image.

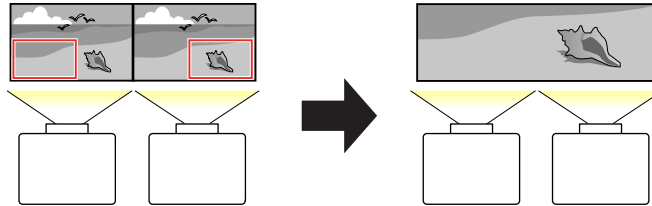

1. Press the **Menu** button.
2. Select the **Extended** menu and press **Enter**.
3. Select the **Multi-Projection** setting and press **Enter**.
4. Select the **Scale** setting and press **Enter**.

You see this screen:

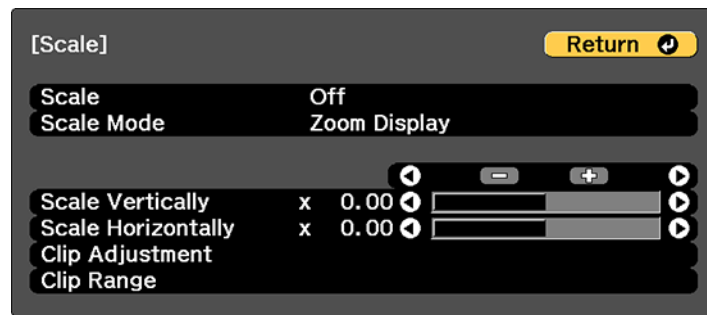

5. Select one of the following as the **Scale** setting:
 - **Auto** to automatically adjust the clipped areas according to the **Edge Blending** and **Tiling** settings you selected
 - **Manual** to adjust the clipped areas manually
6. Select the **Scale Mode** setting and select one of these options:
 - **Zoom Display** to maintain the image aspect ratio as you scale the image

- **Full Display** to adjust the image to the projector's screen size as you scale the image
7. If you selected **Auto** as the Scale setting, you can skip the remaining steps. If you selected **Manual**, adjust each of the following options as necessary:

- Select **-** or **+** to scale the image horizontally and vertically at the same time

Note: You can set a value between 0.5 and 10.

- Select **Scale Vertically** to scale the image vertically only
 - Select **Scale Horizontally** to scale the image horizontally only
8. Select the **Clip Adjustment** setting and use the arrow buttons to adjust the coordinates and size of each image as you view the screen.
 9. Select the **Clip Range** setting to preview the area you just selected.
 10. Press the **Menu** button to exit.

Parent topic: [Using Multiple Projectors](#)

Related tasks

[Blending the Image Edges](#)

Related topics

[Tiling Images into One Image](#)

Enabling Protocol Emulation

You can use protocol emulation to control your projector with the same RS-232 control codes as those used by the manufacturers of other projectors. This lets you control a group of projectors from a common controller.

1. Make sure the projector is turned on.
2. Connect a controller to the RS-232C port on the projector.
3. Do one of the following:
 - Press and hold the **Test Pattern** button on the remote control for at least five seconds.
 - Select the **Extended** menu, highlight the **Standby Mode** setting, and hold down the right arrow button on the remote control or projector control panel for at least five seconds.

You see the Protocol Emulation screen.

4. Select one of the following and press **Enter**:
 - **Type P** for Panasonic projectors
 - **Type M** for Mitsubishi projectors
 - **Type N** for NEC projectors
 - **Type S** for Sony projectors
 - **Type SA** for Sanyo projectors
5. Turn the projector off and on again to enable the protocol emulation you selected.

Parent topic: [Adjusting Projector Features](#)

Related references

[Projector Parts - Interface Ports](#)

[Projector Setup Settings - Extended Menu](#)

Saving Settings to Memory and Using Saved Settings

You can save customized settings and then select the saved settings whenever you want to use them.

1. Turn on the projector and display an image.
2. Press the **Menu** button.
3. Select the **Settings** menu and press **Enter**.

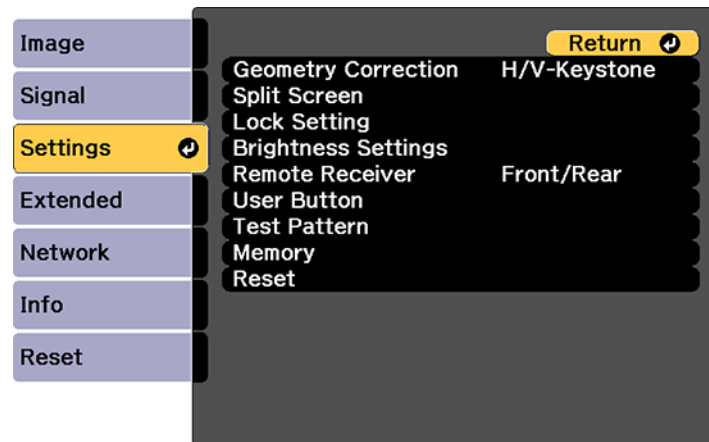

4. Select the **Memory** setting and press **Enter**.

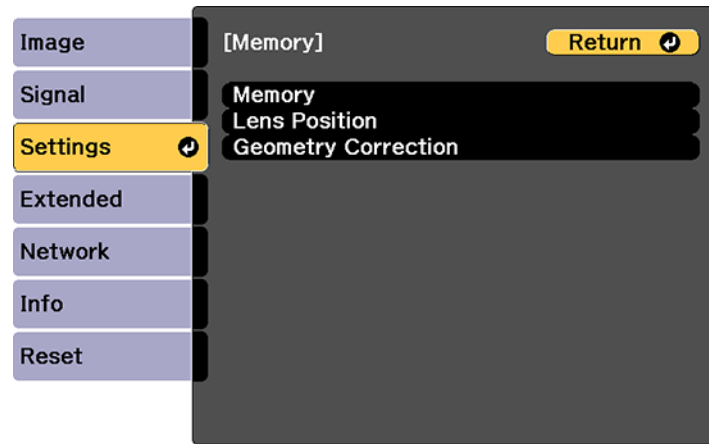

Note: You can also access this screen by pressing the **Memory** button on the remote control.

5. Select one of the following options:

- **Memory:** Saves or loads various settings; you can save up to 10 different memories

Note: The following settings are saved: all settings from the Image menu, the **Scale**, **Overscan**, and **Video Range** settings from the Signal menu, and the **Edge Blending**, **Black Level**, and **Color Matching** settings from the Extended menu.

- **Lens Position:** Saves or loads settings related to the lens such as the lens shift, focus, zoom, and distortion adjustment settings; you can save up to 10 different memories
- **Geometry Correction:** Saves or loads any adjustments made in the **Geometry Correction** setting in the Settings menu; you can save up to 3 different memories

You see this screen:

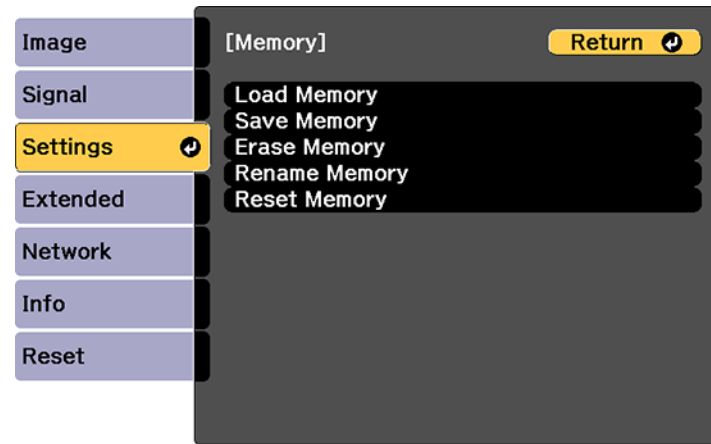

6. Select one of the following options:

- **Load Memory:** Overwrites your current settings with saved settings
- **Save Memory:** Saves your current settings to memory

Note: A memory name that has already been used is indicated by a blue mark. Saving over a previously saved memory overwrites the settings with your current settings.

- **Erase Memory:** Erases the selected memory settings
- **Rename Memory:** Renames a saved memory
- **Reset Memory:** Resets the name and settings of a saved memory

Note: To reset all saved memories of all types, select **Reset All Memories** in the Reset menu.

7. Press **Menu** or **Esc** to exit.

Parent topic: [Adjusting Projector Features](#)

Saving a Scheduled Event

You can select projector commands you want to perform and schedule them as an event.

You cannot schedule an event to occur at the following times:

- Five minutes before or after a Color Calibration event
- Five minutes before or 30 minutes after a Screen Matching event

Note: Make sure to perform Screen Matching after executing Light Source Calibration.

Note: When you have set Light Source Calibration or Screen Matching events and you want to apply this schedule to other projectors with tiling settings, set **Sync Schedule** to **On**.

1. Press the **Menu** button.
2. Select the **Extended** menu and press **Enter**.
3. Select the **Schedule Settings** setting and press **Enter**.

You see a screen like this:

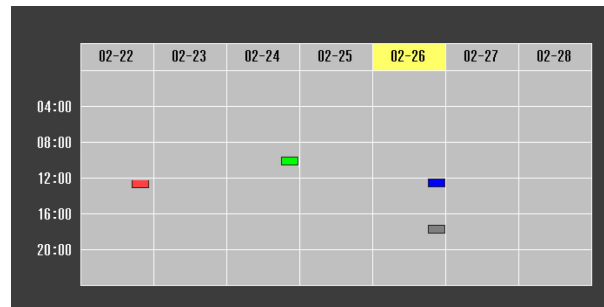

4. Select the **Schedule** or **Extended Schedule** menu and press **Enter**.
5. Select **Add New** and press **Enter**.
6. In the Event Settings section, select the events you want to have occur. (Select **No Change** or **Off** for events that you do not want to occur.)

Note: In the **Extended Schedule** menu, you can schedule only one event for Color Calibration or Screen Matching.

7. In the Date/Time Settings section, set the date and time for the scheduled events to occur.
8. When you are finished, select **Save** and press **Enter**.

- To schedule more events, repeat the previous steps as necessary.
- Select **Setup complete** and select **Yes** to save your changes.

[Viewing Scheduled Events](#)

[Editing a Scheduled Event](#)

Parent topic: [Adjusting Projector Features](#)

Related tasks

[Running Light Source Calibration](#)

Related topics

[Matching Tint and Brightness \(Screen Matching\)](#)

Viewing Scheduled Events

You can view any currently scheduled events.

- Press the **Menu** button.
- Select the **Extended** menu and press **Enter**.
- Select the **Schedule Settings** setting and press **Enter**.

You see a screen like this:

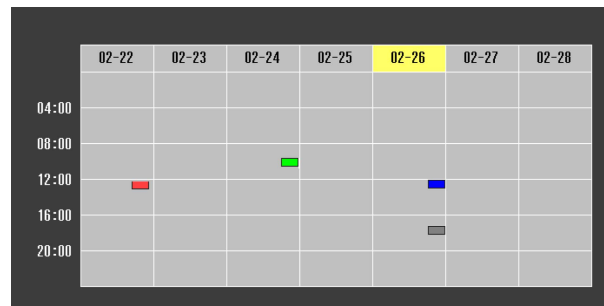

The colored boxes in the calendar indicate the following about the scheduled events:

- One-time event
- Recurring event
- Communication is on/off

■ Event is invalid

Parent topic: [Saving a Scheduled Event](#)

Editing a Scheduled Event

You can edit any currently scheduled event.

1. Press the **Menu** button.
2. Select the **Extended** menu and press **Enter**.
3. Select the **Schedule Settings** setting and press **Enter**.

You see a screen like this:

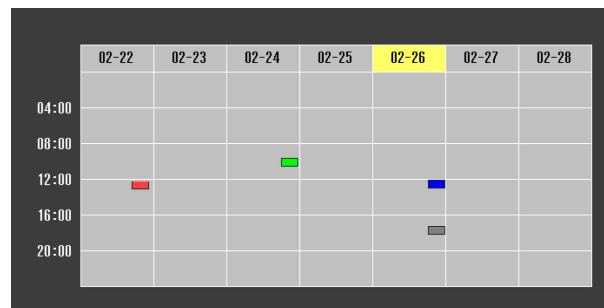

4. Press the left or right arrow buttons to highlight the date on the calendar containing the scheduled event you want to edit.
5. Press the up or down arrow buttons to highlight the event you want to edit, and press **Esc**.
6. Select one of the following:
 - **On/Off** to enable or disable the selected event.
 - **Edit** to edit the settings for the selected event.
 - **Clear** to delete the selected event.
 - **Add New** to add a new scheduled event.
7. When you are finished, select **Return** and press **Enter**.

8. Select **Setup complete** and select **Yes** to save your changes.

Note: To delete all scheduled events, select **Schedule Reset** and select **Yes**.

Parent topic: [Saving a Scheduled Event](#)

Copying Menu Settings Between Projectors

After you select menu settings for your projector, you can transfer them to another projector of the same model.

Note: Copy the projector's settings before you adjust the projected image using the projector's Geometry Correction settings. Any saved User's Logo setting on the projector will transfer to the other projector.

Caution: If the copy process fails due to a power failure, communication error, or for any other reason, Epson will not be responsible for any repair costs incurred.

The following settings will not transfer between projectors:

- Network menu settings other than those in the Notifications and Others menus (when the **Batch Setup Range** setting is set to **Limited**)
- EDID settings in the Signal menu (when the **Batch Setup Range** setting is set to **Limited**)
- Light Source Info in the Info menu
- Status Information in the Info menu
- Password-protected items

Note: In addition to the methods covered in this section, you can also copy and transfer settings to multiple projectors over a network using the Epson Projector Management software. See the online *Epson Projector Management Operation Guide* for instructions. You can download the latest software and documentation from the Epson website.

[Saving Settings to a USB Flash Drive](#)

[Transferring Settings from a USB Flash Drive](#)

[Saving Settings to a Computer](#)

[Transferring Settings from a Computer](#)

Parent topic: [Adjusting Projector Features](#)

Related concepts

[Password Security Types](#)

Related references

[Projector Feature Settings - Settings Menu](#)

[Projector Network and Camera Settings - Network Menu](#)

[Input Signal Settings - Signal Menu](#)

[Projector Information Display - Info Menu](#)

[Additional Projector Software and Manuals](#)

Saving Settings to a USB Flash Drive

You can save the projector settings you want to transfer to a USB flash drive.

Note: Use an empty flash drive. If the drive contains other files, the transfer may not complete correctly. The flash drive must use the FAT format and cannot have any security features.

1. Turn off the projector using the power switch.
2. Insert the flash drive into the **USB-A** port.

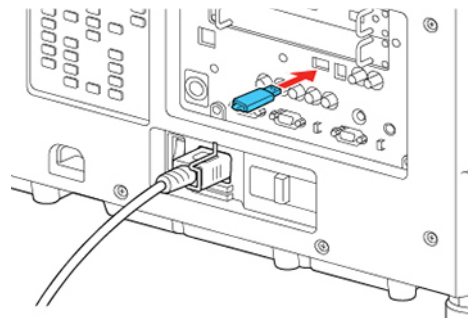

Note: Connect the flash drive directly to the projector. Do not use a hub or your settings may not be saved correctly.

3. Press and hold the **Esc** button on the control panel or remote control as you turn on the power switch.

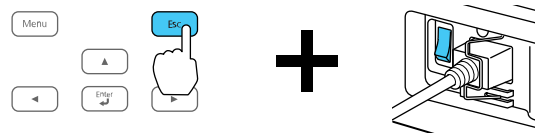

4. When the On/Standby and Status lights are blue, and the Laser and Temp lights are orange, release the **Esc** button.

The lights flash to indicate that settings are transferring to the flash drive. When the lights stop flashing, the On/Standby light turns blue and the projector enters standby mode.

Caution: Do not unplug the power cord, turn off the power switch, or remove the flash drive while the lights are flashing. This could damage the projector.

5. Once the projector enters standby mode, remove the flash drive.

Note: If the projector does not enter standby mode and the lights continue flashing, see the link below for a solution.

Parent topic: [Copying Menu Settings Between Projectors](#)

Related references

[Projector Light Status](#)

Transferring Settings from a USB Flash Drive

After saving projector settings to a USB flash drive, you can transfer them to another projector of the same model.

Note: Make sure the USB flash drive contains only a single settings transfer from another projector of the same model. The settings are contained in a file called **pjconfdata.bin**. If the drive contains other files, the transfer may not complete correctly.

Do not adjust image settings on a projector until after you transfer settings to it. Otherwise, you may have to repeat your adjustments.

1. Turn off the projector using the power switch.

2. Insert the flash drive into the **USB-A** port.

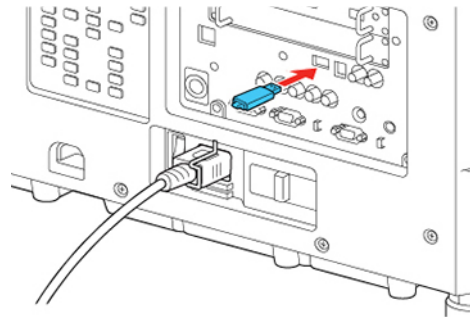

Note: Connect the flash drive directly to the projector. Do not use a hub or your settings may not be saved correctly.

3. Press and hold the **Menu** button on the control panel or remote control as you turn on the power switch.

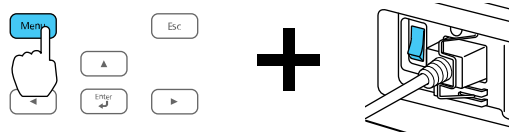

4. When the On/Standby and Status lights are blue, and the Laser and Temp lights are orange, release the **Menu** button.

The lights flash to indicate that settings are transferring to the projector. When the lights stop flashing, the On/Standby light turns blue and the projector enters standby mode.

Caution: Do not unplug the power cord, turn off the power switch, or remove the flash drive while the lights are flashing. This could damage the projector.

5. Once the projector enters standby mode, remove the flash drive.

Note: If the projector does not enter standby mode and the lights continue flashing, see the link below for a solution.

Parent topic: [Copying Menu Settings Between Projectors](#)

Related references

[Projector Light Status](#)

Saving Settings to a Computer

You can save the projector settings you want to transfer to a computer.

Your computer must be running one of the following operating systems:

- Windows Vista
- Windows 7
- Windows 8.x
- Windows 10
- OS X 10.7.x
- OS X 10.8.x
- OS X 10.9.x
- OS X 10.10.x
- OS X 10.11.x
- macOS 10.12.x
- macOS 10.13.x
- macOS 10.14.x

1. Turn off the projector using the power switch.
2. Connect a USB cable to your projector's **Service** port.

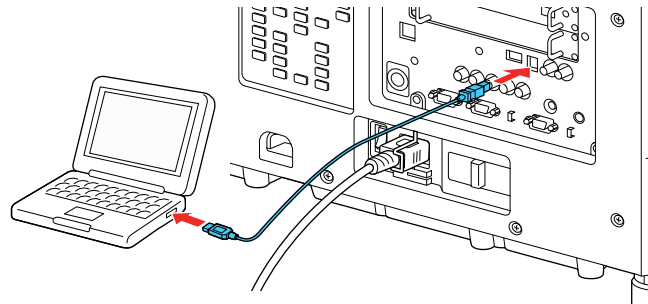

3. Connect the other end to any available USB port on your computer.
4. Press and hold the **Esc** button on the control panel or remote control as you turn on the power switch.

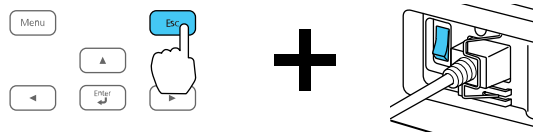

5. When the On/Standby and Status lights are blue, and the Laser and Temp lights are orange, release the **Esc** button.

The projector shows up as a removable disk on your computer.

6. Open the removable disk and copy the **pjconfdata.bin** file to your computer.
7. Once the file has copied, do one of the following:
 - **Windows:** Open the **My Computer**, **Computer**, **Windows Explorer**, or **File Explorer** utility. Right-click the name of your projector (listed as a removable disk) and select **Eject**.
 - **Mac:** Drag the removable disk icon for your projector from the desktop into the trash.

The projector enters standby mode.

Note: If the projector does not enter standby mode and the lights continue flashing, see the link below for a solution.

Parent topic: [Copying Menu Settings Between Projectors](#)

Related references

[Projector Light Status](#)

Transferring Settings from a Computer

After saving projector settings to a computer, you can transfer them to another projector of the same model.

Your computer must be running one of the following operating systems:

- Windows Vista
- Windows 7
- Windows 8.x

- Windows 10
- OS X 10.7.x
- OS X 10.8.x
- OS X 10.9.x
- OS X 10.10.x
- OS X 10.11.x
- macOS 10.12.x
- macOS 10.13.x
- macOS 10.14.x

Do not adjust image settings on a projector until after you transfer settings to it. Otherwise, you may have to repeat your adjustments.

1. Turn off the projector using the power switch.
2. Connect a USB cable to your projector's **Service** port.

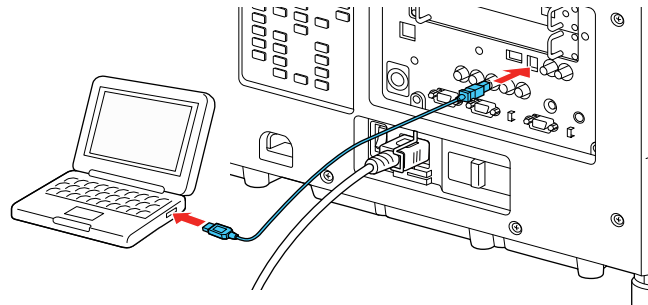

3. Connect the other end to any available USB port on your computer.
4. Press and hold the **Menu** button on the control panel or remote control as you turn on the power switch.

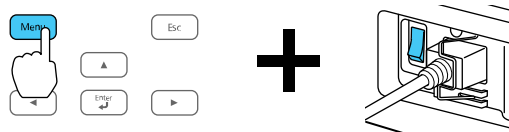

5. When the On/Standby and Status lights are blue, and the Laser and Temp lights are orange, release the **Menu** button.

The projector shows up as a removable disk on your computer.

6. Copy the **pjconfdata.bin** file from your computer to the removable disk.

Note: Do not copy any other files to the removable disk.

7. Once the file has copied, do one of the following:

- **Windows:** Open the **My Computer**, **Computer**, **Windows Explorer**, or **File Explorer** utility. Right-click the name of your projector (listed as a removable disk) and select **Eject**.
- **Mac:** Drag the removable disk icon for your projector from the desktop into the trash.

All the lights start flashing to indicate that the projector's settings are being updated. When the lights stop flashing, the On/Standby light turns blue and the projector enters standby mode.

Caution: Do not turn off the power switch or unplug the power cord while the lights are flashing. This could damage the projector.

Note: If the projector does not enter standby mode and the lights continue flashing, see the link below for a solution.

Parent topic: [Copying Menu Settings Between Projectors](#)

Related references

[Projector Light Status](#)

Adjusting the Menu Settings

Follow the instructions in these sections to access the projector menu system and change projector settings.

[Using the Projector's Menus](#)

[Image Quality Settings - Image Menu](#)

[Input Signal Settings - Signal Menu](#)

[Projector Feature Settings - Settings Menu](#)

[Projector Setup Settings - Extended Menu](#)

[Projector Network and Camera Settings - Network Menu](#)

[Projector Information Display - Info Menu](#)

[Projector Reset Options - Reset Menu](#)

Using the Projector's Menus

You can use the projector's menus to adjust the settings that control how your projector works. The projector displays the menus on the screen.

1. Press the **Menu** button on the control panel or remote control.

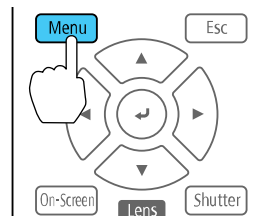

You see the menu screen displaying the Image menu settings.

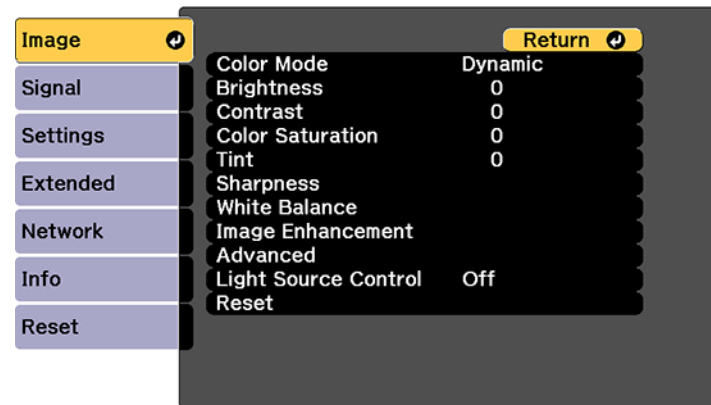

2. Press the up or down arrow button to move through the menus listed on the left. The settings for each menu are displayed on the right.

Note: The available settings depend on the current input source, resolution, or other menu settings.

3. To change settings in the displayed menu, press **Enter**.
4. Press the up or down arrow button to move through the settings.
5. Change the settings using the buttons listed on the bottom of the menu screens.
6. To return all the menu settings to their default values, select **Reset**.
7. When you finish changing settings on a menu, press **Esc**.
8. Press **Menu** or **Esc** to exit the menus.

Parent topic: [Adjusting the Menu Settings](#)

Image Quality Settings - Image Menu

Settings on the Image menu let you adjust the quality of your image for the input source you are currently using. The available settings depend on the currently selected input source.

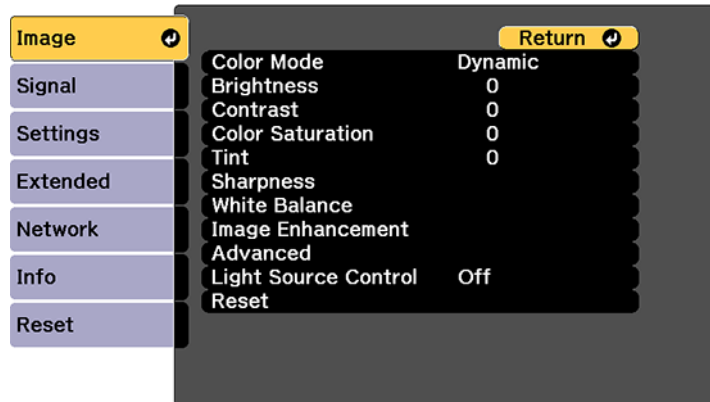

To change settings for an input source, make sure the source is connected and select that source.

Setting	Options	Description
Color Mode	See the list of available Color Modes	Adjusts the vividness of image colors for various image types and environments
Brightness	Varying levels available	Lightens or darkens the overall image
Contrast	Varying levels available	Adjusts the difference between light and dark areas of the image
Color Saturation	Varying levels available	Adjusts the intensity of the image colors
Tint	Varying levels available	Adjusts the balance of green to magenta tones in the image

Setting	Options	Description
Sharpness	Standard Thin Line Enhancement Thick Line Enhancement	Adjusts the sharpness of image details Standard: adjusts the overall image sharpness Thin Line Enhancement: enhances fine details such as hair and fabric patterns Thick Line Enhancement: enhances the outline, background, and main parts of an image to make them more clear
White Balance	Color Temp. G-M Correction Customized	Adjusts the overall tint of the image Color Temp.: sets the color tone based on color temperature G-M Correction: higher values tint the image blue and lower values tint the image red Customized: lets you adjust the offset and gain of each color R (red), G (green), and B (blue) individually

Setting	Options	Description
Image Enhancement	Image Preset Mode	Selects the image enhancement settings saved in advance
	Frame Interpolation	Smooths fast moving video by comparing consecutive frames and inserting an intermediate frame between them
	Deinterlacing	Sets whether to convert interlaced-to-progressive signals for certain video image types Off: for fast-moving video images Video: for most video images Film/Auto: for movies, computer graphics, and animation
	Noise Reduction	Reduces flickering in analog images
	MPEG Noise Reduction	Reduces the noise or artifacts seen in MPEG video
	Super resolution	Sharpens blurred images resulting from increasing resolution
	Detail enhancement	Enhances details to create clear outlines Range: higher settings increase the affected area around the outline Strength: higher settings create a stronger effect
Advanced	Gamma	Adjusts the gamma levels of the image. Select Customized to adjust the gamma while viewing the image or a graph.
	RGBCMY	Adjusts the hue, saturation, and brightness for each color

Setting	Options	Description
Dynamic Contrast	Off Response Speed Black Level	Adjusts the luminance of the image to improve contrast by tracking changes in image brightness Response Speed: select either Normal to adjust brightness at the standard speed or High Speed to adjust brightness as soon as the scene changes Black Level: select the black level you want to project when the brightness level of the image signal is zero; if you select 0%, the light source turns off
Light Source Control	Dynamic Contrast	Automatically adjusts the amount of light according to the brightness of the image.
	Lights-Out Control	Automatically turns off the light after a certain time has elapsed while projecting at the specified video level. Lights-Out Signal Level: select the brightness level for the current video signal Lights-Out Timer: select the amount of time before the light source automatically turns off

Note: The **Brightness** setting does not affect laser brightness. To change the laser brightness, use the **Brightness Settings** in the Settings menu.

Parent topic: [Adjusting the Menu Settings](#)

Related concepts

[Using Advanced Image Adjustment Features](#)

Related references

[Available Color Modes](#)

[Projector Feature Settings - Settings Menu](#)

Related tasks

[Adjusting Luminance Controls](#)

Input Signal Settings - Signal Menu

Normally the projector detects and optimizes the input signal settings automatically. If you need to customize the settings, you can use the Signal menu. The available settings depend on the currently selected input source.

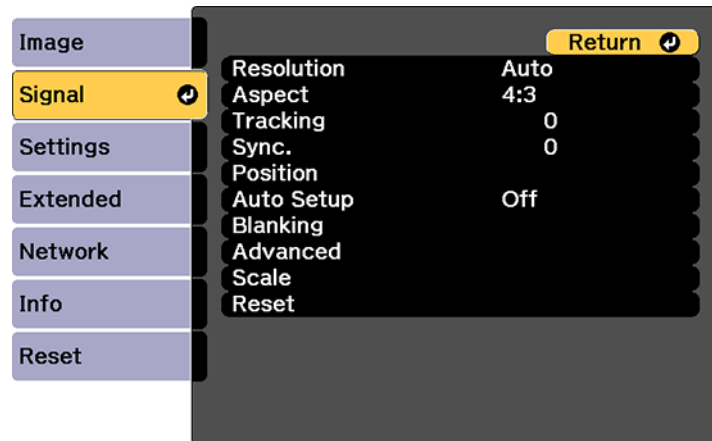

Note: You can restore the default settings of the **Position**, **Tracking**, and **Sync** settings by pressing the **Auto** button on the remote control.

To change settings for an input source, make sure the source is connected and select that source.

Setting	Options	Description
Resolution	Auto Normal Wide Manual	Sets the input signal resolution from an analog RGB computer connection Auto: detects the resolution automatically Normal: for 4:3 or 5:4 screens Wide: for widescreen Manual: lets you specify a resolution
Aspect	See the list of available aspect ratios	Sets the aspect ratio (width-to-height ratio) for the selected input source
Tracking	Varying levels available	Adjusts signal to eliminate vertical stripes in images from an analog RGB computer connection
Sync.	Varying levels available	Adjusts signal to eliminate fuzziness or flickering in images from an analog RGB computer connection
Position	Up, down, left, right	Adjusts the image location on the screen
Auto Setup	On Off	Automatically optimizes image quality from an analog RGB computer connection (when On)
Overscan	Auto Off 4% 8%	Changes the projected image ratio to make the edges visible by a selectable percentage or automatically

Setting	Options	Description
Blanking	Top Bottom Left Right	Hides an area of the projected image that you select using the arrow buttons
Color Space	Auto BT.709 BT.2020	<p>Sets the conversion system for the color space</p> <p>Selecting the incorrect color space for the input source may adversely affect the image colors; the recommended setting in most cases is Auto.</p>
Dynamic Range	Dynamic Range HDR10 Setting HLG Setting	<p>Dynamic Range: sets the range of dark and bright areas in images; choose from Auto (recommended), SDR, HDR10, or HLG</p> <p>HDR10 Setting: adjusts the curve for the PQ (Perceptual Quantizer) signal</p> <p>HLG Setting: adjusts the curve for the HDR HLG (Hybrid Log Gamma) signal</p>

Setting	Options	Description
Advanced	Video Range	Sets the video range to match the setting of the device connected to the HDMI , DVI-D , HDBaseT , or SDI input ports
	Input Signal	Specifies the signal type from input sources connected to computer ports Auto : detects signals automatically RGB : corrects color for computer/RGB video inputs Component : corrects color for component video inputs
	BNC Sync Termination	Sets the termination for the signal from the BNC port (set to Off unless you need analog termination, such as for switchers)
	EDID	Describes the projector's display capabilities to devices connected to the HDMI, HDBaseT, DVI-D, or DisplayPort input ports so you can unify multiple displays
	DDC Buffer	If you are projecting using an HDMI or DVI extension cable and the image is not displayed correctly, enabling this setting may improve image quality
Scale	Various scale options	When using multiple projectors to project one image, adjusts the scale of the image displayed by each projector

Parent topic: [Adjusting the Menu Settings](#)

Related references

[Available Image Aspect Ratios](#)

Related tasks

[Scaling an Image](#)

Projector Feature Settings - Settings Menu

Options on the Settings menu let you customize various projector features.

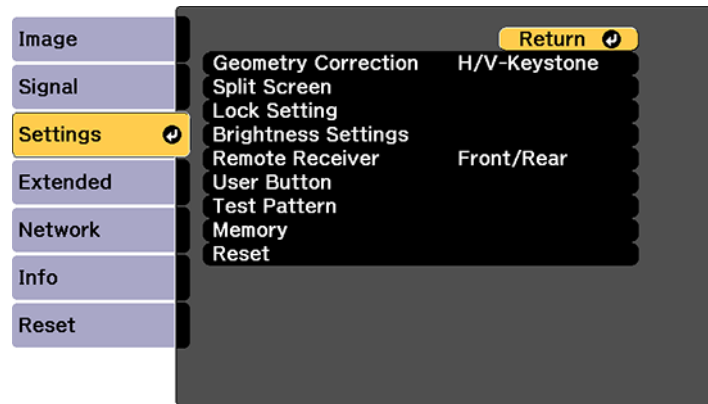

Setting	Options	Description
Geometry Correction	H/V-Keystone Quick Corner Curved Surface Corner Wall Point Correction Memory	Adjusts the projected image shape H/V Keystone: lets you manually correct the angles of the horizontal and vertical sides Quick Corner: select to adjust the position of the four corners Curved Surface: select to adjust the image when projecting on a curved surface Corner Wall: select to adjust the image when projecting on a surface with a right angle Point Correction: select to display a grid and finely adjust the image position Memory: select to save adjustment value of the geometric correction and load it when needed
Split Screen	—	Divides the viewing area horizontally and displays two images side-by-side
Lock Setting	Control Panel Lock Lens Lock	Controls projector button locking to secure the projector Control Panel Lock: <ul style="list-style-type: none"> • Full Lock: locks all buttons • Partial Lock: locks all buttons except the power button • Off: no buttons locked Lens Lock: locks the focus, zoom, and lens shift settings

Setting	Options	Description
Brightness Settings	Light Source Mode Brightness Level Constant Brightness Estimated Remains	Selects the brightness mode of the projector Light Source Mode: sets the brightness for the light source <ul style="list-style-type: none"> • Normal: maximum brightness • Quiet: 70% brightness with reduced fan noise • Extended: 70% brightness and extends the life expectancy of the light source • Custom: select a custom brightness level and enable use of next three settings Brightness Level: select the Custom brightness level you want Constant Brightness: maintains a constant brightness (cannot change the Light Source Mode and Brightness Level settings) Estimated Remains: displays how long the projector can maintain constant brightness (if that setting is selected)
Remote Receiver	Front/Rear Front Rear Off	Limits reception of remote control signals by the selected receiver; Off turns off all receivers
User Button	User1 User2 User3	Assigns a menu option to the User1 , User2 , and User3 buttons on the remote control for one-touch access

Setting	Options	Description
Test Pattern	—	Displays a test pattern to assist in adjusting the image; select from a variety of patterns
Memory	Memory Lens Position Geometry Correction	Save customized sets of settings to memory Memory: loads, saves, erases, or resets specific menu settings Lens Position: saves the position of the adjusted lens Geometry Correction: saves the geometry correction adjustments.

Parent topic: [Adjusting the Menu Settings](#)

Related concepts

[Image Shape](#)

Related tasks

[Projecting Two Images Simultaneously](#)

[Locking the Projector's Lens Settings and Buttons](#)

[Saving Settings to Memory and Using Saved Settings](#)

Projector Setup Settings - Extended Menu

Settings on the Extended menu let you customize various projector setup features that control its operation.

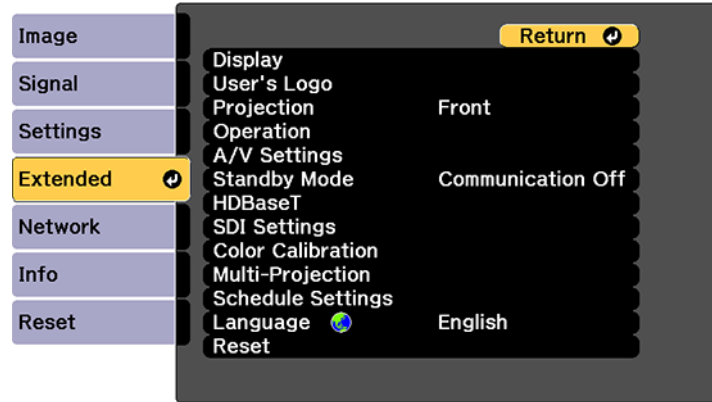

Setting	Options	Description
Display	—	See the Display settings table in this topic
User's Logo	—	Creates a screen that the projector displays to identify itself and enhance security
Projection	Front Front/Ceiling Rear Rear Ceiling	Selects the way the projector faces the screen so the image is oriented correctly
Operation	—	See the Operation settings table in this topic

Setting	Options	Description
A/V Settings	A/V Output	Select Always On to set a fixed IP address and move the lens to the home position when the projector is in standby mode (the Standby Mode setting must be set to Communication On)
Standby Mode	Communication On Communication Off	Enable this setting to allow the following operations to occur when the projector is in standby mode: <ul style="list-style-type: none"> • Monitor and control the projector over a network • Output video to an external device (A/V Output must be set to Always On) • Communication from the HDBaseT port (Control Communications must be set to On in the HDBaseT settings)
HDBaseT	Control Communications Extron XTP	Selects the communication settings for connections to an HDBaseT transmitter or switcher <p>Control Communications: enables or disables communication from the Ethernet and serial ports on the transmitter; turning on this setting disables the projector's LAN, RS-232C, and Remote ports (Extron XTP must be turned off to use this setting)</p> <p>Extron XTP: set to On when you connect an Extron XTP transmitter or switcher to the HDBaseT port</p>

Setting	Options	Description
SDI Settings	Link Type Manual Settings	Select the signal settings for the SDI port Link Type: select Single (Auto) to let the projector read the payload ID for the input signal and automatically display the image, or select Single (Manual) when you know the type of input signal and want to select the same signal in the Manual Settings options Manual Settings: set various SDI settings manually or reset them to their default values
Color Calibration	Start Auto Adjustment Undo Redo Color Uniformity	Automatically detects color deterioration and adjusts the color tone Start Auto Adjustment: automatically adjusts the color tone for the whole image Undo and Redo: undoes or redoes the auto adjustment Color Uniformity: adjusts the color tone balance for the whole image

Setting	Options	Description
Multi-Projection	Projector ID Projector Grouping Tiling Geometry Correction Edge Blending Black Level Scale Screen Matching	<p>Select various options when projecting from multiple projectors</p> <p>Projector ID: sets the projector to a particular ID number which allows you to use a remote control to individually control projectors</p> <p>Projector Grouping: lets you select the projectors being used to project one image</p> <p>Tiling: sets the number of split screens and the position of each image</p> <p>Geometry Correction: corrects image distortion</p> <p>Edge Blending: blends the border between multiple images to create a seamless screen</p> <p>Black Level: adjusts the brightness and tone differences in overlapping images</p> <p>Scale: adjusts the scale of the images</p> <p>Screen Matching: adjusts the tint and brightness of the images</p>
Schedule Settings	Various scheduling options	Lets you schedule various projector tasks
Language	Various languages available	Selects the language for projector menu and message displays (not changed by Reset option)

Display settings

Setting	Description
Menu Position	Selects the position of the projector menu displayed on the screen
Message Position	Selects the position of messages displayed on the screen
Messages	Controls whether messages are displayed on the screen
Display Background	Selects the screen color or logo to display when no signal is received
Startup Screen	Controls whether a special screen appears when the projector starts up
Standby Confirmation	Displays a confirmation message after pressing the Standby button on the remote control
Air Filter Notice	Displays a message when a clog in the air filter is detected
Screen	Sets the aspect ratio and position of the projected image according to the type of screen being used
Panel Alignment	Corrects color misalignment in the projected image
Color Uniformity	Adjusts the color tone balance
OSD Rotation	Rotates the menu display 90°

Operation settings

Setting	Description
Direct Power On	Turns on the projector when you plug it in
Sleep Mode	Automatically places the projector in standby mode after an interval of inactivity
Sleep Mode Timer	Sets the time before the projector automatically turns off (Sleep Mode must be turned on)
High Altitude Mode	Regulates the projector's operating temperature at altitudes above 4921 feet (1500 m)
Startup Source Search	Automatically detects the image signal being input when the projector is turned on

Setting	Description
Shutter Settings	<p>Adjusts the shutter settings</p> <p>Fade-in: sets the number of seconds for a fade-in transition effect when displaying an image</p> <p>Fade-out: sets the number of seconds for a fade-out transition effect when hiding an image</p> <p>Shutter Timer: turns off the projector automatically after using the shutter and 2 hours of inactivity has passed</p> <p>Shutter Release: select Shutter if you want to use only the Shutter button to turn off the shutter, or select Any Button to use any button to turn it off</p> <p>Startup: select the shutter status for when you turn on the projector</p> <p>Standby: select the shutter status for when the projector is in standby mode or select Last Used to maintain the current shutter status when you turn off the projector</p>
Video Terminal Settings	Enables or disables each video input port
Advanced	See the next table in this topic
Date & Time	Adjusts the projector's time and date settings
Lens Calibration	Displays information about the lens currently in use and lets you start lens calibration

Advanced settings

Setting	Description
Beep	Controls the beep that sounds when you turn the projector on or off
Indicators	Select Off to turn off projector lights, except warning lights
Log Save Destination	Select where you want to save projector operation log files
Batch Setup Range	Select which projector menu settings to copy using the batch setup feature; select All or select Limited to not copy the EDID settings or all Network menu settings (except the Notifications and Others menu settings)

Setting	Description
AC Voltage Monitoring	Select Off to regularly use the direct shutdown feature; if you select On for this setting and the projector is turned off by any method other than pressing the power button, a power supply voltage warning message is displayed the next time the projector is turned on
Lens Type	Select the model number of the lens if you installed any of these lenses: ELPLS04, ELPLU02, ELPLR04, ELPLW04, ELPLM06, ELPLM07, or ELPLL07

Parent topic: [Adjusting the Menu Settings](#)

Related concepts

[Using Multiple Projectors](#)

Related tasks

[Saving a User's Logo Image to Display](#)

[Running Light Source Calibration](#)

[Saving a Scheduled Event](#)

[Shutting Off the Picture Temporarily](#)

[Turning Off the Projector](#)

Related topics

[Copying Menu Settings Between Projectors](#)

[Attaching and Removing a Lens](#)

Projector Network and Camera Settings - Network Menu

Settings on the Network menu let you view network information and set up the projector for monitoring and control over a network. You can also control access to a remote camera.

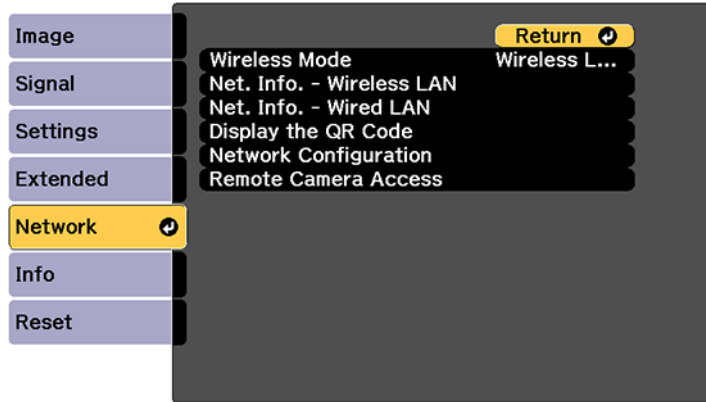

Setting	Options	Description
Wireless Mode	Wireless LAN On Off	Enable or disable wireless communication

Setting	Options	Description
Net. Info - Wireless LAN	Connection mode Wireless LAN Sys. Antenna level Projector Name SSID DHCP IP Address Subnet Mask Gateway Address MAC Address Region Code IPv6	Displays wireless network status and details
Net. Info - Wired LAN	Projector Name DHCP IP Address Subnet Mask Gateway Address MAC Address IPv6 Address (Manual) IPv6 Address (Auto)	Displays wired network status and details
Display the QR Code	—	Displays the QR Code
Network Configuration	Accesses additional network menus	Configures your network settings

Setting	Options	Description
Remote Camera Access	Remote Camera Access Password	Enables or disables the remote camera and lets you set a password to limit access to changing the remote camera setting or capturing the projected image using Web Control

Parent topic: [Adjusting the Menu Settings](#)

Related concepts

[Wired Network Projection](#)

[Wireless Network Projection](#)

Related tasks

[Using a QR Code to Connect a Mobile Device](#)

[Viewing an Image Capture of the Displayed Image from a Remote Location](#)

Projector Information Display - Info Menu

You can display information about the projector and input sources by viewing the Info menu. However, you cannot change any settings in the menu.

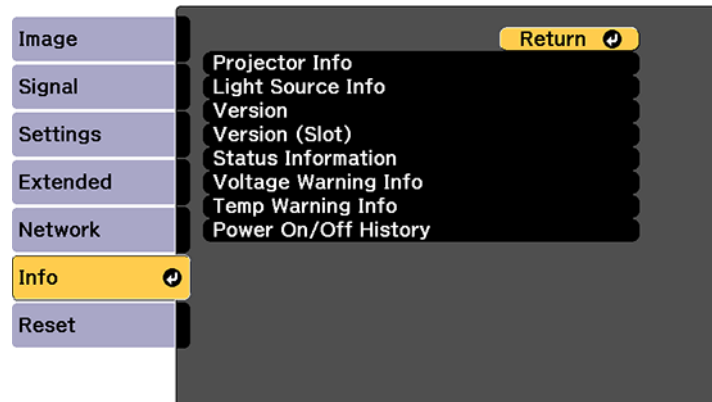

Setting	Options	Description
Projector Info	Operation Hours	Displays the number of hours the projector has been used since it was turned on
	Source	Displays the name of the port to which the current input source is connected
	Input Signal	Displays the input signal setting of the current input source
	Resolution	Displays the resolution of the current input source
	Refresh Rate	Displays the refresh rate of the current input source
	Sync Info	Displays information that may be needed by a service technician
	Color Format	Displays information about the color space and dynamic range
	Status	Displays information about projector problems that may be needed by a service technician
	Serial Number	Displays the projector's serial number
	Lens Type	Displays the model number of the installed lens
	Event ID	Displays the Event ID number corresponding to a specific projector problem; see the list of Event ID codes
	HDBaseT Signal Level	Displays the image signal information from the HDBaseT port

Setting	Options	Description
Light Source Info	Light Source Hours	Displays the number of operating hours for each of the projector's Light Source Mode settings
	Estimated Remains	If the Constant Brightness setting is enabled, displays the remaining number of hours the projector can maintain constant brightness
Version	Main Video2 Sub Sub2 HDBaseT HDBaseT2 SDI Status Monitor AC Monitor	Displays the projector's firmware information
Version (Slot)	Slot1 Slot2	Displays the version information of the interface board connected to the indicated slot
Status Information	—	Displays basic status information
Voltage Warning Info	—	Displays power voltage warning information
Temp Warning Info	—	Displays various high temperature warning information
Power On/Off History	—	Displays the projector's power on and power off history

[Event ID Code List](#)

Parent topic: [Adjusting the Menu Settings](#)

Event ID Code List

If the **Event ID** option on the Info menu displays a code number, check this list of Event ID codes for the solution to the projector problem associated with the code.

Event ID code	Cause and solution
0432	Turn the projector off and then on again.
0435	
0434	Unstable network communication. Check the network communication status, wait a few moments, and try connecting to the network again.
0482	
0484	
0485	
0433	Cannot display the transferred images. Restart the network software.
0481	Communication with computer was disconnected. Restart the network software.
0483 04FE	The network software quit unexpectedly. Check the network communication status, then turn the projector off and then on again.
0479 04FF	A projector system error has occurred. Turn the projector off and then on again.
0891	Cannot find an access point with the same SSID. Set your computer, access point, and projector to the same SSID.
0892	The WPA/WPA2 authentication type does not match. Make sure the wireless network security settings are correct.
0893	The TKIP/AES encryption type does not match. Make sure the wireless network security settings are correct.
0894	Communication with unauthorized access point was disconnected. Contact your network administrator.
0898	Failed to acquire DHCP. Make sure the DHCP server is operating correctly. If you are not using DHCP, turn off the DHCP setting in the Network menus.
0899	Communication error. Turn the projector off and then on again.

Event ID code	Cause and solution
089A 089B 089C 089D	EAP authentication error. Make sure the wireless network security settings are correct.
0920	The internal power supply is running low. Contact Epson support.

Parent topic: [Projector Information Display - Info Menu](#)

Projector Reset Options - Reset Menu

You can reset most of the projector settings to their default values using the **Reset All Config** option on the Reset menu.

You can also reset the saved names and settings in the Save Memory list using the **Reset All Memories** option.

To reset all settings to the factory default (except for password protected settings), select the **Reset All (Factory Default)** option. You need to enter a password to reset the settings. The default password is 0000, which you should change to your own password.

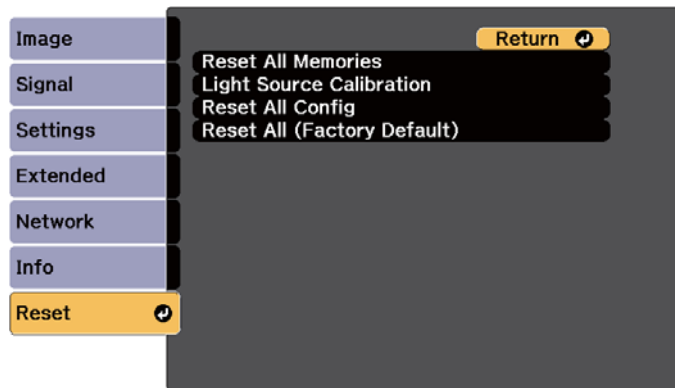

You cannot reset the following settings using the **Reset All Config** option:

- Input Signal
- Memory

- User's Logo
- Network menu items
- Language
- Date & Time
- Panel Alignment
- Color Uniformity
- Lens Calibration
- Color Calibration
- Projector Grouping
- Screen Matching
- Color Matching

Parent topic: [Adjusting the Menu Settings](#)

Related references

[Projector Network and Camera Settings - Network Menu](#)

Related tasks

[Saving Settings to Memory and Using Saved Settings](#)

Maintaining and Transporting the Projector

Follow the instructions in these sections to maintain your projector and transport it from place to place.

[Projector Maintenance](#)

[Transporting the Projector](#)

Projector Maintenance

Your projector needs little maintenance to keep working at its best.

You may need to clean the lens periodically, and clean the air filter and air vents to prevent the projector from overheating due to blocked ventilation.

The only parts you should replace are the air filter and remote control batteries. If any other part needs replacing, contact Epson or an authorized Epson servicer.

This projector uses a sealed laser light source which does not need servicing and cannot be replaced.

Warning: Before cleaning any part of the projector, turn it off, wait for it to beep, and unplug the power cord. Never open any cover on the projector, except as specifically explained in this manual. Dangerous electrical voltages in the projector can injure you severely.

Warning: Do not try to service this product yourself, except as specifically explained in this manual. Refer all other servicing to qualified servicers.

[Cleaning the Lens](#)

[Cleaning the Projector Case](#)

[Air Filter and Vent Maintenance](#)

[Replacing the Remote Control Batteries](#)

Parent topic: [Maintaining and Transporting the Projector](#)

Related tasks

[Turning Off the Projector](#)

Cleaning the Lens

Clean the projector's lens periodically, or whenever you notice dust or smudges on the surface.

- To remove dust or smudges, gently wipe the lens with lens-cleaning paper.

- To remove stubborn smudges, moisten a soft, lint-free cloth with lens cleaner and gently wipe the lens. Do not spray any liquid directly on the lens.

Warning: Do not use a lens cleaner that contains flammable gas. The high heat generated by the projector may cause a fire.

Caution: Do not use glass cleaner or any harsh materials to clean the lens and do not subject the lens to any impacts; you may damage it. Do not use canned air, or the gases may leave a residue. Avoid touching the lens with your bare hands to prevent fingerprints on or damage to the lens surface.

Parent topic: [Projector Maintenance](#)

Cleaning the Projector Case

Before cleaning the projector case, turn off the projector, wait for it to beep, and unplug the power cord.

- To remove dust or dirt, use a soft, dry, lint-free cloth.
- To remove stubborn dirt, use a soft cloth moistened with water and mild soap. Do not spray liquid directly on the projector.

Caution: Do not use wax, alcohol, benzene, paint thinner, or other chemicals to clean the projector case. These can damage the case. Do not use canned air, or the gases may leave a flammable residue.

Parent topic: [Projector Maintenance](#)

Related tasks

[Turning Off the Projector](#)

Air Filter and Vent Maintenance

Regular filter maintenance is important to maintaining your projector. Your Epson projector is designed with an easily accessible, user-replaceable filter to protect your projector and make regular maintenance simple. Filter maintenance intervals will depend on the environment.

If regular maintenance is not performed, your Epson projector will notify you when the temperature inside the projector has reached a high level. Do not wait until this warning appears to maintain your projector filter as prolonged exposure to high temperatures may reduce the life of your projector or laser.

Damage due to the failure to properly maintain the projector or its filter may not be covered by the projector's Limited Warranty.

[Cleaning the Air Filters and Air Intake Vents](#)

[Replacing the Air Filters](#)

Parent topic: [Projector Maintenance](#)

Related references

[Projector Light Status](#)

Cleaning the Air Filters and Air Intake Vents

You need to clean the projector's air filters and air intake vents in the following situations:

- The filters or vents get dusty.
- You see a message telling you to clean it.

Note: To receive air filter notifications, make sure the **Air Filter Notice** setting is set to **On** in the Extended menu **Display** settings.

- The projector's Filter light flashes orange.

Note: The projector has two air filters on the front. The illustrations here show cleaning the air filter on the right, but the steps are the same to clean either filter.

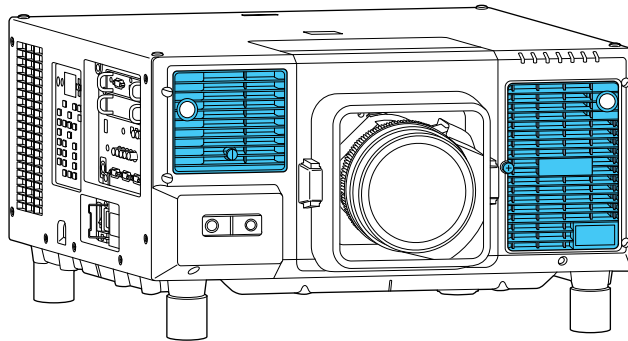

1. Turn off the projector, wait for the projector to beep, and unplug the power cord.

2. Loosen the screw securing the air filter cover and open the air filter cover as shown. (It is attached with a cord.)

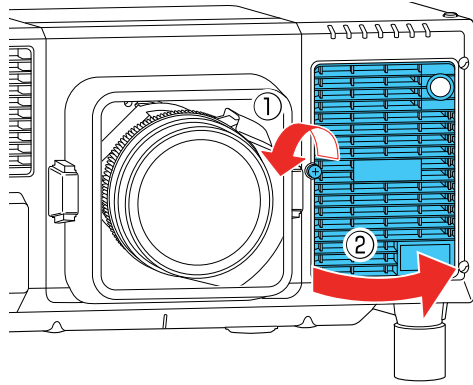

3. Grasp the tab on the air filter and pull it out of the projector.

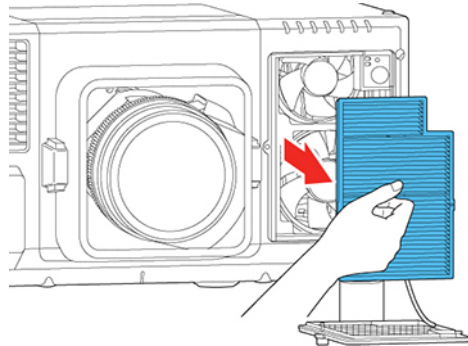

4. Tap each side of the air filter 4 to 5 times to shake off any excess dust.

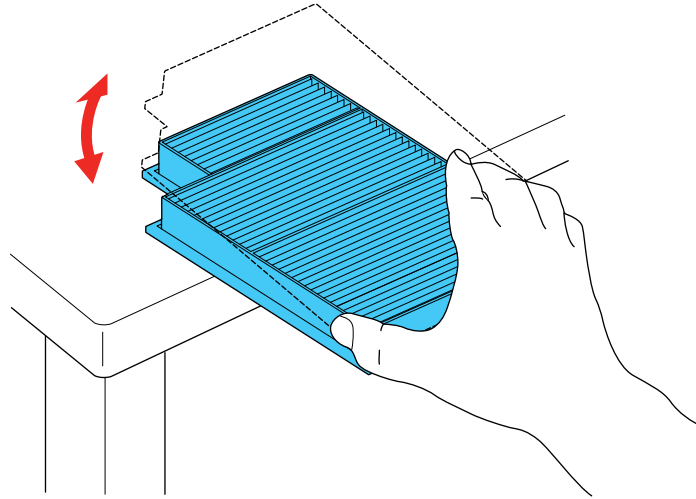

Caution: Do not use excessive force when tapping the air filter, or it may crack and become unusable. Do not rinse the air filter in water, or use any detergent or solvent to clean it. Do not use canned air; the gases may leave a residue, or push dust and debris into the projector's optics or other sensitive areas.

5. Vacuum the front of the air filter (the side with the tabs) to remove any remaining dust.

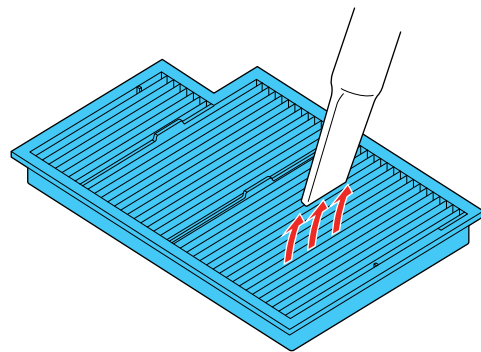

Note: If dust is difficult to remove or the air filter is damaged, replace the air filter.

6. Place the air filter back in the projector as shown and push gently until it clicks into place.

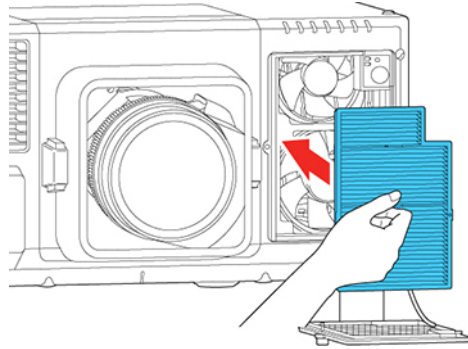

7. Insert the tabs on the right side of the air filter cover into the notches in the projector. Then close the air filter cover and tighten the screw to secure it.

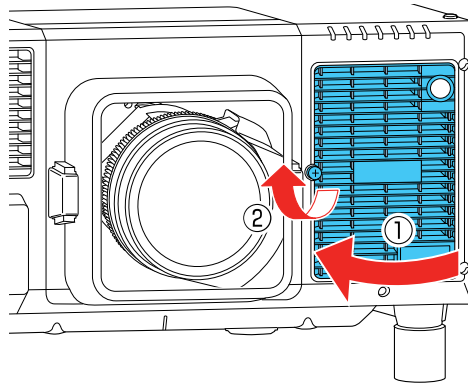

8. Repeat these steps to clean the other air filter.

9. Use a vacuum cleaner or soft, long-bristle brush to carefully remove dust from the air intake vents on the side and bottom of the projector.

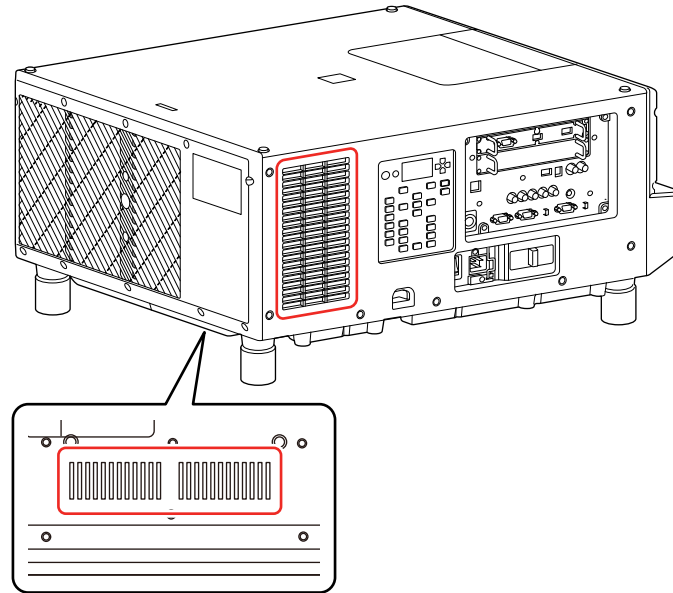

Note: Clean the projector's air intake vents periodically, or whenever you notice dust on the side or bottom of the projector.

Parent topic: [Air Filter and Vent Maintenance](#)

Related references

[Projector Light Status](#)

[Projector Setup Settings - Extended Menu](#)

Related tasks

[Replacing the Air Filters](#)

Replacing the Air Filters

You need to replace the air filters in the following situations:

- After cleaning an air filter, you see a message telling you to clean or replace it.
- An air filter is torn or damaged.

Note: To receive air filter notifications, make sure the **Air Filter Notice** setting is set to **On** in the Extended menu **Display** settings.

You can replace the air filters while the projector is mounted to the ceiling or placed on a table.

Note: The projector has two air filters. The illustrations here show replacing the air filter on the right, but the steps are the same to replace either filter.

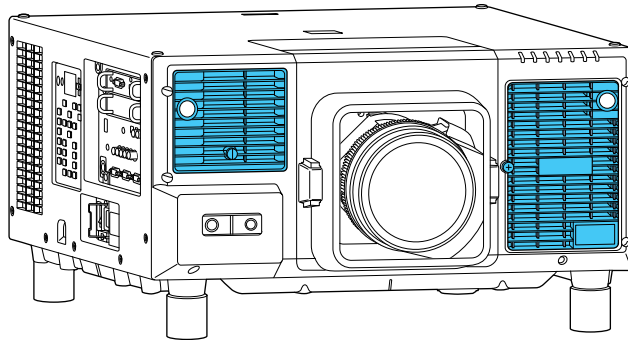

1. Turn off the projector, wait for the projector to beep, and unplug the power cord.
2. Loosen the screw securing the air filter cover and open the air filter cover as shown. (It is attached with a cord.)

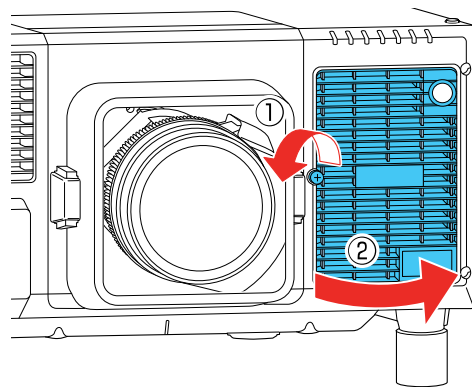

3. Grasp the tab on the air filter and pull it out of the projector.

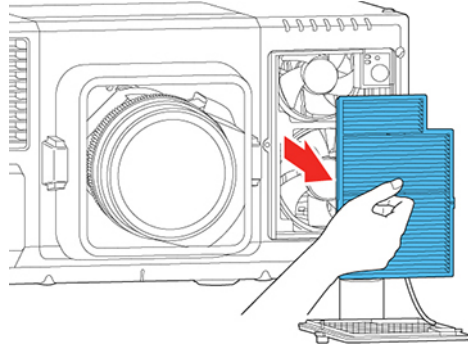

Note: Air filters contain polypropylene. Dispose of used air filters according to local regulations.

4. Place the new air filter in the projector as shown and push gently until it clicks into place.

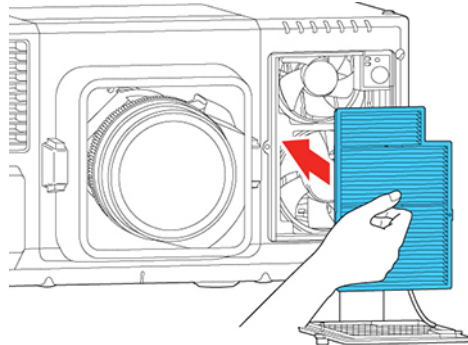

5. Insert the tabs on the right side of the air filter cover into the notches in the projector. Then close the cover and tighten the screw securing it.

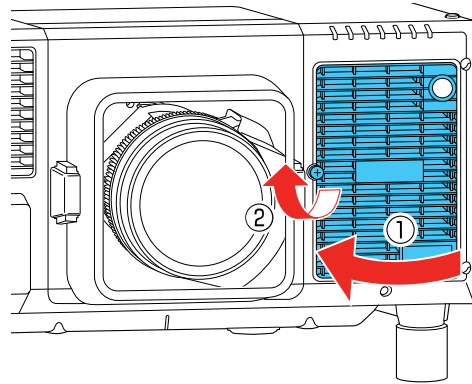

6. Repeat these steps to replace the other air filter.

Parent topic: [Air Filter and Vent Maintenance](#)

Related references

[Projector Setup Settings - Extended Menu](#)

Replacing the Remote Control Batteries

The remote control uses two AA manganese or alkaline batteries. Replace the batteries as soon as they run out.

Caution: Use only the type of batteries specified in this manual. Do not install batteries of different types, or mix new and old batteries.

1. Remove the battery cover as shown.

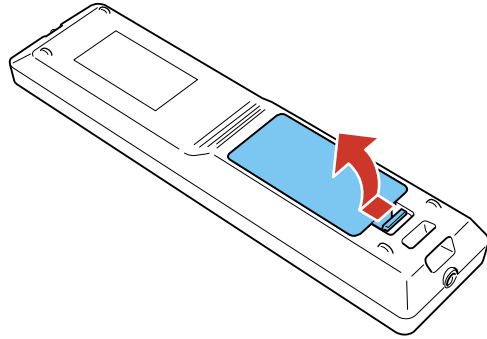

2. Remove the old batteries.

Warning: If the battery fluid has leaked, wipe it away with a soft cloth and avoid getting the fluid on your hands. If it gets on your hands, wash them immediately to avoid injury.

3. Insert the batteries with the + and – ends facing as shown.

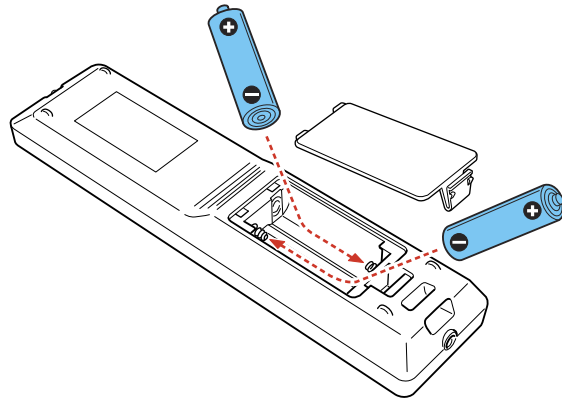

4. Replace the battery cover and press it down until it clicks into place.

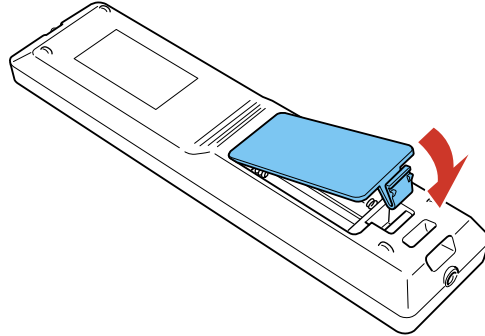

Warning: Dispose of used batteries according to local regulations. Do not expose batteries to heat or flame. Keep batteries out of the reach of children; they are choking hazards and are very dangerous if swallowed.

Parent topic: [Projector Maintenance](#)

Transporting the Projector

The projector contains precision parts, some of which are glass. Follow the guidelines here to transport, ship, or store the projector safely.

Caution: Use three or more people to unpack or lift the projector.

Warning: When moving the projector, do not hold the lens replacement cover. It may come off and the projector may fall, which could cause an injury.

1. Turn the projector off, wait for it to beep, and remove any equipment connected to the projector.
2. If you are packing the projector to transport it a long distance, remove the lens unit and attach the cap for the lens cover.
3. To lift or lower the projector, install four commercially available eye bolt screws M6 (up to a depth of 27 mm) to the screw thread holes in each corner of the projector. Attach straps or chains to the

screws and make sure the angle of the strap is 60 degrees or more when lifting or lowering the projector.

Caution: Do not lift the projector with the front, back, or side of the projector facing up.

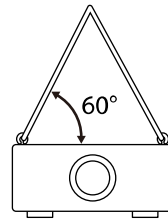
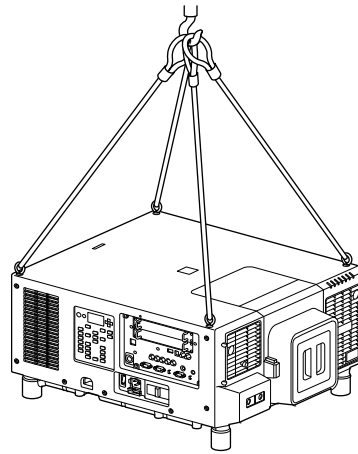

Caution: Do not use the eye bolt screws for permanent installation as this can cause damage.

4. Do one of the following:
 - When transporting the projector a long distance or as checked luggage, pack it in a firm box with cushioning around it and mark the box "Fragile."
 - When shipping the projector for repairs, place it in its original packing materials, if possible, or use equivalent materials with cushioning around the projector. Mark the box "Fragile."

Note: Epson shall not be liable for any damages incurred during transportation.

Parent topic: [Maintaining and Transporting the Projector](#)

Related tasks

[Turning Off the Projector](#)

[Removing a Lens](#)

Solving Problems

Check the solutions in these sections if you have any problems using the projector.

[Projection Problem Tips](#)

[Projector Light Status](#)

[Viewing Projector Status Information](#)

[Using the Projector Help Displays](#)

[Solving Image Problems](#)

[Solving Projector or Remote Control Operation Problems](#)

[Solving Network Problems](#)

[Where to Get Help](#)

Projection Problem Tips

If the projector is not working properly, try turning it off and unplugging it. Then plug it back in and turn it on.

If this does not solve the problem, check the following:

- The lights on the projector may indicate what the problem is.
- The projector's Help system can display information about common problems, if the projector is operating.
- The projector's LCD screen can display information about the projector's status.
- The solutions in this manual can help you solve many problems.

If none of these solutions help, you can contact Epson for technical support.

Parent topic: [Solving Problems](#)

Related references

[Projector Light Status](#)

[Where to Get Help](#)

Related tasks

[Using the Projector Help Displays](#)

[Viewing Projector Status Information](#)

Projector Light Status

The lights on the projector indicate the projector status and let you know when a problem occurs. Check the status and color of the lights and look for a solution in the table here.

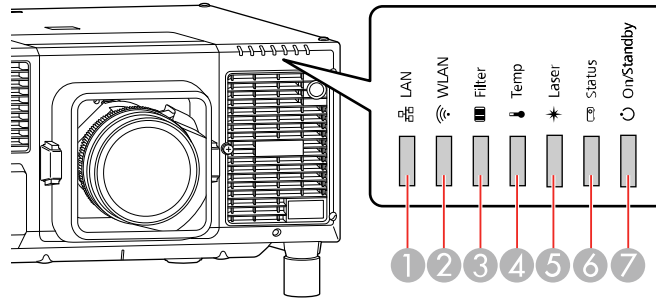

- 1 LAN (wired network or HDBaseT status)
- 2 WLAN (wireless network status)
- 3 Filter light
- 4 Temp (temperature) light
- 5 Laser light
- 6 Status light
- 7 On/Standby light

On/Standby (power) light	Status light	Laser light	Temp light	Filter light	Status and solution
Blue	Off	Off	Off	Off	Projector is in standby mode or network monitoring and control is in progress.
Blue	Flashing blue	Varies	Off	Off	Warming up. Wait for an image to appear.
Blue	Blue	Varies	Off	Off	Normal operation.

On/Standby (power) light	Status light	Laser light	Temp light	Filter light	Status and solution
Blue	Blue	Flashing orange fast	Off	Off	Projector is connected to a 110 V power source and the laser is operating at approximately 55% of available power. For optimal performance, connect the projector to a 220 V power source using the 220 V power cord that came with the projector.
Blue	Flashing blue	Off	Off	Off	Cooling down. All buttons are disabled.
Flashing blue	Off	Off	Off	Off	Preparing network monitoring. (Wait for the light to remain orange before unplugging the projector.)
Blue	Blue	Flashing blue	Off	Off	The shutter feature is enabled.
Off	Flashing blue	Flashing orange	Off	Off	Internal error. Turn off the projector, unplug the power cord, and contact Epson for help.
Off	Flashing blue	Off	Flashing orange	Off	A fan or sensor has a problem. Turn off the projector, unplug the power cord, and contact Epson for help.

On/Standby (power) light	Status light	Laser light	Temp light	Filter light	Status and solution
Off	Flashing blue	Off	Orange	Off	<p>Projector is too hot. Wait for about five minutes so the projector can switch to standby mode. Then check the following:</p> <ul style="list-style-type: none"> • Make sure that the vents and air filter are not clogged with dust or obstructed by nearby objects. • Clean or replace the air filter. • Make sure the environmental temperature is not too hot. • If operating the projector at high altitude, turn on High Altitude Mode. • If the problem persists, unplug the projector and contact Epson for help.
Off	Flashing blue	Orange	Off	Off	<p>Laser error.</p> <ul style="list-style-type: none"> • Make sure that the vents and air filter are not clogged with dust or obstructed by nearby objects. • Clean or replace the air filter. • If the problem persists, unplug the projector and contact Epson for help.
Off	Flashing blue	Off	Off	Orange	<p>Low air flow through the projector.</p> <ul style="list-style-type: none"> • Make sure that the vents and air filter are not clogged with dust or obstructed by nearby objects. • Clean or replace the air filter. • If the problem persists, unplug the projector and contact Epson for help.

On/Standby (power) light	Status light	Laser light	Temp light	Filter light	Status and solution
Off	Flashing blue	Orange	Orange	Off	No lens installed, or lens shift or supply voltage error. Remove and reinstall the lens. If the problem persists, turn off the projector, unplug the power cord, and contact Epson for help
Off	Flashing blue	Flashing orange	Flashing orange	Off	Shutter error. Turn off the projector, unplug the power cord, and contact Epson for help.
Flashing blue	Varies	Varies	Flashing orange	Varies	High temperature warning. If the temperature gets too high, projection will automatically stop. <ul style="list-style-type: none"> • Make sure that the vents and air filter are not clogged with dust or obstructed by nearby objects. • Make sure the environmental temperature is not too hot. • Clean or replace the air filter.
Varies	Varies	Varies	Varies	Flashing orange	Clean the air filter.
Flashing blue	Varies	Flashing orange	Varies	Varies	Laser warning. Turn off the projector, unplug the power cord, and contact Epson for help.
Flashing blue	Varies	Flashing orange	Varies	Varies	An unsupported lens is attached. Attach only a supported lens.
Flashing blue	Varies	Flashing orange	Flashing orange	Varies	Shutter error. Turn off the projector, unplug the power cord, and contact Epson for help.

On/Standby (power) light	Status light	Laser light	Temp light	Filter light	Status and solution
Flashing blue	Varies	Varies	Varies	Orange	Low air flow through the air filter. <ul style="list-style-type: none"> • Make sure that the vents and air filter are not clogged with dust or obstructed by nearby objects. • Clean or replace the air filter. • If the problem persists, unplug the projector and contact Epson for help.
Varies	Varies	Flashing orange	Varies	Varies	End of Constant Brightness mode.
Varies	Off	Flashing orange fast	Flashing orange fast	Varies	When performing batch setup using a USB flash drive, the setup file may be corrupt or the USB flash drive may not be connected correctly. Remove the USB flash drive, turn off the projector and unplug the power cord, then plug the power cord back in, turn on the projector, and try again.
Flashing blue fast	Off	Flashing orange fast	Flashing orange fast	Flashing blue fast	When performing batch setup, an error may have occurred when writing the settings. Turn off the projector, unplug the power cord, and contact Epson for help.

LAN light	WLAN light	Status and solution
Blue	—	You can use a wired LAN or HDBaseT transmitter
Off	—	Cannot use wired LAN or HDBaseT transmitter. Check the LAN cable connection and your LAN or HDBaseT transmitter settings.
—	Blue	Wireless LAN is available.

LAN light	WLAN light	Status and solution
—	Flashing blue quickly	Connecting to a device.
—	Flashing blue slowly	Wireless error. Turn the projector off and then on again.
—	Off	Wireless LAN is unavailable. Check your wireless LAN settings.

Note: If the lights display a pattern not listed in the table above, turn the projector off, unplug it, and contact Epson for help.

Parent topic: [Solving Problems](#)

Related concepts

[Air Filter and Vent Maintenance](#)

[Wired Network Projection](#)

[Wireless Network Projection](#)

Related references

[Projector Setup Settings - Extended Menu](#)

[Optional Equipment and Replacement Parts](#)

[Projector Feature Settings - Settings Menu](#)

[Where to Get Help](#)

Related tasks

[Turning On the Projector](#)

[Shutting Off the Picture Temporarily](#)

[Turning Off the Projector](#)

Related topics

[Attaching and Removing a Lens](#)

[Copying Menu Settings Between Projectors](#)

Viewing Projector Status Information

You can monitor the projector's status and view error information on the LCD screen.

Note: You can also view the projector's status in the Info menu. Press the **i** button on the remote control and select **Status Information**.

1. Turn on the projector.
2. Press the light button on the control panel.
3. Press the left or right arrow button to view different categories of information.

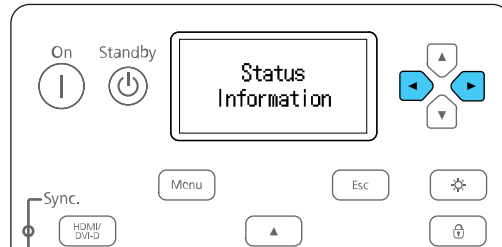

- **Status Information:** the projector's operating status
- **Source:** input signal information
- **Signal Information:** input digital signal information
- **Network Wired:** wired LAN settings
- **Network Wireless:** wireless LAN settings
- **Maintenance:** operating time for the projector and light source
- **Version:** projector's firmware version
- **Setting:** lets you adjust the LCD screen contrast and the length of time the screen remains lit when you press the light button

4. Press the up or down arrow button to scroll through the information on the screen.

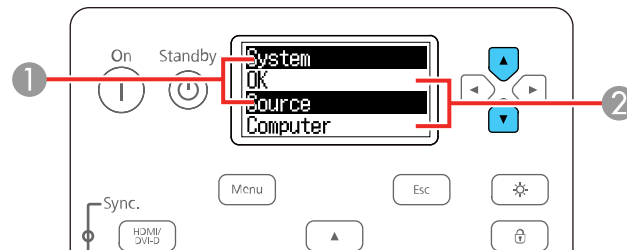

- 1 Item name
- 2 Status information

[Projector Status Display Messages](#)

Parent topic: [Solving Problems](#)

Related references

[Projector Information Display - Info Menu](#)

Projector Status Display Messages

Categories on the status display screens let you view information about the projector and its operation.

Status Information category

Information	Description
System	See the System status information table at the end of this topic
Last Warn/Err	Displays the most recent warnings and errors displayed by the projector
Source	Displays the source currently being used
On-Screen Display	Displays the settings for on-screen displays. When turned off, menus or messages are not displayed on the projected images
Shutter	Displays the shutter status
Shutter Startup	Displays the shutter Startup settings
Shutter Standby	Displays the shutter Standby settings
Intake Air Temp	Displays the air intake temperature
Internal Temp Lv	Displays the projector's internal temperature
AC Voltage	Displays warnings and errors that have occurred when the AC Voltage Monitoring setting is turned on
Laser Status	Displays the operating status of the light source

Information	Description
SLOT1 Model	Displays the name of the interface board installed in Slot 1.
SLOT1 Condition	Displays the status of the interface board installed in Slot 1.
SLOT1 Board ID	Displays the ID of the interface board installed in Slot 1.
SLOT1 Board Ver	Displays the version of the interface board installed in Slot 1.
SLOT2 Model	Displays the name of the interface board installed in Slot 2.
SLOT2 Condition	Displays the status of the interface board installed in Slot 2.
SLOT2 Board ID	Displays the ID of the interface board installed in Slot 2.
SLOT2 Board Ver	Displays the version of the interface board installed in Slot 2.

Source category

Information	Description
Source	Displays the source currently being used
Resolution	Displays the resolution of the current input signal
Color Space	Displays the color space of the current input signal
H-Frequency	Displays the horizontal frequency of the current input signal
V-Frequency	Displays the vertical frequency of the current input signal
Sync Polarity	Displays the sync polarity
Sync Mode	Displays the sync type
Detected Mode	Displays the detected mode of the current input signal

Information	Description
Transport	Displays the scanning method
Video Range	Displays the video range of the projector

Signal Information category

Information	Description
5V Detect	Displays the detection results of 5V signals
TMDS Clock	Displays the TMDS frequency of the current input signal
H-Frequency	Displays the horizontal frequency of the current input signal
V-Frequency	Displays the vertical frequency of the current input signal
Stable Time	Displays the amount of operating time since the input source was determined
HDCP Status	Displays the HDCP status
HDCP Ver	Displays the HDCP version
AVI VIC	Displays the VIC information (AVI) of the current input signal
AVI Sampling Str	Displays color sampling for AVI
Signal Mode	Displays the signal mode
Color Space	Displays the color space conversion method
HDR Mode	Displays the HDR mode
EDID Mode	Displays the EDID mode
HDBaseT Level	Displays the image signal from the HDBaseT port
SDI Link Mode	Displays the linking type for SDI
Sync Detect	Displays the results of signal detection for each SDI port
PayloadID Detect	Displays the results of SDI payload ID detection

Information	Description
Resolution	Displays the resolution
Refresh Rate	Displays the refresh rate for SDI
Color Sampling	Displays the color sampling
Pixel Depth	Displays the color depth for SDI
SDI Type	Displays the type for SDI
Division Type	Displays the split transmission method for SDI
3G Mapping Level	Displays the mapping level for 3G-SDI

Network Wired category

Information	Description
Projector Name	Displays the name used to identify the projector when connected to a network
Connection Mode	Displays the connection path for the LAN
DHCP	Displays the DHCP display settings
IP Display	Displays the IP address display settings
IP Address	Displays the IP address
MAC Address	Displays the MAC address

Network Wireless category

Information	Description
Projector Name	Displays the name used to identify the projector when connected to a network
Connection Mode	Displays the connection mode to use when connecting the projector and a computer over a wireless LAN
SSID Display	Displays the SSID display settings
IP Display	Displays the IP address display settings
SSID	Displays the SSID

Information	Description
IP Address	Displays the IP address
DHCP	Displays the DHCP settings
MAC Address	Displays the MAC address
Security	Displays the security settings
Antenna Level	Displays the reception status for Wi-Fi

Maintenance category

Information	Description
Operation Time	Displays the projector's total operation time
Laser Op. Time	Displays the laser operating time for each Light Source Mode setting
Service Info LBL	Displays information for the light source

Version category

Information	Description
Serial No.	Displays the projector's serial number
Main	Display the projector's firmware version information
Video2	
Sub	
Sub2	
HDBaseT	
Status Monitor	

System status information

Status	Description
OK	The projector is in normal operating mode
Warm-up	The projector is warming up

Status	Description
Standby	The projector is in standby mode
Cool Down	The projector is cooling down
Temp Error	A high temperature error occurred
Fan Error	A fan error occurred
Sensor Error	A sensor error occurred
Internal Error	An internal error occurred
Airflow Error	A filter airflow error occurred
Temp Warning	A high temperature warning occurred
Internal Warning	A warning regarding the internal system occurred
Airflow Decline	A low airflow error occurred
Clean Filter	An air filter notice occurred; clean the air filter
Lens Error	A lens error has occurred
Laser Error	A laser error has occurred
Laser Warning	A laser warning has occurred

Parent topic: [Viewing Projector Status Information](#)

Using the Projector Help Displays

You can display information to help you solve common problems using the projector's Help system.

Note: Before using the Help system, assign **Help** to one of the **User** buttons.

1. Turn on the projector.
2. Press the **User** button assigned to **Help**.
You see the Help menu.
3. Use the up and down arrow buttons to highlight the problem you want to solve.
4. Press **Enter** to view the solutions.

5. When you are finished, do one of the following:
 - To select another problem to solve, press **Esc**.
 - To exit the help system, press the **Menu** button.

Parent topic: [Solving Problems](#)

Related references

[Projector Feature Settings - Settings Menu](#)

Solving Image Problems

Check the solutions in these sections if you have any problems with projected images.

[Solutions When No Image Appears](#)

[Solutions When "No Signal" Message Appears](#)

[Solutions When "Not Supported" Message Appears](#)

[Solutions When Only a Partial Image Appears](#)

[Solutions When the Image is Not Rectangular](#)

[Solutions When the Image Contains Noise or Static](#)

[Solutions When the Image is Fuzzy or Blurry](#)

[Solutions When the Image Brightness or Colors are Incorrect](#)

[Solutions When Automatic Adjustments are not Applied Correctly](#)

Parent topic: [Solving Problems](#)

Solutions When No Image Appears

If no image appears, try the following solutions:

- Make sure the lens cap is off.
- Press the **Shutter** button on the remote control to see if the image was temporarily turned off.
- Make sure all necessary cables are securely connected and the power is on for the projector and connected video sources.
- Make sure the image being projected is not completely black (only when projecting computer images).
- Press the projector's power button to wake it from standby or sleep mode. Also see if your connected computer is in sleep mode or displaying a blank screen saver.
- Press the **Menu** button. If the projector menu displays, there may be a problem with the connected video source, cable connection, or port.

- Check the settings on the Signal menu to make sure they are correct for the current video source. If you are using the SDI In port, make sure the **SDI Settings** options are set correctly on the Extended menu.
- Adjust the **Brightness Settings**.
- Check the **Display** setting to make sure **Messages** is set to **On**.
- For images projected with Windows Media Center, reduce the screen size from full screen mode.
- For images projected from applications using Windows DirectX, turn off DirectX functions.
- If you are projecting from a laptop computer, make sure it is set up to display on an external monitor.
- If you are using other display equipment with the projector, make sure the **EDID** settings are set correctly on the Signal menu. You may need to disconnect the other equipment and select **EDID** settings again.
- If you connected an external monitor to the projector and nothing appears on it, make sure the projector is not in standby mode. Also make sure you connected the external monitor to the correct port for your video source.
- If the other solutions do not solve the problem, reset all of the projector settings using the options on the **Reset** menu.

Parent topic: [Solving Image Problems](#)

Related concepts

[Projector Connections](#)

Related references

[Input Signal Settings - Signal Menu](#)

[Projector Setup Settings - Extended Menu](#)

[Projector Reset Options - Reset Menu](#)

Related tasks

[Shutting Off the Picture Temporarily](#)

[Connecting to an External Computer Monitor](#)

Solutions When "No Signal" Message Appears

If the "No Signal" message appears, try the following solutions:

- Press the **Search** button on the remote control and wait a few seconds for an image to appear. You can also press the source button for the video source on the projector's control panel or remote control.

- Turn on the connected computer or video source, and press its play button to begin your presentation, if necessary.
- Check the connection from the projector to your video sources.
- If you are projecting from a laptop computer, make sure it is set up to display on an external monitor.
- If necessary, turn the projector and the connected computer or video source off and then on again.
- Try a different video cable.
- If the other solutions do not solve the problem, reset all of the projector settings using the options on the **Reset** menu.

[Displaying From a PC Laptop](#)

[Displaying From a Mac Laptop](#)

Parent topic: [Solving Image Problems](#)

Related concepts

[Projector Connections](#)

Related references

[Projector Reset Options - Reset Menu](#)

Related tasks

[Selecting an Image Source](#)

Displaying From a PC Laptop

If you see the "No Signal" message when you display from a PC laptop, you need to set up the laptop to display on an external monitor.

1. Hold down the laptop's **Fn** key and press the key labeled with a monitor icon or **CRT/LCD**. (See your laptop manual for details.) Wait a few seconds for an image to appear. To display on both the laptop's monitor and the projector, try pressing the same keys again.

Note: On Windows 7 or later, hold down the Windows key and press **P** at the same time, then click **Duplicate**.

2. If the same image is not displayed by the laptop and projector, check the Windows **Display** utility to make sure the external monitor port is enabled and extended desktop mode is disabled. (See your computer or Windows manual for instructions.)
3. If necessary, check your video card settings and set the multiple display option to **Clone**, **Mirror**, or **Duplicate**.

Parent topic: [Solutions When "No Signal" Message Appears](#)

Displaying From a Mac Laptop

If you see the "No Signal" message when you display from a Mac laptop, you need to set up the laptop for mirrored display. (See your laptop manual for details.)

1. Open the **System Preferences** utility and select **Displays**, **Display**, or **Color LCD**.
2. Click the **Arrange** or **Arrangement** tab.
3. Select the **Mirror Displays** checkbox.

Parent topic: [Solutions When "No Signal" Message Appears](#)

Solutions When "Not Supported" Message Appears

If the "Not Supported" message appears, try the following solutions:

- Make sure the correct input signal is selected on the Signal menu.
- Make sure the computer's display resolution does not exceed the projector's resolution and frequency limit. If necessary, select a different display resolution for your computer. (See your computer manual for details.)
- As a test, try setting the computer's display resolution to the lowest possible setting, and then gradually increase it as necessary.
- Check the input resolution under **Projector Info** in the **Info** menu and make sure that the projector supports that resolution.

Parent topic: [Solving Image Problems](#)

Related references

[Input Signal Settings - Signal Menu](#)

[Supported Video Display Formats](#)

[Projector Information Display - Info Menu](#)

Solutions When Only a Partial Image Appears

If only a partial computer image appears, try the following solutions:

- Press the **Auto** button on the remote control to optimize the image signal.
- Make sure you selected the correct **Screen Type** setting for the screen you are using.
- Make sure the **Scale** setting in the Extended menu is turned off.
- Try adjusting the image position using the **Position** setting in the Signal menu.
- Try adjusting the image position using the **Screen Position** menu setting.

- Press the **Aspect** button on the remote control to select a different image aspect ratio.
- Check the **Blanking** setting in the Signal menu.
- Check the cables connecting the computer or video source to the projector. Try connecting different cables.
- Check your computer display settings to disable dual display and set the resolution within the projector's limits. (See your computer manual for details.)
- Check the resolution assigned to your presentation files to see if they are created for a different resolution than you are projecting in. (See your software help for details.)
- Make sure you selected the correct **Projection** setting in the Extended menu.
- If the other solutions do not solve the problem, reset all of the projector settings using the options on the **Reset** menu.

Parent topic: [Solving Image Problems](#)

Related concepts

[Projector Connections](#)

Related references

[Input Signal Settings - Signal Menu](#)

[Projector Reset Options - Reset Menu](#)

[Projector Setup Settings - Extended Menu](#)

Related tasks

[Setting the Screen Type](#)

[Scaling an Image](#)

[Adjusting the Image Position Using Screen Position](#)

[Changing the Image Aspect Ratio](#)

Solutions When the Image is Not Rectangular

If the projected image is not evenly rectangular, try the following solutions:

- Place the projector directly in front of the center of the screen, facing it squarely, if possible.
- Adjust the image shape using the **Geometry Correction** menu settings.

Parent topic: [Solving Image Problems](#)

Related references

[Projector Feature Settings - Settings Menu](#)

Solutions When the Image Contains Noise or Static

If the projected image seems to contain electronic interference (noise) or static, try the following solutions:

- Check the cables connecting your computer or video source to the projector. They should be:
 - Separated from the power cord to prevent interference
 - Securely connected at both ends
 - Not connected to an extension cable
 - No longer than 9.8 feet (3 m) for VGA/computer cables or 24 feet (7.3 m) for HDMI cables
- Select a computer video resolution and refresh rate that are compatible with the projector.
- If you are projecting from a computer, press the **Auto** button on the remote control to automatically adjust the tracking and sync. If the problem remains, display a uniformly patterned image on the screen and manually adjust the **Tracking** and **Sync** settings.
- Try a different cable.
- Try adjusting the **Image Enhancement** settings on the Image menu.

Parent topic: [Solving Image Problems](#)

Related references

[Supported Video Display Formats](#)

[Image Quality Settings - Image Menu](#)

Solutions When the Image is Fuzzy or Blurry

If the projected image is fuzzy or blurry, try the following solutions:

- Adjust the image focus.
- Clean the projector lens.

Note: To avoid condensation on the lens after bringing the projector in from a cold environment, let the projector warm up to room temperature before using it.

- Position the projector close enough to the screen.
- Position the projector so the keystone adjustment angle is not so wide that it distorts the image.
- Adjust the **Sharpness** setting to improve image quality.

- If you are projecting from a computer, press the **Auto** button on the remote control to automatically adjust the tracking and sync. If any bands or overall blurriness remain, display a uniformly patterned image on the screen and manually adjust the **Tracking** and **Sync** settings.
- If you are projecting from a computer, try using a lower resolution or try to match the projector's native resolution.

Parent topic: [Solving Image Problems](#)

Related references

[Image Quality Settings - Image Menu](#)

[General Projector Specifications](#)

[Supported Video Display Formats](#)

Related tasks

[Focusing the Image Using the Focus and Distortion Buttons](#)

[Cleaning the Lens](#)

Solutions When the Image Brightness or Colors are Incorrect

If the projected image is too dark or light, or the colors are incorrect, try the following solutions:

- Press the **Color Mode** button on the remote control to try different color modes for the image and environment.
- Check your video source settings.
- Adjust the available settings on the Image menu for the current input source, such as **Brightness**, **Contrast**, **Tint**, **Advanced**, and **Color Saturation**.
- Make sure you selected the correct **Input Signal**, **Video Range**, **HDR 10 Setting**, and **HLG Setting** options on the Signal menu.
- Make sure you selected the correct **Gamma** or **RGBCMY** setting in the Image menu.
- Make sure all the cables are securely connected to the projector and your video device. If you connected long cables, try connecting shorter cables.
- Make sure the **Brightness Settings** options in the Settings menu are set correctly.
- Position the projector close enough to the screen.
- When using multiple projectors, make sure **Light Source Calibration** in the Reset menu is set correctly in all of the projectors. If light source calibration is performed only in some of the projectors, the white balance and the brightness level of the projected image may differ between the projectors.
- If the above solutions do not correct your image, try resetting all of the projector's settings using the Reset menu.

Parent topic: [Solving Image Problems](#)

Related references

[Input Signal Settings - Signal Menu](#)

[Image Quality Settings - Image Menu](#)

[Projector Feature Settings - Settings Menu](#)

[Projector Reset Options - Reset Menu](#)

Related tasks

[Changing the Color Mode](#)

[Running Light Source Calibration](#)

Solutions When Automatic Adjustments are not Applied Correctly

If you have problems with automatic adjustments not being applied correctly, try the following solutions:

- Be sure to wait at least 30 minutes after turning on the projector or turning off the **Shutter** setting before performing automatic adjustments. This gives the projector's temperature a chance to stabilize.
- Check that the protective plate is not installed on the built-in camera and that the camera area is clean.
- Depending on the lens you installed, automatic adjustments may not be available. If you installed one of these lenses, you cannot use the **Screen Matching** setting or the Tiling Assist feature in the Epson Projector Professional Tool software: ELPLX02, ELPLX02W, ELPLU04, or ELPLL08. If you installed one of these lenses, you cannot use the **Color Calibration** setting: ELPLX02, ELPLX02W, or ELPLL08.
- If you are projecting from an analog input source, the changing color and brightness of the image may cause automatic adjustments to not be applied correctly.
- Make sure that a powerful spotlight or source of strong natural light is not shining into the projection environment and interfering with automatic adjustments.
- Check that your image correction and image blending settings are within reasonable ranges. If the projection angle is very large, try turning off the **Geometry Correction** setting or reduce the projection angle. If you are using the **Edge Blending** setting, make sure the blending width is between 15 to 43%.
- If you see an error message during automatic adjustments, make a note of the error codes and contact Epson for support.

Parent topic: [Solving Image Problems](#)

Related references

[Projector Parts - Front/Top](#)

[Projector Parts - Side/Rear](#)

[Additional Projector Software and Manuals](#)

[Optional Equipment and Replacement Parts](#)

[Projector Feature Settings - Settings Menu](#)

[Where to Get Help](#)

Related tasks

[Shutting Off the Picture Temporarily](#)

[Cleaning the Projector Case](#)

[Running Light Source Calibration](#)

[Blending the Image Edges](#)

Related topics

[Matching Tint and Brightness \(Screen Matching\)](#)

Solving Projector or Remote Control Operation Problems

Check the solutions in these sections if you have problems operating the projector or remote control.

[Solutions to Projector Power or Shut-Off Problems](#)

[Solutions to Remote Control Problems](#)

[Solutions to Password Problems](#)

Parent topic: [Solving Problems](#)

Solutions to Projector Power or Shut-Off Problems

If the projector does not come on when you press the power button or it shuts off unexpectedly, try the following solutions:

- Make sure the power cord is securely connected to the projector and to a working electrical outlet.
- The projector's buttons may be locked for security. Unlock the buttons or use the remote control to turn on the projector.
- Make sure the power switch is turned on.
- If the projector's laser shuts off unexpectedly, it may have entered standby mode after a period of inactivity. Press the power button to wake the projector and adjust the **Sleep Mode** setting to change the sleep interval.

- If the power button on the remote control does not turn on the projector, check its batteries and make sure the **Remote Receiver** setting is turned on in the projector's menu, if available.
- If the power button on the remote control does not turn on the projector, check its batteries.
- If you have set the remote control to operating only a projector with a matching ID, set the **ID** switch to **Off**.
- If the projector lights turn on and off when you touch the power cord, the cord may have a poor contact with the electrical outlet. Unplug the power cord and plug it back in to check.
- The power cord may be defective. Try another power cord. If that doesn't work, disconnect the cord and contact Epson.
- If you see an error message indicating that the battery for your clock settings is running low, contact Epson for support.
- If you do not see error messages or other information displayed after turning on the projector, a sudden voltage drop, blackout, or power cut may have occurred. Turn off the power switch or unplug the power cord, wait at least 10 seconds, then turn on the power switch or plug in the power cord.

Parent topic: [Solving Projector or Remote Control Operation Problems](#)

Related references

[Projector Setup Settings - Extended Menu](#)

[Where to Get Help](#)

Related tasks

[Turning On the Projector](#)

[Turning Off the Projector](#)

[Unlocking the Projector's Buttons](#)

[Replacing the Remote Control Batteries](#)

[Setting the Remote Control ID](#)

Solutions to Remote Control Problems

If the projector does not respond to remote control commands, try the following solutions:

- Check that the remote control batteries are installed correctly and have power. If necessary, replace the batteries.
- Make sure you are operating the remote control within the reception angle and range of the projector.
- Make sure the projector is not warming up or shutting down.
- Check to see if a button on the remote control is stuck down, causing it to enter sleep mode. Release the button to wake the remote control up.

- If you enabled the remote control button lock, press and hold the i button for about 5 seconds to turn it off.
- Strong fluorescent lighting, direct sunlight, or infrared device signals may be interfering with the projector's remote receivers. Dim the lights or move the projector away from the sun or interfering equipment.
- Make sure the optional remote control cable set is not attached to the projector's **Remote** port. If you leave the cable connected to the port, the remote control cannot control the projector.
- If available, turn on one of the remote receivers in the projector's menu system, or check if all the remote receivers were turned off.
- If you assigned an ID number to the remote control to operate multiple projectors, you may need to check or change the ID setting (feature not available with all projectors).
- Make sure the **Control Communications** or **Extron XTP** setting in the Extended menu is set to **Off** if you are using the optional remote control cable set.
- If you lose the remote control, you can purchase another from an authorized Epson reseller.

Parent topic: [Solving Projector or Remote Control Operation Problems](#)

Related references

[Remote Control Operation](#)

[Projector Parts - Interface Ports](#)

[Projector Feature Settings - Settings Menu](#)

[Projector Setup Settings - Extended Menu](#)

Related tasks

[Replacing the Remote Control Batteries](#)

[Locking the Remote Control Buttons](#)

[Unlocking the Projector's Buttons](#)

[Setting the Remote Control ID](#)

Solutions to Password Problems

If you cannot enter or remember a password, try the following solutions:

- You may have turned on password protection without first setting a password. Try entering **0000** using the remote control.
- If you have entered an incorrect password too many times and see a message displaying a request code, write down the code and contact Epson. Do not attempt to enter the password again. Provide the request code and proof of ownership for assistance in unlocking the projector.

- If you set a Epson Web Control password and forgot the user ID or password, try entering the following:
 - User ID: **EPSONWEB**
 - Default password: **admin**
- If you set a Remote password (in Epson Web Control) and forgot the user ID or password, try entering the following:
 - User ID: **EPSONREMOTE**
 - Default password: **guest**
- If you lose the remote control, you cannot enter a password. Order a new one from Epson.

Parent topic: [Solving Projector or Remote Control Operation Problems](#)

Related concepts

[Password Security Types](#)

Solving Network Problems

Check the solutions in these sections if you have problems using the projector on a network.

[Solutions When Wireless Authentication Fails](#)

[Solutions When You Cannot Access the Projector Through the Web](#)

[Solutions When the Image Contains Static During Network Projection](#)

[Solutions When Network Alert E-Mails are Not Received](#)

Parent topic: [Solving Problems](#)

Solutions When Wireless Authentication Fails

If you cannot authenticate a wireless connection, try the following solutions:

- If the wireless settings are correct, but authentication fails, you may need to update the **Date & Time** settings in the Extended menu, if available.
- Make sure the **Wireless Mode** setting is set to **Wireless LAN On**.
- Check the Security settings and passphrase in the Network Configuration menu.
- Check the Event ID number displayed in the Info menu and check the link below to identify the problem.
- Make sure the connected device is on and operating properly.

Parent topic: [Solving Network Problems](#)

Related references

[Projector Setup Settings - Extended Menu](#)
[Event ID Code List](#)

Related tasks

[Selecting Wireless Network Settings Manually](#)
[Setting Up Wireless Network Security](#)

Solutions When You Cannot Access the Projector Through the Web

If you are unable to access the projector through a web browser, make sure you are using the correct ID and password, which are case sensitive.

- For the user ID, enter **EPSONWEB**. (You cannot change the user ID.)
- For the password, enter the password set in the projector's Network menu. The default password is **admin**.
- Make sure you have access to the network the projector is on.
- If you have problems while controlling the projector using Art-Net, any operations you perform using the projector remote control or control panel may cause your software operations to be applied incorrectly. To apply channel controls to the projector, set Channel 13 to **Cannot control**, then set it back to **Can control**.

Note: The user ID and password are case sensitive.

Parent topic: [Solving Network Problems](#)

Related concepts

[Password Security Types](#)

Related references

[Art-Net Channel Definitions](#)

Related tasks

[Controlling a Networked Projector Using a Web Browser](#)

Solutions When the Image Contains Static During Network Projection

If the projected image contains static during network projection, try the following solutions:

- Check for any obstacles between the access point, the computer, the mobile device, and the projector. If necessary, change their positions to improve communication. Also make sure that they are not too far apart; move them closer together and try to connect again.
- If the wireless connection is slow or your projected image contains noise, check for interference from other equipment, such as a Bluetooth device or microwave. Move the interfering device farther away or expand your wireless bandwidth.
- If the connection speed declines, reduce the number of connected devices.

Parent topic: [Solving Network Problems](#)

Solutions When Network Alert E-Mails are Not Received

If you do not receive an e-mail alerting you to problems with a projector over the network, try the following solutions:

- Make sure the projector is turned on and connected to the network correctly. (If an error shut down the projector, it cannot send an e-mail.)
- Make sure you set up the projector e-mail alert settings correctly on the projector's network Notifications menu or in the network software.
- Set the **Standby Mode** setting to **Communication On** so the network software can monitor the projector in standby mode.

Parent topic: [Solving Network Problems](#)

Related references

[Projector Setup Settings - Extended Menu](#)

Related tasks

[Setting Up Projector Network E-Mail Alerts](#)

Where to Get Help

If you need to contact Epson for technical support services, use the following support options.

Internet Support

Visit Epson's support website at epson.com/support (U.S.), epson.ca/support (Canada), or epson.com.jm/support (Caribbean) and select your product for solutions to common problems with your

projector. You can download utilities and documentation, get FAQs and troubleshooting advice, or e-mail Epson with your questions.

Speak to a Support Representative

To use the Epson PrivateLine Support service, call (800) 637-7661. This service is available for the duration of your warranty period. You may also speak with a projector support specialist by dialing (562) 276-4394 (U.S.) or (905) 709-3839 (Canada).

Support hours are 6 AM to 8 PM, Pacific Time, Monday through Friday and 7 AM to 4 PM, Pacific Time, Saturday.

Days and hours of support are subject to change without notice. Toll or long distance charges may apply.

Before you call, have the following information ready:

- Product name
- Product serial number (located on the bottom or rear of the projector, or in the menu system)
- Proof of purchase (such as a store receipt) and date of purchase
- Computer or video configuration
- Description of the problem

Purchase Supplies and Accessories

You can purchase screens, other optional accessories, and replacement parts from an Epson authorized reseller. To find the nearest reseller, call 800-GO-EPSON (800-463-7766) in the U.S. or 800-807-7766 in Canada. Or you can purchase online at epsonstore.com (U.S. sales) or epsonstore.ca (Canadian sales).

To purchase a replacement remote control, call (562) 276-4394 (U.S.) or (905) 709-3839 (for dealer referral in Canada).

Parent topic: [Solving Problems](#)

Technical Specifications

These sections list the technical specifications of your projector.

[General Projector Specifications](#)

[Projector Light Source Specifications](#)

[Remote Control Specifications](#)

[Projector Dimension Specifications](#)

[Projector Electrical Specifications](#)

[Projector Environmental Specifications](#)

[Projector Safety and Approvals Specifications](#)

[Safety and Approvals Specifications for Latin America](#)

[Supported Video Display Formats](#)

General Projector Specifications

Type of display	Poly-silicon TFT active matrix
Resolution	1920 × 1200 pixels (WUXGA)
Lens	F=1.8 to 2.3 Focal length: 36.0 to 57.3 mm
Color reproduction	Up to 1.07 billion colors
Brightness	Normal Power Consumption mode: White light output 20000 lumens (ISO 21118 standard) Color light output 20000 lumens Quiet/Extended Power Consumption mode: White light output 14000 lumens (ISO 21118 standard)
	Note: Color brightness (color light output) and white brightness (white light output) will vary depending on usage conditions. Color light output measured in accordance with IDMS 15.4; white light output measured in accordance with ISO 21118.
Contrast ratio	Over 2,500,000:1 (dynamic on), 2000:1 (native)

Image size (in native aspect ratio)	60 inches (1.52 m) to 1000 inches (25.4 m)
Projection distance (in native aspect ratio)	78.3 inches (1.99 m) to 2190.2 inches (55.63 m)
Projection methods	Front, rear, ceiling-mounted
Optical aspect ratio (width-to-height)	16:10
Focus adjustment	Powered
Zoom adjustment	Powered
Zoom ratio (Tele-to-Wide)	1:1.61
Noise level	45 dB (Normal Power Consumption mode) 38 dB (Quiet Power Consumption mode)
Keystone correction angle	± 44° vertical (manual) ± 30° horizontal (manual)
USB Type B port compatibility	USB 1.1 and 2.0 compliant for firmware update or copying menu settings
USB Type A port compatibility	One USB 1.1 and 2.0 compliant port for firmware update or copying menu settings, or for use as a DC Out 900mA port on HDMI/DVI-D interface board

Parent topic: [Technical Specifications](#)

Projector Light Source Specifications

Type	Laser diode
Light source output power	Up to 488 W
Wavelength	450 to 460 nm

Light source life (approximate)	Normal/Quiet Light Source Mode: Up to about 20000 hours Extended Light Source Mode: Up to about 43000 hours
---	--

Note: Turn off this product when not in use to prolong the life of the projector. Laser life will vary depending upon mode selected, environmental conditions, and usage. Brightness decreases over time.

Parent topic: [Technical Specifications](#)

Remote Control Specifications

Reception range	98.4 feet (30 m)
Batteries	Two alkaline or manganese AA

Parent topic: [Technical Specifications](#)

Projector Dimension Specifications

Height (excluding feet)	11.02 inches (280 mm)
Width	24.4 inches (620 mm)
Depth	28.3 inches (720 mm)
Weight	Pro L20000UNL: 109.3 lb (49.6 kg) Pro L20002UNL: 110.9 lb (50.3 kg)

Parent topic: [Technical Specifications](#)

Projector Electrical Specifications

Rated frequency	50/60 Hz
------------------------	----------

Power supply	<p>110 to 120 V AC ±10% : 12.0 A</p> <p>220 to 240 V AC ±10% : 9.7 A</p> <p>Note: 110 to 120 V AC power is for service purposes; use 220 to 240 V AC power for normal operation.</p>
Power consumption (110 to 120 V)	<p>Operating: Normal Power Consumption mode: 1178 W</p> <p>Standby: 0.5 W (Communication Off), 2 W (Communication On)</p> <p>Note: 110 to 120 V AC power is for service purposes; use 220 to 240 V AC power for normal operation.</p>
Power consumption (220 to 240 V)	<p>Operating: Normal Power Consumption mode: 1860 W</p> <p>Standby: 0.5 W (Communication Off), 2 W (Communication On)</p>

Parent topic: [Technical Specifications](#)

Projector Environmental Specifications

Temperature	<p>Operating: Up to 4921 feet (1500 m): 32 to 122 °F (0 to 50 °C) 4921 feet (1500 m) to 10000 feet (3048 m): 32 to 113 °F (0 to 45 °C)</p> <p>Storage: 14 to 140 °F (–10 to 60 °C)</p>
Humidity (relative, non-condensing)	<p>Operating: 20 to 80%</p> <p>Storage: 10 to 90%</p>
Operating altitude	<p>Up to 4921 feet (1500 m)</p> <p>Up to 10000 feet (3048 m) with High Altitude Mode enabled</p>

Parent topic: [Technical Specifications](#)

Related references

[Projector Setup Settings - Extended Menu](#)

Projector Safety and Approvals Specifications

United States

FCC Part 15B Class A (DoC)

UL60950-1 2nd edition/UL62368-1 2nd edition (cTUVus Mark)

Canada

ICES-003 Class A

CSA C22.2 No. 60950-1-07/CSA C22.2 No. 62368-1-14 (cTUVus Mark)

Parent topic: [Technical Specifications](#)

Safety and Approvals Specifications for Latin America

Notice for Argentina

WLAN Module Model: WLU5000-D101 (RoHS)

Brand: EPSON

 CNC ID: C16265

Notice for Mexico

Operation is subject to the following two conditions: (1) this device may not cause harmful interference, and (2) this device must accept any interference received, including interference that may cause undesired operation of the device.

WLAN Module Model: WLU5000-D101 (RoHS)

Brand: EPSON

IFT Certification Number: RCPEPWL16-0829

Notice for Paraguay

Imported by:

Fastrax, S.A.

Av. Perú esq. Río de Janeiro, Barrios Las Mercedes, Asunción, Paraguay

Imported by:

Sol Control S.R.L.

Av. Gral. Bernardino Caballero 810 esq. Celsa Speratti, Asunción, Paraguay

Notice for Peru

Product Manufacturer: Seiko Epson Corporation

Address: 3-3-5 Owa Suwa-shi, Nagano-Ken 392-8502, Japan

Brand: EPSON

Product Model: Pro L20000UNL/L20002UNL

This product uses the following network module:

WLAN Module Model: WLU5000-D101 (RoHS)

FCC ID: BKMAE-WLU5000

Parent topic: [Technical Specifications](#)

Supported Video Display Formats

For best results, your computer's monitor port or video card resolution should be set to display in the projector's native resolution. However, your projector includes Epson's SizeWise chip that supports other computer display resolutions, so your image will be resized to fit automatically.

Your computer's monitor port or video card refresh rate (vertical frequency) must be compatible with the projector. (See your computer or video card manual for details.)

The table here lists the compatible refresh rate and resolution for each compatible video display format.

Display format	Refresh rate (in Hz)	Resolution (in pixels)
Computer signals (analog RGB)		
VGA	60/72/75/85	640 × 480
SVGA	60/72/75/85	800 × 600
XGA	60/70/75/85	1024 × 768

Display format	Refresh rate (in Hz)	Resolution (in pixels)
WXGA	60	1280 × 768
	60/75/85	1280 × 800
	60	1366 × 768
WXGA+	60/75/85	1440 × 900
WXGA++	60	1600 × 900
SXGA	70/75/85	1152 × 864
	60/75/85	1280 × 960
	60/75/85	1280 × 1024
SXGA+	60/75	1400 × 1050
WSXGA ¹	60	1680 × 1050
UXGA	60	1600 × 1200
1920 × 1080	50/60	1920 × 1080
WUXGA ²	60	1920 × 1200
SDTV (480p)	59.94	720 × 480
SDTV (576p)	50	720 × 576
HDTV (720p)	50/59.94/60	1280 × 720
HDTV (1080p)	50/59.94/60	1920 × 1080
Component video		
SDTV (480i/480p)	59.94	720 × 480
SDTV (576i/576p)	50	720 × 576
HDTV (720p)	50/59.94/60	1280 × 720
HDTV (1080i)	50/59.94/60	1920 × 1080
DVI-D, HDMI, and HDBaseT input signals		
VGA	60	640 × 480
SVGA	60	800 × 600
XGA	60	1024 × 768

Display format	Refresh rate (in Hz)	Resolution (in pixels)
WXGA	60	1280 × 800
	60	1366 × 768
WXGA+	60	1440 × 900
WXGA++	60	1600 × 900
WSXGA+	60	1680 × 1050
SXGA	60	1280 × 960
	60	1280 × 1024
SXGA+	60	1400 × 1050
UXGA	60	1600 × 1200
1920 × 1080	50/60	1920 × 1080
WUXGA ²	60	1920 × 1200
QXGA ³	60	2048 × 1536
WQHD ³	60	2560 × 1440
WQXGA ^{2, 3}	60	2560 × 1600
SDTV (480i/480p)	59.94	720 × 480
SDTV (576i/576p)	50	720 × 576
HDTV (720p)	50/59.94/60	1280 × 720
HDTV (1080i)	50/59.94/60	1920 × 1080
HDTV (1080p) ³	23.98/24/29.97/30/50/59.94/60	1920 × 1080
4K×2K ^{2, 3}	23.98/24/25/29.97/30	3840 × 2160
4K×2K ³	50/59.94/60	3840 × 2160
4K×2K (SMPTE) ^{2, 3}	23.98/24	4096 × 2160
4K×2K (SMPTE) ³	50/59.94/60	4096 × 2160
SDI input signals (all 10 bit)		
SDTV (480i)	59.94 (SD-SDI mode ⁴)	720 × 480
SDTV (576i)	50 (SD-SDI mode ⁴)	720 × 576

Display format	Refresh rate (in Hz)	Resolution (in pixels)
HDTV (720p)	50/59.94/60 (HD-SDI mode ⁴)	1280 × 720
HDTV (1080i)	50/59.94/60 (HD-SDI mode ⁴)	1920 × 1080
HDTV (1080p)	23.98/24/25/29.97/30 (HD-SDI mode ⁴)	1920 × 1080
HDTV (1080p) ⁶	50/59.94/60 (3G-SDI mode; Level A ⁴)	1920 × 1080
HDTV (1080p) ⁶	23.98/24/25/29.97/30 (3G-SDI mode; Level A ⁵)	1920 × 1080
HDTV (1080i)	50/59.94/60 (3G-SDI mode; Level A ⁵)	1920 × 1080

¹ Compatible only when **Wide** is selected as the **Resolution** setting

² Compatible only with VESA CVT-RB (Reduced Blanking) input signal

³ HDMI or HDBaseT input only

⁴ Compatible with YPbPr 4:2:2 input signals

⁵ Compatible with RGB4:4:4 input signals

⁶ Supports HDR (HDR10 and HLG)

Parent topic: [Technical Specifications](#)

Related references

[Input Signal Settings - Signal Menu](#)

Notices

Check these sections for important notices about your projector.

[Recycling](#)

[Important Safety Information](#)

[Important Safety Instructions](#)

[List of Safety Symbols \(corresponding to IEC60950-1 A2\)](#)

[Manufacturer and Importer Address](#)

[FCC Compliance Statement](#)

[Binding Arbitration and Class Waiver](#)

[Trademarks](#)

[Copyright Notice](#)

Recycling

Epson offers a recycling program for end of life products. Please go to [this site](#) for information on how to return your products for proper disposal.

Parent topic: [Notices](#)

Important Safety Information

Caution: Never look into the projector lens when the laser is turned on; the bright light can damage your eyes. Never let children look into the lens when it is on. Never open any cover on the projector, except the filter covers. Dangerous electrical voltages inside the projector can severely injure you. Except as specifically explained in this *User's Guide*, do not attempt to service this product yourself. Refer all servicing to qualified service personnel.

Warning: The projector and its accessories come packaged in plastic bags. Keep plastic bags away from small children to avoid any risk of suffocation.

Parent topic: [Notices](#)

Important Safety Instructions

Follow these safety instructions to avoid damage to the product and serious or fatal bodily injury:

Setup and operation

- If an error occurs in the projector, turn off the power and unplug the projector immediately. Continuing to use the projector could result in an electric shock, fire, or visual impairment. Contact Epson support.
- Use of controls or adjustments or performance of procedures other than those specified herein may result in hazardous radiation exposure.
- The projector and its accessories come packaged in plastic bags. Keep plastic bags away from small children to avoid any risk of suffocation.
- Do not look into the lens when the projector is on. The bright light can damage your eyes. Avoid standing in front of the projector so the bright light does not shine into your eyes.
- Possibly hazardous optical radiation emitted from this product. Do not direct or reflect the laser light toward people or reflective objects. Do not look at the operating light source or expose your skin to it. Eye and/or skin injury may result if these instructions are not followed.
- Do not look into the lens using optical devices, such as a magnifying glass or telescope. This could cause visual impairment.
- Do not apply optical devices, such as a magnifying glass or reflector, to the projected image. Using the projector in this way may result in physical harm, fire, or an accident.
- When turning on the projector at a distance using the remote control, make sure no one is looking into the lens.
- Do not place the projector where the cord can be walked on. This may result in fraying or damage to the plug.
- Do not operate the projector in a closed-in cabinet unless proper ventilation is provided.
- Do not block the slots and openings in the projector case. They provide ventilation and prevent the projector from overheating. Do not operate the projector on a sofa, rug, or other soft surface, or set it on top of loose papers. Do not cover the projector with a blanket, curtain, or tablecloth. If you are setting up the projector near a wall, leave at least 7.9 inches (20 cm) of space between the wall and the projector.
- Do not allow small children to operate the projector. Children must be accompanied by an adult.
- Before using the projector, make sure there is nothing in the area that could reflect the projected image.
- If the projector is mounted on a ceiling or wall, it should be installed by qualified technicians using mounting hardware designed for use with this projector.
- When installing or adjusting a ceiling or wall mount, do not use adhesives to prevent the screws from loosening and do not use oils or lubricants. This may cause the projector case to crack and the

projector to fall from its ceiling mount. This could cause serious injury to anyone under the mount and could damage the projector.

- Do not use the projector near water, sources of heat, high-voltage electrical wires, or sources of magnetic fields.
- Use the type of power source indicated on the projector. Use of a different power source may result in fire or electric shock. If you are not sure of the power available, consult your dealer or power company.
- Place the projector near a wall outlet where the plug can be easily unplugged.
- Take the following precautions when handling the plug: Do not hold the plug with wet hands. Do not insert the plug into a dusty outlet. Insert the plug firmly into the outlet. Do not pull the power cord when disconnecting the plug; always be sure to hold the plug when disconnecting it. Do not overload wall outlets, extension cords, or power strips. Failure to comply with these precautions could result in fire or electric shock.
- Never allow objects of any kind to enter any openings in the projector. Do not leave objects, especially flammable objects, near the projector. Never spill liquid of any kind into the projector.
- Never open any covers on the projector except as specifically explained in this manual. Never attempt to disassemble or modify the projector. Refer all repairs to qualified service personnel.
- Unplug the projector from the wall outlet and refer servicing to qualified service personnel under the following conditions: if it does not operate normally when you follow the operating instructions, or exhibits a distinct change in performance; if smoke, strange odors, or strange noises come from the projector; if the power cord or plug is damaged or frayed; if liquid or foreign objects get inside the projector, or if it has been exposed to rain or water; if it has been dropped or the housing has been damaged.
- Place the projector near a wall outlet where the plug can be easily unplugged.
- Do not touch the plug during an electrical storm. Otherwise, you may receive an electric shock.
- Do not use the projector where it may be exposed to rain, water, or excessive humidity.
- Do not use the projector where flammable or explosive gases may be present.
- Do not use or store the projector or remote control in a hot location, such as near a heater, in direct sunlight, or in a closed vehicle.
- Do not place the source of an open flame, such as a lit candle, on or near the projector.
- Do not block the lens during projection using a book or any other object. This could damage the projector or cause a fire.
- Do not modify the power cord. Do not place heavy objects on top of the power cord or bend, twist, or pull it excessively. Keep the power cord away from hot electrical appliances.

- Always attach the lens cover to the lens when not using the projector to prevent the lens from becoming dirty or damaged.
- If you use the projector in a country other than where you purchased it, use the correct power cord for that country.
- Do not stand on the projector or place heavy objects on it.
- Do not use the projector outside of the required temperature range below:
32 to 122 °F (0 to 50 °C) at an altitude of 4921 feet (1500 m) or less, and 32 to 113 °F (0 to 45 °C) at an altitude of 4925 to 10000 feet (1501 to 3048 m)
Doing so may cause an unstable display and could lead to projector damage. Do not use or store the projector where it may be exposed to sudden changes in temperature.
- Do not place anything that can become warped or damaged by heat near the exhaust vents. Do not bring your hands or face close to the vents while projection is in progress. Do not bring your face close to the projector while it is in use.
- Do not place the projector on an unstable cart, stand, or table.

Maintenance, storage, and transportation

- Unplug the projector from the wall outlet and allow to cool before cleaning. Use a dry cloth (or, for stubborn dirt or stains, a moist cloth that has been wrung dry) for cleaning. Do not use liquid or aerosol cleaners, any sprays containing flammable gas, or solvents such as alcohol, paint thinner, or benzene.
- Do not open the projector's case. The projector contains a high-powered laser.
- Unplug the projector from the wall outlet and allow to cool before cleaning. Use a dry cloth (or, for stubborn dirt or stains, a moist cloth that has been wrung dry) for cleaning. Do not use liquid or aerosol cleaners, any sprays containing flammable gas, or solvents such as alcohol, paint thinner, or benzene.
- Do not attempt to disassemble or modify the projector. The projector contains a high-power laser component. Serious injury could result.
- You may need to clean the air filter and vent. A clogged air filter or vent can block ventilation needed to cool the projector. Do not use canned air, or the gases may leave a residue.
- Do not store the projector outdoors for an extended length of time.
- Do not use or store the projector where it may be exposed to smoke, steam, corrosive gases, excessive dust, vibration, or shock.
- Unplug the projector when it will not be used for extended periods.
- Do not store the projector outside of the required temperature range of 14 to 140 °F (–10 to 60 °C) or in direct sunlight for long periods of time. Doing so may cause damage to the case.

- Before you move the projector, make sure its power is turned off, the plug is disconnected from the outlet, and all cables are disconnected.
- When disposing of the projector, do not disassemble it. Dispose of the projector in accordance with your local or national laws and regulations.

[Laser Safety Information](#)

[Laser Safety Labels](#)

[Hazard Distance \(HD\)](#)

[Typical Setup Configurations \(U.S. Only\)](#)

Parent topic: [Notices](#)

Laser Safety Information

This projector is a Class 1/RG3 laser product that complies with the IEC60825-1 international standard for lasers. This projector contains a high-powered laser component and the following precautions should be taken when operating the projector to avoid injury or damage:

- Do not enter the exclusion zone that is determined by the light beam Hazard Distance (HD). See the link below for hazard distance information.
- Never open any covers on the projector except as specifically explained in this manual. Never attempt to disassemble or modify the projector.
- All installations and repairs of this projector must be done by a licensed service personnel.
- The projector generates high amounts of heat. Do not place flammable or combustible objects around the projector, especially in front of the lens.

Note: See the link below for additional safety laser cautions and other general safety instructions.

Parent topic: [Important Safety Instructions](#)

Related references

[Laser Safety Labels](#)

[Hazard Distance \(HD\)](#)

[Typical Setup Configurations \(U.S. Only\)](#)

Laser Safety Labels

Labels are attached to the projector to indicate the level of risk when operating or servicing the projector.

This product is in conformity with performance standards for laser products under 21CFR 1040, except with respect to those characteristics authorized by Variance Number 2018-V-3295 effective on November 21, 2018.

Certification labels (located on side of projector)

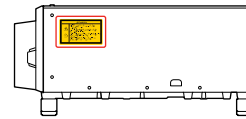
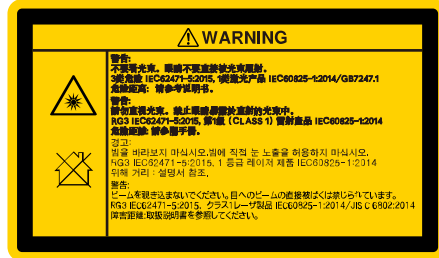
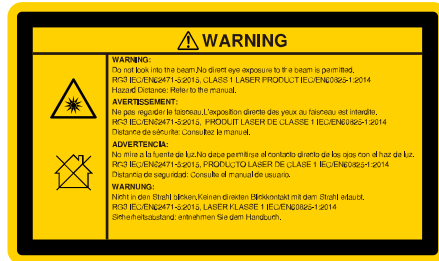

WARNING

RISK GROUP 3: IEC 62471:2006/LIPs Guidance dated Feb. 18, 2015

Possibly hazards optical radiation emitted from this product.

Comply with 21 CFR Part 1040 except with respect to those characteristics authorized by VARIANCE NUMBER 2018-V-3295 Dated November 21, 2018



WARNING: Do not look into the beam. No direct eye exposure to the beam is permitted.
RG3 IEC/EN62471-5:2015, CLASS 1 LASER PRODUCT IEC/EN60825-1:2014
Hazard Distance: Refer to the manual.

Manufacturer identification label (located on back of projector)



WARNING: Never open any covers on the projector expect as specifically explained in the projector manual.

Dangerous electrical voltages inside the projector can severely injure you.

Protective housing label (located inside of projector)



CAUTION/DANGER: CLASS 4 LASER RADIATION WHEN OPEN

AVOID EYE OR SKIN EXPOSURE TO DIRECT OR SCATTERED RADIATION

Parent topic: [Important Safety Instructions](#)

Hazard Distance (HD)

Hazard Distance (HD) is the distance measured from the projection lens at which the intensity of the energy per surface unit becomes lower than the applicable exposure limit on the cornea or on the skin. To prevent risk of eye or skin exposure, no person should enter the area within the HD of the projector during operation.

The HD depends on the number of lumens produced by the projector, the size of the panel(s) used, and the type of lens installed. HD values are provided in the table below.

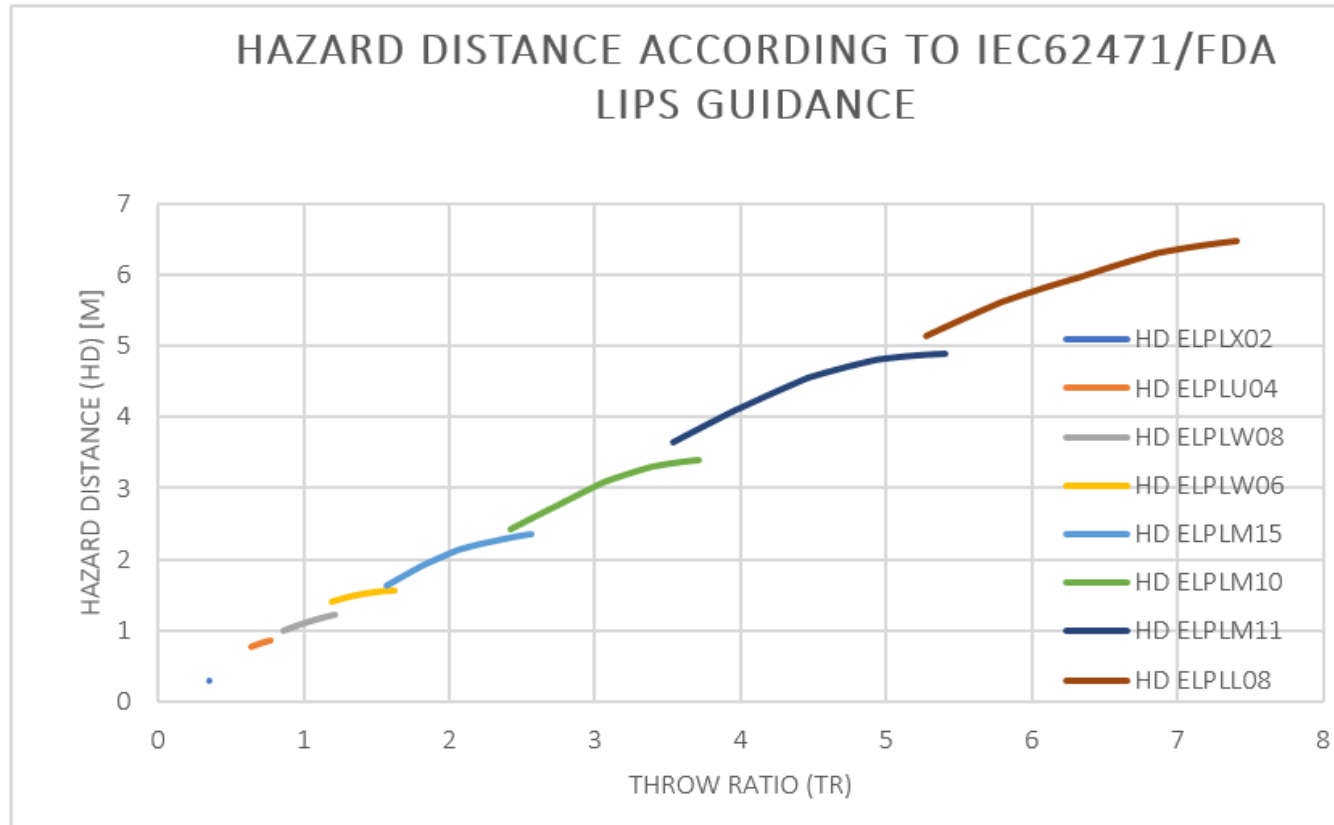

To protect untrained end users (such as cinema visitors or spectators), the installation shall comply with the following installation requirements: Operators shall control access to the beam within the hazard distance or install the product at the height that will prevent spectators from being in the hazard distance. Radiation levels in excess of the limits will not be permitted at any point less than 2.0 meters (SH) above any surface upon which persons other than operators, performers, or employees are permitted to stand or less than 1.0 meter (SH) lateral separation from any place where such persons are permitted to be. In environments where unrestrained behavior is reasonably foreseeable, the minimum separation height should be greater than or equal to 3.0 meters to prevent potential exposure, for example by an individual sitting on another individual's shoulders, within the HD.

These values are minimum values and are based on the guidance provided in IEC 62471-5:2015 section 6.6.5.

The installer must understand the risk and apply protective measures based upon the hazard distance as indicated on the label and in the user information. Installation method, separation height, barriers, detection systems or other applicable control measures shall prevent spectator access to the projected light within the hazard distance.

For example, projectors that have a HD greater than 1 meter and emit light into an uncontrolled area where persons may be present should be positioned in accordance with “the fixed projector installation” parameters, resulting in a HD that does not extend into the audience area unless the beam is at least 2.0 meters above the floor level. In environments where unrestrained behavior is reasonably foreseeable, the minimum separation height should be greater than or equal to 3.0 meters to prevent potential exposure, for example by an individual sitting on another individual’s shoulders, within the HD. Sufficiently large separation height may be achieved by mounting the image projector on the ceiling or through the use of physical barriers.

U.S.A. Market Only:

This projector is a Class 1/RG3 laser product that complies with FDA Title 21 CFR 1040. This projector can only be installed by qualified service personnel with an approved laser light show variance. Only trained users with a valid laser light show variance are allowed access to the area where the projector is installed. The area should be secured and access to it controlled by the owner of the location. Installers must have a valid variance for production of Class IIIb and IV laser light shows and/or for incorporation of the RG3 LIPs into their shows. Dealers, distributors, and end-users are also required to obtain a valid laser light show variance.

If you are renting out this projector, it should only be delivered to parties that demonstrates that they have a valid variance in effect at the time of delivery that permits them to produce laser light shows incorporating this projector.

For a laser-illuminated projector (LIP) installed in the U.S.A. market, the following limits apply. For installations other than in cinema theaters, an LIP shall be installed at a height vertically above the floor such that the bottom plane of the hazard zone shall be no lower than 3.0 meters above the floor. Horizontal clearance to the hazard zone shall be 2.5 meters. Any human access horizontally to the hazard zone, if applicable, shall be restricted by barriers. If human access is possible in an unsupervised environment, the horizontal or vertical clearances shall be increased to prevent exposure to the RG3 hazard zone.

Install one or more readily accessible controls to immediately terminate LIP projection light. The power input at the projector side is considered as a reliable disconnect device. When required to switch off the projector, disconnect the power cord at the projector side. In case the power input at the projector side is not accessible (such as in a truss mount), the socket outlet supplying the projector shall be installed nearby the projector and be easily accessible, or a readily accessible general disconnect device shall be

incorporated in the fixed wiring. Additionally, the projection light can be turned off by pressing the **Shutter** button on the projector's control panel or remote control.

Parent topic: [Important Safety Instructions](#)

Typical Setup Configurations (U.S. Only)

Show - Elevation View

- Projector mounted from the ceiling.
- 9.8 ft (3 m) minimum vertical clearance from accessible floor to bottom plane of Hazard Zone.
- Hazard zone effectively isolated from human access with physical barriers and warning signage.

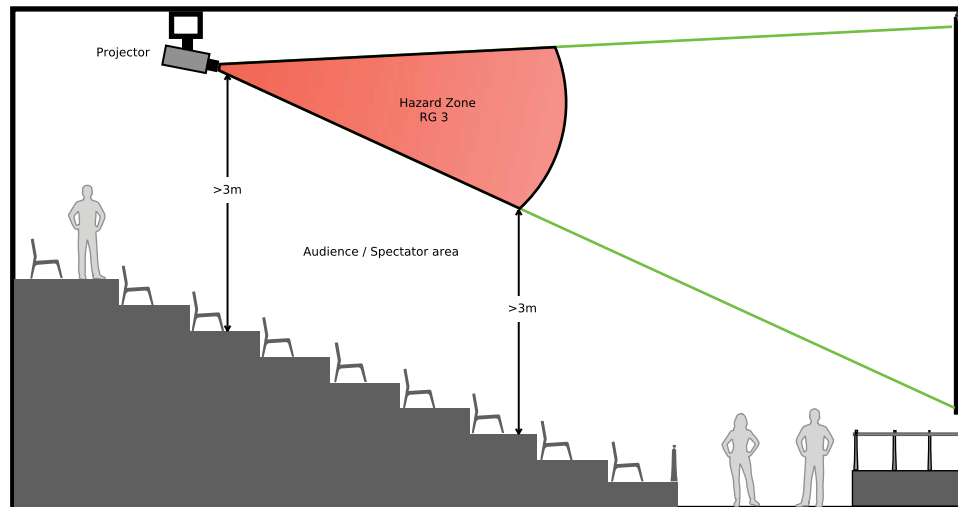

Note: Typical layout concept; not necessarily to scale.

Show - Elevation View - Typical Temporary Cinema Application

- Projector positioned at rear of venue.
- Front projection over audience onto projection surface.
- 8.2 ft (2.5 m) minimum lateral distance from accessible area to Hazard Zone.
- 9.8 ft (3 m) minimum vertical clearance from any accessible floor to bottom plane of Hazard Zone.

- Controlled Area** prevents human access with physical barriers and warning signage except authorized personnel.
- Audience allowed only outside the controlled area.

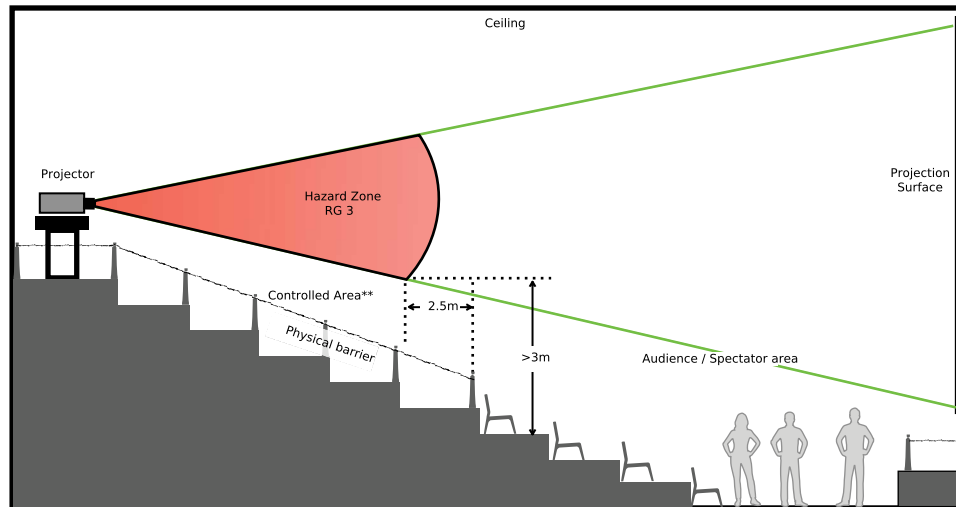

Note: Typical layout concept; not necessarily to scale.

Show - Plan View - Typical Temporary Cinema Application

- Projector positioned at rear of venue.
- Front projection over audience onto projection surface.
- 8.2 ft (2.5 m) minimum lateral distance from accessible area to Hazard Zone.
- Controlled Area** prevents human access with physical barriers and warning signage except authorized personnel.

- Audience allowed only outside the controlled area.

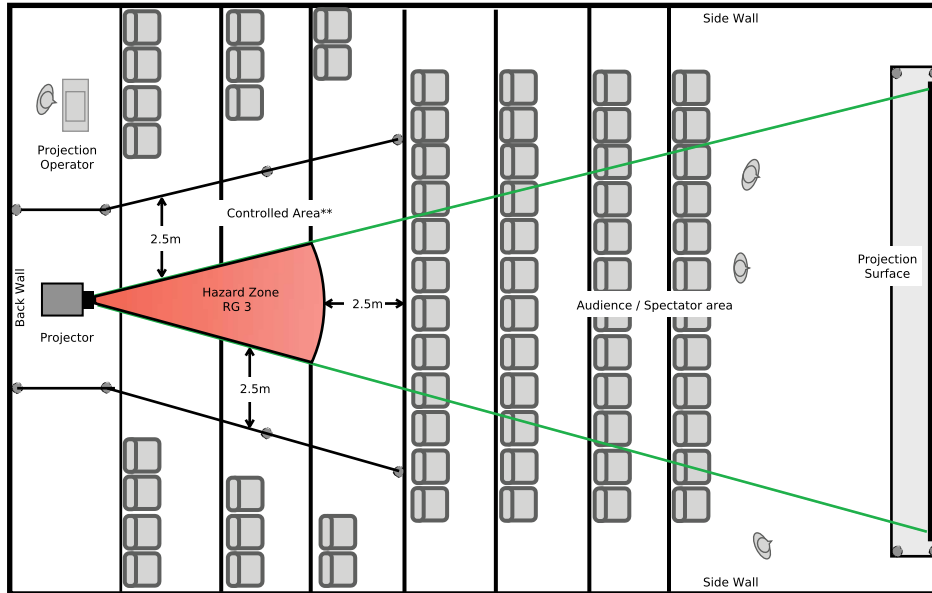







Note: Typical layout concept; not necessarily to scale.







Parent topic: [Important Safety Instructions](#)





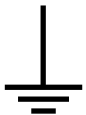

List of Safety Symbols (corresponding to IEC60950-1 A2)



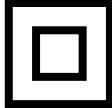

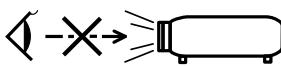

The following table lists the meaning of the safety symbols labeled on the equipment.

No.	Symbol	Approved Standards	Description
1	⏻	IEC60417 No.5007	"ON" (power) To indicate connection to the mains.

No.	Symbol	Approved Standards	Description
2		IEC60417 No.5008	"OFF" (power) To indicate disconnection from the mains.
3		IEC60417 No.5009	Stand-by To identify the switch or switch position by means of which part of the equipment is switched on in order to bring it into the stand-by condition.
4		ISO7000 No.0434B IEC3864-B3.1	Caution To identify general caution when using the product.
5		IEC60417 No.5041	Caution, hot surface To indicate that the marked item can be hot and should not be touched without taking care.
6		IEC60417 No.6042 ISO3864-B3.6	Caution, risk of electric shock To identify equipment that has risk of electric shock.
7		IEC60417 No.5957	For indoor use only To identify electrical equipment designed primarily for indoor use.
8		IEC60417 No.5926	Polarity of DC power connector To identify the positive and negative connections (the polarity) on a piece of equipment to which a DC power supply may be connected.

No.	Symbol	Approved Standards	Description
9		—	Same as No. 8
10		IEC60417 No.5001B	Battery, general On battery powered equipment. To identify a device for instance a cover for the battery compartment, or the connector terminals.
11		IEC60417 No.5002	Positioning of cell To identify the battery holder itself and to identify the positioning of the cell(s) inside the battery holder.
12		—	Same as No. 11
13		IEC60417 No.5019	Protective earth To identify any terminal which is intended for connection to an external conductor for protection against electric shock in case of a fault, or the terminal of a protective earth electrode.
14		IEC60417 No.5017	Earth To identify an earth (ground) terminal in cases where neither the symbol No.13 is explicitly required.
15		IEC60417 No.5032	Alternating current To indicate on the rating plate that the equipment is suitable for alternating current only; to identify relevant terminals.

No.	Symbol	Approved Standards	Description
16		IEC60417 No.5031	Direct current To indicate on the rating plate that the equipment is suitable for direct current only; to identify relevant terminals.
17		IEC60417 No.5172	Class II equipment To identify equipment meeting the safety requirements specified for Class II equipment according to IEC 61140.
18		ISO 3864	General prohibition To identify actions or operations that are prohibited.
19		ISO 3864	Contact prohibition To indicate injury that could occur due to touching a specific part of the equipment.
20		—	Never look into the optical lens while the projector is on.
21		—	To indicate that the marked item don't place anything on projector.
22		ISO3864 IEC60825-1	Caution, laser radiation To indicate the equipment has a laser radiation part.
23		ISO 3864	Disassembly prohibition To indicate a risk of injury, such as electric shock, if the equipment is disassembled.

No.	Symbol	Approved Standards	Description
24		IEC60417 No. 5266	Standby, partial standby To indicate that part of the equipment is in the ready status.
25		ISO3864 IEC60417 No. 5057	Caution, movable parts To indicate that you must keep away from movable parts according to protection standards.
26		IEC60417-6056	Caution (Moving Fan Blades) To indicate that you must keep away from moving fan blades.
27		IEC60417-6043	Caution (Sharp Corners) To indicate that you must not touch sharp corners.
28		—	To indicate that looking into the lens while projecting is prohibited.
29		ISO7010 No. W027 ISO3864	Warning, light emission (UV, visible light, IR, etc.) When you are close to the light emissions, be careful not to injure your eyes or skin.
30		IEC60417 No. 5109	Usage prohibition in residential areas To indicate that this is an electrical device or a device that is not suitable for use in residential areas.

Parent topic: [Notices](#)

Manufacturer and Importer Address

Manufacturer

Name: Seiko Epson Corporation

Address: 3-5, Owa 3-chome, Suwa-shi, Nagano-ken 392-8502 Japan

Telephone: 81-266-52-3131

Importer

Name: Epson America, Inc.

Address: 3840 Kilroy Airport Way, Long Beach, CA 90806 U.S.A.

Telephone: (800) 463-7766

Parent topic: [Notices](#)

FCC Compliance Statement

For United States Users

This equipment has been tested and found to comply with the limits for a Class A digital device, pursuant to Part 15 of the FCC Rules. These limits are designed to provide reasonable protection against harmful interference when the equipment is operated in a commercial environment. This equipment generates, uses, and can radiate radio frequency energy and, if not installed and used in accordance with the instructions, may cause harmful interference to radio communications. Operation of this equipment in a residential area is likely to cause harmful interference in which case the user will be required to correct the interference at his own expense.

For Canadian Users

CAN ICES-3(A)/NMB-3(A)

Parent topic: [Notices](#)

Binding Arbitration and Class Waiver

1. DISPUTES, BINDING INDIVIDUAL ARBITRATION, AND WAIVER OF CLASS ACTIONS AND CLASS ARBITRATIONS

1.1 **Disputes.** The terms of this Section 1 shall apply to all Disputes between you and Epson. The term "Dispute" is meant to have the broadest meaning permissible under law and includes any dispute, claim, controversy or action between you and Epson arising out of or relating to this Agreement, Epson branded products (hardware and including any related software), or other transaction involving you and Epson, whether in contract, warranty, misrepresentation, fraud, tort, intentional tort, statute, regulation, ordinance, or any other legal or equitable basis. "DISPUTE" DOES NOT INCLUDE IP CLAIMS, or more specifically, a claim or cause of action for (a) trademark infringement or dilution, (b) patent infringement, (c) copyright infringement or misuse, or (d) trade secret misappropriation (an "IP Claim"). You and Epson

also agree, notwithstanding Section 1.6, that a court, not an arbitrator, may decide if a claim or cause of action is for an IP Claim.

1.2 Binding Arbitration. You and Epson agree that all Disputes shall be resolved by binding arbitration according to this Agreement. **ARBITRATION MEANS THAT YOU WAIVE YOUR RIGHT TO A JUDGE OR JURY IN A COURT PROCEEDING AND YOUR GROUNDS FOR APPEAL ARE LIMITED.**

Pursuant to this Agreement, binding arbitration shall be administered by JAMS, a nationally recognized arbitration authority, pursuant to its code of procedures then in effect for consumer related disputes, but excluding any rules that permit joinder or class actions in arbitration (for more detail on procedure, see Section 1.6 below). You and Epson understand and agree that (a) the Federal Arbitration Act (9 U.S.C. §1, et seq.) governs the interpretation and enforcement of this Section 1, (b) this Agreement memorializes a transaction in interstate commerce, and (c) this Section 1 shall survive termination of this Agreement.

1.3 Pre-Arbitration Steps and Notice. Before submitting a claim for arbitration, you and Epson agree to try, for sixty (60) days, to resolve any Dispute informally. If Epson and you do not reach an agreement to resolve the Dispute within the sixty (60) days, you or Epson may commence an arbitration. Notice to Epson must be addressed to: Epson America, Inc., ATTN: Legal Department, 3840 Kilroy Airport Way, Long Beach, CA 90806 (the "Epson Address"). The Dispute Notice to you will be sent to the most recent address Epson has in its records for you. For this reason, it is important to notify us if your address changes by emailing us at EAlegal@ea.epson.com or writing us at the Epson Address above. Notice of the Dispute shall include the sender's name, address and contact information, the facts giving rise to the Dispute, and the relief requested (the "Dispute Notice"). Following receipt of the Dispute Notice, Epson and you agree to act in good faith to resolve the Dispute before commencing arbitration.

1.4 Small Claims Court. Notwithstanding the foregoing, you may bring an individual action in the small claims court of your state or municipality if the action is within that court's jurisdiction and is pending only in that court.

1.5 WAIVER OF CLASS ACTIONS AND CLASS ARBITRATIONS. YOU AND EPSON AGREE THAT EACH PARTY MAY BRING DISPUTES AGAINST THE OTHER PARTY ONLY IN AN INDIVIDUAL CAPACITY, AND NOT AS A PLAINTIFF OR CLASS MEMBER IN ANY CLASS OR REPRESENTATIVE PROCEEDING, INCLUDING WITHOUT LIMITATION FEDERAL OR STATE CLASS ACTIONS, OR CLASS ARBITRATIONS. CLASS ACTION LAWSUITS, CLASS-WIDE ARBITRATIONS, PRIVATE ATTORNEY-GENERAL ACTIONS, AND ANY OTHER PROCEEDING WHERE SOMEONE ACTS IN A REPRESENTATIVE CAPACITY ARE NOT ALLOWED. ACCORDINGLY, UNDER THE ARBITRATION PROCEDURES OUTLINED IN THIS SECTION, AN ARBITRATOR SHALL NOT COMBINE OR CONSOLIDATE MORE THAN ONE PARTY'S CLAIMS WITHOUT THE WRITTEN CONSENT OF ALL AFFECTED PARTIES TO AN ARBITRATION PROCEEDING.

1.6 Arbitration Procedure. If you or Epson commences arbitration, the arbitration shall be governed by the rules of JAMS that are in effect when the arbitration is filed, excluding any rules that permit arbitration on a class or representative basis (the "JAMS Rules"), available at <http://www.jamsadr.com> or by calling

1-800-352-5267, and under the rules set forth in this Agreement. All Disputes shall be resolved by a single neutral arbitrator, and both parties shall have a reasonable opportunity to participate in the selection of the arbitrator. The arbitrator is bound by the terms of this Agreement. The arbitrator, and not any federal, state or local court or agency, shall have exclusive authority to resolve all disputes arising out of or relating to the interpretation, applicability, enforceability or formation of this Agreement, including any claim that all or any part of this Agreement is void or voidable. Notwithstanding this broad delegation of authority to the arbitrator, a court may determine the limited question of whether a claim or cause of action is for an IP Claim, which is excluded from the definition of "Disputes" in Section 1.1 above. The arbitrator shall be empowered to grant whatever relief would be available in a court under law or in equity. The arbitrator may award you the same damages as a court could, and may award declaratory or injunctive relief only in favor of the individual party seeking relief and only to the extent necessary to provide relief warranted by that party's individual claim. In some instances, the costs of arbitration can exceed the costs of litigation and the right to discovery may be more limited in arbitration than in court. The arbitrator's award is binding and may be entered as a judgment in any court of competent jurisdiction.

You may choose to engage in arbitration hearings by telephone. Arbitration hearings not conducted by telephone shall take place in a location reasonably accessible from your primary residence, or in Orange County, California, at your option.

a) Initiation of Arbitration Proceeding. If either you or Epson decides to arbitrate a Dispute, both parties agree to the following procedure:

(i) Write a Demand for Arbitration. The demand must include a description of the Dispute and the amount of damages sought to be recovered. You can find a copy of a Demand for Arbitration at <http://www.jamsadr.com> ("Demand for Arbitration").

(ii) Send three copies of the Demand for Arbitration, plus the appropriate filing fee, to: JAMS, 500 North State College Blvd., Suite 600 Orange, CA 92868, U.S.A.

(iii) Send one copy of the Demand for Arbitration to the other party (same address as the Dispute Notice), or as otherwise agreed by the parties.

b) Hearing Format. During the arbitration, the amount of any settlement offer made shall not be disclosed to the arbitrator until after the arbitrator determines the amount, if any, to which you or Epson is entitled. The discovery or exchange of non-privileged information relevant to the Dispute may be allowed during the arbitration.

c) Arbitration Fees. Epson shall pay, or (if applicable) reimburse you for, all JAMS filings and arbitrator fees for any arbitration commenced (by you or Epson) pursuant to provisions of this Agreement.

d) Award in Your Favor. For Disputes in which you or Epson seeks \$75,000 or less in damages exclusive of attorney's fees and costs, if the arbitrator's decision results in an award to you in an amount greater than Epson's last written offer, if any, to settle the Dispute, Epson will: (i) pay you \$1,000 or the amount of the award, whichever is greater; (ii) pay you twice the amount of your reasonable attorney's fees, if

any; and (iii) reimburse you for any expenses (including expert witness fees and costs) that your attorney reasonably accrues for investigating, preparing, and pursuing the Dispute in arbitration. Except as agreed upon by you and Epson in writing, the arbitrator shall determine the amount of fees, costs, and expenses to be paid by Epson pursuant to this Section 1.6d).

e) Attorney's Fees. Epson will not seek its attorney's fees and expenses for any arbitration commenced involving a Dispute under this Agreement. Your right to attorney's fees and expenses under Section 1.6d) above does not limit your rights to attorney's fees and expenses under applicable law; notwithstanding the foregoing, the arbitrator may not award duplicative awards of attorney's fees and expenses.

1.7 Opt-out. You may elect to opt-out (exclude yourself) from the final, binding, individual arbitration procedure and waiver of class and representative proceedings specified in this Agreement by sending a written letter to the Epson Address within thirty (30) days of your assent to this Agreement (including without limitation the purchase, download, installation of the Software or other applicable use of Epson Hardware, products and services) that specifies (i) your name, (ii) your mailing address, and (iii) your request to be excluded from the final, binding individual arbitration procedure and waiver of class and representative proceedings specified in this Section 1. In the event that you opt-out consistent with the procedure set forth above, all other terms shall continue to apply, including the requirement to provide notice prior to litigation.

1.8 Amendments to Section 1. Notwithstanding any provision in this Agreement to the contrary, you and Epson agree that if Epson makes any future amendments to the dispute resolution procedure and class action waiver provisions (other than a change to Epson's address) in this Agreement, Epson will obtain your affirmative assent to the applicable amendment. If you do not affirmatively assent to the applicable amendment, you are agreeing that you will arbitrate any Dispute between the parties in accordance with the language of this Section 1 (or resolve disputes as provided for in Section 1.7, if you timely elected to opt-out when you first assented to this Agreement).

1.9 Severability. If any provision in this Section 1 is found to be unenforceable, that provision shall be severed with the remainder of this Agreement remaining in full force and effect. **The foregoing shall not apply to the prohibition against class or representative actions as provided in Section 1.5. This means that if Section 1.5 is found to be unenforceable, the entire Section 1 (but only Section 1) shall be null and void.**

Parent topic: [Notices](#)

Trademarks

EPSON®, Instant Off®, and Quick Corner® are registered trademarks, Epson iProjection is a trademark, and EPSON Exceed Your Vision is a registered logomark of Seiko Epson Corporation.

PrivateLine® is a registered trademark; SizeWise™ is a trademark; and Extra CareSM is a service mark of Epson America, Inc.

Windows is a registered trademark of Microsoft Corporation in the United States and/or other countries.

Mac, macOS, and OS X are trademarks of Apple Inc., registered in the U.S. and other countries.

Google® is a registered trademark and Android™, Chromebook™, and Google Chrome™ are trademarks of Google LLC.

HDBaseT™ and the HDBaseT Alliance logo are trademarks of the HDBaseT Alliance.

General Notice: Other product names used herein are for identification purposes only and may be trademarks of their respective owners. Epson disclaims any and all rights in those marks.



Parent topic: [Notices](#)

Copyright Notice

All rights reserved. No part of this publication may be reproduced, stored in a retrieval system, or transmitted in any form or by any means, electronic, mechanical, photocopying, recording, or otherwise, without the prior written permission of Seiko Epson Corporation. The information contained herein is designed only for use with this Epson product. Epson is not responsible for any use of this information as applied to other products.

Neither Seiko Epson Corporation nor its affiliates shall be liable to the purchaser of this product or third parties for damages, losses, costs, or expenses incurred by purchaser or third parties as a result of: accident, misuse, or abuse of this product or unauthorized modifications, repairs, or alterations to this product, or (excluding the U.S.) failure to strictly comply with Seiko Epson Corporation's operating and maintenance instructions.

Seiko Epson Corporation shall not be liable for any damages or problems arising from the use of any options or any consumable products other than those designated as Original Epson Products or Epson Approved Products by Seiko Epson Corporation.

This information is subject to change without notice.

[A Note Concerning Responsible Use of Copyrighted Materials](#)

[Copyright Attribution](#)

Parent topic: [Notices](#)

A Note Concerning Responsible Use of Copyrighted Materials

Epson encourages each user to be responsible and respectful of the copyright laws when using any Epson product. While some countries' laws permit limited copying or reuse of copyrighted material in certain circumstances, those circumstances may not be as broad as some people assume. Contact your legal advisor for any questions regarding copyright law.

Parent topic: [Copyright Notice](#)

Copyright Attribution

© 2019 Epson America, Inc.

11/19

CPD-56230

Parent topic: [Copyright Notice](#)