

PowerLite® Pro Z9750UNL/Z9870UNL Z10000UNL/Z10005UNL

Quick Reference

This *Quick Reference* card gives brief instructions on connecting your PowerLite projector and using common features. For details, see the online *User's Guide*.

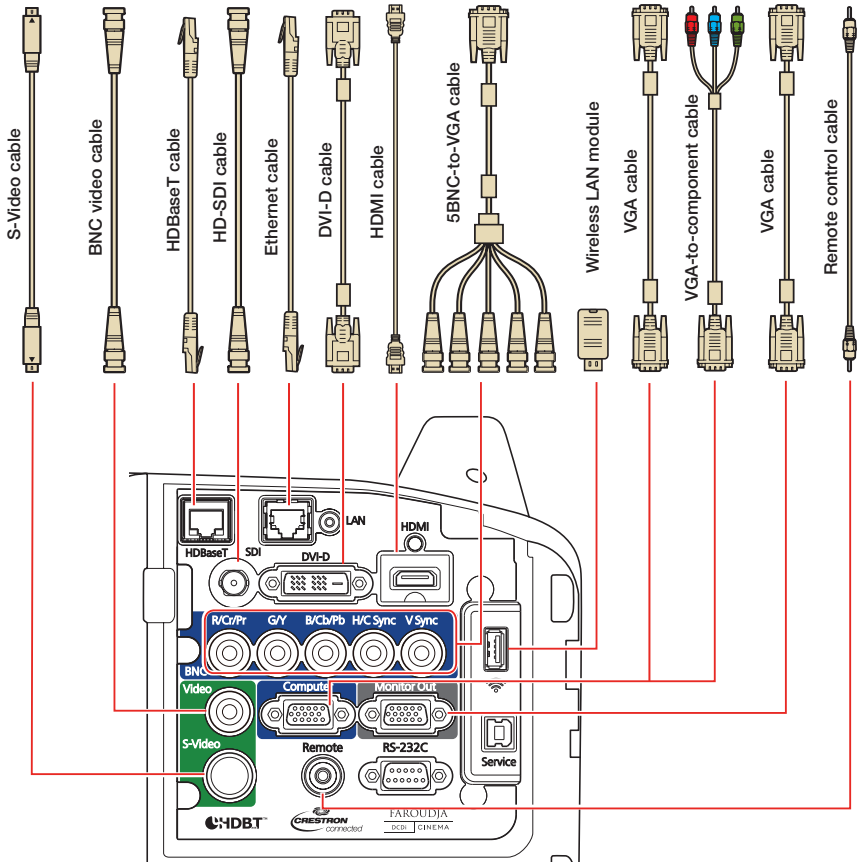

Note: SDI is available for the PowerLite Pro Z9870UNL, Z10000UNL, and Z10005UNL only.

Turning the Projector On



1. Turn on your computer or image source.
2. Remove the projector lens cover.
3. Press the **On** button. After the power and status lights stay blue, the projector is ready.

Note: If the Direct Power On function is enabled, you can turn the projector on without pressing the **On** button; just plug it in or flip the switch controlling the outlet to which the projector is connected. To turn on this feature, see the online *User's Guide*.

4. If your image does not appear, see “Switching Between Image Sources” or “Troubleshooting.”

Changing the Language of the Projector Menus

The default language of the projector's menu system is English, but you can change it as necessary.

1. Press the **Menu** button to access the projector's menu system.
2. Select **Extended** and press .
3. Select **Language** and press .
4. Select your language and press .
5. When you're done, press **Menu** to exit.

Switching Between Image Sources

Press the **Search** button or one of the source buttons (remote control), or one of the source buttons (projector).

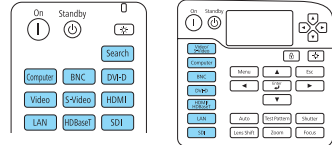

Adjusting Image Position

Press the **Lens Shift** button on the remote control or projector until Adjust Lens Shift is displayed on the screen.

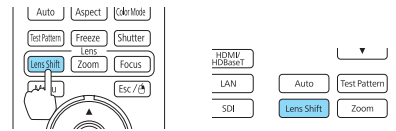

Press the arrow buttons on the remote control or projector to adjust the position.

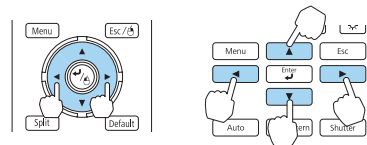

If the projector is on a table, you can level the image by turning any of the projector's adjustable feet.

Focusing the Image

Press the **Focus** button on the remote control or projector until Adjust Focus is displayed on the screen.

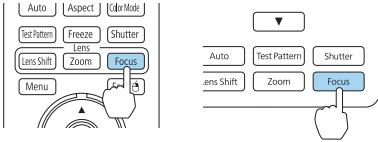

Press the left and right arrow buttons on the remote control or projector to adjust the focus.

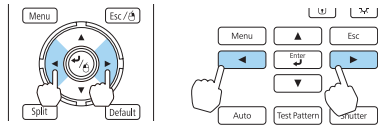

Zooming the Image

Press the **Zoom** button on the remote control or projector until Adjust Zoom is displayed on the screen.

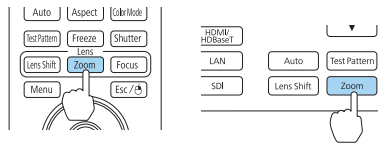

Press the left and right arrow button on the remote control or projector to reduce/enlarge the image.

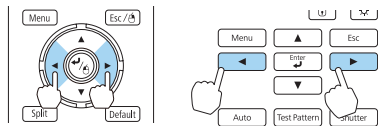

Correcting Image Shape

If your image is uneven on the sides, you can use the projector's distortion correction features such as **H/V-Keystone** and **Quick Corner®** to adjust the shape. See the online *User's Guide*.

Changing the Aspect Ratio

Press the **Aspect** button on the remote control to change the aspect ratio.

For images input through the Computer port, select **Normal** to automatically resize the image.

Making Other Image Adjustments

For help on using the projector's features to improve the image quality, see the online *User's Guide*. You can also view information on how to adjust the image color, position, and edges (Edge Blending) when projecting from multiple projectors to create one seamless widescreen image.

Turning the Projector Off

Press the **Standby** button to turn the projector off. If you see a confirmation message, press the **Standby** button again.

Note: If the Direct Power On function is enabled, you can unplug the projector or flip the switch controlling the outlet to which the projector is connected instead. To turn on this feature, see the online *User's Guide*.

With Epson's Instant Off® technology, you don't have to wait for the projector to cool down; just turn it off or unplug it when you're done.

Troubleshooting

If you see a blank screen or the message *No signal*

- Make sure the  power and status lights on the projector are blue and not flashing, and the lens cover is removed.
- Make sure the cables are connected correctly. See the online *User's Guide*.
- You may need to change the image source. See "Switching Between Image Sources." Also make sure the source device is turned on.

If the projector and the notebook don't display the same image

Windows®

Press the function key on your keyboard that lets you display on an external monitor. It may be labeled **CRT/LCD** or have an icon such as . You may need to hold down the **Fn** key while pressing it (such as **Fn + F7**). Wait a moment for the display to appear. You may need to press the keys again to display the image on both devices.

OS X

Open **System Preferences** and select **Displays**. Click the **Arrangement** tab and select the **Mirror Displays** checkbox.

Where to Get Help

Manuals

For more information about using the projector, click the icons on your desktop to access the online manuals (requires an Internet connection). If you don't have icon links to the manuals, you can install them from the projector CD or go to the Epson website, as described below.

Internet support

Visit **epson.com/support** (U.S.) or **epson.ca/support** (Canada) to download utilities and documentation, get FAQs and troubleshooting advice, or e-mail Epson.

Speak to a support representative

To use the Epson® PrivateLine® Support service, call (800) 637-7661. This service is available for the duration of your warranty period. You may also speak with a projector support specialist by dialing (562) 276-4394 (U.S.) or (905) 709-3839 (Canada).

Support hours are 6 AM to 8 PM, Pacific Time, Monday through Friday and 7 AM to 4 PM, Pacific Time, Saturday.

Days and hours of support are subject to change without notice. Toll or long distance charges may apply.

Purchase supplies and accessories

You can purchase screens and other accessories from an Epson authorized reseller. To find the nearest reseller, call 800-GO-EPSON (800-463-7766). Or you can purchase online at **epsonstore.com** (U.S. sales) or **epson.ca** (Canadian sales).

Remote Control Map

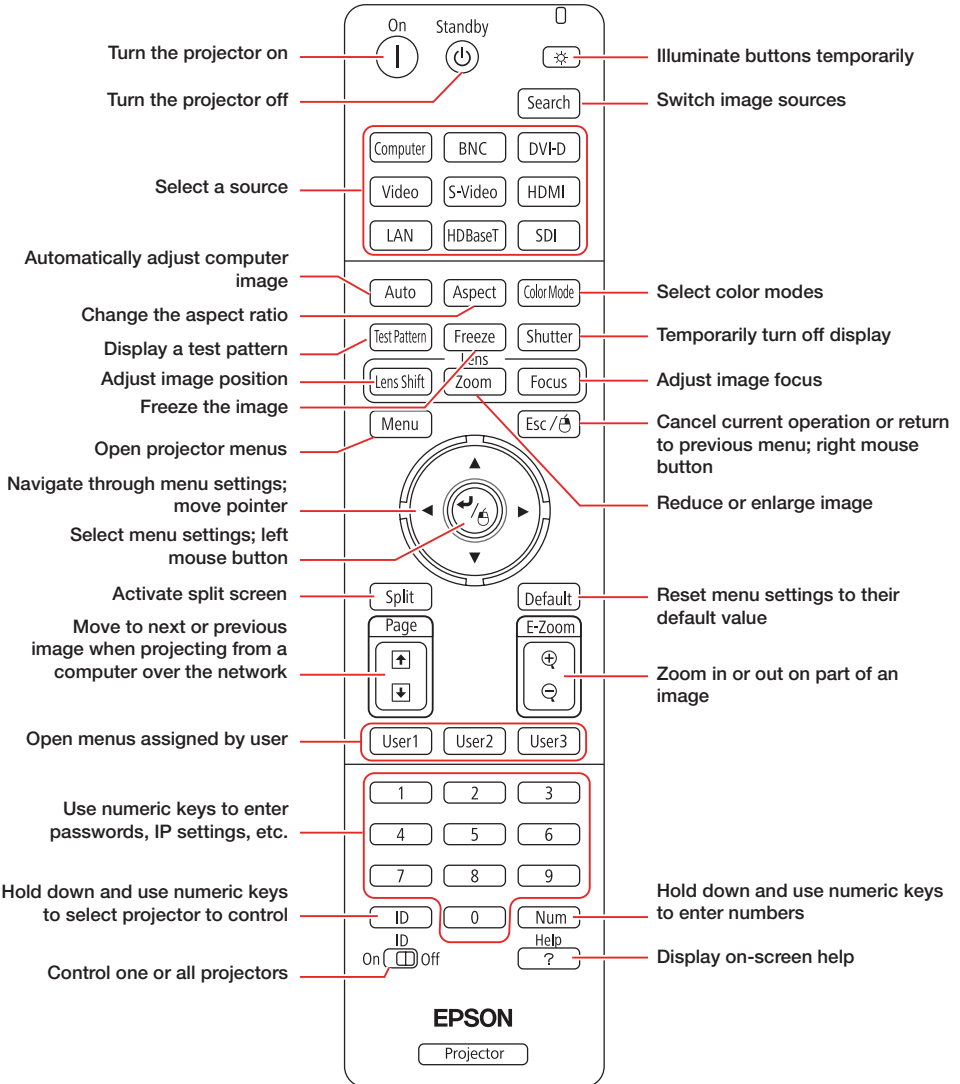

Replacement Parts and Accessories

Product	Part number
Replacement lamp one-pack (ELPLP81)	V13H010L81
Replacement lamp two-pack (ELPLP82)	V13H010L82
Replacement lamp (portrait mode) one-pack (ELPLP83)	V13H010L83
Replacement lamp (portrait mode) two-pack (ELPLP84)	V13H010L84
Air filter (ELPAF46)	V13H134A46
Wireless LAN module (ELPAP07)	V12H418P12

You can purchase replacement parts from an Epson authorized reseller. See “Where to Get Help” inside this card for more information.

Touchboards

205 Westwood Ave, Long Branch, NJ 07740
Phone: 866-94 BOARDS (26273) / (732)-222-1511
Fax: (732)-222-7088 | E-mail: sales@touchboards.com

EPSON®

EXCEED YOUR VISION



EPSON, Instant Off, PowerLite, and Quick Corner are registered trademarks and EPSON Exceed Your Vision is a registered logomark of Seiko Epson Corporation. PrivateLine is a registered trademark of Epson America, Inc.

OS X is a trademark of Apple Inc., registered in the U.S. and other countries.

General Notice: Other product names used herein are for identification purposes only and may be trademarks of their respective owners. Epson disclaims any and all rights in those marks.

This information is subject to change without notice.

© 2014 Epson America, Inc., 6/14

CPD-40850R1

Printed in XXXXXX



412779600