



**205 Westwood Ave, Long Branch, NJ 07740**  
**Phone: 866-94 BOARDS (26273) / (732)-222-1511**  
**Fax: (732)-222-7088 | E-mail: [sales@touchboards.com](mailto:sales@touchboards.com)**

## **Pro L2500U User's Guide**



---

# Contents

<b>Pro L25000U User's Guide</b> .....	<b>11</b>
<b>Introduction to Your Projector</b> .....	<b>12</b>
Projector Features.....	12
Product Box Contents.....	13
Additional Components .....	14
Additional Projector Software and Manuals .....	16
Optional Equipment and Replacement Parts.....	17
Warranty and Registration Information .....	18
Notations Used in the Documentation .....	18
Where to Go for Additional Information .....	18
Projector Part Locations .....	19
Projector Parts - Front/Top .....	19
Projector Parts - Rear .....	20
Projector Parts - Interface Ports .....	21
Projector Parts - Control Panel .....	22
Projector Parts - Remote Control.....	24
<b>Setting Up the Projector</b> .....	<b>27</b>
Projector Placement.....	27
Projector Setup and Installation Options .....	27
Projection Distance.....	31
Projector Connections .....	50
Connecting to Video Sources .....	51
Connecting to an HDMI Video Source .....	51
Connecting to a Component-to-BNC Video Source .....	52
Connecting to a Component Video Source .....	52
Connecting to an SDI Video Source.....	53
Connecting to Computer Sources.....	54
Connecting to a Computer for VGA Video.....	54
Connecting to a Computer for HDMI Video.....	54
Connecting to a Computer for DVI-D Video .....	55

Connecting to a Computer for 5 BNC Video.....	56
Connecting to an HDBaseT Transmitter .....	56
Connecting to an External Computer Monitor.....	57
Attaching and Removing a Lens.....	58
Attaching a Lens .....	58
Removing a Lens .....	61
Securing the Power Cord .....	63
Attaching and Removing the HDMI Cable Clip.....	63
Installing Batteries in the Remote Control .....	64
<b>Using the Projector on a Network .....</b>	<b>66</b>
Wired Network Projection.....	66
Connecting to a Wired Network.....	66
Selecting Wired Network Settings .....	67
Wireless Network Projection .....	70
Installing the Wireless LAN Module .....	70
Using a QR Code to Connect a Mobile Device .....	72
Selecting Wireless Network Settings Manually.....	74
Wireless LAN Menu Settings .....	77
Selecting Wireless Network Settings in Windows.....	78
Selecting Wireless Network Settings on Mac .....	78
Setting Up Projector Network E-Mail Alerts .....	78
Network Projector E-mail Alert Messages .....	80
Selecting Other Network Settings.....	80
Controlling a Networked Projector Using a Web Browser .....	81
Web Control Options .....	83
Crestron RoomView Support.....	89
Setting Up Crestron RoomView Support .....	89
Controlling a Networked Projector Using Crestron RoomView .....	90
<b>Using Basic Projector Features .....</b>	<b>92</b>
Turning On the Projector .....	92
Turning Off the Projector .....	94
Selecting the Language for the Projector Menus.....	96
Resizing the Image with the Zoom Button .....	96

Focusing the Image Using the Focus Button .....	97
Focusing the Image When Using an Optional Short Throw Lens .....	98
Setting the Screen Type .....	100
Adjusting the Image Position Using Lens Shift .....	100
Adjusting the Image Position Using Screen Position .....	103
Displaying a Test Pattern .....	104
Available Test Pattern Image Adjustments .....	105
Image Shape .....	105
Correcting Image Shape with H/V Keystone .....	106
Correcting Image Shape with Quick Corner .....	109
Correcting Image Shape with Curved Surface .....	111
Correcting Image Shape with Corner Wall .....	115
Correcting Image Shape with Point Correction .....	120
Selecting an Image Source .....	123
Remote Control Operation .....	124
Projection Modes .....	126
Changing the Projection Mode Using the Remote Control .....	126
Changing the Projection Mode Using the Menus .....	126
Image Aspect Ratio .....	127
Changing the Image Aspect Ratio .....	128
Available Image Aspect Ratios .....	129
Color Mode .....	130
Changing the Color Mode .....	130
Available Color Modes .....	131
Adjusting the Brightness .....	131
Constant Brightness Usage Hours .....	134
Turning On Automatic Luminance Adjustment .....	136
Setting the Date and Time .....	137
Date and Time Settings .....	138
<b>Adjusting Projector Features .....</b>	<b>140</b>
Shutting Off the Picture Temporarily .....	140
Stopping Video Action Temporarily .....	141
Projector Security Features .....	142

Password Security Types .....	142
Setting a Password .....	143
Selecting Password Security Types.....	144
Entering a Password to Use the Projector.....	145
Saving a User's Logo Image to Display.....	146
Locking the Projector's Lens Settings and Buttons.....	148
Unlocking the Projector's Buttons .....	150
Locking the Remote Control Buttons .....	150
Installing a Security Cable .....	152
Projecting Two Images Simultaneously.....	153
Input Sources for Split Screen Projection .....	155
Using Advanced Image Adjustment Features .....	155
Using Frame Interpolation .....	156
Using 4K Enhancement.....	158
Creating Image Presets.....	159
Using MPEG Noise Reduction.....	161
Adjusting Scaled Resolution Images (Super-resolution) .....	162
Adjusting Detail Enhancement .....	163
Adjusting the Color Convergence (Panel Alignment).....	164
Adjusting the Color Tone (Color Uniformity) .....	166
Using Multiple Projectors.....	168
Multiple Projector Adjustment Overview .....	169
Projector Identification System for Multiple Projector Control.....	170
Setting the Projector ID .....	170
Setting the Remote Control ID .....	171
Tiling Images into One Image.....	172
Configuring Tiling Automatically.....	173
Configuring Tiling Manually.....	175
Blending the Image Edges .....	177
Adjusting the Black Level .....	179
Matching Tint and Brightness (Screen Matching) .....	183
Matching the Screens Automatically.....	184
Matching the Screens Manually .....	185

Scaling an Image.....	187
Enabling Protocol Emulation .....	188
Saving Settings to Memory and Using Saved Settings .....	189
Saving a Scheduled Event .....	191
Viewing Scheduled Events .....	192
Editing a Scheduled Event.....	193
Copying Menu Settings Between Projectors .....	194
Saving Settings to a USB Flash Drive.....	195
Transferring Settings From a USB Flash Drive.....	197
Saving Settings to a Computer .....	198
Transferring Settings From a Computer .....	200
<b>Adjusting the Menu Settings .....</b>	<b>202</b>
Using the Projector's Menus.....	202
Image Quality Settings - Image Menu .....	204
Input Signal Settings - Signal Menu.....	207
Projector Feature Settings - Settings Menu.....	210
Projector Setup Settings - Extended Menu.....	213
Projector Network Settings - Network Menu.....	220
Projector Information Display - Info Menu .....	222
Event ID Code List.....	224
Projector Reset Options - Reset Menu .....	225
<b>Maintaining and Transporting the Projector .....</b>	<b>227</b>
Projector Maintenance .....	227
Cleaning the Lens.....	227
Cleaning the Projector Case.....	228
Air Filter and Vent Maintenance .....	228
Cleaning the Air Filters.....	229
Replacing the Air Filters .....	234
Replacing the Remote Control Batteries .....	238
Transporting the Projector.....	240
<b>Solving Problems .....</b>	<b>243</b>
Projection Problem Tips .....	243
Projector Light Status .....	244

Viewing Projector Status Information .....	247
Projector Status Display Messages .....	249
Using the Projector Help Displays .....	253
Solving Image Problems .....	253
Solutions When No Image Appears.....	254
Solutions When "No Signal" Message Appears.....	255
Displaying From a PC Laptop .....	255
Displaying From a Mac Laptop .....	256
Solutions When "Not Supported" Message Appears .....	256
Solutions When Only a Partial Image Appears .....	256
Solutions When the Image is Not Rectangular .....	257
Solutions When the Image Contains Noise or Static .....	257
Solutions When the Image is Fuzzy or Blurry .....	258
Solutions When the Image Brightness or Colors are Incorrect .....	259
Solving Projector or Remote Control Operation Problems .....	260
Solutions to Projector Power or Shut-Off Problems .....	260
Solutions to Problems with the Remote Control.....	261
Solutions to Password Problems .....	262
Solving Network Problems .....	262
Solutions When You Cannot Access the Projector Through the Web .....	262
Solutions When Network Alert E-Mails are Not Received.....	263
Where to Get Help.....	263
<b>Technical Specifications .....</b>	<b>265</b>
General Projector Specifications .....	265
Projector Light Source Specifications.....	266
Remote Control Specifications .....	267
Projector Dimension Specifications.....	267
Projector Electrical Specifications .....	267
Projector Environmental Specifications.....	268
Projector Safety and Approvals Specifications.....	268
Supported Video Display Formats.....	269
<b>Notices .....</b>	<b>272</b>
Recycling.....	272



Important Safety Information .....	272
Important Safety Instructions.....	273
Laser Safety Information .....	275
Laser Light Source Warning .....	277
Restriction of Use .....	278
List of Safety Symbols (corresponding to IEC60950-1 A2).....	278
FCC Compliance Statement.....	282
Open Source Software License.....	282
Binding Arbitration and Class Waiver .....	329
Trademarks .....	332
Copyright Notice.....	332
A Note Concerning Responsible Use of Copyrighted Materials.....	333
Copyright Attribution .....	333



---

# Pro L25000U User's Guide

Welcome to the Pro L25000U *User's Guide*. For a printable PDF copy of this guide, [click here](#).

---

# Introduction to Your Projector

Refer to these sections to learn more about your projector and this manual.

[Projector Features](#)

[Notations Used in the Documentation](#)

[Where to Go for Additional Information](#)

[Projector Part Locations](#)

## Projector Features

The Pro L25000U projector includes these special features:

### **Bright, high-resolution projection system**

- Up to 25000 lumens of brightness (white light output and color light output)

**Note:** Color brightness (color light output) and white brightness (white light output) will vary depending on usage conditions. Color light output measured in accordance with IDMS 15.4; white light output measured in accordance with ISO 21118.

- Native resolution of 1920 × 1200 pixels (WUXGA)

### **Flexible connectivity**

- Wired and wireless (optional) network support for projection, monitoring, and control via remote network computer
- Variety of connection methods for a computer or video device including HDMI, BNC, DVI-D, SDI, and HDBaseT
- Port for connecting an external monitor

### **Easy-to-use setup and operation features**

- Interchangeable bayonet lens options available
- Project images side by side from two separate input sources
- Create one large seamless display when projecting from multiple projectors using Edge Blending
- Epson's Instant Off and Direct Power On features for quick setup and shut down
- Support for Crestron RoomView network monitoring systems

- Network message broadcast system to project timely messages to all networked projectors (Windows only)

[Product Box Contents](#)

[Additional Components](#)

[Additional Projector Software and Manuals](#)

[Optional Equipment and Replacement Parts](#)

[Warranty and Registration Information](#)

**Parent topic:** [Introduction to Your Projector](#)

**Related concepts**

[Projector Part Locations](#)

[Projector Connections](#)

[Using Multiple Projectors](#)

[Crestron RoomView Support](#)

**Related references**

[Optional Equipment and Replacement Parts](#)

**Related tasks**

[Projecting Two Images Simultaneously](#)

**Related topics**

[Using the Projector on a Network](#)

## Product Box Contents

Save all the packaging in case you need to ship the projector. Always use the original packaging (or equivalent) when shipping.

Make sure your projector box included all of these parts:

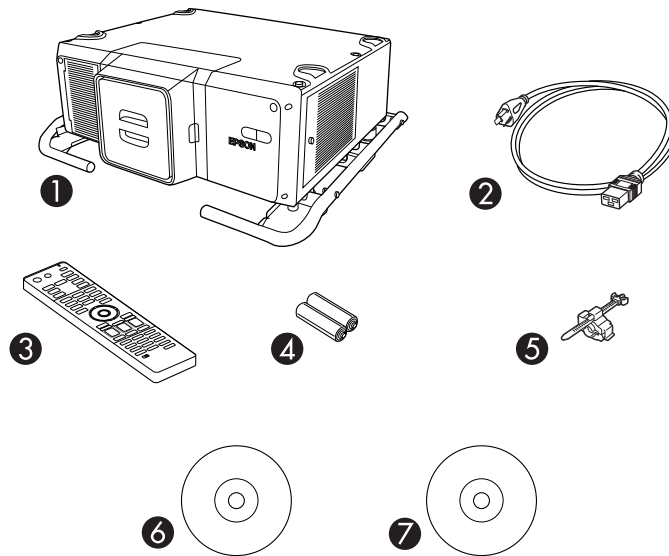

- 1 Projector
- 2 Power cord
- 3 Remote control
- 4 Remote control batteries (two AA alkaline)
- 5 Cable clip
- 6 Projector documentation CD
- 7 Projector software CD

**Parent topic:** [Projector Features](#)

**Related concepts**

[Projector Connections](#)

## Additional Components

Depending on how you plan to use the projector, you may need to obtain additional components.

**Note:** To connect a Mac that does not include a compatible video output port, you need to obtain an adapter that allows you to connect to an input port on the projector. Contact Apple for compatible adapter options. To connect a smartphone or tablet, you may need to obtain an adapter that allows you to connect to the projector. This allows you to mirror your smartphone or tablet screens, watch movies, and more. Contact your device manufacturer for compatible adapter options.

Unless listed as available from Epson in this table, see your local computer or electronics dealer for purchase information.

Signal or connection type	Additional component necessary
Component video	Component-to-BNC or D-sub, 15-pin, component-to-VGA video cable or adapter Available for purchase from Epson or an authorized Epson reseller.
HDMI	HDMI cable Available for purchase from Epson or an authorized Epson reseller. You also need a splitter that supports HDMI signals (commercially available).
MHL	MHL-compatible device or device with an integrated MHL connector, MHL cable, or HDMI cable and MHL adapter compatible with your device Available for purchase from Epson or an authorized Epson reseller.
VGA	VGA computer cable Available for purchase from Epson or an authorized Epson reseller. If you want to connect the projector using a splitter, you also need a splitter that supports VGA signals (commercially available) and a second VGA computer cable.
BNC	VGA-to-5-BNC cable or adapter Available for purchase from Epson or an authorized Epson reseller.
DVI-D	Compatible DVI-D cable
HDBaseT	Compatible 100Base-TX LAN cable
SDI	Compatible BNC video cable

Parent topic: [Projector Features](#)

## Related concepts

### [Projector Connections](#)

## Additional Projector Software and Manuals

After connecting and setting up the projector, install the projector software from the included software CD, or download the software and manuals as necessary.

You can install the projector software programs listed here and view their manuals for instructions on using them.

**Note:** If you still need help after checking this manual and the sources listed here, you can use the Epson PrivateLine Support service to get help fast. For details, see "Where to Get Help".

Projector software	Manual	Description
EasyMP Monitor (Windows only)	<i>EasyMP Monitor Operation Guide</i>	Lets you monitor and control your projector through the network.  You can download the latest software and documentation from the Epson web site. Go to <a href="http://epson.com/support">epson.com/support</a> (U.S.) or <a href="http://epson.ca/support">epson.ca/support</a> (Canada) and select your projector.
EasyMP Multi PC Projection	<i>EasyMP Multi PC Projection Operation Guide</i>	Lets you hold interactive meetings by projecting the computer screens of users over a network.
EasyMP Network Updater (Windows only)	<i>EasyMP Network Updater Operation Guide</i>	Lets you update firmware for a projector over a wired LAN.  You can download the latest software and documentation from the Epson web site. Go to <a href="http://epson.com/support">epson.com/support</a> (U.S.) or <a href="http://epson.ca/support">epson.ca/support</a> (Canada) and select your projector.
Epson iProjection app	Instructions are included with the app	Lets you project from an iOS or Android device if your projector is connected to a network that includes a wireless access point.  Visit <a href="http://epson.com/iprojection">epson.com/iprojection</a> (U.S.) or <a href="http://epson.ca/iprojection">epson.ca/iprojection</a> (Canada) for more information.



Parent topic: [Projector Features](#)

## Optional Equipment and Replacement Parts

You can purchase screens, other optional accessories, and replacement parts from an Epson authorized reseller. To find the nearest reseller, call 800-GO-EPSON (800-463-7766) in the U.S. or 800-807-7766 in Canada. Or you can purchase online at [epsonstore.com](http://epsonstore.com) (U.S. sales) or [epsonstore.ca](http://epsonstore.ca) (Canadian sales).

Epson offers the following optional accessories and replacement parts for your projector:

Option or part	Part number
Air filter (ELPAF52)	V13H134A52
Wireless LAN module (ELPAP10)	V12H731P02
HDBaseT Transmitter (ELPHD01)	V12H547020
Remote control cable set (ELPKC28)	V12H005C28
Epson DC-07 document camera (ELPDC07)	V12H759020
Epson DC-11 document camera (ELPDC11)	V12H377020
Epson DC-13 document camera (ELPDC13)	V12H757020
Epson DC-20 document camera (ELPDC20)	V12H500020
Epson DC-21 document camera (ELPDC21)	V12H758020
Wireless IR mouse receiver for remote control (ELPST16)	V12H007T16
Component-to-VGA video cable	ELPKC19
VGA video cable 10 feet (3.0 m) length	F3H982-10
HDMI audio video cable 3 feet (0.9 m) length	AV22300-03
HDMI audio video cable 6 feet (1.8 m) length	AV22300-06
Mounting handle (ELPMB49)	V12H830010
Rear-throw zoom lens (ELPLR05)	V12H004R05
Short-throw zoom lens (ELPLU05)	V12H004U05
Wide-throw zoom lens (ELPLW07))	V12H004W07
Middle-throw zoom lens #1 (ELPLM12)	V12H004M0C
Middle-throw zoom lens #2 (ELPLM13)	V12H004M0D

Option or part	Part number
Middle-throw zoom lens #3 (ELPLM14)	V12H004M0E
Long-throw zoom lens #1 (ELPLL09)	V12H004L09
Long-throw zoom lens #2 (ELPLL10)	V12H004L0A

Parent topic: [Projector Features](#)

## Warranty and Registration Information

Your projector comes with a basic warranty that lets you project with confidence. For details, see the warranty that came with your projector.

In addition, Epson offers free Extra Care Road Service. In the unlikely event of an equipment failure, you won't have to wait for your unit to be repaired. Instead, Epson will ship you a replacement unit anywhere in the United States, Canada, or Puerto Rico. See the Extra Care Road Service brochure for details.

Register your product online using the projector CD or at this site: [epson.com/webreg](http://epson.com/webreg).

Registering also lets you receive special updates on new accessories, products, and services.

Parent topic: [Projector Features](#)

## Notations Used in the Documentation

Follow the guidelines in these notations as you read your documentation:

- **Warnings** must be followed carefully to avoid bodily injury.
- **Cautions** must be observed to avoid damage to your equipment.
- **Notes** contain important information about your projector.
- **Tips** contain additional projection information.

Parent topic: [Introduction to Your Projector](#)

## Where to Go for Additional Information

Need quick help on using your projector? Here's where to look for help:

- [epson.com/support](http://epson.com/support) (U.S) or [epson.ca/support](http://epson.ca/support) (Canada)

View FAQs (frequently asked questions) and e-mail your questions to Epson technical support 24 hours a day.

- If you still need help after checking this manual and any other sources listed here, you can use the Epson PrivateLine Support service to get help fast. For details, see "Where to Get Help".

**Parent topic:** [Introduction to Your Projector](#)

**Related topics**  
[Solving Problems](#)

## Projector Part Locations

Check the projector part illustrations to learn about the parts on your projector.

[Projector Parts - Front/Top](#)  
[Projector Parts - Rear](#)  
[Projector Parts - Interface Ports](#)  
[Projector Parts - Control Panel](#)  
[Projector Parts - Remote Control](#)

**Parent topic:** [Introduction to Your Projector](#)

### Projector Parts - Front/Top

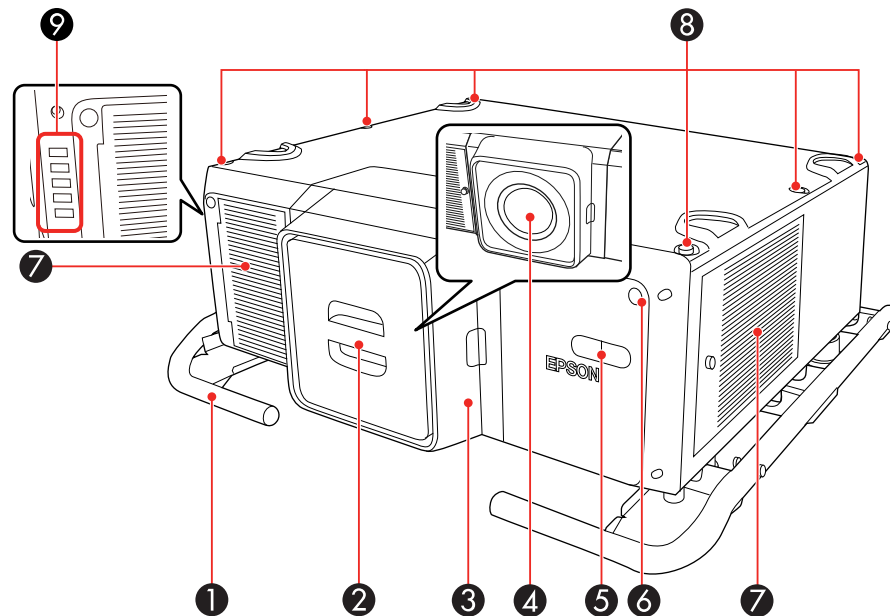

- 1 Carrying handles
- 2 Cap for lens cover
- 3 Lens cover
- 4 Projection lens
- 5 Built-in camera
- 6 Remote receiver
- 7 Air filter cover/intake vents
- 8 Holes for optional mounting
- 9 Status lights

Parent topic: [Projector Part Locations](#)

## Projector Parts - Rear

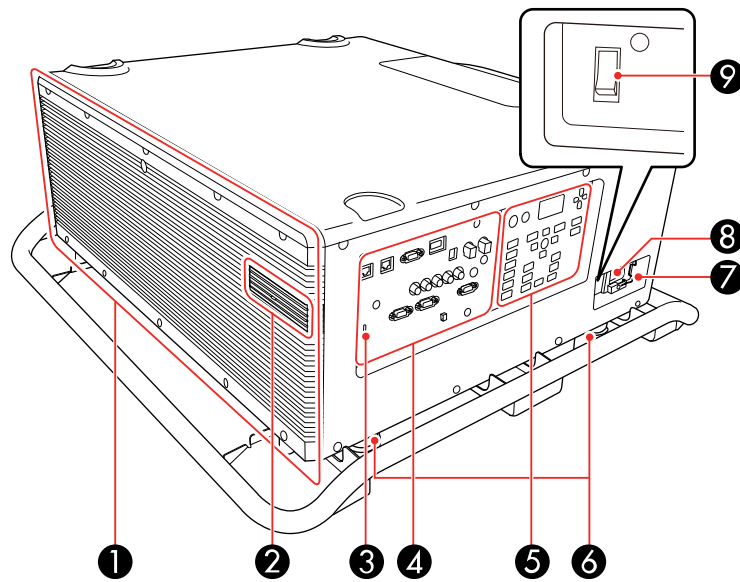

- 1 Exhaust vents

- 2 Wireless LAN module port cover
- 3 Kensington security slot
- 4 Interface ports
- 5 Control panel
- 6 Rear feet
- 7 Power cord holder
- 8 AC input
- 9 Power switch

Parent topic: [Projector Part Locations](#)

## Projector Parts - Interface Ports

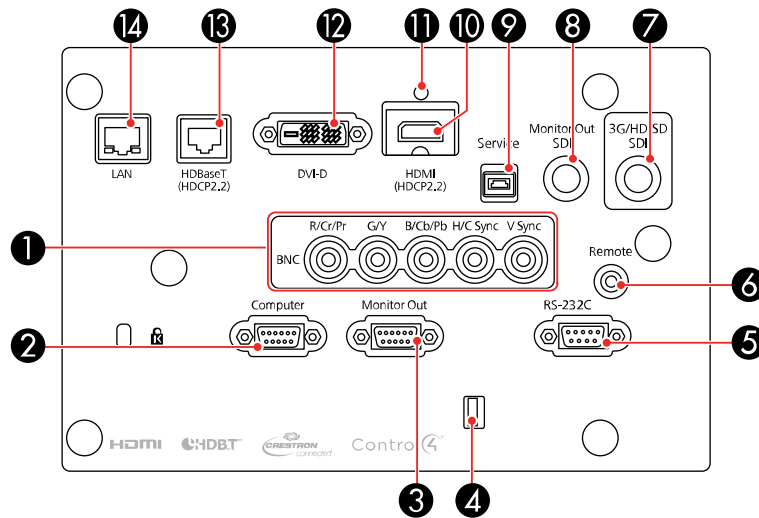

- 1 **BNC** ports
- 2 **Computer** port
- 3 **Monitor Out** port
- 4 **Cable clip** slot

- 5 **RS-232C** port
- 6 **Remote** port
- 7 **3G/HD/SD SDI** port
- 8 **Monitor Out SDI** port
- 9 **Service** port
- 10 **HDMI** port
- 11 Cable clip slot
- 12 **DVI-D** port
- 13 **HDBaseT** port
- 14 Network **LAN** port

Parent topic: [Projector Part Locations](#)

## Projector Parts - Control Panel

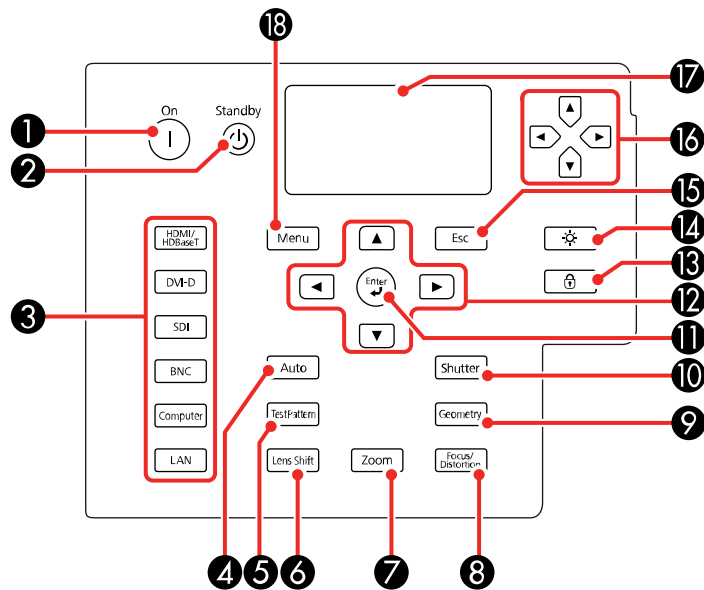

- 1 **On** button (turns on the projector)
- 2 **Standby** button (turns off the projector)
- 3 Source buttons (select an image source)
- 4 **Auto** button (automatically adjusts computer images)
- 5 **Test Pattern** button (displays a test pattern)
- 6 **Lens Shift** button (adjusts the image position)
- 7 **Zoom** button (changes the image size)
- 8 **Focus/Distortion** button (adjusts the image focus/distortion)
- 9 **Geometry** button (adjusts the image shape)
- 10 **Shutter** button (turns input signal on or off temporarily)
- 11 **Enter** button (selects options)
- 12 Arrow buttons (move through on-screen options; adjust the focus, zoom, and lens shift)
- 13 Lock button (displays the Control Panel Lock screen)
- 14 Light button (lights up the control panel buttons and screen temporarily)
- 15 **Esc** button (cancels/exits functions)
- 16 Arrow buttons (select status information settings)
- 17 Status display (displays projector status information)
- 18 **Menu** button (accesses projector menu system)

**Parent topic:** [Projector Part Locations](#)

# Projector Parts - Remote Control

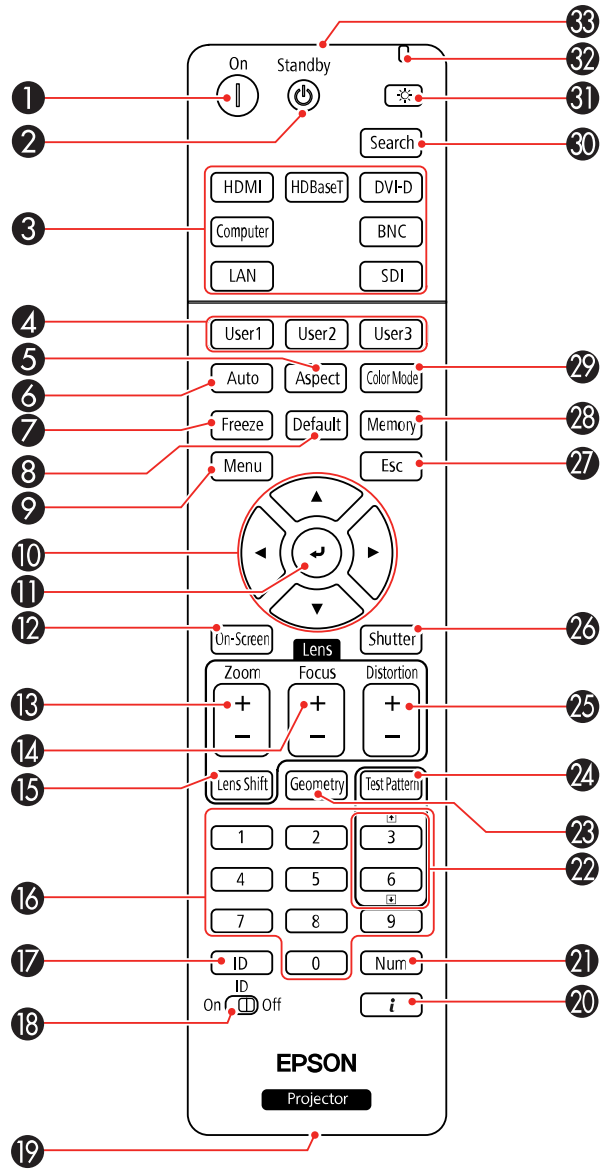



- 1 **On** button (turns on the projector)
- 2 **Standby** button (turns off the projector)
- 3 Source buttons (select an image source)
- 4 **User1**, **User2**, and **User3** buttons (open menu assigned by user)
- 5 **Aspect** button (selects the image aspect ratio)
- 6 **Auto** button (automatically adjusts computer images)
- 7 **Freeze** button (stops video action)
- 8 **Default** button (resets settings to their default values in the projector menu system)
- 9 **Menu** button (accesses projector menu system)
- 10 Arrow buttons (move through on-screen options and move pointer)
- 11 Enter button (selects options and left mouse button)
- 12 **On-Screen** button (displays or hides the on-screen menus or messages)
- 13 **Zoom** button (changes the image size)
- 14 **Focus** button (adjusts the image focus)
- 15 **Lens Shift** button (adjusts the image position)
- 16 Numeric buttons (enter numbers)
- 17 **ID** button (hold down and use numeric keys to select projector to control)
- 18 **ID** switch (selects control of one or all projectors)
- 19 Remote port (connects to a remote control cable)
- 20 **i** button (displays the Info menu)
- 21 **Num** button (hold down and use numeric keys to enter numbers)
- 22 Page up and down buttons (scroll through image files when projecting from a computer over a network connection; change the page when projecting a PowerPoint file using the optional wireless mouse receiver)
- 23 **Geometry** button (corrects image shape)
- 24 **Test Pattern** button (displays a test pattern)
- 25 **Distortion** button (corrects image distortion)
- 26 **Shutter** button (turns signal on or off temporarily)

- 27 **Esc** button (cancels/exits functions and right mouse button)
- 28 **Memory** button (saves and applies presets)
- 29 **Color Mode** button (selects display modes)
- 30 **Search** button (searches for connected sources)
- 31 Light button (lights up the remote control buttons temporarily)
- 32 Indicator light (lights up when the remote control is in use)
- 33 Remote control signal emitter (emits remote control signals)

**Parent topic:** [Projector Part Locations](#)

---

# Setting Up the Projector

Follow the instructions in these sections to set up your projector for use.

[Projector Placement](#)

[Projector Connections](#)

[Attaching and Removing a Lens](#)

[Securing the Power Cord](#)

[Attaching and Removing the HDMI Cable Clip](#)

[Installing Batteries in the Remote Control](#)

## Projector Placement

You can place the projector on almost any flat surface to project an image.

You can also install the projector in a ceiling mount if you want to use it in a fixed location.

Keep these considerations in mind as you select a projector location:

- Place the projector on a sturdy, level surface or install it using a compatible mount.
- Leave plenty of space around and under the projector for ventilation, and do not place it on top of or next to anything that could block the vents.
- Position the projector within reach of a grounded electrical outlet or extension cord.

[Projector Setup and Installation Options](#)

[Projection Distance](#)

**Parent topic:** [Setting Up the Projector](#)

## Projector Setup and Installation Options

You can set up or install your projector in the following ways:

Front

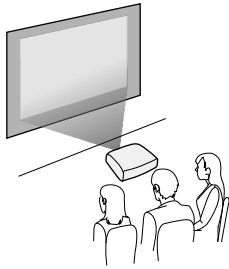

Rear

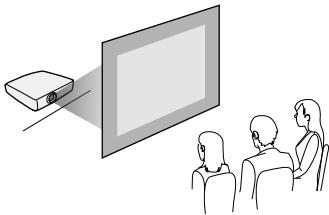

Front ceiling

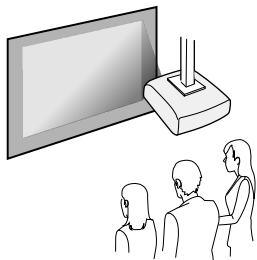

## Rear ceiling

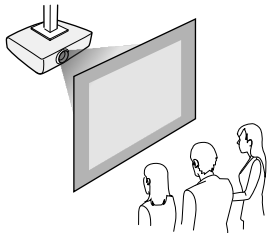

**Caution:** Be sure to leave at least 20 inches (50 cm) of space in front of the air exhaust and intake vents.

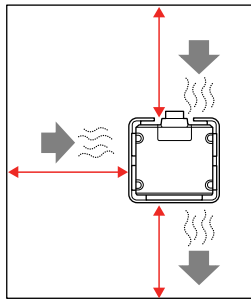

You can mount the projector to the ceiling at any horizontal or vertical angle.

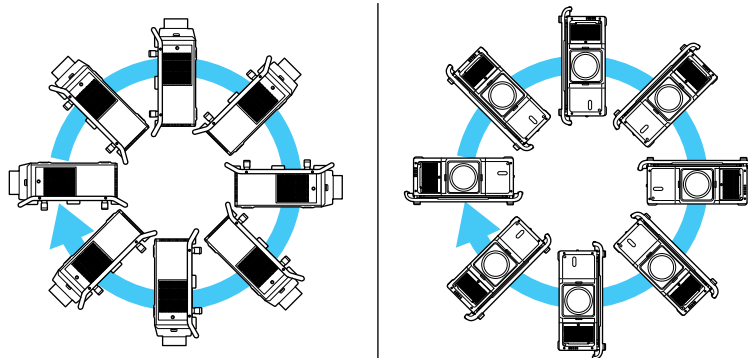

You can place the projector on its side to project a portrait image by attaching the optional mounting handle to the top of the projector. You can also remove the feet from the projector and attach them to the handles as shown here.

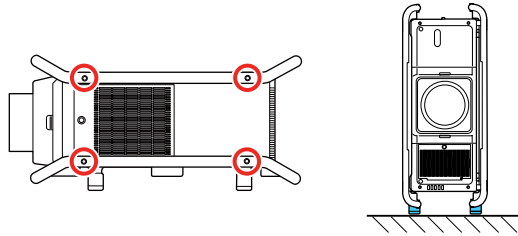

**Caution:** If you are setting up the projector with the intake vent on the bottom, be sure to leave the following amount of space around the projector.

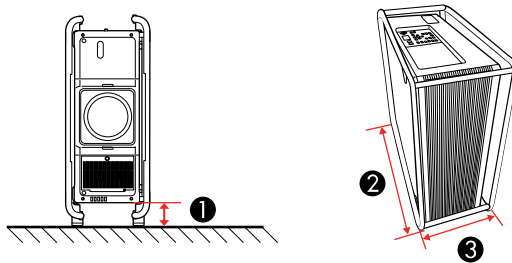

- 1 3.9 inches (10 cm)
- 2 31.5 inches (80 cm)
- 3 13.78 inches (35 cm)

If you are installing multiple projectors next to each other, be sure to leave at least 20 inches (50 cm) of space between the projectors.



If you are stacking multiple projectors, follow these guidelines:

- Do not stack more than three projectors.
- Align the top projector so that its feet is in the indentations on the bottom projector shown here.

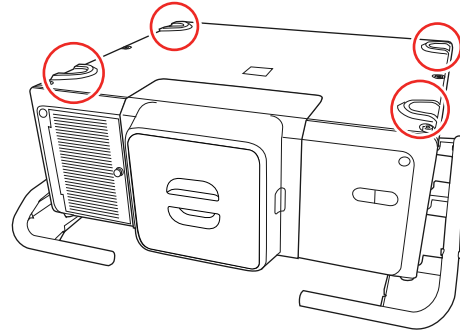

- Remove the projector's mounting handle when placing another projector on top of it.

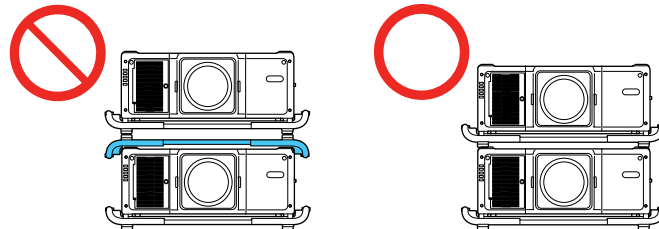

If you project from the ceiling or from the rear, select the correct **Projection** setting and, if necessary, turn on the **Inv Direction Button** setting and adjust the **OSD Rotation** setting.

**Parent topic:** [Projector Placement](#)

**Related references**

[Projector Setup Settings - Extended Menu](#)

## Projection Distance

The distance at which you place the projector from the screen determines the approximate size of the image. The image size increases the farther the projector is from the screen, but can vary depending on the zoom factor, aspect ratio, and other settings.

Use the tables here to determine approximately how far to place the projector from the screen based on the size of the projected image. (Conversion figures may have been rounded up or down.)

You can also use the projector Throw Distance Calculator at [epson.com/support](http://epson.com/support) (U.S.) or [epson.ca/support](http://epson.ca/support) (Canada).

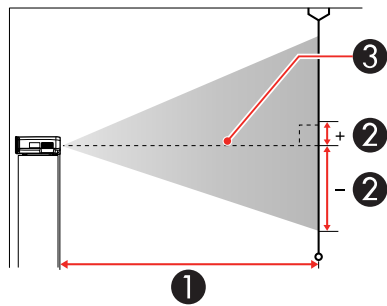
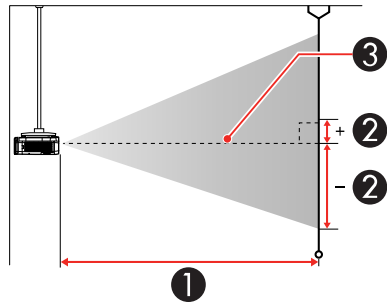

- 1 Projection distance
- 2 Distance from the center of the lens to the base of the image (varies depending on vertical lens shift)
- 3 Center of lens



**Rear-throw Zoom Lens (ELPLR05)**

<b>16:10 Aspect Ratio Image or Screen</b>		
<b>Screen or image size</b>	<b>Projection distance (1) Wide to Tele (Minimum to Maximum)</b>	<b>Vertical lens shift (2) Top to bottom</b>
100 inches	49 to 49 inches (125 to 125 cm)	-35.6 to -17.4 inches (-90 to -44 cm)
120 inches	60 to 60 inches (152 to 152 cm)	-42.7 to -20.9 inches (-109 to -53 cm)
150 inches	76 to 76 inches (193 to 193 cm)	-53.4 to -26.1 inches (-136 to -66 cm)
200 inches	102 to 102 inches (260 to 260 cm)	-71.2 to -34.8 inches (-181 to -88 cm)
250 inches	129 to 129 inches (328 to 328 cm)	-89 to -43.3 inches (-226 to -110 cm)
1000 inches	528 to 528 inches (1342 to 1342 cm)	-356.1 to -173.9 inches (-904 to -442 cm)

<b>16:9 Aspect Ratio Image or Screen</b>		
<b>Screen or image size</b>	<b>Projection distance (1) Wide to Tele (Minimum to Maximum)</b>	<b>Vertical lens shift (2) Top to bottom</b>
100 inches	51 to 51 inches (129 to 129 cm)	-33.9 to -15.2 inches (-86 to -38 cm)
120 inches	62 to 62 inches (157 to 157 cm)	-40.7 to -18.2 inches (-103 to -46 cm)
150 inches	78 to 78 inches (198 to 198 cm)	-50.8 to -22.7 inches (-129 to -58 cm)

<b>16:9 Aspect Ratio Image or Screen</b>		
<b>Screen or image size</b>	<b>Projection distance (1) Wide to Tele (Minimum to Maximum)</b>	<b>Vertical lens shift (2) Top to bottom</b>
200 inches	105 to 105 inches (268 to 268 cm)	-67.8 to -30.3 inches (-172 to -77 cm)
250 inches	133 to 133 inches (337 to 337 cm)	-84.6 to -37.8 inches (-215 to -96 cm)
972 inches	528 to 528 inches (1341 to 1341 cm)	-329.3 to -147.3 inches (-836 to -374 cm)

<b>4:3 Aspect Ratio Image or Screen</b>		
<b>Screen or image size</b>	<b>Projection distance (1) Wide to Tele (Minimum to Maximum)</b>	<b>Vertical lens shift (2) Top to bottom</b>
90 inches	50 to 50 inches (128 to 128 cm)	-36.3 to -17.7 inches (-92 to -45 cm)
100 inches	56 to 56 inches (143 to 143 cm)	-40.3 to -19.7 inches (-102 to -50 cm)
120 inches	68 to 68 inches (174 to 174 cm)	-48.4 to -23.6 inches (-123 to -60 cm)
150 inches	86 to 86 inches (219 to 219 cm)	-60.5 to -29.5 inches (-154 to -75 cm)
200 inches	117 to 117 inches (296 to 296 cm)	-80.6 to -39.4 inches (-205 to -100 cm)
250 inches	147 to 147 inches (373 to 373 cm)	-100.8 to -49.2 inches (-256 to -125 cm)

<b>4:3 Aspect Ratio Image or Screen</b>		
<b>Screen or image size</b>	<b>Projection distance (1) Wide to Tele (Minimum to Maximum)</b>	<b>Vertical lens shift (2) Top to bottom</b>
883 inches	528 to 528 inches (1342 to 1342 cm)	-356 to -173.8 inches (-904 to -442 cm)

**Short-throw Zoom Lens (ELPLU05)**

<b>16:10 Aspect Ratio Image or Screen</b>		
<b>Screen or image size</b>	<b>Projection distance (1) Wide to Tele (Minimum to Maximum)</b>	<b>Vertical lens shift (2) Top to bottom</b>
100 inches	75 to 91 inches (191 to 232 cm)	-55.8 to 2.8 inches (-142 to 7 cm)
120 inches	91 to 110 inches (231 to 280 cm)	-66.9 to 3.3 inches (-170 to 8 cm)
150 inches	114 to 139 inches (290 to 352 cm)	-83.6 to 4.1 inches (-212 to 11 cm)
200 inches	153 to 186 inches (389 to 472 cm)	-111.5 to 5.5 inches (-283 to 14 cm)
250 inches	192 to 192 inches (488 to 591 cm)	-139.4 to 7.1 inches (-354 to 18 cm)
1000 inches	778 to 940 inches (1977 to 2387 cm)	-557.6 to 27.6 inches (-1416 to 70 cm)

<b>16:9 Aspect Ratio Image or Screen</b>		
<b>Screen or image size</b>	<b>Projection distance (1) Wide to Tele (Minimum to Maximum)</b>	<b>Vertical lens shift (2) Top to bottom</b>
100 inches	77 to 94 inches (196 to 239 cm)	-54.6 to 5.6 inches (-139 to 14 cm)
120 inches	93 to 113 inches (237 to 288 cm)	-65.5 to 6.7 inches (-166 to 17 cm)
150 inches	117 to 142 inches (298 to 362 cm)	-81.9 to 8.3 inches (-208 to 21 cm)
200 inches	158 to 191 inches (400 to 485 cm)	-109.2 to 11.1 inches (-277 to 28 cm)
250 inches	197 to 239 inches (502 to 608 cm)	-136.6 to 13.8 inches (-347 to 35 cm)
972 inches	777 to 939 inches (1975 to 2385 cm)	-530.6 to 54.1 inches (-1348 to 137 cm)

<b>4:3 Aspect Ratio Image or Screen</b>		
<b>Screen or image size</b>	<b>Projection distance (1) Wide to Tele (Minimum to Maximum)</b>	<b>Vertical lens shift (2) Top to bottom</b>
90 inches	77 to 93 inches (195 to 237 cm)	-56.8 to 2.8 inches (-144 to 7 cm)
100 inches	85 to 104 inches (217 to 264 cm)	-63.1 to 3.1 inches (-160 to 8 cm)
120 inches	103 to 125 inches (262 to 318 cm)	-75.8 to 3.8 inches (-192 to 10 cm)

<b>4:3 Aspect Ratio Image or Screen</b>		
<b>Screen or image size</b>	<b>Projection distance (1) Wide to Tele (Minimum to Maximum)</b>	<b>Vertical lens shift (2) Top to bottom</b>
150 inches	130 to 157 inches (329 to 399 cm)	-94.7 to 4.7 inches (-214 to 12 cm)
200 inches	174 to 211 inches (442 to 535 cm)	-126.3 to 6.3 inches (-321 to 16 cm)
250 inches	218.1 to 264 inches (554 to 670 cm)	-157.9 to 7.9 inches (-401 to 20 cm)
883 inches	778 to 939 inches (1976 to 2386 cm)	-557.4 to 27.6 inches (-1416 to 70 cm)

**Wide-throw Zoom Lens (ELPLW07)**

<b>16:10 Aspect Ratio Image or Screen</b>		
<b>Screen or image size</b>	<b>Projection distance (1) Wide to Tele (Minimum to Maximum)</b>	<b>Vertical lens shift (2) Top to bottom</b>
100 inches	106 to 147 inches (272 to 375 cm)	-61 to 8 inches (-155 to 20 cm)
120 inches	129 to 177 inches (328 to 452 cm)	-73.2 to 9.6 inches (-186 to 24 cm)
150 inches	162 to 222 inches (413 to 567 cm)	-91.5 to 12 inches (-232 to 30 cm)
200 inches	218 to 298 inches (554 to 760 cm)	-122 to 16 inches (-310 to 41 cm)
250 inches	273 to 374 inches (695 to 952 cm)	-152.4 to 20.1 inches (-387 to 51 cm)

<b>16:10 Aspect Ratio Image or Screen</b>		
<b>Screen or image size</b>	<b>Projection distance (1) Wide to Tele (Minimum to Maximum)</b>	<b>Vertical lens shift (2) Top to bottom</b>
1000 inches	1107 to 1509 inches (2812 to 3840 cm)	-610.1 to 80.1 inches (-1550 to 203 cm)

<b>16:9 Aspect Ratio Image or Screen</b>		
<b>Screen or image size</b>	<b>Projection distance (1) Wide to Tele (Minimum to Maximum)</b>	<b>Vertical lens shift (2) Top to bottom</b>
100 inches	110 to 151 inches (280 to 385 cm)	-60 to 11 inches (-152 to 28 cm)
120 inches	132 to 182 inches (338 to 464 cm)	-72 to 13.1 inches (-183 to 33 cm)
150 inches	167 to 229 inches (425 to 583 cm)	-90 to 16.4 inches (-229 to 42 cm)
200 inches	224 to 307 inches (570 to 781 cm)	-120 to 21.9 inches (-305 to 56 cm)
250 inches	281 to 385 inches (715 to 979 cm)	-150 to 27.6 inches (-381 to 70 cm)
972 inches	1106 to 1507 inches (2809 to 3836 cm)	-583 to 106.4 inches (-1481 to 270 cm)

<b>4:3 Aspect Ratio Image or Screen</b>		
<b>Screen or image size</b>	<b>Projection distance (1) Wide to Tele (Minimum to Maximum)</b>	<b>Vertical lens shift (2) Top to bottom</b>
90 inches	109 to 150 inches (277 to 382 cm)	-62.2 to 8.2 inches (-158 to 21 cm)
100 inches	121 to 167 inches (309 to 425 cm)	-69.1 to 9.1 inches (-175 to 23 cm)
120 inches	146 to 201 inches (373 to 513 cm)	-82.9 to 10.9 inches (-211 to 28 cm)
150 inches	184 to 252 inches (469 to 643 cm)	-103.6 to 13.6 inches (-263 to 35 cm)
200 inches	247 to 338 inches (629 to 861 cm)	-138.1 to 18.1 inches (-351 to 46 cm)
250 inches	310 to 425 inches (788 to 1079 cm)	-172.8 to 22.8 inches (-439 to 58 cm)
883 inches	1106 to 1508 inches (2811 to 3838 cm)	-609.8 to 80 inches (-1549 to 203 cm)

**Middle-throw Zoom Lens #1 (ELPLM12)**

<b>16:10 Aspect Ratio Image or Screen</b>		
<b>Screen or image size</b>	<b>Projection distance (1) Wide to Tele (Minimum to Maximum)</b>	<b>Vertical lens shift (2) Top to bottom</b>
100 inches	145 to 197 inches (386 to 500 cm)	-61 to 8 inches (-155 to 20 cm)
120 inches	175 to 237 inches (444 to 602 cm)	-73.2 to 9.6 inches (-186 to 24 cm)

<b>16:10 Aspect Ratio Image or Screen</b>		
<b>Screen or image size</b>	<b>Projection distance (1) Wide to Tele (Minimum to Maximum)</b>	<b>Vertical lens shift (2) Top to bottom</b>
150 inches	220 to 297 inches (558 to 755 cm)	-91.5 to 12 inches (-232 to 30 cm)
200 inches	295 to 398 inches (749 to 1011 cm)	-122 to 16 inches (-310 to 41 cm)
250 inches	369 to 499 inches (939 to 1267 cm)	-152.4 to 20.1 inches (-387 to 51 cm)
1000 inches	1493 to 2009 inches (3794 to 5103 cm)	-610.1 to 80.1 inches (-1550 to 203 cm)

<b>16:9 Aspect Ratio Image or Screen</b>		
<b>Screen or image size</b>	<b>Projection distance (1) Wide to Tele (Minimum to Maximum)</b>	<b>Vertical lens shift (2) Top to bottom</b>
100 inches	149 to 202 inches (379 to 514 cm)	-60 to 11 inches (-152 to 28 cm)
120 inches	180 to 244 inches (457 to 619 cm)	-72 to 13.1 inches (-183 to 33 cm)
150 inches	226 to 306 inches (574 to 777 cm)	-90 to 16.4 inches (-229 to 42 cm)
200 inches	303 to 409 inches (770 to 1040 cm)	-120 to 21.9 inches (-305 to 56 cm)
250 inches	380 to 513 inches (965 to 1302 cm)	-150 to 27.6 inches (-381 to 70 cm)



<b>16:9 Aspect Ratio Image or Screen</b>		
<b>Screen or image size</b>	<b>Projection distance (1) Wide to Tele (Minimum to Maximum)</b>	<b>Vertical lens shift (2) Top to bottom</b>
972 inches	1492 to 2007 inches (3791 to 5099 cm)	-583 to 106.4 inches (-1481 to 270 cm)

<b>4:3 Aspect Ratio Image or Screen</b>		
<b>Screen or image size</b>	<b>Projection distance (1) Wide to Tele (Minimum to Maximum)</b>	<b>Vertical lens shift (2) Top to bottom</b>
90 inches	148 to 200 inches (375 to 509 cm)	-62.2 to 8.2 inches (-158 to 21 cm)
100 inches	165 to 223 inches (418 to 567 cm)	-69.1 to 9.1 inches (-175 to 23 cm)
120 inches	198 to 269 inches (504 to 683 cm)	-82.9 to 10.9 inches (-211 to 28 cm)
150 inches	249 to 337 inches (634 to 857 cm)	-103.6 to 13.6 inches (-263 to 35 cm)
200 inches	334 to 451 inches (849 to 1146 cm)	-138.1 to 18.1 inches (-351 to 46 cm)
250 inches	419 to 565 inches (1065 to 1436 cm)	-172.8 to 22.8 inches (-439 to 58 cm)
883 inches	1492 to 2008 inches (3793 to 5102 cm)	-609.8 to 80 inches (-1549 to 203 cm)

**Middle-throw Zoom Lens #2 (ELPLM13)**

<b>16:10 Aspect Ratio Image or Screen</b>		
<b>Screen or image size</b>	<b>Projection distance (1) Wide to Tele (Minimum to Maximum)</b>	<b>Vertical lens shift (2) Top to bottom</b>
100 inches	195 to 293 inches (482 to 738 cm)	-61 to 8 inches (-155 to 20 cm)
120 inches	234 to 352 inches (582 to 889 cm)	-73.2 to 9.6 inches (-186 to 24 cm)
150 inches	292 to 440 inches (731 to 1115 cm)	-91.5 to 12 inches (-232 to 30 cm)
200 inches	390 to 587 inches (981 to 1492 cm)	-122 to 16 inches (-310 to 41 cm)
250 inches	485 to 736 inches (1231 to 1869 cm)	-152.4 to 20.1 inches (-387 to 51 cm)
1000 inches	1949 to 2933 inches (4975 to 7526 cm)	-610.1 to 80.1 inches (-1550 to 203 cm)

<b>16:9 Aspect Ratio Image or Screen</b>		
<b>Screen or image size</b>	<b>Projection distance (1) Wide to Tele (Minimum to Maximum)</b>	<b>Vertical lens shift (2) Top to bottom</b>
100 inches	200 to 301 inches (496 to 759 cm)	-60 to 11 inches (-152 to 28 cm)
120 inches	240 to 362 inches (598 to 914 cm)	-72 to 13.1 inches (-183 to 33 cm)
150 inches	300 to 452 inches (752 to 1147 cm)	-90 to 16.4 inches (-229 to 42 cm)

<b>16:9 Aspect Ratio Image or Screen</b>		
<b>Screen or image size</b>	<b>Projection distance (1) Wide to Tele (Minimum to Maximum)</b>	<b>Vertical lens shift (2) Top to bottom</b>
200 inches	401 to 603 inches (1009 to 1534 cm)	-120 to 21.9 inches (-305 to 56 cm)
250 inches	1498 to 757 inches (1265 to 1922 cm)	-150 to 27.6 inches (-381 to 70 cm)
972 inches	1947 to 2930 inches (4970 to 7519 cm)	-583 to 106.4 inches (-1481 to 270 cm)

<b>4:3 Aspect Ratio Image or Screen</b>		
<b>Screen or image size</b>	<b>Projection distance (1) Wide to Tele (Minimum to Maximum)</b>	<b>Vertical lens shift (2) Top to bottom</b>
90 inches	199 to 299 inches (491 to 752 cm)	-62.2 to 8.2 inches (-158 to 21 cm)
100 inches	221 to 332 inches (548 to 838 cm)	-69.1 to 9.1 inches (-175 to 23 cm)
120 inches	265 to 398 inches (661 to 1009 cm)	-82.9 to 10.9 inches (-211 to 28 cm)
150 inches	331 to 498 inches (830 to 1265 cm)	-103.6 to 13.6 inches (-263 to 35 cm)
200 inches	441 to 664 inches (1113 to 1692 cm)	-138.1 to 18.1 inches (-351 to 46 cm)
250 inches	550 to 833.9 inches (1396 to 2118 cm)	-172.8 to 22.8 inches (-439 to 58 cm)

<b>4:3 Aspect Ratio Image or Screen</b>		
<b>Screen or image size</b>	<b>Projection distance (1) Wide to Tele (Minimum to Maximum)</b>	<b>Vertical lens shift (2) Top to bottom</b>
883 inches	1948 to 2932 inches (4973 to 7523 cm)	-609.8 to 80 inches (-1549 to 203 cm)

**Middle-throw Zoom Lens #3 (ELPLM14)**

<b>16:10 Aspect Ratio Image or Screen</b>		
<b>Screen or image size</b>	<b>Projection distance (1) Wide to Tele (Minimum to Maximum)</b>	<b>Vertical lens shift (2) Top to bottom</b>
100 inches	289 to 433 inches (735 to 1100 cm)	-61 to 8 inches (-155 to 20 cm)
120 inches	347 to 520 inches (882 to 1320 cm)	-73.2 to 99.6 inches (-186 to 24 cm)
150 inches	434 to 650 inches (1103 to 1650 cm)	-91.5 to 12 inches (-232 to 30 cm)
200 inches	579 to 866 inches (1470 to 2200 cm)	-122 to 16 inches (-310 to 41 cm)
250 inches	724 to 1083 inches (1838 to 2750 cm)	-152.4 to 20.1 inches (-387 to 51 cm)
1000 inches	2894 to 4331 inches (7350 to 11000 cm)	-610.1 to 80.1 inches (-1550 to 203 cm)

<b>16:9 Aspect Ratio Image or Screen</b>		
<b>Screen or image size</b>	<b>Projection distance (1) Wide to Tele (Minimum to Maximum)</b>	<b>Vertical lens shift (2) Top to bottom</b>
100 inches	297 to 445 inches (755 to 1131 cm)	-60 to 11 inches (-152 to 28 cm)
120 inches	357 to 534 inches (907 to 1357 cm)	-72 to 13.1 inches (-183 to 33 cm)
150 inches	446 to 668 inches (1133 to 1696 cm)	-90 to 16.4 inches (-229 to 42 cm)
200 inches	595 to 890 inches (1511 to 2261 cm)	-120 to 21.9 inches (-305 to 56 cm)
250 inches	743 to 112.6 inches (1889 to 2826 cm)	-150 to 27.6 inches (-381 to 70 cm)
972 inches	2891 to 4326 inches (7343 to 10989 cm)	-583 to 106.4 inches (-1481 to 270 cm)

<b>4:3 Aspect Ratio Image or Screen</b>		
<b>Screen or image size</b>	<b>Projection distance (1) Wide to Tele (Minimum to Maximum)</b>	<b>Vertical lens shift (2) Top to bottom</b>
90 inches	295 to 441 inches (749 to 1121 cm)	-62.2 to 8.2 inches (-158 to 21 cm)
100 inches	328 to 490 inches (832 to 1245 cm)	-69.1 to 9.1 inches (-175 to 23 cm)
120 inches	393 to 588 inches (998 to 1494 cm)	-82.9 to 10.9 inches (-211 to 28 cm)

<b>4:3 Aspect Ratio Image or Screen</b>		
<b>Screen or image size</b>	<b>Projection distance (1) Wide to Tele (Minimum to Maximum)</b>	<b>Vertical lens shift (2) Top to bottom</b>
150 inches	491 to 735 inches (1248 to 1868 cm)	-103.6 to 13.6 inches (-263 to 35 cm)
200 inches	655 to 981 inches (1664 to 2491 cm)	-138.1 to 18.1 inches (-351 to 46 cm)
250 inches	819 to 1226 inches (2080 to 3113 cm)	-172.8 to 22.8 inches (-439 to 58 cm)
883 inches	2893 to 4329 inches (7347 to 10996 cm)	-609.8 to 80 inches (-1549 to 203 cm)

**Long-throw Zoom Lens #1 (ELPLL09)**

<b>16:10 Aspect Ratio Image or Screen</b>		
<b>Screen or image size</b>	<b>Projection distance (1) Wide to Tele (Minimum to Maximum)</b>	<b>Vertical lens shift (2) Top to bottom</b>
100 inches	415 to 619 inches (1054 to 1574 cm)	-55.8 to 2.8 inches (-142 to 7 cm)
120 inches	494 to 740 inches (1256 to 1879 cm)	-66.9 to 3.3 inches (-170 to 8 cm)
150 inches	614 to 921 inches (1559 to 2338 cm)	-83.6 to 4.1 inches (-212 to 11 cm)
200 inches	812 to 1222 inches (2064 to 3103 cm)	-111.5 to 5.5 inches (-283 to 14 cm)
250 inches	1011 to 1523 inches (2569 to 3868 cm)	-139.4 to 7.1 inches (-354 to 18 cm)

<b>16:10 Aspect Ratio Image or Screen</b>		
<b>Screen or image size</b>	<b>Projection distance (1) Wide to Tele (Minimum to Maximum)</b>	<b>Vertical lens shift (2) Top to bottom</b>
1000 inches	3993 to 6040 inches (10142 to 15342 cm)	-557.6 to 27.6 inches (-1416 to 70 cm)

<b>16:9 Aspect Ratio Image or Screen</b>		
<b>Screen or image size</b>	<b>Projection distance (1) Wide to Tele (Minimum to Maximum)</b>	<b>Vertical lens shift (2) Top to bottom</b>
100 inches	426 to 636 inches (1082 to 1616 cm)	-54.6 to 5.6 inches (-139 to 14 cm)
120 inches	508 to 760 inches (1289 to 1931 cm)	-65.5 to 6.7 inches (-166 to 17 cm)
150 inches	630 to 946 inches (1601 to 2402 cm)	-81.9 to 8.3 inches (-208 to 21 cm)
200 inches	835 to 1255 inches (2120 to 3188 cm)	-109.2 to 11.1 inches (-277 to 28 cm)
250 inches	1038 to 1565 inches (2639 to 3975 cm)	-136.6 to 13.8 inches (-347 to 35 cm)
1000 inches	3989 to 6034 inches (10133 to 15327 cm)	-530.6 to 54.1 inches (-1348 to 137 cm)

<b>4:3 Aspect Ratio Image or Screen</b>		
<b>Screen or image size</b>	<b>Projection distance (1) Wide to Tele (Minimum to Maximum)</b>	<b>Vertical lens shift (2) Top to bottom</b>
90 inches	422 to 631 inches (1073 to 1602 cm)	-56.8 to 2.8 inches (-144 to 7 cm)
100 inches	467 to 699 inches (1187 to 1776 cm)	-63.1 to 3.1 inches (-160 to 8 cm)
120 inches	557 to 835 inches (1416 to 2122 cm)	-75.8 to 3.8 inches (-192 to 10 cm)
150 inches	692 to 1040 inches (1759 to 2642 cm)	-94.7 to 4.7 inches (-241 to 12 cm)
200 inches	917 to 1381 inches (2330 to 3508 cm)	-126.3 to 6.3 inches (-321 to 16 cm)
250 inches	1143 to 1722 inches (2902 to 4373 cm)	-158 to 7.9 inches (-401 to 20 cm)
883 inches	3992 to 6038 inches (10139 to 15337 cm)	-557.4 to 27.6 inches (-1416 to 70 cm)

**Long-throw Zoom Lens #2 (ELPLL10)**

<b>16:10 Aspect Ratio Image or Screen</b>		
<b>Screen or image size</b>	<b>Projection distance (1) Wide to Tele (Minimum to Maximum)</b>	<b>Vertical lens shift (2) Top to bottom</b>
100 inches	604 to 899 inches (1533 to 2284 cm)	-55.8 to 2.8 inches (-142 to 7 cm)
120 inches	719 to 1074 inches (1826 to 2727 cm)	-66.9 to 3.3 inches (-170 to 8 cm)



<b>16:10 Aspect Ratio Image or Screen</b>		
<b>Screen or image size</b>	<b>Projection distance (1) Wide to Tele (Minimum to Maximum)</b>	<b>Vertical lens shift (2) Top to bottom</b>
150 inches	892 to 1336 inches (2265 to 3392 cm)	-83.6 to 4.1 inches (-212 to 11 cm)
200 inches	1180 to 1772 inches (2997 to 4500 cm)	-111.5 to 5.5 inches (-283 to 14 cm)
250 inches	1468 to 2208 inches (3728 to 5608 cm)	-139.4 to 7.1 inches (-354 to 18 cm)
1000 inches	5788 to 8750 inches (14701 to 22225 cm)	-557.6 to 27.6 inches (-1416 to 70 cm)

<b>16:9 Aspect Ratio Image or Screen</b>		
<b>Screen or image size</b>	<b>Projection distance (1) Wide to Tele (Minimum to Maximum)</b>	<b>Vertical lens shift (2) Top to bottom</b>
100 inches	620 to 924 inches (1574 to 2346 cm)	-54.6 to 5.6 inches (-139 to 14 cm)
120 inches	738 to 1103 inches (1875 to 2801 cm)	-65.5 to 6.7 inches (-166 to 17 cm)
150 inches	916 to 1372 inches (2326 to 3485 cm)	-81.9 to 8.3 inches (-208 to 21 cm)
200 inches	1212 to 1820 inches (3078 to 4623 cm)	-109.2 to 11.1 inches (-277 to 28 cm)
250 inches	1508 to 2269 inches (3830 to 5762 cm)	-136.6 to 13.8 inches (-347 to 35 cm)

<b>16:9 Aspect Ratio Image or Screen</b>		
<b>Screen or image size</b>	<b>Projection distance (1) Wide to Tele (Minimum to Maximum)</b>	<b>Vertical lens shift (2) Top to bottom</b>
972 inches	5782 to 8742 inches (14687 to 22204 cm)	-530.6 to 54.1 inches (-1348 to 137 cm)

<b>4:3 Aspect Ratio Image or Screen</b>		
<b>Screen or image size</b>	<b>Projection distance (1) Wide to Tele (Minimum to Maximum)</b>	<b>Vertical lens shift (2) Top to bottom</b>
90 inches	615 to 916 inches (1561 to 2326 cm)	-56.8 to 2.8 inches (-144 to 7 cm)
100 inches	680 to 1015 inches (1727 to 2577 cm)	-63.1 to 3.1 inches (-160 to 8 cm)
120 inches	810 to 1212 inches (2058 to 3079 cm)	-75.8 to 3.8 inches (-192 to 10 cm)
150 inches	1006 to 1508 inches (2555 to 3831 cm)	-94.7 to 4.7 inches (-241 to 12 cm)
200 inches	1332 to 2002 inches (3383 to 5085 cm)	-126.3 to 6.3 inches (-321 to 16 cm)
250 inches	1658 to 2496 inches (4211 to 6339 cm)	-157.9 to 7.9 inches (-401 to 20 cm)
883 inches	5786 to 8747 inches (14695 to 22217 cm)	-557.4 to 27.6 inches (-1416 to 70 cm)

Parent topic: [Projector Placement](#)

## Projector Connections

See these sections to connect the projector to a variety of projection sources.

**Caution:** If you will use the projector at altitudes above 4921 feet (1500 m), turn on **High Altitude Mode** to ensure the projector's internal temperature is regulated properly.

[Connecting to Video Sources](#)

[Connecting to Computer Sources](#)

[Connecting to an HDBaseT Transmitter](#)

[Connecting to an External Computer Monitor](#)

**Parent topic:** [Setting Up the Projector](#)

**Related references**

[Projector Setup Settings - Extended Menu](#)

## Connecting to Video Sources

Follow the instructions in these sections to connect video devices to the projector.

[Connecting to an HDMI Video Source](#)

[Connecting to a Component-to-BNC Video Source](#)

[Connecting to a Component Video Source](#)

[Connecting to an SDI Video Source](#)

**Parent topic:** [Projector Connections](#)

### Connecting to an HDMI Video Source

If your video source has an HDMI port, you can connect it to the projector using an optional HDMI cable. The HDMI connection provides the best image quality.

1. Connect the HDMI cable to your video source's HDMI output port.
2. Connect the other end to the projector's **HDMI** port.

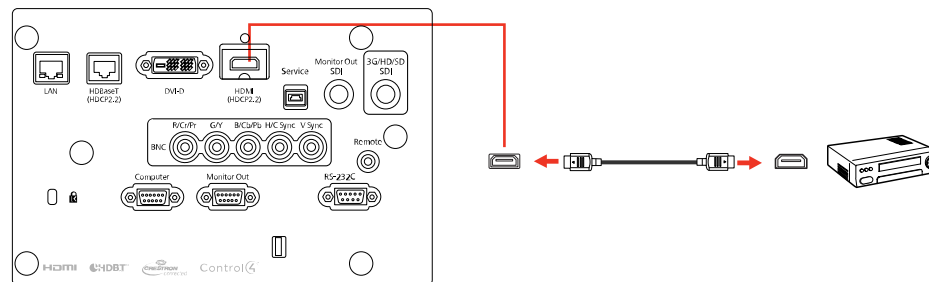

Parent topic: [Connecting to Video Sources](#)

### Connecting to a Component-to-BNC Video Source

If your video source has component video ports, you can connect it to the projector using an optional component-to-BNC video cable. Depending on your component ports, you may need to use an adapter cable along with a component video cable.

1. Connect the component connectors to your video source's color-coded component video output ports, usually labeled **Y**, **Pb**, **Pr** or **Y**, **Cb**, **Cr**. If you are using an adapter, connect these connectors to your component video cable.
2. Connect the BNC connectors to the projector's **R/Cr/Pr**, **G/Y**, **B/Cb/Pb** ports.

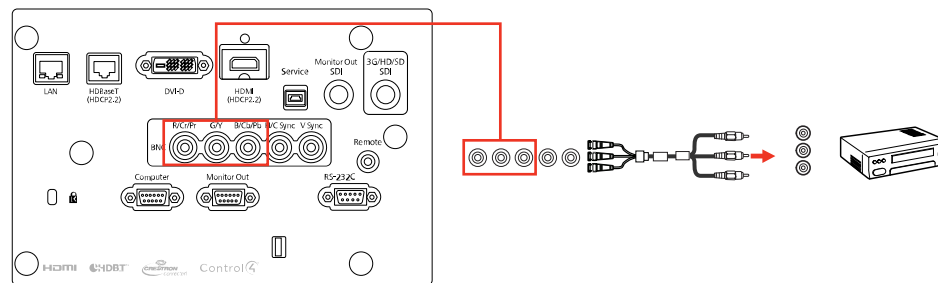

Parent topic: [Connecting to Video Sources](#)

### Connecting to a Component Video Source

If your video source has component video ports, you can connect it to the projector using an optional component-to-VGA video cable. Depending on your component ports, you may need to use an adapter cable along with a component video cable.

1. Connect the component connectors to your video source's color-coded component video output ports, usually labeled **Y**, **Pb**, **Pr** or **Y**, **Cb**, **Cr**. If you are using an adapter, connect these connectors to your component video cable.

2. Connect the VGA connector to a **Computer** port on the projector.

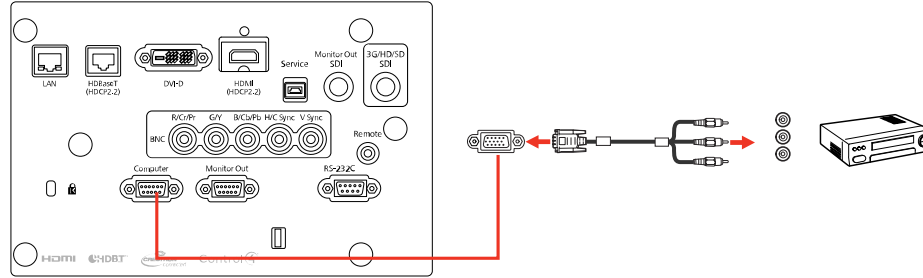

3. Tighten the screws on the VGA connector.

If your image colors appear incorrect, you may need to change the **Input Signal** setting in the projector's Signal menu.

**Parent topic:** [Connecting to Video Sources](#)

**Related references**

[Input Signal Settings - Signal Menu](#)

### Connecting to an SDI Video Source

If your video source has an SDI port, you can connect it to the projector using an optional BNC video cable.

1. Connect the BNC video cable to your video source's SDI output port.
2. Connect the other end to the projector's **3G/HD/SD SDI** port.

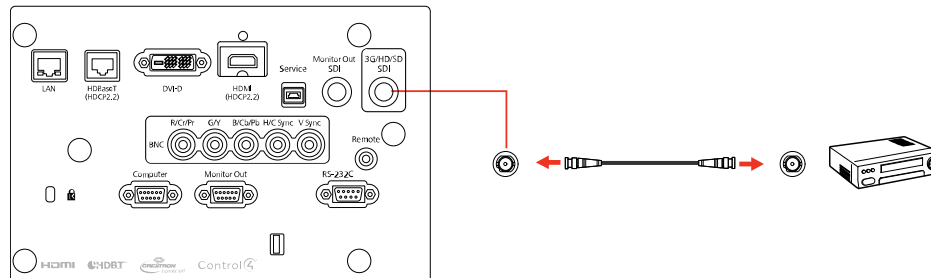

**Parent topic:** [Connecting to Video Sources](#)

## Connecting to Computer Sources

Follow the instructions in these sections to connect a computer to the projector.

[Connecting to a Computer for VGA Video](#)

[Connecting to a Computer for HDMI Video](#)

[Connecting to a Computer for DVI-D Video](#)

[Connecting to a Computer for 5 BNC Video](#)

**Parent topic:** [Projector Connections](#)

### Connecting to a Computer for VGA Video

You can connect the projector to your computer using a VGA computer cable.

**Note:** To connect a Mac that includes only a Mini DisplayPort, Thunderbolt port, or Mini-DVI port for video output, you need to obtain an adapter that allows you to connect to the projector's VGA video port. Contact Apple for compatible adapter options.

1. If necessary, disconnect your computer's monitor cable.
2. Connect the VGA computer cable to your computer's monitor port.
3. Connect the other end to a **Computer** port on the projector.

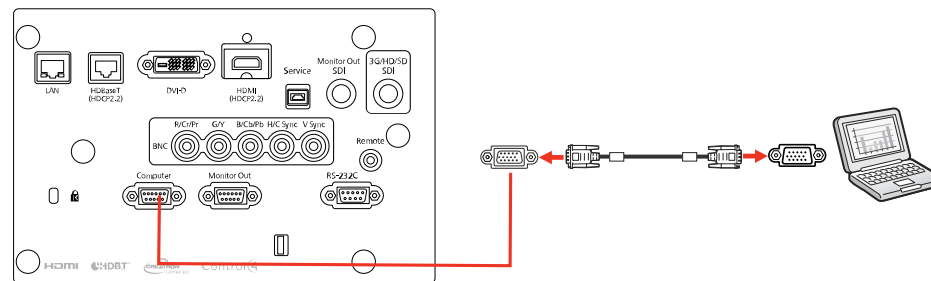

4. Tighten the screws on the VGA connector.

**Parent topic:** [Connecting to Computer Sources](#)

### Connecting to a Computer for HDMI Video

If your computer has an HDMI port, you can connect it to the projector using an optional HDMI cable.

**Note:** To connect a Mac that includes only a Mini DisplayPort, Thunderbolt port, or Mini-DVI port for video output, you need to obtain an adapter that allows you to connect to the projector's **HDMI** port. Contact Apple for compatible adapter options.

1. Connect the HDMI cable to your computer's HDMI output port.
2. Connect the other end to the projector's **HDMI** port.

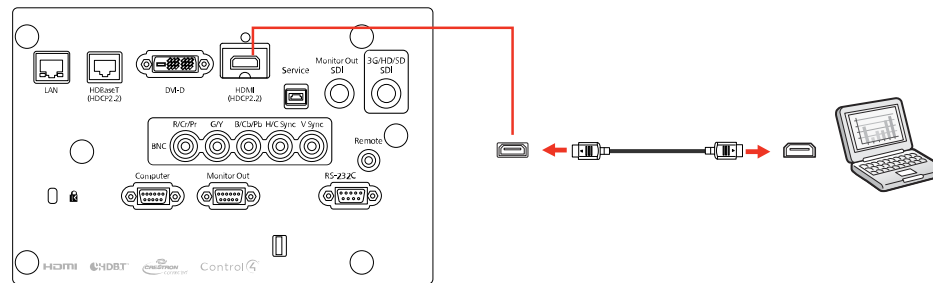

**Parent topic:** [Connecting to Computer Sources](#)

### Connecting to a Computer for DVI-D Video

If your computer has a DVI-D connector, you can connect it to the projector using an optional DVI-D cable.

1. Connect the DVI-D cable to your computer's DVI-D connector.
2. Connect the other end to the projector's **DVI-D** connector.

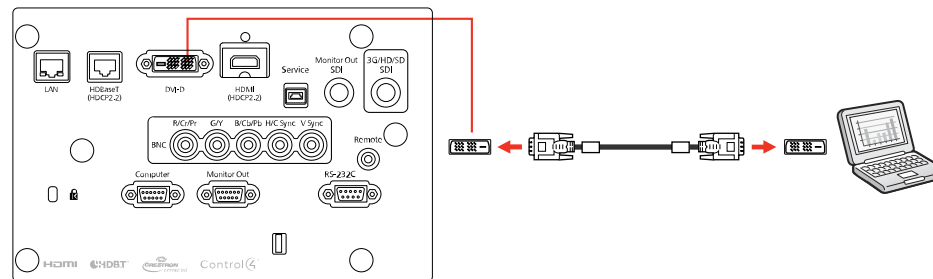

**Parent topic:** [Connecting to Computer Sources](#)

## Connecting to a Computer for 5 BNC Video

You can connect the projector to your computer using an optional VGA-to-5-BNC cable.

1. Connect the VGA connector to your computer's monitor port.
2. Connect the 5 BNC connectors to the projector's **BNC** ports.

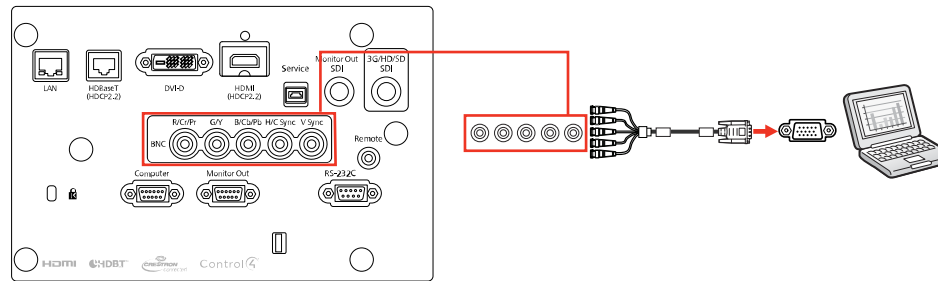

Parent topic: [Connecting to Computer Sources](#)

## Connecting to an HDBaseT Transmitter

To send an HDMI or RS-232C signal over a long distance, you can connect the projector to an optional HDBaseT transmitter using a 100Base-TX network cable. This is useful when you want to send a signal to or control the projector from a remote location, such as in a hall or event site, since you can use a network cable up to 328 feet (100 m) in length. To ensure proper data transmission, use a Category 6 STP cable or better.

1. Turn off the projector and HDBaseT transmitter.

**Note:** Make sure the projector and HDBaseT transmitter are turned off when connecting or disconnecting a network cable between the two devices.

2. Connect one end of the network cable to the **HDBaseT** port on the transmitter.



3. Connect the other end to the projector's **HDBaseT** port.

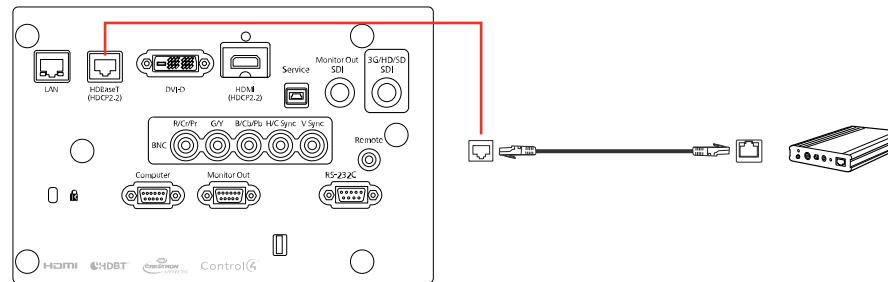

**Note:** See the documentation that came with the HDBaseT transmitter for instructions on connecting it to your video device or computer.

4. Turn on the projector and HDBaseT transmitter.

**Note:** To enable communication from the Ethernet and serial ports on the transmitter, select **On** as the **Control Communications** setting in the projector's Extended menu. Turning on this setting disables the projector's **LAN**, **RS-232C**, and **Remote** ports.

**Parent topic:** [Projector Connections](#)

**Related references**

[Projector Setup Settings - Extended Menu](#)

## Connecting to an External Computer Monitor

If you connected a computer to the projector's **Computer** or **BNC** port, or a video source to the projector's **3G/HD/SD SDI** port, you can also connect an external monitor to the projector. This lets you see your presentation on the external monitor even when the projected image is not visible.

If you want to output images to an external monitor when the projector is turned off, you need to select **Communication On** as the **Standby Mode** setting and **Always On** as the **A/V Output** setting in the projector's Extended menu.

**Note:** Monitors that use a refresh rate less than 60 Hz may not be able to display images correctly.

1. Make sure your computer or video source is connected to the projector's **Computer**, **BNC**, or **3G/HD/SD SDI** port.

2. Connect the external monitor's cable to your projector's **Monitor Out** (for computer or BNC sources) or **Monitor Out SDI** (for SDI sources) port.

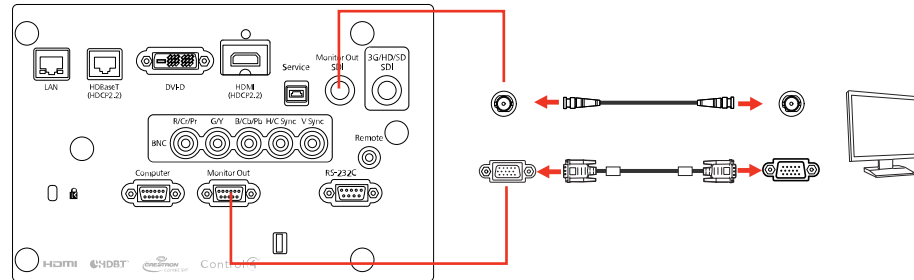

**Note:** If you do not see an image on the external monitor when projecting from a computer or BNC source, you may need to change the **Monitor Out** setting in the Extended menu.

**Parent topic:** [Projector Connections](#)

**Related references**

[Projector Setup Settings - Extended Menu](#)

## Attaching and Removing a Lens

Follow the instructions in these sections to attach or remove a compatible lens.

[Attaching a Lens](#)

[Removing a Lens](#)

**Parent topic:** [Setting Up the Projector](#)

### Attaching a Lens

You can attach a compatible lens to the projector.

1. Turn off the projector and unplug the power cord.

**Caution:** Unplug the power cord from the projector before attaching the lens. Avoid touching the lens with your bare hands to prevent fingerprints on or damage to the lens surface.

2. Press the tabs on both sides of the lens cover and pull the lens cover off the projector.

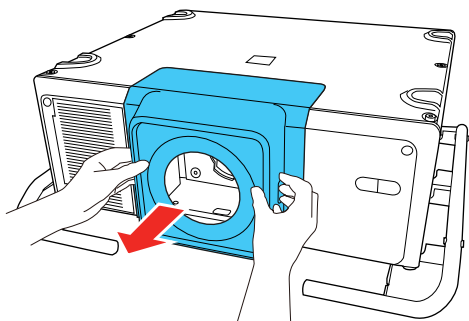

3. Slide the lock lever to the left.

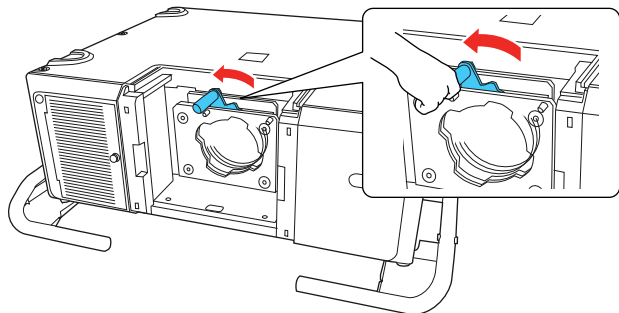

4. Insert the lens unit straight into the projector's lens socket. Make sure the two protruding points in the lens socket fit into the holes on the lens unit.

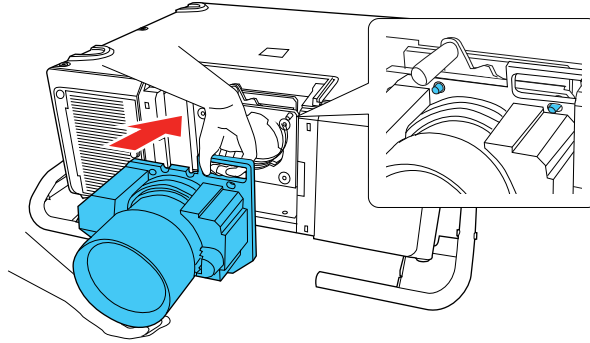

**Caution:** Avoid touching the areas shown here or you may damage the lens unit.

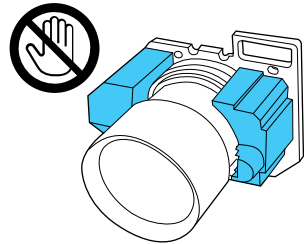

5. Hold the lens unit firmly and slide the lock lever to the right until it clicks, indicating that it is locked.

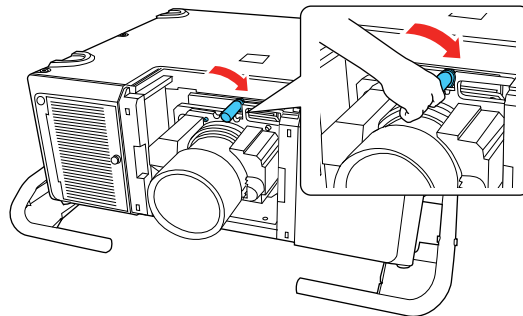

6. Replace the lens cover.

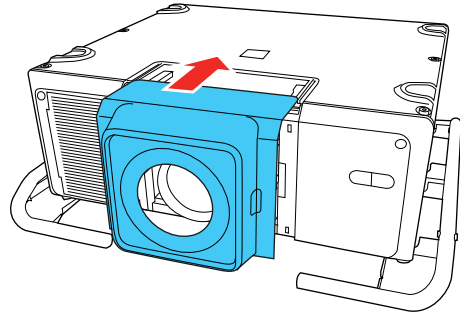

7. Do one of the following:

- If you attach a lens that is different from the previous lens, you see a message to calibrate the lens the next time you turn on the projector. Select **Yes** to calibrate the lens.
- If you remove and attach the same lens, press and hold the **Default** button or select **Lens Calibration** in the Extended menu to calibrate the lens.

Lens calibration takes up to 3 minutes to complete. When calibration is finished, the lens returns to its previous position.

**Caution:** If you see a message that lens calibration failed, turn off the projector, unplug the power cord, and contact Epson.

**Parent topic:** [Attaching and Removing a Lens](#)

#### **Related references**

[Projector Setup Settings - Extended Menu](#)

## **Removing a Lens**

You can remove a lens to replace it with a different lens.

**Caution:** Remove the lens only when necessary and make sure the front of the projector is not facing up when you remove the lens. This prevents dirt or dust from entering the projector and lowering the projection quality. Avoid touching the lens with your bare hands to prevent fingerprints on or damage to the lens surface.

1. Center the lens using the **Lens Shift** button.

2. Turn off the projector and unplug the power cord.
3. Press the tabs on both sides of the lens cover and pull the lens cover off the projector.

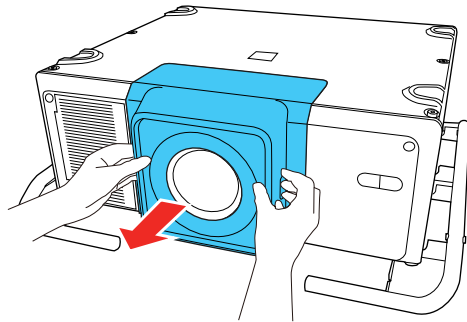

4. Hold the lens unit firmly as you slide the lock lever to the left.

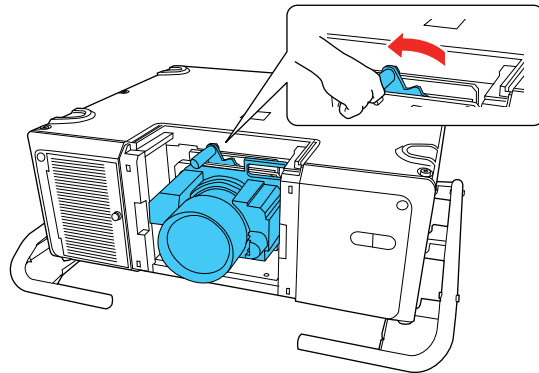

**Caution:** Avoid touching the areas shown here or you may damage the lens unit.

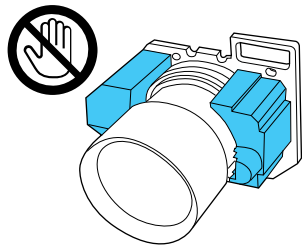

5. Gently pull the lens straight out of the projector.

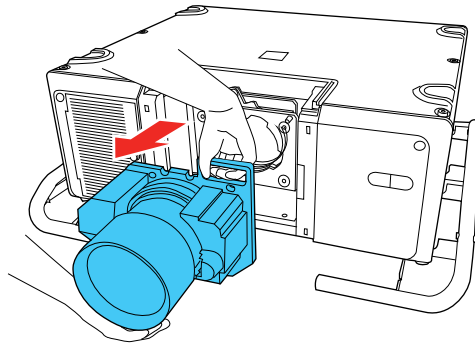

Parent topic: [Attaching and Removing a Lens](#)

## Securing the Power Cord

You can provide additional support to the power cord by securing it with the power cord holder.

1. Plug in the power cord.
2. Flip the power cord holder over the power cord as shown.

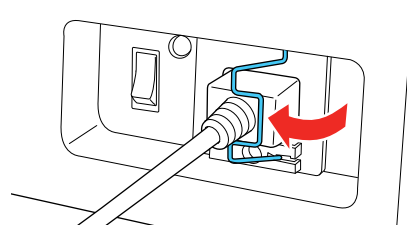

Parent topic: [Setting Up the Projector](#)

## Attaching and Removing the HDMI Cable Clip

You can install the HDMI cable clip that came with your projector to provide additional support to the HDMI cable.

1. Plug in the HDMI cable.

2. Insert the end of the cable clip anchor into the cable clip slot near the **HDMI** port.

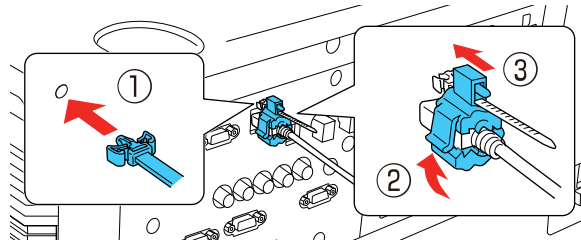

3. Place the open cable clip around the HDMI cable, but don't lock it into place.
4. Slide the cable clip onto the anchor and lock the clip onto the HDMI connector.

To remove the cable clip, open the clip and disconnect the HDMI cable. Then pinch the sides of the cable clip anchor and carefully pull it out of the cable clip slot.

**Parent topic:** [Setting Up the Projector](#)

## Installing Batteries in the Remote Control

The remote control uses the two AA batteries that came with the projector.

**Caution:** Use only the type of batteries specified in this manual. Do not install batteries of different types, or mix new and old batteries.

1. Remove the battery cover.

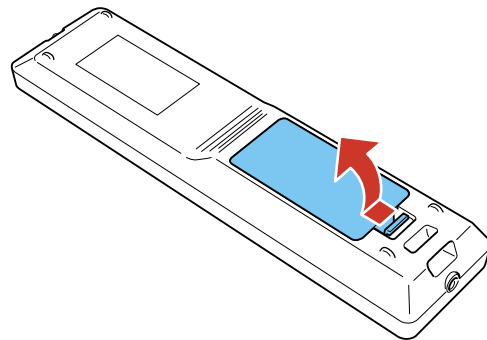



2. Insert the batteries with the + and – ends facing as shown.

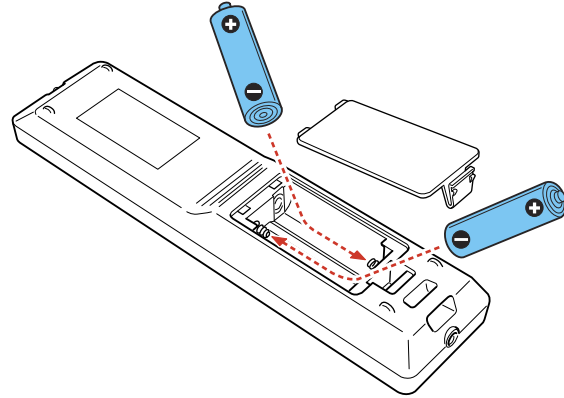

3. Replace the battery cover and press it down until it clicks into place.

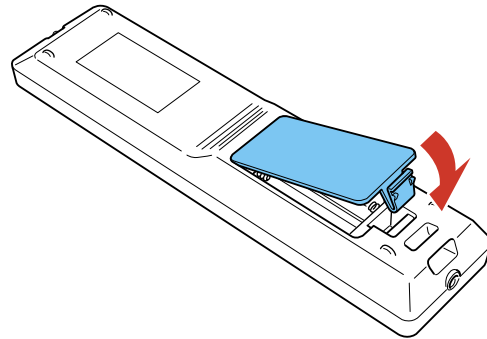

**Warning:** Dispose of used batteries according to local regulations. Do not expose batteries to heat or flame. Keep batteries out of the reach of children; they are choking hazards and are very dangerous if swallowed.

Parent topic: [Setting Up the Projector](#)

---

# Using the Projector on a Network

Follow the instructions in these sections to set up your projector for use on a network.

[Wired Network Projection](#)

[Wireless Network Projection](#)

[Setting Up Projector Network E-Mail Alerts](#)

[Selecting Other Network Settings](#)

[Controlling a Networked Projector Using a Web Browser](#)

[Crestron RoomView Support](#)

## Wired Network Projection

You can project through a wired network. To do this, you connect the projector to your network, and then set up your projector and computer for network projection.

After connecting and setting up the projector as described here, install the network software from the included CD or download the software and manuals as necessary.

**Note:** If your projector is connected via a LAN cable to a network that includes a wireless access point, you can connect to the projector wirelessly through the access point using the Epson network software.

[Connecting to a Wired Network](#)

[Selecting Wired Network Settings](#)

**Parent topic:** [Using the Projector on a Network](#)

**Related references**

[Additional Projector Software and Manuals](#)

## Connecting to a Wired Network

To connect the projector to a wired local area network (LAN), use a 100Base-TX or 10Base-T network cable. To ensure proper data transmission, use a Category 5 shielded cable or better.

1. Connect one end of the network cable to your network hub, switch, or router.

2. Connect the other end of the cable to the projector's **LAN** port.

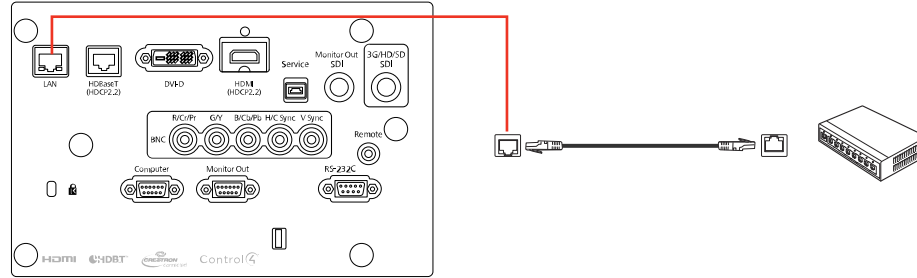

Parent topic: [Wired Network Projection](#)

## Selecting Wired Network Settings

Before you can project from computers on your network, you must select the network settings for the projector using its menu system.

**Note:** Make sure you already connected the projector to your wired network using the **LAN** port.

1. Turn on the projector.
2. Press the **Menu** button.
3. Select the **Network** menu and press **Enter**.

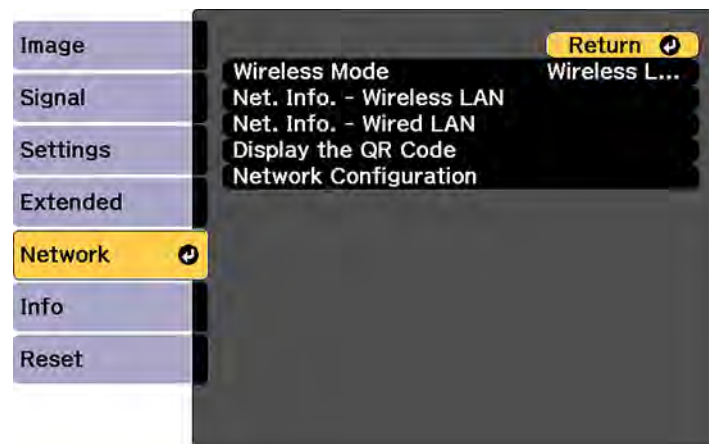

4. Select **Network Configuration** and press **Enter**.
5. Select the **Basic** menu and press **Enter**.

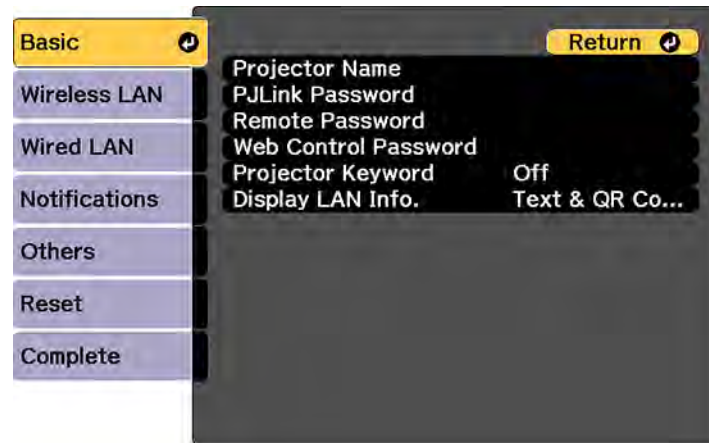

6. Select the following basic options as necessary:
  - **Projector Name** lets you enter a name up to 16 alphanumeric characters long to identify the projector over the network.
  - **PJLink Password** lets you enter a password up to 32 alphanumeric characters long for using the PJLink protocol for projector control.
  - **Remote Password** lets you enter a password up to 8 alphanumeric characters long for accessing the Remote or Basic Control screen in Epson Web Control. (Default user name is **EPSONREMOTE**; default password is **guest**.)
  - **Web Control Password** lets you enter a password up to 8 alphanumeric characters long for accessing Epson Web Control. (Default user name is **EPSONWEB**; default password is **admin**.)
  - **Projector Keyword** lets you turn on a security password to prevent access to the projector by anyone not in the room with it. You must enter a displayed, randomized keyword from a computer using the EasyMP Multi PC Projection software to access the projector.

- **Display LAN Info** lets you select how the projector displays network information. You can select an option to display a QR code that lets you quickly connect your iOS or Android devices using the Epson iProjection app.

**Note:** Use the displayed keyboard to enter the name, passwords, and keyword. Press the arrow buttons on the remote control to highlight characters and press **Enter** to select them.

7. Select the **Wired LAN** menu and press **Enter**.

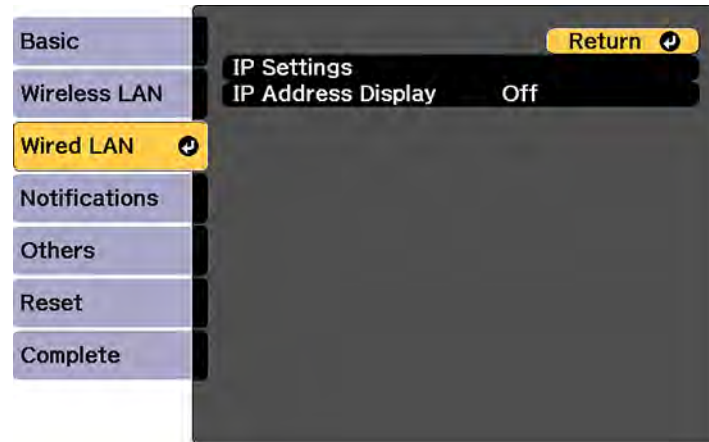

8. Select your IP Settings as necessary:
  - If your network assigns addresses automatically, turn on the **DHCP** setting.
  - If you must set addresses manually, turn off **DHCP** and enter the projector's **IP Address**, **Subnet Mask**, and **Gateway Address** as needed.

**Note:** To highlight the numbers you want from the displayed keyboard, press the arrow buttons on the remote control. To select a highlighted number, press **Enter**.

9. To prevent display of the IP address on the standby screen, turn off **IP Address Display**.
10. When you finish selecting settings, select **Complete** and follow the on-screen instructions to save your settings and exit the menus.

**Parent topic:** [Wired Network Projection](#)

## Wireless Network Projection

You can project over a wireless network. To do this, you must set up your projector and computer for wireless projection.

**Note:** The Epson 802.11b/g/n wireless LAN module is not included with your projector and is optional.

To connect wirelessly to your projector, configure the connection using the projector's Network menus. After setting up the projector as described here, install the network software from the included CD or download the software and manuals as necessary.

**Note:** If your projector is connected via a LAN cable to a network that includes a wireless access point, you can connect to the projector wirelessly through the access point using the Epson network software.

[Installing the Wireless LAN Module](#)

[Using a QR Code to Connect a Mobile Device](#)

[Selecting Wireless Network Settings Manually](#)

[Selecting Wireless Network Settings in Windows](#)

[Selecting Wireless Network Settings on Mac](#)

**Parent topic:** [Using the Projector on a Network](#)

### Related references

[Additional Projector Software and Manuals](#)

[Optional Equipment and Replacement Parts](#)

## Installing the Wireless LAN Module

To use the projector over a wireless network, install the optional Epson 802.11b/g/n wireless LAN module. Do not install any other type of wireless LAN module.

**Caution:** Never remove the module while its indicator light is green or flashing, or while you are projecting wirelessly. You may damage the module or lose data.

1. Remove the screw securing the wireless LAN module port cover.

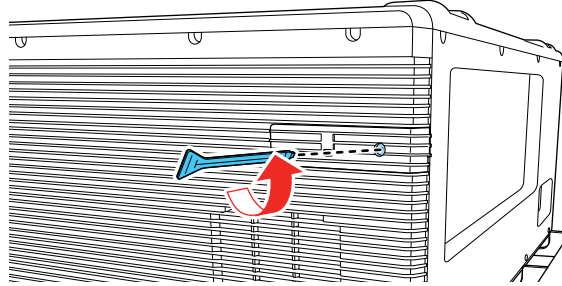

2. Remove the wireless LAN module port cover.

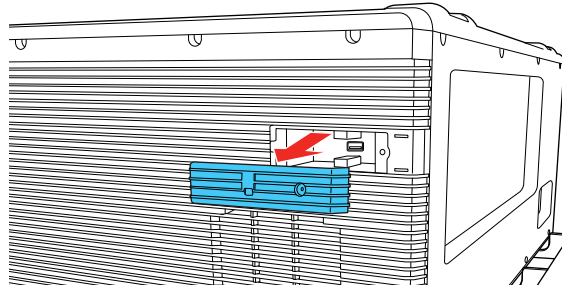

3. Insert the wireless LAN module into the port.

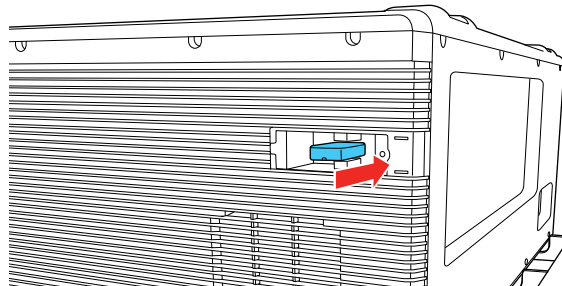

4. Replace the wireless LAN module port cover.

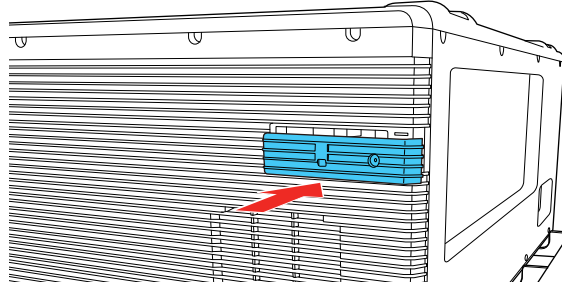

5. Secure the wireless LAN module port cover using the screw you removed.

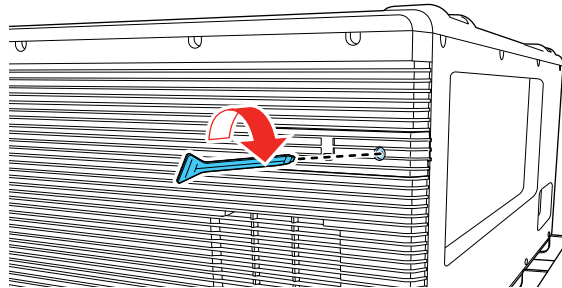

**Parent topic:** [Wireless Network Projection](#)

**Related references**

[Optional Equipment and Replacement Parts](#)

## Using a QR Code to Connect a Mobile Device

After you select the wireless network settings for your projector, you can display a QR code on the screen and use it to connect a mobile device using the Epson iProjection app.

**Note:** Make sure you have installed the latest version of Epson iProjection on your device. Visit [epson.com/iprojection](http://epson.com/iprojection) (U.S.) or [epson.ca/iprojection](http://epson.ca/iprojection) (Canada) for more information.

1. Press the **Menu** button.



2. Select the **Network** menu and press **Enter**.

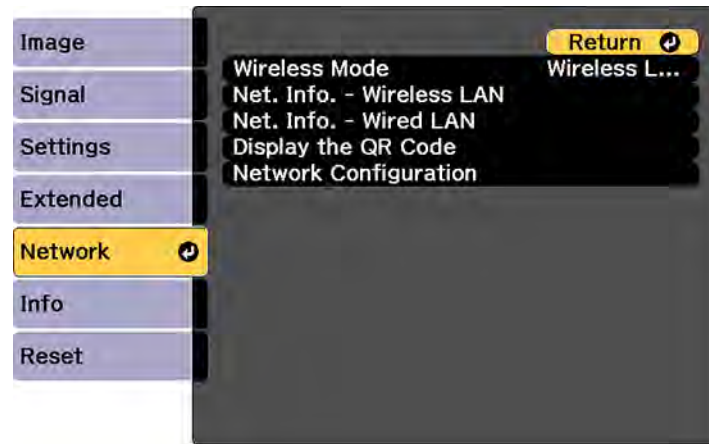

3. Select **Network Configuration** and press **Enter**.
4. Select the **Basic** menu and press **Enter**.

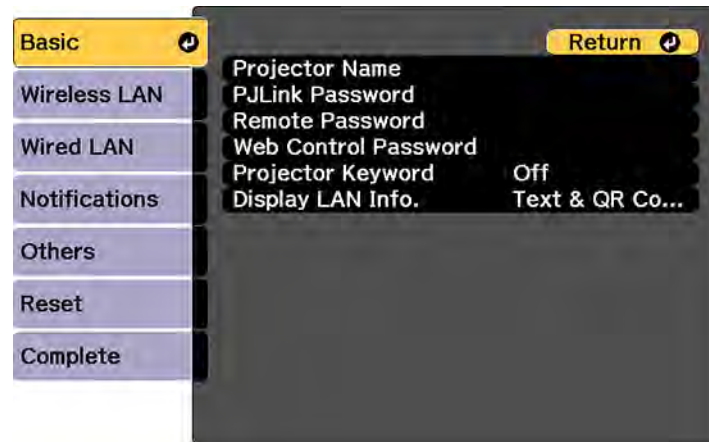

5. Set the **Display LAN Info** setting to **Text & QR Code**.
6. Select **Complete** and follow the on-screen instructions to save your settings and exit the menus.

7. Press the **LAN** button on the remote control or select **Display the QR Code** in the projector's Network menu.

Your projector displays the QR code on the projection surface.

**Note:** If you do not see the QR code after pressing the **LAN** button, press **Enter** to display it.

8. Start Epson iProjection on your mobile device.
9. Use the QR code reader feature to read the QR code and connect your device to the projector. Visit [epson.com/iprojection](http://epson.com/iprojection) (U.S.) or [epson.ca/iprojection](http://epson.ca/iprojection) (Canada) for instructions.

**Parent topic:** [Wireless Network Projection](#)

## Selecting Wireless Network Settings Manually

Before you can project from your wireless network, you must select the network settings for the projector using its menu system.

1. Turn on the projector.
2. Press the **Menu** button.
3. Select the **Network** menu and press **Enter**.

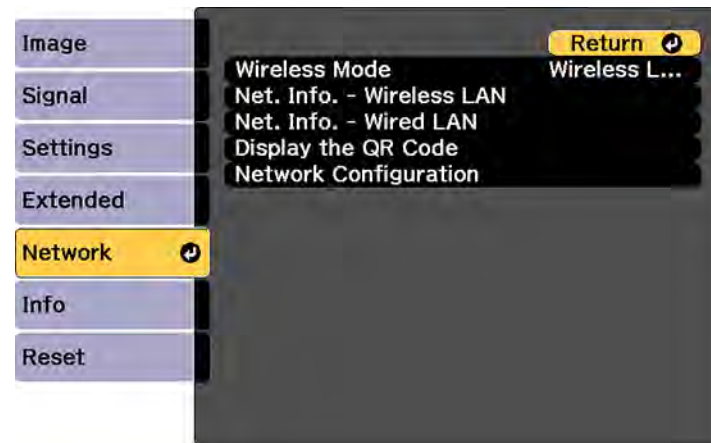

4. Make sure the **Wireless Mode** setting is set to **Wireless LAN On**.
5. Select **Network Configuration** and press **Enter**.

6. Select the **Basic** menu and press **Enter**.

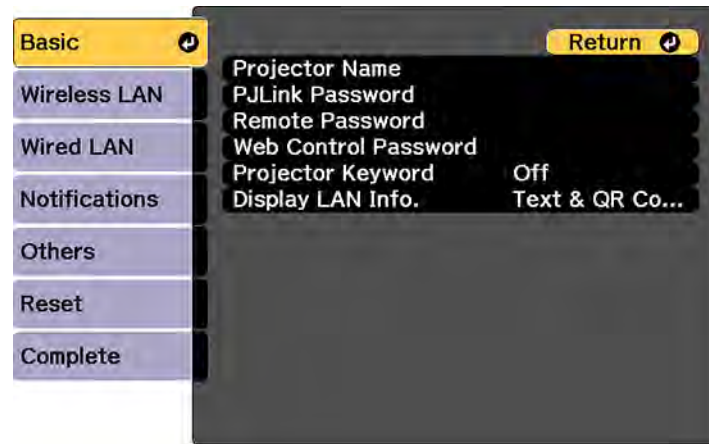

7. Select the following basic options as necessary:

- **Projector Name** lets you enter a name up to 16 alphanumeric characters long to identify the projector over the network.
- **PJLink Password** lets you enter a password up to 32 alphanumeric characters long for using the PJLink protocol for projector control.
- **Remote Password** lets you enter a password up to 8 alphanumeric characters long for accessing the Remote or Basic Control screen in the Epson Web Control. (Default user name is **EPSONREMOTE**; default password is **guest**.)
- **Web Control Password** lets you enter a password up to 8 alphanumeric characters long for accessing the projector over the web. (Default user name is **EPSONWEB**; default password is **admin**.)
- **Projector Keyword** lets you turn on a security password to prevent access to the projector by anyone not in the room with it. The projector displays a random keyword that you must enter from a computer using the EasyMP Network Projection software or an iOS or Android device using iProjection.

- **Display LAN Info** lets you select how the projector displays network information. You can select an option to display a QR code that lets you quickly connect your iOS or Android devices using the Epson iProjection app.

**Note:** Use the displayed keyboard to enter the name, passwords and keyword. Press the arrow buttons on the remote control to highlight characters and press **Enter** to select them.

8. Select the **Wireless LAN** menu and press **Enter**.

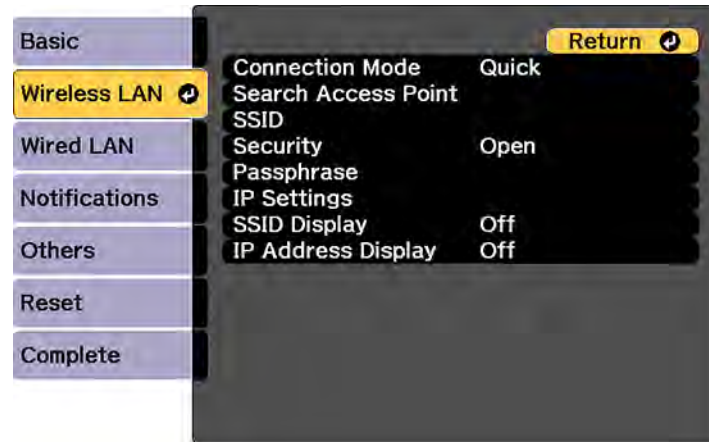

9. Select the settings on the **Wireless LAN** menu as necessary for your network.
10. When you finish selecting settings, select **Complete** and follow the on-screen instructions to save your settings and exit the menus.

After you complete the wireless settings for your projector, you need to select the wireless network on your computer, or iOS or Android device.

[Wireless LAN Menu Settings](#)

**Parent topic:** [Wireless Network Projection](#)

## Wireless LAN Menu Settings

Setting	Options	Description
<b>Connection Mode</b>	<b>Quick</b> <b>Advanced</b>	Selects the type of wireless connection: <b>Quick:</b> lets you quickly connect to one computer (ad hoc mode) <b>Advanced:</b> lets you connect to multiple computers via a wireless network access point (infrastructure mode)
<b>Search Access Point</b>	<b>To Search View</b>	Search for available wireless network access points in <b>Advanced</b> connection mode
<b>SSID</b>	Up 32 alphanumeric characters	Sets the SSID (network name) of the wireless LAN system the projector is connecting to
<b>Security</b>	<b>Open</b> <b>WPA2-PSK</b> <b>WPA/WPA2-PSK</b>	Selects the type of wireless security used in the wireless network
<b>Passphrase</b>	Between 8 to 63 alphanumeric characters	Enter a paraphrase for the wireless network
<b>Channel</b>	<b>1ch</b> <b>6ch</b> <b>11ch</b>	In <b>Quick</b> connection mode, selects the frequency band (channel) used by the wireless LAN
<b>IP Settings</b>	—	Turns on DHCP if your network assigns addresses automatically; set to <b>Off</b> to manually enter the network's <b>IP Address</b> , <b>Subnet Mask</b> , and <b>Gateway Address</b>
<b>SSID Display</b>	<b>On</b> <b>Off</b>	Selects whether to display the SSID on the network standby screen

Setting	Options	Description
IP Address Display	On Off	Selects whether to display the IP address on the network standby screen

Parent topic: [Selecting Wireless Network Settings Manually](#)

## Selecting Wireless Network Settings in Windows

Before connecting to the projector, select the correct wireless network on your computer.

1. To access your wireless utility software, access the Desktop and double-click the network icon on the Windows taskbar.
2. Do one of the following:
  - If your projector is set up on an existing network (Advanced mode), select the network name (SSID).
  - If your projector is configured for Quick mode, select the projector's SSID.
3. Click **Connect**.

Parent topic: [Wireless Network Projection](#)

## Selecting Wireless Network Settings on Mac

Before connecting to the projector, select the correct wireless network on your Mac.

1. Click the AirPort icon on the menu bar at the top of the screen.
2. Make sure AirPort is turned on, then do one of the following:
  - If your projector is set up on an existing network (Advanced mode), select the network name (SSID).
  - If your projector is configured for Quick mode, select the projector's SSID.

Parent topic: [Wireless Network Projection](#)

## Setting Up Projector Network E-Mail Alerts

You can set up the projector to send you an e-mail alert over the network if there is a problem with the projector.

1. Press the **Menu** button.
2. Select the **Network** menu and press **Enter**.

3. Select **Network Configuration** and press **Enter**.
4. Select the **Notifications** menu and press **Enter**.

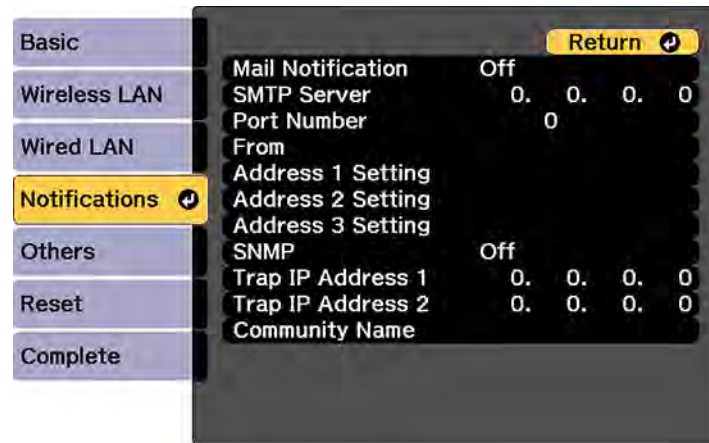

5. Turn on **Mail Notification**.
6. Enter the IP address for the **SMTP Server** setting.
 

**Note:** To enter the IP address using the numeric keys on the remote control, press and hold the **Num** button. Do not use these addresses: 127.x.x.x or 224.0.0.0 through 255.255.255.255 (where x is a number from 0 to 255).
7. Select a number for the SMTP server **Port Number** setting, from 1 to 65535 (default is 25).
8. Choose an **Address** field, enter the e-mail address, and select the alerts you want to receive there. Repeat for up to three addresses. Your e-mail address can be up to 32 alphanumeric characters long.
9. When you finish selecting settings, select **Complete** and follow the on-screen instructions to save your settings and exit the menus.

**Note:** If a critical problem causes a projector to shut down, you may not receive an e-mail alert.

[Network Projector E-mail Alert Messages](#)

**Parent topic:** [Using the Projector on a Network](#)

## Network Projector E-mail Alert Messages

When a problem occurs with a networked projector, and you selected to receive e-mail alerts, you receive an e-mail containing the following information:

- **Epson Projector** on the subject line
- The name of the projector experiencing a problem
- The IP address of the affected projector
- Detailed information about the problem

**Note:** If a critical problem causes a projector to shut down, you may not receive an e-mail alert.

**Parent topic:** [Setting Up Projector Network E-Mail Alerts](#)

## Selecting Other Network Settings

You can select optional network settings on the Others menu.

1. Press the **Menu** button.
2. Select the **Network** menu and press **Enter**.
3. Select **Network Configuration** and press **Enter**.
4. Select the **Others** menu and press **Enter**.

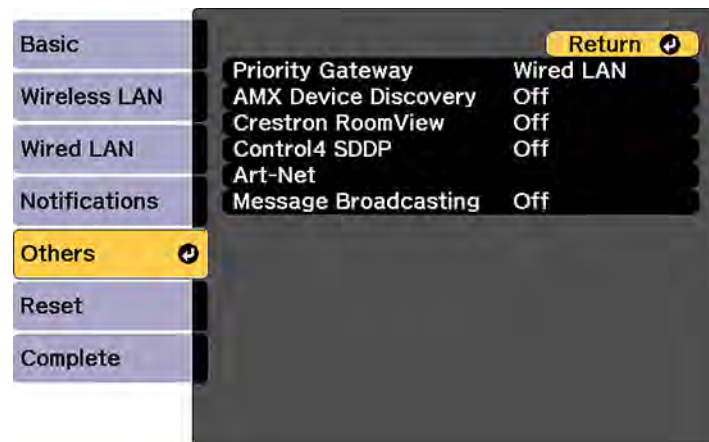



5. If available, select the **Priority Gateway** setting for your network.
6. If your network environment uses an AMX controller, turn on the **AMX Device Discovery** setting to allow the projector to be detected.
7. If your network environment uses a Crestron RoomView controller, turn on the **Crestron RoomView** setting to allow the projector to be detected.

**Note:** Enabling Crestron RoomView disables the Epson Message Broadcast feature in the EasyMP Monitor software.

8. If your network environment uses a Control4 or Control4 SDDP controller, turn on the **Control4 SDDP** setting to allow the projector to be detected.
9. If you want to control the projector using Art-Net (an Ethernet communication protocol based on TCP/IP), turn on the **Art-Net** setting.
10. If you want this projector to receive broadcasted messages over the network, turn on the **Message Broadcasting** setting. Administrators can broadcast messages over the network using the Message Broadcasting plug-in for EasyMP Monitor (Windows only).
11. When you finish selecting settings, select **Complete** and follow the on-screen instructions to save your settings and exit the menus.

**Parent topic:** [Using the Projector on a Network](#)

## Controlling a Networked Projector Using a Web Browser

Once you have connected your projector to your network, you can select projector settings and control projection using a compatible web browser. This lets you access the projector remotely.

**Note:** The web setup and control features support Microsoft Internet Explorer 9.0 or later, and Safari on networks that do not use a proxy server for connection. You cannot select all of the projector menu settings or control all projector functions using a web browser.

**Note:** If you set Standby Mode to **Communication On**, you can use a web browser to select settings and control projection even if the projector is in standby mode.

1. Make sure the projector is turned on.
2. Start your web browser on a computer or device connected to the network.

3. Type the projector's IP address into the browser's address box and press the computer's **Enter** key.

**Note:** You may need to log in before you see the Web Control screen. If you see a log in window, enter your user name and password. (The default user name is **EPSONWEB** and the default password is **admin**.)

You see the Web Control screen.

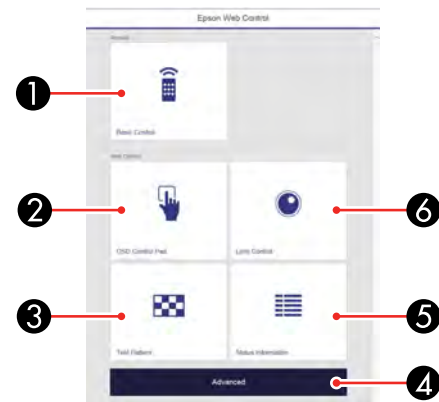

- 1 Select **Basic Control** to control the projector remotely.
- 2 Select **OSD Control Pad** to change the projector's menu settings.
- 3 Select **Test Pattern** to display a test pattern
- 4 Select **Advanced** to open the advanced menu screen.
- 5 Select **Status Information** to view the projector's status.
- 6 Select **Lens Control** to adjust the lens (focus, zoom, and lens shift).

4. Select the option corresponding to the projector function you want to control.

[Web Control Options](#)

**Parent topic:** [Using the Projector on a Network](#)

**Related references**

[Projector Setup Settings - Extended Menu](#)

## Web Control Options

### Basic Control

**Note:** If the Remote Password is set to **On**, you need to enter your user name and password. (The default username is **EPSONREMOTE** and the default password is **guest**).

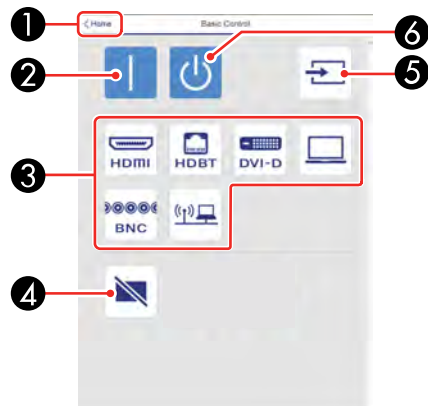

- 1 Returns to the Home screen
- 2 Turns on the projector
- 3 Input source selection controls
- 4 Turns off the image temporarily
- 5 Searches for sources
- 6 Turns off the projector

## OSD Control Pad

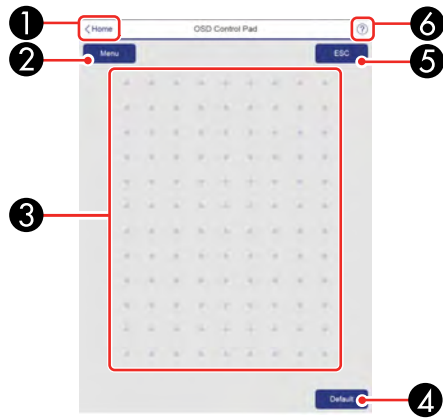

- 1 Returns to the Home screen
- 2 Displays the projector's setting menus
- 3 Use your finger or mouse to navigate the menus
- 4 Returns settings to their default values
- 5 Returns to the previous menu
- 6 Displays help topics

**Note:** You cannot change some settings using Epson Web Control.

## Lens Control

### Focus/Distortion screen

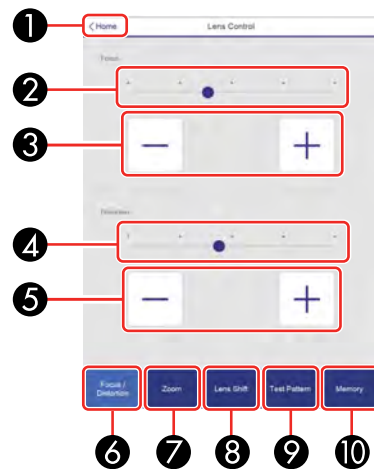

- 1 Returns to the Home screen
- 2 Focus adjustment slider
- 3 Focus adjustment buttons
- 4 Distortion adjustment slider (ELPLR05 and ELPLU05 only)
- 5 Distortion adjustment buttons (ELPLR05 and ELPLU05 only)
- 6 Displays the Focus/Distortion screen
- 7 Displays the Zoom screen
- 8 Displays the Lens Shift screen
- 9 Displays the Test Pattern screen
- 10 Displays the Memory screen

### Zoom screen

**Note:** Zoom is not available for the ELPLR05 lens.

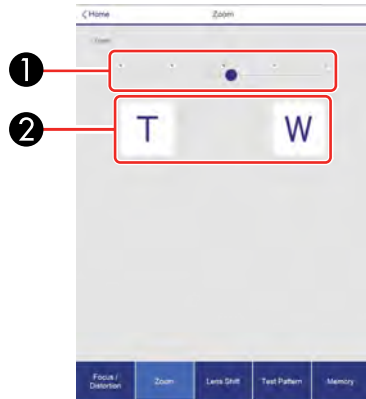

- 1 Zoom adjustment slider
- 2 Zoom adjustment buttons

### Lens Shift screen

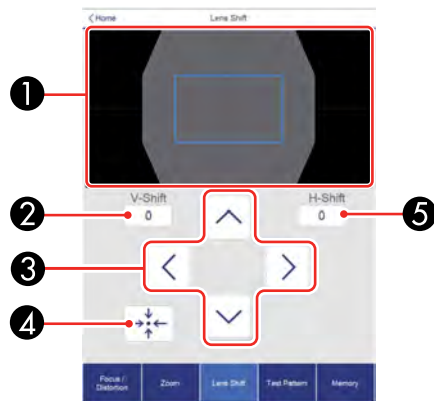

- 1 The blue square displays the current image position and the red square displays the new image position

- 2 Displays the vertical image position; select to change the value
- 3 Moves the image position up, down, left, or right
- 4 Moves the lens to the home position
- 5 Displays the horizontal image position; select to change the value

### Test Pattern screen

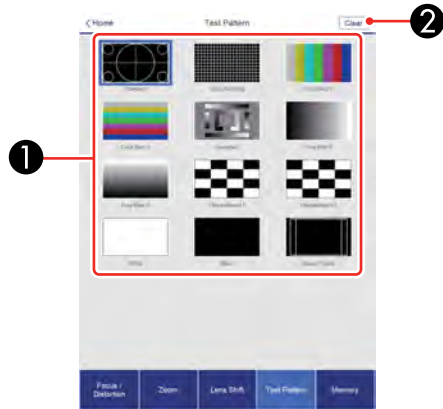

- 1 Displays available test patterns; select to project a test pattern
- 2 Turns off test pattern display

## Memory screen



- 1 Overwrites your current settings with saved settings
- 2 Saves your current settings to memory
- 3 Displays a list of saved memories
- 4 Erases a saved memory
- 5 Renames a saved memory

## Status Information

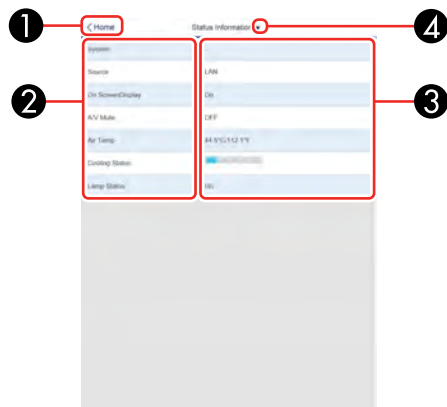



- 1 Returns to the Home screen
- 2 Displays a list of monitored settings
- 3 Displays the setting status
- 4 Select to view different status information

**Parent topic:** [Controlling a Networked Projector Using a Web Browser](#)

## Crestron RoomView Support

If you are using the Crestron RoomView network monitoring and control system, you can set up your projector for use on the system. Crestron RoomView lets you control and monitor your projector using a web browser.

**Note:** You cannot use the Epson Web Control feature or the Message Broadcasting plug-in for EasyMP Monitor when you use Crestron RoomView.

For additional information on Crestron RoomView, contact Crestron.

[Setting Up Crestron RoomView Support](#)

[Controlling a Networked Projector Using Crestron RoomView](#)

**Parent topic:** [Using the Projector on a Network](#)

## Setting Up Crestron RoomView Support

To set up your projector for monitoring and control using a Crestron RoomView system, make sure your computer and projector are connected to the network.

**Note:** If you want to use the Crestron RoomView system when the projector is turned off, you need to adjust the **Standby Mode** settings in the Extended menu.

1. Press the **Menu** button.
2. Select the **Network** menu and press **Enter**.
3. Select **Network Configuration** and press **Enter**.

4. Select the **Others** menu and press **Enter**.

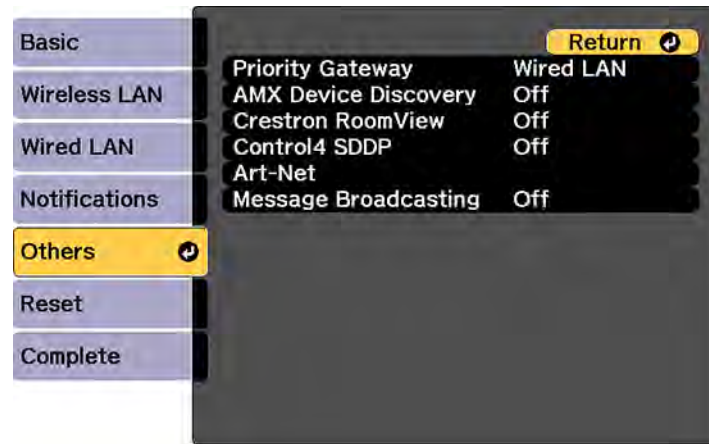

5. Set the **Crestron RoomView** setting to **On** to allow the projector to be detected.

**Note:** Enabling Crestron RoomView disables the Epson Message Broadcasting feature in the EasyMP Monitor software.

6. When you finish selecting settings, select **Complete** and follow the on-screen instructions to save your settings and exit the menus.
7. Turn off the projector, then turn it on again to enable the setting.

**Parent topic:** [Crestron RoomView Support](#)

#### **Related references**

[Projector Setup Settings - Extended Menu](#)

## **Controlling a Networked Projector Using Crestron RoomView**

Once you have set up your projector to use Crestron RoomView, you can control and monitor projection using a compatible web browser.

1. Start your web browser on a computer connected to the network.
2. Type the projector's IP address into the browser's address box and press the computer's **Enter** key.

You see this screen:



3. Select the input source that you want to control in the Sources List box. You can scroll through available sources using the up and down arrows in the box.
4. To control projection remotely, click the on-screen buttons that correspond to the projector's remote control buttons. You can scroll through button options at the bottom of the screen.

**Note:** These on-screen buttons do not directly correspond to the projector's remote control buttons:

- **OK** acts as the **Enter** button
- **Menu** displays the projector's menu

5. To view information about the projector, click the **Info** tab.
6. To change projector, Crestron, and password settings, click the **Tools** tab, select settings on the displayed screen, and click **Send**.
7. When you finish selecting settings, click **Exit** to exit the program.

**Parent topic:** [Crestron RoomView Support](#)

---

# Using Basic Projector Features

Follow the instructions in these sections to use your projector's basic features.

[Turning On the Projector](#)

[Turning Off the Projector](#)

[Selecting the Language for the Projector Menus](#)

[Resizing the Image with the Zoom Button](#)

[Focusing the Image Using the Focus Button](#)

[Setting the Screen Type](#)

[Adjusting the Image Position Using Lens Shift](#)

[Adjusting the Image Position Using Screen Position](#)

[Displaying a Test Pattern](#)

[Image Shape](#)

[Selecting an Image Source](#)

[Remote Control Operation](#)

[Projection Modes](#)

[Image Aspect Ratio](#)

[Color Mode](#)

[Adjusting the Brightness](#)

[Turning On Automatic Luminance Adjustment](#)

[Setting the Date and Time](#)

## Turning On the Projector

Turn on the computer or video equipment you want to use before you turn on the projector so it can display the image source.

**Caution:** Install the current breaker for 13 A to 20 A to the wiring in the building that supplies electricity to the projector.

1. Connect the power cord to the projector's power inlet.

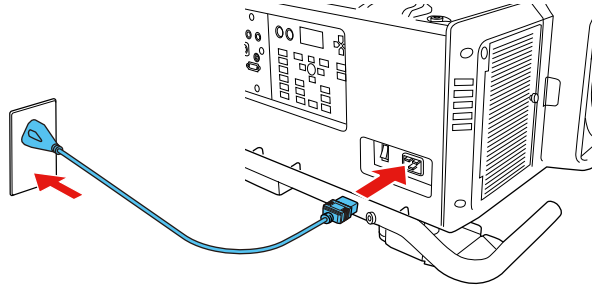

2. Plug the power cord into an electrical outlet.
3. Turn on the power switch on the back of the projector.

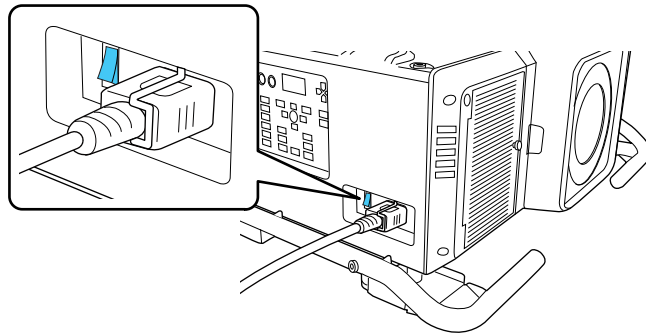

The projector's On/Standby light turns blue. This indicates that the projector is receiving power.

**Note:** With **Direct Power On** turned on, the projector turns on as soon as you plug it in. If you selected **Computer** or **BNC** for the **Auto Power On** setting in the Extended menu, the projector turns on when it detects an input signal from those ports.

4. Press the **On** button on the projector or remote control to turn on the projector.

The projector beeps and the Status light flashes blue as the projector warms up. After about 30 seconds, the Status light stops flashing and turns blue.

**Warning:** Never look into the projector lens when the laser is on. This can damage your eyes and is especially dangerous for children and pets.

**Caution:** Make sure no objects are blocking the light from the projector lens. Objects blocking the lens for an extended time can melt and light that is reflected back into the lens can cause the projector to malfunction.

If you do not see a projected image right away, try the following:

- Make sure the lens cap is off.
- Turn on the connected computer or video device.
- Insert a DVD or other video media and press the play button, if necessary.
- Press the **Search** button on the remote control to detect the video source, or press one of the source buttons on the remote control or projector.

**Parent topic:** [Using Basic Projector Features](#)

**Related references**

[Projector Setup Settings - Extended Menu](#)

**Related tasks**

[Turning Off the Projector](#)

## Turning Off the Projector

Before turning off the projector, shut down any computer connected to it so you can see the computer display during shutdown.

**Note:** Turn off this product when not in use to prolong the life of the projector. Laser life will vary depending upon mode selected, environmental conditions, and usage. Brightness decreases over time.

1. Press the **Standby** button on the projector or remote control.

The projector displays a shutdown confirmation screen.



2. Press the **Standby** button on the projector or remote control again. (To leave it on, press any other button.)

The projector beeps twice, the laser turns off, and the Status light turns off.

**Note:** With Epson's Instant Off technology, there is no cool-down period so you can pack up the projector for transport right away (if necessary).

3. To transport or store the projector, make sure the Status light is off, then unplug the power cord.

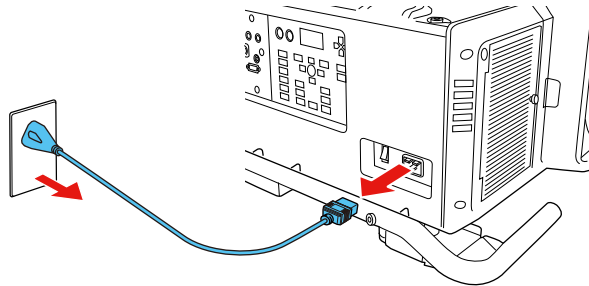

**Note:** If you use the projector continuously for more than 24 hours, or regularly turn it off by shutting off the power outlet, schedule periodic **Light Source Calibration** events in the Extended menu.

**Parent topic:** [Using Basic Projector Features](#)

**Related references**

[Projector Setup Settings - Extended Menu](#)

## Related tasks

[Turning On the Projector](#)

[Saving a Scheduled Event](#)

## Selecting the Language for the Projector Menus

If you want to view the projector's menus and messages in another language, you can change the Language setting.

1. Turn on the projector.
2. Press the **Menu** button.
3. Select the **Extended** menu and press **Enter**.

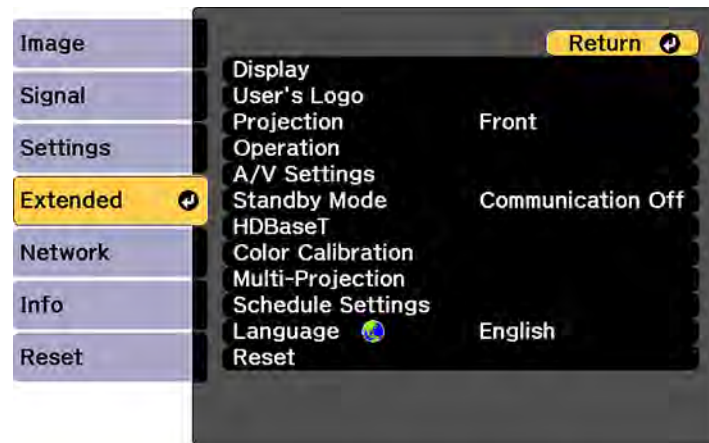

4. Select the **Language** setting and press **Enter**.
5. Select the language you want to use and press **Enter**.
6. Press **Menu** or **Esc** to exit the menus.

**Parent topic:** [Using Basic Projector Features](#)

## Resizing the Image with the Zoom Button

You can adjust the size of the image using the zoom buttons. Zoom is not available for the ELPLR05 lens.



**Note:** Wait 20 minutes after turning on the projector before setting the focus, zoom, and lens shift for maximum accuracy.

1. Turn on the projector and display an image.
2. Press the **Zoom** button on the control panel.

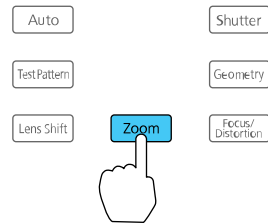

3. Press the left and right arrow buttons to resize the image.
4. Press the **Esc** button when finished.

**Note:** You can also press the **Zoom +** or **-** buttons on the remote control to adjust the size of the image.

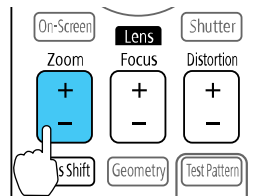

Parent topic: [Using Basic Projector Features](#)

## Focusing the Image Using the Focus Button

You can adjust the sharpness of the projected image using the focus buttons

**Note:** Wait 20 minutes after turning on the projector before setting the focus, zoom, and lens shift for maximum accuracy. If you installed any of the following lenses, see the section on focusing with a short throw lens instead: ELPLR05 or ELPLU05.

1. Turn on the projector and display an image.

**Note:** If you are projecting from multiple projectors that differ in brightness, display a grayscale test pattern to adjust the focus for best results.

2. Press the **Focus/Distortion** button on the control panel.

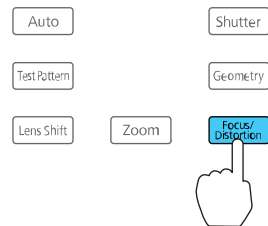

3. Press the left and right arrow buttons to adjust the focus.
4. Press the **Esc** button when finished.

**Note:** You can also press the **Focus +** or **-** buttons on the remote control to adjust the focus.

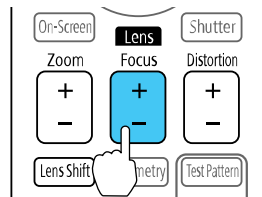

### [Focusing the Image When Using an Optional Short Throw Lens](#)

**Parent topic:** [Using Basic Projector Features](#)

#### **Related tasks**

[Focusing the Image When Using an Optional Short Throw Lens](#)

## **Focusing the Image When Using an Optional Short Throw Lens**

If you installed an optional short throw lens (ELPLR05 or ELPLU05), you may need to first focus on the center of your screen and then correct any distortion in the surrounding area.

1. Turn on the projector and display an image.
2. Press the **Focus/Distortion** button on the control panel.
3. Press the left or right arrow buttons until the center of the image is focused.

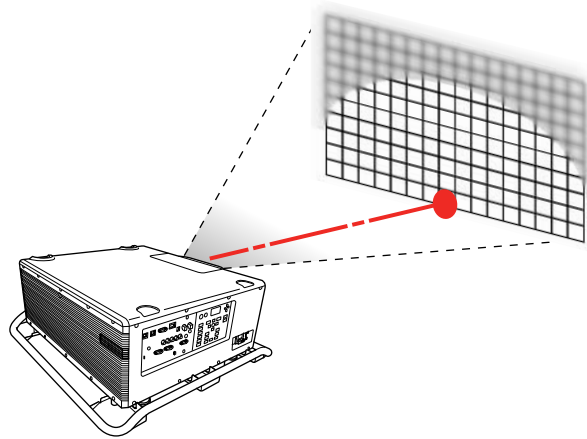

4. Press the **Focus/Distortion** button again.
5. Press the left or right arrow buttons until the edges of the image are also focused.

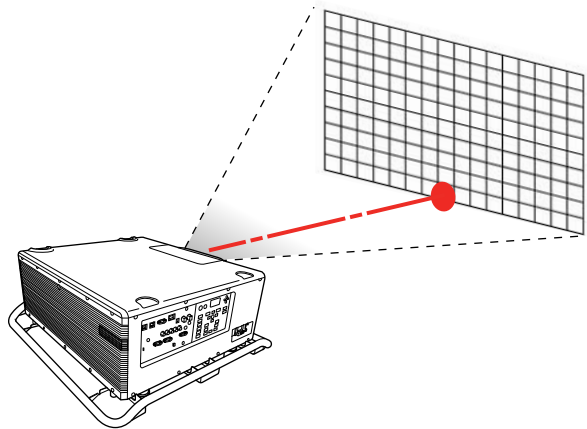

**Note:** You can also press the **Focus +** or **-** button on the remote control to focus the center of your image. Then use the **Distortion +** or **-** button to adjust the edges of the image.

**Parent topic:** [Focusing the Image Using the Focus Button](#)

## Setting the Screen Type

You can use the Screen Type setting to match the aspect ratio of the displayed image to the screen you are using.

1. Turn on the projector and display an image.
2. Press the **Menu** button.
3. Select the **Extended** menu and press **Enter**.
4. Select **Display > Screen > Screen Type**.

You see this screen:

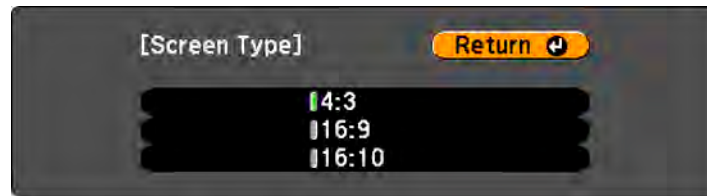

5. Select your screen's aspect ratio and press **Enter**.
6. Press the **Menu** button to exit.
7. Adjust the aspect ratio for the projected image, if necessary.

**Parent topic:** [Using Basic Projector Features](#)

**Related concepts**

[Image Aspect Ratio](#)

## Adjusting the Image Position Using Lens Shift

If you cannot install the projector directly in front of the screen, you can adjust the position of the projected image using the lens shift feature.

**Note:** Wait 20 minutes after turning on the projector before setting the focus, zoom, and lens shift for maximum accuracy.

1. Turn on the projector and display an image.
2. Press the **Lens Shift** button on the control panel or remote control.

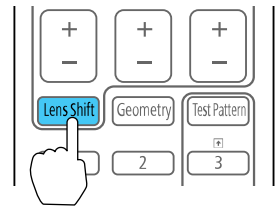
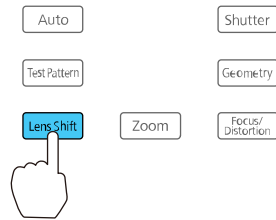

3. Press the arrow buttons on the remote control or the control panel to adjust the position of the projected image as necessary.

### ELPLR05

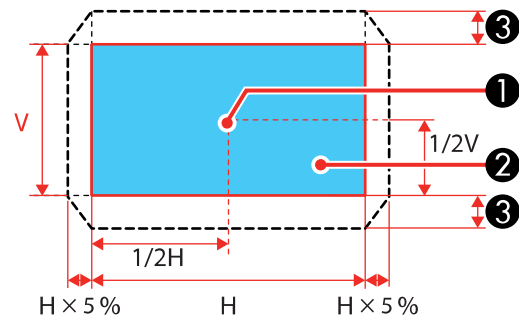

- 1 Center of lens
- 2 Projected image when lens shift is set to the home position
- 3 Maximum range:  $V \times 15\%$

**ELPLU05/ELPLL09/ELPLL10**

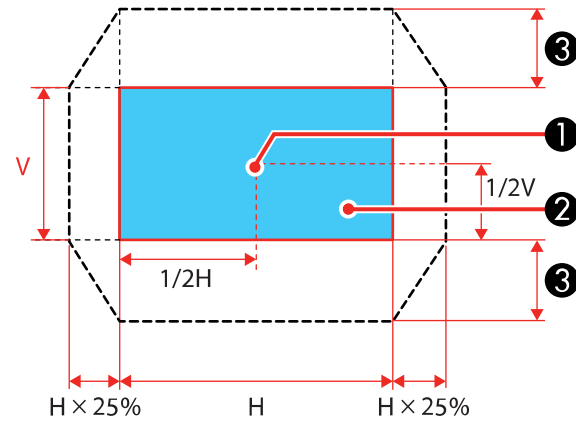

- 1 Center of lens
- 2 Projected image when lens shift is set to the home position
- 3 Maximum range:  $V \times 55\%$

## ELPLW07/ELPLM12/ELPLM13/ELPLM14

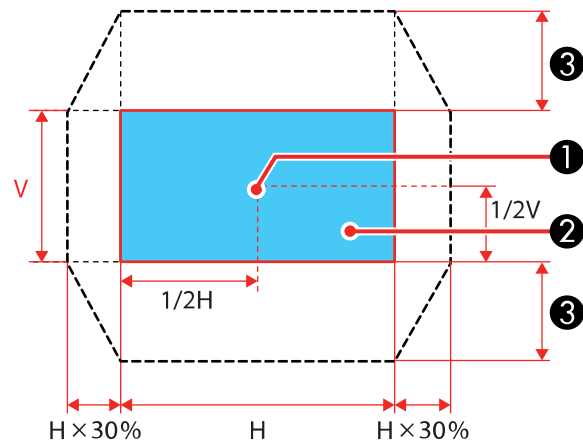

- 1 Center of lens
- 2 Projected image when lens shift is set to the home position
- 3 Maximum range:  $V \times 65\%$ ; maximum range when performing screen matching:  $V \times 60\%$  (ELPLM13)

**Note:** You cannot move the image vertically when the lens is shifted horizontally all the way.

4. When you are finished, press the **Esc** button on the control panel or remote control.

**Note:** When adjusting the image height, position the image lower than where you want it to be and then move it up. This will help prevent the image from moving down after adjustment. The image is clearest when the lens is at the home position. To move the lens to the home position, press and hold the **Lens Shift** button on the remote control or control panel for at least three seconds.

Parent topic: [Using Basic Projector Features](#)

## Adjusting the Image Position Using Screen Position

You can adjust the image position if there are margins between the edge of the image and the projected screen frame.

1. Turn on the projector and display an image.

2. Press the **Menu** button.
3. Select the **Extended** menu and press **Enter**.
4. Select **Display > Screen > Screen Position**.
5. Use the arrow buttons on the remote control or projector to adjust the position of the image.

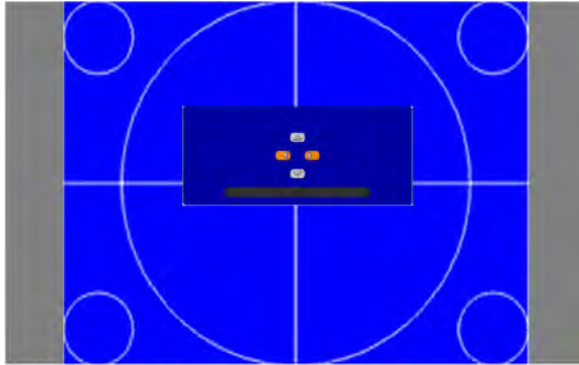

6. When you are finished, press the **Menu** button.

**Parent topic:** [Using Basic Projector Features](#)

**Related tasks**

[Setting the Screen Type](#)

## Displaying a Test Pattern

You can display a test pattern to adjust the projected image without connecting a computer or video device.

**Note:** The test pattern's shape is determined by the Screen Type setting. Be sure to set the correct screen type before adjusting with the test pattern.

1. Turn on the projector.
2. Press the **Test Pattern** button on the remote control or control panel.
3. Press the left or right arrow buttons on the remote control or press **Enter** on the control panel to cycle through the available test patterns.
4. Adjust the image as necessary.



5. Press the **Esc** to clear the test pattern.

[Available Test Pattern Image Adjustments](#)

**Parent topic:** [Using Basic Projector Features](#)

**Related tasks**

[Setting the Screen Type](#)

## Available Test Pattern Image Adjustments

You can adjust the following settings while the test pattern is displayed.

Menu	Settings
Image	Color Mode
	White Balance
	Advanced <ul style="list-style-type: none"><li>• Gamma<sup>1</sup></li><li>• RGBCMY</li></ul>
Settings	Geometry Correction
	Brightness Settings
Extended	Display <sup>2</sup>
	Color Calibration
	Multi-Projection <sup>3</sup>

<sup>1</sup> Except for custom **Gamma** settings

<sup>2</sup> Except for the **Screen**, **Panel Alignment**, and **Color Uniformity** settings

<sup>3</sup> Except for the **Black Level**, **Scale**, **Color Uniformity**, and **Color Adjustment** settings

**Parent topic:** [Displaying a Test Pattern](#)

## Image Shape

You can project an evenly rectangular image by placing the projector directly in front of the center of the screen and keeping it level. If you place the projector at an angle to the screen, or tilted up or down, or off to the side, you may need to correct the image shape for the best display quality.

[Correcting Image Shape with H/V Keystone](#)

[Correcting Image Shape with Quick Corner](#)  
[Correcting Image Shape with Curved Surface](#)  
[Correcting Image Shape with Corner Wall](#)  
[Correcting Image Shape with Point Correction](#)

**Parent topic:** [Using Basic Projector Features](#)

## Correcting Image Shape with H/V Keystone

You can use the projector's H/V Keystone setting to correct the shape of an image that is unevenly rectangular on the sides.

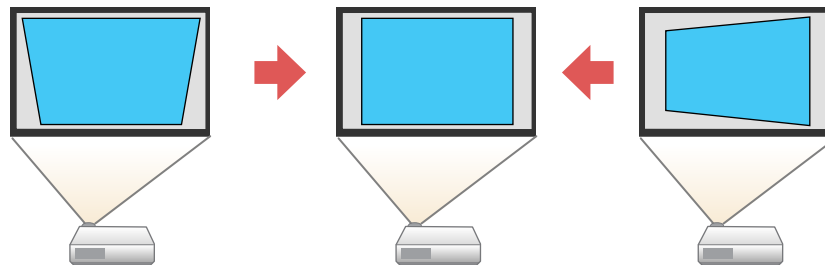

**Note:** You cannot combine H/V Keystone correction with other image adjustment methods.

1. Turn on the projector and display an image.

**Note:** You can display a pattern to aid in adjusting the projected image using the Settings menu.

**Note:** You can also display a pattern to aid in adjusting the projected image using the **Test Pattern** button on the remote control.

2. Press the **Menu** button.

3. Select the **Settings** menu and press **Enter**.

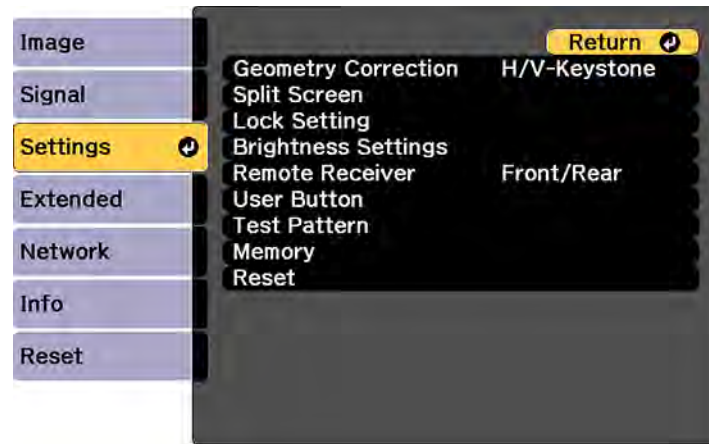

4. Select the **Geometry Correction** setting and press **Enter**.

**Note:** You can also access the geometric adjustment screen by pressing the **Geometry** button on the remote control or the up arrow button on the control panel.

5. Select the **H/V-Keystone** setting and press **Enter**. Then press **Enter** again.

You see the H/V-Keystone adjustment screen:



6. Use the arrow buttons on the projector or the remote control to select between vertical and horizontal keystone correction and to adjust the image shape as necessary.

**V-Keystone**

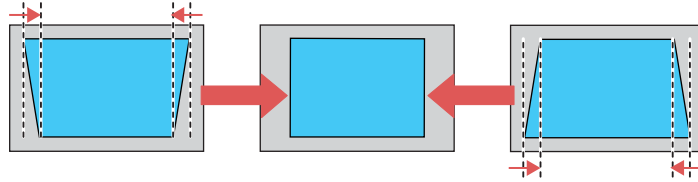

**V-Balance**

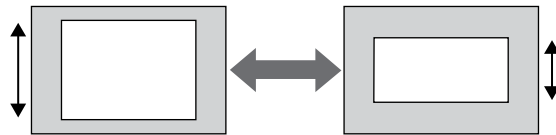

**H-Keystone**

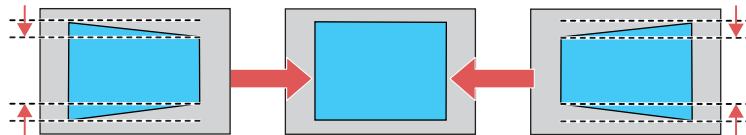

**H-Balance**

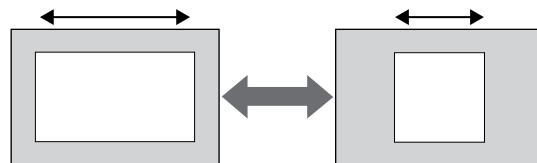

7. When you are finished, press **Esc**.  
After correction, your image is slightly smaller.

**Parent topic:** [Image Shape](#)

**Related references**

[Projector Feature Settings - Settings Menu](#)

**Related tasks**

[Displaying a Test Pattern](#)

## Correcting Image Shape with Quick Corner

You can use the projector's Quick Corner setting to correct the shape and size of an image that is unevenly rectangular on all sides.

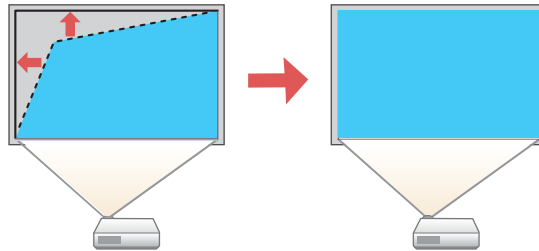

1. Turn on the projector and display an image.

**Note:** You can display a pattern to aid in adjusting the projected image using the Settings menu.

**Note:** You can also display a pattern to aid in adjusting the projected image using the **Test Pattern** button on the remote control.

2. Press the **Menu** button.

3. Select the **Settings** menu and press **Enter**.

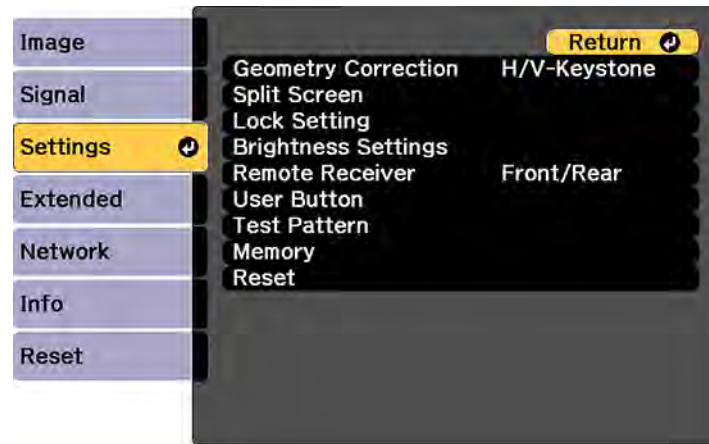

4. Select the **Geometry Correction** setting and press **Enter**.
5. Select the **Quick Corner** setting and press **Enter**. Then press **Enter** again.  
You see the Quick Corner adjustment screen:

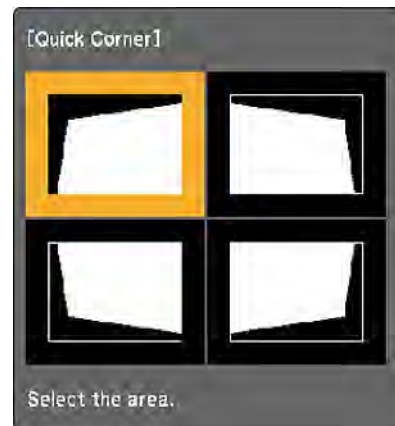

**Note:** To reset your adjustments, press and hold the **Esc** button for at least 2 seconds to display a reset screen. Then select **Yes**.

6. Use the arrow buttons on the projector or the remote control to select the corner of the image you want to adjust. Then press **Enter**.
7. Press the arrow buttons to adjust the image shape as necessary.
8. When you are finished, press **Esc**.

**Parent topic:** [Image Shape](#)

**Related references**

[Projector Feature Settings - Settings Menu](#)

**Related tasks**

[Displaying a Test Pattern](#)

## Correcting Image Shape with Curved Surface

You can use the projector's Curved Surface setting to adjust the shape of an image projected on a curved surface.

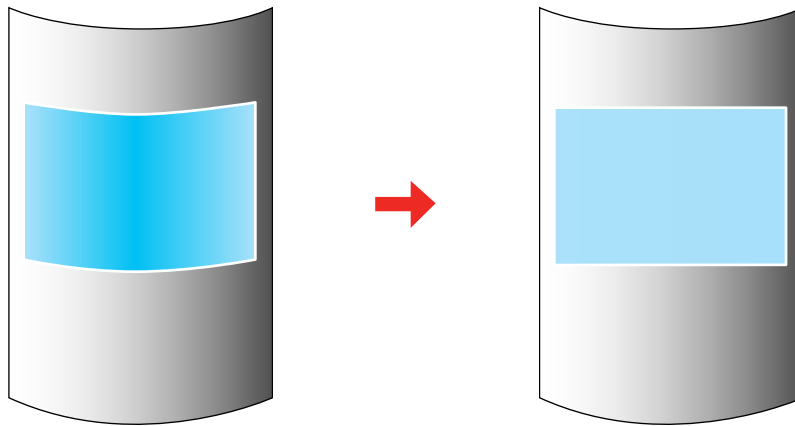

**Note:** For the best results, project from the front of the screen onto a surface with a uniform arc radius. The image may not be evenly focused throughout even after performing the steps here. If you see a 4K Enhancement message, select **Yes** to disable the 4K Enhancement feature.

1. Turn on the projector and display an image.

**Note:** You can display a pattern to aid in adjusting the projected image using the Settings menu.

**Note:** You can also display a pattern to aid in adjusting the projected image using the **Test Pattern** button on the remote control.

2. Press the **Menu** button.
3. Select the **Settings** menu and press **Enter**.

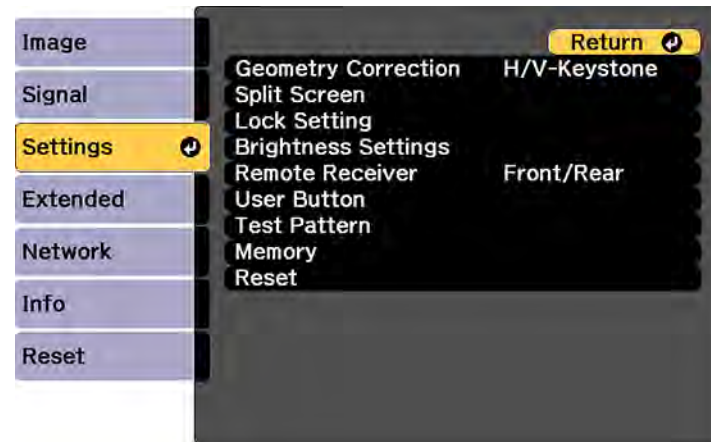

4. Select the **Geometry Correction** setting and press **Enter**.
5. Select the **Curved Surface** setting and press **Enter**.

**Note:** If you see a confirmation message, press **Enter**.

You see this screen:

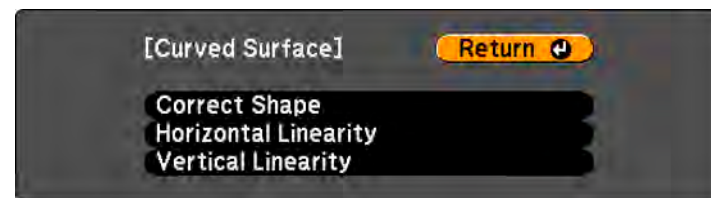

6. Select the **Correct Shape** setting and press **Enter**.



7. Use the arrow buttons on the projector or the remote control to select the area you want to adjust. Then press **Enter**.

**Note:** To reset your adjustments, press and hold the **Esc** button for at least 2 seconds to display a reset screen. Then select **Yes**.

8. Use the arrow buttons on the projector to adjust the image shape.

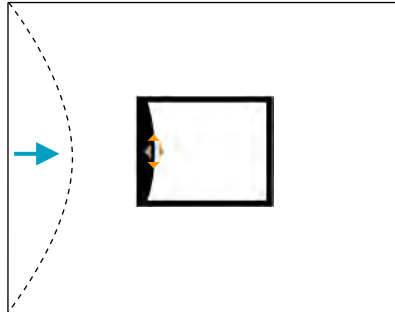

**Note:** If the adjustment triangle turns gray, you cannot adjust the shape any further in that direction.

9. Press the **Esc** button to return to the Curved Surface menu screen.
10. Repeat the previous three steps as necessary to adjust other image areas.  
If the image expands or contracts, continue with the next step to adjust the linearity.
11. Select one of the following from the Curved Surface menu screen:
  - **Horizontal Linearity:** Adjusts horizontal expansion or contraction.
  - **Vertical Linearity:** Adjusts vertical expansion or contraction.
12. Select a displayed line to use as a baseline and press **Enter**.  
The selected baseline flashes red and white.

13. Adjust the linearity by doing one of the following:

- Press the left arrow button to contract the distance between the lines closest to the baseline.

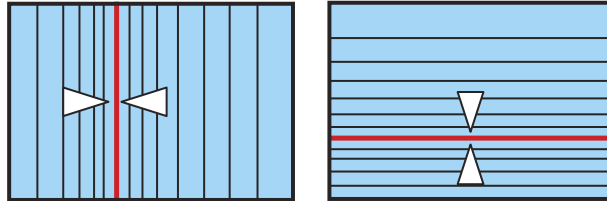

- Press the right arrow button to expand the distance between the lines closest to the baseline.

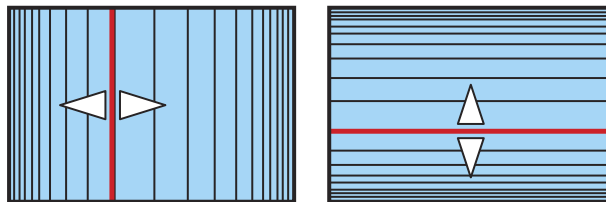

14. When you are finished, press the **Menu** button.

**Parent topic:** [Image Shape](#)

**Related references**

[Projector Feature Settings - Settings Menu](#)

**Related tasks**

[Displaying a Test Pattern](#)

## Correcting Image Shape with Corner Wall

You can use the projector's Corner Wall setting to adjust the shape of an image projected on a surface with right angles, such as a rectangular pillar or the corner of a room.

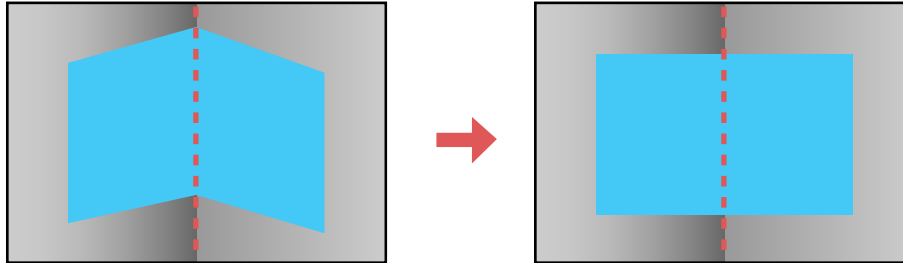

**Note:** For the best results, project from the front of the screen onto a right-angled surface. The image may not be evenly focused throughout even after performing the steps here. If you see a 4K Enhancement message, select **Yes** to disable the 4K Enhancement feature.

1. Turn on the projector and display an image.

**Note:** You can display a pattern to aid in adjusting the projected image using the Settings menu.

**Note:** You can also display a pattern to aid in adjusting the projected image using the **Test Pattern** button on the remote control.

2. Press the **Menu** button.

3. Select the **Settings** menu and press **Enter**.

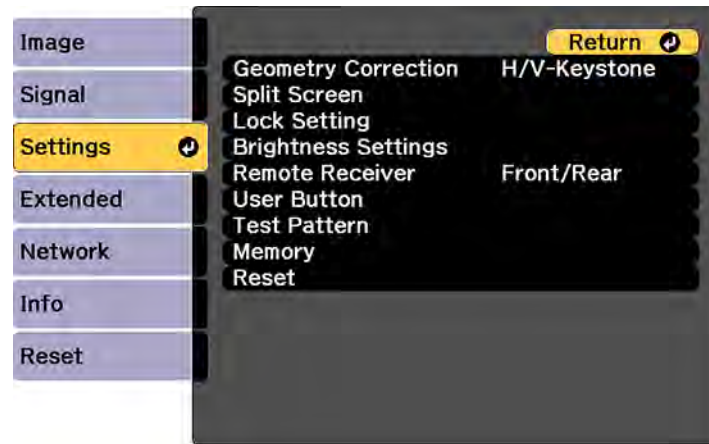

4. Select the **Geometry Correction** setting and press **Enter**.
5. Select the **Corner Wall** setting and press **Enter**.

**Note:** If you see a confirmation message, press **Enter**.

You see this screen:

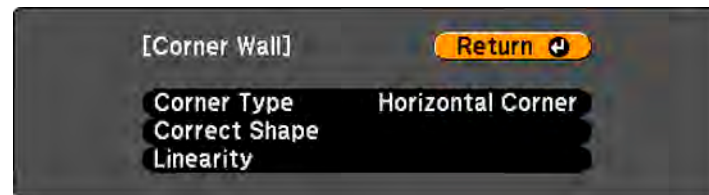

6. Select the **Corner Type** setting and press **Enter**.

7. Select one of the following:

- **Horizontal Corner** when the surfaces line up horizontally

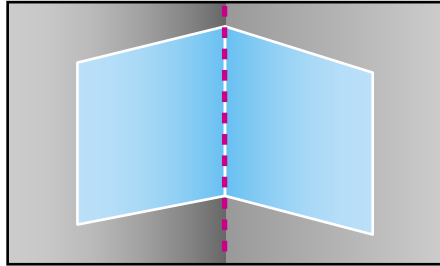

- **Vertical Corner** when the surfaces line up vertically

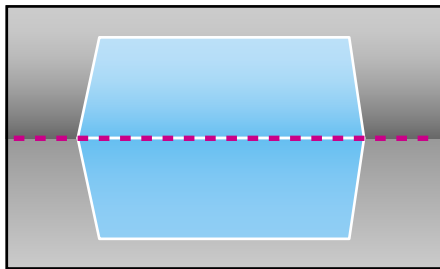

8. Press the **Esc** button to return to the Corner Wall menu screen.

9. Select the **Correct Shape** setting and press **Enter**.

10. Adjust the projector's position and use lens shift to center the image over the point where the two surfaces meet. (The rest of these steps show Horizontal Corner as the selected Corner Type but the steps are the same for Vertical Corner.)

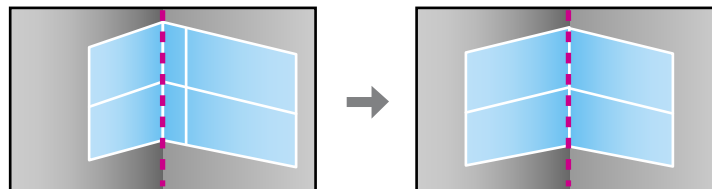

**Note:** You can press **Enter** to show or hide the image and grid to check the results.

11. Press the arrow buttons on the projector or the remote control to select the area you want to adjust. Then press **Enter**.

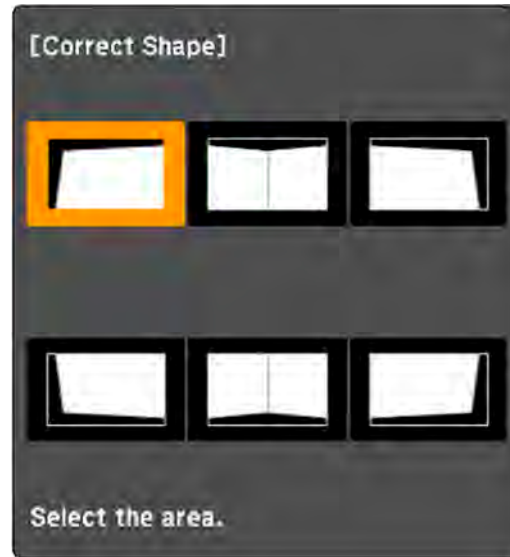

- For horizontal corners, adjust the top area using the lowest point (indicated by the blue arrow) as your reference. Adjust the lower area using the highest point (indicated by the pink arrow) as your reference.

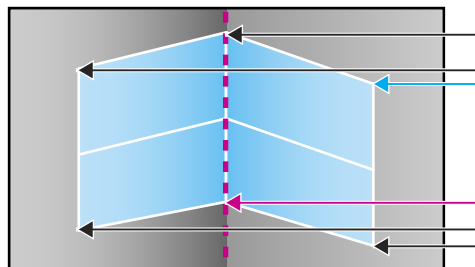

- For vertical corners, adjust the left and right areas using the points nearest the center of the image as your reference points.

**Note:** To reset your adjustments, press and hold the **Esc** button for at least 2 seconds to display a reset screen. Then select **Yes**.

12. Press and hold the arrow buttons on the projector or remote control to adjust the image shape.

13. Repeat the previous two steps as necessary to adjust other image areas.

If the image expands or contracts, continue with the next step to adjust the linearity.

14. Press the **Esc** button to return to the Corner Wall screen.

15. Select the **Linearity** setting and press **Enter**.

16. Adjust the linearity by doing the following as necessary:

- Press and hold the left arrow button to contract the distance between the lines closest to the left or top of the image.

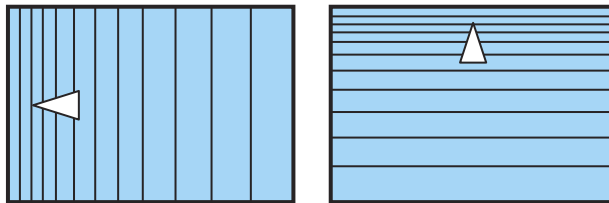

- Press and hold the right arrow button to contract the distance between the lines closest to the right or bottom of the image.

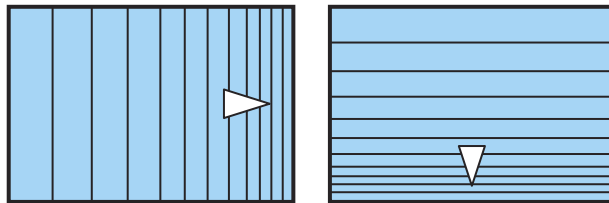

17. When you are finished, press the **Menu** button.

**Note:** If necessary, you can adjust the image tilt using the **Quick Corner** setting, then fine-tune your adjustments using the **Point Correction** setting.

**Parent topic:** [Image Shape](#)

**Related references**

[Projector Feature Settings - Settings Menu](#)

**Related tasks**

[Displaying a Test Pattern](#)

[Correcting Image Shape with Point Correction](#)

## Correcting Image Shape with Point Correction

You can use the projector's Point Correction feature to fine-tune the image shape using points on a grid. This is useful for adjusting overlapping areas in multiple projected images that do not line up correctly.

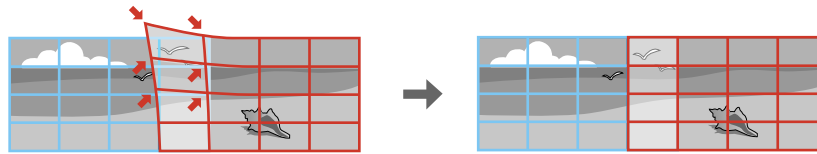

**Note:** You can move the points on the grid between 0.5 to 32 pixels in any direction. If you see a 4K Enhancement message, select **Yes** to disable the 4K Enhancement feature.

1. Turn on the projector and display an image.

**Note:** You can display a pattern to aid in adjusting the projected image using the Settings menu.

**Note:** You can also display a pattern to aid in adjusting the projected image using the **Test Pattern** button on the remote control.

2. Press the **Menu** button.



3. Select the **Settings** menu and press **Enter**.

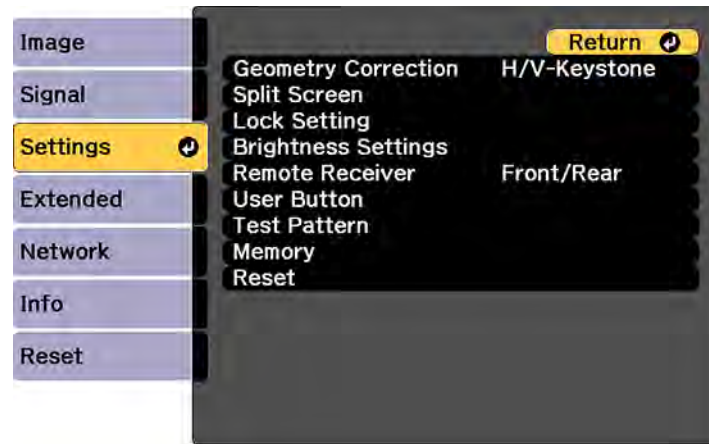

4. Select the **Geometry Correction** setting and press **Enter**.
5. Select the **Point Correction** setting and press **Enter**.

**Note:** If you see a confirmation message, press **Enter**.

You see this screen:

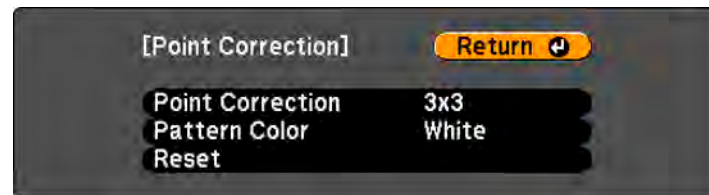

6. Select the **Point Correction** setting and press **Enter**.
7. Select the number of grid lines to display and press **Enter**.

**Note:** If you need to change the color of the grid lines, select the **Pattern Color** setting and select a suitable color.

8. Press the arrow buttons on the projector or remote control to move to the point on the grid that you want to adjust. Then press **Enter**.

The box changes from a single line to a double-lined square.

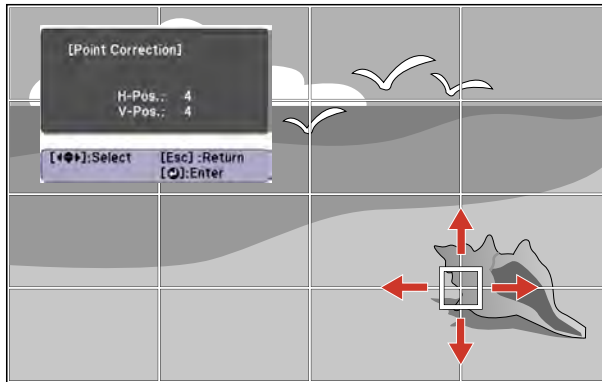

9. Press the arrow buttons to correct the image shape in all necessary directions.

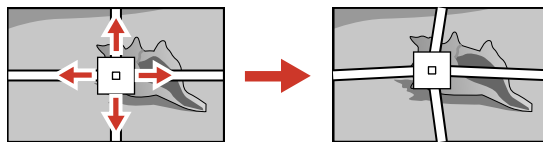

**Note:** You can press **Enter** to show or hide the image and grid to check the results.

10. Press **Esc** to return to the previous screen and select another point to correct, if necessary.
11. When you are finished, press the **Menu** button.

**Note:** If necessary, you can fine-tune your image adjustments using the **Quick Corner** setting.

**Parent topic:** [Image Shape](#)

**Related references**

[Projector Feature Settings - Settings Menu](#)

## Related tasks

[Displaying a Test Pattern](#)

[Correcting Image Shape with Corner Wall](#)

## Selecting an Image Source

If you connected multiple image sources to the projector, such as a computer and DVD player, you may want to switch from one image source to the other.

1. Make sure the connected image source you want to use is turned on.
2. For video image sources, insert a DVD or other video media and press its play button, if necessary.
3. Do one of the following:
  - Press the **Search** button on the remote control until you see the image from the source you want.

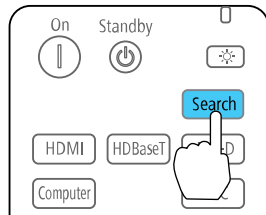

- Press the button for the source you want on the remote control.

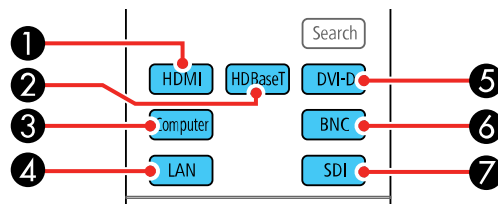

- 1 HDMI port source
- 2 HDBaseT port source
- 3 Computer port source
- 4 Network port source

- 5 DVI-D port source
- 6 BNC port source
- 7 SDI port source

- Press the button for the source you want on the projector.

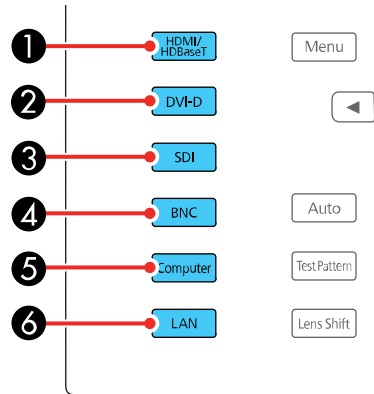

- 1 HDMI and HDBaseT port sources
- 2 DVI-D port source
- 3 SDI port source
- 4 BNC port source
- 5 Computer port source
- 6 Network port source

Parent topic: [Using Basic Projector Features](#)

## Remote Control Operation

The remote control lets you control the projector from almost anywhere in the room, up to 98.4 feet (30 m) away. You can point it at the front or rear of the projector.

Make sure that you aim the remote control at the projector's receivers within the angles listed here.

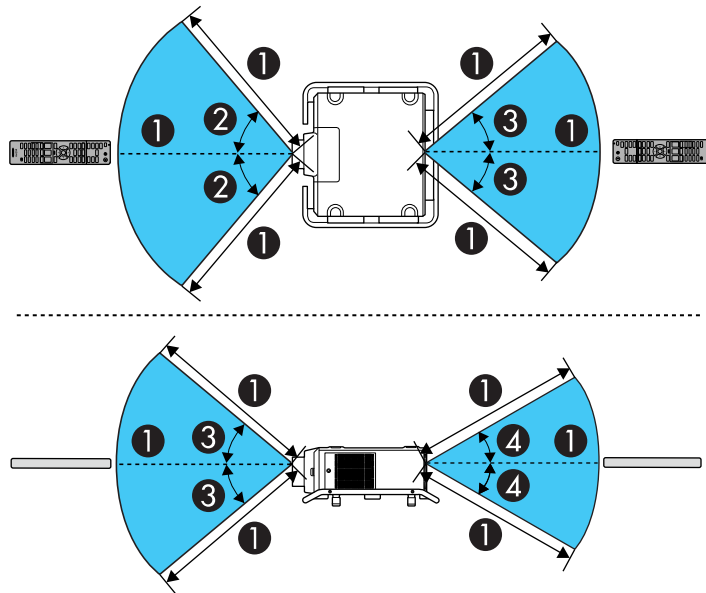

- 1 98.4 feet (30 m)
- 2  $\pm 50^\circ$
- 3  $\pm 40^\circ$
- 4  $\pm 30^\circ$

**Note:** Avoid using the remote control in conditions with bright fluorescent lights or in direct sunlight, or the projector may not respond to commands. If you will not use the remote control for a long time, remove the batteries.

**Parent topic:** [Using Basic Projector Features](#)

**Related tasks**

[Replacing the Remote Control Batteries](#)

## Projection Modes

Depending on how you positioned the projector, you may need to change the projection mode so your images project correctly.

- **Front** (default setting) lets you project from a table in front of the screen.
- **Front/Ceiling** flips the image over top-to-bottom to project upside-down from a ceiling or wall mount.
- **Rear** flips the image horizontally to project from behind a translucent screen.
- **Rear/Ceiling** flips the image over top-to-bottom and horizontally to project from the ceiling and behind a translucent screen.

[Changing the Projection Mode Using the Remote Control](#)

[Changing the Projection Mode Using the Menus](#)

**Parent topic:** [Using Basic Projector Features](#)

## Changing the Projection Mode Using the Remote Control

You can change the projection mode to flip the image over top-to-bottom.

1. Turn on the projector and display an image.
2. Hold down the **Shutter** button on the remote control for five seconds.

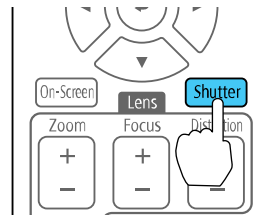

The image disappears briefly and reappears flipped top-to-bottom.

3. To change projection back to the original mode, hold down the **Shutter** button for five seconds again.

**Parent topic:** [Projection Modes](#)

## Changing the Projection Mode Using the Menus

You can change the projection mode to flip the image over top-to-bottom and/or left-to-right using the projector menus.

1. Turn on the projector and display an image.
2. Press the **Menu** button.
3. Select the **Extended** menu and press **Enter**.

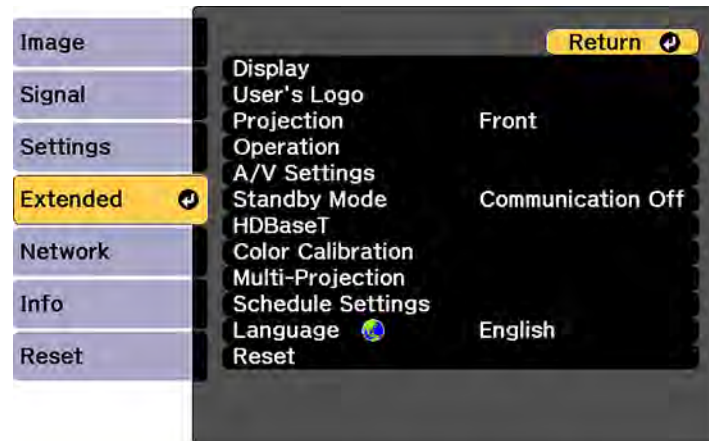

4. Select the **Projection** setting and press **Enter**.
5. Select a projection mode and press **Enter**.
6. Press **Menu** or **Esc** to exit the menus.

**Parent topic:** [Projection Modes](#)

## Image Aspect Ratio

The projector can display images in different width-to-height ratios called aspect ratios. Normally the input signal from your video source determines the image's aspect ratio. However, for certain images you can change the aspect ratio to fit your screen by pressing a button on the remote control.

If you always want to use a particular aspect ratio for a certain video input source, you can select it using the projector's menus.

[Changing the Image Aspect Ratio](#)

[Available Image Aspect Ratios](#)

**Parent topic:** [Using Basic Projector Features](#)

### Related references

[Image Quality Settings - Image Menu](#)

## Changing the Image Aspect Ratio

You can change the aspect ratio of the displayed image to resize it.

**Note:** Set the **Screen Type** setting in the projector's Extended menu before changing the aspect ratio.

1. Turn on the projector and switch to the image source you want to use.
2. Press the **Aspect** button on the remote control.

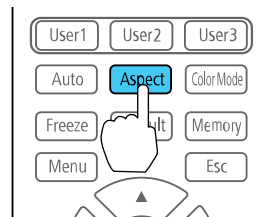

The shape and size of the displayed image changes, and the name of the aspect ratio appears briefly on the screen.

3. To cycle through the available aspect ratios for your input signal, press the **Aspect** button repeatedly.

**Note:** If you are projecting from a computer and parts of the image are cut off, set the **Resolution** setting to **Wide** or **Normal** in the Signal menu.

**Parent topic:** [Image Aspect Ratio](#)

### Related references

[Input Signal Settings - Signal Menu](#)

### Related tasks

[Setting the Screen Type](#)



## Available Image Aspect Ratios

You can select the following image aspect ratios, depending on the selected Screen Type setting and the input signal from your image source.

**Note:** Black bands and cropped or stretched images may project in certain aspect ratios, depending on the aspect ratio and resolution of your input signal.

Screen Type setting	Available aspect ratios
<b>4:3</b>	Auto, Normal, 4:3, 6:9, Native*
<b>16:9</b>	Auto, Normal, Full, H-Zoom, V-Zoom, Native
<b>16:10</b>	Auto, Normal, 16:9, Full, H-Zoom, V-Zoom, Native

\*Available only when projecting computer images or from sources connected to the **HDMI** or **HDBaseT** port

Aspect ratio setting	Description
<b>Auto</b>	Automatically sets the aspect ratio according to the input signal.
<b>Normal</b>	Displays images in the same aspect ratio of the input signal.
<b>4:3</b>	Displays images at a 4:3 aspect ratio.
<b>16:9</b>	Displays images at a 16:9 aspect ratio.
<b>Full</b>	Displays images using the full size of the projection area, but does not maintain the aspect ratio.
<b>H-Zoom</b> <b>V-Zoom</b>	Displays images using the full width (H-Zoom) or full height (V-Zoom) of the projection area and maintains the aspect ratio of the image. Areas that exceed the edges of the projected screen are not projected.
<b>Native</b>	Displays images as is (aspect ratio and resolution are maintained). Areas that exceed the edges of the projected screen are not projected.

Parent topic: [Image Aspect Ratio](#)

Related tasks

[Setting the Screen Type](#)

## Color Mode

The projector offers different Color Modes to provide optimum brightness, contrast, and color for a variety of viewing environments and image types. You can select a mode designed to match your image and environment, or experiment with the available modes.

If you always want to use a particular color mode for a certain video input source, you can select it using the projector menus.

[Changing the Color Mode](#)

[Available Color Modes](#)

**Parent topic:** [Using Basic Projector Features](#)

**Related references**

[Image Quality Settings - Image Menu](#)

## Changing the Color Mode

You can change the projector's Color Mode using the remote control to optimize the image for your viewing environment.

1. Turn on the projector and switch to the image source you want to use.
2. If you are projecting from a DVD player or other video source, insert a disc or other video media and press the play button, if necessary.
3. Press the **Color Mode** button on the remote control to change the Color Mode.

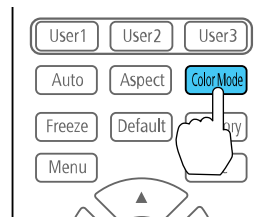

The image appearance changes and the name of the Color Mode appears briefly on the screen.

4. To cycle through all the available Color Modes for your input signal, press the **Color Mode** button repeatedly.

**Parent topic:** [Color Mode](#)

## Available Color Modes

You can set the projector to use these Color Modes, depending on the input source you are using:

Color Mode	Description
<b>Dynamic</b>	Best for projecting in a bright room
<b>Presentation</b>	Best for color presentations in a bright room
<b>Cinema</b>	Best for movies projected in a dark room
<b>sRGB</b>	Best for standard sRGB computer displays
<b>DICOM SIM*</b>	Best for projecting X-ray photographs and other medical images
<b>Multi-Projection</b>	Best for projecting from multiple projectors (reduces the color tone difference between images)

\* Available only when inputting RGB signals

**Note:** The **DICOM SIM** Color Mode is for reference purposes only and should not be used to make medical diagnoses.

Parent topic: [Color Mode](#)

## Adjusting the Brightness

You can adjust the brightness of your projector's light source.

1. Turn on the projector and switch to the image source you want to use.
2. Press the **Menu** button.

3. Select the **Settings** menu and press **Enter**.

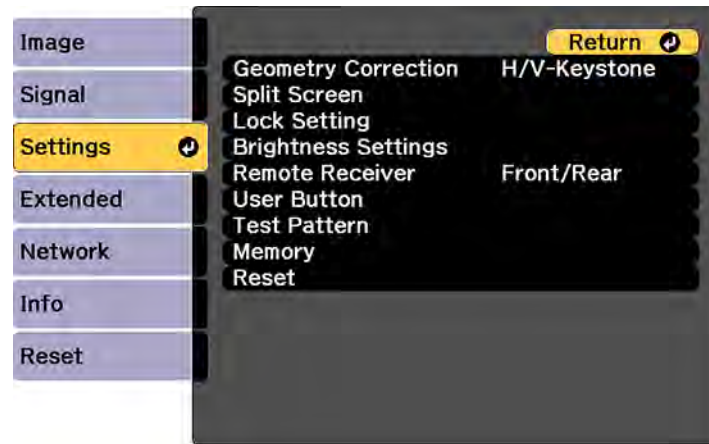

4. Select the **Brightness Settings** setting and press **Enter**.

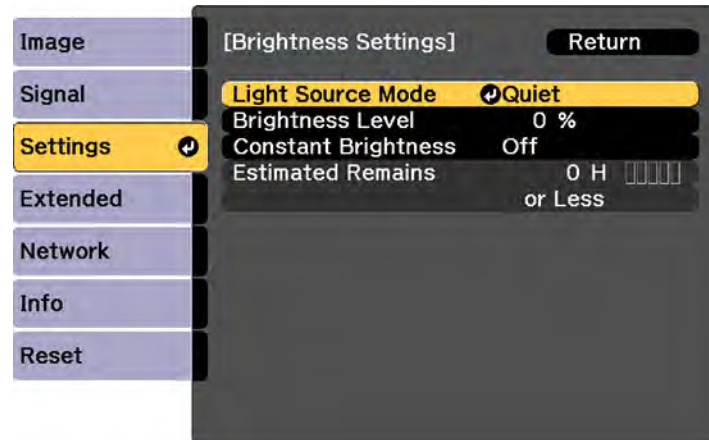

5. Select the **Light Source Mode** setting and press **Enter**.
6. Select one of the following options:
  - **Normal**: Sets brightness to maximum level (ideal for conference rooms, auditoriums, and lecture halls)

- **Quiet:** Sets brightness to 70% and reduces fan noise (ideal for libraries, theaters, museums, and art galleries)
  - **Extended:** Sets brightness to 70% and extends the life expectancy of the light source (ideal for darker environments with ambient light, such as museums and art galleries, where a reduced maintenance cycle is desired)
  - **Custom:** Allows you to select a custom brightness level between 30 to 100%
7. If you selected **Custom**, select **Brightness Level** from the Brightness Settings screen and use the left and right arrow buttons to select the brightness. To maintain consistent brightness, turn on the **Constant Brightness** setting.

**Note:** If you turn on **Constant Brightness**, you cannot change the **Light Source Mode** and **Brightness Level** settings. If you turn off **Constant Brightness**, the **Brightness Level** setting changes according to the status of the light source.

8. Press **Menu** or **Esc** to exit the menus.

**Note:** If you use the projector continuously for more than 24 hours, or regularly turn it off by shutting off the power outlet, schedule periodic **Light Source Calibration** events from the Extended menu. Otherwise, the **Constant Brightness** setting may not work properly.

[Constant Brightness Usage Hours](#)

**Parent topic:** [Using Basic Projector Features](#)

#### **Related references**

[Projector Setup Settings - Extended Menu](#)

#### **Related tasks**

[Saving a Scheduled Event](#)

## Constant Brightness Usage Hours

If you turn on the **Constant Brightness** setting, the number of hours the projector can maintain constant brightness is displayed as the **Estimated Remains** setting.

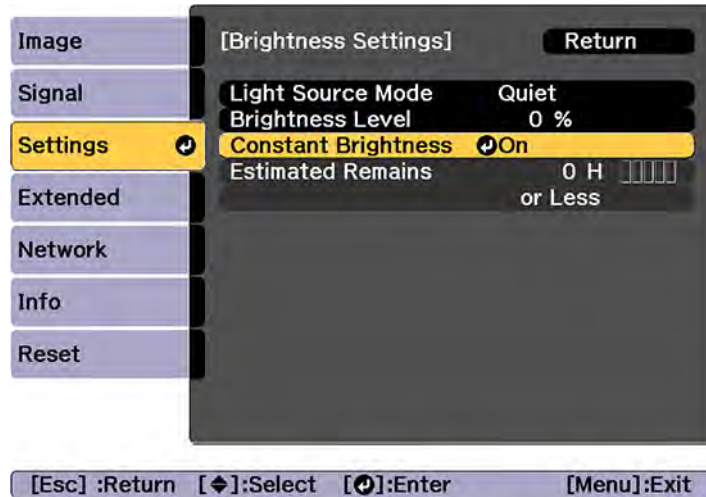

Display level	Estimated remaining hours
	10000 or more hours
█	8000 to 9999 hours
██	6000 to 7999 hours
███	4000 to 5999 hours
████	2000 to 3999 hours
█████	0 to 1999 hours

### Light source life span

The estimated life span of the light source varies depending on the **Brightness Level** setting and whether the **Constant Brightness** setting is on or off.

### Constant Brightness off

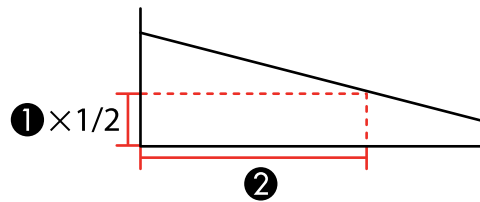

- 1 Brightness level
- 2 Time before the brightness of the light source is reduced by half (approximate)

Brightness Level setting	Hours
100%	20000 hours
90%	36000 hours
80%	41000 hours
70%	43000 hours
60%	46000 hours
50%	57000 hours
40%	75000 hours
30%	103000 hours

### Constant Brightness on

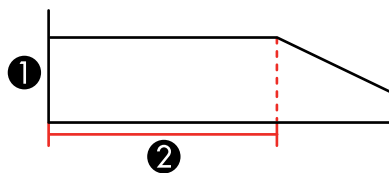

- 1 Brightness level
- 2 Time the projector can maintain constant brightness (approximate)

Brightness Level setting	Hours
90%	7000 hours
80%	15000 hours
70%	25000 hours
60%	35000 hours
50%	47000 hours
40%	66000 hours
30%	95000 hours

**Note:** The light source usage hours vary depending upon environmental conditions and usage. The hours listed here are an approximate and are not guaranteed. After 20000 hours of use, you may need to replace parts in the projector. If **Constant Brightness** is turned on, and you have exceeded the usage hours listed here, you may not be able to select a high **Brightness Level** setting.

Parent topic: [Adjusting the Brightness](#)

## Turning On Automatic Luminance Adjustment

In the **Dynamic** and **Cinema** color modes, you can turn on the **Dynamic Contrast** setting to automatically optimize the image luminance. This improves the image contrast based on the brightness of the content you project.

1. Turn on the projector and switch to the image source you want to use.
2. Press the **Menu** button.



3. Select the **Image** menu and press **Enter**.

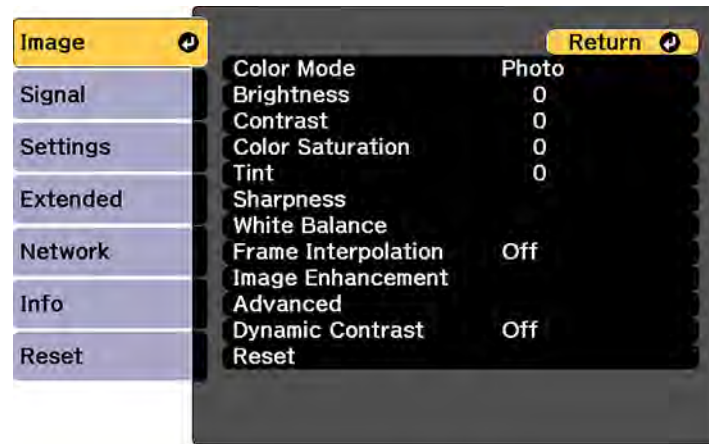

4. Select the **Dynamic Contrast** setting, choose one of the following options, and press **Enter**:
  - **High Speed** to adjust brightness as soon as the scene changes.
  - **Normal** to adjust brightness at the standard speed.
5. Press **Menu** or **Esc** to exit the menus.

Parent topic: [Using Basic Projector Features](#)

## Setting the Date and Time

You can set the date and time for the projector.

**Note:** If the **Schedule Protection** setting in the Password Protection screen is enabled, you cannot change the date and time settings.

1. Press the **Menu** button.
2. Select the **Extended** menu and press **Enter**.
3. Select the **Operation** setting and press **Enter**.
4. Select the **Date & Time** setting and press **Enter**.

You see a screen like this:

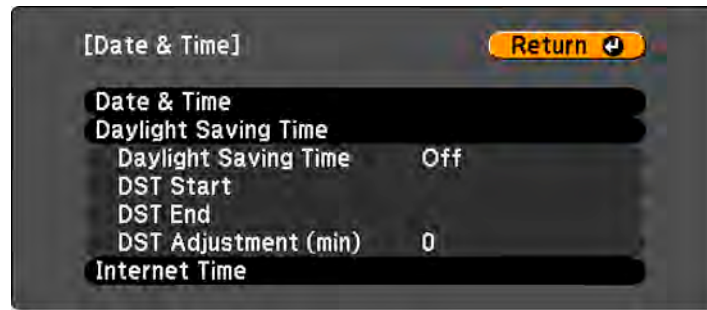

5. Select your date and time settings. Then select **Set** and press **Enter** to confirm your changes.
6. When you are finished, press the **Menu** button to exit.

[Date and Time Settings](#)

**Parent topic:** [Using Basic Projector Features](#)

**Related concepts**

[Password Security Types](#)

## Date and Time Settings

Settings	Options	Description
Date & Time	Date Time Time Difference (UTC)	Adjusts the projector's date and time settings <b>Date and Time:</b> sets the date and time <b>Time Difference (UTC):</b> sets the time difference from Coordinated Universal Time

Settings	Options	Description
<b>Daylight Saving Time</b>	<b>Daylight Saving Time</b> <b>DST Start</b> <b>DST End</b> <b>DST Adjustment (min)</b>	Adjusts the daylight saving time settings <b>Daylight Saving Time:</b> enables or disables daylight saving time <b>DST Start</b> and <b>DST End:</b> sets the date and time to start or end daylight saving time <b>DST Adjustment (min):</b> sets the difference between standard and daylight saving time
<b>Internet Time</b>	<b>Internet Time</b> <b>Internet Time Server</b>	Automatically adjusts the time through an Internet connection <b>Internet Time:</b> turn on this setting to update the date and time automatically through an Internet time server <b>Internet Time Server:</b> sets the IP address for the Internet time server

Parent topic: [Setting the Date and Time](#)

---

# Adjusting Projector Features

Follow the instructions in these sections to use your projector's feature adjustments.

[Shutting Off the Picture Temporarily](#)

[Stopping Video Action Temporarily](#)

[Projector Security Features](#)

[Projecting Two Images Simultaneously](#)

[Using Advanced Image Adjustment Features](#)

[Using Multiple Projectors](#)

[Enabling Protocol Emulation](#)

[Saving Settings to Memory and Using Saved Settings](#)

[Saving a Scheduled Event](#)

[Copying Menu Settings Between Projectors](#)

## Shutting Off the Picture Temporarily

You can temporarily turn off the projected picture if you want to redirect your audience's attention during a presentation. Any video action continues to run, however, so you cannot resume projection at the point that you stopped it.

**Note:** If the picture is off for more than 2 hours, the power automatically turns off. You can disable the **Shutter Timer** setting in the Extended Menu to turn off this feature.

1. Press the **Shutter** button on the projector's control panel or remote control to temporarily stop projection.

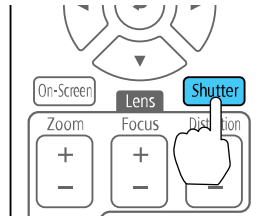
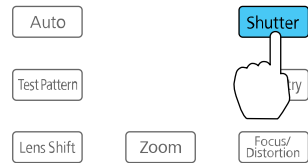

2. To turn the picture back on, press the **Shutter** button again.

**Note:** To fade the image in and out when you press the **Shutter** button, turn on the **Fade-out** and **Fade-in** settings in the Extended menu. If you selected **Shutter** as the **Shutter Release** setting in the Extended menu, you can still control the projector while the shutter feature is active.

**Parent topic:** [Adjusting Projector Features](#)

**Related references**

[Projector Setup Settings - Extended Menu](#)

## Stopping Video Action Temporarily

You can temporarily stop the action in a video or computer presentation and keep the current image on the screen. Any video action continues to run, however, so you cannot resume projection at the point that you stopped it.

1. Press the **Freeze** button on the remote control to stop the video action.

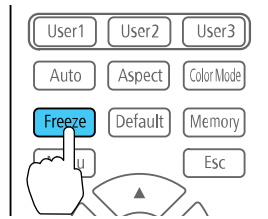

2. To restart the video action in progress, press **Freeze** again.

Parent topic: [Adjusting Projector Features](#)

## Projector Security Features

You can secure your projector to deter theft or prevent unintended use by setting up the following security features:

- Password security to prevent the projector from being turned on, and prevent changes to the startup screen and other settings.
- Button lock security to block operation of the projector using the buttons on the control panel or remote control.
- Security cabling to physically cable the projector in place.

[Password Security Types](#)

[Locking the Projector's Lens Settings and Buttons](#)

[Locking the Remote Control Buttons](#)

[Installing a Security Cable](#)

Parent topic: [Adjusting Projector Features](#)

## Password Security Types

You can set up these types of password security using one shared password:

- **Power On Protection** password prevents anyone from using the projector without first entering a password.
- **User's Logo Protection** password prevents anyone from changing the custom screen the projector can display when it turns on. The presence of the custom screen discourages theft by identifying the projector's owner.

- **Network Protection** password prevents anyone from changing the network settings in the projector menus.
- **Schedule Protection** password prevents anyone from changing the projector's time or schedule settings.

[Setting a Password](#)

[Selecting Password Security Types](#)

[Entering a Password to Use the Projector](#)

[Saving a User's Logo Image to Display](#)

**Parent topic:** [Projector Security Features](#)

## Setting a Password

To use password security, you must set a password.

1. Hold down the **Freeze** button on the remote control for about five seconds or until you see this menu.

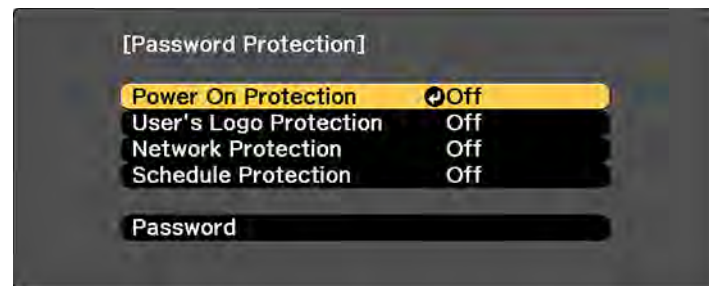

2. Press the down arrow to select **Password** and press **Enter**.  
You see the prompt "Change the password?".
3. Select **Yes** and press **Enter**.

4. Press and hold down the **Num** button on the remote control and use the numeric buttons to set a four-digit password.

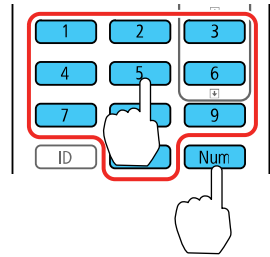

The password displays as \*\*\*\* as you enter it. Then you see the confirmation prompt.

5. Enter the password again.  
You see the message "Password accepted."
6. Press **Esc** to return to the menu.
7. Make a note of the password and keep it in a safe place in case you forget it.

**Parent topic:** [Password Security Types](#)

### Selecting Password Security Types

After setting a password, you see this menu, allowing you to select the password security types you want to use.



If you do not see this menu, hold down the **Freeze** button on the remote control for about five seconds or until the menu appears.



1. To prevent unauthorized use of the projector, select **Power On Protection**, press **Enter**, select **On**, press **Enter** again, and press **Esc**.
2. To prevent changes to the User's Logo screen or related display settings, select **User's Logo Protection**, press **Enter**, select **On**, press **Enter** again, and press **Esc**.
3. To prevent changes to network settings, select **Network Protection**, press **Enter**, select **On**, press **Enter** again, and press **Esc**.
4. To prevent changes to the projector's time or schedule settings, select **Schedule Protection**, press **Enter**, select **On**, press **Enter** again, and press **Esc**.

**Note:** Be sure to keep the remote control in a safe place; if you lose it, you will not be able to enter the password required to use the projector.

**Parent topic:** [Password Security Types](#)

### Entering a Password to Use the Projector

If a password is set up and a **Power On Protection** password is enabled, you see a prompt to enter a password whenever you turn on the projector.

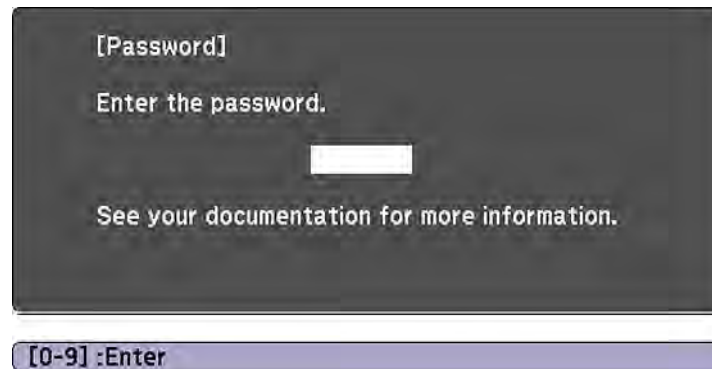

You must enter the correct password to use the projector.

1. Press and hold down the **Num** button on the remote control while you enter the password using the numeric buttons.

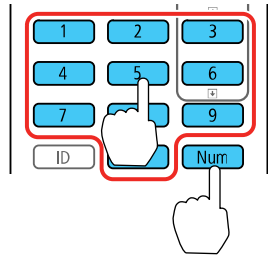

**Note:** The default password is **0000**.

The password screen closes.

2. If the password is incorrect, the following may happen:
  - You see a "wrong password" message and a prompt to try again. Enter the correct password to proceed.
  - If you enter an incorrect password several times in succession, the projector displays a request code and a message to contact Epson Support. Do not attempt to enter the password again. When you contact Epson Support, provide the displayed request code and proof of ownership for assistance in unlocking the projector.

**Parent topic:** [Password Security Types](#)

### **Saving a User's Logo Image to Display**

You can transfer an image to the projector and then display it whenever the projector turns on. You can also display the image when the projector is not receiving an input signal or when you temporarily stop projection (using the Shutter feature). This transferred image is called the User's Logo screen.

The image you select as the User's Logo can be a photo, graphic, or company logo, which is useful in identifying the projector's owner to help deter theft. You can prevent changes to the User's Logo by setting up password protection for it.

1. Display the image you want to project as the User's Logo.

2. Press the **Menu** button, select the **Extended** menu, and press **Enter**.

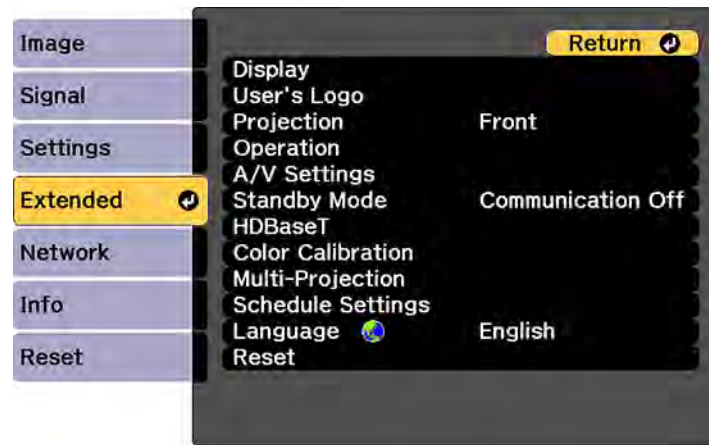

3. Select the **User's Logo** setting and press **Enter**.  
You see a prompt asking if you want to use the displayed image as a user's logo.
4. Select **Yes** and press **Enter**.  
You see a selection box overlaying your image.
5. Use the arrow buttons on the remote control or control panel to surround the image area you want to use as the User's Logo and press **Enter**.  
You see a prompt asking if you want to select this image area.
6. Select **Yes** and press **Enter**. (If you want to change the selected area, select **No**, press **Enter**, and repeat the last step.)

You see the User's Logo zoom factor menu.

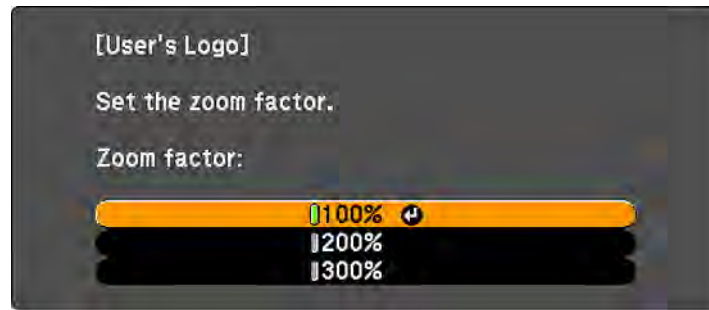

7. Select a zoom percentage and press **Enter**.  
You see a prompt asking if you want to save the image as the User's Logo.
8. Select **Yes** and press **Enter**.  
You see a completion message.
9. Press **Esc** to exit the message screen.
10. Select the **Extended** menu and press **Enter**.
11. Select **Display** and press **Enter**.
12. Select when you want to display the User's Logo screen:
  - To display it whenever there is no input signal, select **Display Background** and set it to **Logo**.
  - To display it whenever you turn the projector on, select **Startup Screen** and set it to **On**.

To prevent anyone from changing the User's Logo settings without first entering a password, set a password and enable User's Logo security.

**Parent topic:** [Password Security Types](#)

## Locking the Projector's Lens Settings and Buttons

You can lock the buttons on the projector's control panel to prevent anyone from using the projector. You can also lock the zoom, focus, and lens shift settings to prevent them from being adjusted.

**Note:** You can use the remote control to control the projector when the control panel buttons are locked.

1. Press the **Menu** button.

2. Select the **Settings** menu and press **Enter**.

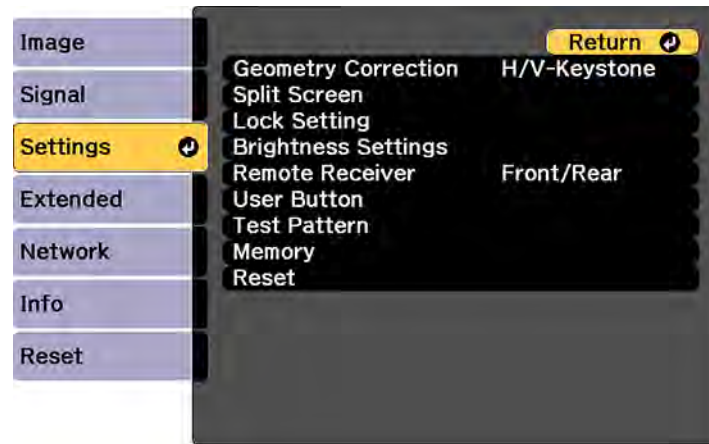

3. Select the **Lock Setting** setting and press **Enter**.
4. Select one of these lock types and press **Enter**:
  - To lock the zoom, focus, and lens shift settings, select **Lens Lock**.
  - To lock all buttons, select **Control Panel Lock > Full Lock**.
  - To lock all buttons except the power button, select **Control Panel Lock > Partial Lock**.

**Note:** The  lock icon is displayed on the screen if any control panel buttons are pressed while this setting is enabled.

**Note:** You can also press the lock button on the control panel to display the Control Panel Lock screen.

You see a confirmation prompt.

5. Select **Yes** and press **Enter**.
6. Restart the projector for the lock settings to take effect.

[Unlocking the Projector's Buttons](#)

**Parent topic:** [Projector Security Features](#)

## Unlocking the Projector's Buttons

If the projector's buttons have been locked, hold the **Enter** button on the projector's control panel for seven seconds to unlock them.

**Parent topic:** [Locking the Projector's Lens Settings and Buttons](#)

### Related references

[Projector Parts - Control Panel](#)

## Locking the Remote Control Buttons

You can lock some of the buttons on the remote control.

To lock the remote control buttons related to lens operation, turn on the **Lens Lock** setting in the Settings menu.

To lock the remote control buttons shown here, press and hold the **i** button on the remote control for approximately 5 seconds. (To unlock the buttons, press and hold the **i** button again for approximately 5 seconds.)

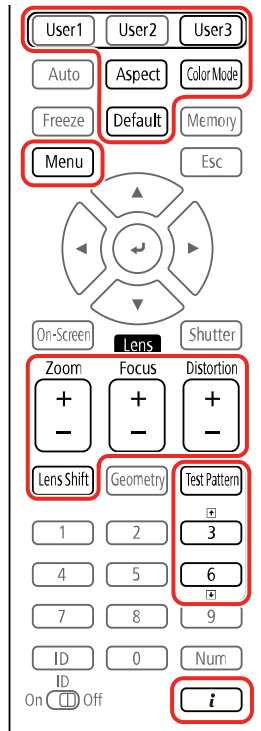

**Note:** If you lock the remote control buttons, you can still reset the **Remote Receiver** setting in the Settings menu to the default settings.

**Parent topic:** [Projector Security Features](#)

**Related references**

[Projector Feature Settings - Settings Menu](#)

**Related tasks**

[Locking the Projector's Lens Settings and Buttons](#)

## Installing a Security Cable

You can install two types of security cables on the projector to deter theft.

- Use the security slot on the projector to attach a Kensington lock. See your local computer or electronics dealer for purchase information.
- Use the security cable attachment point or the carrying handles on the projector to attach a wire cable and secure it to a room fixture or heavy furniture.

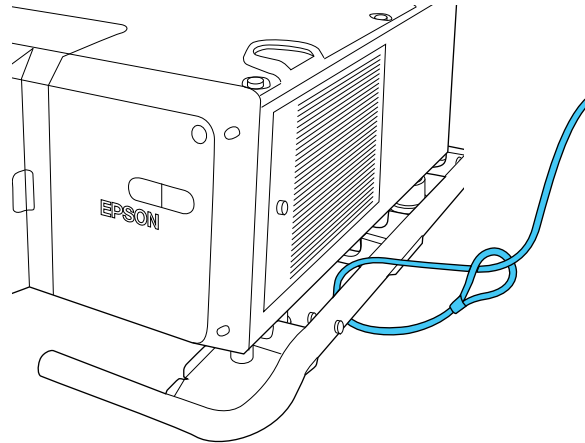

**Note:** Do not pass drop-prevention cables through the security cable attachment point when mounting the projector on a wall or ceiling.

**Parent topic:** [Projector Security Features](#)

**Related references**

[Projector Parts - Rear](#)



## Projecting Two Images Simultaneously

You can use the split screen feature to simultaneously project two images from different image sources next to each other. You can control the split screen feature using the projector menus.

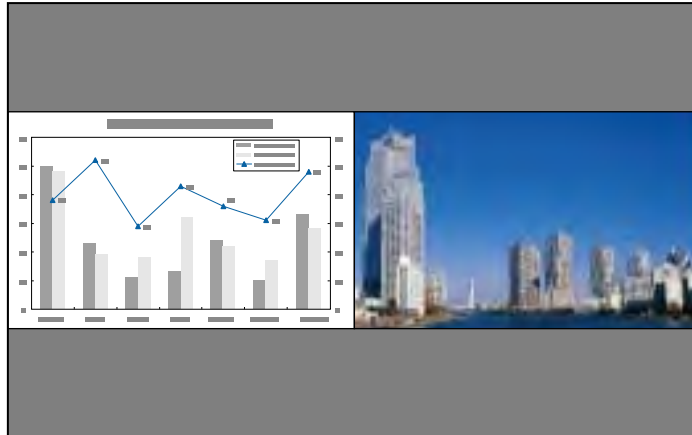

**Note:** While you use the split screen feature, other projector features may not be available and some settings may be automatically applied to both images. You cannot project from the same input source onto both sides (left and right) of the screen. You also cannot use split screen with certain input source combinations.

1. Press the **Menu** button.

2. Select the **Settings** menu and press **Enter**.

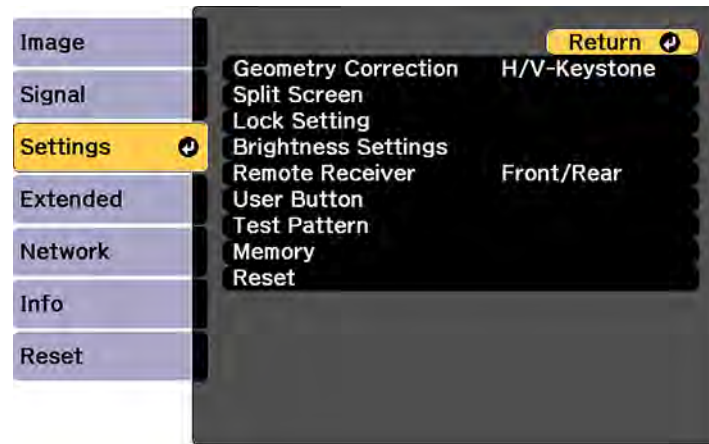

3. Press the **Menu** button.

You see this screen:

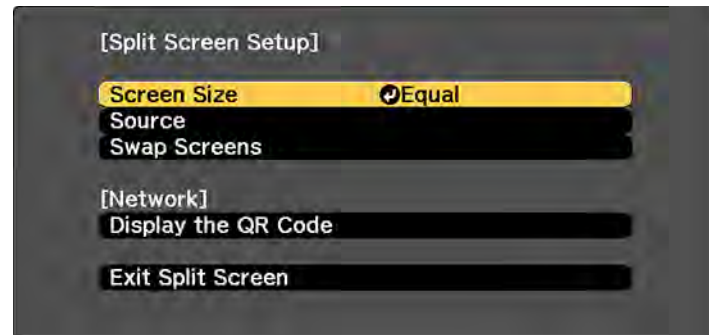

4. To select an input source for the other image, select the **Source** setting, press **Enter**, select the input source, select **Execute**, and press **Enter**. (You can also change image sources, if necessary.)
5. To switch the images, select the **Swap Screens** setting and press **Enter**.

- To change the image sizes, select the **Screen Size** setting, press **Enter**, select a sizing option, press **Enter**, and press **Menu** to exit.

**Note:** Depending on the video input signals, the images may not appear at the same size even if you choose the **Equal** setting.

- To exit the split screen feature, select **Exit Split Screen** or press the **Esc** button.

[Input Sources for Split Screen Projection](#)

Parent topic: [Adjusting Projector Features](#)

## Input Sources for Split Screen Projection

You can choose from the input source combinations listed here for split screen projection.

**Note:** Input signals exceeding WUXGA are not supported. If you see a 4K Enhancement message, select **Yes** to disable the 4K Enhancement feature.

Left Screen	Right Screen						
	HDMI	HDBaseT	DVI-D	SDI	Computer	BNC	LAN
HDMI	—	✓	✓	✓	✓	✓	✓
HDBaseT	✓	—	✓	✓	✓	✓	✓
DVI-D	✓	✓	—	✓	✓	✓	✓
SDI	✓	✓	✓	—	—	—	—
Computer	✓	✓	✓	—	—	—	—
BNC	✓	✓	✓	—	—	—	—
LAN	✓	✓	✓	—	—	—	—

Parent topic: [Projecting Two Images Simultaneously](#)

## Using Advanced Image Adjustment Features

Follow the instructions in these sections to use your projector's advanced image adjustments.

[Using Frame Interpolation](#)

[Using 4K Enhancement](#)

- Creating Image Presets
- Using MPEG Noise Reduction
- Adjusting Scaled Resolution Images (Super-resolution)
- Adjusting Detail Enhancement
- Adjusting the Color Convergence (Panel Alignment)
- Adjusting the Color Tone (Color Uniformity)

**Parent topic:** [Adjusting Projector Features](#)

## Using Frame Interpolation

You can use the projector's Frame Interpolation feature to smooth fast-moving video by comparing consecutive image frames and inserting an intermediate image frame between them.

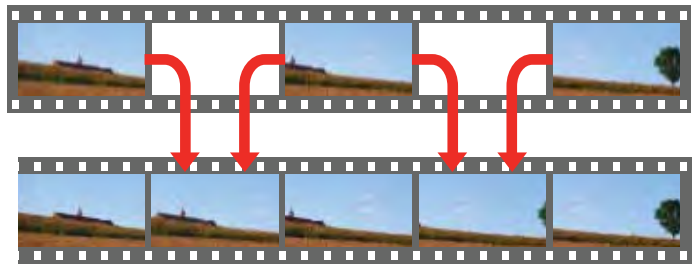

You cannot use this feature in any of the following conditions:

- The image signal exceeds WUXGA
- You turned on the **4K Enhancement**, **Edge Blending**, or **Scale** settings
- You selected **Fast 1** or **Fast 2** as the **Image Processing** setting

1. Press the **Menu** button.

You see a screen like this:

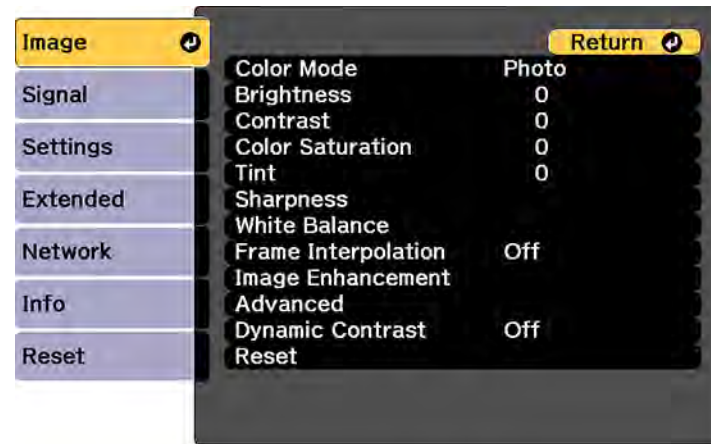

2. Select the **Frame Interpolation** setting and press **Enter**.

You see a screen like this:

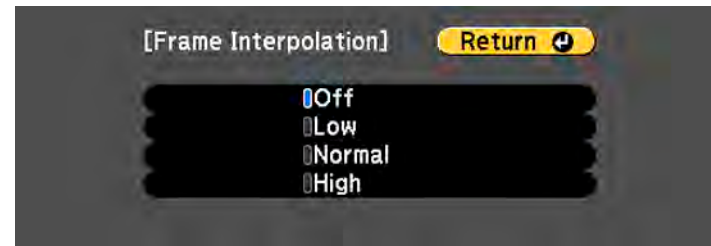

3. Select the level of interpolation and press **Enter**.
4. When you are finished, press the **Menu** button.

**Note:** If your resulting images contain noise, turn off the **Frame Interpolation** setting.

**Parent topic:** [Using Advanced Image Adjustment Features](#)

**Related references**

[Image Quality Settings - Image Menu](#)

## Using 4K Enhancement

Using the projector's 4K Enhancement Technology, you can receive 4K (3840 × 2160 pixel) signals and project ultra high-definition images. This technology shifts each pixel diagonally by 0.5 pixel to double the image resolution.

1. Press the **Menu** button.

You see a screen like this:

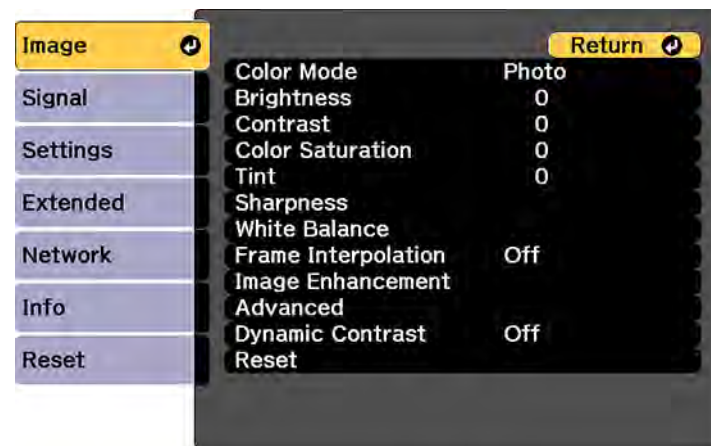

2. Select the **Image Enhancement** setting and press **Enter**.
3. Select the **4K Enhancement** setting and press **Enter**.

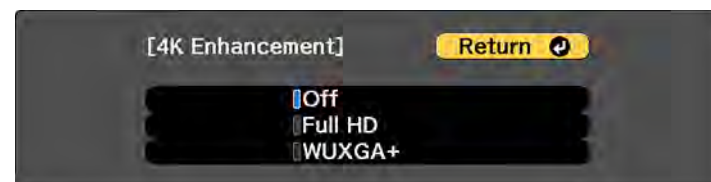

4. Select one of the following options and press **Enter**:
  - **Off** to disable 4K enhancement when projecting from computers or multiple projectors
  - **Full HD** to enhance a signal with a resolution of 1080i/1080p/WUXGA or higher
  - **WUXGA+** to enhance a signal with a resolution exceeding WUXGA; when projecting a high-resolution movie, select **WUXGA+** along with an appropriate **Image Preset Mode** setting

**Note:** If you select **Full HD** or **WUXGA+**, the following adjustment settings are canceled: **Scale**, **Curved Surface**, **Point Correction**, and **Corner Wall**.

5. Press **Menu** or **Esc** to exit the menus.

**Parent topic:** [Using Advanced Image Adjustment Features](#)

**Related references**

[Projector Feature Settings - Settings Menu](#)

[Projector Setup Settings - Extended Menu](#)

## Creating Image Presets

You can quickly optimize your projected image by selecting image adjustment settings and saving them as a preset you can reuse later.

You can save the following settings in a preset:

- Noise Reduction
- MPEG Noise Reduction
- Super-resolution
- Detail Enhancement

1. Press the **Menu** button.

You see a screen like this:

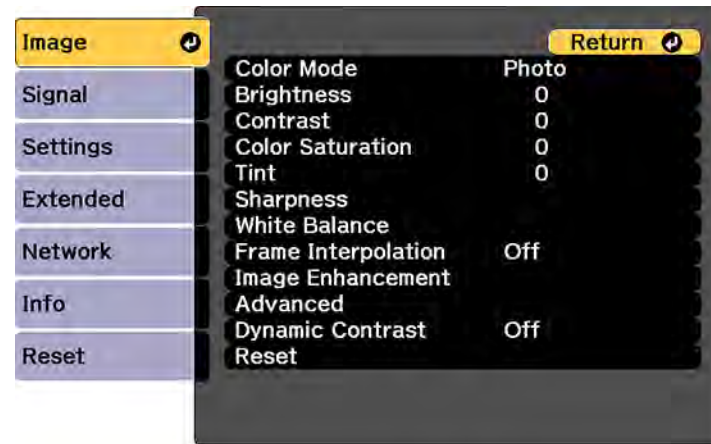

2. Select the **Image Enhancement** setting and press **Enter**.
3. Select the **Image Preset Mode** setting and press **Enter**.

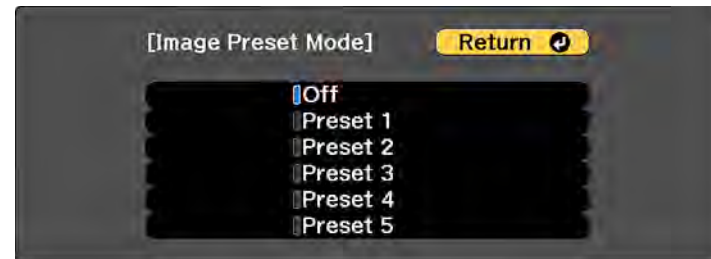

4. Select one of the presets.
5. Fine-tune each setting individually and press **Enter**.

**Note:** If you select a previously used preset, your new adjustments overwrite the old ones.

6. Press **Menu** or **Esc** to exit the menus.

**Parent topic:** [Using Advanced Image Adjustment Features](#)



## Related references

[Image Quality Settings - Image Menu](#)

## Using MPEG Noise Reduction

If you are projecting MPEG movies, you can reduce dots and block noise using the **MPEG Noise Reduction** setting.

**Note:** If you enable the **4K Enhancement** setting, or the resolution of your input signal exceeds WUXGA, this setting is disabled.

1. Press the **Menu** button.

You see a screen like this:

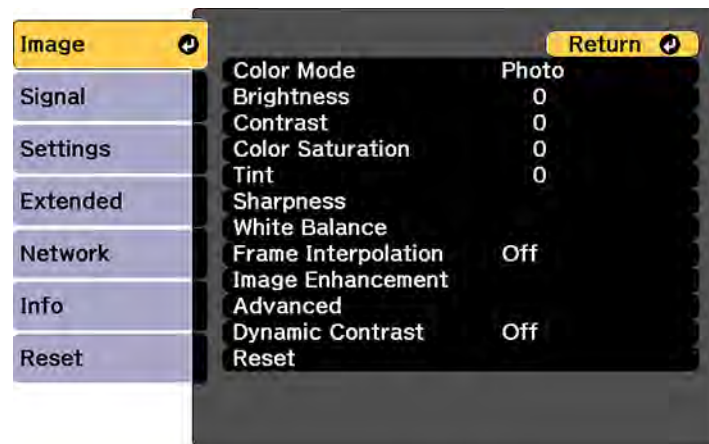

2. Select the **Image Enhancement** setting and press **Enter**.
3. Select the **MPEG Noise Reduction** setting and press **Enter**.
4. Select the level of noise reduction and press **Enter**.
5. Press **Menu** or **Esc** to exit the menus.

**Parent topic:** [Using Advanced Image Adjustment Features](#)

## Related tasks

[Using 4K Enhancement](#)

## Adjusting Scaled Resolution Images (Super-resolution)

You can sharpen blurry, low-resolution images that had their resolution scaled up for projection using the **Super-resolution** setting.

1. Turn on the projector and switch to the image source you want to use.
2. Press the **Menu** button.

You see a screen like this:

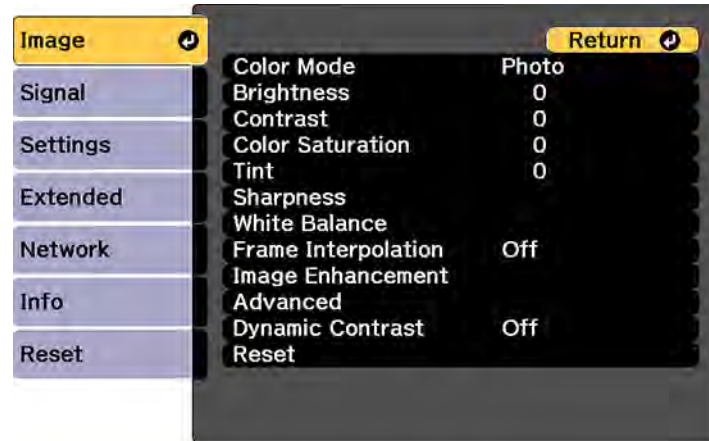

3. Select the **Image Enhancement** setting and press **Enter**.
4. Select the **Super-resolution** setting and press **Enter**.



5. Adjust each of the following options as necessary:
  - **Fine Line Adjust** to enhance fine details such as hair and fabric patterns
  - **Soft Focus Detail** to enhance the outline, background, and main parts of an image

**Note:** Higher values increase the intensity of the effect.

6. Press **Menu** or **Esc** to exit the menus.

**Parent topic:** [Using Advanced Image Adjustment Features](#)

## Adjusting Detail Enhancement

You can enhance the contrast in detailed areas of an image to create a more textured look.

1. Turn on the projector and switch to the image source you want to use.
2. Press the **Menu** button.

You see a screen like this:

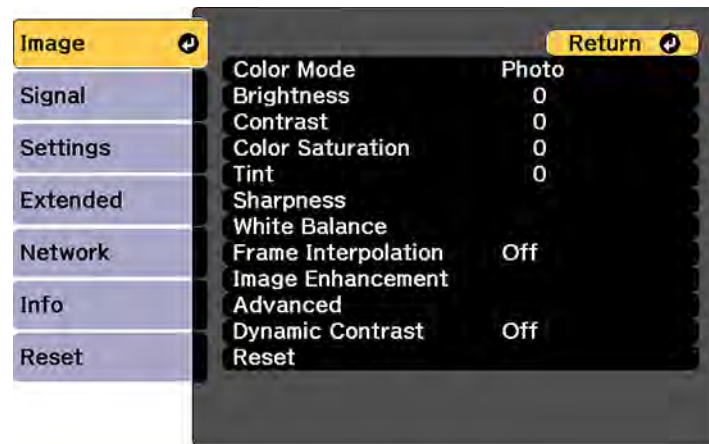

3. Select the **Image Enhancement** setting and press **Enter**.
4. Select the **Detail Enhancement** setting and press **Enter**.



5. Adjust each of the following options as necessary:
  - **Strength** to enhance the image contrast

- **Range** to increase the enhanced area of the image

**Note:** Higher values increase the intensity of the effect.

6. Press **Menu** or **Esc** to exit the menus.

**Parent topic:** [Using Advanced Image Adjustment Features](#)

## Adjusting the Color Convergence (Panel Alignment)

You can use the Panel Alignment feature to manually adjust the color convergence (the alignment of the red, green and blue colors) in the projected image.

**Note:** Allow your projector to warm up for at least 10 to 15 minutes and make sure the image is in focus before you use the Panel Alignment feature. The projected image size should be at least 60 inches (152 cm) diagonally and the projection surface should not be colored or textured; otherwise the adjustment grids are difficult to align.

1. Press the **Menu** button.
2. Select the **Extended** menu and press **Enter**.

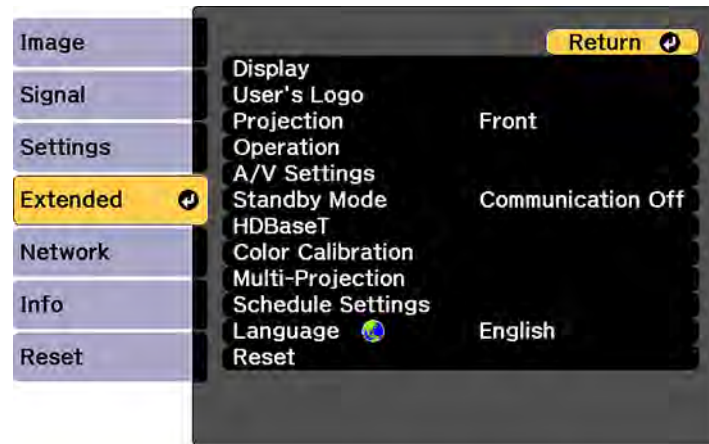

3. Select the **Display** setting and press **Enter**.
4. Select the **Panel Alignment** setting and press **Enter**.
5. Press **Enter** and select **On**.

6. Press **Esc**.
7. Select the **Select Color** setting and choose one of the following:
  - **R** to adjust the red color convergence
  - **B** to adjust the blue color convergence

**Note:** You can adjust only the red or blue color convergence; you cannot adjust the standard green color panel.

8. Select the **Pattern Color** setting and press **Enter**.
9. Select the pattern you want to use and press **Esc**.
10. Select **Start Adjustments** and press **Enter** twice.

You see this screen:

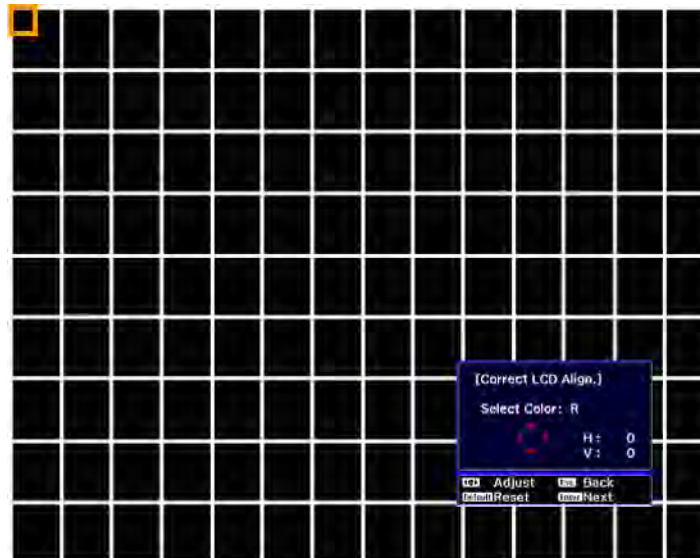

11. Use the arrow buttons on the remote control to adjust the color alignment in the corner of the screen highlighted by the orange box.
12. Press the **Enter** button to move to the next corner of the screen.
13. When you are finished adjusting each corner of the screen, press **Enter**.

You see this screen:

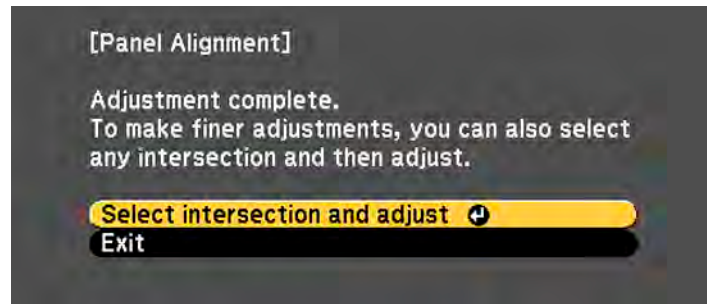

14. Do one of the following:

- If your projector's panel alignment is now correct, select **Exit** and press **Enter** to return to the Panel Alignment menu.
- If your projector needs additional panel alignment, select **Select intersection and adjust** and press **Enter**. Use the arrow keys on the remote control to highlight the corner of any box on the screen that is misaligned and press **Enter** to adjust the color convergence. Repeat this step as necessary.

**Parent topic:** [Using Advanced Image Adjustment Features](#)

## Adjusting the Color Tone (Color Uniformity)

You can use the Color Uniformity feature to manually adjust the color tone balance in the projected image.

1. Press the **Menu** button.

2. Select the **Extended** menu and press **Enter**.

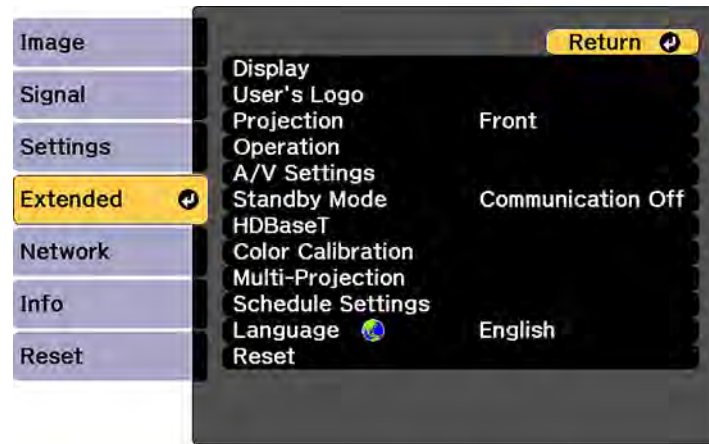

3. Select the **Display** setting and press **Enter**.
4. Select the **Color Uniformity** setting and press **Enter**.

You see this screen:



5. Press **Enter** and select **On**.
6. Press **Esc**.

7. Select the **Adjustment Level** setting and press **Enter**.
8. Press the right and left arrow buttons to adjust the level, then press **Esc**.
9. Select the **Start Adjustments** setting and press **Enter**.



10. Select the area of the screen that you want to adjust and press **Enter**.
11. Select the color (**Red**, **Green**, or **Blue**) you want to adjust, and use the left arrow button to weaken the color tone and the right arrow button to strengthen the color tone.
12. Press **Esc**.
13. Repeat steps 10 and 11 for each area you want to adjust.
14. When you are finished, press the **Menu** button.

**Parent topic:** [Using Advanced Image Adjustment Features](#)

## Using Multiple Projectors

You can combine the projected images from two or more projectors to create one large image. Follow the instructions in these sections to setup and project from multiple projectors.

[Multiple Projector Adjustment Overview](#)

[Projector Identification System for Multiple Projector Control](#)

[Tiling Images into One Image](#)

[Blending the Image Edges](#)

[Adjusting the Black Level](#)

[Matching Tint and Brightness \(Screen Matching\)](#)



## Scaling an Image

Parent topic: [Adjusting Projector Features](#)

### Multiple Projector Adjustment Overview

If you are combining images from multiple projectors on a network, you can assign one projector as the "master" and automatically adjust all the images to match the "master" image. If the projectors are not connected to a network, you can match each projector's images manually.

**Note:** Make sure all networked projectors are connected using LAN cables and have been assigned an IP address. Also disable Sleep Mode on each projector so they do not turn off during adjustment.

1. Turn on all the projectors.
2. To select a master projector for automatic adjustment, select **Custom** for the **Light Source Mode** setting and set the **Brightness Level** setting to the maximum value for all projectors. The projector with the darkest projected image is the master projector.
3. Do one of the following:
  - For automatic adjustment, set an ID for the master projector and the remote control.
  - For manual adjustment, set an ID for each projector and the remote control.
4. Adjust each projector's physical position and angle to the screen.
5. Do one of the following:
  - For automatic adjustment, configure tiling automatically.
  - For manual adjustment, configure tiling manually.
6. Adjust the image aspect ratio for each projector.
7. Adjust the position of the image for each projector using lens shift.
8. Adjust the zoom and focus for each projector.
9. Adjust small differences in the images using the **Point Correction** setting.
10. Adjust the edges of the images using the **Edge Blending** and **Black Level** settings.
11. Adjust the brightness and tint of the images using the **Screen Matching** setting.
12. Select sections of the images using the **Scale** setting.

Parent topic: [Using Multiple Projectors](#)

### **Related concepts**

[Wired Network Projection](#)

[Projector Identification System for Multiple Projector Control](#)

[Projector Placement](#)

[Image Aspect Ratio](#)

### **Related references**

[Projector Feature Settings - Settings Menu](#)

### **Related tasks**

[Turning On the Projector](#)

[Adjusting the Image Position Using Lens Shift](#)

[Adjusting the Image Position Using Screen Position](#)

[Resizing the Image with the Zoom Button](#)

[Focusing the Image Using the Focus Button](#)

[Correcting Image Shape with Point Correction](#)

[Blending the Image Edges](#)

[Adjusting the Black Level](#)

[Scaling an Image](#)

### **Related topics**

[Tiling Images into One Image](#)

[Matching Tint and Brightness \(Screen Matching\)](#)

## **Projector Identification System for Multiple Projector Control**

You can operate multiple projectors using one remote control for more elaborate presentations. To do this, you assign an identification number to each projector and to the remote control. Then you can operate all the projectors at once or individually.

[Setting the Projector ID](#)

[Setting the Remote Control ID](#)

**Parent topic:** [Using Multiple Projectors](#)

### **Setting the Projector ID**

If you want to control multiple projectors from a remote control, give each projector a unique ID.

1. Press the **Menu** button.
2. Select the **Extended** menu and press **Enter**.

3. Select the **Multi-Projection** setting and press **Enter**.
4. Select **Projector ID** and press **Enter**.

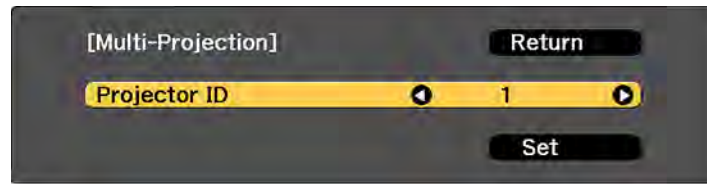

5. Press the left or right arrow buttons on the remote control to select the identification number you want to use for the projector. Then select **Set** and press **Enter**.

Repeat these steps for all the other projectors you want to operate from one remote control.

**Note:** If you don't know the projector's ID, hold down the **ID** button and press the **i** button to temporarily display the projector's ID on the screen.

**Parent topic:** [Projector Identification System for Multiple Projector Control](#)

### Setting the Remote Control ID

The remote control's ID is set to **0** by default so it can operate any compatible projector. If you want to set the remote control to operate only a particular projector, you need to set the remote control's ID to match the projector's ID.

1. Turn on the projector you want the remote control to operate with exclusively.
2. Set the remote control **ID** switch to **On**.

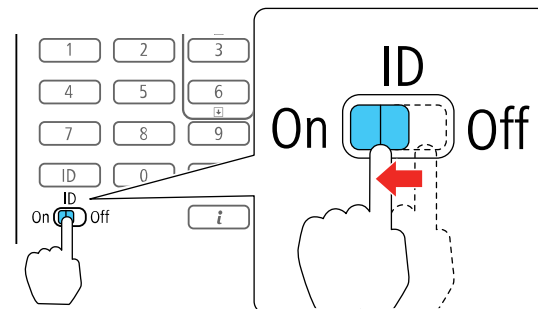

3. Hold down the **ID** button on the remote control while you press the numeric button that matches the projector's ID. Then release the buttons.

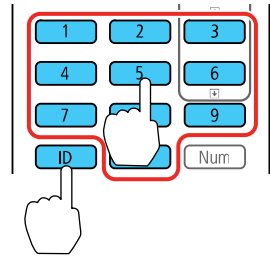

**Note:** If you don't know the projector's ID, hold down the **ID** button and press the **i** button to temporarily display the projector's ID on the screen. If the batteries are left out of the remote control for an extended period, the remote control ID returns to its default setting.

**Parent topic:** [Projector Identification System for Multiple Projector Control](#)

## Tiling Images into One Image

You can project the same image from up to nine projectors to create one large image using the Tiling feature.

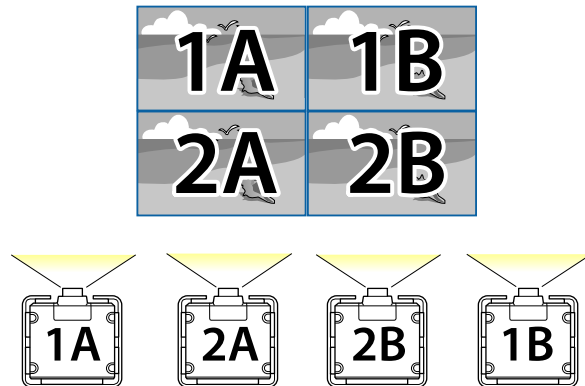

**Note:** Before tiling, make sure the displayed images from your projectors are rectangular, correctly sized, and focused.

[Configuring Tiling Automatically](#)

[Configuring Tiling Manually](#)

**Parent topic:** [Using Multiple Projectors](#)

**Related tasks**

[Multiple Projector Adjustment Overview](#)

## Configuring Tiling Automatically

If your projectors are on a network and you have identified a master projector, you can configure tiling automatically.

1. Turn on the projector.

**Note:** Make sure nothing is blocking the built-in camera on the front of the projector.

2. Press the **Menu** button.
3. Select the **Extended** menu and press **Enter**.
4. Select **Multi-Projection** and press **Enter**.

You see this screen:

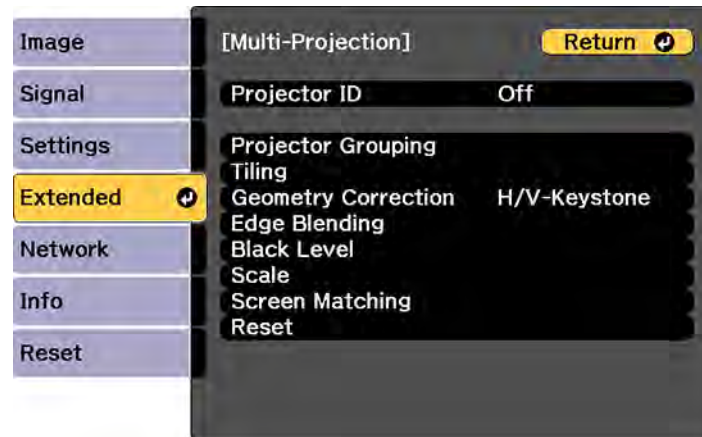

5. Select **Projector Grouping** and press **Enter**.

You see a screen like this:

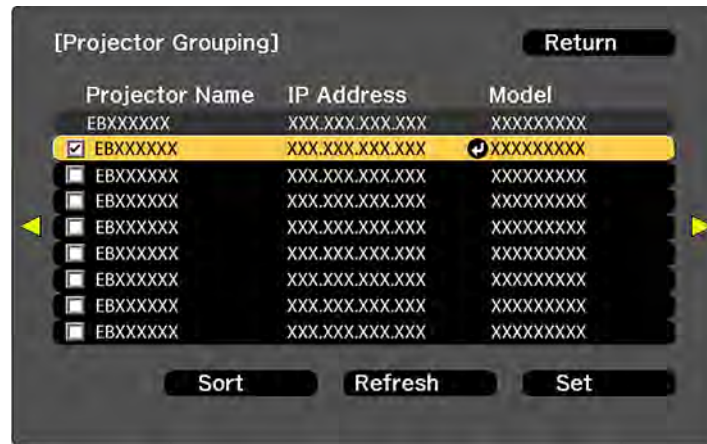

6. Press the up or down arrow buttons to highlight a projector and press **Enter** to place a checkmark next to each projector you want to use for tiling. Then select **Set** and press **Enter**.
7. Select **Tiling** and press **Enter**.
8. Select **Tiling** again and press **Enter**.

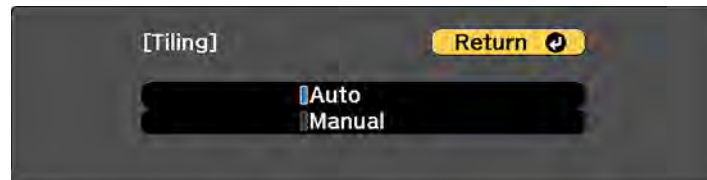

9. Select **Auto** and press **Esc**.
10. Select **Location Setup** and press **Enter**.  
The projected images are positioned automatically.
11. When you see the message to assign projector IDs, select **Yes**.  
When setup is complete, you see a screen like this:

**Note:** If any of the images are not positioned correctly, select **Manual** in step 9 to locate the image manually.

12. Select the input signal to display an image.

After performing the steps here, adjust the images for any gaps and differences in color.

**Note:** Do not change any of the projector names or IP addresses, or the images will not be adjusted automatically.

**Parent topic:** [Tiling Images into One Image](#)

**Related references**

[Projector Parts - Front/Top](#)

**Related tasks**

[Configuring Tiling Manually](#)

### Configuring Tiling Manually

If your projectors are not on a network or you were unsuccessful tiling the images automatically, you can configure tiling manually.

1. Turn on the projector.
2. Press the **Menu** button.
3. Select the **Extended** menu and press **Enter**.
4. Select **Multi-Projection > Tiling > Layout**.



5. Select the number of rows and columns you are setting up as the **Row** and **Column** settings. Then select **Set** and press **Enter**.

6. Repeat the previous steps with each projector you are setting up before continuing with the next step.
7. Select **Location Setup** and press **Enter**.

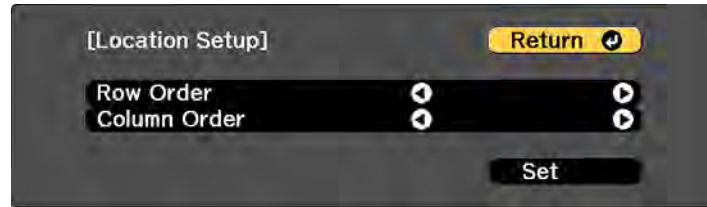

8. Select the position of each projected image as follows:
  - **Row Order** to layout the screens from top to bottom in sequential order, starting with **1** at the top
  - **Column Order** to layout the screens from left to right, starting with **A** on the left

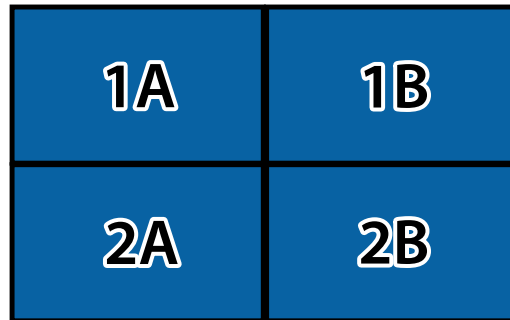

9. Repeat the previous step with each projector you are setting up before continuing with the next step.
10. Select the input signal to display an image.

After performing the steps here, adjust the images for any gaps and differences in color.

**Parent topic:** [Tiling Images into One Image](#)



## Blending the Image Edges

You can use the projector's Edge Blending feature to create a seamless image from multiple projectors.

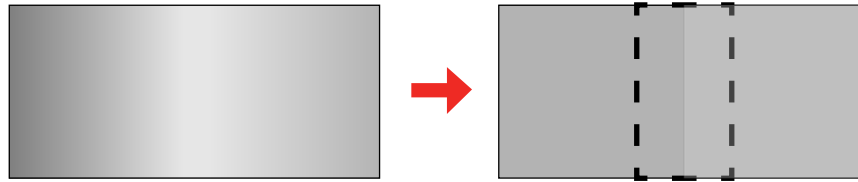

1. Press the **Menu** button.
2. Select the **Extended** menu and press **Enter**.
3. Select the **Multi-Projection** setting and press **Enter**.
4. Select the **Edge Blending** setting and press **Enter**.

You see this screen:

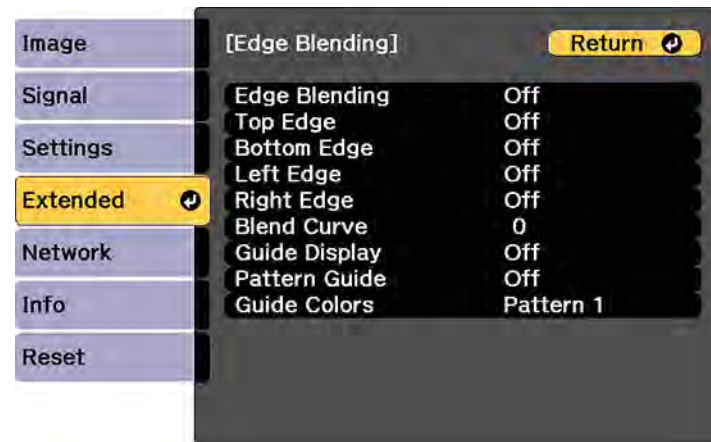

5. Turn on the **Edge Blending**, **Guide Display**, and **Pattern Guide** settings.

**Note:** If the projected guide is unclear, try changing the **Guide Colors** setting.

6. Select the edge you want to blend and press **Enter**.

You see a screen like this:



7. Select the **Blending** setting and select **On**.
8. Select the **Blend Start Position** setting and adjust the point where edge blending begins.
9. Select the **Blend Range** setting and select the width of the blended area so that the displayed guides are at the edges of the overlapping area between the two images.

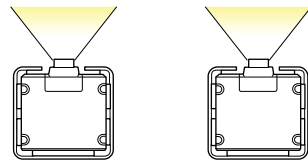
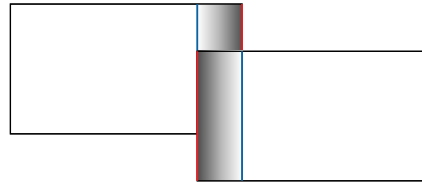

10. Press **Esc** to go back to the previous screen.
11. Select the **Blend Curve** setting and select a gradient for the shaded area.
12. When the edges are blended, turn off the **Guide Display** and **Pattern Guide** settings to check the final settings.
13. When you are finished, press the **Menu** button.

**Parent topic:** [Using Multiple Projectors](#)

## Adjusting the Black Level

When two images overlap, the overlapping area can appear differently from the areas that do not overlap. You can use the projector's Black Level setting to make the difference less noticeable.

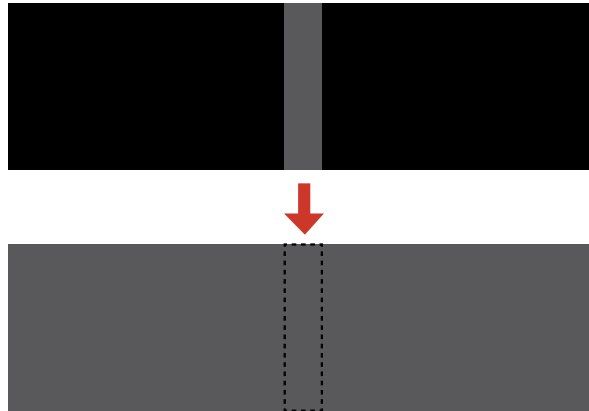

**Note:** You may not be able to adjust the black levels correctly if the **Geometry Correction** settings are set too high. The brightness and tone of the overlapping areas may differ from the rest of the image even after adjusting the black level.

1. Press the **Menu** button.
2. Select the **Extended** menu and press **Enter**.
3. Select the **Multi-Projection** setting and press **Enter**.
4. Select the **Black Level** setting and press **Enter**.



205 Westwood Ave, Long Branch, NJ 07740  
Phone: 866-94 BOARDS (26273) / (732)-222-1511  
Fax: (732)-222-7088 | E-mail: [sales@touchboards.com](mailto:sales@touchboards.com)

You see this screen:

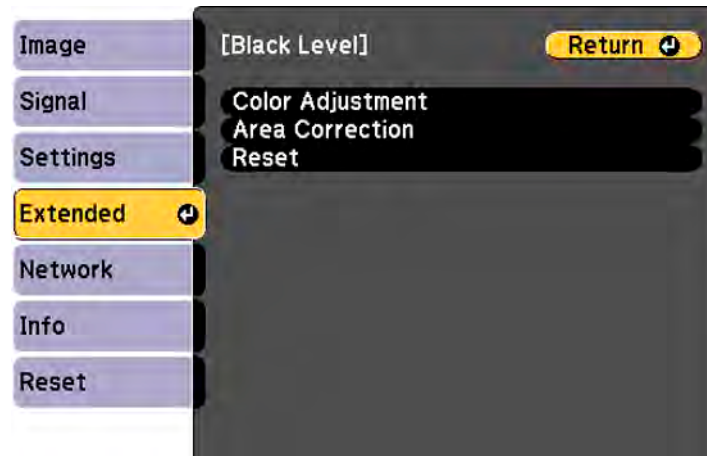

5. Select the **Color Adjustment** setting and press **Enter**.

You see a screen based on the **Top Edge**, **Bottom Edge**, **Right Edge**, and **Left Edge** settings you selected for the **Edge Blending** setting.

**Note:** The **Color Adjustment** setting is automatically adjusted when selecting **Start Auto Adjustment** in the Screen Matching screen.

6. Select the area you want to adjust and press **Enter**.

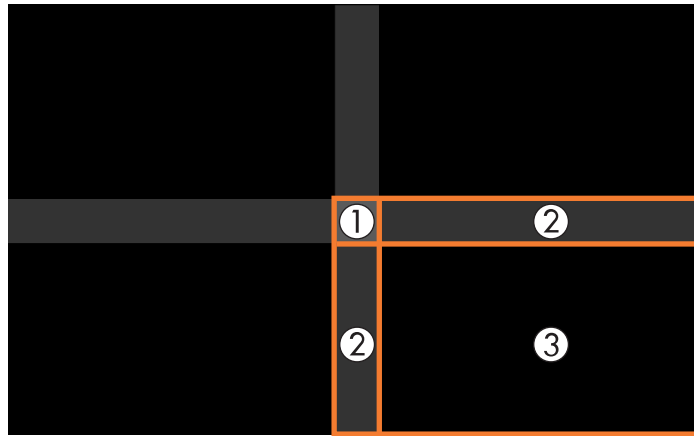

**Note:** The area you selected is displayed in orange. Adjust overlapping areas starting with the brightest areas first. For example, adjust area 2 to match area 1, then adjust area 3 to match area 2.

7. Adjust the brightness and tone of the areas that do not overlap to match the areas that overlap using the displayed adjustment sliders.



8. Repeat the previous two steps as needed until all areas match.
9. If the tone of some areas do not match, you can adjust them using the **Area Correction** setting. Continue with the next step. Otherwise, press the **Menu** button to exit.
10. Press the **Esc** button to return to the Black Level screen.
11. Select the **Area Correction** setting and press **Enter**.
12. Select the **Start Adjustments** setting and press **Enter**.

You see a screen with boundary lines indicating areas that are overlapping. The boundary lines are based on the **Top Edge**, **Bottom Edge**, **Right Edge**, and **Left Edge** settings you selected for the **Edge Blending** setting.

13. Use the arrow buttons to select a boundary line and press **Enter**.

You see a screen like this displaying the points you can use to set the adjustment range:

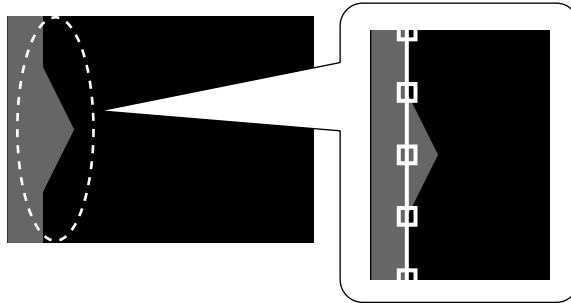

14. Use the arrow buttons to adjust the boundary line position and press the **Enter** button.

15. Use the arrow buttons to select an adjustment point and press the **Enter** button.

The selected point turns orange.

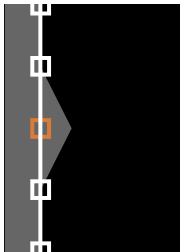

16. Use the arrow buttons to move the point.

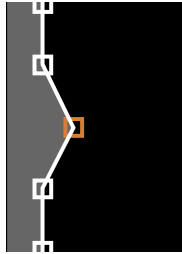

17. To move another point, press the **Esc** button and repeat the previous two steps.

18. To move another boundary line, press the **Esc** button repeatedly until you can select a boundary line.

19. When you are finished, press the **Menu** button.

**Note:** Changing the **Top Edge**, **Bottom Edge**, **Right Edge**, or **Left Edge** settings resets the **Black Level** setting to its default value.

**Parent topic:** [Using Multiple Projectors](#)

**Related references**

[Projector Setup Settings - Extended Menu](#)

## Matching Tint and Brightness (Screen Matching)

You can adjust the tint and brightness of multiple projectors so they match better. You can also schedule automatic adjustments to the tint and brightness.

**Note:** Wait 20 minutes after turning on the projector before using the Screen Matching feature and darken the room for maximum accuracy. Brightness decreases over time, so you may need to perform Screen Matching again to correct large differences in brightness.

[Matching the Screens Automatically](#)

[Matching the Screens Manually](#)

**Parent topic:** [Using Multiple Projectors](#)

## Related tasks

[Saving a Scheduled Event](#)

### Matching the Screens Automatically

You can automatically correct the brightness and tint for multiple projectors based on the brightness and tint settings you selected for the master projector.

Before you start, make sure of the following:

- Select **Multi-Projection** for the **Color Mode** setting and adjust the **Brightness, Contrast, Color Saturation, Tint, White Balance**, and **Advanced** settings in the Image menu, as necessary, on the master projector.
- You are projecting on a matte white diffusion screen that is flat and even.
- The projected image is between 100 to 300 inches (254 to 762 cm) and is rectangular after tiling.
- All the projectors are connected to a network and the **Location Setup** setting has been configured.
- Nothing is blocking the built-in camera on the front of each projector.
- The projected images do not overlap or have gaps between them.
- The projectors are installed parallel to the screen.
- The Blend Range setting is set between 15 to 45%.

**Note:** Auto adjustment is not available for the following lenses: ELPLR04, ELPLL08, or ELPLL07. After auto adjustment, the movement range for lens shift is reduced.

1. Press the **Menu** button.
2. Select the **Extended** menu and press **Enter**.
3. Select the **Multi-Projection** setting and press **Enter**.
4. Select the **Screen Matching** setting and press **Enter**.



5. Select **Start Auto Adjustment** press **Enter**.

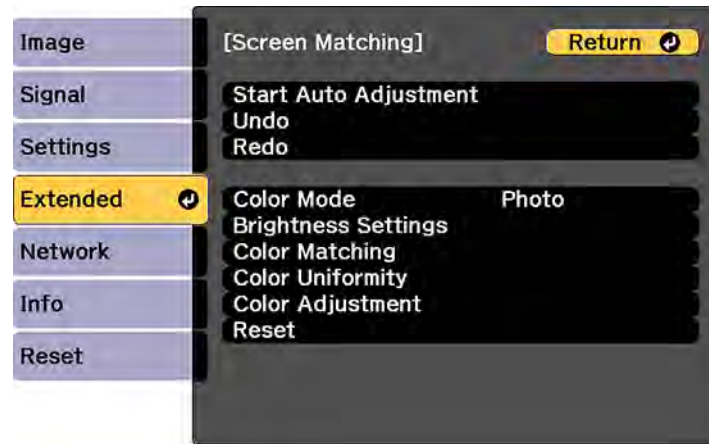

When adjustment starts, you see an adjustment pattern. Adjustment is complete when you see a displayed image.

After automatic adjustment, the **Color Uniformity** and **Color Matching** settings are returned to their default values.

**Parent topic:** [Matching Tint and Brightness \(Screen Matching\)](#)

#### **Related concepts**

[Color Mode](#)

#### **Related references**

[Image Quality Settings - Image Menu](#)

[Projector Parts - Front/Top](#)

#### **Related tasks**

[Multiple Projector Adjustment Overview](#)

[Configuring Tiling Automatically](#)

### **Matching the Screens Manually**

You can manually correct the brightness and tint for multiple projectors.

1. Press the **Menu** button.
2. Select the **Extended** menu and press **Enter**.

3. Select the **Multi-Projection** setting and press **Enter**.
4. Select the **Screen Matching** setting and press **Enter**.

You see this screen:

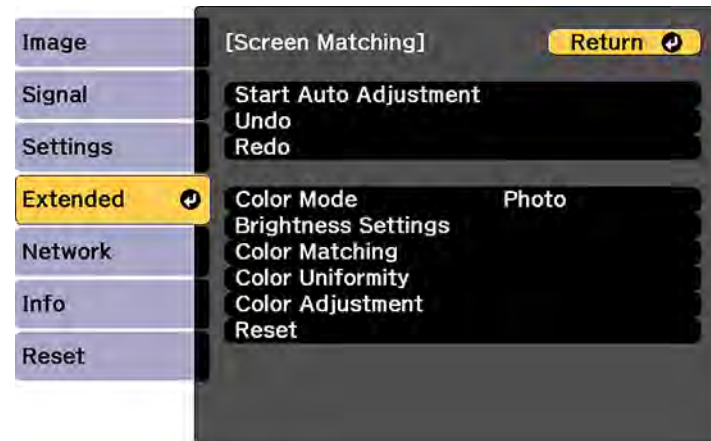

5. Select the **Color Matching** setting and press **Enter**.

You see this screen:



6. Press the left or right arrow buttons to select a value for the **Adjustment Level** setting.

**Note:** There are eight adjustment levels ranging from white to black and you can adjust each level individually.

7. Press the left or right arrow buttons to adjust the color tone for the **Red**, **Green**, and **Blue** settings.
8. Press the left or right arrow buttons to adjust the **Brightness** setting.

9. Repeat the previous three steps as necessary to adjust each adjustment level.

**Parent topic:** [Matching Tint and Brightness \(Screen Matching\)](#)

## Scaling an Image

You can project the same image from multiple projectors and use the Scale feature to crop and combine them into one large image.

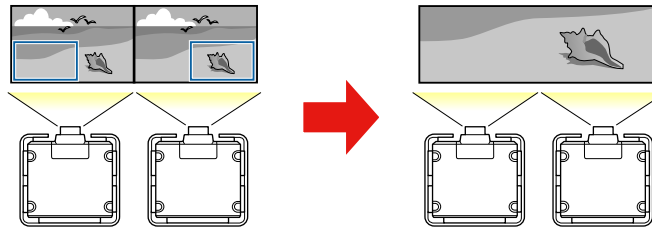

1. Press the **Menu** button.
2. Select the **Extended** menu and press **Enter**.
3. Select the **Multi-Projection** setting and press **Enter**.
4. Select the **Scale** setting and press **Enter**.

You see this screen:



5. Select one of the following as the **Scale** setting:
  - **Auto** to automatically adjust the clipped areas according to the **Edge Blending** and **Tiling** settings you selected

- **Manual** to adjust the clipped areas manually
6. Select the **Scale Mode** setting and select one of these options:
    - **Zoom Display** to maintain the image aspect ratio as you scale the image
    - **Full Display** to adjust the image to the projector's screen size as you scale the image
  7. If you selected **Auto** as the Scale setting, you can skip the remaining steps. If you selected **Manual**, adjust each of the following options as necessary:
    - – or + to scale the image horizontally and vertically at the same time
    - **Scale Vertically** to scale the image vertically only
    - **Scale Horizontally** to scale the image horizontally only
  8. Select the **Clip Adjustment** setting and use the arrow buttons to adjust the coordinates and size of each image as you view the screen.
  9. When you are finished, press the **Menu** button.

**Parent topic:** [Using Multiple Projectors](#)

## Enabling Protocol Emulation

You can use protocol emulation to control your projector with the same RS-232 control codes as those used by the manufacturers of other projectors. This lets you control a group of projectors from a common controller.

1. Make sure the projector is turned on.
2. Connect a controller to the RS-232C port on the projector.
3. Do one of the following:
  - Press and hold the **Test Pattern** button on the remote control for at least five seconds.
  - Select the **Extended** menu, highlight the **Standby Mode** setting, and hold down the right arrow button on the remote control or projector control panel for at least five seconds.

You see the Protocol Emulation screen.

4. Select one of the following and press **Enter**:
  - **Type P** for Panasonic projectors
  - **Type M** for Mitsubishi projectors
  - **Type N** for NEC projectors
  - **Type S** for Sony projectors

5. Turn the projector off and on again to enable the control code you selected.

**Parent topic:** [Adjusting Projector Features](#)

## Saving Settings to Memory and Using Saved Settings

You can save customized settings and then select the saved settings whenever you want to use them.

1. Turn on the projector and display an image.
2. Press the **Menu** button.
3. Select the **Settings** menu and press **Enter**.

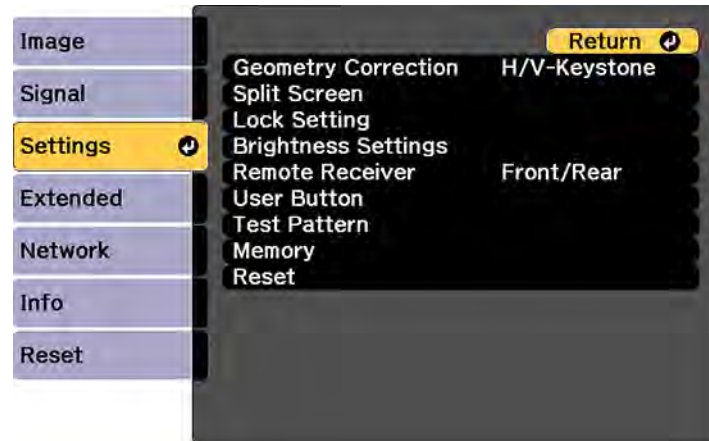

4. Select the **Memory** setting and press **Enter**.

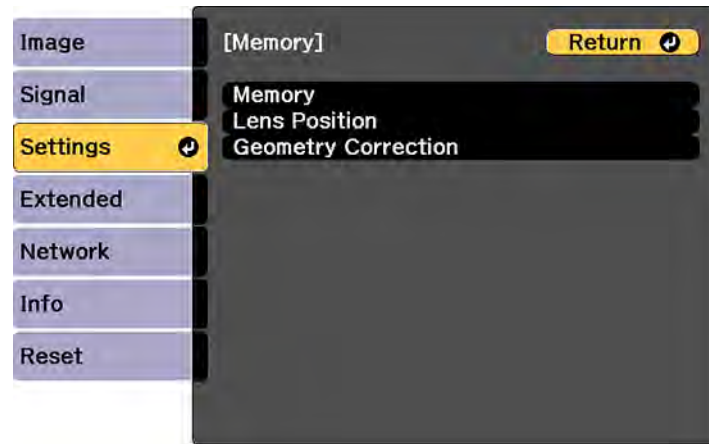

**Note:** You can also access this screen by pressing the **Memory** button on the remote control.

5. Select one of the following options:

- **Memory:** Saves or loads various settings; you can save up to 10 different memories

**Note:** The following settings are saved: all settings from the Image menu, the **Scale** setting from the Signal menu, the **Brightness Settings** from the Settings menu, and the **Edge Blending**, **Black Level**, and **Color Matching** settings from the Extended menu.

- **Lens Position:** Saves or loads settings related to the lens such as the lens shift, focus, zoom, and distortion adjustment settings; you can save up to 10 different memories
- **Geometry Correction:** Saves or loads any adjustments made in the **Geometry Correction** setting in the Settings menu; you can save up to 3 different memories

You see this screen:

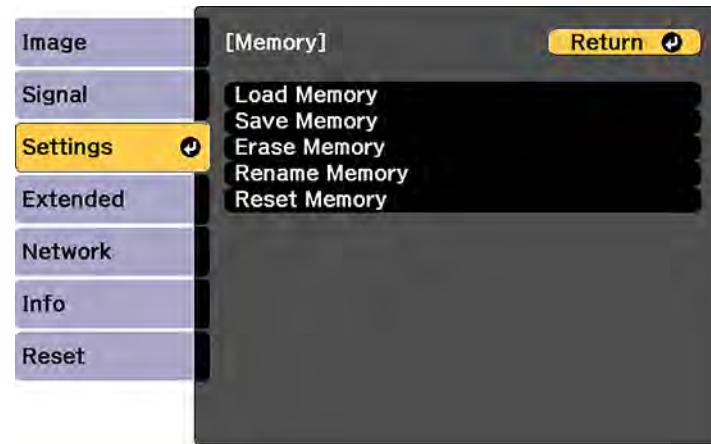

6. Select one of the following options:

- **Load Memory:** Overwrites your current settings with saved settings
- **Save Memory:** Saves your current settings to memory

**Note:** A memory name that has already been used is indicated by a blue mark. Saving over a previously saved memory overwrites the settings with your current settings.

- **Erase Memory:** Erases the selected memory settings
- **Rename Memory:** Renames a saved memory
- **Reset Memory:** Resets the name and settings of a saved memory

**Note:** To reset all saved memories of all types, select **Reset All Memories** in the Reset menu.

7. Press **Menu** or **Esc** to exit.

Parent topic: [Adjusting Projector Features](#)

## Saving a Scheduled Event

You can select projector commands you want to perform and schedule them as an event.

You cannot schedule an event to occur at the following times:

- Five minutes before or after a Color Calibration event
- Five minutes before or 30 minutes after a Screen Matching event

**Note:** Light Source Calibration events do not start if the projector is used continuously for more than 24 hours, or regularly turned off by shutting off the power outlet. Set **Light Source Calibration** events to occur only after 100 hours of projector usage.

1. Press the **Menu** button.
2. Select the **Extended** menu and press **Enter**.
3. Select the **Schedule Settings** setting and press **Enter**.  
The Schedule Settings screen appears.
4. Select the **Schedule** menu and press **Enter**.
5. Select **Add New** and press **Enter**.
6. In the Event Settings section, select the events you want to have occur. (Select **No Change** for events that you do not want to occur.)
7. In the Date/Time Settings section, set the date and time for the scheduled events to occur.
8. When you are finished, select **Save** and press **Enter**.
9. To schedule more events, repeat the previous steps as necessary.
10. Select **Setup complete** and select **Yes** to save your changes.

[Viewing Scheduled Events](#)

[Editing a Scheduled Event](#)

**Parent topic:** [Adjusting Projector Features](#)

## Viewing Scheduled Events

You can view any currently scheduled events.

1. Press the **Menu** button.
2. Select the **Extended** menu and press **Enter**.
3. Select the **Schedule Settings** setting and press **Enter**.



You see a screen like this:

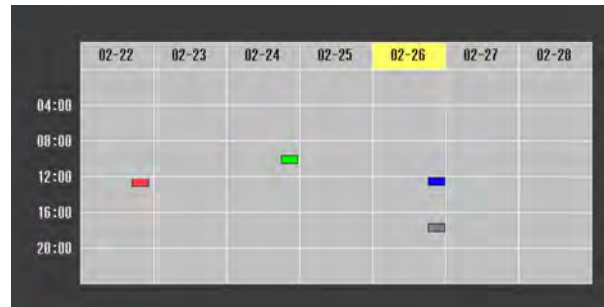

The colored boxes in the calendar indicate the following about the scheduled events:

- One-time event
- Reoccurring event
- Communication is on/off
- Event is invalid

**Parent topic:** [Saving a Scheduled Event](#)

## Editing a Scheduled Event

You can edit any currently scheduled event.

1. Press the **Menu** button.
2. Select the **Extended** menu and press **Enter**.
3. Select the **Schedule Settings** setting and press **Enter**.

You see a screen like this:

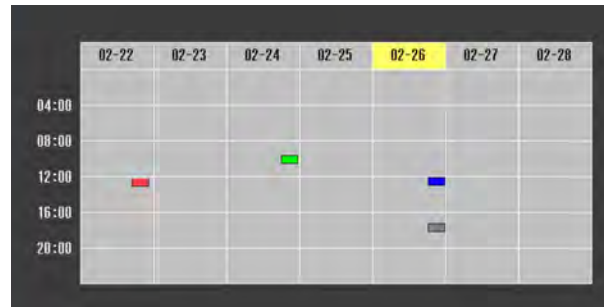

4. Press the left or right arrow buttons to highlight the date on the calendar containing the scheduled event you want to edit.
5. Press the up or down arrow buttons to highlight the event you want to edit, and press **Esc**.
6. Select one of the following:
  - **On/Disabled**: Enable or disable the selected event.
  - **Edit**: Edit the settings for the selected event.
  - **Clear**: Delete the selected event.
  - **Add New**: Add a new scheduled event.
7. When you are finished, select **Return** and press **Enter**.
8. Select **Setup complete** and select **Yes** to save your changes.

**Note:** To delete all scheduled events, select **Schedule Reset** and select **Yes**.

**Parent topic:** [Saving a Scheduled Event](#)

## Copying Menu Settings Between Projectors

After you select menu settings for your projector, you can transfer them to another projector of the same model.

**Note:** Copy the projector's settings before you adjust the projected image using the projector's Geometry Correction settings. Any saved User's Logo setting on the projector will transfer to the other projector.

**Caution:** If the copy process fails due to a power failure, communication error, or for any other reason, Epson will not be responsible for any repair costs incurred.

The following settings will not transfer between projectors:

- Info menu items
- Network menu settings other than those in the Notifications and Others menus

**Note:** In addition to the methods covered this section, you can also copy and transfer settings to multiple projectors over a network using the EasyMP Network Updater software. See the *EasyMP Network Updater Operation Guide* for instructions. You can download the latest software and documentation from the Epson web site.

[Saving Settings to a USB Flash Drive](#)

[Transferring Settings From a USB Flash Drive](#)

[Saving Settings to a Computer](#)

[Transferring Settings From a Computer](#)

**Parent topic:** [Adjusting Projector Features](#)

**Related references**

[Projector Information Display - Info Menu](#)

[Projector Network Settings - Network Menu](#)

[Additional Projector Software and Manuals](#)

## **Saving Settings to a USB Flash Drive**

You can save the projector settings you want to transfer to a USB flash drive.

**Note:** Use an empty flash drive. If the drive contains other files, the transfer may not complete correctly.

1. Turn off the projector using the power switch.

2. Insert the flash drive into the wireless LAN module port.

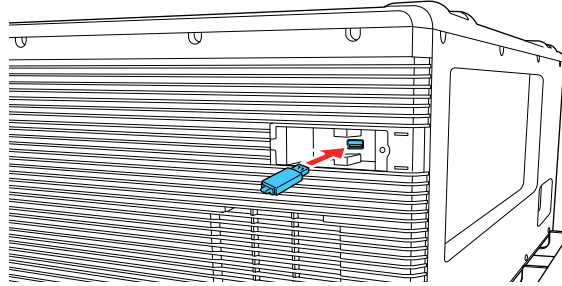

**Note:** Connect the flash drive directly to the projector. Do not use a hub or your settings may not be saved correctly.

3. Press and hold the **Esc** button on the control panel or remote control as you turn on the power switch.

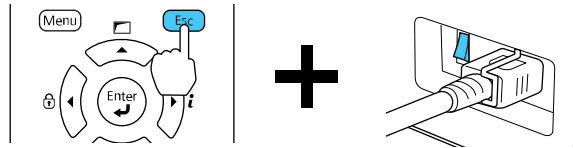

4. When the On/Standby and Status lights are blue, and the Laser and Temp lights are orange, release the **Esc** button.

The lights flash to indicate that settings are transferring to the flash drive. When the lights stop flashing, the On/Standby light turns blue and the projector enters standby mode.

**Caution:** Do not unplug the power cord, turn off the power switch, or remove the flash drive while the lights are flashing. This could damage the projector.

5. Once the projector enters standby mode, remove the flash drive.

**Parent topic:** [Copying Menu Settings Between Projectors](#)

## Transferring Settings From a USB Flash Drive

After saving projector settings to a USB flash drive, you can transfer them to another projector of the same model.

**Note:** Make sure the USB flash drive contains only a single settings transfer from another projector of the same model. The settings are contained in a file called **pjconfdata.bin**. If the drive contains other files, the transfer may not complete correctly.

Do not adjust image settings on a projector until after you transfer settings to it. Otherwise, you may have to repeat your adjustments.

1. Turn off the projector using the power switch.
2. Insert the flash drive into the wireless LAN module port.

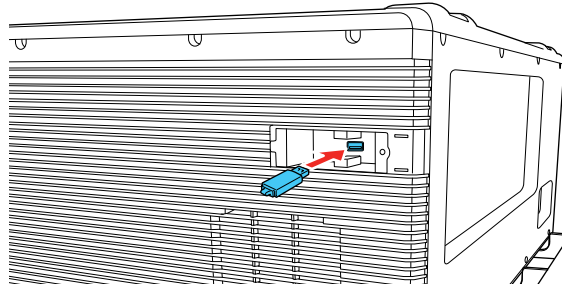

**Note:** Connect the flash drive directly to the projector. Do not use a hub or your settings may not be saved correctly.

3. Press and hold the **Menu** button on the control panel or remote control as you turn on the power switch.



4. When the On/Standby and Status lights are blue, and the Laser and Temp lights are orange, release the **Menu** button.

The lights flash to indicate that settings are transferring to the projector. When the lights stop flashing, the On/Standby light turns blue and the projector enters standby mode.

**Caution:** Do not unplug the power cord, turn off the power switch, or remove the flash drive while the lights are flashing. This could damage the projector.

5. Once the projector enters standby mode, remove the flash drive.

**Parent topic:** [Copying Menu Settings Between Projectors](#)

## **Saving Settings to a Computer**

You can save the projector settings you want to transfer to a computer.

Your computer must be running one of the following operating systems:

- Windows Vista
- Windows 7
- Windows 8.x
- Windows 10
- OS X 10.5.8
- OS X 10.6.x
- OS X 10.7.x
- OS X 10.8.x
- OS X 10.9.x
- OS X 10.10.x
- OS X 10.11.x

1. Turn off the projector using the power switch.

2. Connect a USB cable to your projector's **Service** port.

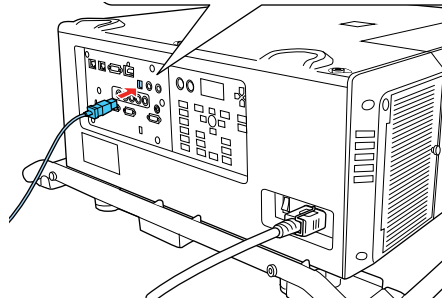

3. Connect the other end to any available USB port on your computer.
4. Press and hold the **Esc** button on the control panel or remote control as you turn on the power switch.

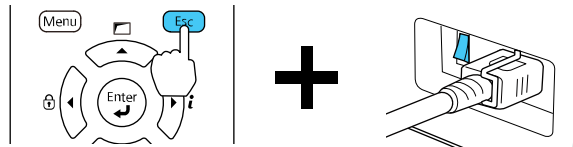

5. When the On/Standby and Status lights are blue, and the Laser and Temp lights are orange, release the **Esc** button.

The projector shows up as a removable disk on your computer.

6. Open the removable disk and copy the **pjconfdata.bin** file to your computer.
7. Once the file has copied, do one of the following:
  - **Windows:** Open the **My Computer**, **Computer**, or **Windows Explorer** utility. Right-click the name of your projector (listed as a removable disk) and select **Eject**.
  - **Mac:** Drag the removable disk icon for your projector from the desktop into the trash.

The projector enters standby mode.

**Parent topic:** [Copying Menu Settings Between Projectors](#)

## Transferring Settings From a Computer

After saving projector settings to a computer, you can transfer them to another projector of the same model.

Your computer must be running one of the following operating systems:

- Windows Vista
- Windows 7
- Windows 8.x
- Windows 10
- OS X 10.5.8
- OS X 10.6.x
- OS X 10.7.x
- OS X 10.8.x
- OS X 10.9.x
- OS X 10.10.x
- OS X 10.11.x

Do not adjust image settings on a projector until after you transfer settings to it. Otherwise, you may have to repeat your adjustments.

1. Turn off the projector using the power switch.
2. Connect a USB cable to your projector's **Service** port.

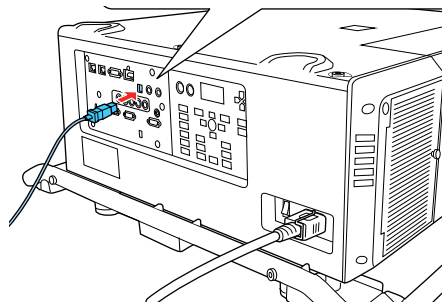



3. Connect the other end to any available USB port on your computer.
4. Press and hold the **Menu** button on the control panel or remote control as you turn on the power switch.



5. When the On/Standby and Status lights are blue, and the Laser and Temp lights are orange, release the **Menu** button.  
The projector shows up as a removable disk on your computer.
6. Copy the **pjconfdata.bin** file from your computer to the removable disk.

**Note:** Do not copy any other files to the removable disk.

7. Once the file has copied, do one of the following:
  - **Windows:** Open the **My Computer**, **Computer**, or **Windows Explorer** utility. Right-click the name of your projector (listed as a removable disk) and select **Eject**.
  - **Mac:** Drag the removable disk icon for your projector from the desktop into the trash.

All the lights start flashing to indicate that the projector's settings are being updated. When the lights stop flashing, the On/Standby light turns blue and the projector enters standby mode.

**Caution:** Do not turn off the power switch or unplug the power cord while the lights are flashing. This could damage the projector.

**Parent topic:** [Copying Menu Settings Between Projectors](#)

---

# Adjusting the Menu Settings

Follow the instructions in these sections to access the projector menu system and change projector settings.

[Using the Projector's Menus](#)

[Image Quality Settings - Image Menu](#)

[Input Signal Settings - Signal Menu](#)

[Projector Feature Settings - Settings Menu](#)

[Projector Setup Settings - Extended Menu](#)

[Projector Network Settings - Network Menu](#)

[Projector Information Display - Info Menu](#)

[Projector Reset Options - Reset Menu](#)

## Using the Projector's Menus

You can use the projector's menus to adjust the settings that control how your projector works. The projector displays the menus on the screen.

1. Press the **Menu** button on the control panel or remote control.

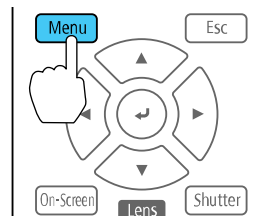
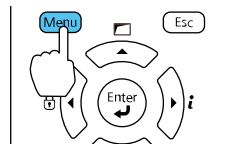

You see the menu screen displaying the Image menu settings.

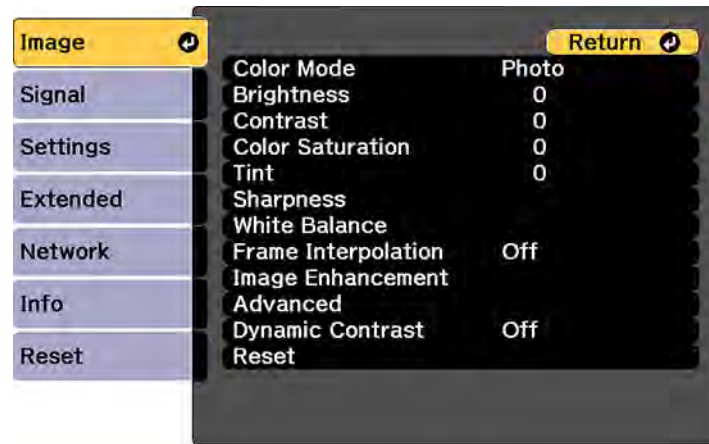

2. Press the up or down arrow button to move through the menus listed on the left. The settings for each menu are displayed on the right.

**Note:** The available settings depend on the current input source.

3. To change settings in the displayed menu, press **Enter**.
4. Press the up or down arrow button to move through the settings.
5. Change the settings using the buttons listed on the bottom of the menu screens.
6. To return all the menu settings to their default values, select **Reset**.
7. When you finish changing settings on a menu, press **Esc**.
8. Press **Menu** or **Esc** to exit the menus.

**Parent topic:** [Adjusting the Menu Settings](#)

## Image Quality Settings - Image Menu

Settings on the Image menu let you adjust the quality of your image for the input source you are currently using. The available settings depend on the currently selected input source.

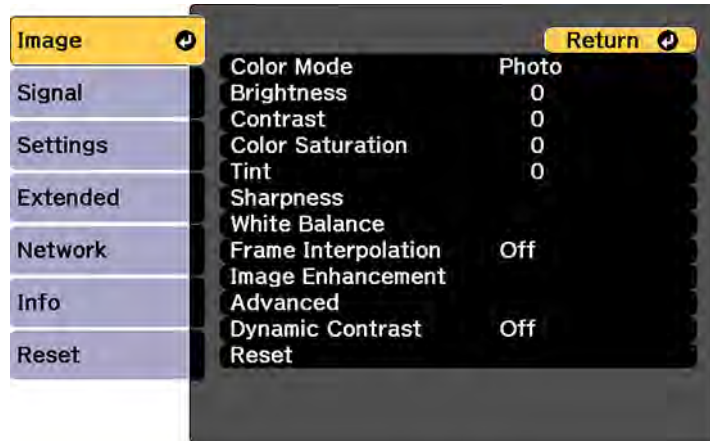

To change settings for an input source, make sure the source is connected and select that source.

Setting	Options	Description
<b>Color Mode</b>	See the list of available Color Modes	Adjusts the vividness of image colors for various image types and environments
<b>Brightness</b>	Varying levels available	Lightens or darkens the overall image
<b>Contrast</b>	Varying levels available	Adjusts the difference between light and dark areas of the image
<b>Color Saturation</b>	Varying levels available	Adjusts the intensity of the image colors
<b>Tint</b>	Varying levels available	Adjusts the balance of green to magenta tones in the image

Setting	Options	Description
<b>Sharpness</b>	<b>Standard</b> <b>Thin Line Enhancement</b> <b>Thick Line Enhancement</b>	Adjusts the sharpness of image details <b>Standard:</b> adjusts the overall image sharpness <b>Thin Line Enhancement:</b> enhances fine details such as hair and fabric patterns <b>Thick Line Enhancement:</b> enhances the outline, background, and main parts of an image to make them more clear
<b>White Balance</b>	<b>Color Temp.</b> <b>G-M Correction</b> <b>Customized</b>	Adjusts the overall tint of the image <b>Color Temp.:</b> sets the color tone based on color temperature <b>G-M Correction:</b> higher values tint the image blue and lower values tint the image red <b>Customized:</b> lets you adjust the offset and gain of each color R (red), G (green), and B (blue) individually
<b>Frame Interpolation</b>	<b>Off</b> <b>Low</b> <b>Normal</b> <b>High</b>	Smooths fast moving video by comparing consecutive frames and inserting an intermediate frame between them

Setting	Options	Description
Image Enhancement	4K Enhancement	Accepts 4K signals and enhances the output of 1080p signals
	Image Preset Mode	Selects the image enhancement settings saved in advance
	Noise Reduction	Reduces flickering in analog images
	MPEG Noise Reduction	Reduces the noise or artifacts seen in MPEG video
	Super resolution	Sharpens blurred images resulting from increasing resolution
	Detail enhancement	Enhances details to create clear outlines <b>Range:</b> higher settings increase the affected area around the outline <b>Strength:</b> higher settings create a stronger effect
Advanced	Gamma	Adjusts the gamma levels of the image. Select <b>Customized</b> to adjust the gamma while viewing the image or a graph.
	RGBCMY	Adjusts the hue, saturation, and brightness for each color
	Deinterlacing	Sets whether to convert interlaced-to-progressive signals for certain video image types <b>Off:</b> for fast-moving video images <b>Video:</b> for most video images <b>Film/Auto:</b> for movies, computer graphics, and animation

Setting	Options	Description
<b>Dynamic Contrast</b>	<b>Off</b> <b>Normal</b> <b>High Speed</b>	Adjusts the luminance of the image to improve contrast by tracking changes in image brightness  <b>Normal:</b> for standard brightness adjustment  <b>High Speed:</b> to adjust brightness as soon as the scene changes

**Note:** The **Brightness** setting does not affect laser brightness. To change the laser brightness, use the **Brightness Settings** in the Settings menu.

Parent topic: [Adjusting the Menu Settings](#)

Related references

[Available Color Modes](#)

## Input Signal Settings - Signal Menu

Normally the projector detects and optimizes the input signal settings automatically. If you need to customize the settings, you can use the Signal menu. The available settings depend on the currently selected input source.

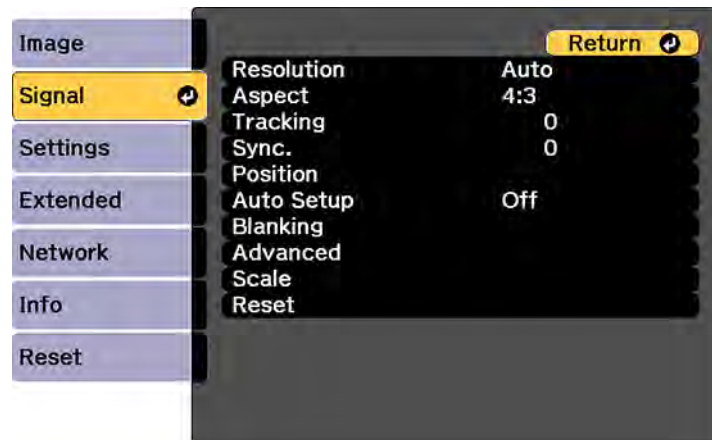

**Note:** You can restore the default settings of the **Position**, **Tracking**, and **Sync** settings by pressing the **Auto** button on the remote control.

To change settings for an input source, make sure the source is connected and select that source.

Setting	Options	Description
<b>Resolution</b>	<b>Auto</b> <b>Normal</b> <b>Wide</b> <b>Manual</b>	Sets the input signal resolution from an analog RGB computer connection <b>Auto:</b> detects the resolution automatically <b>Normal:</b> for 4:3 or 5:4 screens <b>Wide:</b> for widescreen <b>Manual:</b> lets you specify a resolution
<b>Aspect</b>	See the list of available aspect ratios	Sets the aspect ratio (width-to-height ratio) for the selected input source
<b>Tracking</b>	Varying levels available	Adjusts signal to eliminate vertical stripes in images from an analog RGB computer connection
<b>Sync.</b>	Varying levels available	Adjusts signal to eliminate fuzziness or flickering in images from an analog RGB computer connection
<b>Position</b>	Up, down, left, right	Adjusts the image location on the screen
<b>Auto Setup</b>	<b>On</b> <b>Off</b>	Automatically optimizes image quality from an analog RGB computer connection (when On)



Setting	Options	Description
<b>Blanking</b>	<b>Top</b> <b>Bottom</b> <b>Left</b> <b>Right</b>	Hides an area of the projected image that you select using the arrow buttons
<b>Advanced</b>	<b>Video Range</b>	Sets the video range to match the setting of the device connected to the <b>HDMI</b> , <b>DVI-D</b> , <b>HDBaseT</b> , or <b>SDI</b> input ports
	<b>Input Signal</b>	Specifies the signal type from input sources connected to computer ports <b>Auto</b> : detects signals automatically <b>RGB</b> : corrects color for computer/RGB video inputs <b>Component</b> : corrects color for component video inputs
	<b>Image Processing</b>	Adjusts how images are processed <b>Fast 1</b> or <b>Fast 2</b> : to display images quicker; Fast 2 is quicker than Fast 1 <b>Fine</b> : to display images in higher quality
<b>Scale</b>	Various scale options	When using multiple projectors to project one image, adjusts the scale of the image displayed by each projector

Parent topic: [Adjusting the Menu Settings](#)

**Related references**

[Available Image Aspect Ratios](#)

## Projector Feature Settings - Settings Menu

Options on the Settings menu let you customize various projector features.

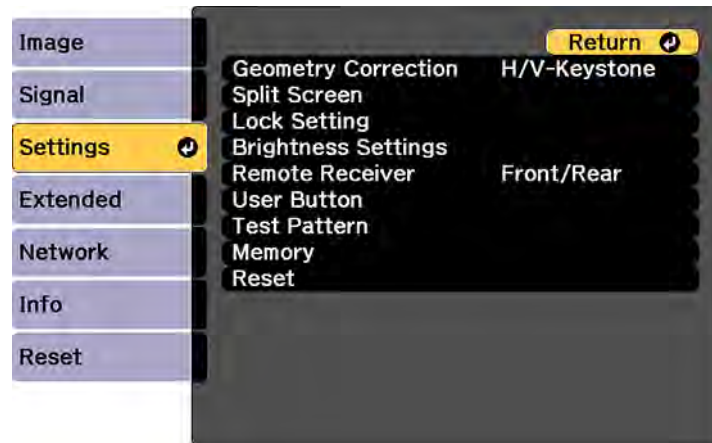

Setting	Options	Description
<b>Geometry Correction</b>	<b>H/V-Keystone</b> <b>Quick Corner</b> <b>Curved Surface</b> <b>Corner Wall</b> <b>Point Correction</b> <b>Memory</b>	Adjusts the projected image shape  <b>H/V Keystone:</b> lets you manually correct the angles of the horizontal and vertical sides  <b>Quick Corner:</b> select to adjust the position of the four corners  <b>Curved Surface:</b> select to adjust the image when projecting on a curved surface  <b>Corner Wall:</b> select to adjust the image when projecting on a surface with a right angle  <b>Point Correction:</b> select to display a grid and finely adjust the image position  <b>Memory:</b> select to save adjustment value of the geometric correction and load it when needed
<b>Split Screen</b>	—	Divides the viewing area horizontally and displays two images side-by-side
<b>Lock Setting</b>	<b>Control Panel Lock</b> <b>Lens Lock</b>	Controls projector button locking to secure the projector  <b>Control Panel Lock:</b> <ul style="list-style-type: none"> <li>• <b>Full Lock:</b> locks all buttons</li> <li>• <b>Partial Lock:</b> locks all buttons except the power button</li> <li>• <b>Off:</b> no buttons locked</li> </ul> <b>Lens Lock:</b> locks the focus, zoom, and lens shift settings

Setting	Options	Description
<b>Brightness Settings</b>	<b>Light Source Mode</b> <b>Brightness Level</b> <b>Constant Brightness</b> <b>Estimated Remains</b>	Selects the brightness mode of the projector <b>Light Source Mode:</b> sets the brightness for the light source <ul style="list-style-type: none"> <li>• <b>Normal:</b> maximum brightness</li> <li>• <b>Quiet:</b> 70% brightness with reduced fan noise</li> <li>• <b>Extended:</b> 70% brightness and extends the life expectancy of the light source</li> <li>• <b>Custom:</b> select a custom brightness level and enable use of next three settings</li> </ul> <b>Brightness Level:</b> select the <b>Custom</b> brightness level you want <b>Constant Brightness:</b> maintains a constant brightness (cannot change the <b>Light Source Mode</b> and <b>Brightness Level</b> settings) <b>Estimated Remains:</b> displays how long the projector can maintain constant brightness (if that setting is selected)
<b>Remote Receiver</b>	<b>Front/Rear</b> <b>Front</b> <b>Rear</b> <b>Off</b>	Limits reception of remote control signals by the selected receiver; <b>Off</b> turns off all receivers
<b>User Button</b>	<b>User1</b> <b>User2</b> <b>User3</b>	Assigns a menu option to the <b>User1</b> , <b>User2</b> , and <b>User3</b> buttons on the remote control for one-touch access

Setting	Options	Description
Test Pattern	—	Displays a test pattern to assist in adjusting the image
Memory	Load Memory Save Memory Erase Memory Rename Memory	Save customized sets of settings to memory

Parent topic: [Adjusting the Menu Settings](#)

## Projector Setup Settings - Extended Menu

Settings on the Extended menu let you customize various projector setup features that control its operation.

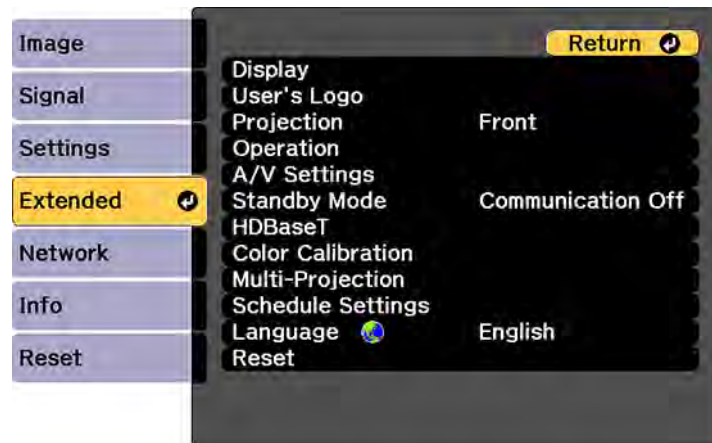

Setting	Options	Description
Display	—	See the <b>Display</b> settings table in this topic
User's Logo	—	Creates a screen that the projector displays to identify itself and enhance security

Setting	Options	Description
Projection	Front Front/Ceiling Rear Rear Ceiling	Selects the way the projector faces the screen so the image is oriented correctly
Operation	—	See the <b>Operation</b> settings table in this topic
A/V Settings	A/V Output Monitor Out	Selects various video output settings  <b>A/V Output:</b> select to output video to an external device when the projector is in standby mode (Standby Mode must be turned on to use this setting)  <b>Monitor Out:</b> select the image source to output to an external device when the projector is in standby mode; when set to <b>Auto</b> , selects output from the <b>Computer</b> or <b>BNC</b> port depending on which was in use when the projector went into standby mode

Setting	Options	Description
<b>Standby Mode</b>	<b>Communication On</b> <b>Communication Off</b>	<p>Enable this setting to allow the following operations to occur when the projector is in standby mode:</p> <ul style="list-style-type: none"> <li>• Monitor and control the projector over a network</li> <li>• Output video to an external device (<b>A/V Output</b> must be set to <b>Always On</b>)</li> <li>• Communication from the <b>HDBaseT</b> port (<b>Control Communications</b> must be set to <b>On</b> in the <b>HDBaseT</b> settings)</li> </ul>
<b>HDBaseT</b>	<b>Control Communications</b> <b>Extron XTP</b>	<p>Selects the communication settings for connections to an HDBaseT transmitter or switcher</p> <p><b>Control Communications:</b> enables or disables communication from the Ethernet and serial ports on the transmitter; turning on this setting disables the projector's <b>LAN</b>, <b>RS-232C</b>, and <b>Remote</b> ports (<b>Extron XTP</b> must be turned off to use this setting)</p> <p><b>Extron XTP:</b> set to <b>On</b> when you connect an Extron XTP transmitter or switcher to the HDBaseT port</p>

Setting	Options	Description
<b>Color Calibration</b>	<b>Start Auto Adjustment</b> <b>Undo</b> <b>Redo</b> <b>Color Uniformity</b>	<p>Automatically detects color deterioration and adjusts the color tone</p> <p><b>Start Auto Adjustment:</b> automatically adjusts the color tone for the whole image</p> <p><b>Undo</b> and <b>Redo:</b> undoes or redoes the auto adjustment</p> <p><b>Color Uniformity:</b> adjusts the color tone balance for the whole image</p>



Setting	Options	Description
<b>Multi-Projection</b>	<b>Projector ID</b> <b>Projector Grouping</b> <b>Tiling</b> <b>Geometry Correction</b> <b>Edge Blending</b> <b>Black Level</b> <b>Scale</b> <b>Screen Matching</b>	Select various options when projecting from multiple projectors  <b>Projector ID:</b> sets the projector to a particular ID number which allows you to use a remote control to individually control projectors  <b>Projector Grouping:</b> lets you select the projectors being used to project one image  <b>Tiling:</b> sets the number of split screens and the position of each image  <b>Geometry Correction:</b> corrects image distortion  <b>Edge Blending:</b> blends the border between multiple images to create a seamless screen  <b>Black Level:</b> adjusts the brightness and tone differences in overlapping images  <b>Scale:</b> adjusts the scale of the images  <b>Screen Matching:</b> adjusts the tint and brightness of the images
<b>Schedule Settings</b>	Various scheduling options	Lets you schedule various projector tasks
<b>Language</b>	Various languages available	Selects the language for projector menu and message displays (not changed by <b>Reset</b> option)

**Display settings**

Setting	Description
<b>Menu Position</b>	Selects the position of the projector menu displayed on the screen
<b>Message Position</b>	Selects the position of messages displayed on the screen
<b>Messages</b>	Controls whether messages are displayed on the screen
<b>Display Background</b>	Selects the screen color or logo to display when no signal is received
<b>Startup Screen</b>	Controls whether a special screen appears when the projector starts up
<b>Standby Confirmation</b>	Displays a confirmation message after pressing the <b>Standby</b> button on the remote control
<b>Air Filter Notice</b>	Displays a message when a clog in the air filter is detected
<b>Screen</b>	Sets the aspect ratio and position of the projected image according to the type of screen being used
<b>Panel Alignment</b>	Corrects color misalignment in the projected image
<b>Color Uniformity</b>	Adjusts the color tone balance
<b>OSD Rotation</b>	Rotates the menu display 90°

#### Operation settings

Setting	Description
<b>Direct Power On</b>	Turns on the projector when you plug it in
<b>Sleep Mode</b>	Automatically places the projector in standby mode after an interval of inactivity
<b>Sleep Mode Timer</b>	Sets the time before the projector automatically turns off (Sleep Mode must be turned on)
<b>High Altitude Mode</b>	Regulates the projector's operating temperature at altitudes above 4921 feet (1500 m)
<b>Startup Source Search</b>	Automatically detects the image signal being input when the projector is turned on
<b>Auto Power On</b>	If <b>Computer</b> or <b>BNC</b> is selected, the projector turns on when it detects an input signal from that port

Setting	Description
<b>Shutter Settings</b>	<p>Adjusts the shutter settings</p> <p><b>Fade-in:</b> sets the number of seconds for a fade-in transition effect when displaying an image</p> <p><b>Fade-out:</b> sets the number of seconds for a fade-out transition effect when hiding an image</p> <p><b>Shutter Timer:</b> turns off the projector automatically after using the shutter and 2 hours of inactivity has passed</p> <p><b>Shutter Release:</b> select <b>Shutter</b> if you want to use only the <b>Shutter</b> button to turn off the shutter, or select <b>Any Button</b> to use any button to turn it off</p>
<b>Advanced</b>	See the next table in this topic
<b>Date &amp; Time</b>	Adjusts the projector's time and date settings
<b>Lens Calibration</b>	Displays information about the lens currently in use

#### Advanced settings

Setting	Description
<b>BNC Sync Termination</b>	Sets the termination for the signal from the <b>BNC</b> port (set to <b>Off</b> unless you need analog termination, such as for switchers)
<b>Beep</b>	Controls the beep that sounds when you turn the projector on or off
<b>Indicators</b>	Select <b>Off</b> to turn off projector lights, except warning lights
<b>Instant Off</b>	Select <b>Enabled</b> to place the projector in standby mode after turning it off, or <b>Disabled</b> to place the projector in standby mode approximately 75 seconds after turning it off
<b>Inv Direction Button</b>	Enable this setting if you installed the projector on a ceiling and want to invert the direction of the arrow buttons on the control panel
<b>HDMI DDC Buffer</b>	If you are projecting using an HDMI extension cable and the image is not displayed correctly, enabling this setting may improve image quality

Setting	Description
<b>DVI-D DDC Buffer</b>	If you are projecting using a DVI extension cable and the image is not displayed correctly, enabling this setting may improve image quality
<b>AC Voltage Monitoring</b>	If you select <b>On</b> for this setting and the projector is turned off by any method other than pressing the power button, a power supply voltage warning message is displayed the next time the projector is turned on

Parent topic: [Adjusting the Menu Settings](#)

## Projector Network Settings - Network Menu

Settings on the Network menu let you view network information and set up the projector for monitoring and control over a network.

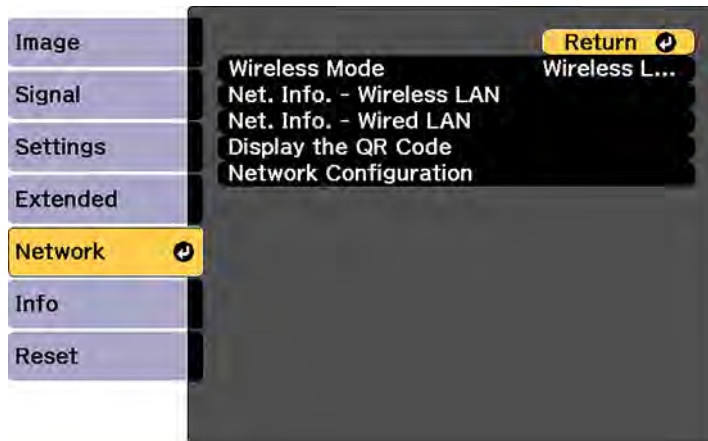

Setting	Options	Description
<b>Wireless Mode</b>	<b>Wireless LAN On</b> <b>Off</b>	Enable or disable wireless communication

<b>Setting</b>	<b>Options</b>	<b>Description</b>
<b>Net. Info - Wireless LAN</b>	<b>Connection mode</b> <b>Wireless LAN Sys.</b> <b>Antenna level</b> <b>Projector Name</b> <b>SSID</b> <b>DHCP</b> <b>IP Address</b> <b>Subnet Mask</b> <b>Gateway Address</b> <b>MAC Address</b> <b>Region Code</b>	Displays wireless network status and details
<b>Net. Info - Wired LAN</b>	<b>Projector Name</b> <b>DHCP</b> <b>IP Address</b> <b>Subnet Mask</b> <b>Gateway Address</b> <b>MAC Address</b>	Displays wired network status and details
<b>Display the QR Code</b>	—	Displays the QR Code
<b>Network Configuration</b>	Accesses additional network menus	Configures your network settings

Parent topic: [Adjusting the Menu Settings](#)

## Projector Information Display - Info Menu

You can display information about the projector and input sources by viewing the Info menu. However, you cannot change any settings in the menu.

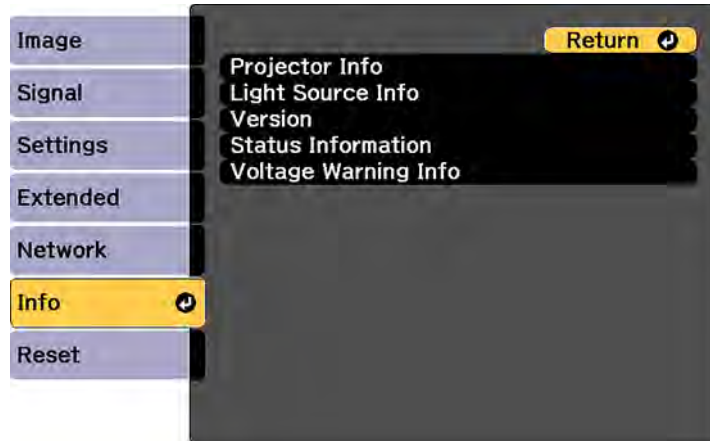

**Note:** The total operating timer does not register any hours until you have used the projector for at least 10 hours. Available settings depend on the current input source.

<b>Setting</b>	<b>Options</b>	<b>Description</b>
<b>Projector Info</b>	<b>Total Op. Time</b>	Displays the number of hours the projector has been used in its operating life
	<b>Operation Hours</b>	Displays the number of hours the projector has been used since it was turned on
	<b>Source</b>	Displays the name of the port to which the current input source is connected
	<b>Input Signal</b>	Displays the input signal setting of the current input source
	<b>Resolution</b>	Displays the resolution of the current input source
	<b>Refresh Rate</b>	Displays the refresh rate of the current input source
	<b>Sync Info</b>	Displays information that may be needed by a service technician
	<b>Status</b>	Displays information about projector problems that may be needed by a service technician
	<b>Serial Number</b>	Displays the projector's serial number
	<b>Lens Type</b>	Displays the model number of the installed lens
	<b>Event ID</b>	Displays the Event ID number corresponding to a specific projector problem; see the list of Event ID codes
	<b>HDBaseT Signal Level</b>	Displays the image signal information from the HDBaseT port

Setting	Options	Description
<b>Light Source Info</b>	<b>Light Source Hours</b>	Displays the number of operating hours for each of the projector's <b>Light Source Mode</b> settings
	<b>Estimated Remains</b>	If the <b>Constant Brightness</b> setting is enabled, displays the remaining number of hours the projector can maintain constant brightness
<b>Version</b>	<b>Main</b> <b>Video2</b> <b>Status Monitor</b>	Displays the projector's firmware information
<b>Status Information</b>	—	Displays basic status information
<b>Voltage Warning Info</b>	—	Displays a power voltage warning

#### [Event ID Code List](#)

Parent topic: [Adjusting the Menu Settings](#)

### Event ID Code List

If the **Event ID** option on the Info menu displays a code number, check this list of Event ID codes for the solution to the projector problem associated with the code.

Event ID code	Cause and solution
0432	Turn the projector off and then on again.
0435	
0434	Unstable network communication. Check the network communication status, wait a few moments, and try connecting to the network again.
0482	
0484	
0485	
0433	Cannot display the transferred images. Restart the network software.
0481	Communication with computer was disconnected. Restart the network software.



Event ID code	Cause and solution
0483 04FE	The network software quit unexpectedly. Check the network communication status, then turn the projector off and then on again.
0479 04FF	A projector system error has occurred. Turn the projector off and then on again.
0891	Cannot find an access point with the same SSID. Set your computer, access point, and projector to the same SSID.
0892	The WPA/WPA2 authentication type does not match. Make sure the wireless network security settings are correct.
0893	The TKIP/AES encryption type does not match. Make sure the wireless network security settings are correct.
0894	Communication with unauthorized access point was disconnected. Contact your network administrator.
0898	Failed to acquire DHCP. Make sure the DHCP server is operating correctly. If you are not using DHCP, turn off the <b>DHCP</b> setting in the Network menus.
0899	Communication error. Turn the projector off and then on again.

Parent topic: [Projector Information Display - Info Menu](#)

## Projector Reset Options - Reset Menu

You can reset most of the projector settings to their default values using the **Reset All Config** option on the Reset menu.

You can also reset the saved names and settings in the Save Memory list using the **Reset All Memories** option.

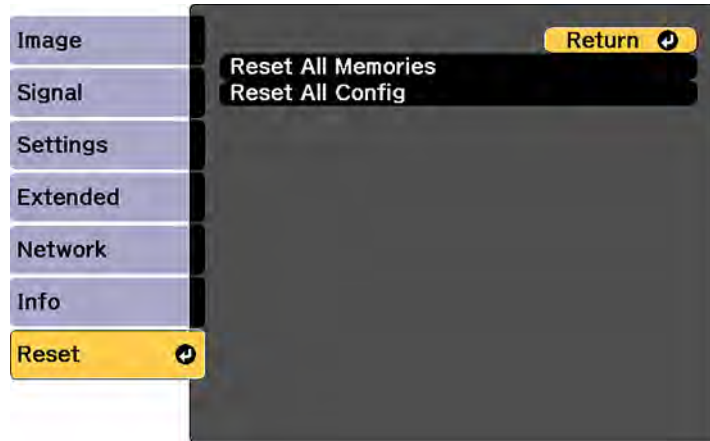

You cannot reset the following settings using the **Reset All Config** option:

- Input Signal
- User's Logo
- Language
- Network menu items
- Date & Time
- Panel Alignment
- Color Uniformity
- Memory
- Color Matching
- Lens Calibration
- Color Calibration
- Projector Grouping
- Screen Matching

**Parent topic:** [Adjusting the Menu Settings](#)

---

# Maintaining and Transporting the Projector

Follow the instructions in these sections to maintain your projector and transport it from place to place.

[Projector Maintenance](#)

[Transporting the Projector](#)

## Projector Maintenance

Your projector needs little maintenance to keep working at its best.

You may need to clean the lens periodically, and clean the air filter and air vents to prevent the projector from overheating due to blocked ventilation.

The only parts you should replace are the air filter and remote control batteries. If any other part needs replacing, contact Epson or an authorized Epson servicer.

This projector uses a sealed laser light source which does not need servicing and cannot be replaced.

**Warning:** Before cleaning any part of the projector, turn it off and unplug the power cord. Never open any cover on the projector, except as specifically explained in this manual. Dangerous electrical voltages in the projector can injure you severely.

**Warning:** Do not try to service this product yourself, except as specifically explained in this manual. Refer all other servicing to qualified servicers.

[Cleaning the Lens](#)

[Cleaning the Projector Case](#)

[Air Filter and Vent Maintenance](#)

[Replacing the Remote Control Batteries](#)

**Parent topic:** [Maintaining and Transporting the Projector](#)

## Cleaning the Lens

Clean the projector's lens periodically, or whenever you notice dust or smudges on the surface.

- To remove dust or smudges, gently wipe the lens with lens-cleaning paper.

- To remove stubborn smudges, moisten a soft, lint-free cloth with lens cleaner and gently wipe the lens. Do not spray any liquid directly on the lens.

**Warning:** Do not use a lens cleaner that contains flammable gas. The high heat generated by the projector may cause a fire.

**Caution:** Do not use glass cleaner or any harsh materials to clean the lens and do not subject the lens to any impacts; you may damage it. Do not use canned air, or the gases may leave a residue. Avoid touching the lens with your bare hands to prevent fingerprints on or damage to the lens surface.

**Parent topic:** [Projector Maintenance](#)

## Cleaning the Projector Case

Before cleaning the projector case, turn off the projector and unplug the power cord.

- To remove dust or dirt, use a soft, dry, lint-free cloth.
- To remove stubborn dirt, use a soft cloth moistened with water and mild soap. Do not spray liquid directly on the projector.

**Caution:** Do not use wax, alcohol, benzene, paint thinner, or other chemicals to clean the projector case. These can damage the case. Do not use canned air, or the gases may leave a residue.

**Parent topic:** [Projector Maintenance](#)

## Air Filter and Vent Maintenance

Regular filter maintenance is important to maintaining your projector. Your Epson projector is designed with an easily accessible, user-replaceable filter to protect your projector and make regular maintenance simple. Filter maintenance intervals will depend on the environment.

If regular maintenance is not performed, your Epson projector will notify you when the temperature inside the projector has reached a high level. Do not wait until this warning appears to maintain your projector filter as prolonged exposure to high temperatures may reduce the life of your projector or laser.

Damage due to the failure to properly maintain the projector or its filter may not be covered by the projector's Limited Warranty.

[Cleaning the Air Filters](#)

[Replacing the Air Filters](#)

**Parent topic:** [Projector Maintenance](#)

## Related references

[Projector Light Status](#)

### Cleaning the Air Filters

You need to clean the projector's air filters in the following situations:

- The filter or vents get dusty.
- You see a message telling you to clean it.
- The projector's Filter light flashes orange.

**Note:** The projector has one air filter on the front and two on the sides. The illustrations here show cleaning the air filter on the front, but the steps are the same to clean the filters on the side.

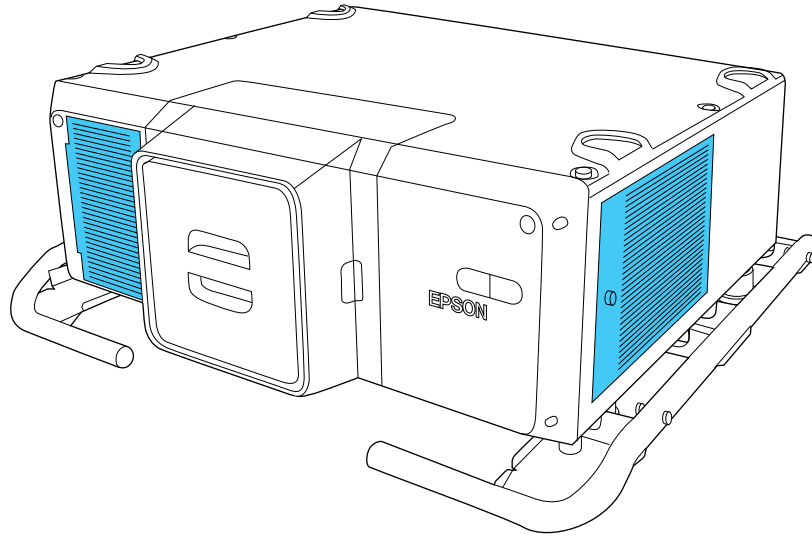

1. Turn off the projector, wait for the projector to beep, and unplug the power cord.

2. Loosen the screw securing the air filter cover.

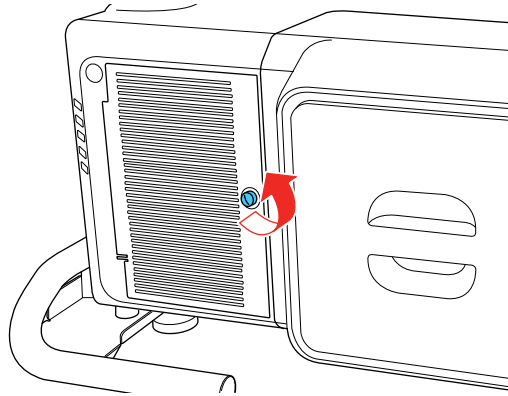

3. Open the air filter cover.

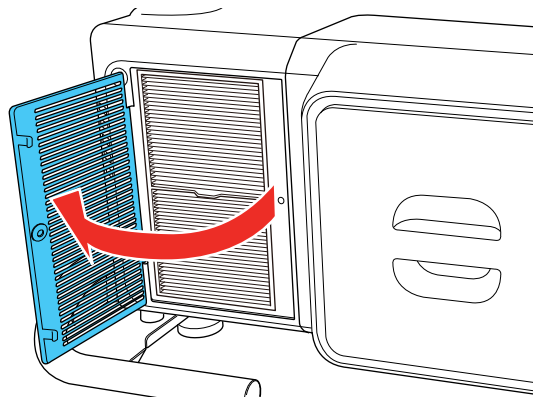

4. Pull the air filter out of the projector.

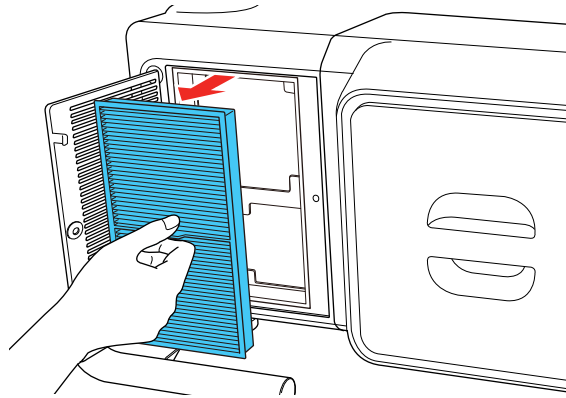

5. Tap each side of the air filter 4 to 5 times to shake off any excess dust.

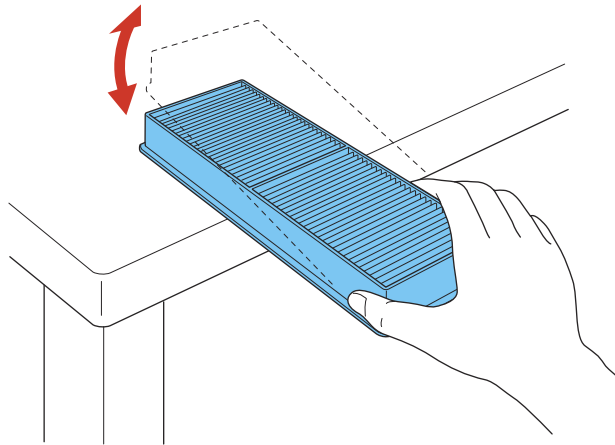

**Caution:** Do not use excessive force when tapping the air filter, or it may crack and become unusable. Do not rinse the air filter in water, or use any detergent or solvent to clean it. Do not use canned air; the gases may leave a residue, or push dust and debris into the projector's optics or other sensitive areas.

6. Vacuum the front of the air filter (the side with the tabs) to remove any remaining dust.

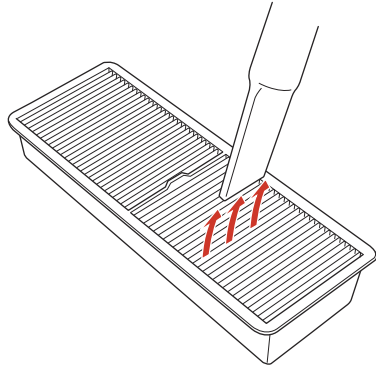

**Note:** If dust is difficult to remove or the air filter is damaged, replace the air filter.

7. Place the air filter back in the projector as shown and push gently until it clicks into place.

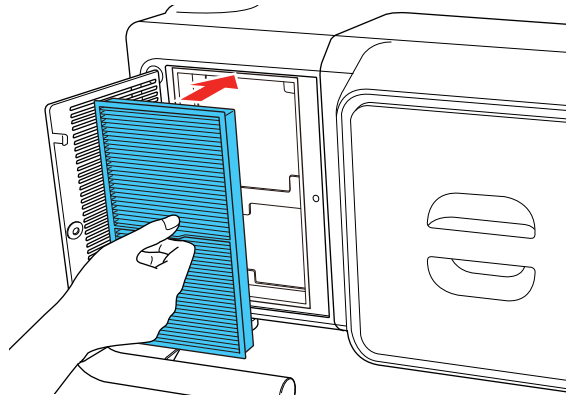



8. Close the air filter cover.

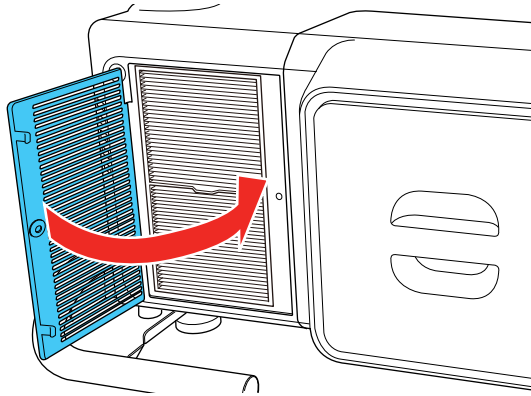

9. Tighten the screw to secure the air filter cover.

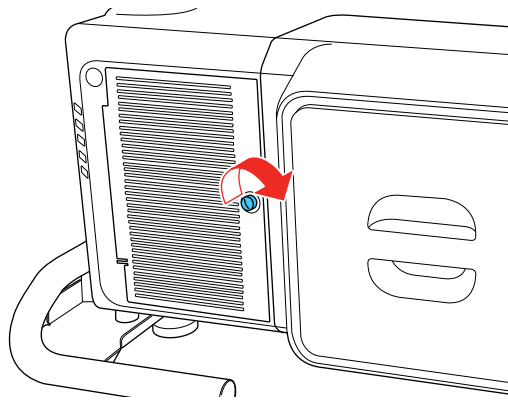

10. Repeat these steps to clean the other air filters.

**Note:** The air filter cover on the side of the projector is attached to a cord to prevent it from falling.

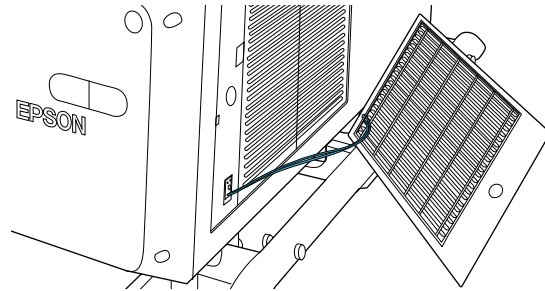

**Parent topic:** [Air Filter and Vent Maintenance](#)

**Related references**

[Projector Light Status](#)

### Replacing the Air Filters

You need to replace the air filters in the following situations:

- After cleaning an air filter, you see a message telling you to clean or replace it
- An air filter is torn or damaged

You can replace an air filter while the projector is mounted to the ceiling or placed on a table.

**Note:** The projector has one air filter on the front and two on the sides. The illustrations here show replacing the air filter on the front, but the steps are the same to replace the filters on the side.

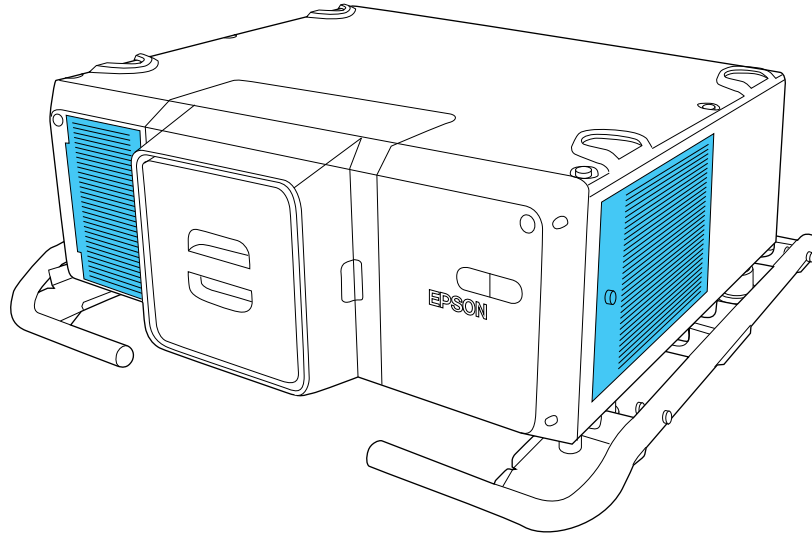

1. Turn off the projector, wait for the projector to beep, and unplug the power cord.
2. Loosen the screw securing the air filter cover.

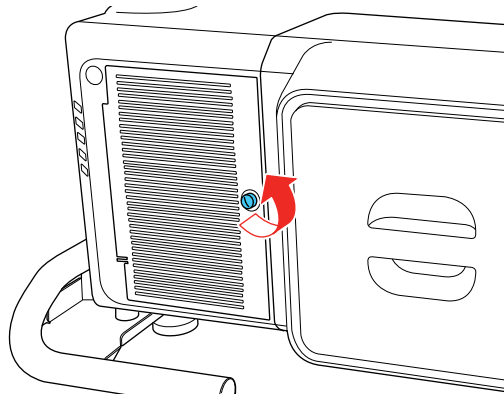

3. Open the air filter cover.

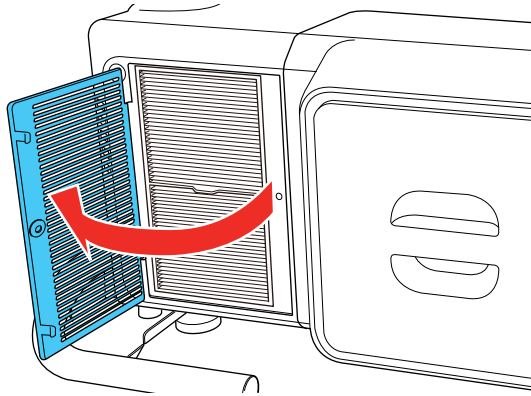

4. Pull the air filter out of the projector.

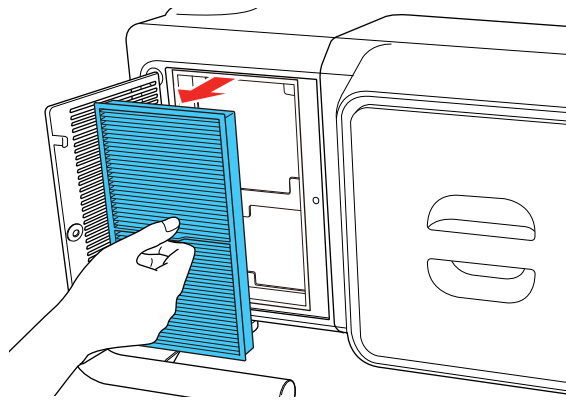

**Note:** Air filters contain polypropylene. Dispose of used air filters according to local regulations.

5. Place the new air filter in the projector as shown and push gently until it clicks into place.

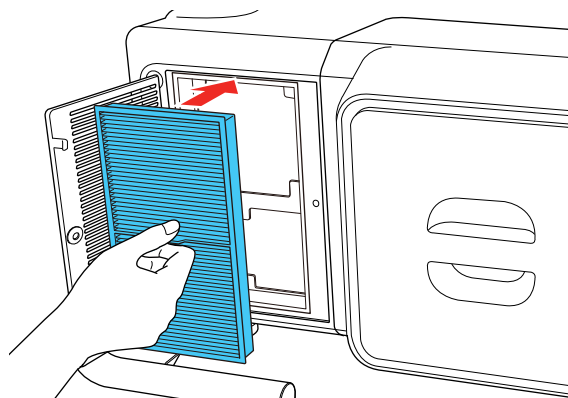

6. Close the air filter cover.

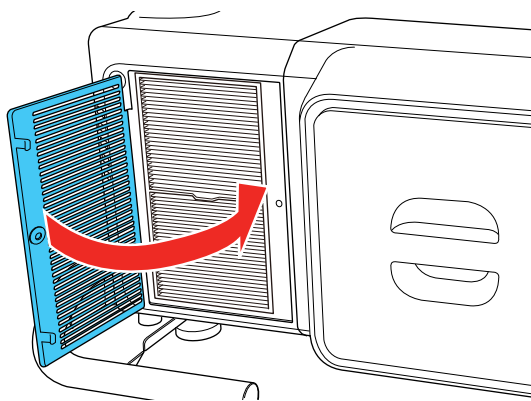

7. Tighten the screw securing the air filter cover.

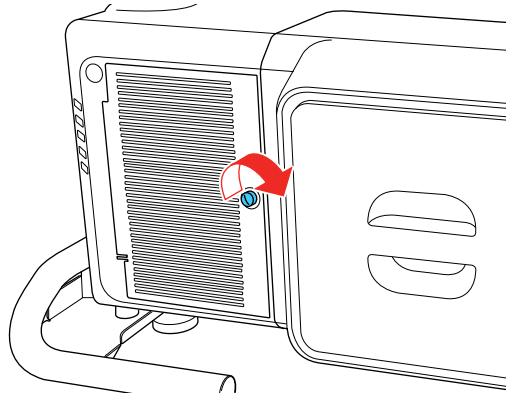

8. Repeat these steps to replace the other air filters.

**Note:** The air filter cover on the side of the projector is attached to a cord to prevent it from falling.

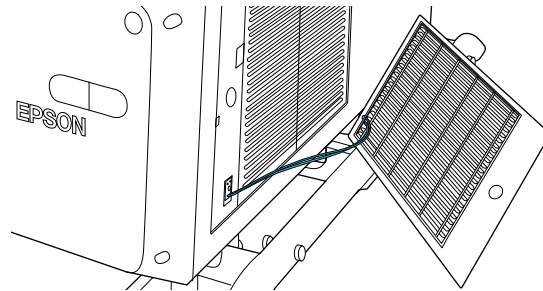

**Parent topic:** [Air Filter and Vent Maintenance](#)

## Replacing the Remote Control Batteries

The remote control uses two AA manganese or alkaline batteries. Replace the batteries as soon as they run out.

**Caution:** Use only the type of batteries specified in this manual. Do not install batteries of different types, or mix new and old batteries.

1. Remove the battery cover as shown.

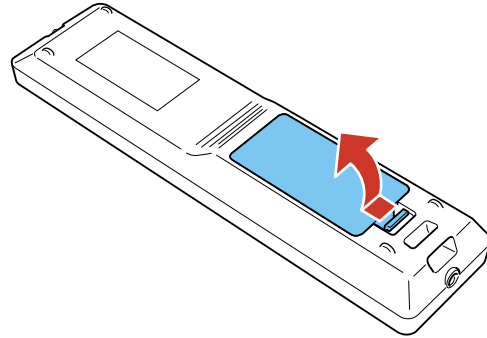

2. Remove the old batteries.

**Warning:** If the battery fluid has leaked, wipe it away with a soft cloth and avoid getting the fluid on your hands. If it gets on your hands, wash them immediately to avoid injury.

3. Insert the batteries with the + and – ends facing as shown.

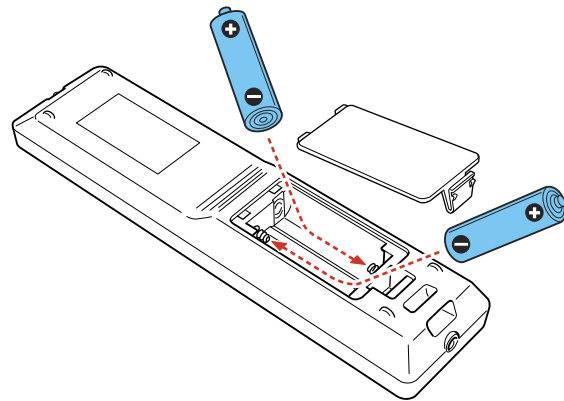

4. Replace the battery cover and press it down until it clicks into place.

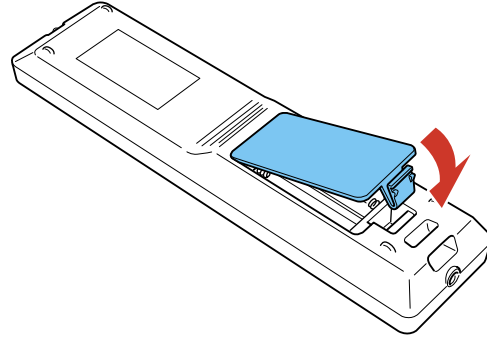

**Warning:** Dispose of used batteries according to local regulations. Do not expose batteries to heat or flame. Keep batteries out of the reach of children; they are choking hazards and are very dangerous if swallowed.

Parent topic: [Projector Maintenance](#)

## Transporting the Projector

The projector contains precision parts, some of which are glass. Follow the guidelines here to transport, ship, or store the projector safely.

**Caution:** Use four or more people to unpack or lift the projector. Hold the carrying handles to lift the projector.

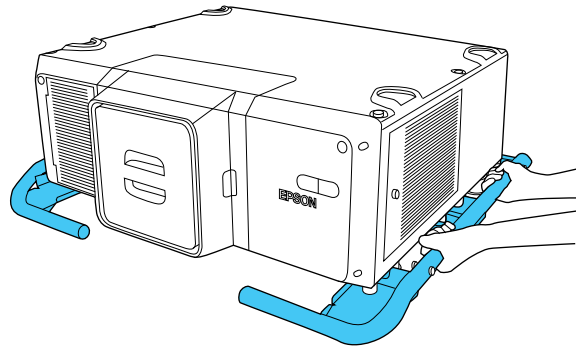



1. Remove any equipment connected to the projector.
2. Do one of the following:
  - If you are moving the projector a short distance, attach the lens cap to the lens unit.

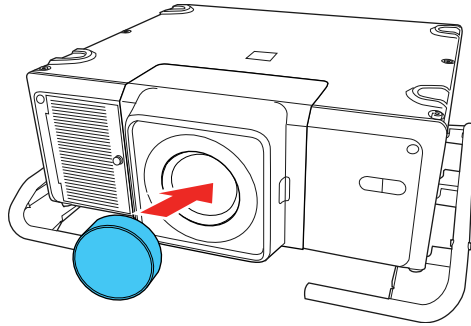

- If you are packing the projector to transport it a long distance, remove the lens unit and attach the cap for the lens cover.

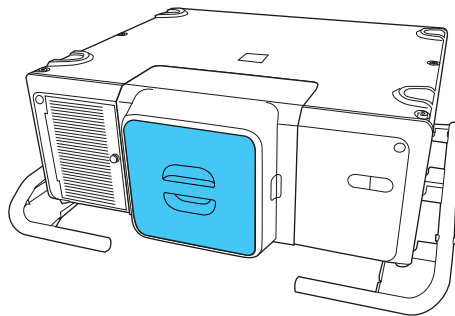

3. Do one of the following:
  - When transporting the projector a long distance or as checked luggage, pack it in a firm box with cushioning around it and mark the box "Fragile."
  - When shipping the projector for repairs, place it in its original packing materials, if possible, or use equivalent materials with cushioning around the projector. Mark the box "Fragile."

**Note:** Epson shall not be liable for any damages incurred during transportation.

**Parent topic:** [Maintaining and Transporting the Projector](#)

**Related tasks**

[Removing a Lens](#)

---

# Solving Problems

Check the solutions in these sections if you have any problems using the projector.

[Projection Problem Tips](#)

[Projector Light Status](#)

[Viewing Projector Status Information](#)

[Using the Projector Help Displays](#)

[Solving Image Problems](#)

[Solving Projector or Remote Control Operation Problems](#)

[Solving Network Problems](#)

[Where to Get Help](#)

## Projection Problem Tips

If the projector is not working properly, try turning it off and unplugging it. Then plug it back in and turn it on.

If this does not solve the problem, check the following:

- The lights on the projector may indicate what the problem is.
- The projector's Help system can display information about common problems, if the projector is operating.
- The projector's LCD screen can display information about the projector's status.
- The solutions in this manual can help you solve many problems.

If none of these solutions help, you can contact Epson for technical support.

**Parent topic:** [Solving Problems](#)

# Projector Light Status

The lights on the projector indicate the projector status and let you know when a problem occurs. Check the status and color of the lights and look for a solution in the table here.

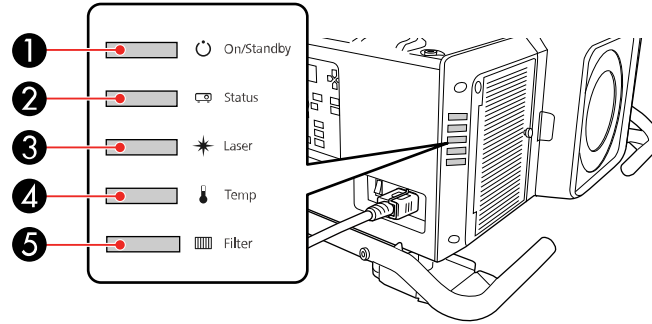

- 1 On/Standby light
- 2 Status light
- 3 Laser light
- 4 Temp (temperature) light
- 5 Filter light

On/Standby (power) light	Status light	Laser light	Temp light	Filter light	Status and solution
Blue	Off	Off	Off	Off	Projector is in standby mode or network monitoring and control is in progress.
Blue	Flashing blue	Varies	Off	Off	Warming up. Wait for an image to appear.
Blue	Blue	Varies	Off	Off	Normal operation.
Blue	Flashing blue	Off	Off	Off	Cooling down. All buttons are disabled.

On/Standby (power) light	Status light	Laser light	Temp light	Filter light	Status and solution
Flashing blue	Off	Off	Off	Off	Preparing network monitoring. (Wait for the light to remain orange before unplugging the projector.)
Blue	Blue	Flashing blue	Off	Off	The shutter feature is enabled.
Off	Flashing blue	Flashing orange	Off	Off	Internal error. Turn off the projector, unplug the power cord, and contact Epson for help.
Off	Flashing blue	Off	Flashing orange	Off	A fan or sensor has a problem. Turn off the projector, unplug the power cord, and contact Epson for help.
Off	Flashing blue	Off	Orange	Off	<p>Projector is too hot.</p> <ul style="list-style-type: none"> <li>• Make sure that the vents and air filter are not clogged with dust or obstructed by nearby objects.</li> <li>• Clean or replace the air filter.</li> <li>• Make sure the environmental temperature is not too hot.</li> <li>• If operating the projector at high altitude, turn on <b>High Altitude Mode</b>.</li> <li>• If the problem persists, unplug the projector and contact Epson for help.</li> </ul>
Off	Flashing blue	Orange	Off	Off	<p>The laser has a problem.</p> <ul style="list-style-type: none"> <li>• Make sure that the vents and air filter are not clogged with dust or obstructed by nearby objects.</li> <li>• Clean or replace the air filter.</li> <li>• If the problem persists, unplug the projector and contact Epson for help.</li> </ul>

On/Standby (power) light	Status light	Laser light	Temp light	Filter light	Status and solution
Off	Flashing blue	Off	Off	Orange	Low air flow through the projector. <ul style="list-style-type: none"> <li>• Make sure that the vents and air filter are not clogged with dust or obstructed by nearby objects.</li> <li>• Clean or replace the air filter.</li> <li>• If the problem persists, unplug the projector and contact Epson for help.</li> </ul>
Off	Flashing blue	Orange	Orange	Off	Lens Shift error. Turn off the projector, unplug the power cord, and contact Epson for help
Flashing blue	Varies	Varies	Flashing orange	Varies	High temperature warning. If the temperature gets too high, projection will automatically stop. <ul style="list-style-type: none"> <li>• Make sure that the vents and air filter are not clogged with dust or obstructed by nearby objects.</li> <li>• Clean or replace the air filter.</li> </ul>
Varies	Varies	Varies	Varies	Flashing orange	Clean the air filter.
Flashing blue	Varies	Flashing orange	Varies	Varies	The laser has a problem. Turn off the projector, unplug the power cord, and contact Epson for help.
Flashing blue	Varies	Flashing orange	Varies	Varies	An unsupported lens is attached. Attach only a supported lens.

On/Standby (power) light	Status light	Laser light	Temp light	Filter light	Status and solution
Flashing blue	Varies	Varies	Varies	Orange	<p>Low air flow through the air filter.</p> <ul style="list-style-type: none"> <li>• Make sure that the vents and air filter are not clogged with dust or obstructed by nearby objects.</li> <li>• Clean or replace the air filter.</li> <li>• If the problem persists, unplug the projector and contact Epson for help.</li> </ul>

**Note:** If the lights display a pattern not listed in the table above, turn the projector off, unplug it, and contact Epson for help.

**Parent topic:** [Solving Problems](#)

**Related concepts**

[Air Filter and Vent Maintenance](#)

**Related references**

[Projector Setup Settings - Extended Menu](#)

[Optional Equipment and Replacement Parts](#)

**Related tasks**

[Stopping Video Action Temporarily](#)

## Viewing Projector Status Information

You can monitor the projector's status and view error information on the LCD status display.

**Note:** You can also view the projector's status in the Info menu. Press the **i** button on the remote control and select **Status Information**.

1. Turn on the projector.
2. Press the light button on the control panel.

3. Press the left or right arrow button to view different categories of information.

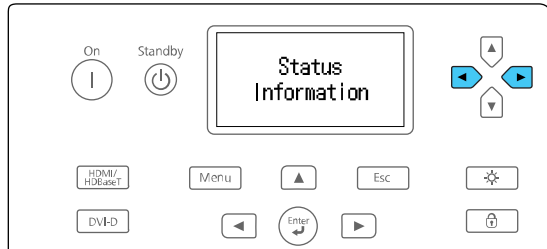

- **Status Information:** the projector's operating status
  - **Source:** input signal information
  - **Signal Information:** input digital signal information
  - **Network Wired:** wired LAN settings
  - **Network Wireless:** wireless LAN settings
  - **Maintenance:** operating time for the projector and light source
  - **Version:** projector's firmware version
  - **Setting:** lets you adjust the LCD contrast and the length of time the screen remains lit when you press the light button
4. Press the up or down arrow button to scroll through the information on the screen.

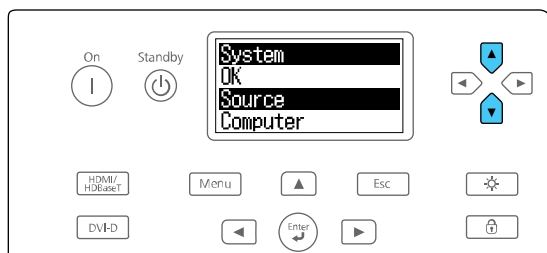

## Projector Status Display Messages

Parent topic: [Solving Problems](#)



## Projector Status Display Messages

Categories on the status display screens let you view information about the projector and its operation.

### Status Information category

Information	Description
<b>System</b>	See the System status information table at the end of this topic
<b>Source</b>	Displays the source currently being used
<b>On-Screen Display</b>	Displays the settings for on-screen displays . When turned off, menus or messages are not displayed on the projected images
<b>Shutter</b>	Displays the shutter status
<b>Air Temp</b>	Display the environmental temperature
<b>Temp Level</b>	
<b>AC Voltage</b>	Displays warnings and errors that have occurred when the <b>AC Voltage Monitoring</b> setting is turned on
<b>Laser Status</b>	Display the operating status of the light source

### Source category

Information	Description
<b>Source</b>	Displays the source currently being used
<b>Resolution</b>	Displays the resolution of the current input signal
<b>Video Signal</b>	Displays the current input video signal
<b>Color Space</b>	Displays the color space of the current input signal
<b>H-Frequency</b>	Displays the horizontal frequency of the current input signal
<b>V-Frequency</b>	Displays the vertical frequency of the current input signal
<b>Sync Polarity</b>	Displays the sync polarity

<b>Information</b>	<b>Description</b>
<b>Sync Mode</b>	Displays the sync type
<b>Detected Mode</b>	Displays the detected mode of the current input signal
<b>Video Level</b>	Displays the video level of the projector

**Signal Information** category

<b>Information</b>	<b>Description</b>
<b>5V Detect</b>	Displays the detection results of 5V signals
<b>TMDS Clock</b>	Displays the TMDS frequency of the current input signal
<b>TMDS H-Frequency</b>	Displays the horizontal frequency of the current input signal
<b>TMDS V-Frequency</b>	Displays the vertical frequency of the current input signal
<b>DetChg 5CFHMP123</b>	Displays the factors of signal changes
<b>Stable Time</b>	Displays the amount of operating time since the input source was determined
<b>HDCP Status</b>	Displays the HDCP status
<b>HDCP Ver</b>	Displays the HDCP version
<b>AVI Info VIC</b>	Displays the VIC information (AVI) of the current input signal
<b>AVI InfoChecksum</b>	Displays the checksum result for AVI
<b>Signal Mode</b>	Displays the signal mode
<b>Pixel Encoding</b>	Displays the color space information (AVI) of the current input signal
<b>HDBaseT Level</b>	Displays the image signal information from the HDBaseT port

**Network Wired** category

Information	Description
<b>Projector Name</b>	Displays the name used to identify the projector when connected to a network
<b>Connection Mode</b>	Displays the connection path for the LAN
<b>DHCP</b>	Displays the DHCP display settings
<b>IP Display</b>	Displays the IP address display settings
<b>IP Address</b>	Displays the IP address
<b>MAC Address</b>	Displays the MAC address

**Network Wireless** category

Information	Description
<b>Projector Name</b>	Displays the name used to identify the projector when connected to a network
<b>Connection Mode</b>	Displays the connection mode to use when connecting the projector and a computer over a wireless LAN
<b>SSID Display</b>	Displays the SSID display settings
<b>IP Display</b>	Displays the IP address display settings
<b>SSID</b>	Displays the SSID
<b>IP Address</b>	Displays the IP address
<b>DHCP</b>	Displays the DHCP settings
<b>MAC Address</b>	Displays the MAC address
<b>Security</b>	Displays the security settings
<b>Antenna Level</b>	Displays the reception status for Wi-Fi

**Maintenance** category

Information	Description
<b>Operation Time</b>	Displays the projector's total operation time

Information	Description
Laser Op. Time	Displays the laser operating time for each Light Source Mode setting

#### Version category

Information	Description
Serial No.	Displays the projector's serial number
Main	Display the projector's firmware version information
Video2	
Sub	
Sub2	
HDBaseT	
Status Monitor	

#### System status information

Status	Description
OK	The projector is in normal operating mode
Warm-up	The projector is warming up
Standby	The projector is in standby mode
Cool Down	The projector is cooling down
Temp Error	A high temperature error occurred
Fan Error	A fan error occurred
Sensor Error	A sensor error occurred
Power Error	A power error occurred
Internal Error	An internal error occurred
Airflow Error	A filter airflow error occurred
Temp Warning	A high temperature warning occurred
Internal Warning	A warning regarding the internal system occurred

Status	Description
<b>Airflow Decline</b>	A low airflow error occurred
<b>Power Warning</b>	A power warning occurred
<b>Clean Filter</b>	An air filter notice occurred; clean the air filter
<b>Lens Error</b>	A lens error has occurred
<b>Laser Error</b>	A laser error has occurred
<b>Laser Warning</b>	A laser warning has occurred

Parent topic: [Viewing Projector Status Information](#)

## Using the Projector Help Displays

You can display information to help you solve common problems using the projector's Help system.

**Note:** Before using the Help system, assign **Help** to one of the **User** buttons.

1. Turn on the projector.
2. Press the **User** button assigned to **Help**.  
You see the Help menu.
3. Use the up and down arrow buttons to highlight the problem you want to solve.
4. Press **Enter** to view the solutions.
5. When you are finished, do one of the following:
  - To select another problem to solve, press **Esc**.
  - To exit the help system, press the **Menu** button.

Parent topic: [Solving Problems](#)

## Solving Image Problems

Check the solutions in these sections if you have any problems with projected images.

[Solutions When No Image Appears](#)

[Solutions When "No Signal" Message Appears](#)

[Solutions When "Not Supported" Message Appears](#)

[Solutions When Only a Partial Image Appears](#)

[Solutions When the Image is Not Rectangular](#)

[Solutions When the Image Contains Noise or Static](#)

[Solutions When the Image is Fuzzy or Blurry](#)

[Solutions When the Image Brightness or Colors are Incorrect](#)

**Parent topic:** [Solving Problems](#)

## Solutions When No Image Appears

If no image appears, try the following solutions:

- Make sure the lens cap is off.
- Press the **Shutter** button on the remote control to see if the image was temporarily turned off.
- Make sure all necessary cables are securely connected and the power is on for the projector and connected video sources.
- Press the projector's power button to wake it from standby or sleep mode. Also see if your connected computer is in sleep mode or displaying a blank screen saver.
- Press the **Menu** button. If the projector menu is able to display, there may be a problem with the connected video source, cable connection, or port.
- Check the settings on the Signal menu to make sure they are correct for the current video source.
- Adjust the **Brightness Settings**.
- Check the **Display** setting to make sure **Messages** is set to **On**.
- If the projector does not respond when you press the control panel buttons, the buttons may be locked. Unlock the buttons.
- For images projected with Windows Media Center, reduce the screen size from full screen mode.
- For images projected from applications using Windows DirectX, turn off DirectX functions.
- If the other solutions do not solve the problem, reset all of the projector settings using the options on the **Reset** menu.

**Parent topic:** [Solving Image Problems](#)

### Related concepts

[Projector Connections](#)

### Related references

[Input Signal Settings - Signal Menu](#)

[Projector Setup Settings - Extended Menu](#)

### Related tasks

[Adjusting the Brightness](#)

[Unlocking the Projector's Buttons](#)

## Solutions When "No Signal" Message Appears

If the "No Signal" message appears, try the following solutions:

- Press the **Search** button on the remote control and wait a few seconds for an image to appear
- Turn on the connected computer or video source, and press its play button to begin your presentation, if necessary.
- Check the connection from the projector to your video sources.
- If you are projecting from a laptop computer, make sure it is set up to display on an external monitor.
- If necessary, turn the projector and the connected computer or video source off and then on again.
- If the other solutions do not solve the problem, reset all of the projector settings using the options on the **Reset** menu.

[Displaying From a PC Laptop](#)

[Displaying From a Mac Laptop](#)

**Parent topic:** [Solving Image Problems](#)

### Related concepts

[Projector Connections](#)

## Displaying From a PC Laptop

If you see the "No Signal" message when you display from a PC laptop, you need to set up the laptop to display on an external monitor.

1. Hold down the laptop's **Fn** key and press the key labeled with a monitor icon or **CRT/LCD**. (See your laptop manual for details.) Wait a few seconds for an image to appear.
2. To display on both the laptop's monitor and the projector, try pressing the same keys again.
3. If the same image is not displayed by the laptop and projector, check the Windows **Display** utility to make sure the external monitor port is enabled and extended desktop mode is disabled. (See your computer or Windows manual for instructions.)
4. If necessary, check your video card settings and set the multiple display option to **Mirror** or **Duplicate**.

**Parent topic:** [Solutions When "No Signal" Message Appears](#)

## Displaying From a Mac Laptop

If you see the "No Signal" message when you display from a Mac laptop, you need to set up the laptop for mirrored display. (See your laptop manual for details.)

1. Open the **System Preferences** utility and select **Displays**.
2. Click the **Arrangement** tab.
3. Select the **Mirror Displays** checkbox.

**Parent topic:** [Solutions When "No Signal" Message Appears](#)

## Solutions When "Not Supported" Message Appears

If the "Not Supported" message appears, try the following solutions:

- Make sure the correct input signal is selected on the Signal menu.
- Make sure the computer's display resolution does not exceed the projector's resolution and frequency limit. If necessary, select a different display resolution for your computer. (See your computer manual for details.)
- As a test, try setting the computer's display resolution to the lowest possible setting, and then gradually increase it as necessary.

**Parent topic:** [Solving Image Problems](#)

### Related references

[Input Signal Settings - Signal Menu](#)

[Supported Video Display Formats](#)

## Solutions When Only a Partial Image Appears

If only a partial computer image appears, try the following solutions:

- Make sure you selected the correct **Screen Type** setting for the screen being used.
- Make sure the **Scale** setting in the Extended menu is turned off.
- Try adjusting the image position using the **Position** menu setting.
- Try adjusting the image position using the **Screen Position** menu setting.
- Press the **Aspect** button on the remote control to select a different image aspect ratio.
- Check the cables connecting the computer or video source to the projector. Try connecting different cables.



- Check your computer display settings to disable dual display and set the resolution within the projector's limits. (See your computer manual for details.)
- Check the resolution assigned to your presentation files to see if they are created for a different resolution than you are projecting in. (See your software help for details.)

**Parent topic:** [Solving Image Problems](#)

**Related concepts**

[Projector Connections](#)

**Related references**

[Projector Setup Settings - Extended Menu](#)

[Input Signal Settings - Signal Menu](#)

[Supported Video Display Formats](#)

**Related tasks**

[Setting the Screen Type](#)

[Adjusting the Image Position Using Screen Position](#)

## **Solutions When the Image is Not Rectangular**

If the projected image is not evenly rectangular, try the following solutions:

- Place the projector directly in front of the center of the screen, facing it squarely, if possible.
- Adjust the image shape using the **Geometry Correction** menu settings.

**Parent topic:** [Solving Image Problems](#)

**Related references**

[Projector Feature Settings - Settings Menu](#)

## **Solutions When the Image Contains Noise or Static**

If the projected image seems to contain electronic interference (noise) or static, try the following solutions:

- Check the cables connecting your computer or video source to the projector. They should be:
  - Separated from the power cord to prevent interference
  - Securely connected at both ends
  - Not connected to an extension cable
  - No longer than 10 feet (3 m) for VGA/computer cables or 24 feet (7.3 m) for HDMI cables

- Check the settings on the projector's Signal menu to make sure they match the video source. If available for your video source, adjust the **Deinterlacing** and **Noise Reduction** settings.
- Select a computer video resolution and refresh rate that are compatible with the projector.
- If you are projecting from a computer, press the **Auto** button on the remote control to automatically adjust the tracking and sync. If the problem remains, display a uniformly patterned image on the screen and manually adjust the **Tracking** and **Sync** settings.
- If you adjusted the image shape using the projector controls, try decreasing the **Sharpness** setting to improve image quality.
- Try a different cable.
- Try turning off **Frame Interpolation**, or turn on **Image Enhancement** in the Image menu.

**Parent topic:** [Solving Image Problems](#)

#### **Related references**

[Image Quality Settings - Image Menu](#)

[Input Signal Settings - Signal Menu](#)

[Supported Video Display Formats](#)

## **Solutions When the Image is Fuzzy or Blurry**

If the projected image is fuzzy or blurry, try the following solutions:

- Adjust the image focus.
- Clean the projector lens.

**Note:** To avoid condensation on the lens after bringing the projector in from a cold environment, let the projector warm up to room temperature before using it.

- Try connecting the projector to the highest quality connection available on your input source. For example, connect to an HDMI port or component video ports for a better quality input signal.
- Position the projector close enough to the screen.
- Position the projector so the keystone adjustment angle is not so wide that it distorts the image.
- Adjust the **Sharpness** setting to improve image quality.
- If you are projecting from a computer, press the **Auto** button on the remote control to automatically adjust the tracking and sync. If any bands or overall blurriness remain, display a uniformly patterned image on the screen and manually adjust the **Tracking** and **Sync** settings.

- If you are projecting from a computer, try using a lower resolution or try to match the projector's native resolution.

**Parent topic:** [Solving Image Problems](#)

**Related concepts**

[Projector Connections](#)

**Related references**

[Projector Setup and Installation Options](#)

[Image Quality Settings - Image Menu](#)

[General Projector Specifications](#)

[Supported Video Display Formats](#)

**Related tasks**

[Focusing the Image Using the Focus Button](#)

[Cleaning the Lens](#)

## Solutions When the Image Brightness or Colors are Incorrect

If the projected image is too dark or light, or the colors are incorrect, try the following solutions:

- Press the **Color Mode** button on the remote control to try different color modes for the image and environment.
- Check your video source settings.
- Adjust the available settings on the Image menu for the current input source, such as **Brightness**, **Contrast**, **Tint**, **Advanced**, and **Color Saturation**.
- Make sure you selected the correct **Input Signal** or **Video Signal** setting on the Signal menu, if available for your image source.
- Make sure all the cables are securely connected to the projector and your video device. If you connected long cables, try connecting shorter cables.
- Make sure the **Brightness Settings** in the Settings menu is set correctly.
- Position the projector close enough to the screen.

**Parent topic:** [Solving Image Problems](#)

**Related references**

[Image Quality Settings - Image Menu](#)

[Input Signal Settings - Signal Menu](#)

[Projector Feature Settings - Settings Menu](#)

[Projection Distance](#)

## Solving Projector or Remote Control Operation Problems

Check the solutions in these sections if you have problems operating the projector or remote control.

[Solutions to Projector Power or Shut-Off Problems](#)

[Solutions to Problems with the Remote Control](#)

[Solutions to Password Problems](#)

**Parent topic:** [Solving Problems](#)

### Solutions to Projector Power or Shut-Off Problems

If the projector does not come on when you press the power button or it shuts off unexpectedly, try the following solutions:

- Make sure the power cord is securely connected to the projector and to a working electrical outlet.
- The projector's buttons may be locked for security. Unlock the buttons or use the remote control to turn on the projector.
- If the projector's laser shuts off unexpectedly, it may have entered standby mode after a period of inactivity. Press the power button to wake the projector and adjust the **Sleep Mode Timer** setting to change the sleep interval.
- If the power button on the remote control does not turn on the projector, check its batteries and make sure the **Remote Receiver** setting is turned on in the projector's menu, if available.
- The power cord may be defective. Try another power cord. If that doesn't work, disconnect the cord and contact Epson.
- Make sure the power switch is turned on.

**Parent topic:** [Solving Projector or Remote Control Operation Problems](#)

#### Related references

[Projector Setup Settings - Extended Menu](#)

[Projector Feature Settings - Settings Menu](#)

[Projector Light Status](#)

#### Related tasks

[Unlocking the Projector's Buttons](#)

## Solutions to Problems with the Remote Control

If the projector does not respond to remote control commands, try the following solutions:

- Check that the remote control batteries are installed correctly and have power. If necessary, replace the batteries.
- Make sure you are operating the remote control within the reception angle and range of the projector.
- Make sure the projector is not warming up or shutting down.
- Check to see if a button on the remote control is stuck down, causing it to enter sleep mode. Release the button to wake the remote control up.
- Strong fluorescent lighting, direct sunlight, or infrared device signals may be interfering with the projector's remote receivers. Dim the lights or move the projector away from the sun or interfering equipment.
- Make sure the optional remote control cable set is not attached to the projector's **Remote** port. If you leave the cable connected to the port, the remote control cannot control the projector.
- If available, turn off one of the remote receivers in the projector's menu system, or check if all the remote receivers were turned off.
- If you assigned an ID number to the remote control to operate multiple projectors, you may need to check or change the ID setting (feature not available with all projectors).
- Make sure the **Control Communications** or **Extron XTP** setting in the Extended menu is set to **Off** if you are using the optional remote control cable set.
- If you lose the remote control, you can purchase another from an authorized Epson reseller.

**Parent topic:** [Solving Projector or Remote Control Operation Problems](#)

### Related concepts

[Projector Identification System for Multiple Projector Control](#)

### Related references

[Remote Control Operation](#)

[Projector Feature Settings - Settings Menu](#)

[Projector Setup Settings - Extended Menu](#)

### Related tasks

[Replacing the Remote Control Batteries](#)

## Solutions to Password Problems

If you cannot enter or remember a password, try the following solutions:

- You may have turned on password protection without first setting a password. Try entering **0000** using the remote control.
- If you have entered an incorrect password too many times and see a message displaying a request code, write down the code and contact Epson. Do not attempt to enter the password again. Provide the request code and proof of ownership for assistance in unlocking the projector.
- If you set a Web Control password and forgot the user ID or password, try entering the following:
  - User ID: **EPSONWEB**
  - Default password: **admin**
- If you set a Remote password (in Epson Web Control) and forgot the user ID or password, try entering the following:
  - User ID: **EPSONREMOTE**
  - Default password: **guest**
- If you lose the remote control, you cannot enter a password. Order a new one from Epson.

**Parent topic:** [Solving Projector or Remote Control Operation Problems](#)

**Related concepts**

[Password Security Types](#)

## Solving Network Problems

Check the solutions in these sections if you have problems using the projector on a network.

[Solutions When You Cannot Access the Projector Through the Web](#)

[Solutions When Network Alert E-Mails are Not Received](#)

**Parent topic:** [Solving Problems](#)

## Solutions When You Cannot Access the Projector Through the Web

If you are unable to access the projector through a web browser, make sure you are using the correct ID and password, which are case sensitive.

- For the user ID, enter **EPSONWEB**. (You cannot change the user ID.)
- For the password, enter the password set in the projector's Network menu. The default password is **admin**.

- Make sure you have access to the network the projector is on.

**Note:** The user ID and password are case sensitive.

**Parent topic:** [Solving Network Problems](#)

**Related concepts**

[Password Security Types](#)

**Related tasks**

[Controlling a Networked Projector Using a Web Browser](#)

## Solutions When Network Alert E-Mails are Not Received

If you do not receive an e-mail alerting you to problems with a projector over the network, try the following solutions:

- Make sure the projector is turned on and connected to the network correctly. (If an error shut down the projector, it cannot send an e-mail.)
- Make sure you set up the projector e-mail alert settings correctly on the projector's network Mail menu or in the network software.
- Set the **Standby Mode** setting to **Communication On** so the network software can monitor the projector in standby mode.

**Parent topic:** [Solving Network Problems](#)

**Related references**

[Projector Network Settings - Network Menu](#)

[Projector Setup Settings - Extended Menu](#)

## Where to Get Help

If you need to contact Epson for technical support services, use the following support options.

**Internet Support**

Visit Epson's support website at [epson.com/support](http://epson.com/support) (U.S.), [epson.ca/support](http://epson.ca/support) (Canada), or [epson.com.jm/support](http://epson.com.jm/support) (Caribbean) and select your product for solutions to common problems with your projector. You can download utilities and documentation, get FAQs and troubleshooting advice, or e-mail Epson with your questions.

### **Speak to a Support Representative**

To use the Epson PrivateLine Support service, call (800) 637-7661. This service is available for the duration of your warranty period. You may also speak with a projector support specialist by dialing (562) 276-4394 (U.S.) or (905) 709-3839 (Canada).

Support hours are 6 AM to 8 PM, Pacific Time, Monday through Friday and 7 AM to 4 PM, Pacific Time, Saturday.

Days and hours of support are subject to change without notice. Toll or long distance charges may apply.

Before you call, have the following information ready:

- Product name
- Product serial number (located on the bottom or rear of the projector, or in the menu system)
- Proof of purchase (such as a store receipt) and date of purchase
- Computer or video configuration
- Description of the problem

### **Purchase Supplies and Accessories**

You can purchase screens, other optional accessories, and replacement parts from an Epson authorized reseller. To find the nearest reseller, call 800-GO-EPSON (800-463-7766) in the U.S. or 800-807-7766 in Canada. Or you can purchase online at [epsonstore.com](http://epsonstore.com) (U.S. sales) or [epsonstore.ca](http://epsonstore.ca) (Canadian sales).

To purchase a replacement remote control, call (562) 276-4394 (U.S.) or (905) 709-3839 (for dealer referral in Canada).

**Parent topic:** [Solving Problems](#)



---

# Technical Specifications

These sections list the technical specifications of your projector.

[General Projector Specifications](#)

[Projector Light Source Specifications](#)

[Remote Control Specifications](#)

[Projector Dimension Specifications](#)

[Projector Electrical Specifications](#)

[Projector Environmental Specifications](#)

[Projector Safety and Approvals Specifications](#)

[Supported Video Display Formats](#)

## General Projector Specifications

<b>Type of display</b>	Poly-silicon TFT active matrix
<b>Resolution</b>	1920 × 1200 pixels (WUXGA)
<b>Lens</b>	F=1.9 to 2.1 Focal length: 54.7 to 73 mm
<b>Color reproduction</b>	Full color, up to 1 billion colors
<b>Brightness</b>	Normal Light Source mode: White light output 25000 lumens (ISO 21118 standard) Color light output 25000 lumens Extended Light Source mode: White light output 17500 lumens (ISO 21118 standard)  <b>Note:</b> Color brightness (color light output) and white brightness (white light output) will vary depending on usage conditions. Color light output measured in accordance with IDMS 15.4; white light output measured in accordance with ISO 21118.
<b>Contrast ratio</b>	Over 2,500,000:1 with Dynamic contrast on and Normal Light Source mode

<b>Image size</b> (in native aspect ratio)	100 inches (2.54 m) to 1000 inches (25.4 m)
<b>Projection distance</b> (in native aspect ratio)	144.9 inches (3.68 m) to 2009 inches (51.03 m)
<b>Projection methods</b>	360° free
<b>Optical aspect ratio</b> (width-to-height)	16:10
<b>Focus adjustment</b>	Powered
<b>Zoom adjustment</b>	Powered
<b>Zoom ratio</b> (Tele-to-Wide)	1 to 1.35
<b>Noise level</b>	49 dB (Normal/Extended/Custom Light Source mode) 41 dB (Quiet Light Source mode)
<b>Keystone correction angle</b>	Vertical: ± 35° to 45°, depending on the lens type Horizontal: ± 30° (all lens types)
<b>USB Type B port compatibility</b>	USB 1.1 and 2.0 compliant for firmware update and copying menu settings
<b>USB Type A port compatibility</b>	USB 1.1 and 2.0 compliant port for optional wireless LAN module, firmware update, or copying menu settings

Parent topic: [Technical Specifications](#)

## Projector Light Source Specifications

<b>Type</b>	Laser Diode
<b>Power consumption</b>	2160 W
<b>Light source output power</b>	1670 W
<b>Wavelength</b>	450 to 460 nm

<b>Light source life</b>	Normal/Quiet Light Source mode: Up to about 20000 hours Extended Light Source mode: Up to about 30000 hours
--------------------------	--

**Note:** Turn off this product when not in use to prolong the life of the projector. Laser life will vary depending upon mode selected, environmental conditions, and usage. Brightness decreases over time.

Parent topic: [Technical Specifications](#)

## Remote Control Specifications

<b>Reception range</b>	98.4 feet (30 m)
<b>Batteries</b>	Two alkaline or manganese AA

Parent topic: [Technical Specifications](#)

## Projector Dimension Specifications

**Note:** These specifications exclude the projector's feet, projection lens, and carrying handles.

<b>Height</b>	11.8 inches (299 mm)
<b>Width</b>	31.2 inches (790 mm)
<b>Depth</b>	28 inches (710 mm)
<b>Weight</b>	144.6 lb (65.6 kg)

Parent topic: [Technical Specifications](#)

## Projector Electrical Specifications

<b>Rated frequency</b>	50/60 Hz
<b>Power supply</b>	200 to 240 VAC $\pm$ 10% 12.3 A

**Power consumption**                      Operating:  
Normal Power Consumption mode: 2390 W  
Extended Power Consumption mode: 1670 W  
Standby:  
0.5 W (Communication Off), 3 W (Communication On)

Parent topic: [Technical Specifications](#)

## Projector Environmental Specifications

**Temperature**                              Operating:  
Up to 4921 feet (1500 m): 32 to 122 °F (0 to 50 °C)  
4921 feet (1500 m) to 10000 feet (3048 m) with High Altitude Mode enabled: 32 to 113 °F (0 to 45 °C)  
Storage:  
14 to 140 °F (–10 to 60 °C)

**Humidity** (relative, non-condensing)                      Operating: 20 to 80%  
Storage: 10 to 90%

**Operating altitude**                      Up to 4921 feet (1500 m)  
Up to 10000 feet (3048 m) with High Altitude Mode enabled

Parent topic: [Technical Specifications](#)

## Projector Safety and Approvals Specifications

**United States**                              FCC Part 15B Class A  
UL60950-1 2nd edition/UL62368-1 2nd Edition (cTUVus Mark)

**Canada**                                      ICES-003 Class A  
CSA C22.2 No. 60950-1-07/CSA C22.2 No. 62368-1-14

## Warning

This is a class A product. In a domestic environment this product may cause radio interference in which case the user may be required to take adequate measures.

Parent topic: [Technical Specifications](#)

## Supported Video Display Formats

For best results, your computer's monitor port or video card resolution should be set to display in the projector's native resolution. However, your projector includes Epson's SizeWise chip that supports other computer display resolutions, so your image will be resized to fit automatically.

Your computer's monitor port or video card refresh rate (vertical frequency) must be compatible with the projector. (See your computer or video card manual for details.)

The table here lists the compatible refresh rate and resolution for each compatible video display format.

Display format	Refresh rate (in Hz)	Resolution (in pixels)
<b>Computer signals (analog RGB)</b>		
VGA	60/72/75/85	640 × 480
SVGA	60/72/75/85	800 × 600
XGA	60/70/75/85	1024 × 768
WXGA	60	1280 × 768
	60	1366 × 768
	60/75/85	1280 × 800
WXGA+	60/75/85	1440 × 900
WXGA++	60	1600 × 900
SXGA	70/75/85	1152 × 864
	60/75/85	1280 × 960
	60/75/85	1280 × 1024
SXGA+	60/75	1400 × 1050
WSXGA+ <sup>1</sup>	60	1680 × 1050
UXGA	60	1600 × 1200
WUXGA <sup>2</sup>	60	1920 × 1200

Display format	Refresh rate (in Hz)	Resolution (in pixels)
<b>Component video</b>		
SDTV (480i)	60	720 × 480
SDTV (576i)	50	720 × 576
SDTV (480p)	60	720 × 480
SDTV (576p)	50	720 × 576
HDTV (720p)	50/60	1280 × 720
HDTV (1080i)	50/60	1920 × 1080
HDTV (1080p)	50/60	1920 × 1080
<b>HDMI, DVI-D, and HDBaseT input signals</b>		
VGA	60	640 × 480
SVGA	60	800 × 600
XGA	60	1024 × 768
WXGA	60	1280 × 800
	60	1366 × 768
WXGA+	60	1440 × 900
WXGA++	60	1600 × 900
WSXGA+	60	1680 × 1050
SXGA	60	1280 × 960
	60	1280 × 1024
SXGA+	60	1400 × 1050
UXGA	60	1600 × 1200
WUXGA <sup>2</sup>	60	1920 × 1200
QXGA <sup>3</sup>	60	2048 × 1536
WQHD <sup>3</sup>	60	2560 × 1440
WQXGA <sup>2, 3</sup>	60	2560 × 1600
SDTV (480i/480p)	60	720 × 480

Display format	Refresh rate (in Hz)	Resolution (in pixels)
SDTV (576i/576p)	50	720 × 576
HDTV (720p)	50/60	1280 × 720
HDTV (1080i)	50/60	1920 × 1080
HDTV (1080p)	24/30/50/60	1920 × 1080
4Kx2K <sup>3</sup>	24/25/30	3840 × 2160
4Kx2K <sup>3, 4</sup>	50/60	3840 × 2160
4Kx2K (SMPTE) <sup>3</sup>	24	4096 × 2160
4Kx2K (SMPTE) <sup>3, 4</sup>	50/60	4096 × 2160
<b>SDI input signals</b>		
SDTV (480i)	59.94 (SD-SDI mode)	720 × 480
SDTV (576i)	50 (SD-SDI mode)	720 × 576
HDTV (720p)	50/59.94/60 (HD-SDI mode)	1280 × 720
HDTV (1080i)	50/59.94/60 (HD-SDI mode)	1920 × 1080
HDTV (1080p)	23.98/24/25/29.97/30 (HD-SDI mode)	1920 × 1080
HDTV (1080p)	50/59.94/60 (3G-SDI mode; Level A)	1920 × 1080
HDTV (1080p)	23.98/24/25/29.97/30 (3G-SDI mode; Level A)	1920 × 1080
HDTV (1080i)	50/59.94/60 (3G-SDI mode; Level A)	1920 × 1080

<sup>1</sup> Compatible only when **Wide** is selected as the **Resolution** setting

<sup>2</sup> Compatible only with VESA CVT-RB (Reduced Blanking) input signal

<sup>3</sup> HDMI or HDBaseT input only

<sup>4</sup> Compatible only with YPbPr 4:2:0 input signals

**Parent topic:** [Technical Specifications](#)

---

## Notices

Check these sections for important notices about your projector.

[Recycling](#)

[Important Safety Information](#)

[Important Safety Instructions](#)

[List of Safety Symbols \(corresponding to IEC60950-1 A2\)](#)

[FCC Compliance Statement](#)

[Open Source Software License](#)

[Binding Arbitration and Class Waiver](#)

[Trademarks](#)

[Copyright Notice](#)

## Recycling

Epson offers a recycling program for end of life products. Please go to [this site](#) for information on how to return your products for proper disposal.

**Parent topic:** [Notices](#)

## Important Safety Information

**Caution:** Never look into the projector lens when the laser is turned on; the bright light can damage your eyes. Never let children look into the lens when it is on. Never open any cover on the projector, except the filter covers. Dangerous electrical voltages inside the projector can severely injure you. Except as specifically explained in this *User's Guide*, do not attempt to service this product yourself. Refer all servicing to qualified service personnel.

**Warning:** The projector and its accessories come packaged in plastic bags. Keep plastic bags away from small children to avoid any risk of suffocation.

**Parent topic:** [Notices](#)



## Important Safety Instructions

Follow these safety instructions when setting up and using the projector:

- Do not look into the lens when the projector is on. The bright light can damage your eyes. Avoid standing in front of the projector so the bright light does not shine into your eyes.
- Do not place the projector on an unstable cart, stand, or table.
- If the projector is mounted on a ceiling or wall, it should be installed by qualified technicians using mounting hardware designed for use with this projector.
- When installing or adjusting a ceiling or wall mount, do not use adhesives to prevent the screws from loosening and do not use oils or lubricants. This may cause the projector case to crack and the projector to fall from its ceiling mount. This could cause serious injury to anyone under the mount and could damage the projector.
- Do not use the projector near water, sources of heat, high-voltage electrical wires, or sources of magnetic fields.
- Use the type of power source indicated on the projector. Use of a different power source may result in fire or electric shock. If you are not sure of the power available, consult your dealer or power company.
- Place the projector near a wall outlet where the plug can be easily unplugged.
- Take the following precautions when handling the plug: Do not hold the plug with wet hands. Do not insert the plug into a dusty outlet. Insert the plug firmly into the outlet. Do not pull the power cord when disconnecting the plug; always be sure to hold the plug when disconnecting it. Do not overload wall outlets, extension cords, or power strips. Failure to comply with these precautions could result in fire or electric shock.
- Do not place the projector where the cord can be walked on. This may result in fraying or damage to the plug.
- Unplug the projector from the wall outlet and allow to cool before cleaning. Use a dry cloth (or, for stubborn dirt or stains, a moist cloth that has been wrung dry) for cleaning. Do not use liquid or aerosol cleaners, any sprays containing flammable gas, or solvents such as alcohol, paint thinner, or benzene.
- Do not block the slots and openings in the projector case. They provide ventilation and prevent the projector from overheating. Do not operate the projector on a sofa, rug, or other soft surface, or set it on top of loose papers. Do not cover the projector with a blanket, curtain, or tablecloth. If you are setting up the projector near a wall, leave at least 7.9 inches (20 cm) of space between the wall and the projector.
- Do not operate the projector in a closed-in cabinet unless proper ventilation is provided.
- Never allow objects of any kind to enter any openings in the projector. Do not leave objects, especially flammable objects, near the projector. Never spill liquid of any kind into the projector.

- You may need to clean the air filter and vent. A clogged air filter or vent can block ventilation needed to cool the projector. Do not use canned air, or the gases may leave a residue.
- Do not store the projector outdoors for an extended length of time.
- Except as specifically explained in this manual, do not attempt to service this product yourself. Refer all servicing to qualified personnel. Opening or removing covers may expose you to dangerous voltages and other hazards.
- Never open any covers on the projector except as specifically explained in this manual. Never attempt to disassemble or modify the projector. Refer all repairs to qualified service personnel.
- Unplug the projector from the wall outlet and refer servicing to qualified service personnel under the following conditions: if it does not operate normally when you follow the operating instructions, or exhibits a distinct change in performance; if smoke, strange odors, or strange noises come from the projector; if the power cord or plug is damaged or frayed; if liquid or foreign objects get inside the projector, or if it has been exposed to rain or water; if it has been dropped or the housing has been damaged.
- Do not touch the plug during an electrical storm. Otherwise, you may receive an electric shock.
- Unplug the projector when it will not be used for extended periods.
- Do not use the projector where it may be exposed to rain, water, or excessive humidity.
- Do not use or store the projector where it may be exposed to smoke, steam, corrosive gases, excessive dust, vibration, or shock.
- Do not use the projector where flammable or explosive gases may be present.
- Do not use or store the projector or remote control in a hot location, such as near a heater, in direct sunlight, or in a closed vehicle.
- If you use the projector in a country other than where you purchased it, use the correct power cord for that country.
- Do not stand on the projector or place heavy objects on it.
- Do not use the projector outside of the required temperature range below:  
 32 to 122 °F (0 to 50 °C) at an altitude of 4921 feet (1500 m) or less, and 32 to 113 °F (0 to 45 °C) at an altitude of 4925 to 10000 feet (1501 to 3048 m)  
 41 to 104 °F (5 to 40 °C) at an altitude of 7500 feet (2286 m) or less, or 41 to 95 °F (5 to 35 °C) at a higher altitude  
 Doing so may cause an unstable display and could lead to projector damage. Do not use or store the projector where it may be exposed to sudden changes in temperature.

- Do not store the projector outside of the required temperature range of 14 to 140 °F (–10 to 60 °C) or in direct sunlight for long periods of time. Doing so may cause damage to the case.
- Do not place anything that can become warped or damaged by heat near the exhaust vents. Do not bring your hands or face close to the vents while projection is in progress. Do not bring your face close to the projector while it is in use.
- Before you move the projector, make sure its power is turned off, the plug is disconnected from the outlet, and all cables are disconnected.
- Do not place the source of an open flame, such as a lit candle, on or near the projector.
- Do not block the lens during projection using a book or any other object. This could damage the projector or cause a fire.
- Do not modify the power cord. Do not place heavy objects on top of the power cord or bend, twist, or pull it excessively. Keep the power cord away from hot electrical appliances.
- Always attach the lens cover to the lens when not using the projector to prevent the lens from becoming dirty or damaged.

**WARNING:** The cords included with this product contain chemicals, including lead, known to the State of California to cause birth defects or other reproductive harm. ***Wash hands after handling.*** (This notice is provided in accordance with Proposition 65 in Cal. Health & Safety Code § 25249.5 and following.)

[Laser Safety Information](#)

[Laser Light Source Warning](#)

[Restriction of Use](#)

**Parent topic:** [Notices](#)

## Laser Safety Information

This projector is a Class 3R laser product that complies with the IEC60825-1 international standard for lasers. Follow these safety instructions when using the projector.

- If an error occurs in the projector, turn off the power and unplug the projector immediately. Continuing to use the projector could result in an electric shock, fire, or visual impairment. Contact Epson support.
- Do not attempt to disassemble or modify the projector. The projector contains a high-power laser component. Serious injury could result.
- Do not look into the lens during projection. Also, do not look into the lens using optical devices, such as a magnifying glass or telescope. This could cause visual impairment.
- When turning on the projector at a distance using the remote control, make sure no one is looking into the lens.

- Do not allow small children to operate the projector. Children must be accompanied by an adult.
- Do not apply optical devices, such as a magnifying glass or reflector, to the projected image. Using the projector may result in physical harm, fire, or an accident.
- Before using the projector, make sure there is nothing in the area that could reflect the projected image.
- When disposing of the projector, do not disassemble it. Dispose of the projector in accordance with your local or national laws and regulations.

Labels are attached to the projector to indicate it is a Class 3R product and complies with FDA performance standards for laser products except for deviations pursuant to Laser Notice N. 50, dated June 24, 2007:

- **Bottom**

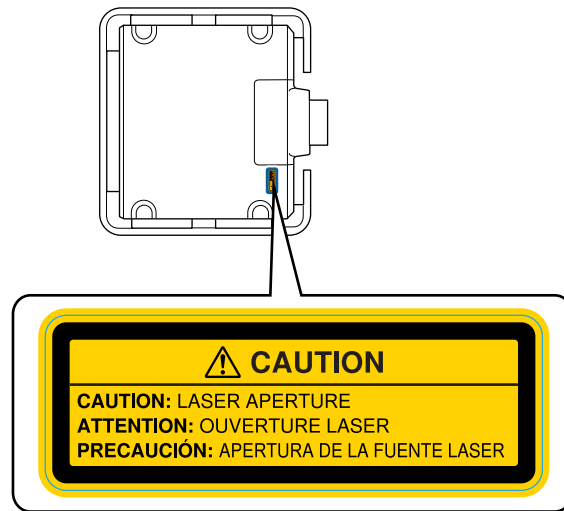

- Back

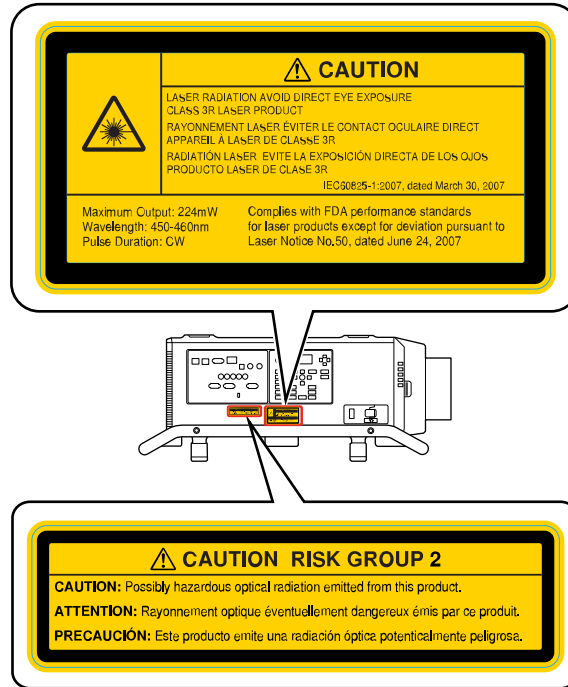

Parent topic: [Important Safety Instructions](#)

## Laser Light Source Warning

Refer to the table here for the Exposure Hazard Values (EHV) in accordance with the IEC62471-2:2009 standard. The EHV indicates the hazard level for objects in front of the light source for 0.25 seconds at a distance of 7.9 inches (20 cm). The higher the value, the greater the hazard level.

Lens	Exposure Hazard Value
ELPLR05	<0.5
ELPLU05	<0.5
ELPLW07	0.6
ELPLM12	0.8

Lens	Exposure Hazard Value
ELPLM13	0.9
ELPLM14	0.9
ELPLL09	0.9
ELPLL10	0.8

Parent topic: [Important Safety Instructions](#)

## Restriction of Use



When this product is used for applications requiring high reliability/safety such as transportation devices related to aviation, rail, marine, automotive; disaster prevention devices; various safety devices; or functional/precision devices, you should use this product only after giving consideration to including fail-safes and redundancies into your design to maintain safety and total system reliability.







Because this product was not intended for use in applications requiring extremely high reliability/safety such as aerospace equipment, main communication equipment, nuclear power control equipment, or medical equipment related to direct medical care, please make your own judgment on this product's suitability after a full evaluation.





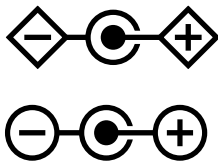

Parent topic: [Important Safety Instructions](#)

## List of Safety Symbols (corresponding to IEC60950-1 A2)

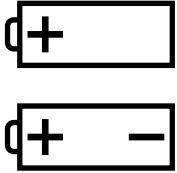

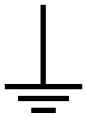





The following table lists the meaning of the safety symbols labeled on the equipment.

No.	Symbol	Approved Standards	Description
1		IEC60417 No.5007	"ON" (power) To indicate connection to the mains.
2		IEC60417 No.5008	"OFF" (power) To indicate disconnection from the mains.

No.	Symbol	Approved Standards	Description
3		IEC60417 No.5009	Stand-by To identify the switch or switch position by means of which part of the equipment is switched on in order to bring it into the stand-by condition.
4		ISO7000 No.0434B IEC3864-B3.1	Caution To identify general caution when using the product.
5		IEC60417 No.5041	Caution, hot surface To indicate that the marked item can be hot and should not be touched without taking care.
6		IEC60417 No.6042 ISO3864-B3.6	Caution, risk of electric shock To identify equipment that has risk of electric shock.
7		IEC60417 No.5957	For indoor use only To identify electrical equipment designed primarily for indoor use.
8		IEC60417 No.5926	Polarity of DC power connector To identify the positive and negative connections (the polarity) on a piece of equipment to which a DC power supply may be connected.
9		IEC60417 No.5001B	Battery, general On battery powered equipment. To identify a device for instance a cover for the battery compartment, or the connector terminals.

No.	Symbol	Approved Standards	Description
10		IEC60417 No.5002	Positioning of cell  To identify the battery holder itself and to identify the positioning of the cell(s) inside the battery holder.
11		IEC60417 No.5019	Protective earth  To identify any terminal which is intended for connection to an external conductor for protection against electric shock in case of a fault, or the terminal of a protective earth electrode.
12		IEC60417 No.5017	Earth  To identify an earth (ground) terminal in cases where neither the symbol No.13 is explicitly required.
13		IEC60417 No.5032	Alternating current  To indicate on the rating plate that the equipment is suitable for alternating current only; to identify relevant terminals.
14		IEC60417 No.5031	Direct current  To indicate on the rating plate that the equipment is suitable for direct current only; to identify relevant terminals.
15		IEC60417 No.5172	Class II equipment  To identify equipment meeting the safety requirements specified for Class II equipment according to IEC 61140.
16		ISO 3864	General prohibition  To identify actions or operations that are prohibited.



No.	Symbol	Approved Standards	Description
17		ISO 3864	Contact prohibition To indicate injury that could occur due to touching a specific part of the equipment.
18		—	Never look into the optical lens while the projector is on.
19		—	To indicate that the marked item don't place anything on projector.
20		ISO3864 IEC60825-1	Caution, laser radiation To indicate the equipment has a laser radiation part.
21		ISO 3864	Disassembly prohibition To indicate a risk of injury, such as electric shock, if the equipment is disassembled.
22		—	Never look into the lens while the LED for lighting is on.
23		IEC60417 No. 5266	Standby, partial standby To indicate that part of the equipment is in the ready status.
24		ISO3864 IEC60417 No. 5057	Caution, movable parts To indicate that you must keep away from movable parts according to protection standards.

Parent topic: [Notices](#)

## FCC Compliance Statement

### For United States Users

This equipment has been tested and found to comply with the limits for a Class A digital device, pursuant to Part 15 of the FCC Rules. These limits are designed to provide reasonable protection against harmful interference when the equipment is operated in a commercial environment. This equipment generates, uses, and can radiate radio frequency energy and, if not installed and used in accordance with the instructions, may cause harmful interference to radio communications. Operation of this equipment in a residential area is likely to cause harmful interference in which case the user will be required to correct the interference at his own expense.

### For Canadian Users

CAN ICES-3(A)/NMB-3(A)

Parent topic: [Notices](#)

## Open Source Software License

### GNU GPL

This projector product includes the open source software programs which apply the GNU General Public License Version 2 or later version ("GPL Programs").

We provide the source code of the GPL Programs until five (5) years after the discontinuation of same model of this projector product.

If you desire to receive the source code of the GPL Programs, contact Epson.

These GPL Programs are WITHOUT ANY WARRANTY; without even the implied warranty of MERCHANTABILITY AND FITNESS FOR A PARTICULAR PURPOSE. See the GNU General Public License for more details.

The list of GPL Programs is as follows and the names of author are described in the source code of the GPL Programs

The list of GPL Programs

- busybox-1.21.0
- iptables-1.4.20
- linux-3.4.49
- patches
- udhcp 0.9.8

- wireless\_tools 29
- dbus-1.6.18
- EPSON original drivers
- Stonestreet One Drivers

The GNU General Public License Version 2 is as follows. You also can see the GNU General Public License Version 2 at <http://www.gnu.org/licenses/>.

## **GNU GENERAL PUBLIC LICENSE**

Version 2, June 1991

Copyright (C) 1989, 1991 Free Software Foundation, Inc., 51 Franklin Street, Fifth Floor, Boston, MA 02110-1301 USA Everyone is permitted to copy and distribute verbatim copies of this license document, but changing it is not allowed.

### **Preamble**

The licenses for most software are designed to take away your freedom to share and change it. By contrast, the GNU General Public License is intended to guarantee your freedom to share and change free software—to make sure the software is free for all its users. This General Public License applies to most of the Free Software Foundation's software and to any other program whose authors commit to using it. (Some other Free Software Foundation software is covered by the GNU Lesser General Public License instead.) You can apply it to your programs, too.

When we speak of free software, we are referring to freedom, not price. Our General Public Licenses are designed to make sure that you have the freedom to distribute copies of free software (and charge for this service if you wish), that you receive source code or can get it if you want it, that you can change the software or use pieces of it in new free programs; and that you know you can do these things.

To protect your rights, we need to make restrictions that forbid anyone to deny you these rights or to ask you to surrender the rights. These restrictions translate to certain responsibilities for you if you distribute copies of the software, or if you modify it.

For example, if you distribute copies of such a program, whether gratis or for a fee, you must give the recipients all the rights that you have. You must make sure that they, too, receive or can get the source code. And you must show them these terms so they know their rights.

We protect your rights with two steps: (1) copyright the software, and (2) offer you this license which gives you legal permission to copy, distribute and/or modify the software.

Also, for each author's protection and ours, we want to make certain that everyone understands that there is no warranty for this free software. If the software is modified by someone else and passed on,

we want its recipients to know that what they have is not the original, so that any problems introduced by others will not reflect on the original authors' reputations.

Finally, any free program is threatened constantly by software patents. We wish to avoid the danger that redistributors of a free program will individually obtain patent licenses, in effect making the program proprietary. To prevent this, we have made it clear that any patent must be licensed for everyone's free use or not licensed at all.

The precise terms and conditions for copying, distribution and modification follow.

## **GNU GENERAL PUBLIC LICENSE TERMS AND CONDITIONS FOR COPYING, DISTRIBUTION AND MODIFICATION**

0. This License applies to any program or other work which contains a notice placed by the copyright holder saying it may be distributed under the terms of this General Public License. The "Program", below, refers to any such program or work, and a "work based on the Program" means either the Program or any derivative work under copyright law: that is to say, a work containing the Program or a portion of it, either verbatim or with modifications and/or translated into another language. (Hereinafter, translation is included without limitation in the term "modification".) Each licensee is addressed as "you".

Activities other than copying, distribution and modification are not covered by this License; they are outside its scope. The act of running the Program is not restricted, and the output from the Program is covered only if its contents constitute a work based on the Program (independent of having been made by running the Program). Whether that is true depends on what the Program does.

1. You may copy and distribute verbatim copies of the Program's source code as you receive it, in any medium, provided that you conspicuously and appropriately publish on each copy an appropriate copyright notice and disclaimer of warranty; keep intact all the notices that refer to this License and to the absence of any warranty; and give any other recipients of the Program a copy of this License along with the Program.

You may charge a fee for the physical act of transferring a copy, and you may at your option offer warranty protection in exchange for a fee.

2. You may modify your copy or copies of the Program or any portion of it, thus forming a work based on the Program, and copy and distribute such modifications or work under the terms of Section 1 above, provided that you also meet all of these conditions:

a) You must cause the modified files to carry prominent notices stating that you changed the files and the date of any change.

b) You must cause any work that you distribute or publish, that in whole or in part contains or is derived from the Program or any part thereof, to be licensed as a whole at no charge to all third parties under the terms of this License.

c) If the modified program normally reads commands interactively when run, you must cause it, when started running for such interactive use in the most ordinary way, to print or display an announcement including an appropriate copyright notice and a notice that there is no warranty (or else, saying that you provide a warranty) and that users may redistribute the program under these conditions, and telling the user how to view a copy of this License. (Exception: if the Program itself is interactive but does not normally print such an announcement, your work based on the Program is not required to print an announcement.)

These requirements apply to the modified work as a whole. If identifiable sections of that work are not derived from the Program, and can be reasonably considered independent and separate works in themselves, then this License, and its terms, do not apply to those sections when you distribute them as separate works. But when you distribute the same sections as part of a whole which is a work based on the Program, the distribution of the whole must be on the terms of this License, whose permissions for other licensees extend to the entire whole, and thus to each and every part regardless of who wrote it.

Thus, it is not the intent of this section to claim rights or contest your rights to work written entirely by you; rather, the intent is to exercise the right to control the distribution of derivative or collective works based on the Program.

In addition, mere aggregation of another work not based on the Program with the Program (or with a work based on the Program) on a volume of a storage or distribution medium does not bring the other work under the scope of this License.

3. You may copy and distribute the Program (or a work based on it, under Section 2) in object code or executable form under the terms of Sections 1 and 2 above provided that you also do one of the following:

a) Accompany it with the complete corresponding machine-readable source code, which must be distributed under the terms of Sections 1 and 2 above on a medium customarily used for software interchange; or,

b) Accompany it with a written offer, valid for at least three years, to give any third party, for a charge no more than your cost of physically performing source distribution, a complete machine-readable copy of the corresponding source code, to be distributed under the terms of Sections 1 and 2 above on a medium customarily used for software interchange; or,

c) Accompany it with the information you received as to the offer to distribute corresponding source code. (This alternative is allowed only for noncommercial distribution and only if you received the program in object code or executable form with such an offer, in accord with Subsection b above.)

The source code for a work means the preferred form of the work for making modifications to it. For an executable work, complete source code means all the source code for all modules it contains, plus any associated interface definition files, plus the scripts used to control compilation and installation of the executable. However, as a special exception, the source code distributed need not include anything that is normally distributed (in either source or binary form) with the major components (compiler, kernel, and

so on) of the operating system on which the executable runs, unless that component itself accompanies the executable.

If distribution of executable or object code is made by offering access to copy from a designated place, then offering equivalent access to copy the source code from the same place counts as distribution of the source code, even though third parties are not compelled to copy the source along with the object code.

4. You may not copy, modify, sublicense, or distribute the Program except as expressly provided under this License. Any attempt otherwise to copy, modify, sublicense or distribute the Program is void, and will automatically terminate your rights under this License. However, parties who have received copies, or rights, from you under this License will not have their licenses terminated so long as such parties remain in full compliance.

5. You are not required to accept this License, since you have not signed it. However, nothing else grants you permission to modify or distribute the Program or its derivative works. These actions are prohibited by law if you do not accept this License. Therefore, by modifying or distributing the Program (or any work based on the Program), you indicate your acceptance of this License to do so, and all its terms and conditions for copying, distributing or modifying the Program or works based on it.

6. Each time you redistribute the Program (or any work based on the Program), the recipient automatically receives a license from the original licensor to copy, distribute or modify the Program subject to these terms and conditions. You may not impose any further restrictions on the recipients' exercise of the rights granted herein. You are not responsible for enforcing compliance by third parties to this License.

7. If, as a consequence of a court judgment or allegation of patent infringement or for any other reason (not limited to patent issues), conditions are imposed on you (whether by court order, agreement or otherwise) that contradict the conditions of this License, they do not excuse you from the conditions of this License. If you cannot distribute so as to satisfy simultaneously your obligations under this License and any other pertinent obligations, then as a consequence you may not distribute the Program at all. For example, if a patent license would not permit royalty-free redistribution of the Program by all those who receive copies directly or indirectly through you, then the only way you could satisfy both it and this License would be to refrain entirely from distribution of the Program.

If any portion of this section is held invalid or unenforceable under any particular circumstance, the balance of the section is intended to apply and the section as a whole is intended to apply in other circumstances.

It is not the purpose of this section to induce you to infringe any patents or other property right claims or to contest validity of any such claims; this section has the sole purpose of protecting the integrity of the free software distribution system, which is implemented by public license practices. Many people have made generous contributions to the wide range of software distributed through that system in reliance on consistent application of that system; it is up to the author/donor to decide if he or she is willing to distribute software through any other system and a licensee cannot impose that choice.

This section is intended to make thoroughly clear what is believed to be a consequence of the rest of this License.

8. If the distribution and/or use of the Program is restricted in certain countries either by patents or by copyrighted interfaces, the original copyright holder who places the Program under this License may add an explicit geographical distribution limitation excluding those countries, so that distribution is permitted only in or among countries not thus excluded. In such case, this License incorporates the limitation as if written in the body of this License.

9. The Free Software Foundation may publish revised and/or new versions of the General Public License from time to time. Such new versions will be similar in spirit to the present version, but may differ in detail to address new problems or concerns.

Each version is given a distinguishing version number. If the Program specifies a version number of this License which applies to it and "any later version", you have the option of following the terms and conditions either of that version or of any later version published by the Free Software Foundation. If the Program does not specify a version number of this License, you may choose any version ever published by the Free Software Foundation.

10. If you wish to incorporate parts of the Program into other free programs whose distribution conditions are different, write to the author to ask for permission. For software which is copyrighted by the Free Software Foundation, write to the Free Software Foundation; we sometimes make exceptions for this. Our decision will be guided by the two goals of preserving the free status of all derivatives of our free software and of promoting the sharing and reuse of software generally.

## **NO WARRANTY**

11. BECAUSE THE PROGRAM IS LICENSED FREE OF CHARGE, THERE IS NO WARRANTY FOR THE PROGRAM, TO THE EXTENT PERMITTED BY APPLICABLE LAW. EXCEPT WHEN OTHERWISE STATED IN WRITING THE COPYRIGHT HOLDERS AND/OR OTHER PARTIES PROVIDE THE PROGRAM "AS IS" WITHOUT WARRANTY OF ANY KIND, EITHER EXPRESSED OR IMPLIED, INCLUDING, BUT NOT LIMITED TO, THE IMPLIED WARRANTIES OF MERCHANTABILITY AND FITNESS FOR A PARTICULAR PURPOSE. THE ENTIRE RISK AS TO THE QUALITY AND PERFORMANCE OF THE PROGRAM IS WITH YOU. SHOULD THE PROGRAM PROVE DEFECTIVE, YOU ASSUME THE COST OF ALL NECESSARY SERVICING, REPAIR OR CORRECTION.

12. IN NO EVENT UNLESS REQUIRED BY APPLICABLE LAW OR AGREED TO IN WRITING WILL ANY COPYRIGHT HOLDER, OR ANY OTHER PARTY WHO MAY MODIFY AND/OR REDISTRIBUTE THE PROGRAM AS PERMITTED ABOVE, BE LIABLE TO YOU FOR DAMAGES, INCLUDING ANY GENERAL, SPECIAL, INCIDENTAL OR CONSEQUENTIAL DAMAGES ARISING OUT OF THE USE OR INABILITY TO USE THE PROGRAM (INCLUDING BUT NOT LIMITED TO LOSS OF DATA OR DATA BEING RENDERED INACCURATE OR LOSSES SUSTAINED BY YOU OR THIRD PARTIES OR A FAILURE OF THE PROGRAM TO OPERATE WITH ANY OTHER PROGRAMS), EVEN IF SUCH HOLDER OR OTHER PARTY HAS BEEN ADVISED OF THE POSSIBILITY OF SUCH DAMAGES.

## END OF TERMS AND CONDITIONS

### **How to Apply These Terms to Your New Programs**

If you develop a new program, and you want it to be of the greatest possible use to the public, the best way to achieve this is to make it free software which everyone can redistribute and change under these terms.

To do so, attach the following notices to the program. It is safest to attach them to the start of each source file to most effectively convey the exclusion of warranty; and each file should have at least the "copyright" line and a pointer to where the full notice is found.

<one line to give the program's name and a brief idea of what it does.>

Copyright (C) <year> <name of author>

This program is free software; you can redistribute it and/or modify it under the terms of the GNU General Public License as published by the Free Software Foundation; either version 2 of the License, or (at your option) any later version.

This program is distributed in the hope that it will be useful, but WITHOUT ANY WARRANTY; without even the implied warranty of MERCHANTABILITY or FITNESS FOR A PARTICULAR PURPOSE. See the GNU General Public License for more details.

You should have received a copy of the GNU General Public License along with this program; if not, write to the Free Software Foundation, Inc., 51 Franklin Street, Fifth Floor, Boston, MA 02110-1301 USA.

Also add information on how to contact you by electronic and paper mail.

If the program is interactive, make it output a short notice like this when it starts in an interactive mode:

Gnomovision version 69, Copyright (C) year name of author Gnomovision comes with ABSOLUTELY NO WARRANTY; for details type `show w'. This is free software, and you are welcome to redistribute it under certain conditions; type `show c' for details.

The hypothetical commands `show w' and `show c' should show the appropriate parts of the General Public License. Of course, the commands you use may be called something other than `show w' and `show c'; they could even be mouse-clicks or menu items--whatever suits your program.

You should also get your employer (if you work as a programmer) or your school, if any, to sign a "copyright disclaimer" for the program, if necessary. Here is a sample; alter the names:

Yoyodyne, Inc., hereby disclaims all copyright interest in the program `Gnomovision' (which makes passes at compilers) written by James Hacker.

<signature of Ty Coon>, 1 April 1989

Ty Coon, President of Vice



This General Public License does not permit incorporating your program into proprietary programs. If your program is a subroutine library, you may consider it more useful to permit linking proprietary applications with the library. If this is what you want to do, use the GNU Lesser General Public License instead of this License.

## **GNU LGPL**

This projector product includes the open source software programs which apply the GNU Lesser General Public License Version 2 or later version ("LGPL Programs").

We provide the source code of the LGPL Programs until five (5) years after the discontinuation of same model of this projector product.

If you desire to receive the source code of the LGPL Programs, please contact Epson.

These LGPL Programs are WITHOUT ANY WARRANTY; without even the implied warranty of MERCHANTABILITY AND FITNESS FOR A PARTICULAR PURPOSE. See the GNU General Public License for more details.

The list of LGPL Programs is as follows and the names of author are described in the source code of the LGPL Programs.

LGPL Programs

- SDL-1.2.15
- SDL-Image
- alsa-lib-1.0.27.2
- libdbus-c++-0.9.0
- gencode-3.4.2
- libnl-3.2.24

The GNU Lesser General Public License Version 2 is as follows. You also can see the GNU Lesser General Public License Version 2 at <http://www.gnu.org/licenses/>.

## **GNU LESSER GENERAL PUBLIC LICENSE**

Version 2.1, February 1999

Copyright (C) 1991, 1999 Free Software Foundation, Inc. 51 Franklin Street, Fifth Floor, Boston, MA 02110-1301 USA Everyone is permitted to copy and distribute verbatim copies of this license document, but changing it is not allowed.

[This is the first released version of the Lesser GPL. It also counts as the successor of the GNU Library Public License, version 2, hence the version number 2.1.]

## Preamble

The licenses for most software are designed to take away your freedom to share and change it. By contrast, the GNU General Public Licenses are intended to guarantee your freedom to share and change free software—to make sure the software is free for all its users.

This license, the Lesser General Public License, applies to some specially designated software packages—typically libraries—of the Free Software Foundation and other authors who decide to use it. You can use it too, but we suggest you first think carefully about whether this license or the ordinary General Public License is the better strategy to use in any particular case, based on the explanations below.

When we speak of free software, we are referring to freedom of use, not price. Our General Public Licenses are designed to make sure that you have the freedom to distribute copies of free software (and charge for this service if you wish); that you receive source code or can get it if you want it; that you can change the software and use pieces of it in new free programs; and that you are informed that you can do these things.

To protect your rights, we need to make restrictions that forbid distributors to deny you these rights or to ask you to surrender these rights. These restrictions translate to certain responsibilities for you if you distribute copies of the library or if you modify it.

For example, if you distribute copies of the library, whether gratis or for a fee, you must give the recipients all the rights that we gave you. You must make sure that they, too, receive or can get the source code. If you link other code with the library, you must provide complete object files to the recipients, so that they can relink them with the library after making changes to the library and recompiling it. And you must show them these terms so they know their rights.

We protect your rights with a two-step method: (1) we copyright the library, and (2) we offer you this license, which gives you legal permission to copy, distribute and/or modify the library.

To protect each distributor, we want to make it very clear that there is no warranty for the free library. Also, if the library is modified by someone else and passed on, the recipients should know that what they have is not the original version, so that the original author's reputation will not be affected by problems that might be introduced by others.

Finally, software patents pose a constant threat to the existence of any free program. We wish to make sure that a company cannot effectively restrict the users of a free program by obtaining a restrictive license from a patent holder. Therefore, we insist that any patent license obtained for a version of the library must be consistent with the full freedom of use specified in this license.

Most GNU software, including some libraries, is covered by the ordinary GNU General Public License. This license, the GNU Lesser General Public License, applies to certain designated libraries, and is quite different from the ordinary General Public License. We use this license for certain libraries in order to permit linking those libraries into non-free programs.

When a program is linked with a library, whether statically or using a shared library, the combination of the two is legally speaking a combined work, a derivative of the original library. The ordinary General Public License therefore permits such linking only if the entire combination fits its criteria of freedom. The Lesser General Public License permits more lax criteria for linking other code with the library.

We call this license the "Lesser" General Public License because it does Less to protect the user's freedom than the ordinary General Public License. It also provides other free software developers Less of an advantage over competing non-free programs. These disadvantages are the reason we use the ordinary General Public License for many libraries. However, the Lesser license provides advantages in certain special circumstances.

For example, on rare occasions, there may be a special need to encourage the widest possible use of a certain library, so that it becomes a de-facto standard. To achieve this, non-free programs must be allowed to use the library. A more frequent case is that a free library does the same job as widely used non-free libraries. In this case, there is little to gain by limiting the free library to free software only, so we use the Lesser General Public License.

In other cases, permission to use a particular library in non-free programs enables a greater number of people to use a large body of free software. For example, permission to use the GNU C Library in non-free programs enables many more people to use the whole GNU operating system, as well as its variant, the GNU/Linux operating system.

Although the Lesser General Public License is Less protective of the users' freedom, it does ensure that the user of a program that is linked with the Library has the freedom and the wherewithal to run that program using a modified version of the Library.

The precise terms and conditions for copying, distribution and modification follow. Pay close attention to the difference between a "work based on the library" and a "work that uses the library". The former contains code derived from the library, whereas the latter must be combined with the library in order to run.

## **GNU LESSER GENERAL PUBLIC LICENSE TERMS AND CONDITIONS FOR COPYING, DISTRIBUTION AND MODIFICATION**

0. This License Agreement applies to any software library or other program which contains a notice placed by the copyright holder or other authorized party saying it may be distributed under the terms of this Lesser General Public License (also called "this License"). Each licensee is addressed as "you".

A "library" means a collection of software functions and/or data prepared so as to be conveniently linked with application programs (which use some of those functions and data) to form executables.

The "Library", below, refers to any such software library or work which has been distributed under these terms. A "work based on the Library" means either the Library or any derivative work under copyright law: that is to say, a work containing the Library or a portion of it, either verbatim or with modifications

and/or translated straightforwardly into another language. (Hereinafter, translation is included without limitation in the term "modification".)

"Source code" for a work means the preferred form of the work for making modifications to it. For a library, complete source code means all the source code for all modules it contains, plus any associated interface definition files, plus the scripts used to control compilation and installation of the library.

Activities other than copying, distribution and modification are not covered by this License; they are outside its scope. The act of running a program using the Library is not restricted, and output from such a program is covered only if its contents constitute a work based on the Library (independent of the use of the Library in a tool for writing it). Whether that is true depends on what the Library does and what the program that uses the Library does.

1. You may copy and distribute verbatim copies of the Library's complete source code as you receive it, in any medium, provided that you conspicuously and appropriately publish on each copy an appropriate copyright notice and disclaimer of warranty; keep intact all the notices that refer to this License and to the absence of any warranty; and distribute a copy of this License along with the Library.

You may charge a fee for the physical act of transferring a copy, and you may at your option offer warranty protection in exchange for a fee.

2. You may modify your copy or copies of the Library or any portion of it, thus forming a work based on the Library, and copy and distribute such modifications or work under the terms of Section 1 above, provided that you also meet all of these conditions:

a) The modified work must itself be a software library.

b) You must cause the files modified to carry prominent notices stating that you changed the files and the date of any change.

c) You must cause the whole of the work to be licensed at no charge to all third parties under the terms of this License.

d) If a facility in the modified Library refers to a function or a table of data to be supplied by an application program that uses the facility, other than as an argument passed when the facility is invoked, then you must make a good faith effort to ensure that, in the event an application does not supply such function or table, the facility still operates, and performs whatever part of its purpose remains meaningful.

(For example, a function in a library to compute square roots has a purpose that is entirely well-defined independent of the application. Therefore, Subsection 2d requires that any application-supplied function or table used by this function must be optional: if the application does not supply it, the square root function must still compute square roots.)

These requirements apply to the modified work as a whole. If identifiable sections of that work are not derived from the Library, and can be reasonably considered independent and separate works in themselves, then this License, and its terms, do not apply to those sections when you distribute them as separate works. But when you distribute the same sections as part of a whole which is a work based on

the Library, the distribution of the whole must be on the terms of this License, whose permissions for other licensees extend to the entire whole, and thus to each and every part regardless of who wrote it.

Thus, it is not the intent of this section to claim rights or contest your rights to work written entirely by you; rather, the intent is to exercise the right to control the distribution of derivative or collective works based on the Library.

In addition, mere aggregation of another work not based on the Library with the Library (or with a work based on the Library) on a volume of a storage or distribution medium does not bring the other work under the scope of this License.

3. You may opt to apply the terms of the ordinary GNU General Public License instead of this License to a given copy of the Library. To do this, you must alter all the notices that refer to this License, so that they refer to the ordinary GNU General Public License, version 2, instead of to this License. (If a newer version than version 2 of the ordinary GNU General Public License has appeared, then you can specify that version instead if you wish.) Do not make any other change in these notices.

Once this change is made in a given copy, it is irreversible for that copy, so the ordinary GNU General Public License applies to all subsequent copies and derivative works made from that copy.

This option is useful when you wish to copy part of the code of the Library into a program that is not a library.

4. You may copy and distribute the Library (or a portion or derivative of it, under Section 2) in object code or executable form under the terms of Sections 1 and 2 above provided that you accompany it with the complete corresponding machine-readable source code, which must be distributed under the terms of Sections 1 and 2 above on a medium customarily used for software interchange.

If distribution of object code is made by offering access to copy from a designated place, then offering equivalent access to copy the source code from the same place satisfies the requirement to distribute the source code, even though third parties are not compelled to copy the source along with the object code.

5. A program that contains no derivative of any portion of the Library, but is designed to work with the Library by being compiled or linked with it, is called a "work that uses the Library". Such a work, in isolation, is not a derivative work of the Library, and therefore falls outside the scope of this License.

However, linking a "work that uses the Library" with the Library creates an executable that is a derivative of the Library (because it contains portions of the Library), rather than a "work that uses the library". The executable is therefore covered by this License. Section 6 states terms for distribution of such executables.

When a "work that uses the Library" uses material from a header file that is part of the Library, the object code for the work may be a derivative work of the Library even though the source code is not. Whether this is true is especially significant if the work can be linked without the Library, or if the work is itself a library. The threshold for this to be true is not precisely defined by law.

If such an object file uses only numerical parameters, data structure layouts and accessors, and small macros and small inline functions (ten lines or less in length), then the use of the object file is unrestricted, regardless of whether it is legally a derivative work. (Executables containing this object code plus portions of the Library will still fall under Section 6.)

Otherwise, if the work is a derivative of the Library, you may distribute the object code for the work under the terms of Section 6. Any executables containing that work also fall under Section 6, whether or not they are linked directly with the Library itself.

6. As an exception to the Sections above, you may also combine or link a "work that uses the Library" with the Library to produce a work containing portions of the Library, and distribute that work under terms of your choice, provided that the terms permit modification of the work for the customer's own use and reverse engineering for debugging such modifications.

You must give prominent notice with each copy of the work that the Library is used in it and that the Library and its use are covered by this License. You must supply a copy of this License. If the work during execution displays copyright notices, you must include the copyright notice for the Library among them, as well as a reference directing the user to the copy of this License. Also, you must do one of these things:

a) Accompany the work with the complete corresponding machine-readable source code for the Library including whatever changes were used in the work (which must be distributed under Sections 1 and 2 above); and, if the work is an executable linked with the Library, with the complete machine-readable "work that uses the Library", as object code and/or source code, so that the user can modify the Library and then relink to produce a modified executable containing the modified Library. (It is understood that the user who changes the contents of definitions files in the Library will not necessarily be able to recompile the application to use the modified definitions.)

b) Use a suitable shared library mechanism for linking with the Library. A suitable mechanism is one that (1) uses at run time a copy of the library already present on the user's computer system, rather than copying library functions into the executable, and (2) will operate properly with a modified version of the library, if the user installs one, as long as the modified version is interface-compatible with the version that the work was made with.

c) Accompany the work with a written offer, valid for at least three years, to give the same user the materials specified in Subsection 6a, above, for a charge no more than the cost of performing this distribution.

d) If distribution of the work is made by offering access to copy from a designated place, offer equivalent access to copy the above specified materials from the same place.

e) Verify that the user has already received a copy of these materials or that you have already sent this user a copy.

For an executable, the required form of the "work that uses the Library" must include any data and utility programs needed for reproducing the executable from it. However, as a special exception, the materials

to be distributed need not include anything that is normally distributed (in either source or binary form) with the major components (compiler, kernel, and so on) of the operating system on which the executable runs, unless that component itself accompanies the executable.

It may happen that this requirement contradicts the license restrictions of other proprietary libraries that do not normally accompany the operating system. Such a contradiction means you cannot use both them and the Library together in an executable that you distribute.

7. You may place library facilities that are a work based on the Library side-by-side in a single library together with other library facilities not covered by this License, and distribute such a combined library, provided that the separate distribution of the work based on the Library and of the other library facilities is otherwise permitted, and provided that you do these two things:

a) Accompany the combined library with a copy of the same work based on the Library, uncombined with any other library facilities. This must be distributed under the terms of the Sections above.

b) Give prominent notice with the combined library of the fact that part of it is a work based on the Library, and explaining where to find the accompanying uncombined form of the same work.

8. You may not copy, modify, sublicense, link with, or distribute the Library except as expressly provided under this License. Any attempt otherwise to copy, modify, sublicense, link with, or distribute the Library is void, and will automatically terminate your rights under this License. However, parties who have received copies, or rights, from you under this License will not have their licenses terminated so long as such parties remain in full compliance.

9. You are not required to accept this License, since you have not signed it. However, nothing else grants you permission to modify or distribute the Library or its derivative works. These actions are prohibited by law if you do not accept this License. Therefore, by modifying or distributing the Library (or any work based on the Library), you indicate your acceptance of this License to do so, and all its terms and conditions for copying, distributing or modifying the Library or works based on it.

10. Each time you redistribute the Library (or any work based on the Library), the recipient automatically receives a license from the original licensor to copy, distribute, link with or modify the Library subject to these terms and conditions. You may not impose any further restrictions on the recipients' exercise of the rights granted herein. You are not responsible for enforcing compliance by third parties with this License.

11. If, as a consequence of a court judgment or allegation of patent infringement or for any other reason (not limited to patent issues), conditions are imposed on you (whether by court order, agreement or otherwise) that contradict the conditions of this License, they do not excuse you from the conditions of this License. If you cannot distribute so as to satisfy simultaneously your obligations under this License and any other pertinent obligations, then as a consequence you may not distribute the Library at all. For example, if a patent license would not permit royalty-free redistribution of the Library by all those who receive copies directly or indirectly through you, then the only way you could satisfy both it and this License would be to refrain entirely from distribution of the Library.

If any portion of this section is held invalid or unenforceable under any particular circumstance, the balance of the section is intended to apply, and the section as a whole is intended to apply in other circumstances.

It is not the purpose of this section to induce you to infringe any patents or other property right claims or to contest validity of any such claims; this section has the sole purpose of protecting the integrity of the free software distribution system which is implemented by public license practices. Many people have made generous contributions to the wide range of software distributed through that system in reliance on consistent application of that system; it is up to the author/donor to decide if he or she is willing to distribute software through any other system and a licensee cannot impose that choice.

This section is intended to make thoroughly clear what is believed to be a consequence of the rest of this License.

12. If the distribution and/or use of the Library is restricted in certain countries either by patents or by copyrighted interfaces, the original copyright holder who places the Library under this License may add an explicit geographical distribution limitation excluding those countries, so that distribution is permitted only in or among countries not thus excluded. In such case, this License incorporates the limitation as if written in the body of this License.

13. The Free Software Foundation may publish revised and/or new versions of the Lesser General Public License from time to time. Such new versions will be similar in spirit to the present version, but may differ in detail to address new problems or concerns.

Each version is given a distinguishing version number. If the Library specifies a version number of this License which applies to it and "any later version", you have the option of following the terms and conditions either of that version or of any later version published by the Free Software Foundation. If the Library does not specify a license version number, you may choose any version ever published by the Free Software Foundation.

14. If you wish to incorporate parts of the Library into other free programs whose distribution conditions are incompatible with these, write to the author to ask for permission. For software which is copyrighted by the Free Software Foundation, write to the Free Software Foundation; we sometimes make exceptions for this. Our decision will be guided by the two goals of preserving the free status of all derivatives of our free software and of promoting the sharing and reuse of software generally.

## **NO WARRANTY**

15. BECAUSE THE LIBRARY IS LICENSED FREE OF CHARGE, THERE IS NO WARRANTY FOR THE LIBRARY, TO THE EXTENT PERMITTED BY APPLICABLE LAW. EXCEPT WHEN OTHERWISE STATED IN WRITING THE COPYRIGHT HOLDERS AND/OR OTHER PARTIES PROVIDE THE LIBRARY "AS IS" WITHOUT WARRANTY OF ANY KIND, EITHER EXPRESSED OR IMPLIED, INCLUDING, BUT NOT LIMITED TO, THE IMPLIED WARRANTIES OF MERCHANTABILITY AND FITNESS FOR A PARTICULAR PURPOSE. THE ENTIRE RISK AS TO THE QUALITY AND



PERFORMANCE OF THE LIBRARY IS WITH YOU. SHOULD THE LIBRARY PROVE DEFECTIVE, YOU ASSUME THE COST OF ALL NECESSARY SERVICING, REPAIR OR CORRECTION.

16. IN NO EVENT UNLESS REQUIRED BY APPLICABLE LAW OR AGREED TO IN WRITING WILL ANY COPYRIGHT HOLDER, OR ANY OTHER PARTY WHO MAY MODIFY AND/OR REDISTRIBUTE THE LIBRARY AS PERMITTED ABOVE, BE LIABLE TO YOU FOR DAMAGES, INCLUDING ANY GENERAL, SPECIAL, INCIDENTAL OR CONSEQUENTIAL DAMAGES ARISING OUT OF THE USE OR INABILITY TO USE THE LIBRARY (INCLUDING BUT NOT LIMITED TO LOSS OF DATA OR DATA BEING RENDERED INACCURATE OR LOSSES SUSTAINED BY YOU OR THIRD PARTIES OR A FAILURE OF THE LIBRARY TO OPERATE WITH ANY OTHER SOFTWARE), EVEN IF SUCH HOLDER OR OTHER PARTY HAS BEEN ADVISED OF THE POSSIBILITY OF SUCH DAMAGES.

END OF TERMS AND CONDITIONS

### **How to Apply These Terms to Your New Libraries**

If you develop a new library, and you want it to be of the greatest possible use to the public, we recommend making it free software that everyone can redistribute and change. You can do so by permitting redistribution under these terms (or, alternatively, under the terms of the ordinary General Public License).

To apply these terms, attach the following notices to the library. It is safest to attach them to the start of each source file to most effectively convey the exclusion of warranty; and each file should have at least the "copyright" line and a pointer to where the full notice is found.

<one line to give the library's name and a brief idea of what it does.>

Copyright (C) <year> <name of author>

This library is free software; you can redistribute it and/or modify it under the terms of the GNU Lesser General Public License as published by the Free Software Foundation; either version 2.1 of the License, or (at your option) any later version.

This library is distributed in the hope that it will be useful, but WITHOUT ANY WARRANTY; without even the implied warranty of MERCHANTABILITY or FITNESS FOR A PARTICULAR PURPOSE. See the GNU Lesser General Public License for more details.

You should have received a copy of the GNU Lesser General Public License along with this library; if not, write to the Free Software Foundation, Inc., 51 Franklin Street, Fifth Floor, Boston, MA 02110-1301 USA

Also add information on how to contact you by electronic and paper mail.

You should also get your employer (if you work as a programmer) or your school, if any, to sign a "copyright disclaimer" for the library, if necessary. Here is a sample; alter the names:

Yoyodyne, Inc., hereby disclaims all copyright interest in the library `Frob' (a library for tweaking knobs) written by James Random Hacker.

<signature of Ty Coon>, 1 April 1990

Ty Coon, President of Vice

That's all there is to it!

## **libjpeg**

This projector product includes the open source software program "libjpeg" which applies the terms and conditions provided by owner of the copyright to the "libjpeg".

The "libjpeg" are WITHOUT ANY WARRANTY; without even the implied warranty of MERCHANTABILITY AND FITNESS FOR A PARTICULAR PURPOSE.

List of libjpeg programs

- libjpeg-6b

License terms of conditions of each program which are provided by owner of the copyright to the "libjpeg" are as follows.

Copyright (C) 1994-1997, Thomas G. Lane. This file is part of the Independent JPEG Group's software. For conditions of distribution and use, see the accompanying README file.

This distribution contains the sixth public release of the Independent JPEG Group's free JPEG software. You are welcome to redistribute this software and to use it for any purpose, subject to the conditions under LEGAL ISSUES, below.

## **LEGAL ISSUES**

=====

In plain English:

1. We don't promise that this software works. (But if you find any bugs, please let us know!)
2. You can use this software for whatever you want. You don't have to pay us.
3. You may not pretend that you wrote this software. If you use it in a program, you must acknowledge somewhere in your documentation that you've used the IJG code.

In legalese:

The authors make NO WARRANTY or representation, either express or implied, with respect to this software, its quality, accuracy, merchantability, or fitness for a particular purpose. This software is provided "AS IS", and you, its user, assume the entire risk as to its quality and accuracy.

This software is copyright (C) 1991-1998, Thomas G. Lane. All Rights Reserved except as specified below.

Permission is hereby granted to use, copy, modify, and distribute this software (or portions thereof) for any purpose, without fee, subject to these conditions:

(1) If any part of the source code for this software is distributed, then this README file must be included, with this copyright and no-warranty notice unaltered; and any additions, deletions, or changes to the original files must be clearly indicated in accompanying documentation.

(2) If only executable code is distributed, then the accompanying documentation must state that "this software is based in part on the work of the Independent JPEG Group".

(3) Permission for use of this software is granted only if the user accepts full responsibility for any undesirable consequences; the authors accept NO LIABILITY for damages of any kind.

These conditions apply to any software derived from or based on the IJG code, not just to the unmodified library. If you use our work, you ought to acknowledge us.

Permission is NOT granted for the use of any IJG author's name or company name in advertising or publicity relating to this software or products derived from it. This software may be referred to only as "the Independent JPEG Group's software".

We specifically permit and encourage the use of this software as the basis of commercial products, provided that all warranty or liability claims are assumed by the product vendor.

ansi2knr.c is included in this distribution by permission of L. Peter Deutsch, sole proprietor of its copyright holder, Aladdin Enterprises of Menlo Park, CA. ansi2knr.c is NOT covered by the above copyright and conditions, but instead by the usual distribution terms of the Free Software Foundation; principally, that you must include source code if you redistribute it. (See the file ansi2knr.c for full details.) However, since ansi2knr.c is not needed as part of any program generated from the IJG code, this does not limit you more than the foregoing paragraphs do.

The Unix configuration script "configure" was produced with GNU Autoconf. It is copyright by the Free Software Foundation but is freely distributable. The same holds for its supporting scripts (config.guess, config.sub, ltconfig, ltmain.sh). Another support script, install-sh, is copyright by M.I.T. but is also freely distributable.

It appears that the arithmetic coding option of the JPEG spec is covered by patents owned by IBM, AT&T, and Mitsubishi. Hence arithmetic coding cannot legally be used without obtaining one or more licenses. For this reason, support for arithmetic coding has been removed from the free JPEG software. (Since arithmetic coding provides only a marginal gain over the unpatented Huffman mode, it is unlikely that very many implementations will support it.) So far as we are aware, there are no patent restrictions on the remaining code.

The IJG distribution formerly included code to read and write GIF files. To avoid entanglement with the Unisys LZW patent, GIF reading support has been removed altogether, and the GIF writer has been

simplified to produce "uncompressed GIFs". This technique does not use the LZW algorithm; the resulting GIF files are larger than usual, but are readable by all standard GIF decoders.

We are required to state that "The Graphics Interchange Format(c) is the Copyright property of CompuServe Incorporated. GIF(sm) is a Service Mark property of CompuServe Incorporated."

## **libpng**

This projector product includes the open source software program "libpng" which applies the terms and conditions provided by owner of the copyright to the "libpng".

The "libpng" are WITHOUT ANY WARRANTY; without even the implied warranty of MERCHANTABILITY AND FITNESS FOR A PARTICULAR PURPOSE.

List of libpng programs

- libpng-1.2.49

License terms of conditions of each program which are provided by owner of the copyright to the "libpng" are as follows.

This copy of the libpng notices is provided for your convenience. In case of any discrepancy between this copy and the notices in the file png.h that is included in the libpng distribution, the latter shall prevail.

COPYRIGHT NOTICE, DISCLAIMER, and LICENSE:

If you modify libpng you may insert additional notices immediately following this sentence.

This code is released under the libpng license.

libpng versions 1.2.6, August 15, 2004, through 1.2.49, March 29, 2012, are Copyright (c) 2004, 2006-2009 Glenn Randers-Pehrson, and are distributed according to the same disclaimer and license as libpng-1.2.5 with the following individual added to the list of Contributing Authors

Cosmin Truta

libpng versions 1.0.7, July 1, 2000, through 1.2.5 - October 3, 2002, are Copyright (c) 2000-2002 Glenn Randers-Pehrson, and are distributed according to the same disclaimer and license as libpng-1.0.6 with the following individuals added to the list of Contributing Authors

Simon-Pierre Cadieux

Eric S. Raymond

Gilles Vollant

and with the following additions to the disclaimer:

There is no warranty against interference with your enjoyment of the library or against infringement. There is no warranty that our efforts or the library will fulfill any of your particular purposes or needs. This

library is provided with all faults, and the entire risk of satisfactory quality, performance, accuracy, and effort is with the user.

libpng versions 0.97, January 1998, through 1.0.6, March 20, 2000, are Copyright (c) 1998, 1999 Glenn Randers-Pehrson, and are distributed according to the same disclaimer and license as libpng-0.96, with the following individuals added to the list of Contributing Authors:

Tom Lane

Glenn Randers-Pehrson

Willem van Schaik

libpng versions 0.89, June 1996, through 0.96, May 1997, are Copyright (c) 1996, 1997 Andreas Dilger Distributed according to the same disclaimer and license as libpng-0.88, with the following individuals added to the list of Contributing Authors:

John Bowler

Kevin Bracey

Sam Bushell

Magnus Holmgren

Greg Roelofs

Tom Tanner

libpng versions 0.5, May 1995, through 0.88, January 1996, are Copyright (c) 1995, 1996 Guy Eric Schalnat, Group 42, Inc.

For the purposes of this copyright and license, "Contributing Authors" is defined as the following set of individuals:

Andreas Dilger

Dave Martindale

Guy Eric Schalnat

Paul Schmidt

Tim Wegner

The PNG Reference Library is supplied "AS IS". The Contributing Authors and Group 42, Inc. disclaim all warranties, expressed or implied, including, without limitation, the warranties of merchantability and of fitness for any purpose. The Contributing Authors and Group 42, Inc. assume no liability for direct, indirect, incidental, special, exemplary, or consequential damages, which may result from the use of the PNG Reference Library, even if advised of the possibility of such damage.

Permission is hereby granted to use, copy, modify, and distribute this source code, or portions hereof, for any purpose, without fee, subject to the following restrictions:

1. The origin of this source code must not be misrepresented.
2. Altered versions must be plainly marked as such and must not be misrepresented as being the original source.
3. This Copyright notice may not be removed or altered from any source or altered source distribution.

The Contributing Authors and Group 42, Inc. specifically permit, without fee, and encourage the use of this source code as a component to supporting the PNG file format in commercial products. If you use this source code in a product, acknowledgment is not required but would be appreciated.

A "png\_get\_copyright" function is available, for convenient use in "about" boxes and the like:

```
printf("%s",png_get_copyright(NULL));
```

Also, the PNG logo (in PNG format, of course) is supplied in the files "pngbar.png" and "pngbar.jpg" (88x31) and "pngnow.png" (98x31).

Libpng is OSI Certified Open Source Software. OSI Certified Open Source is a certification mark of the Open Source Initiative.

Glenn Randers-Pehrson

glennrp at users.sourceforge.net

March 29, 2012

### **zlib**

This projector product includes the open source software program "zlib" which applies the terms and conditions provided by owner of the copyright to the "zlib".

The "zlib" are WITHOUT ANY WARRANTY; without even the implied warranty of MERCHANTABILITY AND FITNESS FOR A PARTICULAR PURPOSE.

List of zlib programs

- zlib-1.1.4

License terms of conditions of each program which are provided by owner of the copyright to the "zlib" are as follows.

Copyright notice:

(C) 1995-1998 Jean-loup Gailly and Mark Adler

This software is provided 'as-is', without any express or implied warranty. In no event will the authors be held liable for any damages arising from the use of this software.

Permission is granted to anyone to use this software for any purpose, including commercial applications, and to alter it and redistribute it freely, subject to the following restrictions:

1. The origin of this software must not be misrepresented; you must not claim that you wrote the original software. If you use this software in a product, an acknowledgment in the product documentation would be appreciated but is not required.
2. Altered source versions must be plainly marked as such, and must not be misrepresented as being the original software.
3. This notice may not be removed or altered from any source distribution.

Jean-loup Gailly

jloup@gzip.org

Mark Adler

madler@alumni.caltech.edu

If you use the zlib library in a product, we would appreciate \*not\* receiving lengthy legal documents to sign. The sources are provided for free but without warranty of any kind. The library has been entirely written by Jean-loup Gailly and Mark Adler; it does not include third-party code.

If you redistribute modified sources, we would appreciate that you include in the file ChangeLog history information documenting your changes.

### **aes-src-29-04-09**

This projector product includes the open source software program "aes-src-29-04-09" which applies the terms and conditions provided by owner of the copyright to the "aes-src-29-04-09".

The "aes-src-29-04-09" are WITHOUT ANY WARRANTY; without even the implied warranty of MERCHANTABILITY AND FITNESS FOR A PARTICULAR PURPOSE.

List of aes-src-29-04-09 programs

- aes-src-29-04-09

License terms of conditions of each program which are provided by owner of the copyright to the "aes-src-29-04-09" are as follows.

Copyright (c) 1998-2008, Brian Gladman, Worcester, UK. All rights reserved.

### LICENSE TERMS

The redistribution and use of this software (with or without changes) is allowed without the payment of fees or royalties provided that:

1. source code distributions include the above copyright notice, this list of conditions and the following disclaimer;

2. binary distributions include the above copyright notice, this list of conditions and the following disclaimer in their documentation;

3. the name of the copyright holder is not used to endorse products built using this software without specific written permission.

#### DISCLAIMER

This software is provided 'as is' with no explicit or implied warranties in respect of its properties, including, but not limited to, correctness and/or fitness for purpose.

#### **newlib**

This projector product includes the open source software program "newlib" which applies the terms and conditions provided by owner of the copyright to the "newlib".

The "newlib" are WITHOUT ANY WARRANTY; without even the implied warranty of MERCHANTABILITY AND FITNESS FOR A PARTICULAR PURPOSE.

List of newlib programs

- newlib 1.17.0

License terms of conditions of each program which are provided by owner of the copyright to the "newlib" are as follows.

The newlib subdirectory is a collection of software from several sources.

Each file may have its own copyright/license that is embedded in the source file. Unless otherwise noted in the body of the source file(s), the following copyright notices will apply to the contents of the newlib subdirectory:

(1) Red Hat Incorporated

Copyright (c) 1994-2007 Red Hat, Inc. All rights reserved.

This copyrighted material is made available to anyone wishing to use, modify, copy, or redistribute it subject to the terms and conditions of the BSD License. This program is distributed in the hope that it will be useful, but WITHOUT ANY WARRANTY expressed or implied, including the implied warranties of MERCHANTABILITY or FITNESS FOR A PARTICULAR PURPOSE. A copy of this license is available at <http://www.opensource.org/licenses>. Any Red Hat trademarks that are incorporated in the source code or documentation are not subject to the BSD License and may only be used or replicated with the express permission of Red Hat, Inc.

(2) University of California, Berkeley

Copyright (c) 1981-2000 The Regents of the University of California.

All rights reserved.



Redistribution and use in source and binary forms, with or without modification, are permitted provided that the following conditions are met:

\* Redistributions of source code must retain the above copyright notice, this list of conditions and the following disclaimer.

\* Redistributions in binary form must reproduce the above copyright notice, this list of conditions and the following disclaimer in the documentation and/or other materials provided with the distribution.

\* Neither the name of the University nor the names of its contributors may be used to endorse or promote products derived from this software without specific prior written permission.

THIS SOFTWARE IS PROVIDED BY THE COPYRIGHT HOLDERS AND CONTRIBUTORS "AS IS" AND ANY EXPRESS OR IMPLIED WARRANTIES, INCLUDING, BUT NOT LIMITED TO, THE IMPLIED WARRANTIES OF MERCHANTABILITY AND FITNESS FOR A PARTICULAR PURPOSE ARE DISCLAIMED. IN NO EVENT SHALL THE COPYRIGHT OWNER OR CONTRIBUTORS BE LIABLE FOR ANY DIRECT, INDIRECT, INCIDENTAL, SPECIAL, EXEMPLARY, OR CONSEQUENTIAL DAMAGES (INCLUDING, BUT NOT LIMITED TO, PROCUREMENT OF SUBSTITUTE GOODS OR SERVICES; LOSS OF USE, DATA, OR PROFITS; OR BUSINESS INTERRUPTION) HOWEVER CAUSED AND ON ANY THEORY OF LIABILITY, WHETHER IN CONTRACT, STRICT LIABILITY, OR TORT (INCLUDING NEGLIGENCE OR OTHERWISE) ARISING IN ANY WAY OUT OF THE USE OF THIS SOFTWARE, EVEN IF ADVISED OF THE POSSIBILITY OF SUCH DAMAGE.

(3) David M. Gay (AT&T 1991, Lucent 1998)

The author of this software is David M. Gay.

Copyright (c) 1991 by AT&T.

Permission to use, copy, modify, and distribute this software for any purpose without fee is hereby granted, provided that this entire notice is included in all copies of any software which is or includes a copy or modification of this software and in all copies of the supporting documentation for such software.

THIS SOFTWARE IS BEING PROVIDED "AS IS", WITHOUT ANY EXPRESS OR IMPLIED WARRANTY. IN PARTICULAR, NEITHER THE AUTHOR NOR AT&T MAKES ANY REPRESENTATION OR WARRANTY OF ANY KIND CONCERNING THE MERCHANTABILITY OF THIS SOFTWARE OR ITS FITNESS FOR ANY PARTICULAR PURPOSE.

-----

The author of this software is David M. Gay.

Copyright (C) 1998-2001 by Lucent Technologies

All Rights Reserved

Permission to use, copy, modify, and distribute this software and its documentation for any purpose and without fee is hereby granted, provided that the above copyright notice appear in all copies and that both

that the copyright notice and this permission notice and warranty disclaimer appear in supporting documentation, and that the name of Lucent or any of its entities not be used in advertising or publicity pertaining to distribution of the software without specific, written prior permission.

LUCENT DISCLAIMS ALL WARRANTIES WITH REGARD TO THIS SOFTWARE, INCLUDING ALL IMPLIED WARRANTIES OF MERCHANTABILITY AND FITNESS. IN NO EVENT SHALL LUCENT OR ANY OF ITS ENTITIES BE LIABLE FOR ANY SPECIAL, INDIRECT OR CONSEQUENTIAL DAMAGES OR ANY DAMAGES WHATSOEVER RESULTING FROM LOSS OF USE, DATA OR PROFITS, WHETHER IN AN ACTION OF CONTRACT, NEGLIGENCE OR OTHER TORTIOUS ACTION, ARISING OUT OF OR IN CONNECTION WITH THE USE OR PERFORMANCE OF THIS SOFTWARE.

(4) Advanced Micro Devices

Copyright 1989, 1990 Advanced Micro Devices, Inc.

This software is the property of Advanced Micro Devices, Inc (AMD) which specifically grants the user the right to modify, use and distribute this software provided this notice is not removed or altered. All other rights are reserved by AMD.

AMD MAKES NO WARRANTY OF ANY KIND, EXPRESS OR IMPLIED, WITH REGARD TO THIS SOFTWARE. IN NO EVENT SHALL AMD BE LIABLE FOR INCIDENTAL OR CONSEQUENTIAL DAMAGES IN CONNECTION WITH OR ARISING FROM THE FURNISHING, PERFORMANCE, OR USE OF THIS SOFTWARE.

So that all may benefit from your experience, please report any problems or suggestions about this software to the 29K Technical Support Center at 800-29-29-AMD (800-292-9263) in the USA, or 0800-89-1131 in the UK, or 0031-11-1129 in Japan, toll free. The direct dial number is 512-462-4118.

Advanced Micro Devices, Inc.

29K Support Products

Mail Stop 573

5900 E. Ben White Blvd.

Austin, TX 78741

800-292-9263

(5) C.W. Sandmann

Copyright (C) 1993 C.W. Sandmann

This file may be freely distributed as long as the author's name remains.

(6) Eric Backus

(C) Copyright 1992 Eric Backus

This software may be used freely so long as this copyright notice is left intact. There is no warrantee on this software.

(7) Sun Microsystems

Copyright (C) 1993 by Sun Microsystems, Inc. All rights reserved.

Developed at SunPro, a Sun Microsystems, Inc. business. Permission to use, copy, modify, and distribute this software is freely granted, provided that this notice is preserved.

(8) Hewlett Packard

(c) Copyright 1986 HEWLETT-PACKARD COMPANY

To anyone who acknowledges that this file is provided "AS IS" without any express or implied warranty: permission to use, copy, modify, and distribute this file for any purpose is hereby granted without fee, provided that the above copyright notice and this notice appears in all copies, and that the name of Hewlett-Packard Company not be used in advertising or publicity pertaining to distribution of the software without specific, written prior permission. Hewlett-Packard Company makes no representations about the suitability of this software for any purpose.

(9) Hans-Peter Nilsson

Copyright (C) 2001 Hans-Peter Nilsson

Permission to use, copy, modify, and distribute this software is freely granted, provided that the above copyright notice, this notice and the following disclaimer are preserved with no changes.

THIS SOFTWARE IS PROVIDED "AS IS" AND WITHOUT ANY EXPRESS OR IMPLIED WARRANTIES, INCLUDING, WITHOUT LIMITATION, THE IMPLIED WARRANTIES OF MERCHANTABILITY AND FITNESS FOR A PARTICULAR PURPOSE.

(11) Christopher G. Demetriou

Copyright (c) 2001 Christopher G. Demetriou

All rights reserved.

Redistribution and use in source and binary forms, with or without modification, are permitted provided that the following conditions are met:

1. Redistributions of source code must retain the above copyright notice, this list of conditions and the following disclaimer.
2. Redistributions in binary form must reproduce the above copyright notice, this list of conditions and the following disclaimer in the documentation and/or other materials provided with the distribution.
3. The name of the author may not be used to endorse or promote products derived from this software without specific prior written permission.

THIS SOFTWARE IS PROVIDED BY THE AUTHOR "AS IS" AND ANY EXPRESS OR IMPLIED WARRANTIES, INCLUDING, BUT NOT LIMITED TO, THE IMPLIED WARRANTIES OF MERCHANTABILITY AND FITNESS FOR A PARTICULAR PURPOSE ARE DISCLAIMED. IN NO EVENT SHALL THE AUTHOR BE LIABLE FOR ANY DIRECT, INDIRECT, INCIDENTAL, SPECIAL, EXEMPLARY, OR CONSEQUENTIAL DAMAGES (INCLUDING, BUT NOT LIMITED TO, PROCUREMENT OF SUBSTITUTE GOODS OR SERVICES; LOSS OF USE, DATA, OR PROFITS; OR BUSINESS INTERRUPTION) HOWEVER CAUSED AND ON ANY THEORY OF LIABILITY, WHETHER IN CONTRACT, STRICT LIABILITY, OR TORT (INCLUDING NEGLIGENCE OR OTHERWISE) ARISING IN ANY WAY OUT OF THE USE OF THIS SOFTWARE, EVEN IF ADVISED OF THE POSSIBILITY OF SUCH DAMAGE.

(12) SuperH, Inc.

Copyright 2002 SuperH, Inc. All rights reserved

This software is the property of SuperH, Inc (SuperH) which specifically grants the user the right to modify, use and distribute this software provided this notice is not removed or altered. All other rights are reserved by SuperH.

SUPERH MAKES NO WARRANTY OF ANY KIND, EXPRESS OR IMPLIED, WITH REGARD TO THIS SOFTWARE. IN NO EVENT SHALL SUPERH BE LIABLE FOR INDIRECT, SPECIAL, INCIDENTAL OR CONSEQUENTIAL DAMAGES IN CONNECTION WITH OR ARISING FROM THE FURNISHING, PERFORMANCE, OR USE OF THIS SOFTWARE.

So that all may benefit from your experience, please report any problems or suggestions about this software to the SuperH Support Center via e-mail at [softwaresupport@superh.com](mailto:softwaresupport@superh.com).

SuperH, Inc.

405 River Oaks Parkway

San Jose

CA 95134

USA

(13) Royal Institute of Technology

Copyright (c) 1999 Kungliga Tekniska Högskolan (Royal Institute of Technology, Stockholm, Sweden).

All rights reserved.

Redistribution and use in source and binary forms, with or without modification, are permitted provided that the following conditions are met:

1. Redistributions of source code must retain the above copyright notice, this list of conditions and the following disclaimer.

2. Redistributions in binary form must reproduce the above copyright notice, this list of conditions and the following disclaimer in the documentation and/or other materials provided with the distribution.

3. Neither the name of KTH nor the names of its contributors may be used to endorse or promote products derived from this software without specific prior written permission.

THIS SOFTWARE IS PROVIDED BY KTH AND ITS CONTRIBUTORS "AS IS" AND ANY EXPRESS OR IMPLIED WARRANTIES, INCLUDING, BUT NOT LIMITED TO, THE IMPLIED WARRANTIES OF MERCHANTABILITY AND FITNESS FOR A PARTICULAR PURPOSE ARE DISCLAIMED. IN NO EVENT SHALL KTH OR ITS CONTRIBUTORS BE LIABLE FOR ANY DIRECT, INDIRECT, INCIDENTAL, SPECIAL, EXEMPLARY, OR CONSEQUENTIAL DAMAGES (INCLUDING, BUT NOT LIMITED TO, PROCUREMENT OF SUBSTITUTE GOODS OR SERVICES; LOSS OF USE, DATA, OR PROFITS; OR BUSINESS INTERRUPTION) HOWEVER CAUSED AND ON ANY THEORY OF LIABILITY, WHETHER IN CONTRACT, STRICT LIABILITY, OR TORT (INCLUDING NEGLIGENCE OR OTHERWISE) ARISING IN ANY WAY OUT OF THE USE OF THIS SOFTWARE, EVEN IF ADVISED OF THE POSSIBILITY OF SUCH DAMAGE.

(14) Alexey Zelkin

Copyright (c) 2000, 2001 Alexey Zelkin <phantom@FreeBSD.org>

All rights reserved.

Redistribution and use in source and binary forms, with or without modification, are permitted provided that the following conditions are met:

1. Redistributions of source code must retain the above copyright notice, this list of conditions and the following disclaimer.

2. Redistributions in binary form must reproduce the above copyright notice, this list of conditions and the following disclaimer in the documentation and/or other materials provided with the distribution.

THIS SOFTWARE IS PROVIDED BY THE AUTHOR AND CONTRIBUTORS "AS IS" AND ANY EXPRESS OR IMPLIED WARRANTIES, INCLUDING, BUT NOT LIMITED TO, THE IMPLIED WARRANTIES OF MERCHANTABILITY AND FITNESS FOR A PARTICULAR PURPOSE ARE DISCLAIMED. IN NO EVENT SHALL THE AUTHOR OR CONTRIBUTORS BE LIABLE FOR ANY DIRECT, INDIRECT, INCIDENTAL, SPECIAL, EXEMPLARY, OR CONSEQUENTIAL DAMAGES (INCLUDING, BUT NOT LIMITED TO, PROCUREMENT OF SUBSTITUTE GOODS OR SERVICES; LOSS OF USE, DATA, OR PROFITS; OR BUSINESS INTERRUPTION) HOWEVER CAUSED AND ON ANY THEORY OF LIABILITY, WHETHER IN CONTRACT, STRICT LIABILITY, OR TORT (INCLUDING NEGLIGENCE OR OTHERWISE) ARISING IN ANY WAY OUT OF THE USE OF THIS SOFTWARE, EVEN IF ADVISED OF THE POSSIBILITY OF SUCH DAMAGE.

(15) Andrey A. Chernov

Copyright (C) 1997 by Andrey A. Chernov, Moscow, Russia.

All rights reserved.

Redistribution and use in source and binary forms, with or without modification, are permitted provided that the following conditions are met:

1. Redistributions of source code must retain the above copyright notice, this list of conditions and the following disclaimer.
2. Redistributions in binary form must reproduce the above copyright notice, this list of conditions and the following disclaimer in the documentation and/or other materials provided with the distribution.

THIS SOFTWARE IS PROVIDED BY THE AUTHOR "AS IS" AND ANY EXPRESS OR IMPLIED WARRANTIES, INCLUDING, BUT NOT LIMITED TO, THE IMPLIED WARRANTIES OF MERCHANTABILITY AND FITNESS FOR A PARTICULAR PURPOSE ARE DISCLAIMED. IN NO EVENT SHALL THE REGENTS OR CONTRIBUTORS BE LIABLE FOR ANY DIRECT, INDIRECT, INCIDENTAL, SPECIAL, EXEMPLARY, OR CONSEQUENTIAL DAMAGES (INCLUDING, BUT NOT LIMITED TO, PROCUREMENT OF SUBSTITUTE GOODS OR SERVICES; LOSS OF USE, DATA, OR PROFITS; OR BUSINESS INTERRUPTION) HOWEVER CAUSED AND ON ANY THEORY OF LIABILITY, WHETHER IN CONTRACT, STRICT LIABILITY, OR TORT (INCLUDING NEGLIGENCE OR OTHERWISE) ARISING IN ANY WAY OUT OF THE USE OF THIS SOFTWARE, EVEN IF ADVISED OF THE POSSIBILITY OF SUCH DAMAGE.

(16) FreeBSD

Copyright (c) 1997-2002 FreeBSD Project.

All rights reserved.

Redistribution and use in source and binary forms, with or without modification, are permitted provided that the following conditions are met:

1. Redistributions of source code must retain the above copyright notice, this list of conditions and the following disclaimer.
2. Redistributions in binary form must reproduce the above copyright notice, this list of conditions and the following disclaimer in the documentation and/or other materials provided with the distribution.

THIS SOFTWARE IS PROVIDED BY THE AUTHOR AND CONTRIBUTORS "AS IS" AND ANY EXPRESS OR IMPLIED WARRANTIES, INCLUDING, BUT NOT LIMITED TO, THE IMPLIED WARRANTIES OF MERCHANTABILITY AND FITNESS FOR A PARTICULAR PURPOSE ARE DISCLAIMED. IN NO EVENT SHALL THE AUTHOR OR CONTRIBUTORS BE LIABLE FOR ANY DIRECT, INDIRECT, INCIDENTAL, SPECIAL, EXEMPLARY, OR CONSEQUENTIAL DAMAGES (INCLUDING, BUT NOT LIMITED TO, PROCUREMENT OF SUBSTITUTE GOODS OR SERVICES; LOSS OF USE, DATA, OR PROFITS; OR BUSINESS INTERRUPTION) HOWEVER CAUSED AND ON ANY THEORY OF LIABILITY, WHETHER IN CONTRACT, STRICT LIABILITY, OR TORT (INCLUDING NEGLIGENCE OR OTHERWISE) ARISING IN ANY WAY OUT OF THE USE OF THIS SOFTWARE, EVEN IF ADVISED OF THE POSSIBILITY OF SUCH DAMAGE.

(17) S. L. Moshier

Author: S. L. Moshier.

Copyright (c) 1984,2000 S.L. Moshier

Permission to use, copy, modify, and distribute this software for any purpose without fee is hereby granted, provided that this entire notice is included in all copies of any software which is or includes a copy or modification of this software and in all copies of the supporting documentation for such software.

THIS SOFTWARE IS BEING PROVIDED "AS IS", WITHOUT ANY EXPRESS OR IMPLIED WARRANTY. IN PARTICULAR, THE AUTHOR MAKES NO REPRESENTATION OR WARRANTY OF ANY KIND CONCERNING THE MERCHANTABILITY OF THIS SOFTWARE OR ITS FITNESS FOR ANY PARTICULAR PURPOSE.

(18) Citrus Project

Copyright (c)1999 Citrus Project,

All rights reserved.

Redistribution and use in source and binary forms, with or without modification, are permitted provided that the following conditions are met:

1. Redistributions of source code must retain the above copyright notice, this list of conditions and the following disclaimer.
2. Redistributions in binary form must reproduce the above copyright notice, this list of conditions and the following disclaimer in the documentation and/or other materials provided with the distribution.

THIS SOFTWARE IS PROVIDED BY THE AUTHOR AND CONTRIBUTORS "AS IS" AND ANY EXPRESS OR IMPLIED WARRANTIES, INCLUDING, BUT NOT LIMITED TO, THE IMPLIED WARRANTIES OF MERCHANTABILITY AND FITNESS FOR A PARTICULAR PURPOSE ARE DISCLAIMED. IN NO EVENT SHALL THE AUTHOR OR CONTRIBUTORS BE LIABLE FOR ANY DIRECT, INDIRECT, INCIDENTAL, SPECIAL, EXEMPLARY, OR CONSEQUENTIAL DAMAGES (INCLUDING, BUT NOT LIMITED TO, PROCUREMENT OF SUBSTITUTE GOODS OR SERVICES; LOSS OF USE, DATA, OR PROFITS; OR BUSINESS INTERRUPTION) HOWEVER CAUSED AND ON ANY THEORY OF LIABILITY, WHETHER IN CONTRACT, STRICT LIABILITY, OR TORT (INCLUDING NEGLIGENCE OR OTHERWISE) ARISING IN ANY WAY OUT OF THE USE OF THIS SOFTWARE, EVEN IF ADVISED OF THE POSSIBILITY OF SUCH DAMAGE.

(19) Todd C. Miller

Copyright (c) 1998 Todd C. Miller <Todd.Miller@courtesan.com>

All rights reserved.

Redistribution and use in source and binary forms, with or without modification, are permitted provided that the following conditions are met:

1. Redistributions of source code must retain the above copyright notice, this list of conditions and the following disclaimer.
2. Redistributions in binary form must reproduce the above copyright notice, this list of conditions and the following disclaimer in the documentation and/or other materials provided with the distribution.
3. The name of the author may not be used to endorse or promote products derived from this software without specific prior written permission.

THIS SOFTWARE IS PROVIDED "AS IS" AND ANY EXPRESS OR IMPLIED WARRANTIES, INCLUDING, BUT NOT LIMITED TO, THE IMPLIED WARRANTIES OF MERCHANTABILITY AND FITNESS FOR A PARTICULAR PURPOSE ARE DISCLAIMED. IN NO EVENT SHALL THE AUTHOR BE LIABLE FOR ANY DIRECT, INDIRECT, INCIDENTAL, SPECIAL, EXEMPLARY, OR CONSEQUENTIAL DAMAGES (INCLUDING, BUT NOT LIMITED TO, PROCUREMENT OF SUBSTITUTE GOODS OR SERVICES; LOSS OF USE, DATA, OR PROFITS; OR BUSINESS INTERRUPTION) HOWEVER CAUSED AND ON ANY THEORY OF LIABILITY, WHETHER IN CONTRACT, STRICT LIABILITY, OR TORT (INCLUDING NEGLIGENCE OR OTHERWISE) ARISING IN ANY WAY OUT OF THE USE OF THIS SOFTWARE, EVEN IF ADVISED OF THE POSSIBILITY OF SUCH DAMAGE.

(20) DJ Delorie (i386)

Copyright (C) 1991 DJ Delorie

All rights reserved.

Redistribution and use in source and binary forms is permitted provided that the above copyright notice and following paragraph are duplicated in all such forms.

This file is distributed WITHOUT ANY WARRANTY; without even the implied warranty of MERCHANTABILITY or FITNESS FOR A PARTICULAR PURPOSE.

(23) Intel (i960)

Copyright (c) 1993 Intel Corporation

Intel hereby grants you permission to copy, modify, and distribute this software and its documentation. Intel grants this permission provided that the above copyright notice appears in all copies and that both the copyright notice and this permission notice appear in supporting documentation. In addition, Intel grants this permission provided that you prominently mark as "not part of the original" any modifications made to this software or documentation, and that the name of Intel Corporation not be used in advertising or publicity pertaining to distribution of the software or the documentation without specific, written prior permission.

Intel Corporation provides this AS IS, WITHOUT ANY WARRANTY, EXPRESS OR IMPLIED, INCLUDING, WITHOUT LIMITATION, ANY WARRANTY OF MERCHANTABILITY OR FITNESS FOR A PARTICULAR PURPOSE. Intel makes no guarantee or representations regarding the use of, or the



results of the use of, the software and documentation in terms of correctness, accuracy, reliability, currentness, or otherwise; and you rely on the software, documentation and results solely at your own risk.

IN NO EVENT SHALL INTEL BE LIABLE FOR ANY LOSS OF USE, LOSS OF BUSINESS, LOSS OF PROFITS, INDIRECT, INCIDENTAL, SPECIAL OR CONSEQUENTIAL DAMAGES OF ANY KIND. IN NO EVENT SHALL INTEL'S TOTAL LIABILITY EXCEED THE SUM PAID TO INTEL FOR THE PRODUCT LICENSED HEREUNDER.

(26) Mike Barcroft

Copyright (c) 2001 Mike Barcroft <mike@FreeBSD.org>

All rights reserved.

Redistribution and use in source and binary forms, with or without modification, are permitted provided that the following conditions are met:

1. Redistributions of source code must retain the above copyright notice, this list of conditions and the following disclaimer.
2. Redistributions in binary form must reproduce the above copyright notice, this list of conditions and the following disclaimer in the documentation and/or other materials provided with the distribution.

THIS SOFTWARE IS PROVIDED BY THE AUTHOR AND CONTRIBUTORS "AS IS" AND ANY EXPRESS OR IMPLIED WARRANTIES, INCLUDING, BUT NOT LIMITED TO, THE IMPLIED WARRANTIES OF MERCHANTABILITY AND FITNESS FOR A PARTICULAR PURPOSE ARE DISCLAIMED. IN NO EVENT SHALL THE AUTHOR OR CONTRIBUTORS BE LIABLE FOR ANY DIRECT, INDIRECT, INCIDENTAL, SPECIAL, EXEMPLARY, OR CONSEQUENTIAL DAMAGES (INCLUDING, BUT NOT LIMITED TO, PROCUREMENT OF SUBSTITUTE GOODS OR SERVICES; LOSS OF USE, DATA, OR PROFITS; OR BUSINESS INTERRUPTION) HOWEVER CAUSED AND ON ANY THEORY OF LIABILITY, WHETHER IN CONTRACT, STRICT LIABILITY, OR TORT (INCLUDING NEGLIGENCE OR OTHERWISE) ARISING IN ANY WAY OUT OF THE USE OF THIS SOFTWARE, EVEN IF ADVISED OF THE POSSIBILITY OF SUCH DAMAGE.

(27) Konstantin Chuguev (--enable-newlib-iconv)

Copyright (c) 1999, 2000

Konstantin Chuguev. All rights reserved.

Redistribution and use in source and binary forms, with or without modification, are permitted provided that the following conditions are met:

1. Redistributions of source code must retain the above copyright notice, this list of conditions and the following disclaimer.

2. Redistributions in binary form must reproduce the above copyright notice, this list of conditions and the following disclaimer in the documentation and/or other materials provided with the distribution.

THIS SOFTWARE IS PROVIDED BY THE AUTHOR AND CONTRIBUTORS "AS IS" AND ANY EXPRESS OR IMPLIED WARRANTIES, INCLUDING, BUT NOT LIMITED TO, THE IMPLIED WARRANTIES OF MERCHANTABILITY AND FITNESS FOR A PARTICULAR PURPOSE ARE DISCLAIMED. IN NO EVENT SHALL THE AUTHOR OR CONTRIBUTORS BE LIABLE FOR ANY DIRECT, INDIRECT, INCIDENTAL, SPECIAL, EXEMPLARY, OR CONSEQUENTIAL DAMAGES (INCLUDING, BUT NOT LIMITED TO, PROCUREMENT OF SUBSTITUTE GOODS OR SERVICES; LOSS OF USE, DATA, OR PROFITS; OR BUSINESS INTERRUPTION) HOWEVER CAUSED AND ON ANY THEORY OF LIABILITY, WHETHER IN CONTRACT, STRICT LIABILITY, OR TORT (INCLUDING NEGLIGENCE OR OTHERWISE) ARISING IN ANY WAY OUT OF THE USE OF THIS SOFTWARE, EVEN IF ADVISED OF THE POSSIBILITY OF SUCH DAMAGE.

iconv (Charset Conversion Library) v2.0

(28) Artem Bityuckiy (--enable-newlib-iconv)

Copyright (c) 2003, Artem B. Bityuckiy, SoftMine Corporation. Rights transferred to Franklin Electronic Publishers.

Redistribution and use in source and binary forms, with or without modification, are permitted provided that the following conditions are met:

1. Redistributions of source code must retain the above copyright notice, this list of conditions and the following disclaimer.

2. Redistributions in binary form must reproduce the above copyright notice, this list of conditions and the following disclaimer in the documentation and/or other materials provided with the distribution.

THIS SOFTWARE IS PROVIDED BY THE AUTHOR AND CONTRIBUTORS "AS IS" AND ANY EXPRESS OR IMPLIED WARRANTIES, INCLUDING, BUT NOT LIMITED TO, THE IMPLIED WARRANTIES OF MERCHANTABILITY AND FITNESS FOR A PARTICULAR PURPOSE ARE DISCLAIMED. IN NO EVENT SHALL THE AUTHOR OR CONTRIBUTORS BE LIABLE FOR ANY DIRECT, INDIRECT, INCIDENTAL, SPECIAL, EXEMPLARY, OR CONSEQUENTIAL DAMAGES (INCLUDING, BUT NOT LIMITED TO, PROCUREMENT OF SUBSTITUTE GOODS OR SERVICES; LOSS OF USE, DATA, OR PROFITS; OR BUSINESS INTERRUPTION) HOWEVER CAUSED AND ON ANY THEORY OF LIABILITY, WHETHER IN CONTRACT, STRICT LIABILITY, OR TORT (INCLUDING NEGLIGENCE OR OTHERWISE) ARISING IN ANY WAY OUT OF THE USE OF THIS SOFTWARE, EVEN IF ADVISED OF THE POSSIBILITY OF SUCH DAMAGE.

(30) - Alex Tatmanjants (targets using libc/posix)

Copyright (c) 1995 Alex Tatmanjants <alex@elvisti.kiev.ua>

at Electronni Visti IA, Kiev, Ukraine.

All rights reserved.

Redistribution and use in source and binary forms, with or without modification, are permitted provided that the following conditions are met:

1. Redistributions of source code must retain the above copyright notice, this list of conditions and the following disclaimer.
2. Redistributions in binary form must reproduce the above copyright notice, this list of conditions and the following disclaimer in the documentation and/or other materials provided with the distribution.

THIS SOFTWARE IS PROVIDED BY THE AUTHOR "AS IS" AND ANY EXPRESS OR IMPLIED WARRANTIES, INCLUDING, BUT NOT LIMITED TO, THE IMPLIED WARRANTIES OF MERCHANTABILITY AND FITNESS FOR A PARTICULAR PURPOSE ARE DISCLAIMED. IN NO EVENT SHALL THE AUTHOR BE LIABLE FOR ANY DIRECT, INDIRECT, INCIDENTAL, SPECIAL, EXEMPLARY, OR CONSEQUENTIAL DAMAGES (INCLUDING, BUT NOT LIMITED TO, PROCUREMENT OF SUBSTITUTE GOODS OR SERVICES; LOSS OF USE, DATA, OR PROFITS; OR BUSINESS INTERRUPTION) HOWEVER CAUSED AND ON ANY THEORY OF LIABILITY, WHETHER IN CONTRACT, STRICT LIABILITY, OR TORT (INCLUDING NEGLIGENCE OR OTHERWISE) ARISING IN ANY WAY OUT OF THE USE OF THIS SOFTWARE, EVEN IF ADVISED OF THE POSSIBILITY OF SUCH DAMAGE.

(31) - M. Warner Losh (targets using libc/posix)

Copyright (c) 1998, M. Warner Losh <imp@freebsd.org>

All rights reserved.

Redistribution and use in source and binary forms, with or without modification, are permitted provided that the following conditions are met:

1. Redistributions of source code must retain the above copyright notice, this list of conditions and the following disclaimer.
2. Redistributions in binary form must reproduce the above copyright notice, this list of conditions and the following disclaimer in the documentation and/or other materials provided with the distribution.

THIS SOFTWARE IS PROVIDED BY THE AUTHOR AND CONTRIBUTORS "AS IS" AND ANY EXPRESS OR IMPLIED WARRANTIES, INCLUDING, BUT NOT LIMITED TO, THE IMPLIED WARRANTIES OF MERCHANTABILITY AND FITNESS FOR A PARTICULAR PURPOSE ARE DISCLAIMED. IN NO EVENT SHALL THE AUTHOR OR CONTRIBUTORS BE LIABLE FOR ANY DIRECT, INDIRECT, INCIDENTAL, SPECIAL, EXEMPLARY, OR CONSEQUENTIAL DAMAGES (INCLUDING, BUT NOT LIMITED TO, PROCUREMENT OF SUBSTITUTE GOODS OR SERVICES; LOSS OF USE, DATA, OR PROFITS; OR BUSINESS INTERRUPTION) HOWEVER CAUSED AND ON ANY THEORY OF LIABILITY, WHETHER IN CONTRACT, STRICT LIABILITY, OR TORT (INCLUDING NEGLIGENCE OR OTHERWISE) ARISING IN ANY WAY OUT OF THE USE OF THIS SOFTWARE, EVEN IF ADVISED OF THE POSSIBILITY OF SUCH DAMAGE.

(32) - Andrey A. Chernov (targets using libc/posix)

Copyright (C) 1996 by Andrey A. Chernov, Moscow, Russia.

All rights reserved.

Redistribution and use in source and binary forms, with or without modification, are permitted provided that the following conditions are met:

1. Redistributions of source code must retain the above copyright notice, this list of conditions and the following disclaimer.
2. Redistributions in binary form must reproduce the above copyright notice, this list of conditions and the following disclaimer in the documentation and/or other materials provided with the distribution.

THIS SOFTWARE IS PROVIDED BY THE AUTHOR "AS IS" AND ANY EXPRESS OR IMPLIED WARRANTIES, INCLUDING, BUT NOT LIMITED TO, THE IMPLIED WARRANTIES OF MERCHANTABILITY AND FITNESS FOR A PARTICULAR PURPOSE ARE DISCLAIMED. IN NO EVENT SHALL THE REGENTS OR CONTRIBUTORS BE LIABLE FOR ANY DIRECT, INDIRECT, INCIDENTAL, SPECIAL, EXEMPLARY, OR CONSEQUENTIAL DAMAGES (INCLUDING, BUT NOT LIMITED TO, PROCUREMENT OF SUBSTITUTE GOODS OR SERVICES; LOSS OF USE, DATA, OR PROFITS; OR BUSINESS INTERRUPTION) HOWEVER CAUSED AND ON ANY THEORY OF LIABILITY, WHETHER IN CONTRACT, STRICT LIABILITY, OR TORT (INCLUDING NEGLIGENCE OR OTHERWISE) ARISING IN ANY WAY OUT OF THE USE OF THIS SOFTWARE, EVEN IF ADVISED OF THE POSSIBILITY OF SUCH DAMAGE.

(33) - Daniel Eischen (targets using libc/posix)

Copyright (c) 2001 Daniel Eischen <deischen@FreeBSD.org>.

All rights reserved.

Redistribution and use in source and binary forms, with or without modification, are permitted provided that the following conditions are met:

1. Redistributions of source code must retain the above copyright notice, this list of conditions and the following disclaimer.
2. Redistributions in binary form must reproduce the above copyright notice, this list of conditions and the following disclaimer in the documentation and/or other materials provided with the distribution.

THIS SOFTWARE IS PROVIDED BY THE AUTHOR AND CONTRIBUTORS "AS IS" AND ANY EXPRESS OR IMPLIED WARRANTIES, INCLUDING, BUT NOT LIMITED TO, THE IMPLIED WARRANTIES OF MERCHANTABILITY AND FITNESS FOR A PARTICULAR PURPOSE ARE DISCLAIMED. IN NO EVENT SHALL THE REGENTS OR CONTRIBUTORS BE LIABLE FOR ANY DIRECT, INDIRECT, INCIDENTAL, SPECIAL, EXEMPLARY, OR CONSEQUENTIAL DAMAGES (INCLUDING, BUT NOT LIMITED TO, PROCUREMENT OF SUBSTITUTE GOODS OR SERVICES; LOSS OF USE, DATA, OR PROFITS; OR BUSINESS INTERRUPTION) HOWEVER CAUSED AND ON

ANY THEORY OF LIABILITY, WHETHER IN CONTRACT, STRICT LIABILITY, OR TORT (INCLUDING NEGLIGENCE OR OTHERWISE) ARISING IN ANY WAY OUT OF THE USE OF THIS SOFTWARE, EVEN IF ADVISED OF THE POSSIBILITY OF SUCH DAMAGE.

(35) - ARM Ltd (arm and thumb variant targets only)

Copyright (c) 2009 ARM Ltd

All rights reserved.

Redistribution and use in source and binary forms, with or without modification, are permitted provided that the following conditions are met:

1. Redistributions of source code must retain the above copyright notice, this list of conditions and the following disclaimer.
2. Redistributions in binary form must reproduce the above copyright notice, this list of conditions and the following disclaimer in the documentation and/or other materials provided with the distribution.
3. The name of the company may not be used to endorse or promote products derived from this software without specific prior written permission.

THIS SOFTWARE IS PROVIDED BY ARM LTD "AS IS" AND ANY EXPRESS OR IMPLIED WARRANTIES, INCLUDING, BUT NOT LIMITED TO, THE IMPLIED WARRANTIES OF MERCHANTABILITY AND FITNESS FOR A PARTICULAR PURPOSE ARE DISCLAIMED. IN NO EVENT SHALL ARM LTD BE LIABLE FOR ANY DIRECT, INDIRECT, INCIDENTAL, SPECIAL, EXEMPLARY, OR CONSEQUENTIAL DAMAGES (INCLUDING, BUT NOT LIMITED TO, PROCUREMENT OF SUBSTITUTE GOODS OR SERVICES; LOSS OF USE, DATA, OR PROFITS; OR BUSINESS INTERRUPTION) HOWEVER CAUSED AND ON ANY THEORY OF LIABILITY, WHETHER IN CONTRACT, STRICT LIABILITY, OR TORT (INCLUDING NEGLIGENCE OR OTHERWISE) ARISING IN ANY WAY OUT OF THE USE OF THIS SOFTWARE, EVEN IF ADVISED OF THE POSSIBILITY OF SUCH DAMAGE.

(36) - CodeSourcery, Inc.

Copyright (c) 2009 CodeSourcery, Inc.

All rights reserved.

Redistribution and use in source and binary forms, with or without modification, are permitted provided that the following conditions are met:

- \* Redistributions of source code must retain the above copyright notice, this list of conditions and the following disclaimer.
- \* Redistributions in binary form must reproduce the above copyright notice, this list of conditions and the following disclaimer in the documentation and/or other materials provided with the distribution.

\* Neither the name of CodeSourcery nor the names of its contributors may be used to endorse or promote products derived from this software without specific prior written permission.

THIS SOFTWARE IS PROVIDED BY CODESOURCERY, INC. "AS IS" AND ANY EXPRESS OR IMPLIED WARRANTIES, INCLUDING, BUT NOT LIMITED TO, THE IMPLIED WARRANTIES OF MERCHANTABILITY AND FITNESS FOR A PARTICULAR PURPOSE ARE DISCLAIMED. IN NO EVENT SHALL CODESOURCERY BE LIABLE FOR ANY DIRECT, INDIRECT, INCIDENTAL, SPECIAL, EXEMPLARY, OR CONSEQUENTIAL DAMAGES (INCLUDING, BUT NOT LIMITED TO, PROCUREMENT OF SUBSTITUTE GOODS OR SERVICES; LOSS OF USE, DATA, OR PROFITS; OR BUSINESS INTERRUPTION) HOWEVER CAUSED AND ON ANY THEORY OF LIABILITY, WHETHER IN CONTRACT, STRICT LIABILITY, OR TORT (INCLUDING NEGLIGENCE OR OTHERWISE) ARISING IN ANY WAY OUT OF THE USE OF THIS SOFTWARE, EVEN IF ADVISED OF THE POSSIBILITY OF SUCH DAMAGE.

(37) MIPS Technologies, Inc

/\*

\* Copyright (c) 2009 MIPS Technologies, Inc.

\* All rights reserved.

\* Redistribution and use in source and binary forms, with or without modification, are permitted provided that the following conditions are met:

\* \* Redistributions of source code must retain the above copyright notice, this list of conditions and the following disclaimer.

\* \* Redistributions in binary form must reproduce the above copyright notice, this list of conditions and the following disclaimer in the documentation and/or other materials provided with the distribution.

\* \* Neither the name of MIPS Technologies Inc. nor the names of its contributors may be used to endorse or promote products derived from this software without specific prior written permission.

\* THIS SOFTWARE IS PROVIDED BY THE COPYRIGHT HOLDERS AND CONTRIBUTORS "AS IS" AND ANY EXPRESS OR IMPLIED WARRANTIES, INCLUDING, BUT NOT LIMITED TO, THE IMPLIED WARRANTIES OF MERCHANTABILITY AND FITNESS FOR A PARTICULAR PURPOSE ARE DISCLAIMED. IN NO EVENT SHALL THE COPYRIGHT OWNER OR CONTRIBUTORS BE LIABLE FOR ANY DIRECT, INDIRECT, INCIDENTAL, SPECIAL, EXEMPLARY, OR CONSEQUENTIAL DAMAGES (INCLUDING, BUT NOT LIMITED TO, PROCUREMENT OF SUBSTITUTE GOODS OR SERVICES; LOSS OF USE, DATA, OR PROFITS; OR BUSINESS INTERRUPTION) HOWEVER CAUSED AND ON ANY THEORY OF LIABILITY, WHETHER IN CONTRACT, STRICT LIABILITY, OR TORT (INCLUDING NEGLIGENCE OR OTHERWISE) ARISING IN ANY WAY OUT OF THE USE OF THIS SOFTWARE, EVEN IF ADVISED OF THE POSSIBILITY OF SUCH DAMAGE.

\*/

## MIT License

This projector product includes the open source software program which applies the terms and conditions provided by owner of the copyright to the "MIT License".

The "MIT License" are WITHOUT ANY WARRANTY; without even the implied warranty of MERCHANTABILITY AND FITNESS FOR A PARTICULAR PURPOSE.

List of MIT License programs

- jquery-1.7.2.min.js
- jquery-ui-1.8.20
- jquery.ui.touch-punch.js
- jquery.upload-1.0.2.min.js
- jquery-1.11.3.min.js
- jquery-ui-1.11.4
- normalize.css

License terms of conditions of each program which are provided by owner of the copyright to the "MIT License" are as follows.

Copyright (c) 2012 jQuery Foundation and other contributors,

<http://jquery.com/>

Copyright (c) Nicolas Gallagher and Jonathan Neal

Permission is hereby granted, free of charge, to any person obtaining a copy of this software and associated documentation files (the "Software"), to deal in the Software without restriction, including without limitation the rights to use, copy, modify, merge, publish, distribute, sublicense, and/or sell copies of the Software, and to permit persons to whom the Software is furnished to do so, subject to the following conditions:

The above copyright notice and this permission notice shall be included in all copies or substantial portions of the Software.

THE SOFTWARE IS PROVIDED "AS IS", WITHOUT WARRANTY OF ANY KIND, EXPRESS OR IMPLIED, INCLUDING BUT NOT LIMITED TO THE WARRANTIES OF MERCHANTABILITY, FITNESS FOR A PARTICULAR PURPOSE AND NONINFRINGEMENT. IN NO EVENT SHALL THE AUTHORS OR COPYRIGHT HOLDERS BE LIABLE FOR ANY CLAIM, DAMAGES OR OTHER LIABILITY, WHETHER IN AN ACTION OF CONTRACT, TORT OR OTHERWISE, ARISING FROM, OUT OF OR IN CONNECTION WITH THE SOFTWARE OR THE USE OR OTHER DEALINGS IN THE SOFTWARE.

## **TOPPERS/JSP**

This projector product includes the open source software program "TOPPERS/JSP" which applies the terms and conditions provided by owner of the copyright to the "TOPPERS/JSP".

The "TOPPERS/JSP" are WITHOUT ANY WARRANTY; without even the implied warranty of MERCHANTABILITY AND FITNESS FOR A PARTICULAR PURPOSE.

List of TOPPERS/JSP programs

- jsp-1.4.3

License terms of conditions of each program which are provided by owner of the copyright to the "TOPPERS/JSP" are as follows.

TOPPERS/JSP Kernel

Toyohashi Open Platform for Embedded Real-Time Systems/Just Standard Profile Kernel

Copyright (C) 2000-2003 by Embedded and Real-Time Systems Laboratory Toyohashi Univ. of Technology, JAPAN

Copyright (C) 2004 by Embedded and Real-Time Systems Laboratory Graduate School of Information Science, Nagoya Univ., JAPAN.

The above copyright holder, limited to cases in which one satisfies conditions (1) ~ (4) below, or the conditions described in Version 2 of the GNU Public License officially announced by the Free Software Foundation, consents to the use, reproduction, alteration, and redistribution (hereafter called utilization) of this software (this software includes alterations, likewise below) without compensation.

(1) When this software is utilized in the form of source code, the above copyright declaration, these conditions of utilization, and the following stipulation of no guarantee shall be included in unchanged form inside the source code.

(2) When this software is redistributed in a form in which it can be used in the development of other software, library form, etc., the above copyright display, these terms of utilization, and the following stipulation of no guarantee shall be inserted in documentation accompanying redistribution (user's manual, etc.).

(3) When this software is redistributed in a form in which it cannot be used in the development of other software, embedded in devices, etc., one of the following conditions shall be satisfied.

(a) The above copyright display, these terms of utilization, and the following stipulation of no guarantee shall be inserted in documentation accompanying redistribution (user's manual, etc.).

(b) The TOPPERS Project shall be notified owing to a method in which the form of distribution is decided otherwise.



(4) The above copyright holder and the TOPPERS Project shall be exempt from responsibility for whatever damages occur either directly or indirectly through the utilization of this software.

This software is something that is provided with no guarantee. The above copyright holder and the TOPPERS Project make no guarantee whatsoever in regard to this software, including the possibility of its application. In addition, the above copyright holder and the TOPPERS Project shall also not bear responsibility for whatever damages occur either directly or indirectly through the utilization of this software.

Note: The TOPPERS License has been revised several times; what is shown above is the latest version that is to be applied to software made public hereafter.

## **TINET**

This projector product includes the open source software program "TINET" which applies the terms and conditions provided by owner of the copyright to the "TINET".

The "TINET" are WITHOUT ANY WARRANTY; without even the implied warranty of MERCHANTABILITY AND FITNESS FOR A PARTICULAR PURPOSE.

List of TINET programs

- tinet-1.4.4

License terms of conditions of each program which are provided by owner of the copyright to the "TINET" are as follows.

(1) FreeBSD

Copyright (c) 1980, 1986, 1993

The Regents of the University of California. All rights reserved.

Redistribution and use in source and binary forms, with or without modification, are permitted provided that the following conditions are met:

1. Redistributions of source code must retain the above copyright notice, this list of conditions and the following disclaimer.
2. Redistributions in binary form must reproduce the above copyright notice, this list of conditions and the following disclaimer in the documentation and/or other materials provided with the distribution.
3. All advertising materials mentioning features or use of this software must display the following acknowledgement:

This product includes software developed by the University of California, Berkeley and its contributors.

4. Neither the name of the University nor the names of its contributors may be used to endorse or promote products derived from this software without specific prior written permission.

THIS SOFTWARE IS PROVIDED BY THE REGENTS AND CONTRIBUTORS "AS IS" AND ANY EXPRESS OR IMPLIED WARRANTIES, INCLUDING, BUT NOT LIMITED TO, THE IMPLIED WARRANTIES OF MERCHANTABILITY AND FITNESS FOR A PARTICULAR PURPOSE ARE DISCLAIMED. IN NO EVENT SHALL THE REGENTS OR CONTRIBUTORS BE LIABLE FOR ANY DIRECT, INDIRECT, INCIDENTAL, SPECIAL, EXEMPLARY, OR CONSEQUENTIAL DAMAGES (INCLUDING, BUT NOT LIMITED TO, PROCUREMENT OF SUBSTITUTE GOODS OR SERVICES; LOSS OF USE, DATA, OR PROFITS; OR BUSINESS INTERRUPTION) HOWEVER CAUSED AND ON ANY THEORY OF LIABILITY, WHETHER IN CONTRACT, STRICT LIABILITY, OR TORT (INCLUDING NEGLIGENCE OR OTHERWISE) ARISING IN ANY WAY OUT OF THE USE OF THIS SOFTWARE, EVEN IF ADVISED OF THE POSSIBILITY OF SUCH DAMAGE.

(6) TINET and TOPPERS

TINET (TCP/IP Protocol Stack)

Copyright (C) 2001-2006 by Dep. of Computer Science and Engineering Tomakomai National College of Technology, JAPAN

The above copyright holder, limited to cases in which one satisfies conditions (1) ~ (4) below, or the conditions described in Version 2 of the GNU Public License officially announced by the Free Software Foundation, consents to the use, reproduction, alteration, and redistribution (hereafter called utilization) of this software (this software includes alterations, likewise below) without compensation.

(1) When this software is utilized in the form of source code, the above copyright declaration, these conditions of utilization, and the following stipulation of no guarantee shall be included in unchanged form inside the source code.

(2) When this software is redistributed in a form in which it can be used in the development of other software, library form, etc., the above copyright display, these terms of utilization, and the following stipulation of no guarantee shall be inserted in documentation accompanying redistribution (user's manual, etc.).

(3) When this software is redistributed in a form in which it cannot be used in the development of other software, embedded in devices, etc., following conditions shall be satisfied.

(a) The above copyright display, these terms of utilization, and the following stipulation of no guarantee shall be inserted in documentation accompanying redistribution (user's manual, etc.).

(4) The above copyright holder and the TOPPERS Project shall be exempt from responsibility for whatever damages occur either directly or indirectly through the utilization of this software.

This software is something that is provided with no guarantee. The above copyright holder and the TOPPERS Project make no guarantee whatsoever in regard to this software, including the possibility of its application. In addition, the above copyright holder and the TOPPERS Project shall also not bear responsibility for whatever damages occur either directly or indirectly through the utilization of this software.

## WPA Supplicant

This projector product includes the open source software program which applies the terms and conditions provided by owner of the copyright to the "WPA Supplicant".

The "WPA Supplicant" are WITHOUT ANY WARRANTY; without even the implied warranty of MERCHANTABILITY AND FITNESS FOR A PARTICULAR PURPOSE.

List of WPA Supplicant programs

- wpa\_supplicant-2.3

License terms of conditions of each program which are provided by owner of the copyright to the "WPA Supplicant" are as follows.

Copyright (c) 2003-2014, Jouni Malinen <j@w1.fi> and contributors

All Rights Reserved.

This program is licensed under the BSD license (the one with advertisement clause removed).

If you are submitting changes to the project, please see CONTRIBUTIONS file for more instructions.

License

-----

This software may be distributed, used, and modified under the terms of BSD license:

Redistribution and use in source and binary forms, with or without modification, are permitted provided that the following conditions are met:

1. Redistributions of source code must retain the above copyright notice, this list of conditions and the following disclaimer.
2. Redistributions in binary form must reproduce the above copyright notice, this list of conditions and the following disclaimer in the documentation and/or other materials provided with the distribution.
3. Neither the name(s) of the above-listed copyright holder(s) nor the names of its contributors may be used to endorse or promote products derived from this software without specific prior written permission.

THIS SOFTWARE IS PROVIDED BY THE COPYRIGHT HOLDERS AND CONTRIBUTORS "AS IS" AND ANY EXPRESS OR IMPLIED WARRANTIES, INCLUDING, BUT NOT LIMITED TO, THE IMPLIED WARRANTIES OF MERCHANTABILITY AND FITNESS FOR A PARTICULAR PURPOSE ARE DISCLAIMED. IN NO EVENT SHALL THE COPYRIGHT OWNER OR CONTRIBUTORS BE LIABLE FOR ANY DIRECT, INDIRECT, INCIDENTAL, SPECIAL, EXEMPLARY, OR CONSEQUENTIAL DAMAGES (INCLUDING, BUT NOT LIMITED TO, PROCUREMENT OF SUBSTITUTE GOODS OR SERVICES; LOSS OF USE, DATA, OR PROFITS; OR BUSINESS INTERRUPTION) HOWEVER CAUSED AND ON ANY THEORY OF LIABILITY, WHETHER IN CONTRACT, STRICT LIABILITY, OR

TORT (INCLUDING NEGLIGENCE OR OTHERWISE) ARISING IN ANY WAY OUT OF THE USE OF THIS SOFTWARE, EVEN IF ADVISED OF THE POSSIBILITY OF SUCH DAMAGE.

### **lighttpd**

This projector product includes the open source software program "lighttpd" which applies the terms and conditions provided by owner of the copyright to the "lighttpd".

The "lighttpd" are WITHOUT ANY WARRANTY; without even the implied warranty of MERCHANTABILITY AND FITNESS FOR A PARTICULAR PURPOSE.

List of lighttpd programs

- lighttpd-1.4.35

License terms of conditions of each program which are provided by owner of the copyright to the "lighttpd" are as follows.

Copyright (c) 2004, Jan Kneschke, incremental

All rights reserved.

Redistribution and use in source and binary forms, with or without modification, are permitted provided that the following conditions are met:

- Redistributions of source code must retain the above copyright notice, this list of conditions and the following disclaimer.
- Redistributions in binary form must reproduce the above copyright notice, this list of conditions and the following disclaimer in the documentation and/or other materials provided with the distribution.
- Neither the name of the 'incremental' nor the names of its contributors may be used to endorse or promote products derived from this software without specific prior written permission.

THIS SOFTWARE IS PROVIDED BY THE COPYRIGHT HOLDERS AND CONTRIBUTORS "AS IS" AND ANY EXPRESS OR IMPLIED WARRANTIES, INCLUDING, BUT NOT LIMITED TO, THE IMPLIED WARRANTIES OF MERCHANTABILITY AND FITNESS FOR A PARTICULAR PURPOSE ARE DISCLAIMED. IN NO EVENT SHALL THE COPYRIGHT OWNER OR CONTRIBUTORS BE LIABLE FOR ANY DIRECT, INDIRECT, INCIDENTAL, SPECIAL, EXEMPLARY, OR CONSEQUENTIAL DAMAGES (INCLUDING, BUT NOT LIMITED TO, PROCUREMENT OF SUBSTITUTE GOODS OR SERVICES; LOSS OF USE, DATA, OR PROFITS; OR BUSINESS INTERRUPTION) HOWEVER CAUSED AND ON ANY THEORY OF LIABILITY, WHETHER IN CONTRACT, STRICT LIABILITY, OR TORT (INCLUDING NEGLIGENCE OR OTHERWISE) ARISING IN ANY WAY OUT OF THE USE OF THIS SOFTWARE, EVEN IF ADVISED OF THE POSSIBILITY OF SUCH DAMAGE

## **PCRE**

This projector product includes the open source software program "PCRE" which applies the terms and conditions provided by owner of the copyright to the "PCRE".

The "PCRE" are WITHOUT ANY WARRANTY; without even the implied warranty of MERCHANTABILITY AND FITNESS FOR A PARTICULAR PURPOSE.

List of PCRE programs

- pcre-8.32

License terms of conditions of each program which are provided by owner of the copyright to the "PCRE" are as follows.

### **PCRE LICENCE**

-----

PCRE is a library of functions to support regular expressions whose syntax and semantics are as close as possible to those of the Perl 5 language.

Release 8 of PCRE is distributed under the terms of the "BSD" licence, as specified below. The documentation for PCRE, supplied in the "doc" directory, is distributed under the same terms as the software itself.

The basic library functions are written in C and are freestanding. Also included in the distribution is a set of C++ wrapper functions, and a just-in-time compiler that can be used to optimize pattern matching. These are both optional features that can be omitted when the library is built.

### **THE BASIC LIBRARY FUNCTIONS**

-----

Written by: Philip Hazel

Email local part: ph10

Email domain: cam.ac.uk

University of Cambridge Computing Service, Cambridge, England.

Copyright (c) 1997-2012 University of Cambridge

All rights reserved.

### **PCRE JUST-IN-TIME COMPILATION SUPPORT**

-----

Written by: Zoltan Herczeg

Email local part: hzmester  
Email domain: freemail.hu  
Copyright(c) 2010-2012 Zoltan Herczeg  
All rights reserved.

### **STACK-LESS JUST-IN-TIME COMPILER**

-----

Written by: Zoltan Herczeg  
Email local part: hzmester  
Email domain: freemail.hu  
Copyright(c) 2009-2012 Zoltan Herczeg  
All rights reserved.

### **THE C++ WRAPPER FUNCTIONS**

-----

Contributed by: Google Inc.  
Copyright (c) 2007-2012, Google Inc.  
All rights reserved.

### **THE "BSD" LICENCE**

-----

Redistribution and use in source and binary forms, with or without modification, are permitted provided that the following conditions are met:

- \* Redistributions of source code must retain the above copyright notice, this list of conditions and the following disclaimer.
- \* Redistributions in binary form must reproduce the above copyright notice, this list of conditions and the following disclaimer in the documentation and/or other materials provided with the distribution.
- \* Neither the name of the University of Cambridge nor the name of Google Inc. nor the names of their contributors may be used to endorse or promote products derived from this software without specific prior written permission.

THIS SOFTWARE IS PROVIDED BY THE COPYRIGHT HOLDERS AND CONTRIBUTORS "AS IS"  
AND ANY EXPRESS OR IMPLIED WARRANTIES, INCLUDING, BUT NOT LIMITED TO, THE IMPLIED

WARRANTIES OF MERCHANTABILITY AND FITNESS FOR A PARTICULAR PURPOSE ARE DISCLAIMED. IN NO EVENT SHALL THE COPYRIGHT OWNER OR CONTRIBUTORS BE LIABLE FOR ANY DIRECT, INDIRECT, INCIDENTAL, SPECIAL, EXEMPLARY, OR CONSEQUENTIAL DAMAGES (INCLUDING, BUT NOT LIMITED TO, PROCUREMENT OF SUBSTITUTE GOODS OR SERVICES; LOSS OF USE, DATA, OR PROFITS; OR BUSINESS INTERRUPTION) HOWEVER CAUSED AND ON ANY THEORY OF LIABILITY, WHETHER IN CONTRACT, STRICT LIABILITY, OR TORT (INCLUDING NEGLIGENCE OR OTHERWISE) ARISING IN ANY WAY OUT OF THE USE OF THIS SOFTWARE, EVEN IF ADVISED OF THE POSSIBILITY OF SUCH DAMAGE.

End

### **FastCGI**

This projector product includes the open source software program "FastCGI" which applies the terms and conditions provided by owner of the copyright to the "FastCGI"

The "FastCGI" are WITHOUT ANY WARRANTY; without even the implied warranty of MERCHANTABILITY AND FITNESS FOR A PARTICULAR PURPOSE.

List of FastCGI programs

- fcgi-2.4.0

License terms of conditions of each program which are provided by owner of the copyright to the "FastCGI" are as follows.

This FastCGI application library source and object code (the "Software") and its documentation (the "Documentation") are copyrighted by Open Market, Inc ("Open Market"). The following terms apply to all files associated with the Software and Documentation unless explicitly disclaimed in individual files.

Open Market permits you to use, copy, modify, distribute, and license this Software and the Documentation for any purpose, provided that existing copyright notices are retained in all copies and that this notice is included verbatim in any distributions. No written agreement, license, or royalty fee is required for any of the authorized uses. Modifications to this Software and Documentation may be copyrighted by their authors and need not follow the licensing terms described here. If modifications to this Software and Documentation have new licensing terms, the new terms must be clearly indicated on the first page of each file where they apply.

OPEN MARKET MAKES NO EXPRESS OR IMPLIED WARRANTY WITH RESPECT TO THE SOFTWARE OR THE DOCUMENTATION, INCLUDING WITHOUT LIMITATION ANY WARRANTY OF MERCHANTABILITY OR FITNESS FOR A PARTICULAR PURPOSE. IN NO EVENT SHALL OPEN MARKET BE LIABLE TO YOU OR ANY THIRD PARTY FOR ANY DAMAGES ARISING FROM OR RELATING TO THIS SOFTWARE OR THE DOCUMENTATION, INCLUDING, WITHOUT LIMITATION, ANY INDIRECT, SPECIAL OR CONSEQUENTIAL DAMAGES OR SIMILAR DAMAGES, INCLUDING LOST PROFITS OR LOST DATA, EVEN IF OPEN MARKET HAS BEEN ADVISED OF THE POSSIBILITY OF SUCH DAMAGES. THE SOFTWARE AND DOCUMENTATION ARE PROVIDED "AS

IS". OPEN MARKET HAS NO LIABILITY IN CONTRACT, TORT, NEGLIGENCE OR OTHERWISE ARISING OUT OF THIS SOFTWARE OR THE DOCUMENTATION.

### **D3.js**

This projector product includes the open source software program "D3.js" which applies the terms and conditions provided by owner of the copyright to the "D3.js"

The "D3.js" are WITHOUT ANY WARRANTY; without even the implied warranty of MERCHANTABILITY AND FITNESS FOR A PARTICULAR PURPOSE.

List of D3.js programs:

d3.js

License terms of conditions of each program which are provided by owner of the copyright to the "D3.js" are as follows.

Copyright (c) 2010-2016, Michael Bostock

All rights reserved.

Redistribution and use in source and binary forms, with or without modification, are permitted provided that the following conditions are met:

- \* Redistributions of source code must retain the above copyright notice, this list of conditions and the following disclaimer.
- \* Redistributions in binary form must reproduce the above copyright notice, this list of conditions and the following disclaimer in the documentation and/or other materials provided with the distribution.
- \* The name Michael Bostock may not be used to endorse or promote products derived from this software without specific prior written permission.

THIS SOFTWARE IS PROVIDED BY THE COPYRIGHT HOLDERS AND CONTRIBUTORS "AS IS" AND ANY EXPRESS OR IMPLIED WARRANTIES, INCLUDING, BUT NOT LIMITED TO, THE IMPLIED WARRANTIES OF MERCHANTABILITY AND FITNESS FOR A PARTICULAR PURPOSE ARE DISCLAIMED. IN NO EVENT SHALL MICHAEL BOSTOCK BE LIABLE FOR ANY DIRECT, INDIRECT, INCIDENTAL, SPECIAL, EXEMPLARY, OR CONSEQUENTIAL DAMAGES (INCLUDING, BUT NOT LIMITED TO, PROCUREMENT OF SUBSTITUTE GOODS OR SERVICES; LOSS OF USE, DATA, OR PROFITS; OR BUSINESS INTERRUPTION) HOWEVER CAUSED AND ON ANY THEORY OF LIABILITY, WHETHER IN CONTRACT, STRICT LIABILITY, OR TORT (INCLUDING NEGLIGENCE OR OTHERWISE) ARISING IN ANY WAY OUT OF THE USE OF THIS SOFTWARE, EVEN IF ADVISED OF THE POSSIBILITY OF SUCH DAMAGE.

**Parent topic:** [Notices](#)



# Binding Arbitration and Class Waiver

## 1. DISPUTES, BINDING INDIVIDUAL ARBITRATION, AND WAIVER OF CLASS ACTIONS AND CLASS ARBITRATIONS

1.1 **Disputes.** The terms of this Section 1 shall apply to all Disputes between you and Epson. The term "Dispute" is meant to have the broadest meaning permissible under law and includes any dispute, claim, controversy or action between you and Epson arising out of or relating to this Agreement, Epson branded products (hardware and including any related software), or other transaction involving you and Epson, whether in contract, warranty, misrepresentation, fraud, tort, intentional tort, statute, regulation, ordinance, or any other legal or equitable basis. "DISPUTE" DOES NOT INCLUDE IP CLAIMS, or more specifically, a claim or cause of action for (a) trademark infringement or dilution, (b) patent infringement, (c) copyright infringement or misuse, or (d) trade secret misappropriation (an "IP Claim"). You and Epson also agree, notwithstanding Section 1.6, that a court, not an arbitrator, may decide if a claim or cause of action is for an IP Claim.

1.2 **Binding Arbitration.** You and Epson agree that all Disputes shall be resolved by binding arbitration according to this Agreement. **ARBITRATION MEANS THAT YOU WAIVE YOUR RIGHT TO A JUDGE OR JURY IN A COURT PROCEEDING AND YOUR GROUNDS FOR APPEAL ARE LIMITED.**

Pursuant to this Agreement, binding arbitration shall be administered by JAMS, a nationally recognized arbitration authority, pursuant to its code of procedures then in effect for consumer related disputes, but excluding any rules that permit joinder or class actions in arbitration (for more detail on procedure, see Section 1.6 below). You and Epson understand and agree that (a) the Federal Arbitration Act (9 U.S.C. §1, et seq.) governs the interpretation and enforcement of this Section 1, (b) this Agreement memorializes a transaction in interstate commerce, and (c) this Section 1 shall survive termination of this Agreement.

1.3 **Pre-Arbitration Steps and Notice.** Before submitting a claim for arbitration, you and Epson agree to try, for sixty (60) days, to resolve any Dispute informally. If Epson and you do not reach an agreement to resolve the Dispute within the sixty (60) days, you or Epson may commence an arbitration. Notice to Epson must be addressed to: Epson America, Inc., ATTN: Legal Department, 3840 Kilroy Airport Way, Long Beach, CA 90806 (the "Epson Address"). The Dispute Notice to you will be sent to the most recent address Epson has in its records for you. For this reason, it is important to notify us if your address changes by emailing us at [EAILEgal@ea.epson.com](mailto:EAILEgal@ea.epson.com) or writing us at the Epson Address above. Notice of the Dispute shall include the sender's name, address and contact information, the facts giving rise to the Dispute, and the relief requested (the "Dispute Notice"). Following receipt of the Dispute Notice, Epson and you agree to act in good faith to resolve the Dispute before commencing arbitration.

1.4 **Small Claims Court.** Notwithstanding the foregoing, you may bring an individual action in the small claims court of your state or municipality if the action is within that court's jurisdiction and is pending only in that court.

**1.5 WAIVER OF CLASS ACTIONS AND CLASS ARBITRATIONS. YOU AND EPSON AGREE THAT EACH PARTY MAY BRING DISPUTES AGAINST THE OTHER PARTY ONLY IN AN INDIVIDUAL CAPACITY, AND NOT AS A PLAINTIFF OR CLASS MEMBER IN ANY CLASS OR REPRESENTATIVE PROCEEDING, INCLUDING WITHOUT LIMITATION FEDERAL OR STATE CLASS ACTIONS, OR CLASS ARBITRATIONS. CLASS ACTION LAWSUITS, CLASS-WIDE ARBITRATIONS, PRIVATE ATTORNEY-GENERAL ACTIONS, AND ANY OTHER PROCEEDING WHERE SOMEONE ACTS IN A REPRESENTATIVE CAPACITY ARE NOT ALLOWED. ACCORDINGLY, UNDER THE ARBITRATION PROCEDURES OUTLINED IN THIS SECTION, AN ARBITRATOR SHALL NOT COMBINE OR CONSOLIDATE MORE THAN ONE PARTY'S CLAIMS WITHOUT THE WRITTEN CONSENT OF ALL AFFECTED PARTIES TO AN ARBITRATION PROCEEDING.**

**1.6 Arbitration Procedure.** If you or Epson commences arbitration, the arbitration shall be governed by the rules of JAMS that are in effect when the arbitration is filed, excluding any rules that permit arbitration on a class or representative basis (the "JAMS Rules"), available at <http://www.jamsadr.com> or by calling 1-800-352-5267, and under the rules set forth in this Agreement. All Disputes shall be resolved by a single neutral arbitrator, and both parties shall have a reasonable opportunity to participate in the selection of the arbitrator. The arbitrator is bound by the terms of this Agreement. The arbitrator, and not any federal, state or local court or agency, shall have exclusive authority to resolve all disputes arising out of or relating to the interpretation, applicability, enforceability or formation of this Agreement, including any claim that all or any part of this Agreement is void or voidable. Notwithstanding this broad delegation of authority to the arbitrator, a court may determine the limited question of whether a claim or cause of action is for an IP Claim, which is excluded from the definition of "Disputes" in Section 1.1 above. The arbitrator shall be empowered to grant whatever relief would be available in a court under law or in equity. The arbitrator may award you the same damages as a court could, and may award declaratory or injunctive relief only in favor of the individual party seeking relief and only to the extent necessary to provide relief warranted by that party's individual claim. In some instances, the costs of arbitration can exceed the costs of litigation and the right to discovery may be more limited in arbitration than in court. The arbitrator's award is binding and may be entered as a judgment in any court of competent jurisdiction.

You may choose to engage in arbitration hearings by telephone. Arbitration hearings not conducted by telephone shall take place in a location reasonably accessible from your primary residence, or in Orange County, California, at your option.

a) Initiation of Arbitration Proceeding. If either you or Epson decides to arbitrate a Dispute, both parties agree to the following procedure:

(i) Write a Demand for Arbitration. The demand must include a description of the Dispute and the amount of damages sought to be recovered. You can find a copy of a Demand for Arbitration at <http://www.jamsadr.com> ("Demand for Arbitration").

(ii) Send three copies of the Demand for Arbitration, plus the appropriate filing fee, to: JAMS, 500 North State College Blvd., Suite 600 Orange, CA 92868, U.S.A.

(iii) Send one copy of the Demand for Arbitration to the other party (same address as the Dispute Notice), or as otherwise agreed by the parties.

b) Hearing Format. During the arbitration, the amount of any settlement offer made shall not be disclosed to the arbitrator until after the arbitrator determines the amount, if any, to which you or Epson is entitled. The discovery or exchange of non-privileged information relevant to the Dispute may be allowed during the arbitration.

c) Arbitration Fees. Epson shall pay, or (if applicable) reimburse you for, all JAMS filings and arbitrator fees for any arbitration commenced (by you or Epson) pursuant to provisions of this Agreement.

d) Award in Your Favor. For Disputes in which you or Epson seeks \$75,000 or less in damages exclusive of attorney's fees and costs, if the arbitrator's decision results in an award to you in an amount greater than Epson's last written offer, if any, to settle the Dispute, Epson will: (i) pay you \$1,000 or the amount of the award, whichever is greater; (ii) pay you twice the amount of your reasonable attorney's fees, if any; and (iii) reimburse you for any expenses (including expert witness fees and costs) that your attorney reasonably accrues for investigating, preparing, and pursuing the Dispute in arbitration. Except as agreed upon by you and Epson in writing, the arbitrator shall determine the amount of fees, costs, and expenses to be paid by Epson pursuant to this Section 1.6d).

e) Attorney's Fees. Epson will not seek its attorney's fees and expenses for any arbitration commenced involving a Dispute under this Agreement. Your right to attorney's fees and expenses under Section 1.6d) above does not limit your rights to attorney's fees and expenses under applicable law; notwithstanding the foregoing, the arbitrator may not award duplicative awards of attorney's fees and expenses.

**1.7 Opt-out. You may elect to opt-out (exclude yourself) from the final, binding, individual arbitration procedure and waiver of class and representative proceedings specified in this Agreement by sending a written letter to the Epson Address within thirty (30) days of your assent to this Agreement (including without limitation the purchase, download, installation of the Software or other applicable use of Epson Hardware, products and services) that specifies (i) your name, (ii) your mailing address, and (iii) your request to be excluded from the final, binding individual arbitration procedure and waiver of class and representative proceedings specified in this Section 1. In the event that you opt-out consistent with the procedure set forth above, all other terms shall continue to apply, including the requirement to provide notice prior to litigation.**

**1.8 Amendments to Section 1.** Notwithstanding any provision in this Agreement to the contrary, you and Epson agree that if Epson makes any future amendments to the dispute resolution procedure and class action waiver provisions (other than a change to Epson's address) in this Agreement, Epson will obtain your affirmative assent to the applicable amendment. If you do not affirmatively assent to the applicable amendment, you are agreeing that you will arbitrate any Dispute between the parties in accordance with the language of this Section 1 (or resolve disputes as provided for in Section 1.7, if you timely elected to opt-out when you first assented to this Agreement).

**1.9 Severability.** If any provision in this Section 1 is found to be unenforceable, that provision shall be severed with the remainder of this Agreement remaining in full force and effect. **The foregoing shall not apply to the prohibition against class or representative actions as provided in Section 1.5. This means that if Section 1.5 is found to be unenforceable, the entire Section 1 (but only Section 1) shall be null and void.**

Parent topic: [Notices](#)

## Trademarks

EPSON®, EasyMP®, Instant Off®, and Quick Corner® are registered trademarks, and EPSON Exceed Your Vision is a registered logomark of Seiko Epson Corporation.

PrivateLine® is a registered trademark; SizeWise™ is a trademark; and Epson Store<sup>SM</sup> and Extra Care<sup>SM</sup> are service marks of Epson America, Inc.

Mac and OS X are trademarks of Apple Inc., registered in the U.S. and other countries.

HDMI and High-Definition Multimedia Interface are the trademarks or registered trademarks of HDMI Licensing LLC.  HIGH DEFINITION MULTIMEDIA INTERFACE

HDBaseT™ and the HDBaseT Alliance logo are trademarks of the HDBaseT Alliance.

General Notice: Other product names used herein are for identification purposes only and may be trademarks of their respective owners. Epson disclaims any and all rights in those marks.



Parent topic: [Notices](#)

## Copyright Notice

All rights reserved. No part of this publication may be reproduced, stored in a retrieval system, or transmitted in any form or by any means, electronic, mechanical, photocopying, recording, or otherwise, without the prior written permission of Seiko Epson Corporation. The information contained herein is designed only for use with this Epson product. Epson is not responsible for any use of this information as applied to other products.

Neither Seiko Epson Corporation nor its affiliates shall be liable to the purchaser of this product or third parties for damages, losses, costs, or expenses incurred by purchaser or third parties as a result of: accident, misuse, or abuse of this product or unauthorized modifications, repairs, or alterations to this

product, or (excluding the U.S.) failure to strictly comply with Seiko Epson Corporation's operating and maintenance instructions.

Seiko Epson Corporation shall not be liable for any damages or problems arising from the use of any options or any consumable products other than those designated as Original Epson Products or Epson Approved Products by Seiko Epson Corporation.

This information is subject to change without notice.

[A Note Concerning Responsible Use of Copyrighted Materials](#)  
[Copyright Attribution](#)

**Parent topic:** [Notices](#)

## **A Note Concerning Responsible Use of Copyrighted Materials**

Epson encourages each user to be responsible and respectful of the copyright laws when using any Epson product. While some countries' laws permit limited copying or reuse of copyrighted material in certain circumstances, those circumstances may not be as broad as some people assume. Contact your legal advisor for any questions regarding copyright law.

**Parent topic:** [Copyright Notice](#)

## **Copyright Attribution**

© 2016 Epson America, Inc.

11/16

CPD-52094R1

**Parent topic:** [Copyright Notice](#)



**205 Westwood Ave, Long Branch, NJ 07740**

**Phone: 866-94 BOARDS (26273) / (732)-222-1511**

**Fax: (732)-222-7088 | E-mail: [sales@touchboards.com](mailto:sales@touchboards.com)**