

# Quick Setup

**IMPORTANT:** Before using the projector, make sure you read these instructions and the safety instructions in the online *User's Guide*.

**Note:** Your product may differ from the illustrations on this sheet, but the instructions are the same.

## Connect the projector

### Computer

Choose from the following connections. See the sections below or the online *User's Guide* for details.

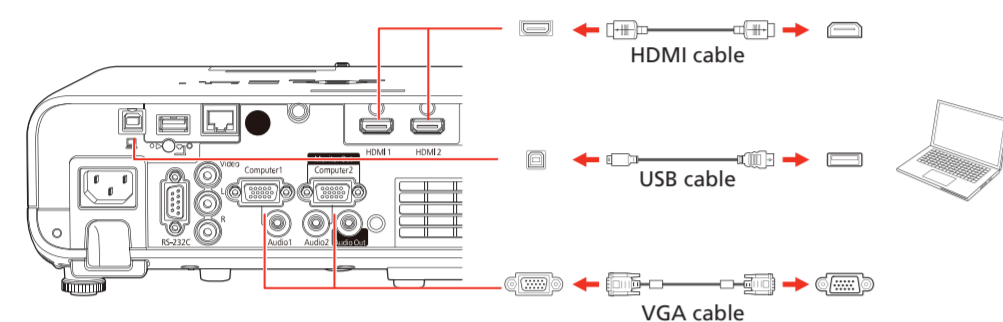

### HDMI port

Connect one end of an HDMI cable to one of the projector's **HDMI** ports and the other end to an HDMI port on your computer.

### Computer port

Connect one end of a VGA cable to the projector's **Computer1** port, and the other end to your computer's  monitor port. If you are using a laptop, switch it to external display (see "Troubleshooting" on the back of this sheet). You can also connect an audio cable.

**Note:** To use the projector's **Computer2** port, you need to change the **Monitor Out Port** setting in the **Signal I/O** menu. See the online *User's Guide* for details.

### USB port

Connect the square end of a USB cable to the projector's **USB-B** (square) port. Connect the flat end of the cable to any USB port on your computer.

**Windows® 7 or later:** After turning on the projector, follow the on-screen instructions to install the Epson® USB Display software (**EMP\_UDSE.EXE**; only on first connection). If the software screen does not display automatically, open **My Computer**, **Computer**, or **This PC**, then double-click **EPSON\_PJ\_UD**.

**OS X 10.8.x or higher:** After turning on the projector, the setup folder for USB Display appears in the Finder. Double-click **USB Display Installer** and follow the on-screen instructions to install the Epson USB Display software (only on first connection). If the software screen does not display automatically, double-click **EPSON\_PJ\_UD**, then double-click **USB Display Installer**.

### External monitor and speakers

You can connect an external monitor and external speakers to your projector to enhance your presentations. See the online *User's Guide* for details.

### Wired network

Connect the projector to your network using an Ethernet cable. See "Wired network configuration" for more information.

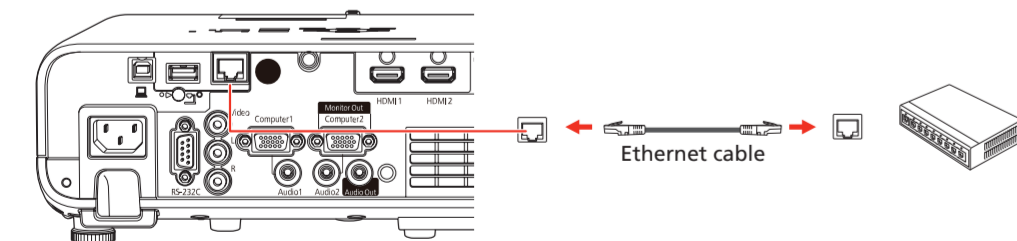

### Video device

Connect multiple video devices and use the **Source Search** button on the projector or remote control to switch between them. For more information on playing sound through the projector, see the online *User's Guide*.

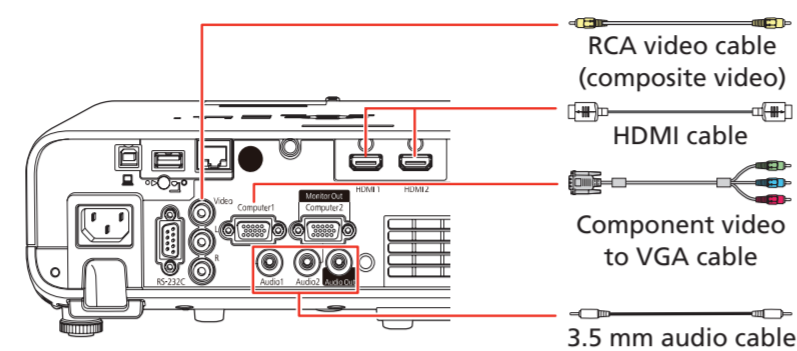

### Camera, USB device, or document camera

Connect a digital camera, USB flash drive, USB storage device, or Epson DC-07 document camera to the projector's **USB-A** (flat) port.

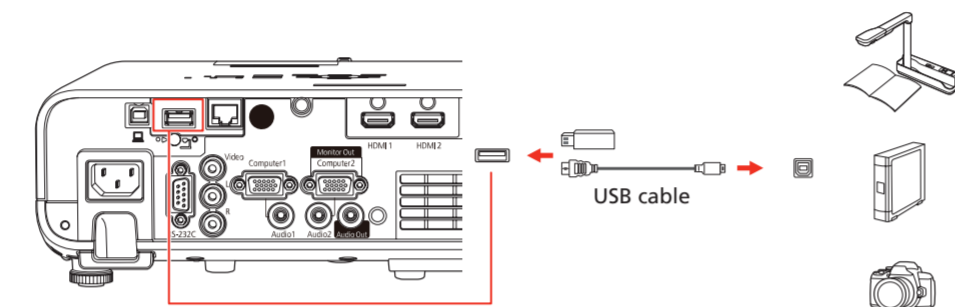

If you connect a digital camera, USB flash drive, or USB storage device, you can use the projector's **PC Free** feature. You can also connect other Epson document cameras to the projector. See the online *User's Guide* for details.

## Using the remote control

Install the two AA batteries as shown.

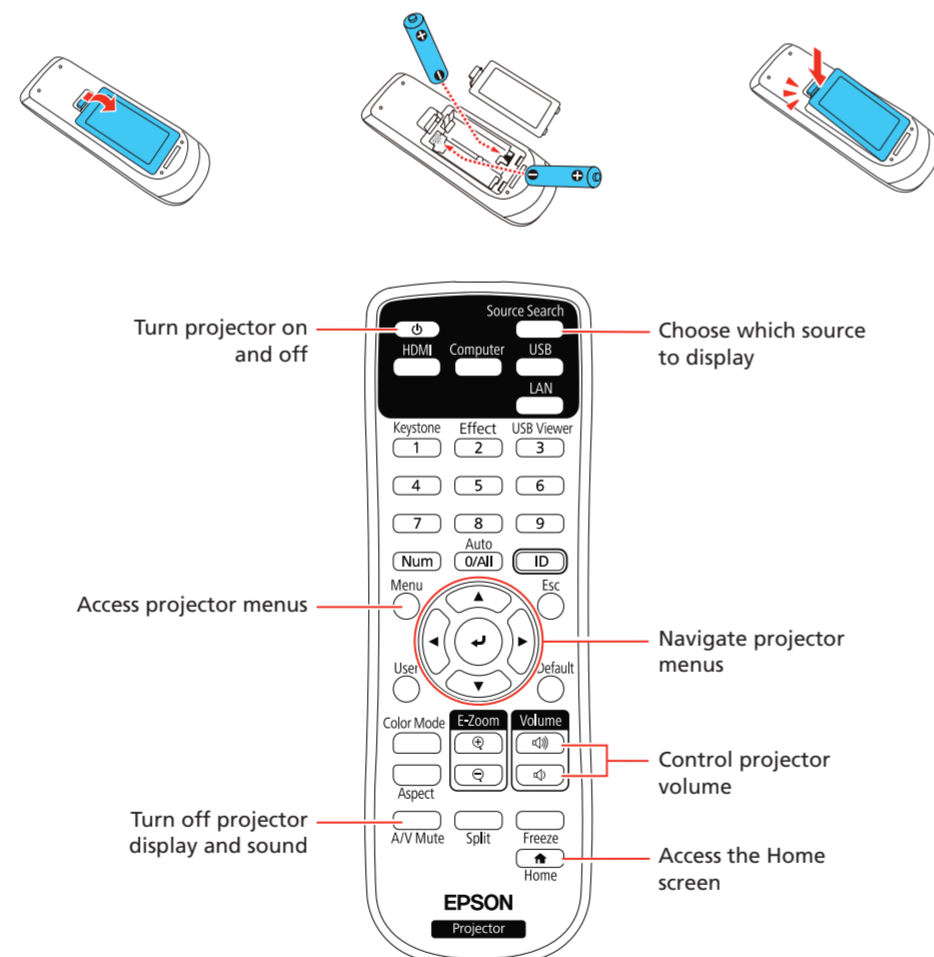

For more information on using the remote control, see the online *User's Guide*.

## Turn on your equipment

- 1 Turn on your computer or video source.
- 2 Make sure the power cord is connected and plugged into an electrical outlet.

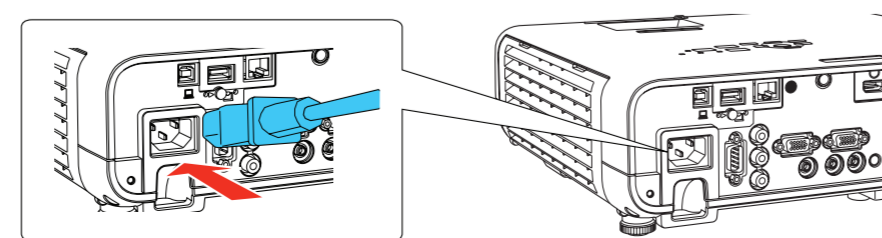

- 3 Open the projector's lens cover.

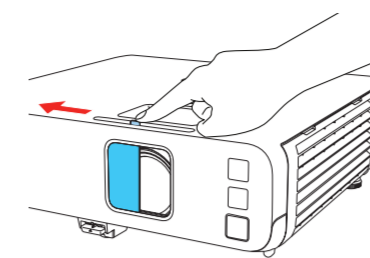

- 4 Press the **Power** button on the projector or remote control. The projector beeps, and the Status light flashes blue and then stays on.

**Note:** To shut down the projector, press the **Power** button twice.

- 5 Follow the on-screen instructions to set up your projector. If you see a screen displaying 123, press **Left Arrow** on the remote control to continue.

**Note:** To change these settings, see the online *User's Guide*.

- 6 If you don't see an image, do one of the following:

- Press the **Source Search** button on the remote control to select the image source.
- Press the **Home** button on the remote control. Use the arrow buttons to highlight any of the options on the Home screen, then press **Left Arrow** to select it.

**Note:** If you still see a blank screen or have other display problems, see the troubleshooting tips on the back of this sheet.

- 7 The default language of the menu system is English. To select another language, press the **Menu** button on the remote control. Select **Management** and press **Left Arrow**. Select **Language** and press **Left Arrow**. Select your language and press **Left Arrow**. Press the **Menu** button to exit the menu system.

## Adjust the image

- 1 To raise the image, press the foot release button and lift the front of the projector. Release the button to lock the foot in position.

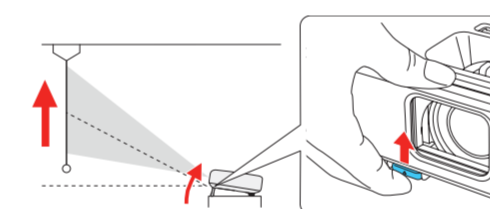

- 2 To reduce or enlarge the image, rotate the zoom ring on the projector.



- 3 To sharpen the image, turn the focus ring on the projector.

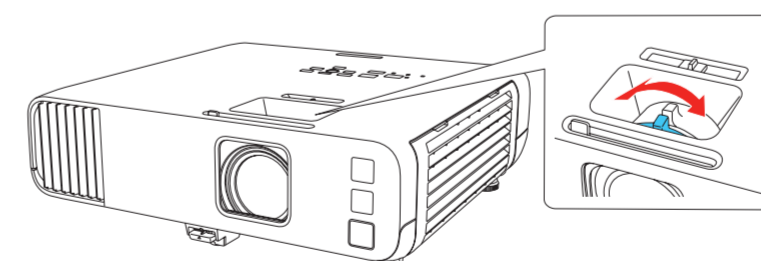

- 4 If your image looks like or , you may have placed the projector off to one side of the screen at an angle. Place the projector directly in front of the center of the screen, facing the screen squarely. If you can't move the projector, use the horizontal keystone slider on the projector to correct the image shape.

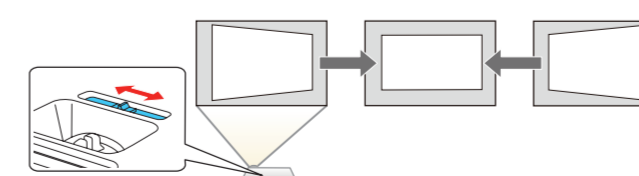

- 5 Your projector automatically adjusts an image that looks like or , but if necessary you can press the or button on the projector to correct it.

## Wireless network configuration

Follow these steps to set up the projector for a wireless network connection.

- 1 Press the **Menu** button on the remote control.
- 2 Select the **Management** menu and press **Left Arrow**.

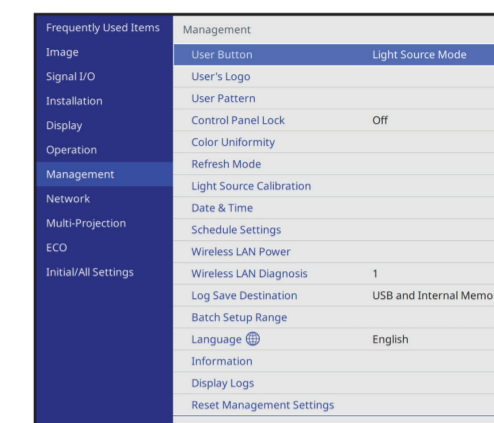

- 3 Select **On** as the **Wireless LAN Power** setting.

- 4 Select the **Network** menu and press **Left Arrow**.

- 5 Select **Network Settings** and press **Left Arrow**.

- 6 Select **Wireless LAN** as the **Priority Control Interface** setting.

- 7 Select one of the following as the **Simple AP** setting:

- **On** for a direct connection to a computer, tablet, or smartphone.
- **Off** to connect your projector to a router or access point.

**Note:** If you connect to the projector directly, you can only project locally stored content.

- 8 Select any other wireless settings as necessary. See the online *User's Guide* for details.

- 9 When you are finished, return to the Network Settings menu and select **Set** to apply your settings.

## Wired network configuration

Follow these steps to set up your projector for a wired network connection.

- 1 Press the **Menu** button on the remote control, select the **Network** menu, then press **Left Arrow**.

- 2 Choose **Network Settings** and press **Left Arrow**.

- 3 Select **Wired LAN** as the **Priority Control Interface** setting.

- 4 Select the **Wired LAN** menu and press **Left Arrow**.

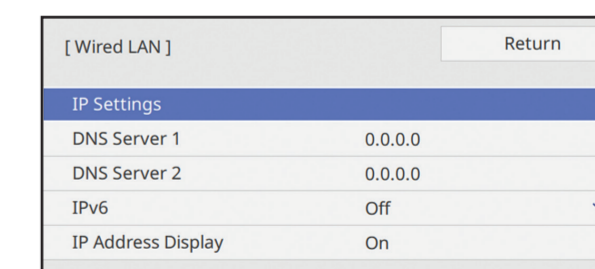

- 5 Choose **IP Settings** and press **Left Arrow**.

- 6 If your network assigns addresses automatically, make sure the **DHCP** setting is on. If not, make sure **DHCP** is off and enter the projector's **IP Address**, **Subnet Mask**, and **Gateway Address**, as needed. Then press **Esc**.

- 7 To prevent the IP address from appearing on the network standby screen, set the **IP Address Display** setting to **Off**.





8 When you are finished, return to the Network Settings menu and select **Set** to apply your settings.

9 Press the **Menu** button to exit the menu system.

## Install the optional software

Download the Epson iProjection™ software and operation guide from your product's support page (see "Where to get help") and install the program on each computer that will project over the network.

To monitor and control your projector over the network, download and install the Epson Projector Management software (Windows only) and operation guide from your product's support page (see "Where to get help").

## Project over a network

If you need to configure the projector for a wired network, see "Wired network configuration" on the front of this sheet.

1 Press the **LAN** button on the remote control. You see this screen:

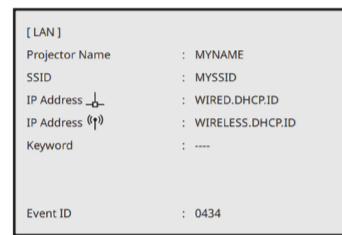

2 Start Epson iProjection on your computer. **Windows 10:** Select  > **EPSON Projector > Epson iProjection VerX.XX.**

**Windows 8.x:** Navigate to the **Apps** screen and select **Epson iProjection Ver. X.XX.**

**Windows 7:** Select  or **Start > Programs** or **All Programs > EPSON Projector > Epson iProjection > Epson iProjection Ver X.XX.**

**macOS:** Double-click the **Epson iProjection** icon in the Applications folder.

3 Select **Advanced Connection Mode** and click **OK**.

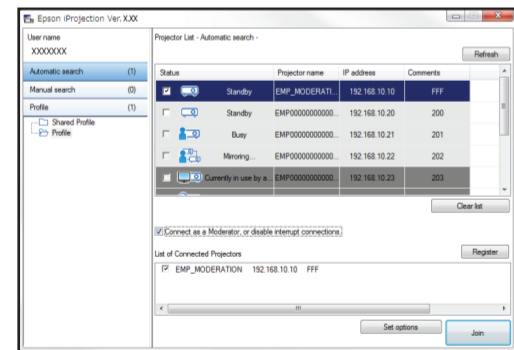

4 Select the projector you want to connect to, then click **Join**.

If you don't see the projector you want, click the **Automatic search** button to find the projector automatically, click the **Manual search** button to enter the projector's IP address, or click the **Profile** button to find the projector based on a previously saved profile.

5 If you see a message asking for a keyword, enter the four digits that appear on the LAN standby screen and click **OK**.

Your computer image is projected, with a floating toolbar:



When you're done presenting, click **Disconnect All** on the toolbar.

## Using the Epson iProjection app

You can project wirelessly from a mobile device (iOS, Android™, or Chromebook™) using the Epson iProjection app and a QR code.

1 Scan the following QR code to download and install the Epson iProjection app.



2 If you connected the projector to a network wirelessly, make sure to connect your mobile device to the same network.

3 Press the **LAN** button on the remote control to display a QR code on the projector screen.

4 Start Epson iProjection on your mobile device.

5 Use the QR code reader feature to read the QR code displayed.

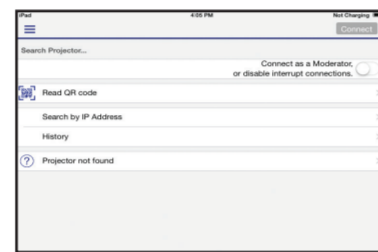

6 Follow the app instructions to connect your device to the projector.

For more information on setting up and using this app, visit [www.epson.com/projectorapp](http://www.epson.com/projectorapp) (U.S.), [www.epson.ca/projectorapp](http://www.epson.ca/projectorapp) (Canada), or [www.latin.epson.com/iprojection](http://www.latin.epson.com/iprojection) (Caribbean).

## Using web remote

You can use a standard web browser to control the projector through the network. A virtual remote control on your computer screen lets you perform many of the same functions as you can with the physical remote control.

1 Open your web browser and enter the IP address of the projector you want to monitor in the browser's address bar.

If you're not sure what the IP address of the projector is, turn the projector on and select **Wired LAN Info** or **Wireless LAN Info** from the Network menu to display the IP address of the projector. (Do not enter the leading zeroes.)

2 Enter **EPSONWEB** as the default user name and **admin** as the default password, then click **OK**. The Epson Web Control menu opens.

3 Select **Basic Control**. If you see a login screen, enter **EPSONREMOTE** as the user name and **guest** as the password.

4 Use the on-screen buttons to operate the projector, as you would using the remote control. See the online *User's Guide* for details.

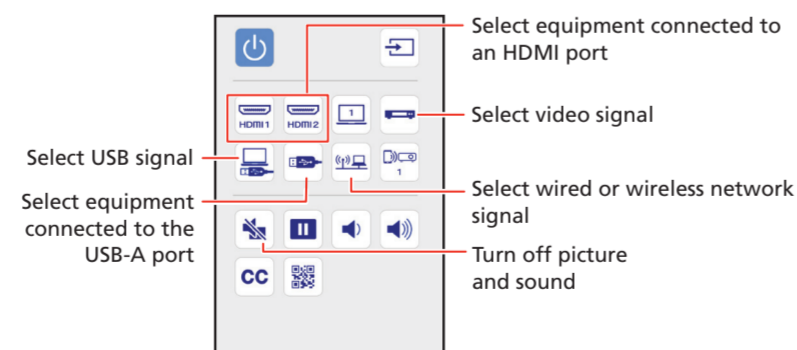

## Managing content

You can manage content from your computer using the Epson Projector Content Manager software, or over the network using a web browser (Epson Web Control) or the Epson iProjection app.

### Using the Content Manager software

The Epson Projector Content Manager software allows you to add images and movies to playlists and load them easily and directly to your projector via USB for playback.

**Note:** Download and install the Epson Projector Content Manager software from your product's support page (see "Where to get help"). For more information, see the online Epson Projector Content Manager Operation Guide or the online User's Guide.

## Troubleshooting

If you see a blank screen or the **No signal** message after turning on your computer or video device, check the following:

- Make sure the Status light on the projector is blue and not flashing.
- Press the **Source Search** button on the projector or the remote control to switch to the correct image source, if necessary.
- Press the **Home** button on the projector or remote control to verify the source input and settings.
- If you're using a Windows laptop, press the function key on your keyboard that lets you display on an external monitor. It may be labeled **CRT/LCD** or have an icon such as . You may have to hold down the **Fn** key while pressing it (such as **Fn + F7**). Wait a moment for the display to appear.
  - On Windows 7 or later, hold down the Windows key and press **P** at the same time, then click **Duplicate**.
- If you're using a Mac laptop, open **System Preferences** and select **Displays**. Click the **Arrangement** tab and select the **Mirror Displays** checkbox.
- Make sure A/V Mute is not enabled. Press the **A/V Mute** button on the remote control and make sure the projector's lens cover is all the way open.

## Registration

Register today to get product updates and exclusive offers. You can register online at [www.epson.com/webreg](http://www.epson.com/webreg).

## Where to get help

### Manuals

For more information about using the projector, see the online manuals. You can view or download the manuals from the Epson website, as described below.

### Internet support services

Visit [www.epson.com/support](http://www.epson.com/support) (U.S.) or [www.epson.ca/support](http://www.epson.ca/support) (Canada) and search for your product to download software and utilities, view manuals, get FAQs and troubleshooting advice, or contact Epson.

### Telephone support

To use the Epson PrivateLine® Support service, call (800) 637-7661. This service is available for the duration of your warranty period. You may also speak with a support specialist by calling (562) 276-4394 (U.S.) or (905) 709-3839 (Canada).

Support hours are 6 AM to 8 PM, Pacific Time, Monday through Friday, and 7 AM to 4 PM, Pacific Time, Saturday. Days and hours of support are subject to change without notice. Toll or long distance charges may apply.

## Optional accessories

For a list of optional accessories, see the online *User's Guide*.

You can purchase screens or other accessories from an Epson authorized reseller. To find the nearest reseller, call 800-GO-EPSON (800-463-7766). Or you can purchase online at [www.epsonstore.com](http://www.epsonstore.com) (U.S. sales) or [www.epsonstore.ca](http://www.epsonstore.ca) (Canadian sales).



EPSON and PowerLite are registered trademarks. Epson iProjection is a trademark, and EPSON Exceed Your Vision is a registered logomark of Seiko Epson Corporation.

PrivateLine is a registered trademark of Epson America, Inc.

Mac, macOS, and OS X are trademarks of Apple Inc., registered in the U.S. and other countries.

Windows is a registered trademark of Microsoft Corporation in the United States and/or other countries.

Android and Chromebook are trademarks of Google LLC.

General Notice: Other product names used herein are for identification purposes only and may be trademarks of their respective owners. Epson disclaims any and all rights in those marks.

This information is subject to change without notice.

© 2020 Epson America, Inc., 8/20  
Printed in XXXXXX