

INSTRUCTION BOOK FOR
IDEA™ Screen
with Touch Interactive Bracket
for Epson BrightLink



A BRAND OF MILESTONE AV TECHNOLOGIES | www.milestone.com

USA P 866.977.3901 **E** info@da-lite.com

CANADA P 877.345.4329 **E** canadainfo@milestone.com

In British Columbia, Milestone AV Technologies ULC carries on business as MAVT Milestone AV Technologies ULC.

©2018 Milestone AV Technologies. DL-0724 (Rev. 0) 0418

Da-Lite is a registered trademarks of Milestone AV Technologies. All other brand names or marks are used for identification purposes and are trademarks of their respective owners. All patents are protected under existing designations. Other patents pending.

Disclaimer

Milestone and its affiliated corporations and subsidiaries (collectively "Milestone"), intend to make this manual accurate and complete. However, Milestone makes no claim that the information contained herein covers all details, conditions or variations, nor does it provide for every possible contingency in connection with the installation or use of this subject to change without notice or obligation of any kind. Milestone makes no representation of warranty, expressed or implied, regarding the information contained herein. Milestone assumes no responsibility for accuracy, completeness or sufficiency of the information contained in this document.

Da-Lite® is a registered trademark of Milestone AV Technologies. All rights reserved.

Important Safety Instructions

1. Read and understand all instructions before using.
2. Failure to provide adequate structural strength for this component can result in serious personal injury or damage to equipment! It is the installer's responsibility to make sure the structure to which this component is attached can support the weight of all equipment. Reinforce the structure as required before installing the component.
3. Use this projection screen only for its intended use as described in these instructions. Do not use attachments not recommended by the manufacturer.

Save These Instructions

Tools Required For Assembly

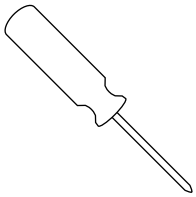

Phillips Screwdriver

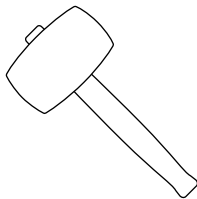

Rubber Mallet

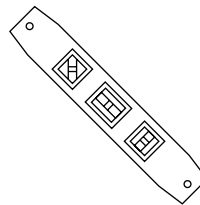

Level

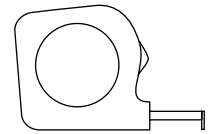

Measuring Tape



7mm Wrench

Hardware Provided

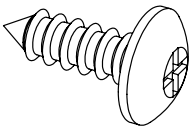

(9) #8 x 1/2" Screws

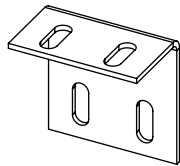

(2) L-Brackets

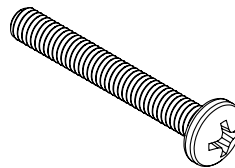

(2) M4 x 30mm
Screws



(2) M4 Nuts



(1) Wall Bracket

Cleaning

Everyday Cleaning: The supplied foam eraser can be used to clean marks on the screen surface made by everyday dry erase marker usage. Do not use spray cleaner in combination with the foam eraser.

Thorough Cleaning: For periodic full screen cleaning or to clean persistent marks from dry erase markers, use the supplied Da-Lite spray cleaner and cleaning cloth. Use clean or dry sections of the microfiber cloth when erasing the screen. This is important to prevent smearing on the screen while cleaning. To clean permanent markers and other unintentional marks on the surface, use the supplied foam eraser or the Da-Lite spray cleaner and cleaning cloth.

Preparation

Note: It requires two people to assemble an IDEA Screen. To maintain optimal projected image geometry and screen alignment, a flat and straight wall free from obstructions and angular distortions should be used.

Choose a clean work area for assembly using padded material or other soft, clean materials. The work area should be larger than the overall screen size and directly in front of the location where the screen is to be installed.

Assembly Instructions

1. Carefully unpack unit and place assembly on top of the clean work area. The viewing surface must face up.
2. Center marker tray to the bottom of frame and attach with (3) of the provided #8 x 1/2" screws. Insert screws through the tray into the groove (Figure 1).
3. Position the touch module bracket along the top of the IDEA Screen by locating the two notches along the back side of the frame. Using (2) provided #8 x 1/2" screws, attach the bracket to the IDEA frame with the touch module facing towards the audience. The front of the touch module bracket should be flush with the screen surface (Figure 1)

NOTE: The Da-Lite touch module bracket will be used in place of the mounting bracket provided with the projector's touch module.

NOTE: Do not rest the IDEA Screen on the marker tray while attaching the touch module bracket to avoid damaging the tray.

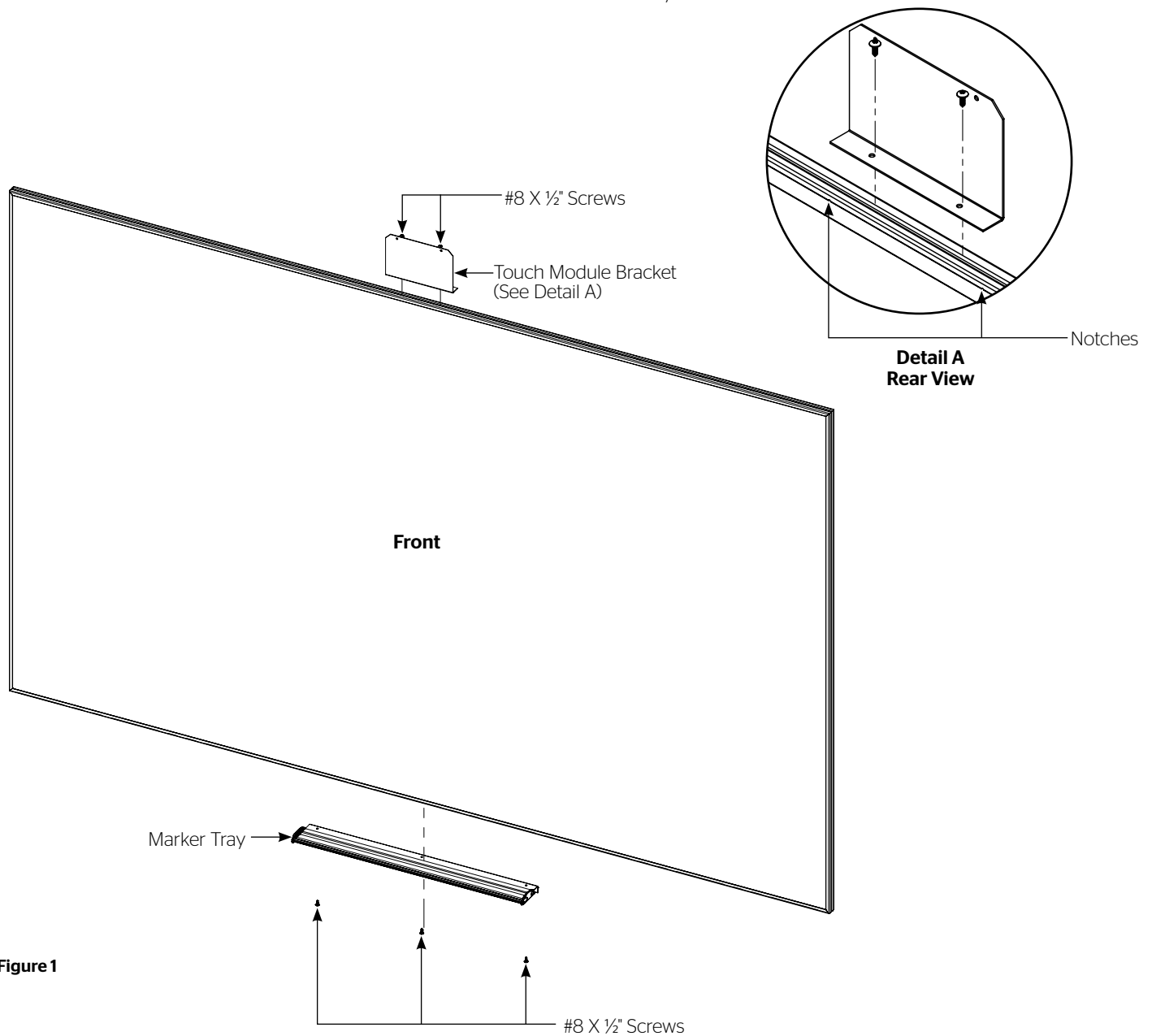

Figure 1

Wall Mounting Instructions

Determining Screen Placement: When installing the IDEA Screen with BrightLink projectors, you must leave at least 22" (56 cm) of space between the top of the screen and the ceiling to accommodate the projector wall mount.

NOTE: Use appropriate mounting hardware for the wall type and to accommodate for the screen's hanging weight (Figure 2). Hardware is not provided.

1. Secure the wall bracket to wall studs at the desired height. Center the wall bracket with the screen frame. You will need at least 1" clearance above the drilled holes to hang the screen (Figure 2).
2. To install the (2) L-brackets, you must measure the overall height of the screen frame and subtract 1 $\frac{1}{8}$ " (29 mm). Using that dimension, measure down from the top edge of the wall brackets and mark the wall for two screw holes. The outside edge of each L-bracket must be no greater than 5" (127 mm) away from the left and right edges of the screen frame (Figure 2).

3. Secure the two L-brackets to the wall at the marked locations. The longest side of the two L-brackets should be pointing upwards when secured in order to hide the L-brackets behind the screen frame once the screen is installed.

NOTE: The L-brackets are necessary to maintain a flat surface for touch interactivity.

4. This step requires two people. Hang the screen on the wall brackets. There is a lip on the back of the frame that wedges itself into the wall brackets once fully installed. Ensure that the screen clears the L-brackets and that the screen weight is on the wall brackets, not the L-brackets.

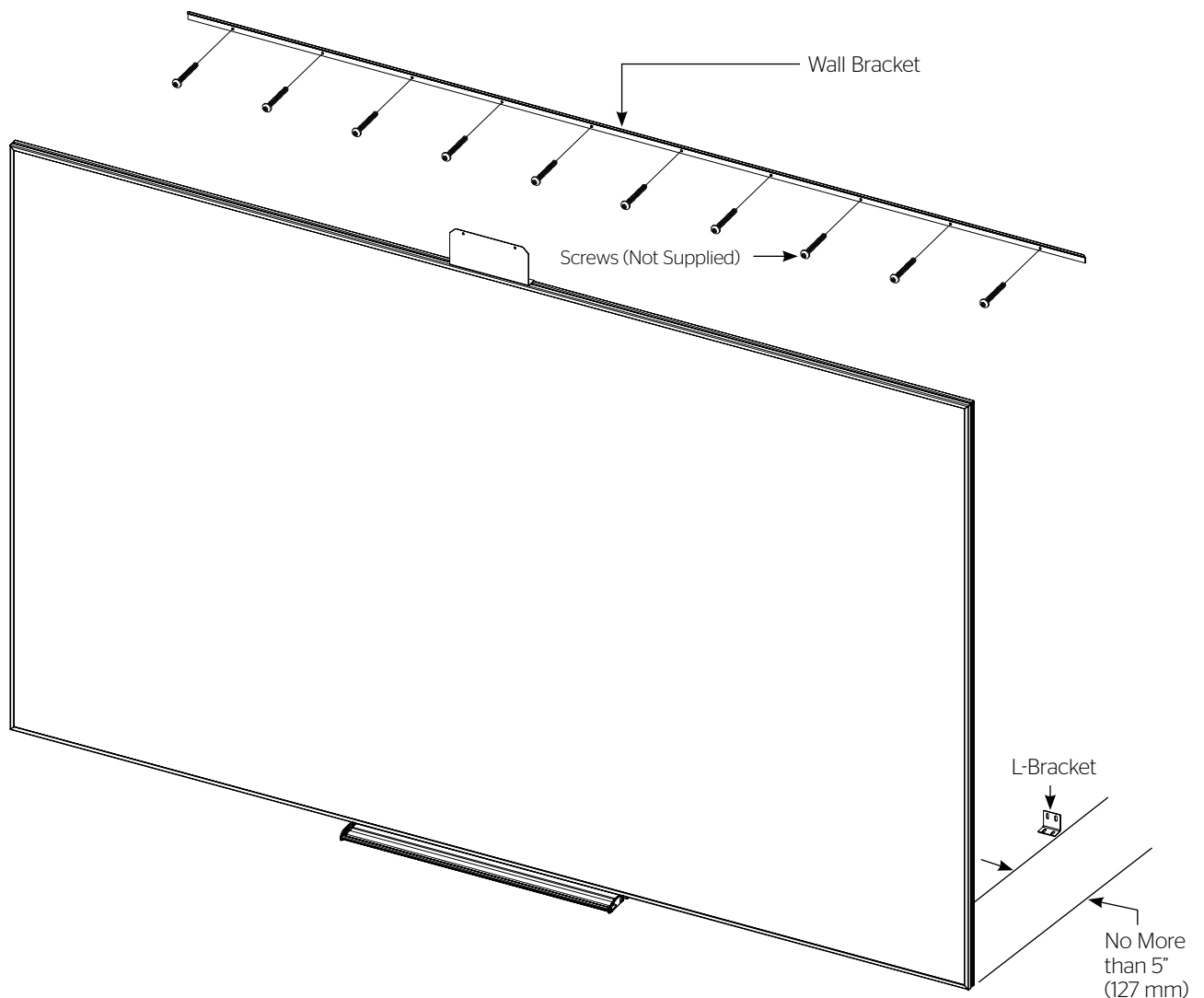
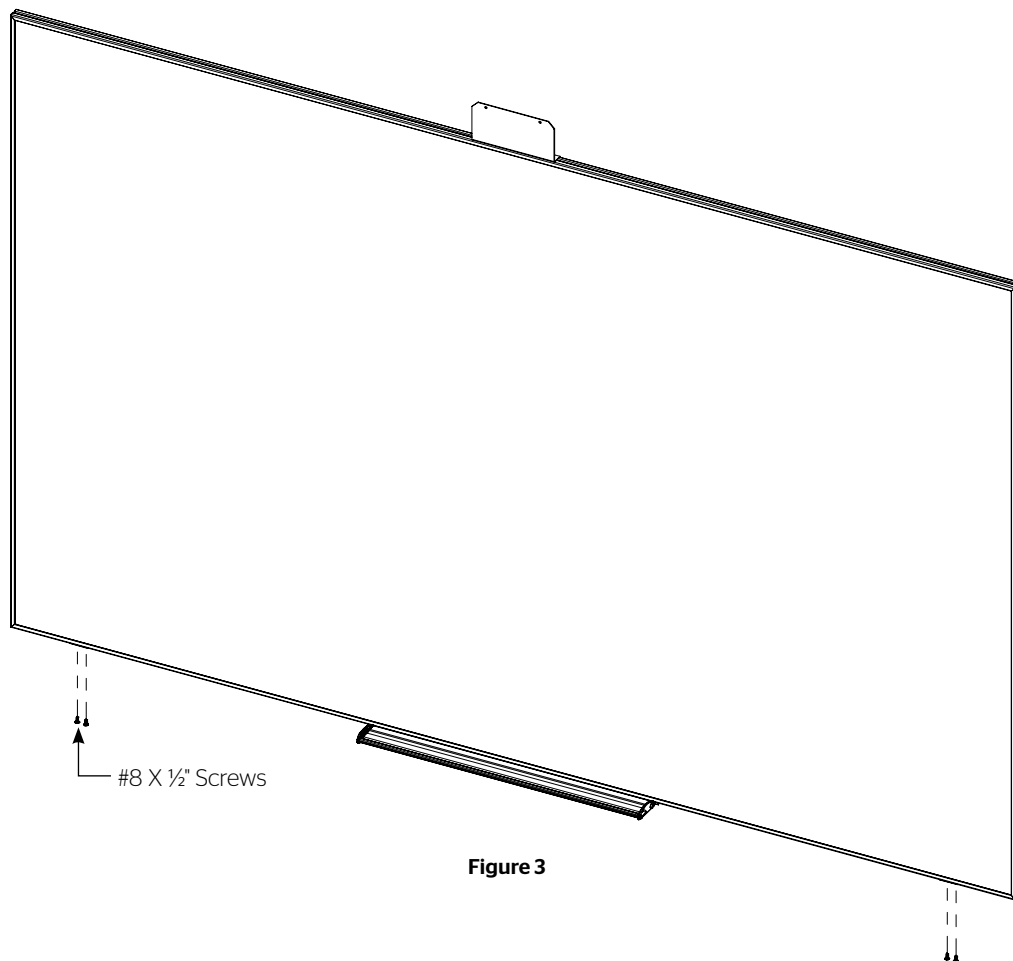

Figure 2

Wall Mounting Instructions (continued)

5. Tap the bottom of the two L-brackets with the rubber mallet until they make contact with the frame. Secure the two L-brackets to the frame with the remaining (4) #8 x 1/2" screws (Figure 3).
6. Attach bottom of screen to wall through the mounting holes located under the marker tray.



Attaching Touch Module

1. Remove the cover from the touch module provided with the interactive projector. Using the provided M4 x 30mm screws and M4 nuts, attach the touch module to the touch interactive bracket as shown (Figure 4).

NOTE: The touch module can attach to the bracket with hardware or magnets. Hardware attachment is recommended.

2. Follow interactive projector's instructions for aligning and calibrating the IR curtain.

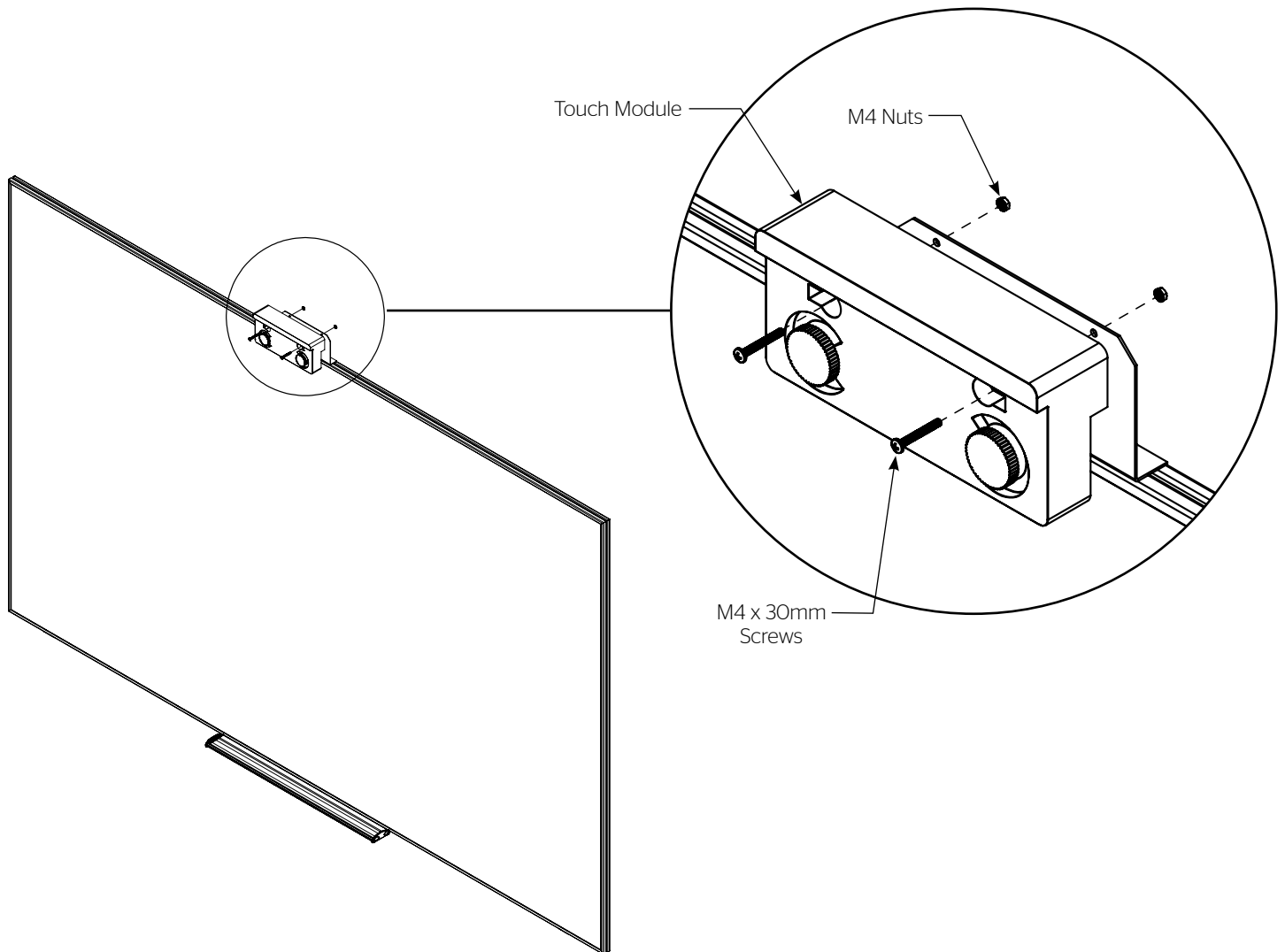

Figure 4

LIMITED FIVE YEAR WARRANTY ON DA-LITE IDEA™ PRODUCTS ONLY

Milestone AV Technologies LLC warrants these Da-Lite branded products to the original purchaser only, to be free from defects in materials and workmanship for a period of five (5) years from the date of purchase by the original purchaser; provided they are properly operated according to Da-Lite's instructions and are not damaged due to improper handling or treatment after shipment from the factory.

This warranty does not apply to equipment showing evidence of misuse, abuse or accidental damage, or which has been tampered with or repaired by a person other than authorized Da-Lite personnel.

Da-Lite's sole obligation under this warranty shall be to repair or to replace (at Da-Lite's option) the defective part of the merchandise. Returns for service should be made to your Da-Lite dealer. If it is necessary for the dealer to return the screen or part to Da-Lite, transportation expenses to and from Da-Lite are payable by the purchaser and Da-Lite is not responsible for damage in shipment.

To protect yourself against damage or loss in transit, insure the product and prepay all transportation expenses.

TO THE MAXIMUM EXTENT PERMITTED BY APPLICABLE LAW, THIS WARRANTY IS IN LIEU OF ALL OTHER WARRANTIES, EXPRESS OR IMPLIED, INCLUDING WARRANTIES AS TO FITNESS FOR USE AND MERCHANTABILITY. Any implied warranties of fitness for use, or merchantability, that may be mandated by statute or rule of law are limited to the five (5) year warranty period. This warranty gives you specific legal rights, and you may also have other rights, which vary from state-to-state. **TO THE MAXIMUM EXTENT PERMITTED BY APPLICABLE LAW, NO LIABILITY IS ASSUMED FOR EXPENSES OR DAMAGES RESULTING FROM INTERRUPTION IN OPERATION OF EQUIPMENT, OR FOR INCIDENTAL, DIRECT, OR CONSEQUENTIAL DAMAGES OF ANY NATURE.**

In the event that there is a defect in materials or workmanship of a Da-Lite product, you may contact our Customer Care Specialists at 3100 North Detroit Street, Warsaw, IN 46582, (574) 267-8101, (800) 622-3737.

IMPORTANT: THIS WARRANTY SHALL NOT BE VALID AND DA-LITE BRANDED PRODUCTS SHALL NOT BE BOUND BY THIS WARRANTY IF THE PRODUCT IS NOT OPERATED IN ACCORDANCE WITH THE DA-LITE WRITTEN INSTRUCTIONS.

Keep your sales receipt to prove the date of purchase and your original ownership.