

# THE WALLABY - ASSEMBLY INSTRUCTIONS

## Assembly Parts list

- A. (6) Black Screw Covers
- B. (2) 1/4-20 x 3.50 Hex Head Bolts
- C. (1) 5/32 Allen Wrench
- D. (2) Fender Washers
- E. (2) Acorn Nuts
- F. (3) 1/4-20 x 7/8 BHCS
- G. (2) Thick Black Washers
- H. (1) 7/16 Wrench
- I. (2) Locking Star Washers

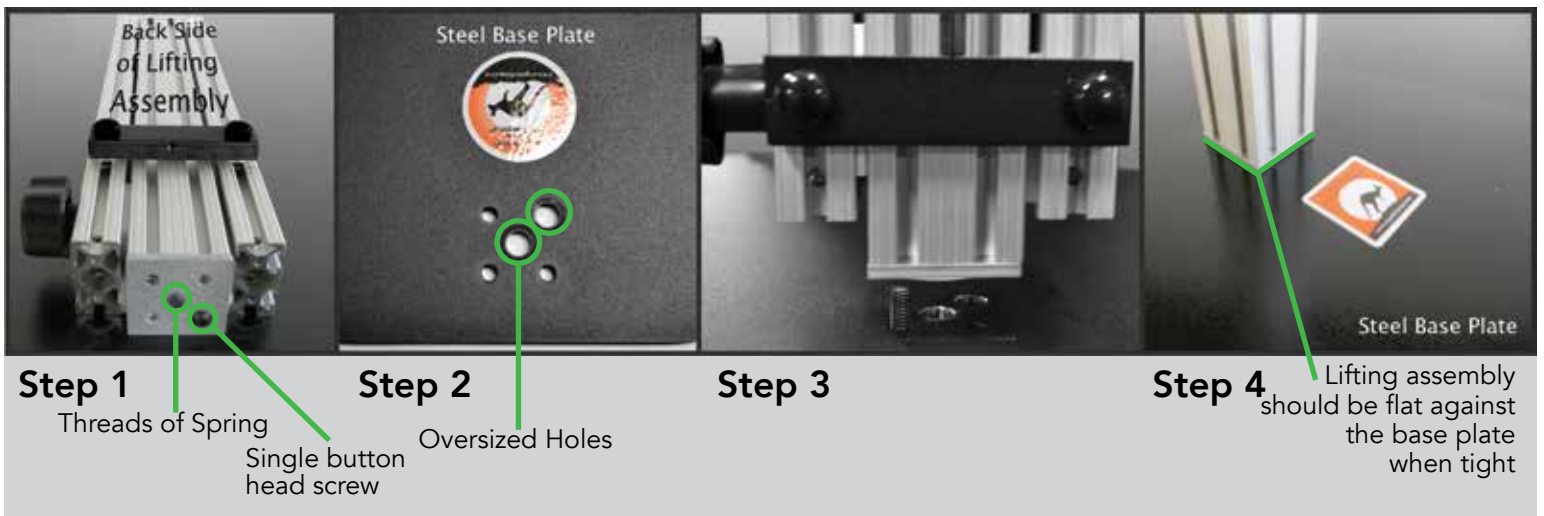

**Step 1:** Lay the lifting assembly on a solid surface with the back side up as shown. Notice the single Button Head Bolt in the assembly union plate. **DO NOT LOOSEN THE SINGLE BUTTON HEAD BOLT THAT IS NOTATED.**

**Step 2:** Notice the (2) oversized holes in the Base Plate. The Single Button Head Bolt will go into the oversized hole on the top right, while the other 3 holes should line up with the base. The center oversized hole is not used with this unit.

**Step 3:** With the Base Plate over hanging the table about 2 inches, hold the Lifting Assembly above the Base Plate and align the Single Button Bolt into the oversized hole. Place one 1/4-20 x 7/8 BHCS{F} through the base plate to screw in the lifting assembly.

**Step 4:** Insert and thread the other (2) 1/4-20 x 7/8 BHCS{F} through the Base Plate and into the Lifting Assembly. Once all (3) bolts are threaded in, tighten securely with the 5/32 allen wrench{C}. Lifting Assembly should be flat against the Base and all three bolts should look like the picture above.

# THE WALLABY - ASSEMBLY INSTRUCTIONS



**Step 5:** Put (1) Locking Star Washer{I} on each of the 1/4 –20 x 3.50 Hex Head Bolts{B}.

**Step 6:** Insert the (2) 1/4-20 x 3.50 Hex Head Bolts{B} through the holes in the Vertical Rail.

**Step 7:** Put (1) Fender Washer{D} on each of the 1/4-20 x 3.50 Hex Head Bolts{B} on the other side of the Vertical Rail.

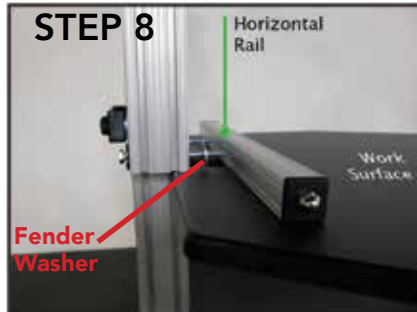

**Step 8:** Lift the Work Surface up and align the holes in the Horizontal Rail with the (2) 1/4-20 x 3.50 Hex Head Bolts{B}. Push the Work Surface onto the Hex Head Bolts until the threads of the bolts come through the Horizontal Rail.



**Step 9:** Put (1) Black Washer{G} and (1) Acorn Nut{E} on the end of each of the Hex Head Bolts. Using the 7/16 wrench{H} tighten the Acorn Nuts securely.

**Step 10:** Follow the instructions below to mount your monitor. Then place your monitor on the unit without tightening the set screw mentioned in step 2. *Is the monitor height right for you in the seated and standing position?* If not, remove the monitor by sliding part A out of part B(mentioned below), and adjust the height of part B by loosening each of the notated four bolts **BY ONLY HALF A TURN**, with the provided 7/16 wrench{H}. Adjust to your height and tighten the 4 bolts securely. Use 4 black caps to cover the exposed bolts once completed.

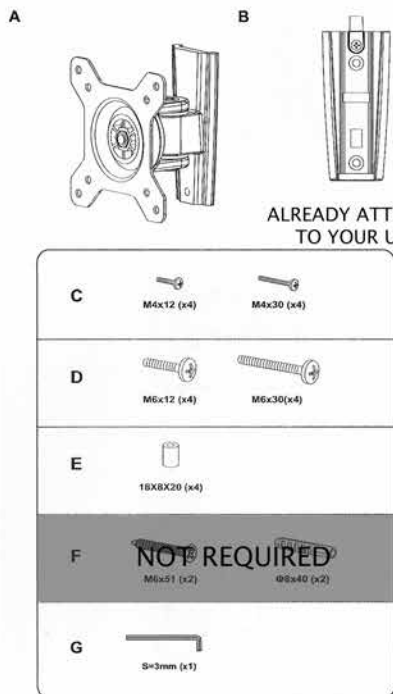

1. Try using the shortest screw to mount your monitor to prevent screwing into the internal components of the monitor.

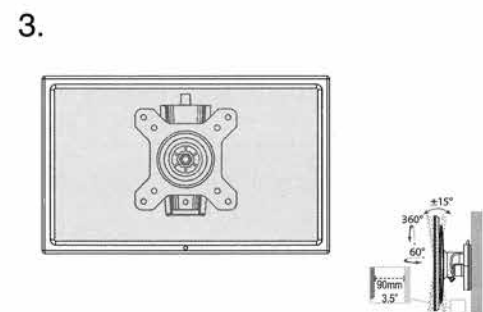
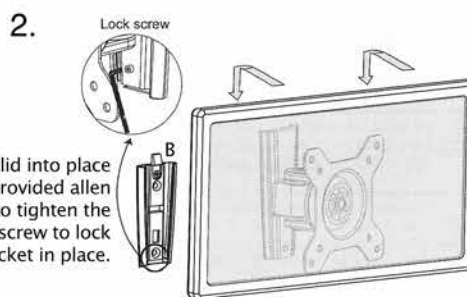
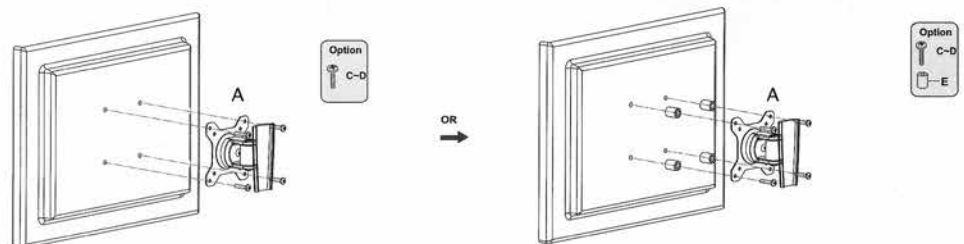

# THE WALLABY



The Wallaby is designed to hold your monitor mounted in a fixed position, and will travel up and down with your keyboard and mouse on the work surface. Your Wallaby is shipped in the down position with the work surface brake tightened. The mount may need adjusted to your desired height for both the seated and standing position.

The Wallaby has (1) spring that assists in raising your unit to the standing position and works best when your monitor and keyboard are in place. This reduces the amount of pressure needed to lower the unit.

Always push down with both hands on the horizontal rear rail when lowering the work surface.

## HOW TO USE THE WALLABY

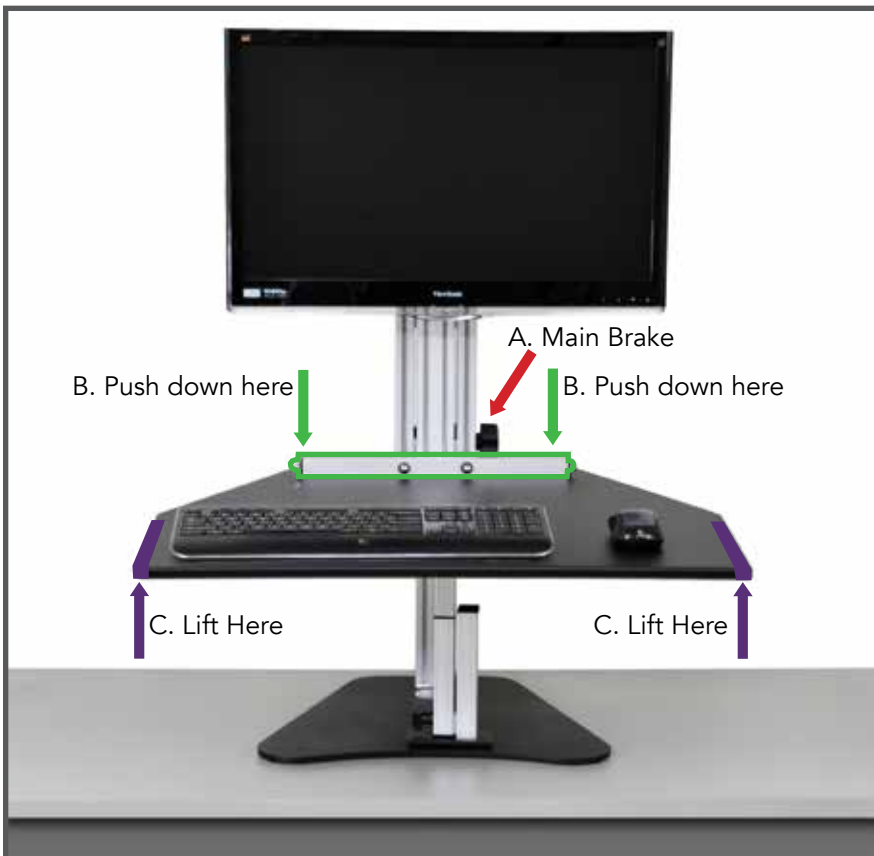

To raise the Wallaby, loosen the main brake(A) and lift the main work surface on the sides(C & C).

To lower the Wallaby, loosen the main brake(A) and lean into the unit using your upper body weight pushing down with both hands on the horizontal bar at the rear of the main work surface (B & B).

A. Main Brake

B. Work Surface Rail

C. Main Work Surface

# ADJUST THE STOPPING BOLT

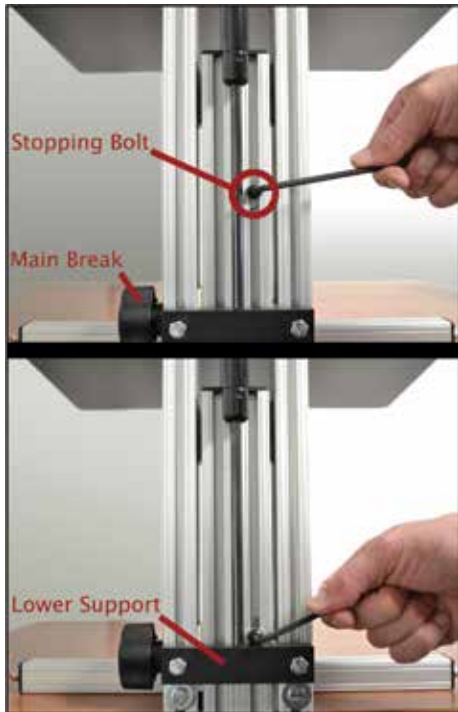

On the back side of your unit you will notice a small bolt located on the lifting tower. This bolt is used as our work surface stopper. It is currently set at 15", the highest our unit should go. This setting is for a 6'2" user on a 30" high desk. If you are shorter than this, raise the unit to your desired height and tighten the Main Brake. Adjust the stopping bolt by loosening the bolt **with one turn** and drop the bolt down to reach the lower support, and re-tighten the stopping bolt.

If you are a taller individual and need to raise the stopping bolt, please note that the work surface can get up to 16 1/2 inches but you will be raising the unit into the oil dampening zone of the spring. This makes it a little more difficult to lower the unit into the seated position when raised to this maximum point.

Our work surface should only be raised to your belt or navel line. This creates a 90-110 degree angle in your elbows which is suggested in the standing position. This will also allow you to lower the unit with ease by simply transferring your upper body weight into the back of the unit.

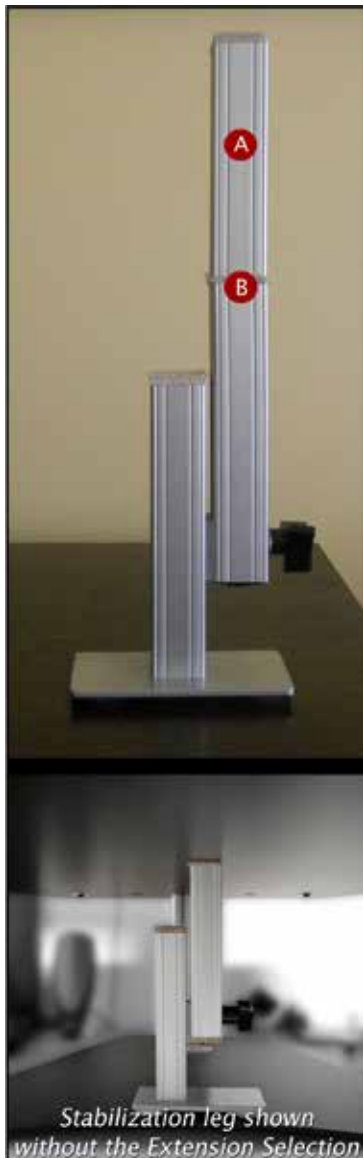

## THE STABILIZATION LEG

Your adjustable height desk top unit comes with an adjustable leg that can be used to give you maximum stability when you are using "The Kangaroo" in the standing position.

Raise the Kangaroo work surface to your desired standing height and tighten the work surface brake.

Place the adjustable leg under the work surface and loosen the adjustable leg brake. Only loosen the brake by a turn or two, too much and the brake will disengage from the slot.

Extend the adjustable leg until it engages the bottom of the work surface and then tighten the adjustable leg brake.

The leg is shipped with the extension section installed to give you additional height adjustment. If this is too tall for your application, simply unscrew the extension selection.

**A** Extension selection

**B** Screws into here

**ALWAYS REMEMBER TO REMOVE THE STABILIZATION LEG BEFORE LOWERING YOUR WORK SURFACE**

Stabilization leg shown without the Extension Selection

# THE WALLABY ELITE - ASSEMBLY INSTRUCTIONS

## Assembly Parts list

- A. (6) Black Screw Covers
- B. (2) 1/4-20 x 3.50 Hex Head Bolts
- C. (1) 5/32 Allen Wrench
- D. (2) Fender Washers
- E. (2) Acorn Nuts
- F. (3) 1/4-20 x 7/8 BHCS
- G. (2) Thick Black Washers
- H. (1) 7/16 Wrench
- I. (2) Locking Star Washers

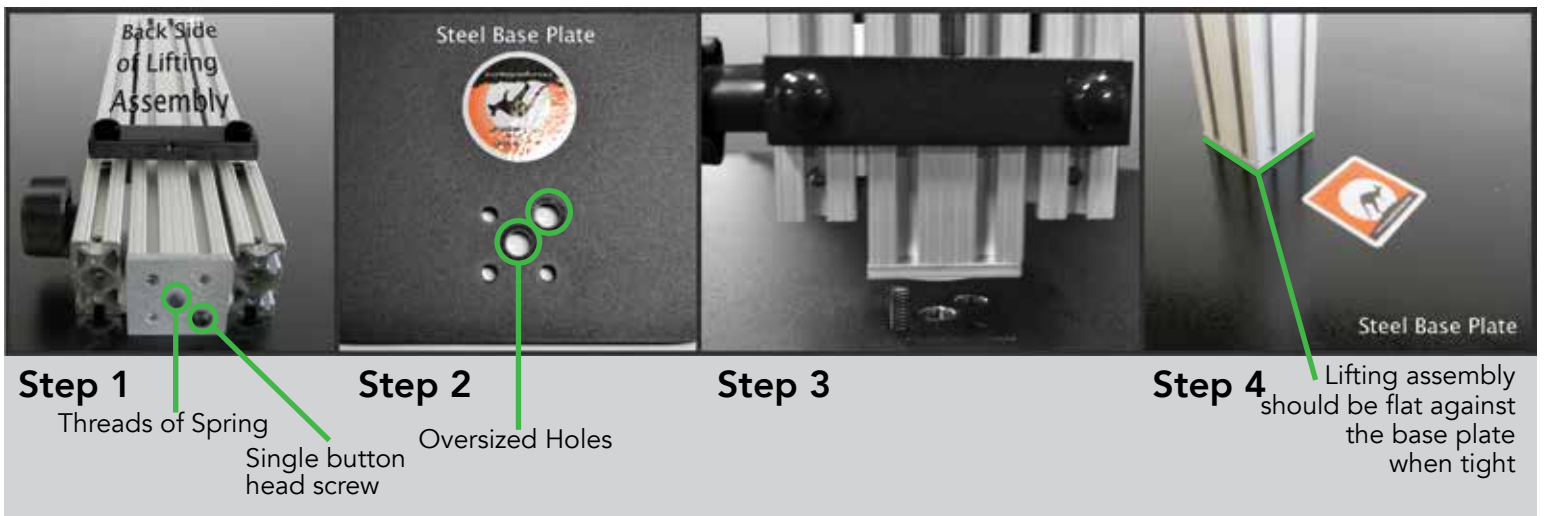
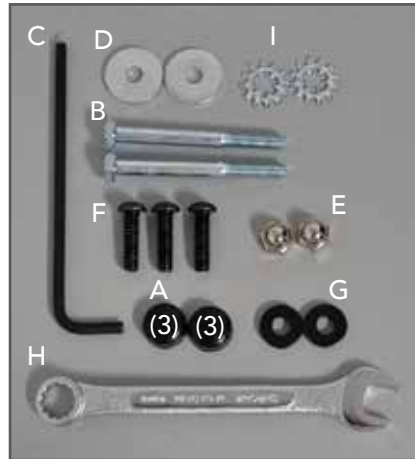

**Step 1:** Lay the lifting assembly on a solid surface with the back side up as shown. Notice the single Button Head Bolt in the assembly union plate. **DO NOT LOOSEN THE SINGLE BUTTON HEAD BOLT THAT IS NOTATED.**

**Step 2:** Notice the (2) oversized holes in the Base Plate. The Single Button Head Bolt will go into the oversized hole on the top right, while the other 3 holes should line up with the base. The center oversized hole is not used with this unit.

**Step 3:** With the Base Plate over hanging the table about 2 inches, hold the Lifting Assembly above the Base Plate and align the Single Button Bolt into the oversized hole. Place one 1/4-20 x 7/8 BHCS{F} through the base plate to screw in the lifting assembly.

**Step 4:** Insert and thread the other (2) 1/4-20 x 7/8 BHCS{F} through the Base Plate and into the Lifting Assembly. Once all (3) bolts are threaded in, tighten securely with the 5/32 allen wrench{C}. Lifting Assembly should be flat against the Base and all three bolts should look like the picture above.



# THE WALLABY ELITE - ASSEMBLY INSTRUCTIONS



**Step 5:** Put (1) Locking Star Washer{I} on each of the 1/4 –20 x 3.50 Hex Head Bolts{B}.

**Step 6:** Insert the (2) 1/4-20 x 3.50 Hex Head Bolts{B} through the holes in the Vertical Rail.

**Step 7: Put (1) Fender Washer{D} on each of the 1/4-20 x 3.50 Hex Head Bolts{B} on the other side of the Vertical Rail.**

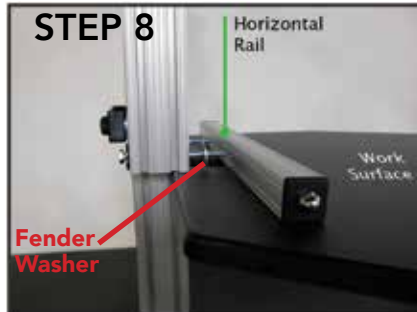

**Step 8:** Lift the Work Surface up and align the holes in the Horizontal Rail with the (2) 1/4-20 x 3.50 Hex Head Bolts{B}. Push the Work Surface onto the Hex Head Bolts until the threads of the bolts come through the Horizontal Rail.



**Step 9:** Put (1) Black Washer{G} and (1) Acorn Nut{E} on the end of each of the Hex Head Bolts. Using the 7/16 wrench{H} tighten the Acorn Nuts securely.

**Step 10:** Follow the instructions below to mount your monitors. Then place your monitors on the unit without tightening the set screw mentioned in step 2 below. *Is the monitor height right for you in the seated and standing position?* If not, remove the monitor by sliding part A out of part B(-mentioned below), and adjust the height of part B by loosening each of the notated four bolts **BY ONLY HALF A TURN**, with the provided 7/16 wrench{H}. Adjust to your height and tighten the 4 bolts securely. Use 4 black caps to cover the exposed bolts once completed.

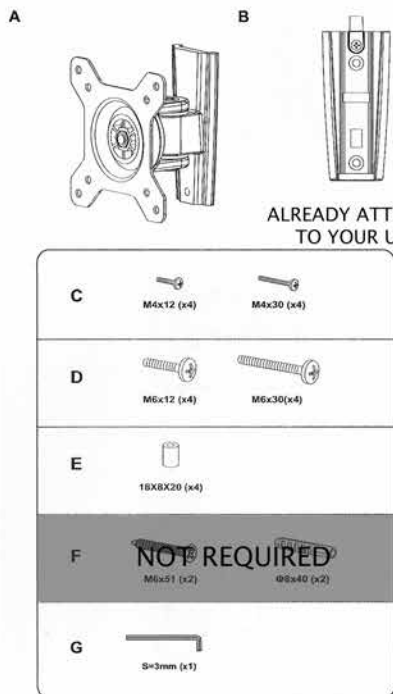

**1.** Try using the shortest screw to mount your monitor to prevent screwing into the internal components of the monitor.

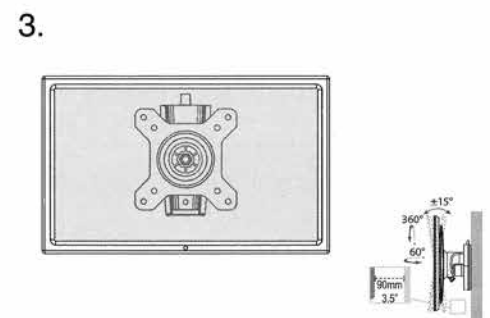
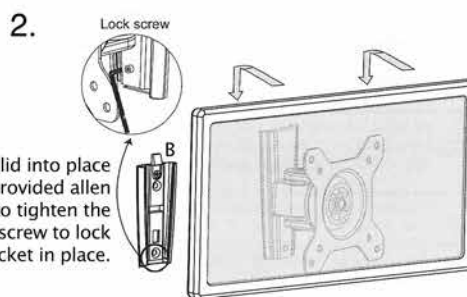
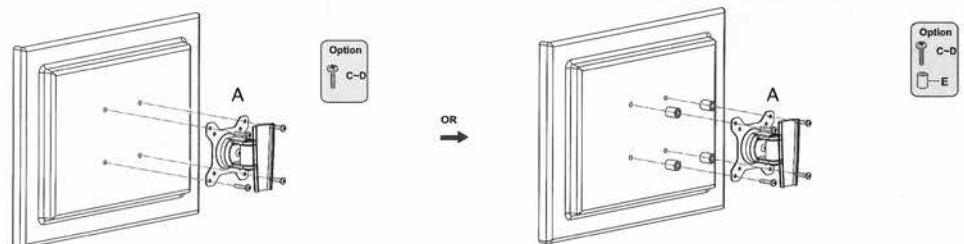

# THE WALLABY ELITE



The Wallaby Elite is designed to hold your monitors mounted in a fixed position, and will travel up and down with your keyboard and mouse on the work surface. Your Wallaby Elite is shipped in the down position with the work surface brake tightened. The mounts may need adjusted to your desired height for both the seated and standing position.

The Wallaby Elite has (1) spring that assists in raising your unit to the standing position and works best when your monitor and keyboard are in place. This reduces the amount of pressure needed to lower the unit.

Always push down with both hands on the horizontal rear rail when lowering the work surface.

## HOW TO USE THE WALLABY ELITE

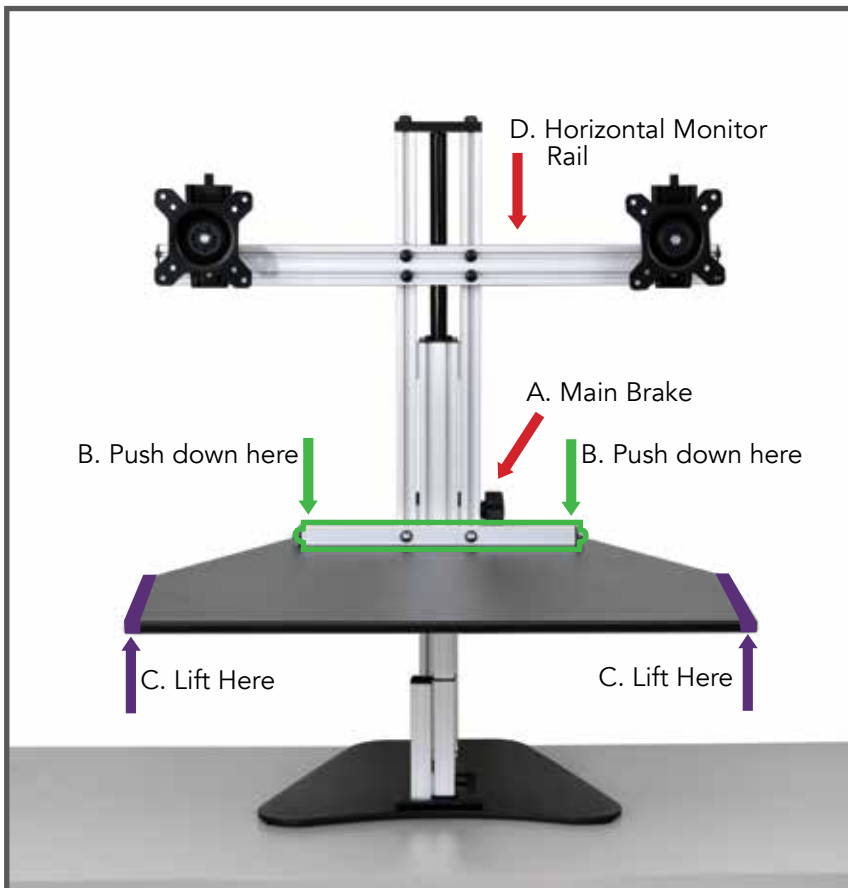

To move the mount horizontally closer or farther apart, simply loosen the bolt attached to the horizontal monitor rail (D) by a single turn with an 5/32 allen wrench. Once you have reached the desired position tighten the bolt.

To raise the Wallaby Elite, loosen the main brake(A) and lift the main work surface on the sides(C & C).

To lower the Wallaby Elite, loosen the main brake(A) and lean into the unit using your upper body weight pushing down with both hands on the horizontal bar at the rear of the main work surface (B & B).

A. Main Brake

B. Work Surface Rail

C. Main Work Surface

D. Horizontal Monitor Rail

# ADJUST THE STOPPING BOLT

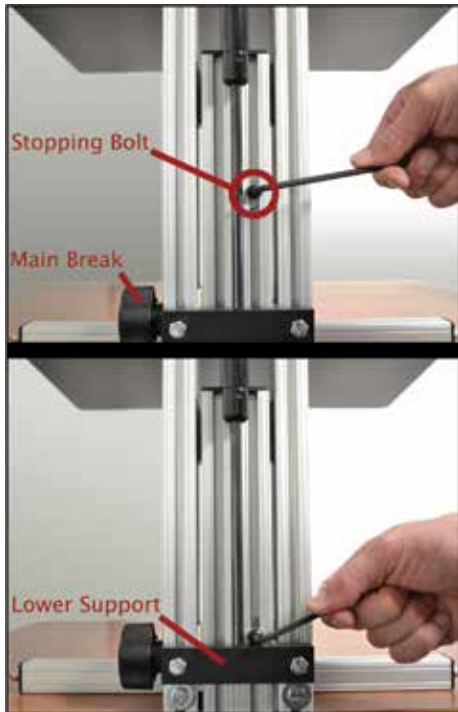

On the back side of your unit you will notice a small bolt located on the lifting tower. This bolt is used as our work surface stopper. It is currently set at 15", the highest our unit should go. This setting is for a 6'2" user on a 30" high desk. If you are shorter than this, raise the unit to your desired height and tighten the Main Brake. Adjust the stopping bolt by loosening the bolt **with one turn** and drop the bolt down to reach the lower support, and re-tighten the stopping bolt.

If you are a taller individual and need to raise the stopping bolt, please note that the work surface can get up to 16 1/2 inches but you will be raising the unit into the oil dampening zone of the spring. This makes it a little more difficult to lower the unit into the seated position when raised to this maximum point.

Our work surface should only be raised to your belt or navel line. This creates a 90-110 degree angle in your elbows which is suggested in the standing position. This will also allow you to lower the unit with ease by simply transferring your upper body weight into the back of the unit.

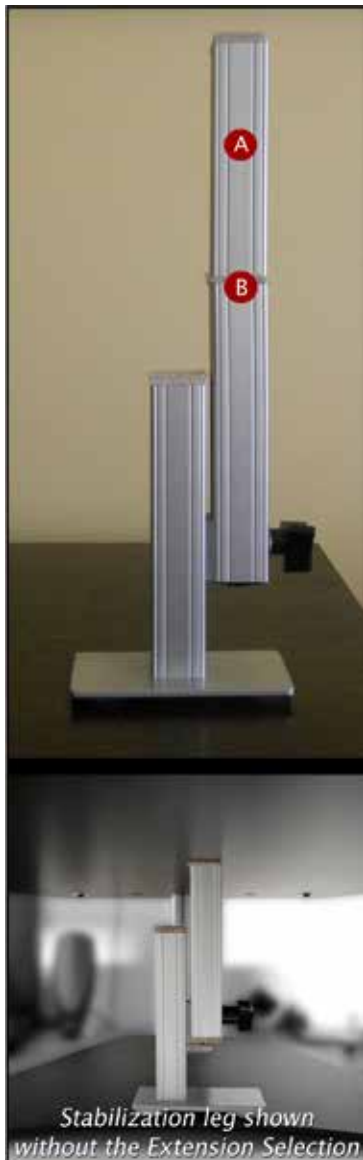

## THE STABILIZATION LEG

Your adjustable height desk top unit comes with an adjustable leg that can be used to give you maximum stability when you are using "The Kangaroo" in the standing position.

Raise the Kangaroo work surface to your desired standing height and tighten the work surface brake.

Place the adjustable leg under the work surface and loosen the adjustable leg brake. Only loosen the brake by a turn or two, too much and the brake will disengage from the slot.

Extend the adjustable leg until it engages the bottom of the work surface and then tighten the adjustable leg brake.

The leg is shipped with the extension section installed to give you additional height adjustment. If this is too tall for your application, simply unscrew the extension selection.

**A** Extension selection

**B** Screws into here

**ALWAYS REMEMBER TO REMOVE THE STABILIZATION LEG BEFORE LOWERING YOUR WORK SURFACE**