

Ergotron® LX

Dimensional & Range of Motion Illustrations

Wall Mount Keyboard Arm

Dimensions

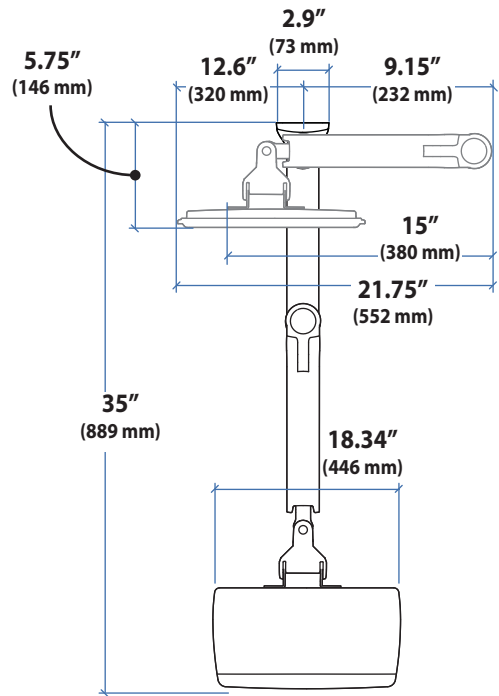
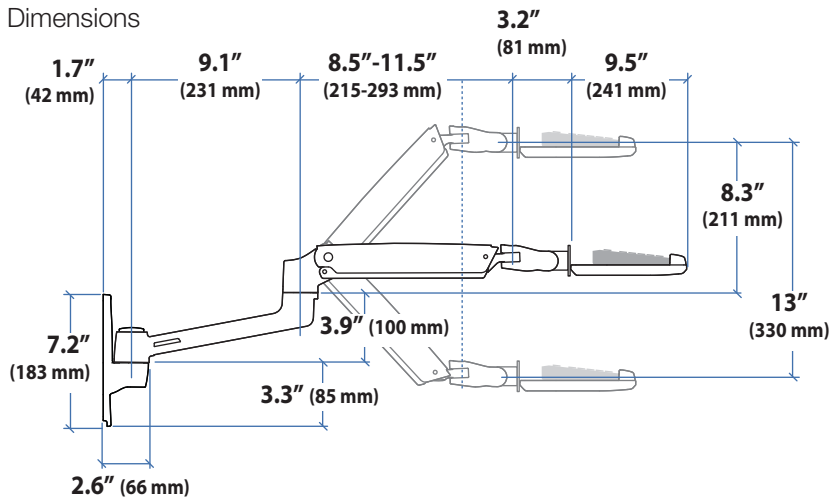

Wall Mount Bracket

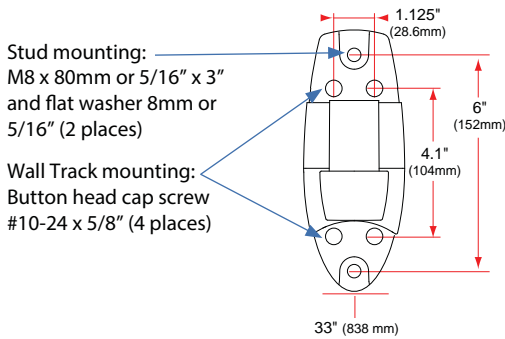

Weight Capacity

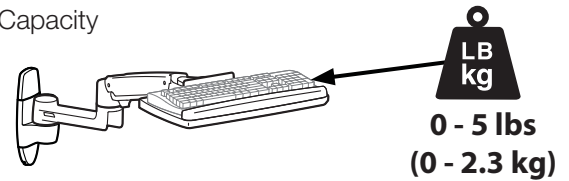

Range of Motion

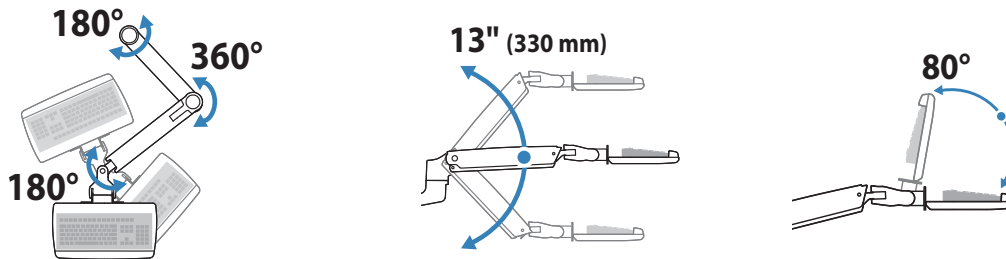

© 2014 Ergotron, Inc. rev. 06/02/2014 DIM-068 Content is subject to change without notification

Americas Sales and Corporate Headquarters

St. Paul, MN USA
(800) 888-8458
+1-651-681-7600
www.ergotron.com
sales@ergotron.com

EMEA Sales

Amersfoort, The Netherlands
+31 33 45 45 600
www.ergotron.com
info.eu@ergotron.com

APAC Sale

Tokyo, Japan
www.ergotron.com
apaccustomerservice@ergotron.com

Worldwide OEM Sales

www.ergotron.com
info.oem@ergotron.com

