

*The lower most range of motion for vertical lift is decreased up to 4.5" (114 mm) when arm is adjusted to hold over 20lbs (9 kgs).

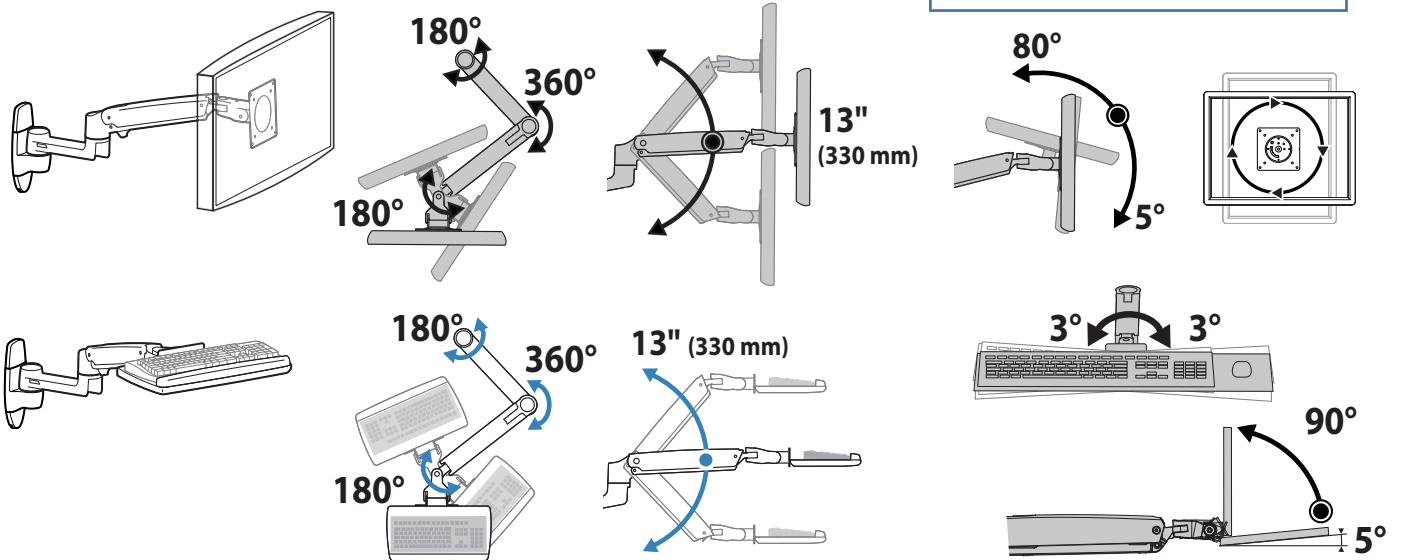

For the latest User Installation Guide please visit: www.ergotron.com

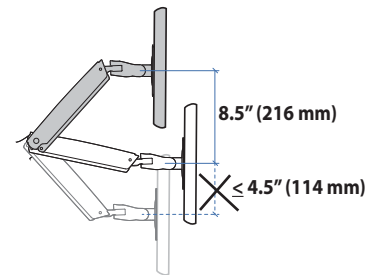

User's Guide - English
 Guía del usuario - Español
 Manuel de l'utilisateur - Français
 Gebruikersgids - Deutsch
 Benutzerhandbuch - Nederlands
 Guida per l'utente - Italiano
 Användarhandbok - svenska
 ユーザーガイド : 日本語
 用户指南 : 汉语



Includes
 Constant Force™
 Technology



www.ergotron.com

USA 1-800-888-8458
 Europe +31 (0)33-45 45 600
 China 400-120-3051

Components



	A	B	C	D
1	2x	1x	1x	14x
2	2x	2x	2x	14x
3	2x	1x	1x	7x
4	3x	4x	9x	7x
5	1x	2x	8x	1x
6	2x	2x	2x	1x
7	1x	2x	4x	4x
8	1x	2x	4x	1x
9	2x	4x	4x	1x
			2x	1x

ENGLISH

Tools Needed

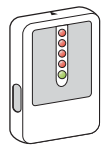
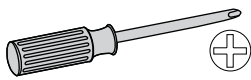

Stud Finder



Ø 1/2" (12.7 mm)
Hollow Wall
Pared
Mur
Wand
Muur
Parete
壁
Due montanti in legno massiccio

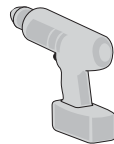

Solide Holzbalkenträger
Massief Houten Pilaren



Ø 3/16" (5 mm)

Wood
Madera
Bois
Solide Holz
木
木质
木質
板墙筋为不小于 25 标号的钢材

Studs ≥ 25 gauge steel
Pernos de acero de calibre ≥ 25
Goujons ≥ calibre 25 en acier
Bolzen ≥ Blechlehre Nr. 25
Verbindingsbouten ≥ 25 gauge staal
Prigionieri in acciaio spessore ≥ gauge 25 (0,556 mm)
Reglar ≥ 25-gauge stål
25ゲージのスティールよりも強力なスタッド

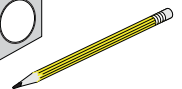
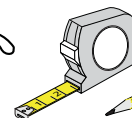
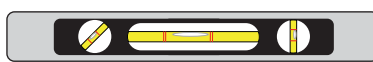
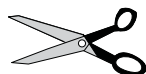

1 Mounting Height for Ergonomic Workstation

This mounting height is a recommendation for an ergonomic workstation that accommodates user heights of 5'0"-6'1" (152-185cm) when set up for standing and user heights of 5'0"-6'4" (152-193cm) when set up for sitting.

If user heights are different than this, you should change mounting height to accommodate user heights. (Change mounting height one inch for every one inch difference in user heights).

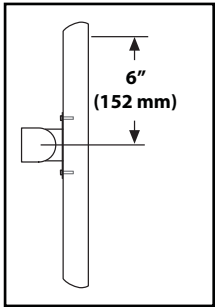

Mounting height assumes there is a 6" (152 mm) distance between the center of your monitor mounting holes and the top of the screen. If your distance is smaller, you should increase mounting height accordingly, if your distance is larger, you should decrease your mounting height accordingly.

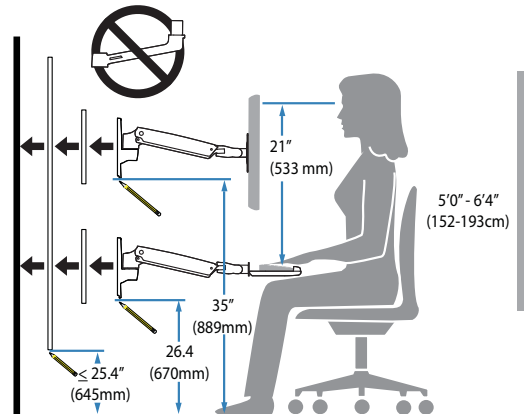
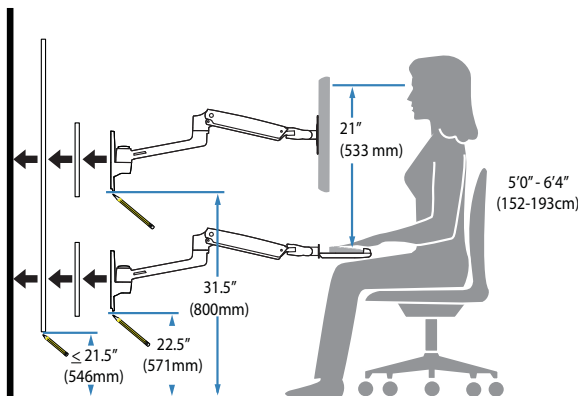
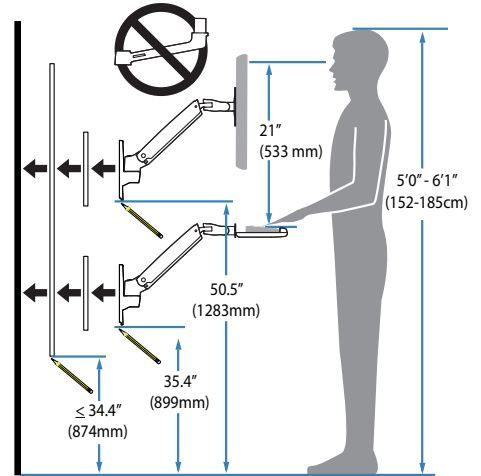
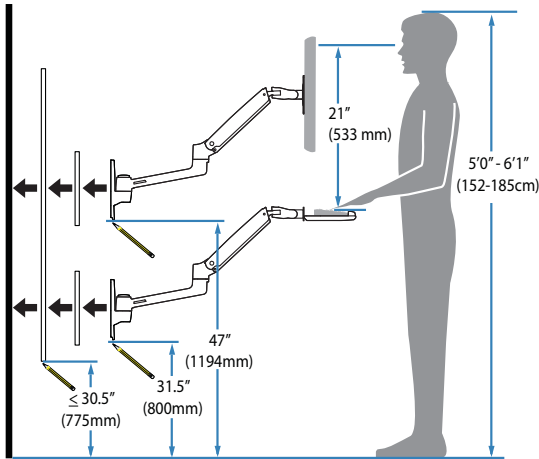

ENGLISH

Determine mounting location:

Front view with arm pushed back against the wall.

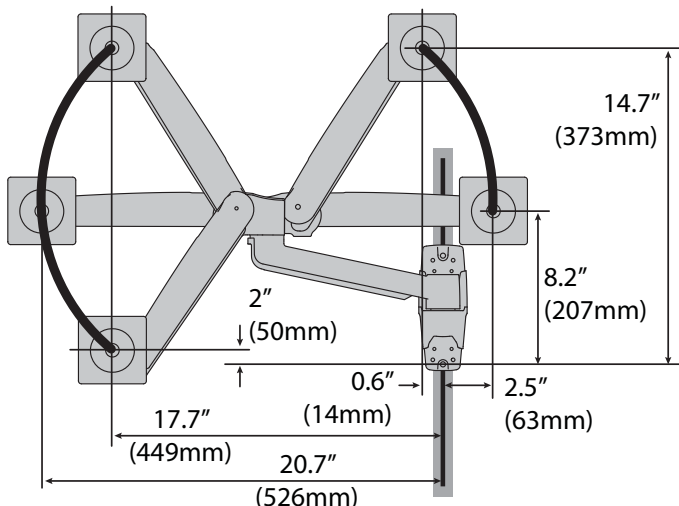

Top view showing range of motion when pulled out from the wall.

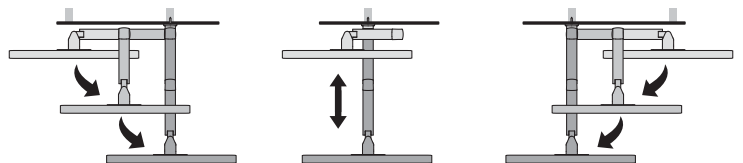

2

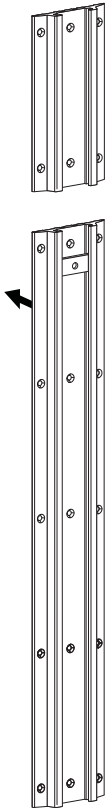

WARNING: Ensure that the wall structure is capable of supporting four times the total weight of mounted equipment. Mounting to wall surfaces that do not meet this criteria may result in an unstable, unsafe condition which could lead to personal injury and/or property damage. Consult a construction professional if you have any doubt about what this means in regard to your particular application.



CAUTION: Make sure the wall mount bracket is level, flush and snug to the wall surface. **DO NOT OVERTIGHTEN THE BOLTS.**

Wood
Madera
Bois
Solide Holzbalkenträger
Massief Houten Pilaren
Due montanti in legno massiccio
 木
 木质
 나무

Studs ≥ 25 gauge steel
Pernos de acero de calibre ≥ 25
Goujons ≥ calibre 25 en acier
Bolzen ≥ Blechlehre Nr. 25
Verbindingsbouten ≥ 25 gauge staal
Prigionieri in acciaio spessore ≥ gauge 25 (0,556 mm)
Reglar ≥ 25-gauge stål
 25ゲージのスチールよりも強力なスタッド
 板墙筋为不小于 25 标号的钢材

5

Hollow Wall
Pared
Mur
Wand
Muur
Parete
 壁
 墙壁

≥ 5/8"

Sheetrock
Sheetrock
Plaque de plâtre
Rigipsplatte
Sheetrock
Cartongesso
Gipsskiva
 シートロック
 石膏板

6

Requires minimum material thickness of 5/8" (16 mm).
 Requiere un grosor mínimo de 16 mm.
 Epaisseur minimum de 16 mm.
 Requer uma espessura mínima de 5/8" (16 mm).
 Mit einer Materialdicke von mindestens 16 mm.
 Vereist een minimale materiaaldikte van 1.6 cm.
 Richiede uno spessore del materiale non inferiore a 16 mm.
 厚さが最低 5/8" (16 mm) の資材が必要。
 需要最低材料厚度为 5/8" (16 mm).

Wood	Studs ≥ 25 gauge steel
Madera	Pernos de acero de calibre ≥ 25
Bois	Goujons ≥ calibre 25 en acier
Solide Holzbalkenträger	Bolzen ≥ Blechlehre Nr. 25
Massief Houten Pilaren	Verbindingsbouten ≥ 25 gauge staal
Due montanti in legno massiccio	Prigionieri in acciaio spessore ≥ gauge 25 (0,556 mm)
木	Reglar ≥ 25-gauge stål
木质	25ゲージのスチールよりも強力なスタッド
나무	板墙筋为不小于 25 标号的钢材

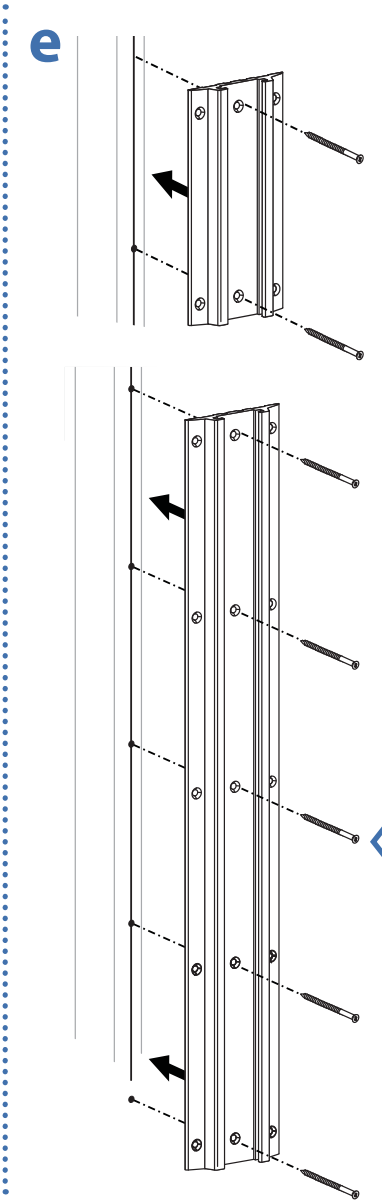
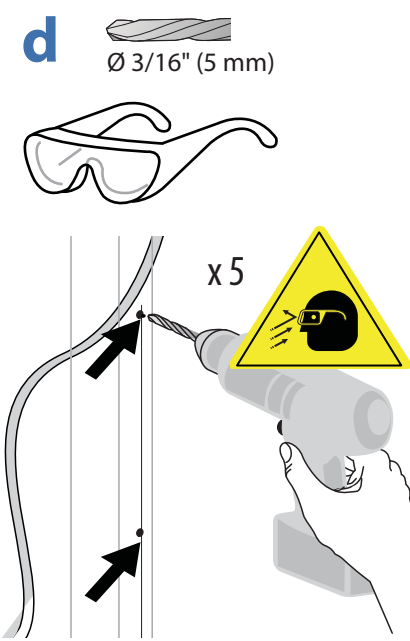
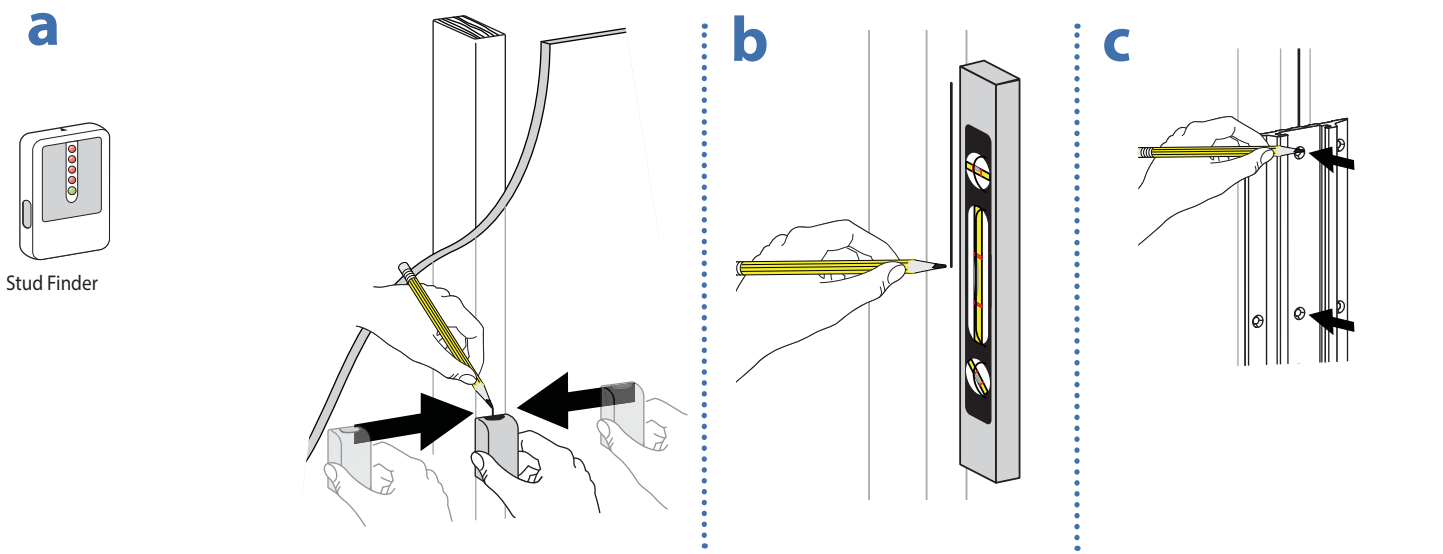

Wood Stud Mounting

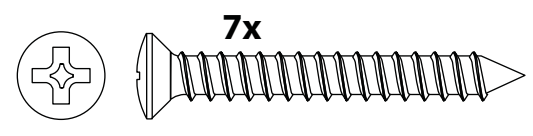

Studs ≥ 25 gauge steel
 Pernos de acero de calibre ≥ 25
 Goujons ≥ calibre 25 en acier
 Bolzen ≥ Blechlehre Nr. 25
 Verbindingsbouten ≥ 25 gauge staal
 Prigionieri in acciaio spessore ≥ gauge 25 (0,556 mm)
 Reglar ≥ 25-gauge stål
 25ゲージのスチールよりも強力なスタッド
 板墙筋为不小于 25 标号的钢材

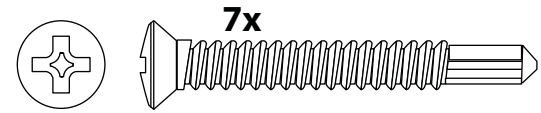

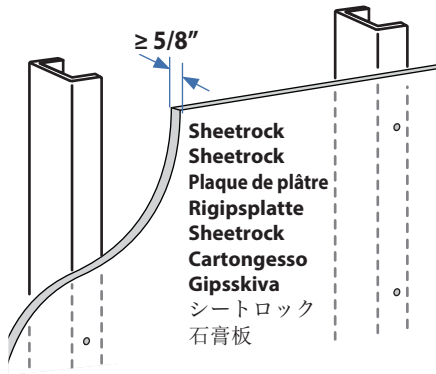

Sheetrock
 Sheetrock
 Plaque de plâtre
 Rigipsplatte
 Sheetrock
 Cartongesso
 Gipsskiva
 シートロック
 石膏板



Requires minimum material thickness of 5/8" (16 mm).
 Requiere un grosor mínimo de 16 mm.
 Epaisseur minimum de 16 mm.
 Requer uma espessura mínima de 5/8" (16 mm).
 Mit einer Materialdicke von mindestens 16 mm.
 Vereist een minimale materiaaldikte van 1.6 cm.
 Richiede uno spessore del materiale non inferiore a 16 mm.
 厚さが最低 5/8" (16 mm) の資材が必要。
 需要最低材料厚度为 5/8" (16 mm).

a

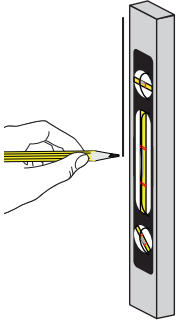

b

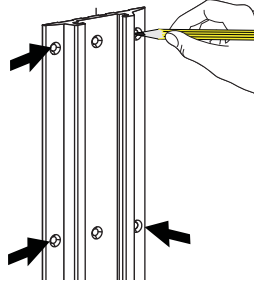

c

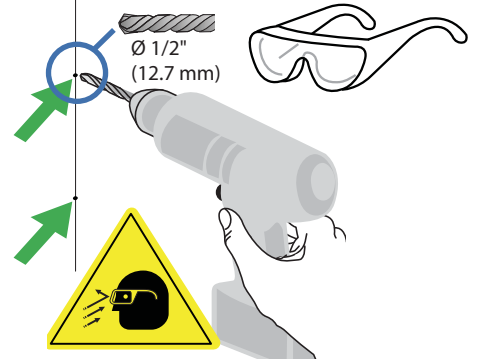

d 14x

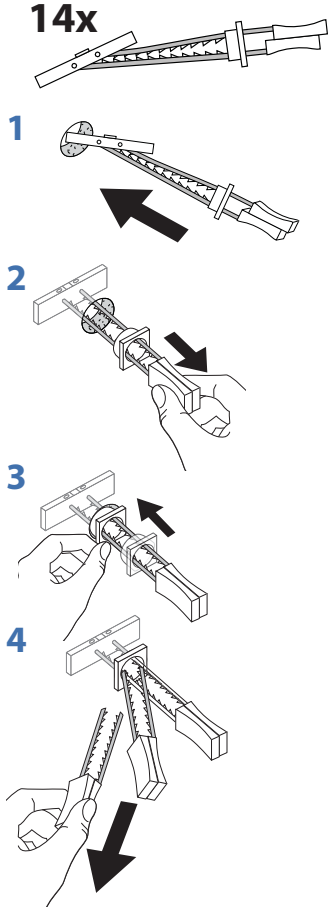

e

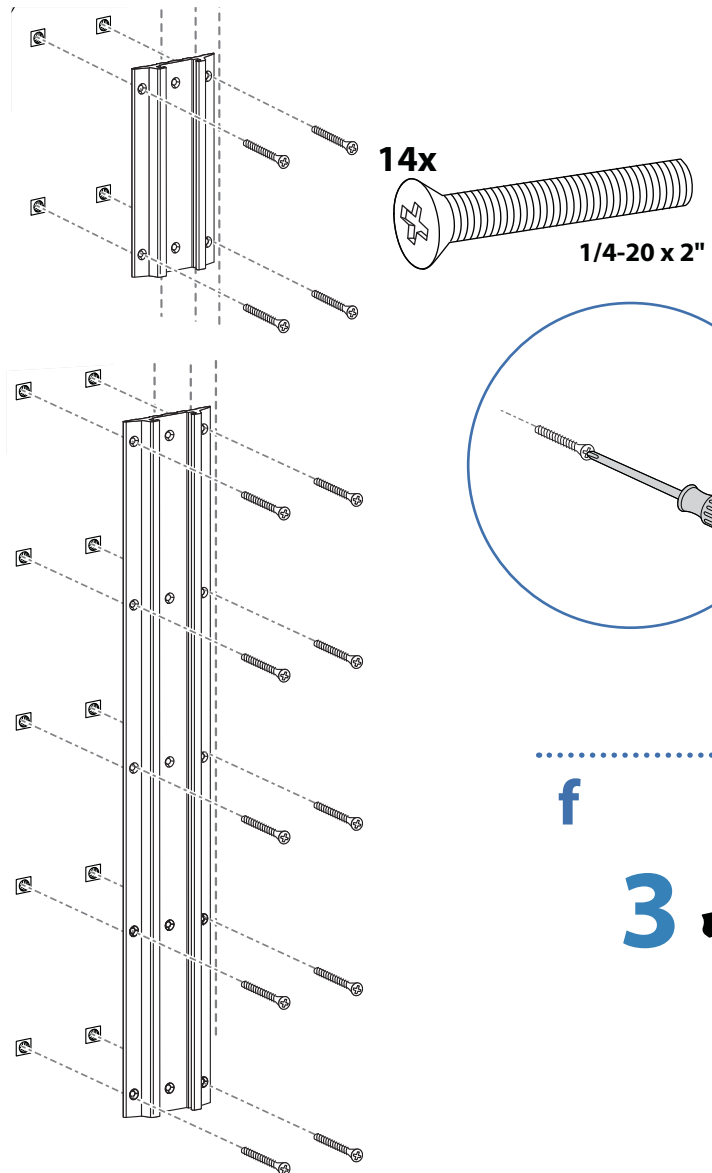

f



3

a

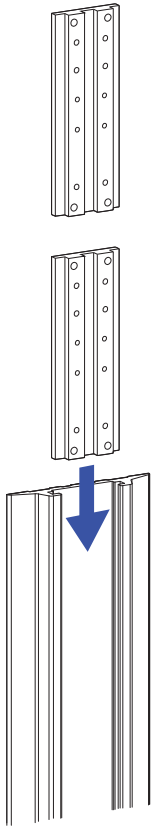

b

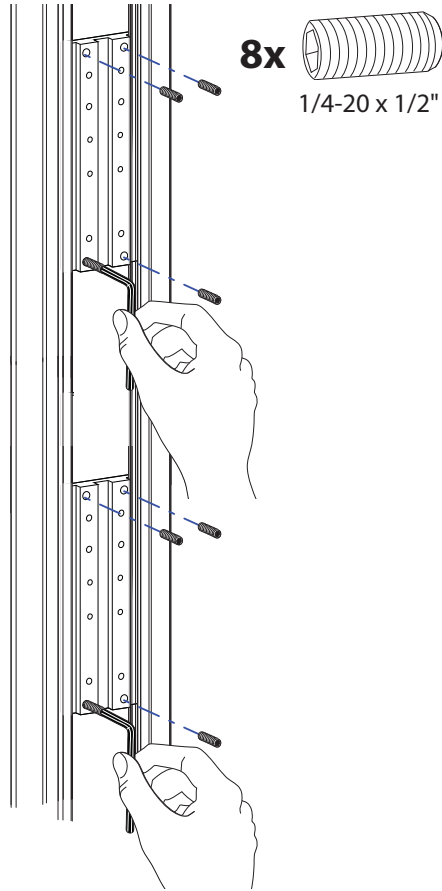

c

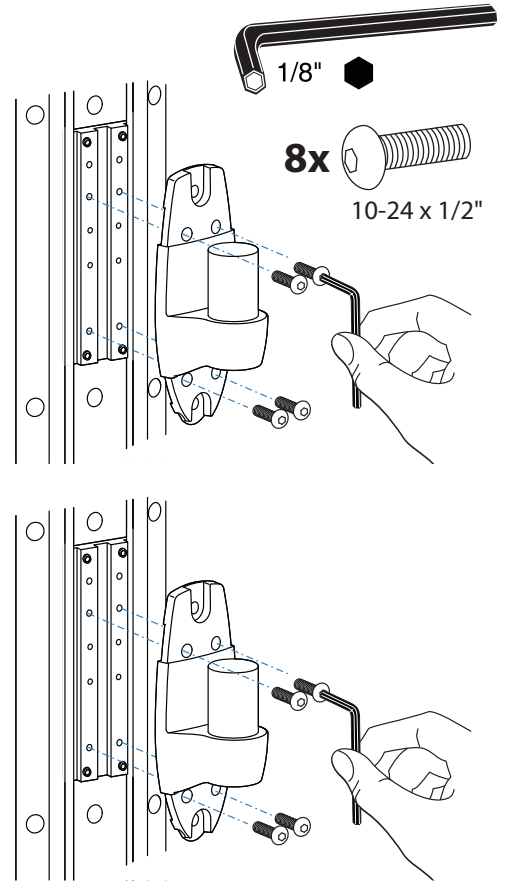
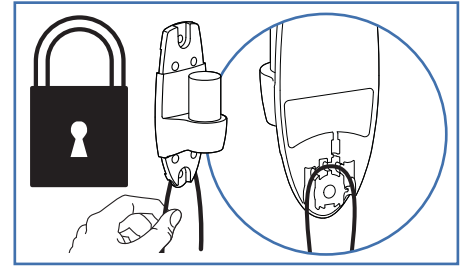

NOTE: Fasteners may unwind due to vibration caused by movement of mounting solution over time. Inspect mounting solution for loose fasteners on a routine basis. If desired, apply a light duty thread locking adhesive to fasteners before installation to prevent back-out.

d

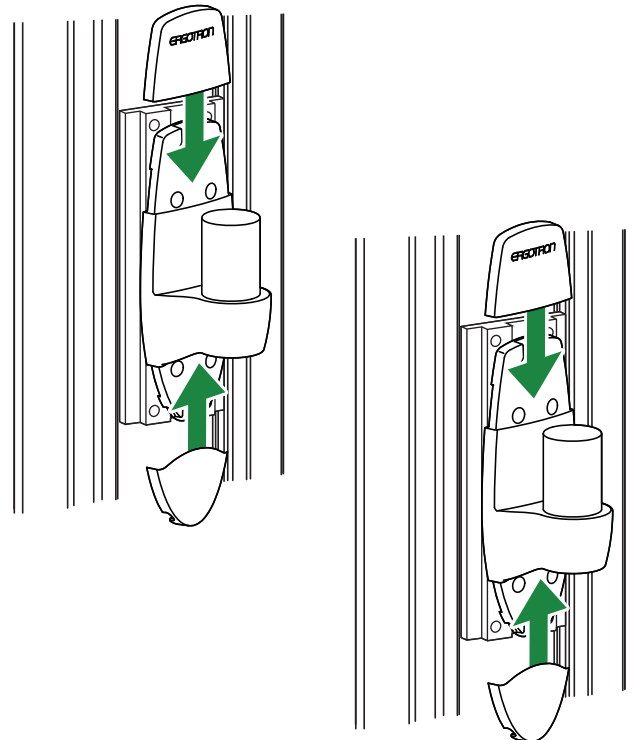

4

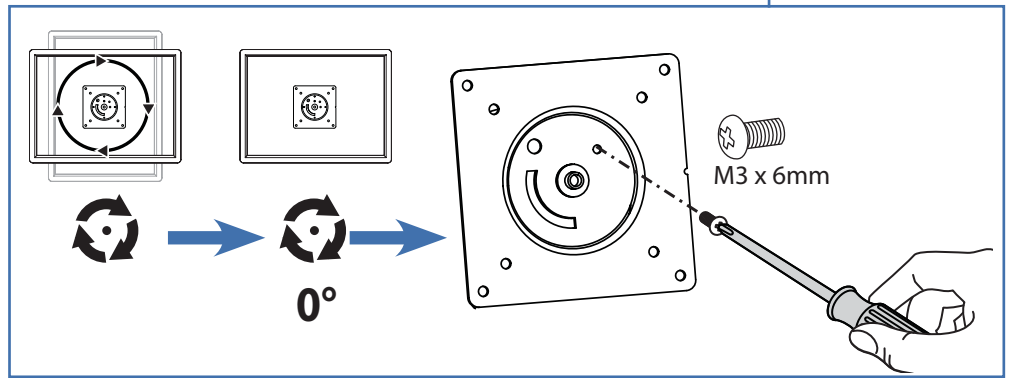
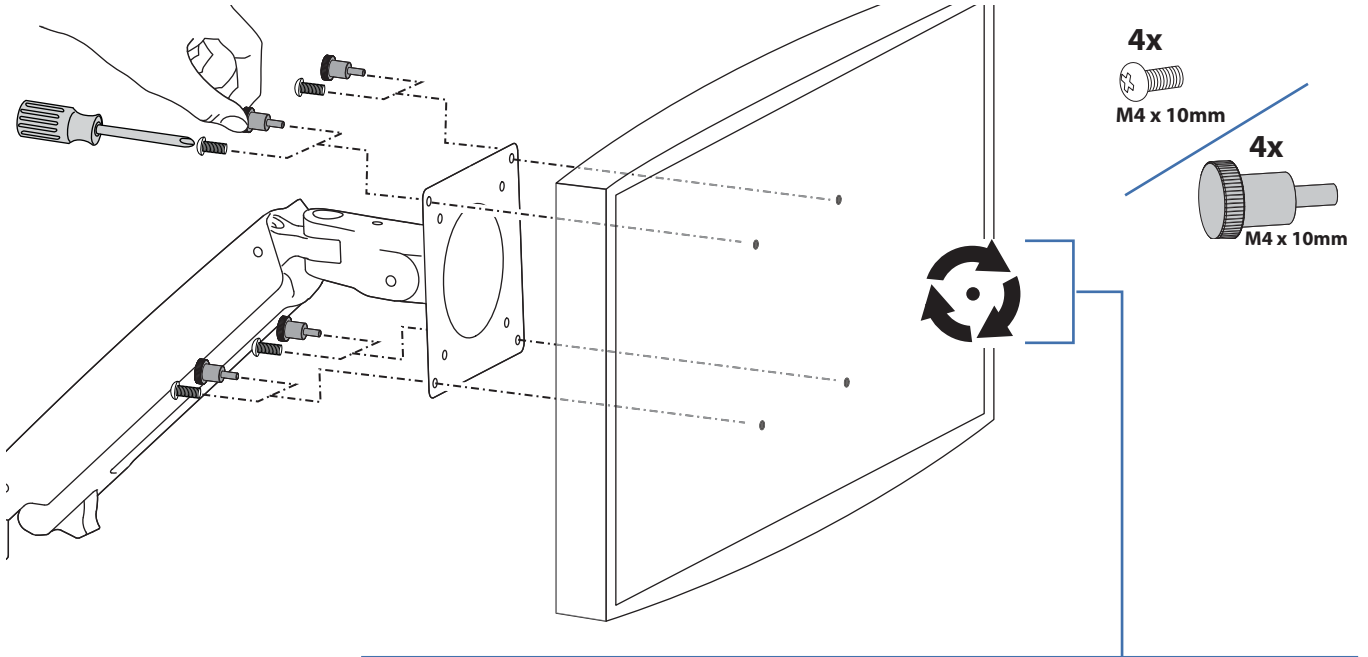

ENGLISH

5

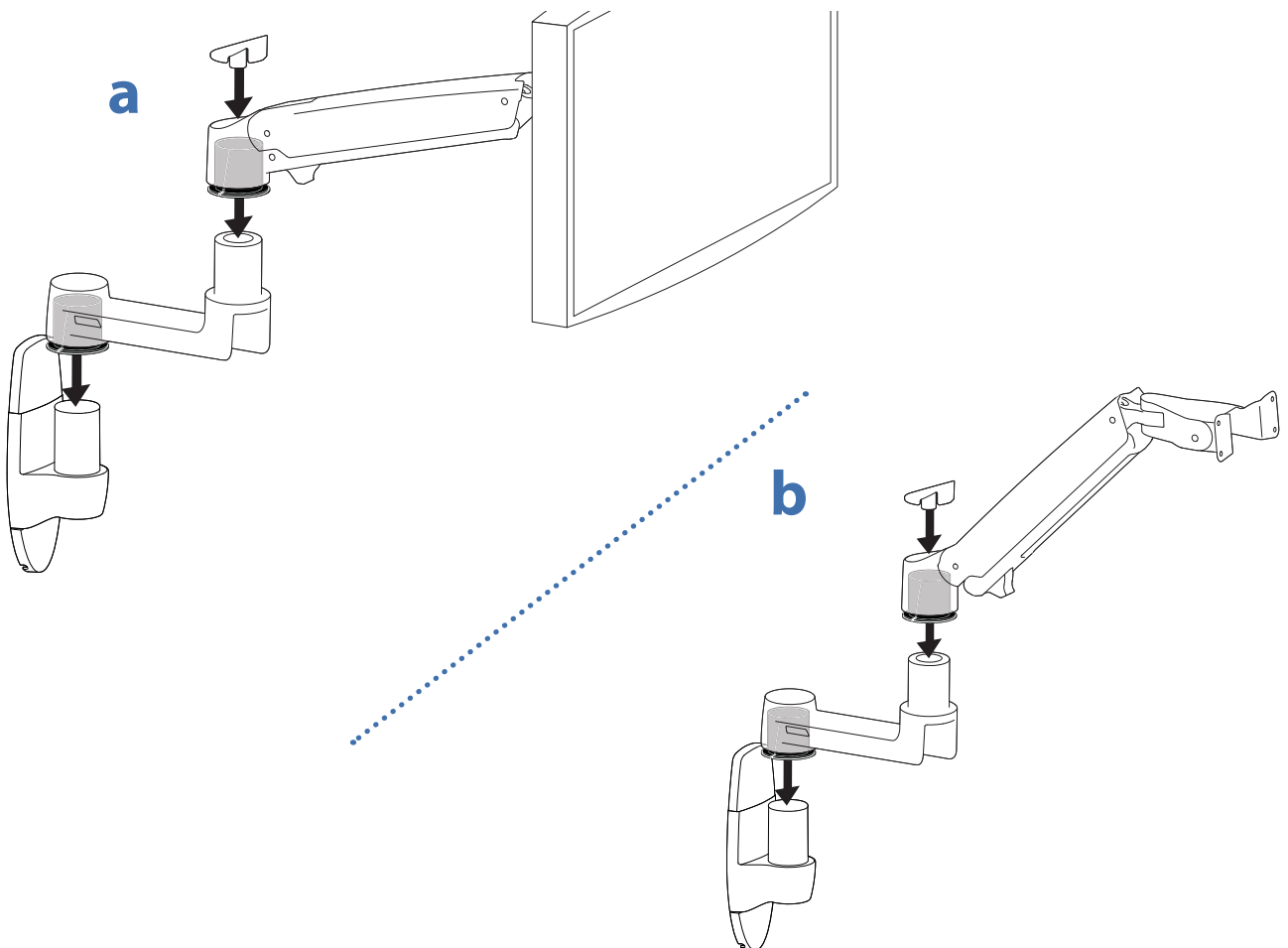

6

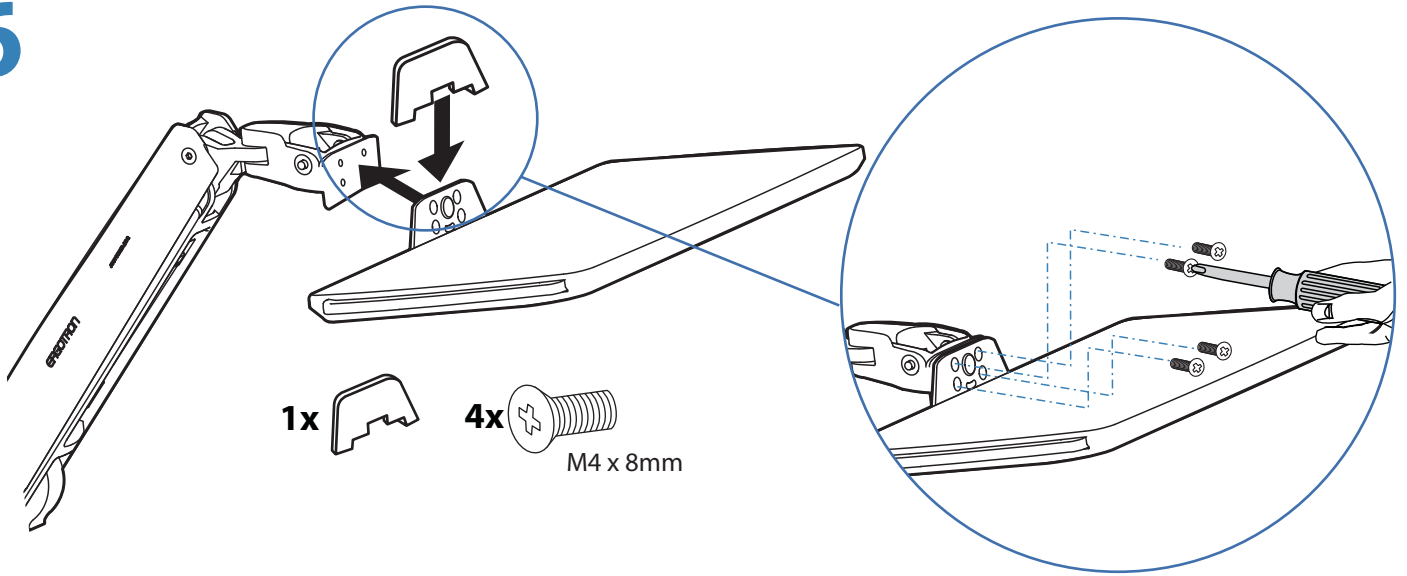

7

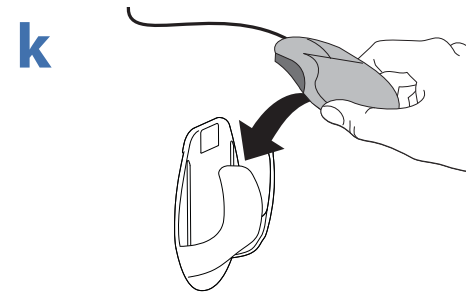
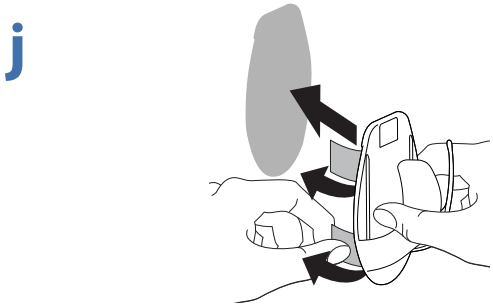
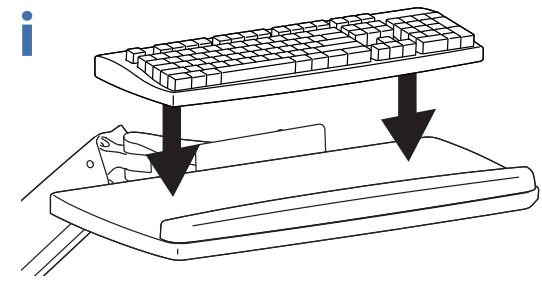
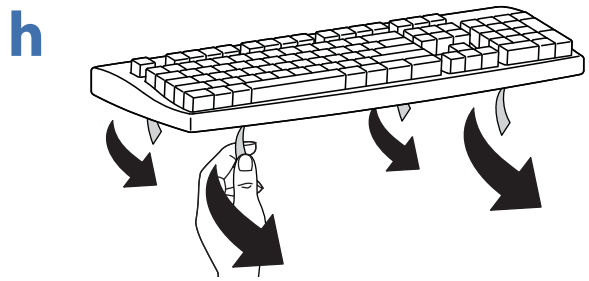
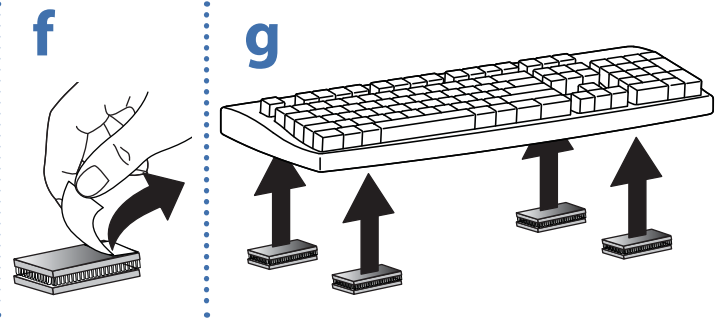
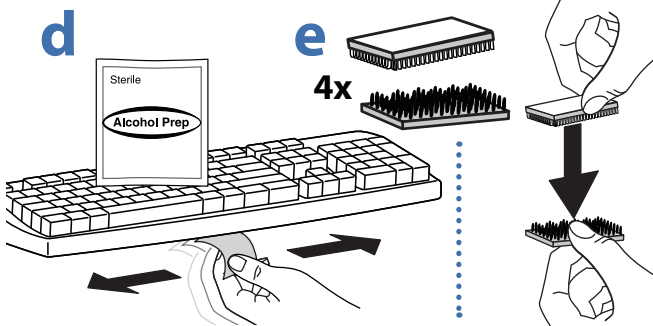
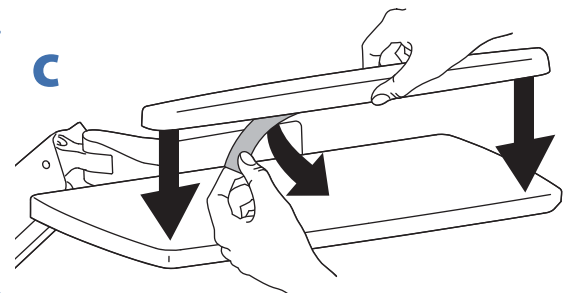
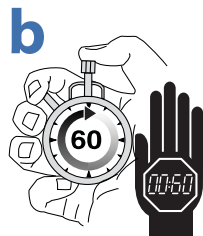
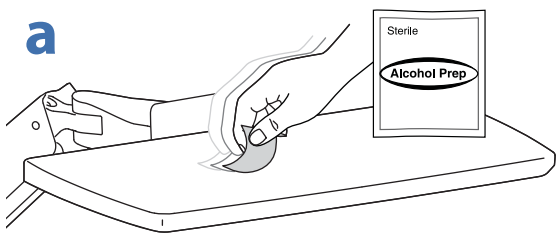
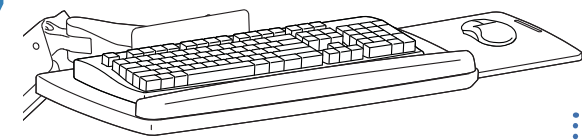

ENGLISH

8

4x

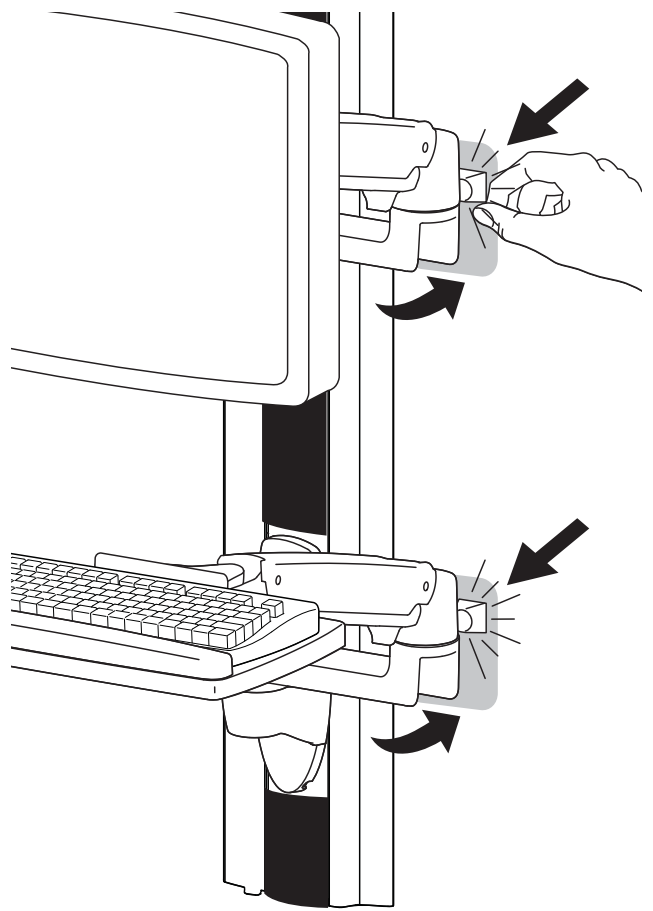
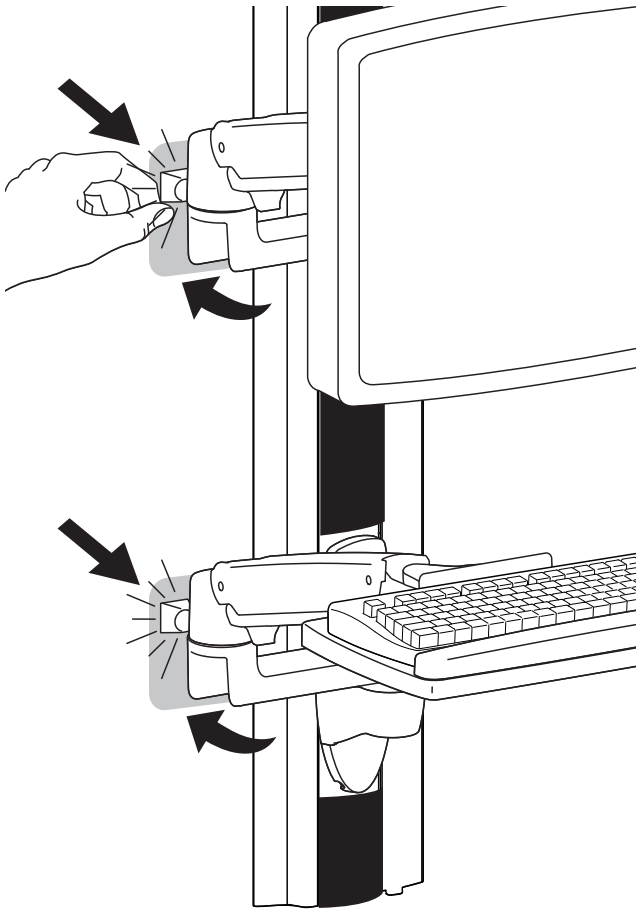

ENGLISH

9



NOTE: Leave enough slack in cable to allow full range of motion.



Caution: To avoid the potential to pinch cables it is important to follow the cable routing instructions in this manual. Failure to follow these instructions may result in equipment damage or personal injury.

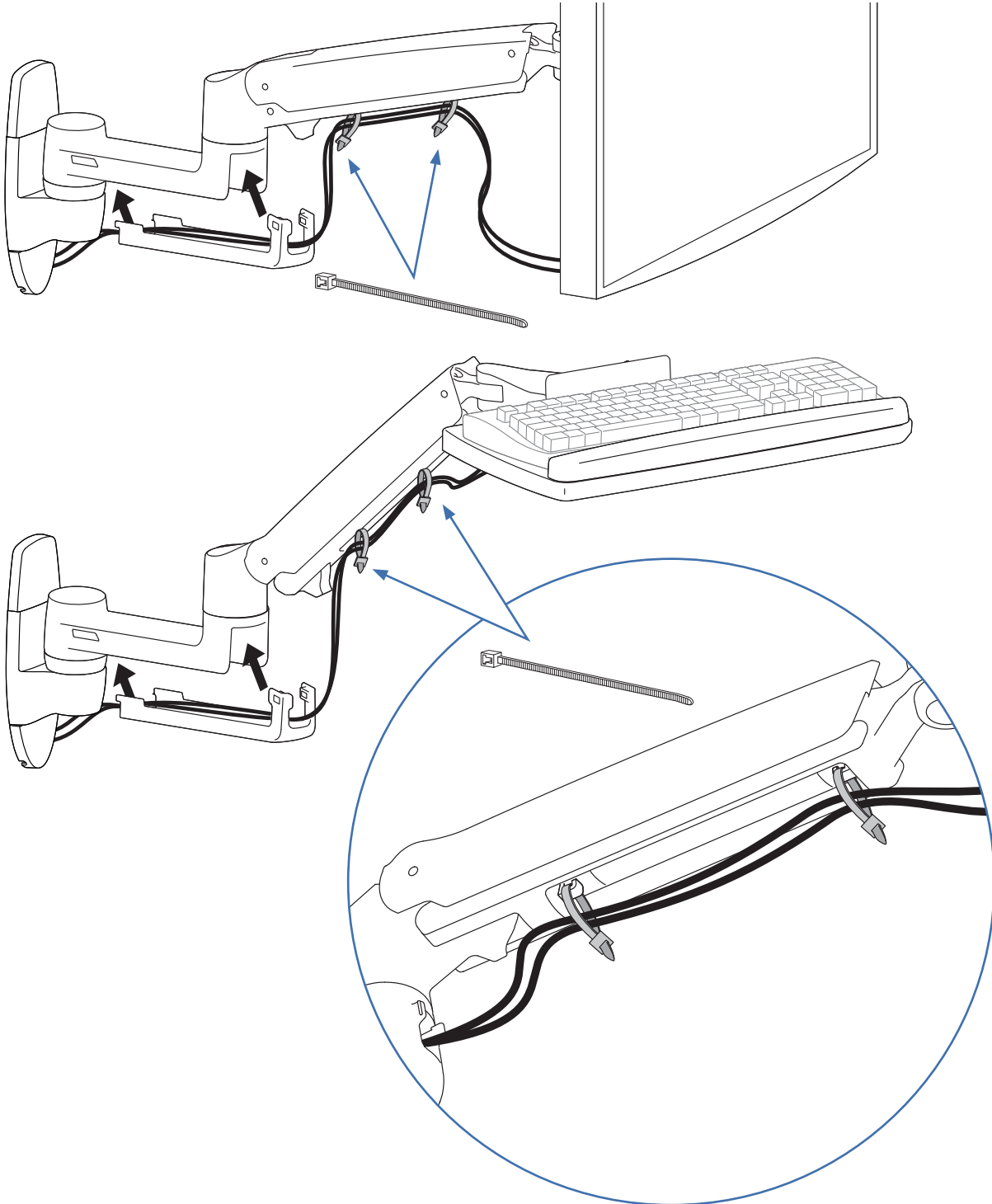

10 a

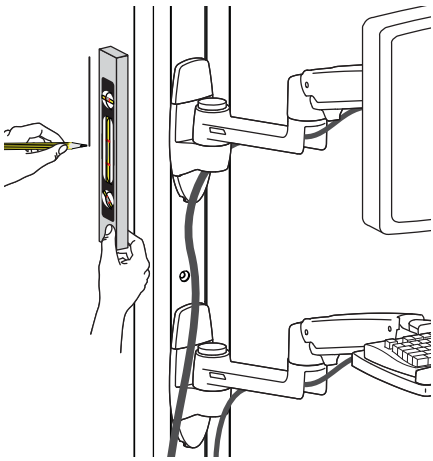

b

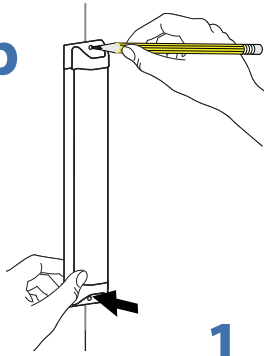

Ø 7/32" (5.6 mm)

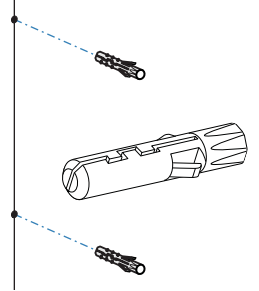
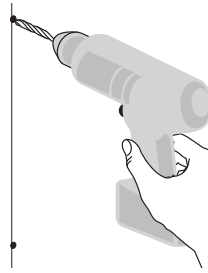

1

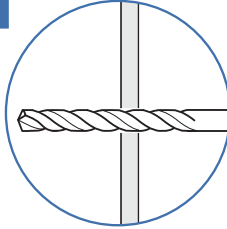

2

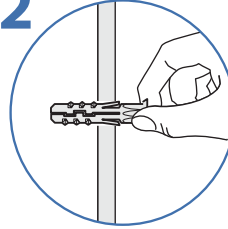

3

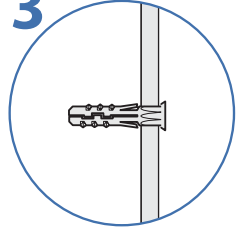

b

M4.2 x 25mm

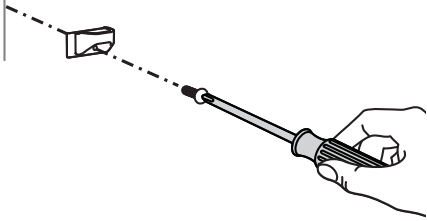

c



d



e

M4.2 x 25mm

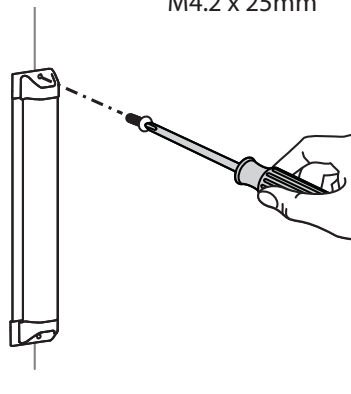

f

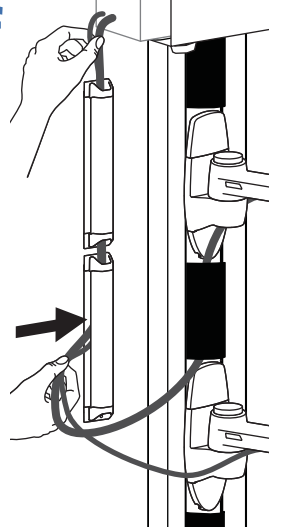

11 a

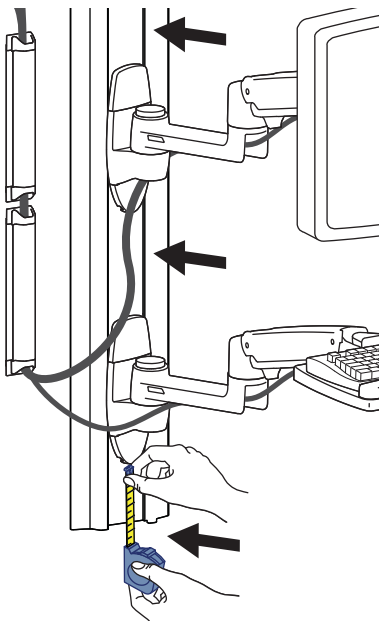

b

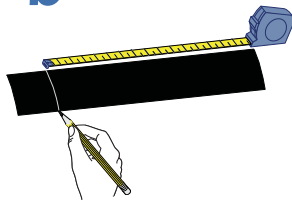

c

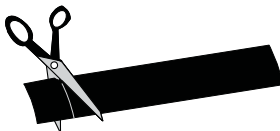

d

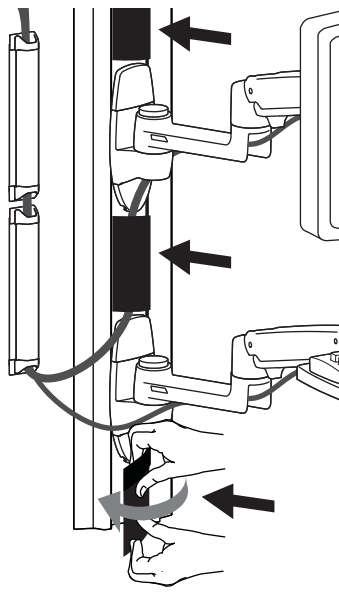

e

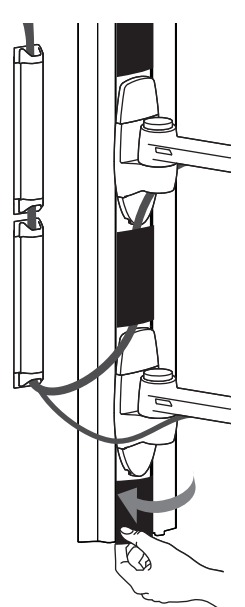

12 Adjustment Step

Important! You will need to adjust this product after installation is complete. Make sure all your equipment is properly installed on the product before attempting adjustments. This product should move smoothly and easily through the full range of motion and stay where you set it. If movements are too easy or difficult or if product does not stay in desired positions, follow the adjustment instructions to create smooth and easy movements. Depending on your product and the adjustment, it may take many turns to notice a difference. Any time equipment is added or removed from this product, resulting in a change in the weight of the mounted load, you should repeat these adjustment steps to ensure safe and optimum operation.

a Lift - Up and down

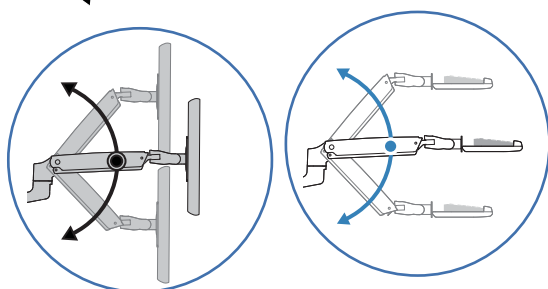

Increase Lift Strength

If the mounted weight is too heavy or this product does not stay up when raised, then you'll need to increase Lift Strength:



Decrease Lift Strength

If the mounted weight is too light or this product does not stay down when lowered, then you'll need to decrease Lift Strength:

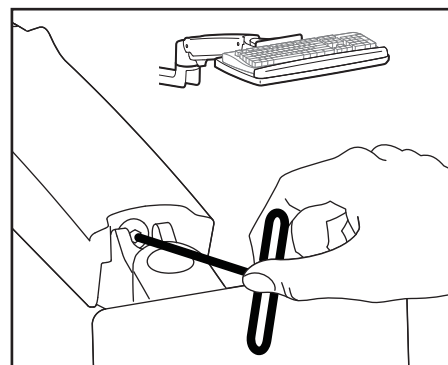
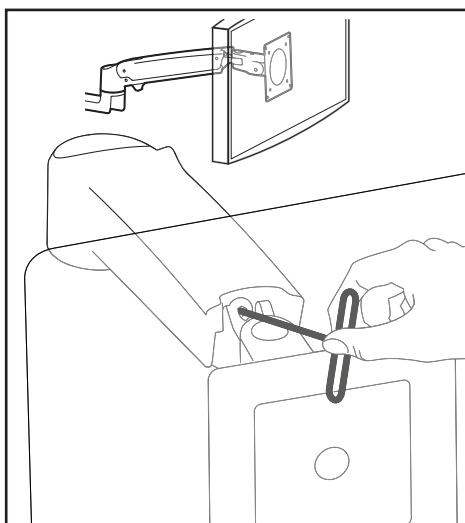
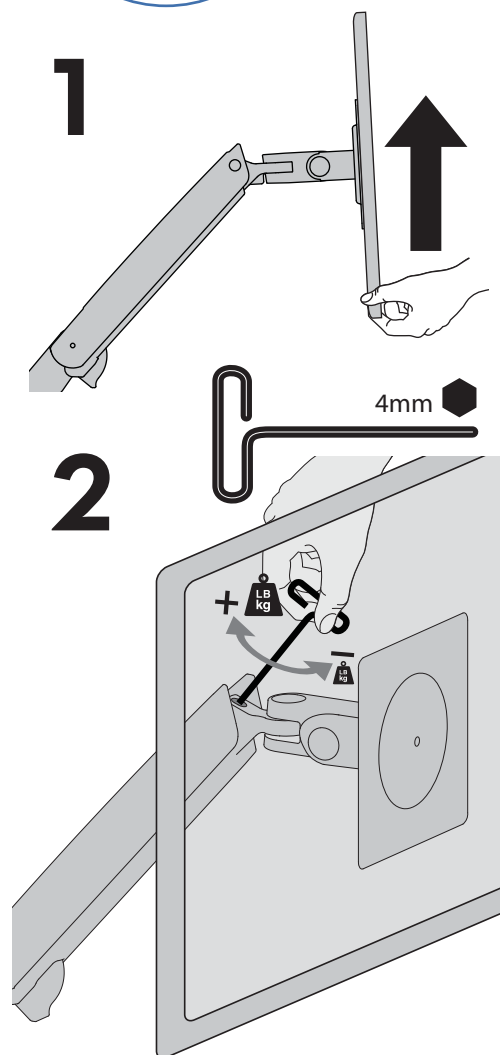

CAUTION: DO NOT overtighten fasteners. Overtightening may cause damage to your equipment.



WARNING! Stored Energy Hazard: The arm mechanism is under tension and will move up rapidly, on its own, as soon as attached equipment is removed. For this reason, **DO NOT** remove equipment unless the arm has been moved to the highest position! Failure to follow this instruction may result in serious personal injury and/or equipment damage!

b Tilt – Forward and Backward

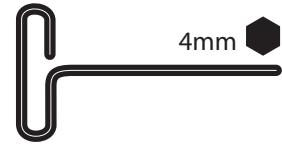
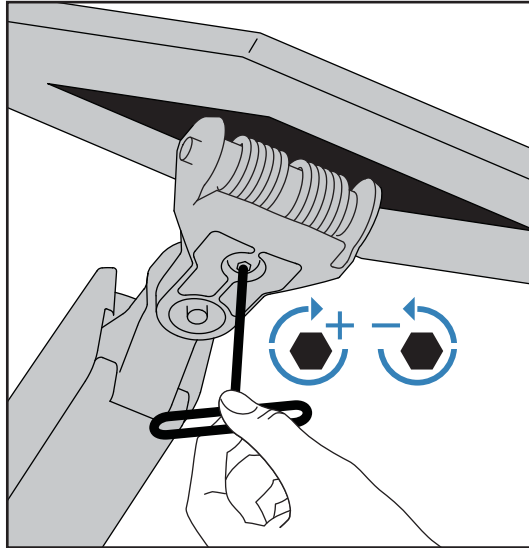
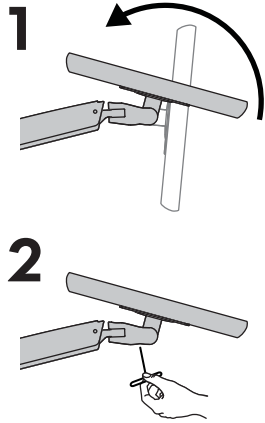
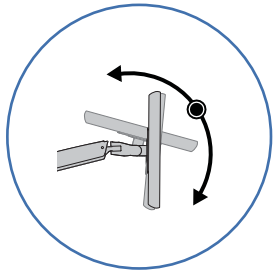

+ **LB kg** Increase Friction
If this product moves too easily, then you'll need to increase friction:

- **LB kg** Decrease Friction
If this product is too difficult to move, then you'll need to decrease friction:



CAUTION: DO NOT remove screw. Removing screw may cause damage to equipment.

c Arm Swing – Side-to-side

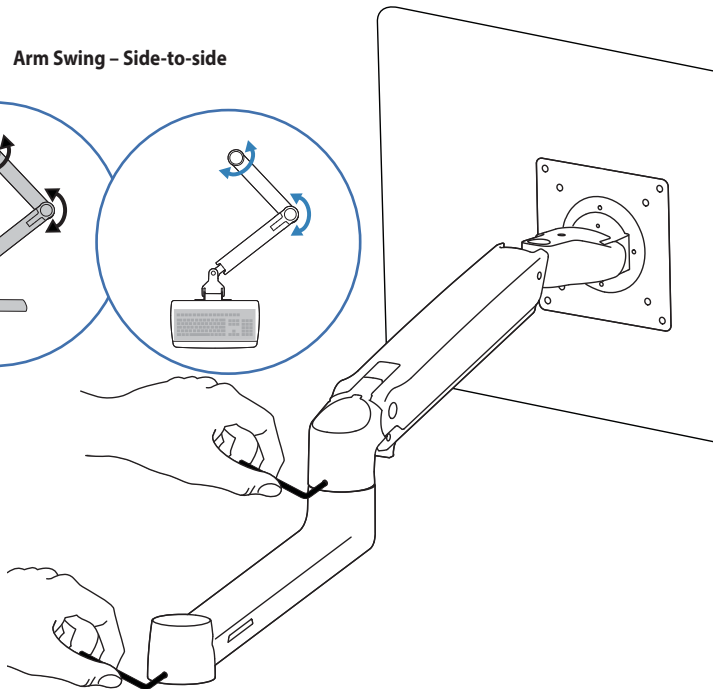
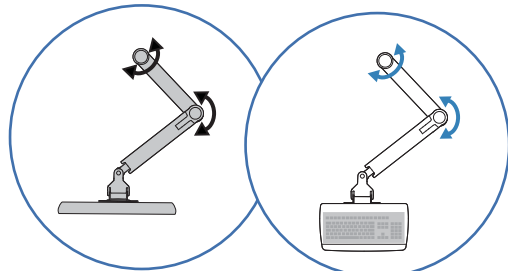

+ **LB kg** Increase Friction
If this product moves too easily, then you'll need to increase friction:

- **LB kg** Decrease Friction
If this product is too difficult to move, then you'll need to decrease friction:

d Rotate – Portrait/Landscape

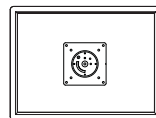
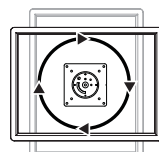

0°

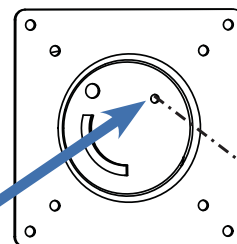

M3 x 6mm

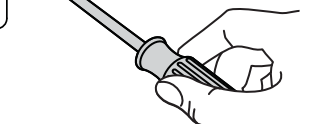

How to remove this tilting feature:

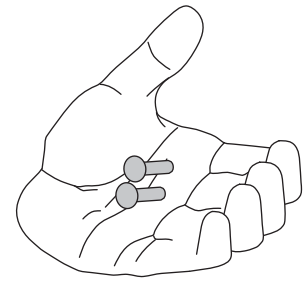
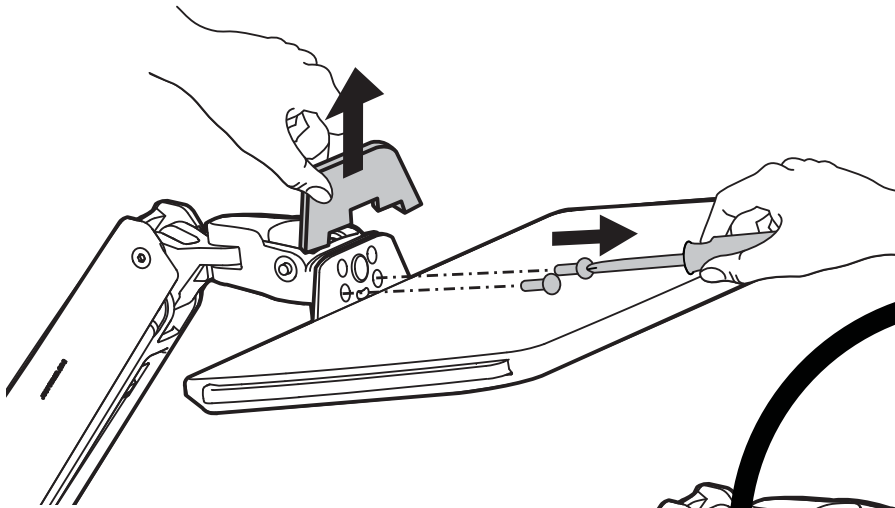
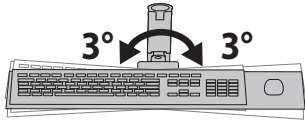

Save these screws incase you want to add this feature later.

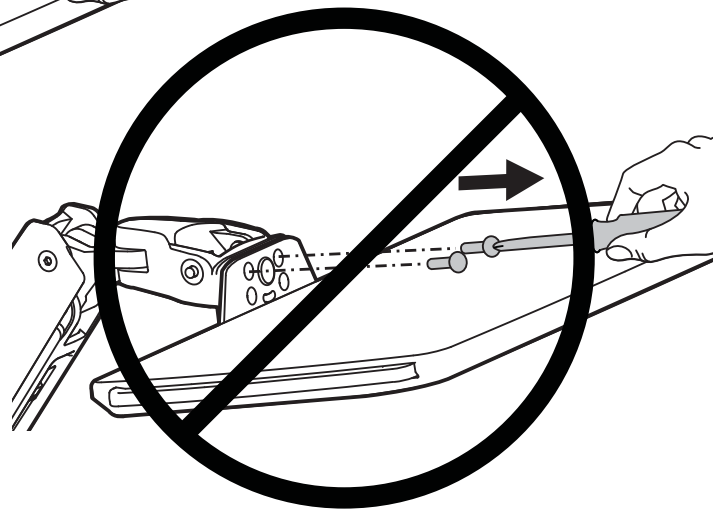

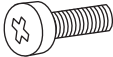
2x  M4 x 14mm

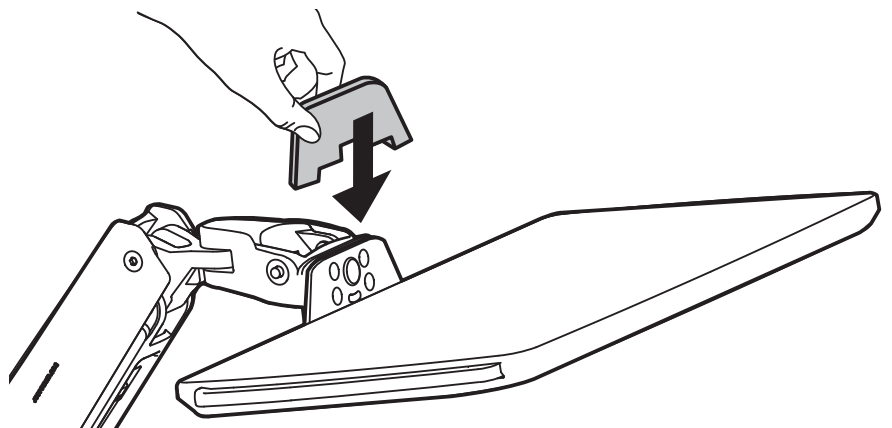
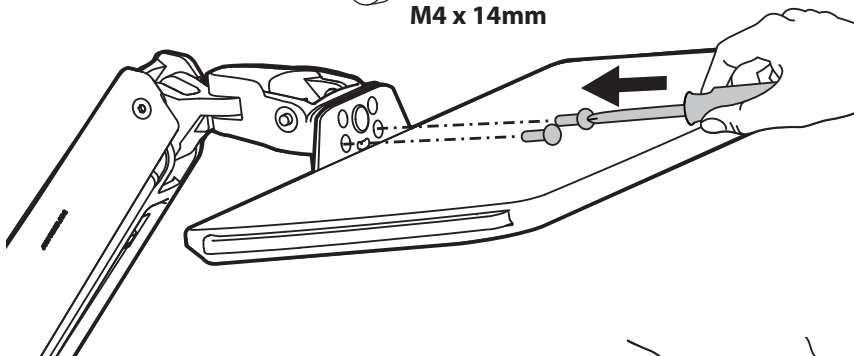

Set Your Workstation to Work For YOU!

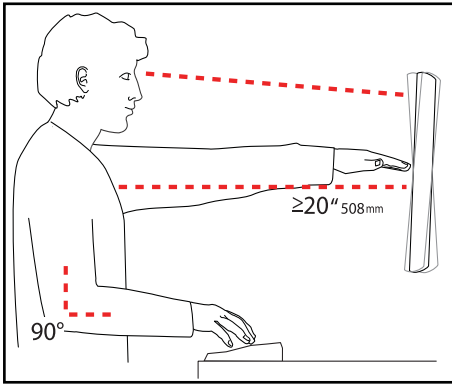

Learn more about ergonomic computer use at:
www.computingcomfort.org

- Height** Position top of screen slightly below eye level.
- Distance** Position keyboard at about elbow height with wrists flat. Position screen an arm's length from face—at least 20" (508mm).
- Angle** Position keyboard close enough to create a 90° angle in elbow. Tilt screen to eliminate glare. Tilt the keyboard back 10° so that your wrists remain flat.

To Reduce Fatigue
 Breathe - Breathe deeply through your nose.
 Blink - Blink often to avoid dry eyes.
 Break • 2 to 3 minutes every 20 minutes
 • 15 to 20 minutes every 2 hours.

How to attach optional CPU holder accessory (ordered separately)

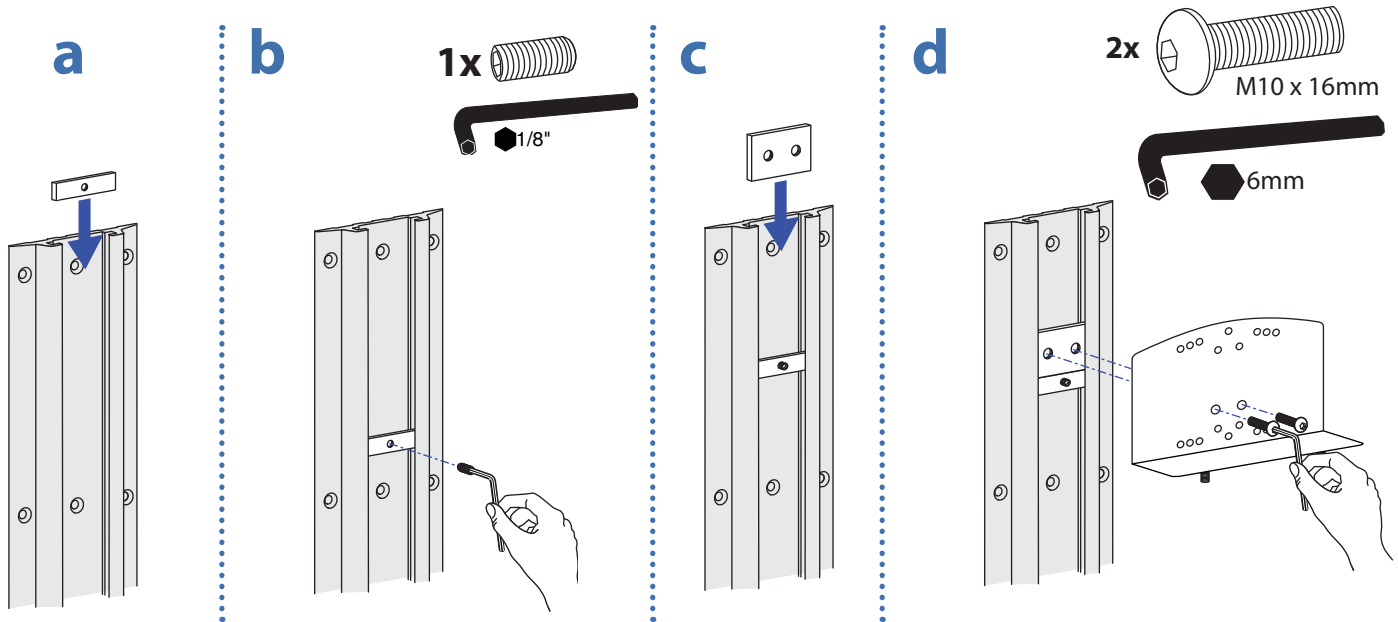

ENGLISH

For Warranty visit: www.ergotron.com/warranty

For Service visit: www.ergotron.com

For local customer care phone numbers visit: <http://contact.ergotron.com>

Americas Sales and Corporate Headquarters

1181 Trapp Rd.
 St. Paul, MN USA
 (800) 888-8458
 +1-651-681-7600
www.ergotron.com
sales@ergotron.com

EMEA Sales

Amersfoort, The Netherlands
 +31 33 45 45 600
www.ergotron.com
info.eu@ergotron.com

APAC Sales

Tokyo, Japan
www.ergotron.com
apaccustomerservice@ergotron.com

Worldwide OEM Sales

www.ergotron.com
info.oem@ergotron.com

ERGOTRON®

While Ergotron, Inc. makes every effort to provide accurate and complete information on the installation and use of its products, it will not be held liable for any editorial errors or omissions (including those made in the process of translation from English to another language), or for incidental, special or consequential damages of any nature resulting from furnishing this instruction and performance of equipment in connection with this instruction. Ergotron, Inc. reserves the right to make changes in the product design and/or product documentation without notification to its users. For the most current product information, or to know if this document is available in languages other than those herein, please contact Ergotron. No part of this publication may be reproduced, stored in a retrieval system, or transmitted in any form or by any means, electronic, mechanical, photocopying, recording or otherwise without the prior written consent of Ergotron, Inc., 1181 Trapp Road, Eagan, Minnesota, 55121, USA. Patents Pending and Patented U.S. & Foreign. Ergotron is a registered trademark of Ergotron, Inc.

© 2017 Ergotron, Inc. All rights reserved.