

Mobile WorkStand Cart

Mobile WorkStand

Configure a mobile mounting solution that works for you

No matter how demanding the mobile computing application, or what type of computing equipment you need to mobilize, Ergotron has a computer cart to get the job done. The Mobile WorkStand integrates technology and convenience, allowing the user to move a computer system from room to room. It quickly adjusts to a sitting or standing user height, providing an ergonomically-correct work environment at all times.



Universal CPU Holder, 80-102-064: Ergotron Mobile WorkStand Cart (interface bracket required, 60-131-003)

Configure Your Own Mobile WorkStand

Start with the basic components below. Then add peripherals and components from selections on the next page. Finally, choose arms/pivots to mount your monitor, keyboard and/or laptop: Ergotron's LX, 400 and 200 Series mounting solutions are all compatible with Mobile WorkStand.

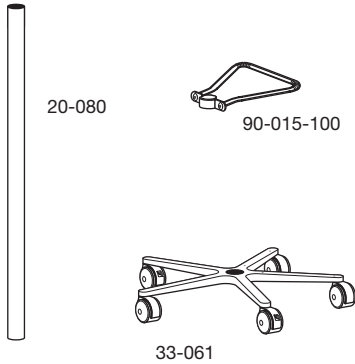

Part Number	Description	Dimensions H x W x D	Shipping Weight
20-080, chrome	2" Round Pole	50" x 2" x 2" (1270 x 51 x 51 mm)	7 lbs (3.2 kg)
20-128-006, chrome	2" Round Pole	63" x 2" x 2" (1270 x 51 x 51 mm)	8.5 lbs (3.9 kg)
33-061, black	Base & Casters	7" x 27" x 27" (178 x 686 x 686 mm)	13 lbs (5.9 kg)
90-015-100, chrome	Handle	1" x 9-1/4" x 11" (25 x 235 x 279 mm)	2 lbs (.9 kg)

Mobile WorkStand with LX Notebook Arm - pole mount brackets allow easy attachment of many Ergotron mounts, placed at any point along the pole



Mobile WorkStand with 400 Series LCD and Keyboard Arms offer vertical adjustment range of 22"-24" (56-61 cm) for sit-to-stand flexibility



Ergotron's Universal CPU Holder attaches to the base and accommodates a wide range of CPU/UPS sizes

Mobile WorkStand Cart



99-140

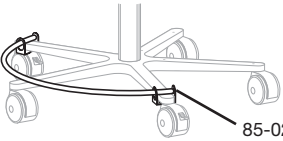

85-022



50-180-180

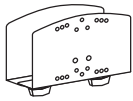

80-063-xxx

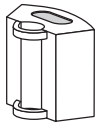

70-054-100



99-068-100

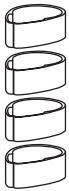

Cable Clips



Spiral Wrap

70-087, Cable Management Kit

Optional Peripherals & Components for Mobile WorkStand

Order these options to complete your cart to your exact specifications. CPU Holders and the Wire Storage Basket can be mounted to the backs of the monitor or keyboard brackets or a separately ordered Pole Mount Bracket is required.

Part Number	Description	Dimensions H x W x D	Shipping Weight
99-140*, black	Stabilizer Weight 25 lbs (11.4 kg)	1" x 11-1/4" x 11-1/4" (25 x 286 x 286 mm)	26 lbs (11.8 kg)
85-022, chrome	Footrest		2 lbs (.9 kg)
50-180-180, grey	Base Tray w/ Mounting Straps	1" x 14" x 12" (25 x 356 x 305 mm)	10 lbs (4.5 kg)
80-063-100**, grey 80-063-180**, black	CPU Holder, Small	6" x 10" x 1-3/8-3-3/4" (152 x 254 x 35-95 mm)	6 lbs (2.7 kg)
80-058-100**, grey 80-058-180**, black	CPU Holder, Medium	6-1/2" x 10" x 3-3/8-7-5/8" (165 x 254 x 86-194 mm)	10 lbs (4.5 kg)
70-054-100, grey	Cable Box (Pole Mount Brackets included)	9-1/8" x 7-7/8" x 4-3/8" (232 x 200 x 111 mm)	3 lbs (1.4 kg)
99-068-100**, grey	Wire Storage Basket	6-1/8" x 13-1/8" x 4-1/8" (156 x 333 x 105 mm)	3 lbs (1.4 kg)
60-144-003	Pole Mount Bracket for CPU Holders & Wire Storage Basket		1 lbs (.5 kg)
80-102-064, dark grey	Universal CPU Holder	50 lbs (22.7 kg) Weight capacity	2 lbs (.9 kg)

* Recommended for system stability.

** Requires separately ordered Pole Mount Bracket. May be mounted to Bracket shared by another component.

Cable Management Kit

The Cable Management Kit includes three feet of spiral wrap to conceal cables (standard color is black) and four cable clips to secure spiral wrap to pole (standard color is grey).

Part Number	Description	Attaches to...	Shipping Weight
70-087	Cable Management Kit	Cables and 2" Dia. Pole	1 lbs (.5 kg)

Brackets to Mount Arms & Peripherals to Mobile WorkStand

For both arms/pivots and peripherals*, select the appropriate bracket listed below. Attach anywhere along the Pole.

Part Number	Description	Application	Shipping Weight
60-131-003, aluminum	Pole Mount Brackets (2 Brackets)	Mounts LX, 400, 200 Series and 400 Combo	2 lbs (.9 kg)
60-144-003, aluminum	Pole Mount Bracket (1 Bracket)	Mounts CPU Holders and Wire Storage Basket	1 lbs (.5 kg)
60-199-003**, aluminum	Split Pole Bracket (1 Bracket)	Mounts LX, 400 & 200 Series, 400 Combo, CPU Holders and Storage Basket For use with Pole having no open end – facilitates mounting after Mounting Solutions are in place	2 lbs (.9 kg)
97-094-099, grey 97-094-085, black	Pole Bracket Kit (1 bracket, 1 plate)	Mounts 100 Series to 2" Pole	2 lbs (.9 kg)

* Refer to the peripheral's description to see whether Bracket is necessary.

** LX, 400, 200 Series, and 400 Combo require two Brackets for installation.

Note: Brackets provide attachment holes on two sides. This allows an additional Arm or peripheral to be mounted on the opposite side.

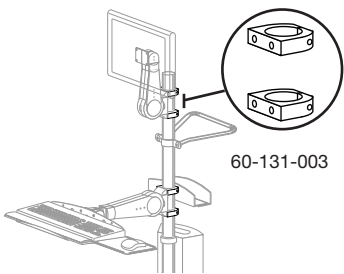

60-131-003



60-144-003



60-199-003

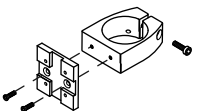

97-094-XXX