

24/7 Emergency Assistance Hotline
1-877-OSCAR99 (672-2799)



Flexible MINI-SYNC™ and MICRO-SYNC™ Connectors, Cable Assemblies and Receptacles



FEATURES:

- NEMA 6P and IP68 protection
- Made in the USA
- Compatible with U.S. and European sensors
- High-impact resistant contact carriers
- Highly accurate machined contacts
- Corrosion resistant gold plated contacts
- Secure pin and contact crimp termination
- Mechanically keyed
- Field installable
- Stress and harsh environment resistant
- Vibration resistant



Ericson’s family of MINI-SYNC™ and MICRO-SYNC™ connectors, cable assemblies and receptacles offer the flexibility, vibration resistance and product configuration options necessary for today’s challenging manufacturing environments. These connectors have been designed for low amperage AC or DC control systems, and are compatible with the pin configurations used by major U.S. and European sensor manufacturers.

MINI-SYNC™ and MICRO-SYNC™ plugs and cable assemblies are excellent for use where flexibility and resistance to stress, abuse, and harsh physical environments is essential. A wide range of configuration alternatives are available including male and female connections, 2 thru 12 pole pin-outs, straight or 90° configurations, and single or dual keyway.

Flexible connector configurations make these products ideal for applications where proximity switches, limit switches, photoelectric switches and solenoids are used including:

- | | | |
|-----------------------|---------------------|------------------------|
| • Automotive Assembly | • Conveyor Sensors | • Packaging Machinery |
| • Automated Machinery | • Material Handling | • Automated Assembly |
| • Packaging Equipment | • Robotics | • Automated Inspection |



MANY ERICSON PRODUCTS ARE LISTED OR CERTIFIED.
 FOR THE LATEST FULL SEARCHABLE LISTING BY PART NUMBER, GO TO: WWW.ERICSON.COM/AGENCY
 Note: Products shown on this page may not be listed.

SPECIFICATIONS

Materials

Body: PVC

Contact Carrier: Nitrile Rubber

Contact Sleeve: Stainless Steel

Contact: Brass, Gold Plated over Nickel

Coupling Nut: Machined Aluminum, Black Anodized

Cable: #16 AWG Type PVC, 65 x #34 stranding 105° C

Other cables available

Cable Diameters: 2/C-.37", 3/C-.39", 4/C-.42", 5/C-.50", 6/C-.53"

Electrical

Voltage Rating: 600 VAC

Contact Resistance: ≤;5m Ω

Environmental

Protection: IP68, NEMA 6P

Operating Temp: -20°C to 105°C

Certifications



OPTIONS

#18 AWG (PVC) Plug Assemblies

Stainless Steel Couplers

Plastic Couplers

Consult the factory for custom wire length and a full range of wire management product accessories.



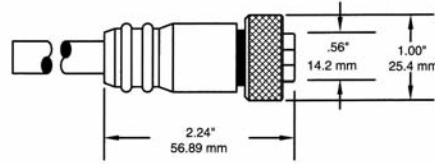



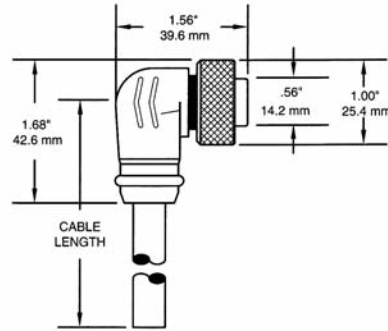



Straight Connector



90° Plug Connector



MINI-SYNC™ - 2- 6 Pole - Male & Female - Straight & 90°

Poles	Face View	Rating	Wiring Code	Overall Length (ft./m)	MINI-SYNC™ Straight Male	MINI-SYNC™ Male 90°	MINI-SYNC™ Female Straight	MINI-SYNC™ Female 90°
2	Male  Female 	13A 600V	1-White 2-Black	3 ft./0.91m	82MS003A	82M9003A	82FS003A	82F9003A
				6 ft./1.83m	82MS006A	82M9006A	82FS006A	82F9006A
				12 ft./3.66m	82MS012A	82M9012A	82FS012A	82F9012A
				15 ft./4.57m	82MS015A	82M9015A	82FS015A	82F9015A
				20 ft./6.10m	82MS020A	82M9020A	82FS020A	82F9020A
3	Male  Female 	13A 600V	1-Green 2-Black 3-White	3 ft./0.91m	83MS003A	83M9003A	83FS003A	83F9003A
				6 ft./1.83m	83MS006A	83M9006A	83FS006A	83F9006A
				12 ft./3.66m	83MS012A	83M9012A	83FS012A	83F9012A
				15 ft./4.57m	83MS015A	83M9015A	83FS015A	83F9015A
				20 ft./6.10m	83MS020A	83M9020A	83FS020A	83F9020A
4	Male  Female 	10A 600V	1-Black 2-White 3-Red 4-Green	3 ft./0.91m	84MS003A	84M9003A	84FS003A	84F9003A
				6 ft./1.83m	84MS006A	84M9006A	84FS006A	84F9006A
				12 ft./3.66m	84MS012A	84M9012A	84FS012A	84F9012A
				15 ft./4.57m	84MS015A	84M9015A	84FS015A	84F9015A
				20 ft./6.10m	84MS020A	84M9020A	84FS020A	84F9020A
5	Male  Female 	8A 600V	1-White 2-Red 3-Green 4-Orange 5-Black	3 ft./0.91m	85MS003A	85M9003A	85FS003A	85F9003A
				6 ft./1.83m	85MS006A	85M9006A	85FS006A	85F9006A
				12 ft./3.66m	85MS012A	85M9012A	85FS012A	85F9012A
				15 ft./4.57m	85MS015A	85M9015A	85FS015A	85F9015A
				20 ft./6.10m	85MS020A	85M9020A	85FS020A	85F9020A
6	Male  Female 	8A 600V	1-White 2-Red 3-Green 5-Black 4-Orange 6-Blue	3 ft./0.91m	86MS003A	86M9003A	86FS003A	86F9003A
				6 ft./1.83m	86MS006A	86M9006A	86FS006A	86F9006A
				12 ft./3.66m	86MS012A	86M9012A	86FS012A	86F9012A
				15 ft./4.57m	86MS015A	86M9015A	86FS015A	86F9015A
				20 ft./6.10m	86MS020A	86M9020A	86FS020A	86F9020A



MANY ERICSON PRODUCTS ARE LISTED OR CERTIFIED.
 FOR THE LATEST FULL SEARCHABLE LISTING BY PART NUMBER, GO TO: WWW.ERICSON.COM/AGENCY
 Note: Products shown on this page may not be listed.

SPECIFICATIONS

Materials

Body: PVC

Contact Carrier: Nitrile Rubber

Contact Sleeve: Stainless Steel

Contact: Brass, Gold Plated over Nickel

Coupling Nut: Machined Aluminum, Black Anodized

Cable: #16 AWG Type PVC, 65 x #34 stranding 105° C

Other cables available

Cable Diameters: 2/C-.37", 3/C-.39", 4/C-.42", 5/C-.50", 6/C-.53"

Electrical

Voltage Rating: 600 VAC

Contact Resistance: ≤5m Ω

Environmental

Protection: IP68, NEMA 6P

Operating Temp: -20°C to 105°C

Certifications



OPTIONS

#18 AWG (PVC) Plug Assemblies

Stainless Steel Couplers

Plastic Couplers

Consult the factory for custom wire length and a full range of wire management product accessories.

**6-8 POLE
Straight Connector**

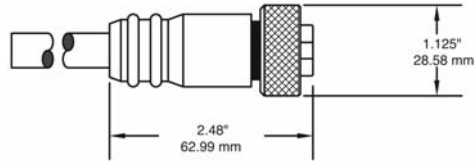

90° Connector

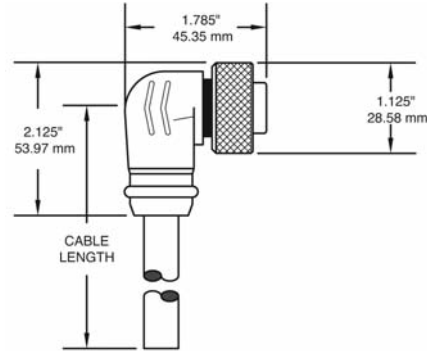

**9-12 POLE
Straight Connector**

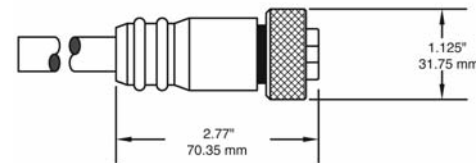

90° Connector

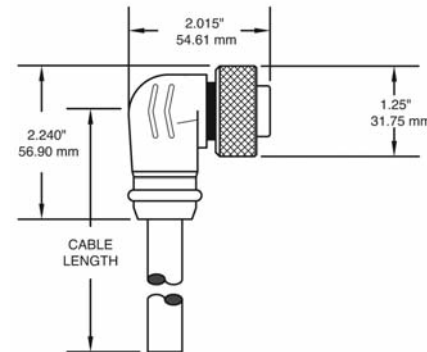

MINI-SYNC™ - 6B- 12 Pole - Male & Female - Straight & 90°

Poles	Male Face View	Rating	Wiring Code	Overall Length (ft./m)	MINI-SYNC™ Straight Male	MINI-SYNC™ Male 90°	MINI-SYNC™ Female Straight	MINI-SYNC™ Female 90°
6 B Size		8A 600V	1-White 2-Red 3-Green 5-Black 4-Orange 6-Blue	3 ft./0.91m	86BMS003A	86BM9003A	86BFS003A	86BF9003A
				6 ft./1.83m	86BMS006A	86BM9006A	86BFS006A	86BF9006A
				12 ft./3.66m	86BMS012A	86BM9012A	86BFS012A	86BF9012A
				15 ft./4.57m	86BMS015A	86M9015A	86BFS015A	86BF9015A
				20 ft./6.10m	86BMS020A	86BM9020A	86BFS020A	86BF9020A
7		7A 600V	1-White 2-Red 3-Green 5-Black 4-Orange 6-Blue 7-Green	3 ft./0.91m	87MS003A	87M9003A	87FS003A	87F9003A
				6 ft./1.83m	87MS006A	87M9006A	87FS006A	87F9006A
				12 ft./3.66m	87MS012A	87M9012A	87FS012A	87F9012A
				15 ft./4.57m	87MS015A	87M9015A	87FS015A	87F9012A
				20 ft./6.10m	87MS020A	87M9020A	87FS020A	87F9020A
8		7A 600V	1-White 2-Red 3-Green 5-Black 4-Orange 6-Blue 7-Green 8-White-Blk.Tr.	3 ft./0.91m	88MS003A	88M9003A	88FS003A	88F9003A
				6 ft./1.83m	88M9006A	88M9006A	88FS006A	88F9006A
				12 ft./3.66m	88MS012A	88M9012A	88FS012A	88F9012A
				15 ft./4.57m	88MS015A	88M9015A	88FS015A	88F9015A
				20 ft./6.10m	88MS020A	88M9020A	88FS020A	88F9020A
9		7A 600V	1-Orange 2-Blue 3-Red-Blk.Tr. 4-Green-Blk.Tr. 5-White 6-Red 7-Green 8-White-Blk.Tr. 9-Black	3 ft./0.91m	89MS003A	89M9003A	89FS003A	89F9003A
				6 ft./1.83m	89MS006A	89M9006A	89FS006A	89F9006A
				12 ft./3.66m	89MS012A	89M9012A	89FS012A	89F9012A
				15 ft./4.57m	89MS015A	89M9015A	89FS015A	89F9015A
				20 ft./6.10m	89MS020A	89M9020A	89FS020A	89F9020A
10		7A 600V	1-Orange 2-Blue 3-White-Blk.Tr. 4-Red-Blk.Tr. 5-Green-Blk.Tr. 6-Orange-Blk.Tr. 7-Red 8-Green 9-Black 10-White	3 ft./0.91m	810MS003A	810M9003A	810FS003A	810F9003A
				6 ft./1.83m	810MS006A	810M9006A	810FS006A	810F9006A
				12 ft./3.66m	810MS012A	810M9012A	810FS012A	810F9012A
				15 ft./4.57m	810MS015A	810M9015A	810FS015A	810F9015A
				20 ft./6.10m	810MS020A	810M9020A	810FS020A	810F9020A
12		7A 600V	1-Orange 2-Blue 3-White-Blk.Tr. 4-Red-Blk.Tr. 5-Green-Blk.Tr. 6-Orange-Blk.Tr. 7-Blue-Blk.Tr. 8-Black-Wht.Tr. 9-Green 10-Red 11-White 12-Black	3 ft./0.91m	812MS003A	812M9003A	812FS003A	812F9003A
				6 ft./1.83m	812MS006A	812M9006A	812FS006A	812F9006A
				12 ft./3.66m	812MS012A	812M9012A	812FS012A	812F9012A
				15 ft./4.57m	812MS015A	812M9015A	812FS015A	812F9015A
				20 ft./6.10m	812MS020A	812M9020A	812FS020A	812F9020A



MANY ERICSON PRODUCTS ARE LISTED OR CERTIFIED.
 FOR THE LATEST FULL SEARCHABLE LISTING BY PART NUMBER, GO TO: WWW.ERICSON.COM/AGENCY
 Note: Products shown on this page may not be listed.

SPECIFICATIONS

MATERIALS

- Insert Material:** Nitrile Rubber
- Contact:** Brass, Gold Plated over Nickel
- Sleeve:** Stainless Steel
- Shell:** Machined Aluminum, Black Anodized (stainless steel available)
- Wire:** #16 AWG/600 Volts 26 x #30 Stranding
- "O" Ring:** Viton
- Lock nut: Plated Steel (not pictured)

ELECTRICAL

- Voltage Rating:** 600 VAC
- Contact Resistance:** $\leq 5m \Omega$

ENVIRONMENTAL

- Protection:** IP68, NEMA 6P
- Operating Temp:** -50°C to 90°C (UL), -34°C to 90°C (CSA)

CERTIFICATIONS



OPTIONS

Stainless Steel Hardware can be specified - add "SS" after Part Number; to specify 18 AWG Wire add "-18" after the Part Number.



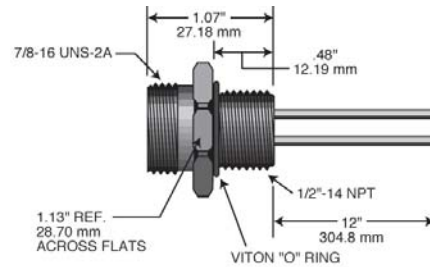

Not available in stainless steel.

DIMENSIONS

Receptacle



MINI-SYNC™ - 2-6 Pole Receptacles

Poles	Face View	Rating	Wiring Code	Overall Length (ft./m)	Male Straight Receptacle 12 in. Leads	Female Straight Receptacle 12 in. Leads
2		13A 600V	1-White 2-Black	12 in.	82MRC	82FRC
3		13A 600V	1-Green 2-Black 3-White	12 in.	83MRC	83FRC
4		10A 600V	1-Black 2-White 3-Red 4-Green	12 in.	84MRC	84FRC
5		8A 600V	1-White 2-Red 3-Green 4-Orange 5-Black	12 in.	85MRC	85FRC
6		8A 600V	1-White 2-Red 3-Green 5-Black 4-Orange 6-Blue	12 in.	86MRC	86FRC



MANY ERICSON PRODUCTS ARE LISTED OR CERTIFIED.
 FOR THE LATEST FULL SEARCHABLE LISTING BY PART NUMBER, GO TO: WWW.ERICSON.COM/AGENCY
 Note: Products shown on this page may not be listed.

Specifications

MATERIALS

Insert Material: Nitrile Rubber

Contact: Brass, Gold Plated over Nickel

Sleeve: Stainless Steel

Shell: Machined Aluminum, Black Anodized (stainless steel available)

Wire: #16 AWG/600 Volts 26 x #30 Stranding

"O" Ring: Viton

Lock nut: Plated Steel (not pictured)

ELECTRICAL

Voltage Rating: 600 VAC

Contact Resistance: $\leq 5m \Omega$

ENVIRONMENTAL

Protection: IP68, NEMA 6P

Operating Temp: -50°C to 90°C (UL),
-34°C to 90°C (CSA)

CERTIFICATIONS



OPTIONS

Stainless Steel Hardware can be specified - add "SS" after Part Number; to specify 18 AWG Wire add "-18" after the Part Number.

Not available in stainless steel.

DIMENSIONS

6B-8 POLE Receptacle

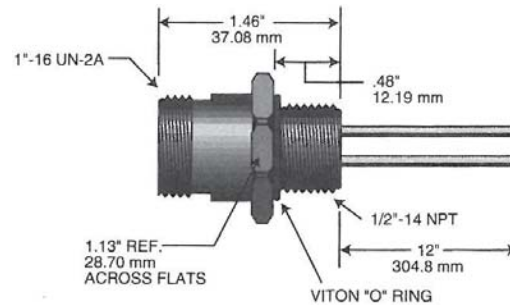

6B-12 POLE Receptacle

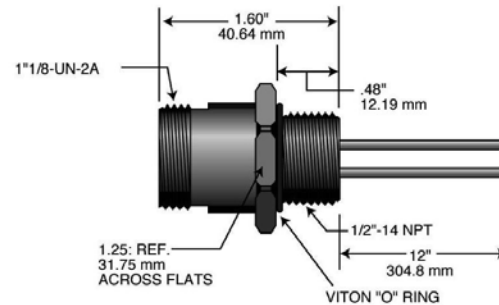

MINI-SYNC™ - 6B-12 Pole Receptacles

Poles	Face View	Rating	Wiring Code	Overall Length (ft./m)	Male Straight Receptacle 12 in. Leads	Female Straight Receptacle 12 in. Leads
6 B Size		8A 600V	1-White 2-Red 3-Green 5-Black 4-Orange 6-Blue 7-Green	12 inches	86BMRC	86BFRC
8		8A 600V	1-White 2-Red 3-Green 5-Black 4-Orange 6-Blue 7-Green 8-White-Blk.Tr.	12 inches	88MRC	88FRC
9		7A 600V	1-Orange 2-Blue 3-Red-Blk.Tr. 4-Green-Blk.Tr. 5-White 6-Red 7-Green 8-White-Blk.Tr. 9-Black	12 inches	89MRC	89FRC
10		7A 600V	1-Orange 2-Blue 3-White-Blk.Tr. 4-Red-Blk.Tr. 5-Green-Blk.Tr. 6-Orange-Blk.Tr. 7-Red 8-Green 9-Black 10-White	12 inches	810MRC	810FRC
12		7A 600V	1-Orange 2-Blue 3-White-Blk.Tr. 4-Red-Blk.Tr. 5-Green-Blk.Tr. 6-Orange-Blk.Tr. 7-Blue-Blk.Tr. 8-Black-Wht.Tr. 9-Green 10-Red 11-White 12-Black	12 inches	812MRC	812FRC



MANY ERICSON PRODUCTS ARE LISTED OR CERTIFIED.

FOR THE LATEST FULL SEARCHABLE LISTING BY PART NUMBER, GO TO: WWW.ERICSON.COM/AGENCY

Note: Products shown on this page may not be listed.

SPECIFICATIONS

MATERIALS

- Body:** PVC
- Contact Carrier:** Nitrile Rubber
- Contact Sleeve:** Stainless Steel
- Contact:** Brass, Gold Plated over Nickel
- Coupling Nut:** Machined Aluminum, Black Anodized

Cable: #16 AWG Type PVC, 65 x
#34 stranding, 105° C
Other cables available

Cable Diameters: 2/C-.37", 3/C-.39",
4/C-.42", 5/C-.50", 6/C-.53"

ELECTRICAL

- Voltage Rating:** 600 VAC
- Contact Resistance:** ≤5m Ω

ENVIRONMENTAL

- Protection:** IP68, NEMA 6P
- Operating Temp:** -20°C to 105°C

CERTIFICATIONS



OPTIONS

- #18 AWG (PVC) Plug Assemblies
- Stainless Steel Couplers
- Plastic Couplers

Consult the factory for custom wire length and a full range of wire management product accessories

DIMENSIONS

Female/Male Cordset

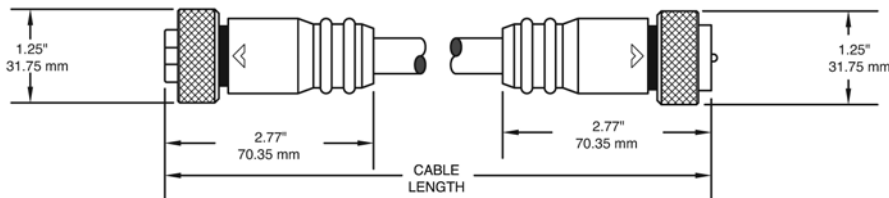

Poles	Face Views	Rating	Overall Wiring Code	Length (ft./m)	MINI-SYNC™ Male/Female Straight	MINI-SYNC™ Male 90°/Female Straight	MINI-SYNC™ Male 90°/Female 90°	MINI-SYNC™ Female 90° / Male Straight
2	Male Female 	13A 600V	1-White 2-Black	3 ft./0.91m	82FMS003A	82M9FS003A	82F9M9003A	82F9MS003A
				6 ft./1.83m	82FMS006A	82M9FS006A	82F9M9006A	82F9MS006A
				12 ft./3.66m	82FMS012A	82M9FS012A	82F9M9012A	82F9MS012A
				15 ft./4.57m	82FMS015A	82M9FS015A	82F9M9015A	82F9MS015A
				20 ft./6.10m	82FMS020A	82M9FS020A	82F9M9020A	82F9MS020A
3	Male Female 	13A 600V	1-Green 2-Black 3-White	3 ft./0.91m	83FMS003A	83M9FS003A	83F9M9003A	83F9MS003A
				6 ft./1.83m	83FMS006A	83M9FS006A	83F9M9006A	83F9MS006A
				12 ft./3.66m	83FMS012A	83M9FS012A	83F9M9012A	83F9MS012A
				15 ft./4.57m	83FMS015A	83M9FS015A	83F9M9015A	83F9MS015A
				20 ft./6.10m	83FMS020A	83M9FS020A	83F9M9020A	83F9MS020A
4	Male Female 	10A 600V	1-Black 2-White 3-Red 4-Green	3 ft./0.91m	84FMS003A	84M9FS003A	84F9M9003A	84F9MS003A
				6 ft./1.83m	84FMS006A	84M9FS006A	84F9M9006A	84F9MS006A
				12 ft./3.66m	84FMS012A	84M9FS012A	84F9M9012A	84F9MS012A
				15 ft./4.57m	84FMS015A	84M9FS015A	84F9M9015A	84F9MS015A
				20 ft./6.10m	84FMS020A	84M9FS020A	84F9M9020A	84F9MS020A
5	Male Female 	8A 600V	1-White 2-Red 3-Green 4-Orange 5-Black	3 ft./0.91m	85FMS003A	85M9FS003A	85F9M9003A	85F9MS003A
				6 ft./1.83m	85FMS006A	85M9FS006A	85F9M9006A	85F9MS006A
				12 ft./3.66m	85FMS012A	85M9FS012A	85F9M9012A	85F9MS012A
				15 ft./4.57m	85FMS015A	85M9FS015A	85F9M9015A	85F9MS015A
				20 ft./6.10m	85FMS020A	85M9FS020A	85F9M9020A	85F9MS020A
6	Male Female 	8A 600V	1-White 2-Red 3-Green 4-Orange 5-Black 6-Blue	3 ft./0.91m	86FMS003A	86M9FS003A	86F9M9003A	86F9MS003A
				6 ft./1.83m	86FMS006A	86M9FS006A	86F9M9006A	86F9MS006A
				12 ft./3.66m	86FMS012A	86M9FS012A	86F9M9012A	86F9MS012A
				15 ft./4.57m	86FMS015A	86M9FS015A	86F9M9015A	86F9MS015A
				20 ft./6.10m	86FMS020A	86M9FS020A	86F9M9020A	86F9MS020A

Closure Caps for Plugs and Receptacles

Adapter for Joining Two Cable Assemblies

Plug

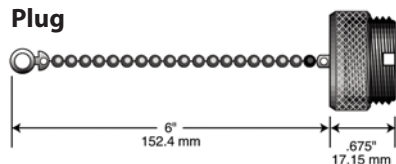

Receptacle

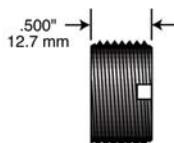
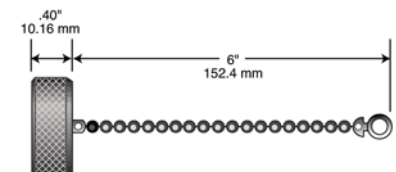

Number of Poles	Part Number
2, 3, 4, 5, or 6 (A Size)	826AJAD
6 (B Size), 7, or 8	86B8JAD
9, 10, or 12	8912JAD

Number of Poles	Plugs	Receptacles
2, 3, 4, 5, or 6 (A Size)	826AETCC	826AITCC
6 (B Size), 7, or 8	86B8ETCC	86B8ITCC
9, 10, or 12	8912ETCC	8912ITCC



MANY ERICSON PRODUCTS ARE LISTED OR CERTIFIED.
 FOR THE LATEST FULL SEARCHABLE LISTING BY PART NUMBER, GO TO: WWW.ERICSON.COM/AGENCY
 Note: Products shown on this page may not be listed.



SPECIFICATIONS

MATERIALS

Body: PVC
O-Ring: Nitrile Rubber
Contact Carrier: Zytel ST801
Contact: Brass, Gold Plated over Nickel
Coupling Nut: Machined Aluminum, Clear Anodized
Cable: #22 AWG PVC 26 x #36 stranding, 105°C,
 Or #18 AWG PVC 41 x #34 stranding, 105°C,
 UL Recognized, CSA Certified
Cable Diameters: #22 AWG PVC w/o braid, 2/C-.17",
 3/C-.18", 4/C-.19", 5/C-.21", 6/C-.22"

ELECTRICAL

Voltage Rating: 300 VAC
Current Rating: #22 AWG 2 to 5 Pole – 4A,
 6 Pole – 3A, #18 AWG – 5A
 Contact Resistance: <5mΩ

ENVIRONMENTAL

Protection: IP68, NEMA 6P
Operating Temp: -20°C to 105°C
 Certifications



OPTIONS

#18 AWG (PVC) Plug Assemblies (2-5) Poles
 Stainless Steel Couplers
 Plastic Couplers

Consult the factory for custom wire length and a full range of wire management product accessories

DIMENSIONS



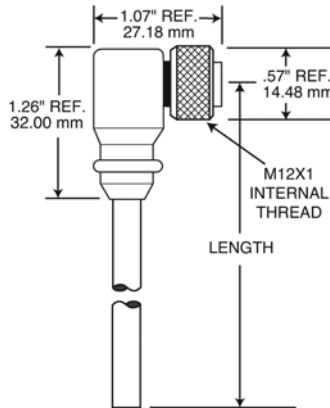
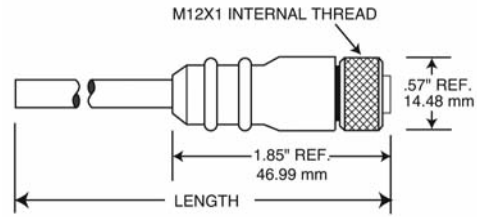

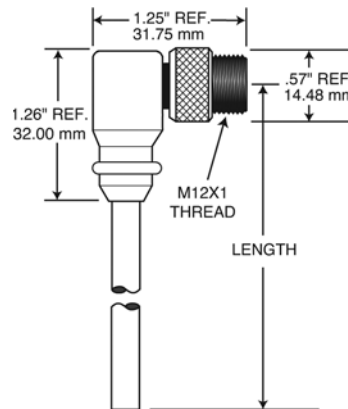
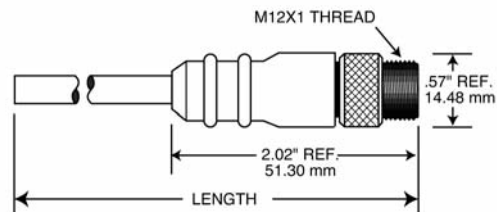

Female Plugs



Male Plugs



MICRO-SYNC™ - Single Key (DC) Male & Female - Straight & 90°

Poles	Face View	Rating	Wiring Code	Overall Length (m/ft.)	MICRO-SYNC™ Straight Male	MICRO-SYNC™ Male 90°	MICRO-SYNC™ Female Straight	MICRO-SYNC™ Female 90°
3	Male  Female 	4A 300V	1-Brown 2-N/A 3-Blue 4-Black	2m / 6.6 ft.	93MSE2G	93M9E2G	93FS2G	93F92G
				4m / 13.1 ft.	93MSE4G	93M9E4G	93FS4G	93F94G
				5m / 16.3 ft.	93MSE5G	93M9E5G	93FS4G	93F95G
4	Male  Female 	4A 300V	1-Brown 2-White 3-Blue 4-Black	2m / 6.6 ft.	94MSE2G	94M9E2G	94FS2G	94F92G
				4m / 13.1 ft.	94MSE4G	94M9E4G	94FS4G	94F94G
				5m / 16.3 ft.	94MSE5G	94M9E5G	94FS5G	94F95G
5	Male  Female 	4A 300V	1-Brown 2-White 3-Blue 4-Black 5-Grey	2m / 6.6 ft.	95MSE2G	95M9E2G	95FS2G	95F92G
				4m / 13.1 ft.	95MSE4G	95M9E4G	95FS4G	95F94G
				5m / 16.3 ft.	95MSE5G	95M9E5G	95FS5G	95F95G



MANY ERICSON PRODUCTS ARE LISTED OR CERTIFIED.
 FOR THE LATEST FULL SEARCHABLE LISTING BY PART NUMBER, GO TO: WWW.ERICSON.COM/AGENCY
 Note: Products shown on this page may not be listed.

SPECIFICATIONS

MATERIALS

Body: PVC
O-Ring: Nitrile Rubber
Contact Carrier: Zytel ST801
Contact: Brass, Gold Plated over Nickel
Coupling Nut: Machined Aluminum, Clear Anodized
Cable: #22 AWG PVC 26 x #36 stranding, 105°C, Or #18 AWG PVC 41 x #34 stranding, 105°C, UL Recognized, CSA Certified
Cable Diameters: #22 AWG PVC w/o braid, 2/C-.17", 3/C-.18", 4/C-.19", 5/C-.21", 6/C-.22"

ELECTRICAL

Voltage Rating: 300 VAC
Current Rating: #22 AWG 2 to 5 Pole – 4A, 6 Pole – 3A, #18 AWG – 5A
Contact Resistance: <5mΩ

ENVIRONMENTAL

Protection: IP68, NEMA 6P
Operating Temp: -20°C to 105°C

CERTIFICATIONS



OPTIONS





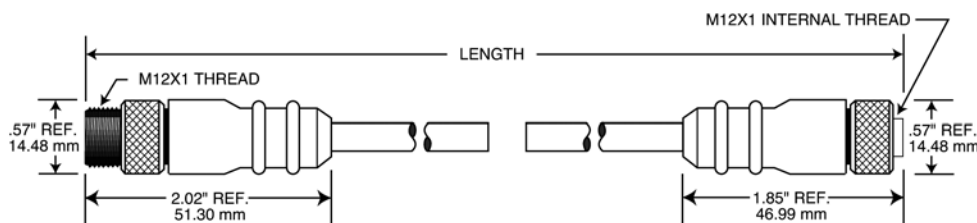

#18 AWG (PVC) Plug Assemblies (2-5) Poles
 Stainless Steel Couplers
 Plastic Couplers

Consult the factory for custom wire length and a full range of wire management product accessories

DIMENSIONS



MICRO-SYNC™ - Single Key (DC) Cable Assemblies

Poles	Face View	Rating	Wiring Code	Overall Length (ft./m)	MICRO-SYNC™ DC Female / Male Straight
3	<p>Male</p>  <p>Female</p> 	4A 300V	1-Brown 2-N/A 3-Blue 4-Black	6 ft. / 1.8 m	93FMSE2G
				12 ft. / 3.6 m	93FMSE4G
				20 ft. / 6.1 m	93FMSE5G
4	<p>Male</p>  <p>Female</p> 	4A 300V	1-Brown 2-White 3-Blue 4-Black	6 ft. / 1.8 m	94FMSE2G
				12 ft. / 3.6 m	94FMSE4G
				20 ft. / 6.1 m	94FMSE5G
5	<p>Male</p>  <p>Female</p> 	4A 300V	1-Brown 2-White 3-Blue 4-Black 5-Grey	6 ft. / 1.8 m	95FMSE2G
				12 ft. / 3.6 m	95FMSE4G
				20 ft. / 6.1 m	95FMSE5G



MANY ERICSON PRODUCTS ARE LISTED OR CERTIFIED.

FOR THE LATEST FULL SEARCHABLE LISTING BY PART NUMBER, GO TO: WWW.ERICSON.COM/AGENCY

Note: Products shown on this page may not be listed.

SPECIFICATIONS

MATERIALS

Insert Material: Zytel ST801
O-Ring: Nitrile Rubber
Contact: Brass, Gold Plated over Nickel
Shell: Machine Aluminum, Black Anodized
Lock Nut: Plated Steel
Wire: #22 AWG PVC Insulated 26 x #36 stranding, 80°C

ELECTRICAL

Voltage Rating: 300 VAC
Current Rating: #22 AWG 2- 4A,
 #18 AWG - 5A
Contact Resistance: <5mΩ

ENVIRONMENTAL

Protection: IP68, NEMA 6P
 Operating Temp: -20°C to 80°C

CERTIFICATIONS



OPTIONS

#18 AWG (PVC) Leads
 Stainless Steel Shells
 Not available on back panel mount styles

DIMENSIONS

Male Receptacles

1/2" NPT

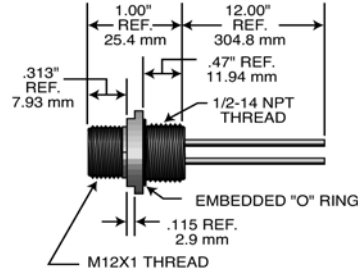

M14 x 1

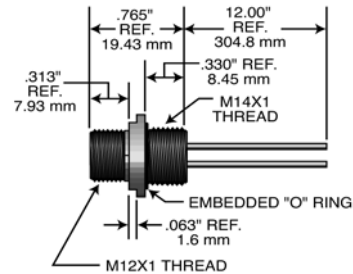

Female Receptacles



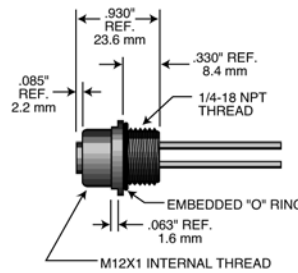

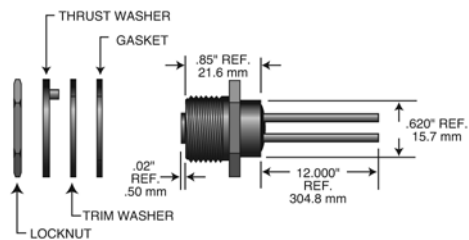

1/4" NPT



Back Panel Mount



MICRO-SYNC™ - Single Key (DC) Receptacles

Poles	Face View	Rating	Wiring Code	Overall Length (ft./m)	MICRO-SYNC™ DC Male 1/2" NPT	MICRO-SYNC™ DC Male M14 x 1	MICRO-SYNC™ DC Female 1/4" NPT	MICRO-SYNC™ DC Female Back Panel
3	<p>Male</p>  <p>Female</p> 	4A 300V	1-Brown 2-N/A 3-Blue 4-Black	12 inches	93MRK2	93MRK4	93FRK1	93FRK3
4	<p>Male</p>  <p>Female</p> 	4A 300V	1-Brown 2-White	12 inches	94MRK2	94MRK4	94FRK1	94FRK3
5	<p>Male</p>  <p>Female</p> 	4A 300V	1-Brown 2-White 3-Blue 4-Black 5-Grey	12 inches	95MRK2	95MRK4	95FRK1	95FRK3



MANY ERICSON PRODUCTS ARE LISTED OR CERTIFIED.
 FOR THE LATEST FULL SEARCHABLE LISTING BY PART NUMBER, GO TO: WWW.ERICSON.COM/AGENCY
 Note: Products shown on this page may not be listed.

SPECIFICATIONS

MATERIALS

Body: PVC
O-Ring: Nitrile Rubber
Contact Carrier: Zytel ST801
Contact: Brass, Gold Plated over Nickel
Coupling Nut: Machined Aluminum, Clear Anodized
Cable: #22 AWG PVC 26 x #36 stranding, 105°C,
 Or #18 AWG PVC 41 x #34 stranding, 105°C,
 UL Recognized, CSA Certified
 Cable Diameters: #22 AWG PVC w/o braid, 2/C-.17",
 3/C-.18", 4/C-.19", 5/C-.21", 6/C-.22"

ELECTRICAL

Voltage Rating: 300 VAC
Current Rating: #22 AWG 2 to 5 Pole – 4A,
 6 Pole – 3A, #18 AWG – 5A
 Contact Resistance: <5mΩ

ENVIRONMENTAL

Protection: IP68, NEMA 6P
Operating Temp: -20°C to 105°C

CERTIFICATIONS



OPTIONS

#18 AWG (PVC) Plug Assemblies (2-5) Poles
 Stainless Steel Couplers
 Plastic Couplers

Consult the factory for custom wire length and a full range of wire management product accessories

DIMENSIONS



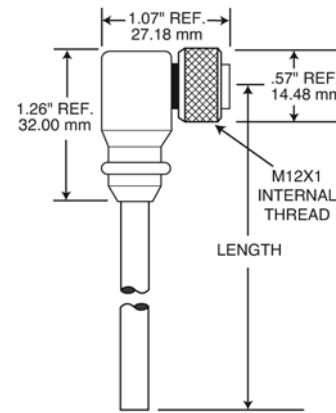
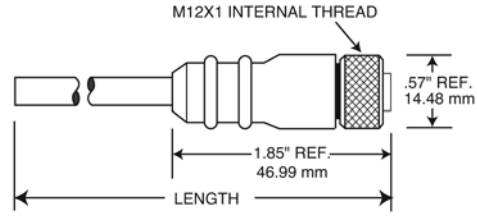

Female Plugs

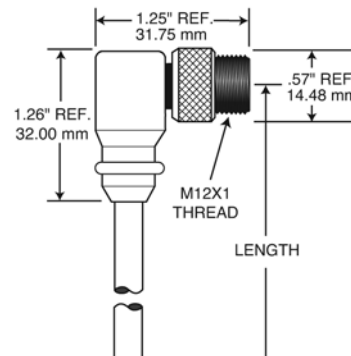
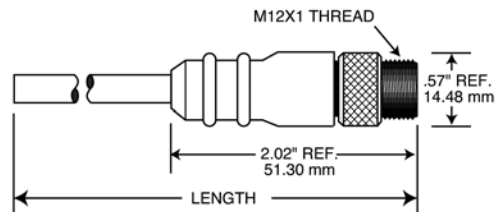

Male Plugs



MICRO-SYNC™ - Dual Key (AC) Male & Female - Straight & 90°

Poles	Face View	Rating	Wiring Code	Overall Length (ft./m)	MICRO-SYNC™ Male Straight	MICRO-SYNC™ Male 90°	MICRO-SYNC™ Female Straight	MICRO-SYNC™ Female 90°
2	Male 	4A 300V	1-Brown 2-Blue	6 ft. / 1.8 m	72MSE006F	72M9E006F	72FS006F	72F9006F
	12 ft. / 3.6 m			72MSE012F	72M9E012F	72FS012F	72F9012F	
	20 ft. / 6.1 m			72MSE020F	72M9E020F	72FS020F	72F9020F	
3	Male 	4A 300V	1-Brown 2-Red/Black 3-Red/White	6 ft. / 1.8 m	73MSE006F	73M9E006F	73FS006F	73F9006F
	12 ft. / 3.6 m			73MSE012F	73M9E012F	73FS012F	73F9012F	
	20 ft. / 6.1 m			73MSE020F	73M9E020F	73FS020F	73F9020F	
4	Male 	4A 300V	1-Red/Black 2-Red/White 3-Red 4-Green	6 ft. / 1.8 m	74MSE006F	74M9E006F	74FS006F	74F9006F
	12 ft. / 3.6 m			74MSE012F	74M9E012F	74FS012F	74F9012F	
	20 ft. / 6.1 m			74MSE020F	74M9E020F	74FS020F	74F9020F	
5	Male 	4A 300V	1-Red/White 2-Red 3-Green 4-Red/Yellow 5-Red/Black	6 ft. / 1.8 m	75MSE006F	75M9E006F	75FS006F	75F9006F
	12 ft. / 3.6 m			75MSE012F	75M9E012F	75FS012F	75F9012F	
	20 ft. / 6.1 m			75MSE020F	75M9E020F	75FS020F	75F9020F	
6	Male 	4A 300V	1-Red/White 2-Red 3-Green 4-Red/Yellow 5-Red/Black 6-Red/Blue	6 ft. / 1.8 m	76MSE006F	76M9E006F	76FS006F	76F9006F
	12 ft. / 3.6 m			76MSE012F	76M9E012F	76FS012F	76F9012F	
	20 ft. / 6.1 m			76MSE020F	76M9E020F	76FS020F	76F9020F	



MANY ERICSON PRODUCTS ARE LISTED OR CERTIFIED.
 FOR THE LATEST FULL SEARCHABLE LISTING BY PART NUMBER, GO TO: WWW.ERICSON.COM/AGENCY
 Note: Products shown on this page may not be listed.

SPECIFICATIONS

MATERIALS

Body: PVC
O-Ring: Nitrile Rubber
Contact Carrier: Zytel ST801
Contact: Brass, Gold Plated over Nickel
Coupling Nut: Machined Aluminum, Clear Anodized
Cable: #22 AWG PVC 26 x #36 stranding, 105°C, Or #18 AWG PVC 41 x #34 stranding, 105°C, UL Recognized, CSA Certified
Cable Diameters: #22 AWG PVC w/o braid, 2/C-.17", 3/C-.18", 4/C-.19", 5/C-.21", 6/C-.22"

ELECTRICAL

Voltage Rating: 300 VAC
Current Rating: #22 AWG 2 to 5 Pole – 4A, 6 Pole – 3A, #18 AWG – 5A
Contact Resistance: <5mΩ

ENVIRONMENTAL

Protection: IP68, NEMA 6P
Operating Temp: -20°C to 105°C

CERTIFICATIONS



OPTIONS







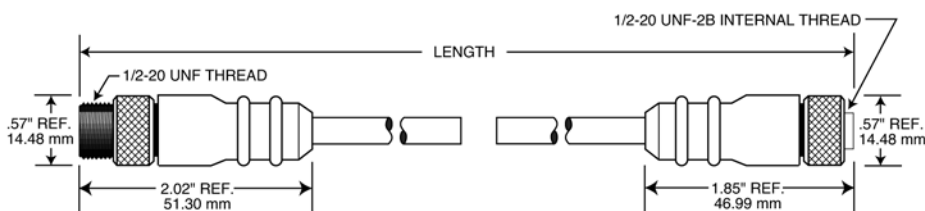



#18 AWG (PVC) Plug Assemblies (2-5) Poles
 Stainless Steel Couplers
 Plastic Couplers

Consult the factory for custom wire length and a full range of wire management product accessories

DIMENSIONS



MICRO-SYNC™ - Dual Key (AC) Cable Assemblies

Poles	Face View	Rating	Wiring Code	Overall Length (ft./m)	MICRO-SYNC™ AC Female / Male Straight
2	Male 	4A 300V	1-Brown 2-Blue	6 ft. / 1.8 m	72FMSE006F
	Female 			12 ft. / 3.6 m	72FMSE012F
				20 ft. / 6.1 m	72FMSE020F
3	Male 	4A 300V	1-Brown 2-N/A 3-Blue 4-Black	6 ft. / 1.8 m	73FMSE006F
	Female 			12 ft. / 3.6 m	73FMSE012F
				20 ft. / 6.1 m	73FMSE020F
4	Male 	4A 300V	1-Brown 2-White 3-Blue 4-Black	6 ft. / 1.8 m	74FMSE006F
	Female 			12 ft. / 3.6 m	74FMSE012F
				20 ft. / 6.1 m	74FMSE020F
5	Male 	4A 300V	1-Brown 2-White 3-Blue 4-Black 5-Grey	6 ft. / 1.8 m	75FMSE006F
	Female 			12 ft. / 3.6 m	75FMSE012F
				20 ft. / 6.1 m	75FMSE020F
6	Male 	4A 300V	1-Red/White 2-Red 3-Green 4-Red/Yellow 5-Red/Black 6-Red/Blue	6 ft. / 1.8 m	76FMSE006F
	Female 			12 ft. / 3.6 m	76FMSE012F
				20 ft. / 6.1 m	76FMSE020F



MANY ERICSON PRODUCTS ARE LISTED OR CERTIFIED.
 FOR THE LATEST FULL SEARCHABLE LISTING BY PART NUMBER, GO TO: WWW.ERICSON.COM/AGENCY
 Note: Products shown on this page may not be listed.

SPECIFICATIONS

MATERIALS

Insert Material: Zytel ST801
O-Ring: Nitrile Rubber
Contact: Brass, Gold Plated over Nickel
Shell: Machine Aluminum, Clear Anodized
Lock Nut: Plated Steel
Wire: #22 AWG PVC Insulated 26 x #36 stranding, 80°C

ELECTRICAL

Voltage Rating: 300 VAC
Current Rating: #22 AWG – 2 to 5 Pole – 4A, 6 Pole – 3A / #18 AWG – 5A
Contact Resistance: <5mΩ

ENVIRONMENTAL

Protection: IP68, NEMA 6P
Operating Temp: -20°C to 80°C

CERTIFICATIONS



OPTIONS

#18 AWG (PVC) Leads
 Stainless Steel Shells

DIMENSIONS

Male Receptacles

1/4" NPT

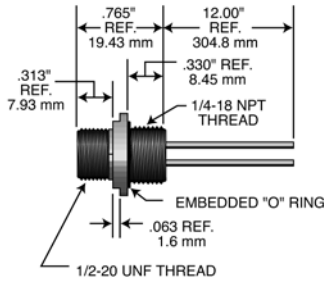

1/2" NPT

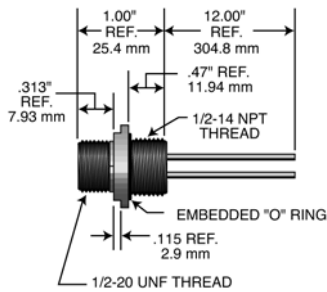





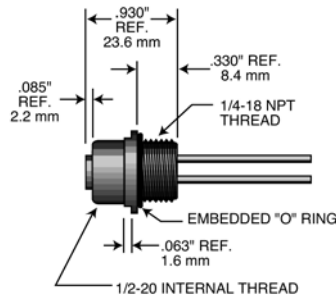



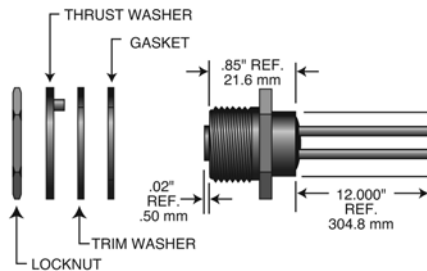

Female Receptacles

1/4" NPT



Back Panel Mount



Poles	Face View	Rating	Wiring Code	Overall Length (ft./m)	MICRO-SYNC™ AC Male 1/2" NPT	MICRO-SYNC™ AC Male 1/4" NPT	MICRO-SYNC™ AC Female 1/4" NPT	MICRO-SYNC™ AC Female Back Panel
2	<p>Male</p>  <p>Female</p> 	4A 300V	1-Brown 2-Blue	12 inches	72MRK2	72MRK1	72FRK1	72FRK3
3	<p>Male</p>  <p>Female</p> 	4A 300V	1-Brown 2-Red/Black 3-Red/White	12 inches	73MRK2	73MRK1	73FRK1	73FRK3
4	<p>Male</p>  <p>Female</p> 	4A 300V	1-Red/Black 2-Red/White 3-Red 4-Green	12 inches	74MRK2	74MRK1	74FRK1	74FRK3
5	<p>Male</p>  <p>Female</p> 	4A 300V	1-Red/White 2-Red 3-Green 4-Red/Yellow 5-Red/Black	12 inches	75MRK2	75MRK1	75FRK1	75FRK3
6	<p>Male</p>  <p>Female</p> 	4A 300V	1-Red/White 2-Red 3-Green 4-Red/Yellow 5-Red/Black 6-Red/Blue	12 inches	76MRK2	76MRK1	76FRK1	N/A

Wire Management Accessories

Closure Caps for Plugs and Receptacles With Internal Threads

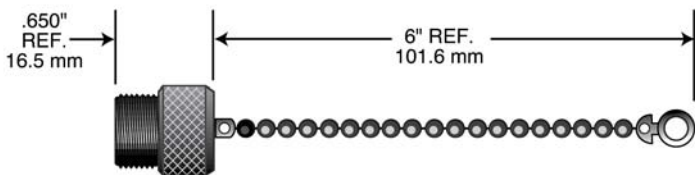

Single Key (M12)	Dual Key (1/2-20)
9ETSKCC	7ETDKCC

Closure Caps for Plugs and Receptacles With External Threads

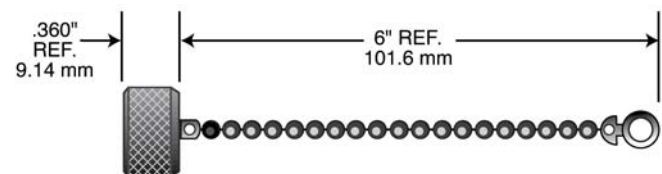

Single Key (M12)	Dual Key (1/2-20)
9ITSKCC	7ITDKCC



MANY ERICSON PRODUCTS ARE LISTED OR CERTIFIED. FOR THE LATEST FULL SEARCHABLE LISTING BY PART NUMBER, GO TO: WWW.ERICSON.COM/AGENCY
 Note: Products shown on this page may not be listed.

