



 **EXCELTA[®]**
SINCE 1957





Over sixty years ago, the American aerospace industry was faced with a problem. As technology advanced, electronics were getting smaller, more complex, and harder to assemble and maintain. This problem needed solving, and a young entrepreneur named Jerome Dalseme thought he carried the answer in his briefcase, a selection of precision watchmakers tools from Europe.

When the giants of aerospace were presented with these purpose-built, high-precision tweezers, they found the tools they needed. Many of these tweezers were adopted and remained in use for decades. After this success, Mr. Dalseme founded Excelta on the principle of staying one step ahead of the changing needs of its customers and always offering a tool Precisely Right for the job.

Our catalog began as a modest selection of pliers and tweezers which has now grown to encompass over 1,500 hand tools. We pay close attention to our customers in military and consumer electronics, in medical device manufacturing and in schools and labs across the country to ensure Excelta stocks the tools they need.

Excelta's Special & Customs Application Department are experts in adapting tools to meet hyperspecialized needs. Our California-based manufacturing plant hosts an innovative R&D department and works diligently to develop groundbreaking new designs for the hand tools of tomorrow.

Industry is constantly changing and Excelta is committed to making sure you're always reaching for a tool that is Precisely Right for the task at hand.

9200 SL Series

New Slim Line Cutters - New geometry, improved LazerLok™ joint system, ESD-safe slim handles and black oxide finish to inhibit rust and glare.



7376E

New subminiature angulated tip cutter. Our smallest tip cutter yet. 50° tip angle makes for excellent visibility in limited access areas or microscopic work.



EI Series

New Italian made cutters - 3 Star cutters for general use. Hardened jaws allow greater tool life and smooth clean cuts.



M-159 Series

New miniature Carbofib™ tweezers. Protect against ESD damage (conductive), Nicking, Scratching and Marring with these new 3 1/2" softip tweezers. Ideal for working under a microscope or in areas with limited accessibility.





5 levels
of precision!

5 levels
of pricing!



We offer a wide range of materials and designs for any application.



For the most critical applications, the Excelta Five Star line offers ultra-precision with the most advanced materials available.



For demanding applications, the Excelta Four Star line meets and exceeds high precision requirements.



The Excelta Three Star line offers the widest range of products designed for pharmaceutical, medical manufacturing, military and electronic assembly.



When precision is required and price is a concern, the Excelta Two Star line fills most requirements.



The One Star line offers quality products at the most economical price.

Call us at Excelta Corporation or contact your local Excelta Sales Representative to find tools *"Precisely Right"* for you.

TABLE OF CONTENTS

CUTTERS

| | |
|---------------------------------|----|
| Technical Information | 10 |
| Correlation Chart | 13 |
| Side Cutters | |
| Small Head | 14 |
| Medium Head | 16 |
| Large Head | 19 |
| Fine Tip Cutters | 20 |
| Angulated Cutters | |
| Small Head | 22 |
| Medium Head | 23 |
| Large Head | 24 |
| Transverse Cutters | 26 |
| Tungsten Carbide Insert Cutters | 27 |
| Standoff Shear Cutters | 28 |
| Cable Cutters/Depanelizers | 33 |

TWEEZERS (Cont)

| | |
|----------------------------|-------|
| Cross Action | 87 |
| Miniature | 65/89 |
| Ergonomic | 92 |
| SMD & Small Parts Handling | 100 |
| Wafer | 105 |
| Replaceable Tip | 108 |
| Peek | 109 |
| Copolymer | 110 |
| Carbon Fiber | 111 |
| Acetal | 113 |
| Ceramic | 115 |
| Plastic | 116 |
| Cutting | 118 |
| Wire Stripping Tools | 124 |
| Kitsets | 126 |
| Lab Specific | 130 |

PLIERS

| | |
|-----------------------------|----|
| Plier Technical Information | 35 |
| Miniature Self-Opening | 36 |
| Standard Pliers | |
| Small Head | 37 |
| Medium Head | 40 |
| Large Head | 43 |
| Cleanroom Safe | 44 |
| Soft Tip | 45 |
| Wide Jaw | 46 |
| Concave/Convex | 46 |
| Tubing Cutters/Expanders | 47 |

SCISSORS HEMOSTATS

| | |
|-------------------------|-----|
| Scissors | |
| Tungsten Carbide Insert | 136 |
| Delicate Applications | 137 |
| Fine Precision | 140 |
| Large Precision | 144 |
| Hemostats | 145 |
| Clamps & Needle Holders | 147 |

DESIGN SPECIALS

| | |
|-----------------------------|----|
| Lead Forming | 50 |
| Insertion/Extraction Pliers | 57 |

BRUSHES

| | |
|------------------------------------|-----|
| Instrument Cleaning/Heat Resistant | 148 |
| ESD Safe/Cleanroom Safe | 149 |
| Scratch/Cleaning | 150 |
| Miscellaneous - ESD Safe | 151 |

TWEEZERS

| | |
|-------------------------------|----|
| Technical Information | 58 |
| Adders | 60 |
| Cobalt Alloy | 62 |
| Exotic Metals/Coatings | 66 |
| Standard | 72 |
| Straight Tapered - Microscopy | 73 |
| Straight Very Fine Points | 74 |
| Angulated Very Fine Points | 76 |
| Curved Very Fine Points | 78 |
| Straight Medium Points | 79 |
| Straight Strong Points | 80 |
| Straight Medium Points | 81 |
| Straight Round Fine Points | 82 |
| Straight Broad/Medium Points | 83 |
| Angled Medium Points | 84 |
| Tapered Flat Round Points | 85 |
| Large Flat Points | 86 |

SMALL HAND TOOLS

| | |
|-------------------------|-----|
| Scalpels & Razor Blades | 152 |
| Miniature Oilers | 154 |
| Spatulas / Mirrors | 156 |
| Pin Vises | 157 |
| Probes & Scribes | |
| Stainless Steel | 158 |
| Lab Specific | 159 |
| Magnifiers / Loops | 160 |

METERS

| | |
|------------------|-----|
| Continuity Meter | 161 |
| R-C-L Meter | 162 |

VACUUM

| | |
|-------------------------|-----|
| Roto Pic® Vacuum System | 166 |
| Continous Vacuum | 168 |
| Pen-Vac® and Handi-Vac® | 169 |
| Cups and Probes | 171 |



CUSTOM DESIGN SERVICE

As the leader in tool technology, Excelta knows every application is unique. Our Custom Design facility can work from your schematic to manufacture any tool to your specifications. Or, if you prefer, our experienced designers can diagnose your needs and design a tool "Precisely Right" for your unique application.



Whether you need a single tool to handle special parts under unique conditions, or a supply of custom tools to crimp, cut, place or extract parts, Excelta's Custom Design Service has the experience, ingenuity and capability to meet your needs.



USA



Precision.

Welcome to the new era in wire cutting technology!

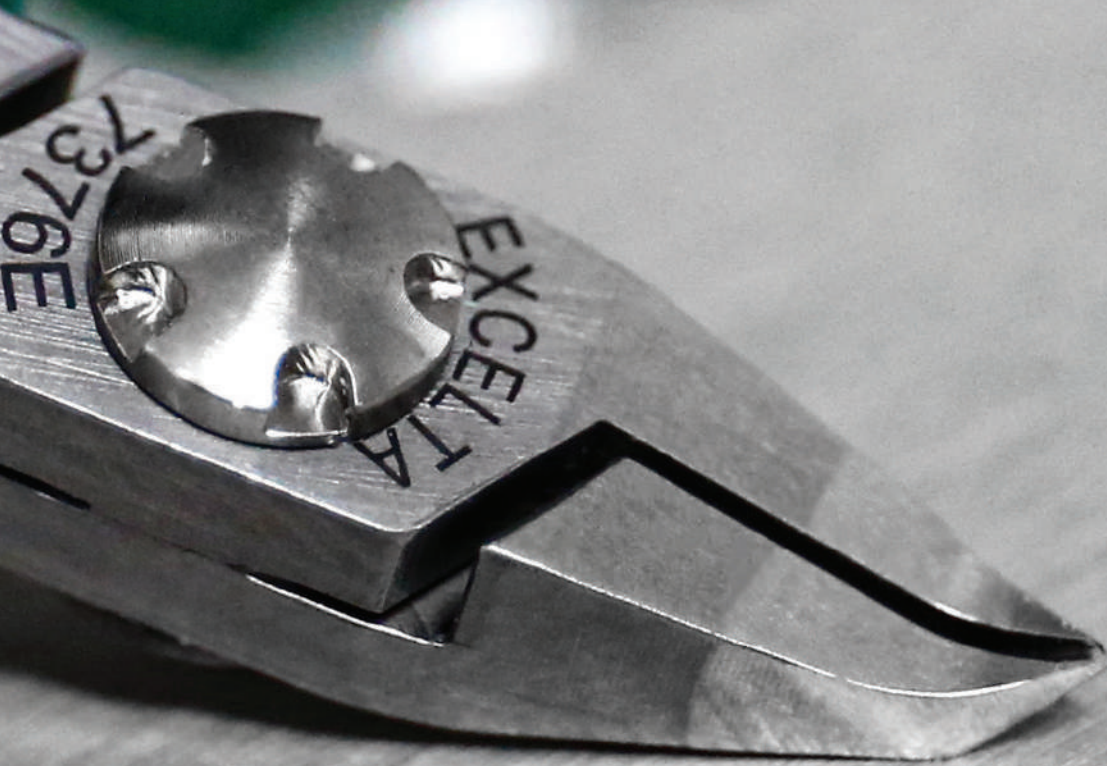

DESIGNED AND MANUFACTURED
IN BUELLTON CALIFORNIA

EDGES ARE INDUCTION
HARDENED TO RHC 63-65

STAINLESS STEEL
LEAF SPRINGS



LazerLine

Excelta has pioneered the combined use of Laser technology with advanced CNC machining to build the finest grade cutter available. We start with premium steel, laser cut for consistency, and milled to exact specifications at our headquarters in Buellton, CA. Our cutting blades are induction hardened to

★★★★★ Ultra Precision

LazerLine



Look for the Made in USA icon throughout the catalog!



63-65 Rockwell C for durability, then CNC ground to within a thousandth of an inch to achieve unsurpassed sharpness and an unbelievably clean cut. Excelta's LazerLine series represents state of the art cutting tools, and is Precisely Right for all your cutting needs.

SIDE CUTTER

Selection Guide



Head Shapes

Oval Head

Tapered Head

Tapered Relieved Head

1. Choose head shape based on the following:

- The oval head cutter is the most common head shape for cutting tools. It allows for the maximum amount of 'metal' behind the cutting edge delivering an extremely long tool life.
- The tapered head was developed to allow the cutting tool to get into those "hard to reach" areas. It was designed more along diagonal lines with less "metal" behind the cutting edge.
- The tapered/relieved head allows for the most access to "hard to reach" areas. In addition to having a diagonal profile, the face has been relieved allowing even greater access.

Type of Cut

Semi Flush
0.010 Bevel

Optimum Flush
0.005 Bevel

Lazer Flush
0.000 Bevel

2. Choose 'Type of Cut' based on the following:

- Semi-Flush cutters have a cutting edge with a .010" bevel, which produces more cuts than a maximum flush cutter but leaves a 'pinch' on the lead/wire.
- Optimum-Flush cutters have a cutting edge with a .005" bevel, which produces a smaller 'pinch' on the lead/wire than a semi-flush cutter. The smaller bevel means fewer cuts than a semi-flush cutter.
- Lazer-Flush cutters have no bevel producing a pure, clean cut with no 'pinch' on the lead/wire. The cutting edges are extremely sharp. Cutting life is once again reduced over either of the above.

CUTTER CORRELATION CHART



3. Find your wire type & size then choose the cutter from this chart:

Hard Wire - Annealed Stainless Steel, Nitinol, Titanium, Polypropylenes. Tensile Strength 116,000/19,000 PSI

Soft Wire - Copper Wire, Rubber, Polyurethanes and PTFE. Tensile Strength up to 30,000 PSI

| | Part # | Cut | Wire | .03mm | .05mm | .08mm | .13mm | .20mm | .25mm | .30mm | .38mm | .40mm | .45mm | .50mm | .63mm | .70mm | .75mm | .80mm | .90mm | 1.0mm | 1.05mm | 1.13mm | 1.25mm | 1.5mm | 1.6mm | 2.0mm | | |
|--------------------|---------------|-----|------|-------|-------|-------|-------|-------|-------|-------|-------|-------|-------|-------|-------|-------|-------|-------|-------|-------|--------|--------|--------|-------|-------|-------|--|--|
| Small | 9231E | OF | Soft | | | | | | | | | | | | | | | | | | | | | | | | | |
| | 9232E | LF | Soft | | | | | | | | | | | | | | | | | | | | | | | | | |
| | 9238E | LF | Soft | | | | | | | | | | | | | | | | | | | | | | | | | |
| | 9231SL | OF | Soft | | | | | | | | | | | | | | | | | | | | | | | | | |
| | 9232SL | LF | Soft | | | | | | | | | | | | | | | | | | | | | | | | | |
| | 9235SL | LF | Soft | | | | | | | | | | | | | | | | | | | | | | | | | |
| | 9238SL | LF | Soft | | | | | | | | | | | | | | | | | | | | | | | | | |
| | 9240E/SL | SF | Soft | | | | | | | | | | | | | | | | | | | | | | | | | |
| Medium (Slim Line) | 9241E/SL | OF | Soft | | | | | | | | | | | | | | | | | | | | | | | | | |
| | 9242E/SL | LF | Soft | | | | | | | | | | | | | | | | | | | | | | | | | |
| | 9243E/SL | SF | Soft | | | | | | | | | | | | | | | | | | | | | | | | | |
| | 9244E/SL | OF | Soft | | | | | | | | | | | | | | | | | | | | | | | | | |
| | 9245E/SL | LF | Soft | | | | | | | | | | | | | | | | | | | | | | | | | |
| | 9246E/SL | SM | Soft | | | | | | | | | | | | | | | | | | | | | | | | | |
| | 9247E/SL | OF | Soft | | | | | | | | | | | | | | | | | | | | | | | | | |
| | 9248E/SL | LF | Soft | | | | | | | | | | | | | | | | | | | | | | | | | |
| Medium | 7140E/7240E | SF | Soft | | | | | | | | | | | | | | | | | | | | | | | | | |
| | 7141E/7241E | OF | Soft | | | | | | | | | | | | | | | | | | | | | | | | | |
| | 7142E/7242E | LF | Soft | | | | | | | | | | | | | | | | | | | | | | | | | |
| | 7143E/7243E | SF | Soft | | | | | | | | | | | | | | | | | | | | | | | | | |
| | 7144E/7244E | OF | Soft | | | | | | | | | | | | | | | | | | | | | | | | | |
| | 7145E/7245E | LF | Soft | | | | | | | | | | | | | | | | | | | | | | | | | |
| | 7146E/7246E | SF | Soft | | | | | | | | | | | | | | | | | | | | | | | | | |
| | 7147E/7247E | OF | Soft | | | | | | | | | | | | | | | | | | | | | | | | | |
| Large | 7148E/7248E | LF | Soft | | | | | | | | | | | | | | | | | | | | | | | | | |
| | 7210E | SF | Soft | | | | | | | | | | | | | | | | | | | | | | | | | |
| | 7250E | SF | Soft | | | | | | | | | | | | | | | | | | | | | | | | | |
| | 7251E | OF | Soft | | | | | | | | | | | | | | | | | | | | | | | | | |
| | 7260E | SF | Soft | | | | | | | | | | | | | | | | | | | | | | | | | |
| | 7261E | OF | Soft | | | | | | | | | | | | | | | | | | | | | | | | | |
| | 7371E | LF | Soft | | | | | | | | | | | | | | | | | | | | | | | | | |
| | 7171E/7271E | OF | Soft | | | | | | | | | | | | | | | | | | | | | | | | | |
| Tip | 7170EA/7270EA | OF | Soft | | | | | | | | | | | | | | | | | | | | | | | | | |
| | 7170E/7270E | OF | Soft | | | | | | | | | | | | | | | | | | | | | | | | | |
| | 7149E/7249E | OF | Soft | | | | | | | | | | | | | | | | | | | | | | | | | |
| | 7375E/7376E | LF | Soft | | | | | | | | | | | | | | | | | | | | | | | | | |
| | 7175E/7275E | OF | Soft | | | | | | | | | | | | | | | | | | | | | | | | | |
| | 7182E/7282E | OF | Soft | | | | | | | | | | | | | | | | | | | | | | | | | |
| | 7172E/7272E | OF | Soft | | | | | | | | | | | | | | | | | | | | | | | | | |
| | 7104E/7204E | OF | Soft | | | | | | | | | | | | | | | | | | | | | | | | | |
| 90° | 7174E/7274E | LF | Soft | | | | | | | | | | | | | | | | | | | | | | | | | |
| | 7173E/7273E | LF | Soft | | | | | | | | | | | | | | | | | | | | | | | | | |
| | 2899EHT | SF | Hard | | | | | | | | | | | | | | | | | | | | | | | | | |
| | 2897EHT | SF | Hard | | | | | | | | | | | | | | | | | | | | | | | | | |
| | 2896EHT | SF | Hard | | | | | | | | | | | | | | | | | | | | | | | | | |
| | 2876EHT | SF | Hard | | | | | | | | | | | | | | | | | | | | | | | | | |

SLIM LINE 9000 SERIES | MINIATURE HEAD CUTTERS

MADE IN USA ★★★★★ EXTREME PRECISION

Our new 9230SL SLIM LINE series feature a completely new and smaller profile. These tools have a black oxide finish to prevent oxidation and glare.

9230SL Series SL MOLDED Grips - ESD Safe (10⁹ Ohms/Sq.) Length 4.25" (106mm)



Slim Line Small Round Head

| Part# | Grip | Cutting Edge | Maximum Cutting Capacity | |
|--------|-----------|---------------|--------------------------|---------|
| 9231SL | SL Molded | Optimum-Flush | 18 AWG .040" | 1.00 mm |
| 9232SL | SL Molded | Lazer-Flush | 20 AWG .032" | 0.80 mm |



NEW ITEM

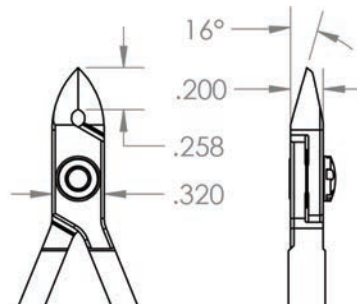

Slim Line Small Tapered

| Part# | Grip | Cutting Edge | Maximum Cutting Capacity | |
|--------|-----------|--------------|--------------------------|---------|
| 9235SL | SL Molded | Lazer-Flush | 22 AWG .025" | 0.63 mm |



NEW ITEM

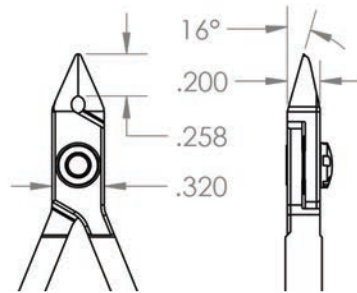

Slim Line Small Tapered/Relieved Head

| Part# | Grip | Cutting Edge | Maximum Cutting Capacity | |
|--------|-----------|--------------|--------------------------|---------|
| 9238SL | SL Molded | Lazer-Flush | 22 AWG .025" | 0.63 mm |



NEW ITEM

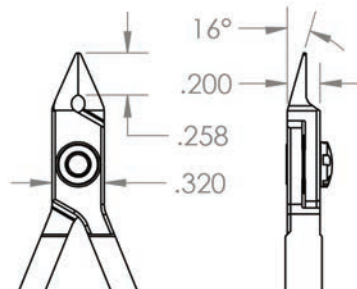

MINIATURE HEAD CUTTERS

9000 SERIES



★★★★★ ULTRA PRECISION

MADE IN USA

Our new 9230E series come with their own unique head shapes specifically designed to meet customers needs!

9230E Series **SL MOLDED Grips** - ESD Safe (10⁸ ohms/sq.) Length 4.25" (106mm)



Small Round/Relieved Head

| Part# | Grip | Cutting Edge | Maximum Cutting Capacity |
|-------|-----------|---------------|--------------------------|
| 9231E | SL Molded | Optimum-Flush | 18 AWG .040" 1.00 mm |
| 9232E | SL Molded | Lazer-Flush | 20 AWG .032" 0.80 mm |

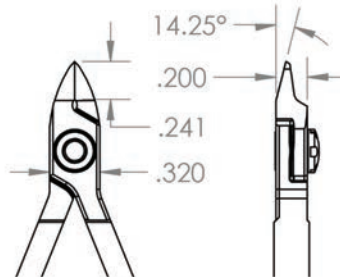

Small Tapered/Relieved Head

| Part# | Grip | Cutting Edge | Maximum Cutting Capacity |
|-------|-----------|--------------|--------------------------|
| 9238E | SL Molded | Lazer-Flush | 22 AWG .025" 0.63 mm |

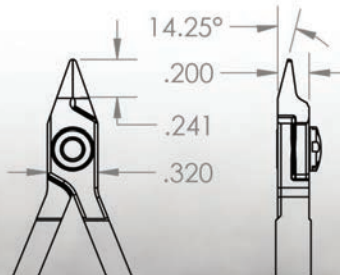

SLIM LINE 9000 SERIES MEDIUM HEAD CUTTERS

MADE IN USA

★★★★ EXTREME PRECISION

Our new 9240SL SLIM LINE series feature a completely new and smaller profile. These tools have a black oxide finish to prevent oxidation and glare.

9240SL Series SL MOLDED Grips - ESD Safe (10⁹ Ohms/Sq.)

Length 4.25" (108mm)



Slim Line Medium Oval Head

NEW ITEM

| Part# | Grip | Cutting Edge | Maximum Cutting Capacity |
|--------|-----------|---------------|--------------------------|
| 9240SL | SL Molded | Semi-flush | 18 AWG .042" 1.05mm |
| 9241SL | SL Molded | Optimum-flush | 18 AWG .040" 1.00 mm |
| 9242SL | SL Molded | Lazer-flush | 20 AWG .032" 0.80 mm |

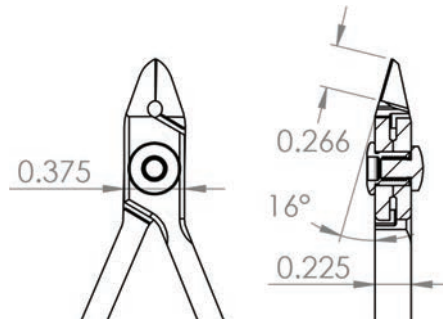

Slim Line Medium Tapered Head

NEW ITEM

| Part# | Grip | Cutting Edge | Maximum Cutting Capacity |
|--------|-----------|---------------|--------------------------|
| 9243SL | SL Molded | Semi-flush | 18 AWG .040" 1.00 mm |
| 9244SL | SL Molded | Optimum-flush | 19 AWG .036" 0.90 mm |
| 9245SL | SL Molded | Lazer-flush | 20 AWG .032" 0.80 mm |

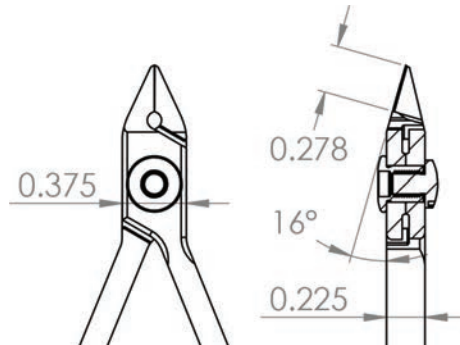

Slim Line Medium Tapered/Relieved Head

NEW ITEM

| Part# | Grip | Cutting Edge | Maximum Cutting Capacity |
|--------|-----------|---------------|--------------------------|
| 9246SL | SL Molded | Semi-flush | 19 AWG .036" 0.90 mm |
| 9247SL | SL Molded | Optimum-flush | 20 AWG .032" 0.80 mm |
| 9248SL | SL Molded | Lazer-flush | 20 AWG .030" 0.75 mm |

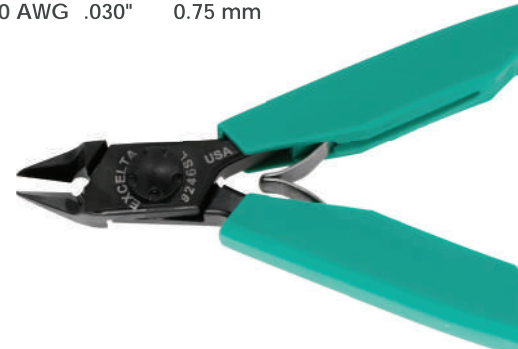
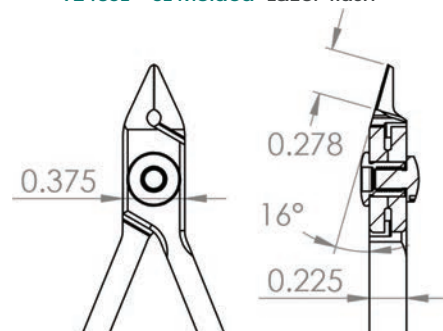

MEDIUM HEAD CUTTERS

9000 SERIES



★★★★★ ULTRA PRECISION

MADE IN USA

9200 Series **STANDARD Cushion Grip** - ESD Safe (10^{10} ohms/sq.)
 9200-GM Series **MOLDED Grip** - ESD Safe (10^9 ohms/sq.)

Length 4.50" (112mm)
 Length 4.75" (119mm)



Medium Oval Head

| Part# | Grip | Cutting Edge | Maximum Cutting Capacity | MADE IN USA |
|----------|----------|---------------|--------------------------|-------------|
| 9240E | Standard | Semi-Flush | 18 AWG .042" 1.05mm | |
| 9241E | Standard | Optimum-Flush | 18 AWG .040" 1.00 mm | |
| 9241E-GM | Molded | Optimum-Flush | 18 AWG .040" 1.00 mm | |
| 9242E | Standard | Lazer-Flush | 20 AWG .032" 0.88mm | |

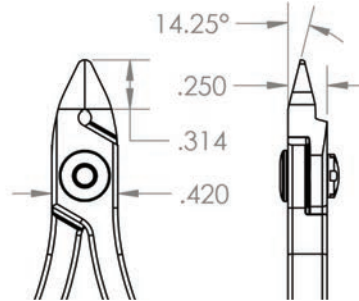

Medium Tapered Head

| Part# | Grip | Cutting Edge | Maximum Cutting Capacity | MADE IN USA |
|----------|----------|---------------|--------------------------|-------------|
| 9243E | Standard | Semi-Flush | 18 AWG .040" 1.00mm | |
| 9244E | Standard | Optimum-Flush | 19 AWG .036" 0.90mm | |
| 9244E-GM | Molded | Optimum-Flush | 19 AWG .036" 0.90mm | |
| 9245E | Standard | Lazer-Flush | 20 AWG .032" 0.88mm | |

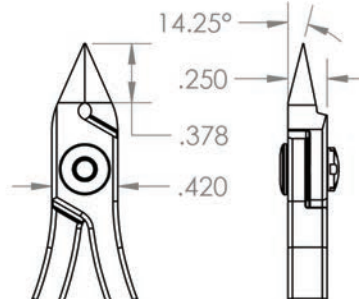

Medium Tapered/Relieved Head

| Part# | Grip | Cutting Edge | Maximum Cutting Capacity | MADE IN USA |
|-------|----------|---------------|--------------------------|-------------|
| 9246E | Standard | Semi-flush | 19 AWG .036" 0.90 mm | |
| 9247E | Standard | Optimum-flush | 20 AWG .032" 0.80 mm | |
| 9248E | Standard | Lazer-flush | 20 AWG .030" 0.75 mm | |

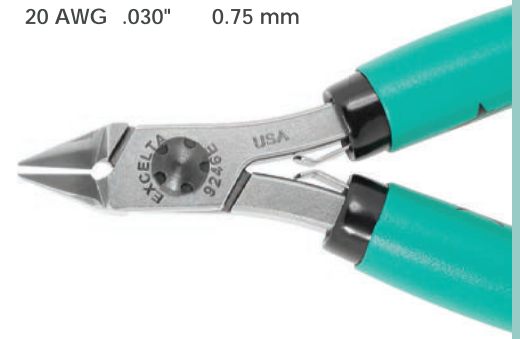
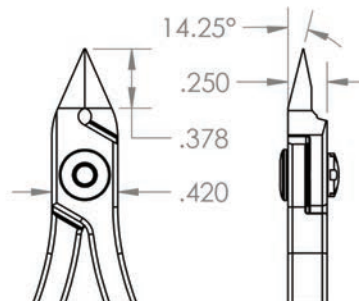

7000 SERIES | MEDIUM HEAD CUTTERS

MADE IN USA

★★★★★ ULTRA PRECISION

7100 Series **LONG Cushion Grip** - ESD Safe (10^{10} ohms/sq.) Length 5.75" (144mm)

7200 Series **MOLDED Grip** - ESD Safe (10^8 ohms/sq.) Length 4.75" (119mm)



Medium Oval Head

| Part# | Grip | Cutting Edge | Maximum Cutting Capacity |
|-------|--------|---------------|--------------------------|
| 7140E | Long | Semi-flush | 16 AWG .050" 1.25 mm |
| 7240E | Molded | Semi-flush | 16 AWG .050" 1.25 mm |
| 7141E | Long | Optimum-flush | 17 AWG .045" 1.13 mm |
| 7241E | Molded | Optimum-flush | 17 AWG .045" 1.13 mm |
| 7142E | Long | Lazer-flush | 18 AWG .042" 1.05 mm |
| 7242E | Molded | Lazer-flush | 18 AWG .042" 1.05 mm |

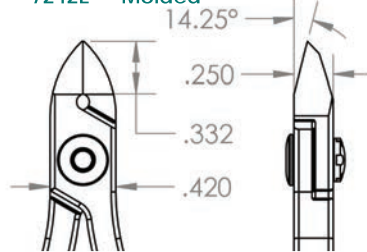

Medium Tapered Head

| Part# | Grip | Cutting Edge | Maximum Cutting Capacity |
|-------|--------|---------------|--------------------------|
| 7143E | Long | Semi-flush | 16 AWG .050" 1.25 mm |
| 7243E | Molded | Semi-flush | 16 AWG .050" 1.25 mm |
| 7144E | Long | Optimum-flush | 17 AWG .045" 1.13 mm |
| 7244E | Molded | Optimum-flush | 17 AWG .045" 1.13 mm |
| 7145E | Long | Lazer-flush | 18 AWG .040" 1.00 mm |
| 7245E | Molded | Lazer-flush | 18 AWG .040" 1.00 mm |

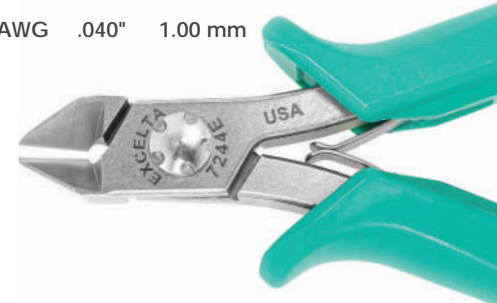
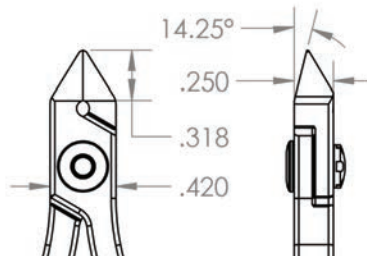

Medium Tapered/Relieved Head

| Part# | Grip | Cutting Edge | Maximum Cutting Capacity |
|-------|--------|---------------|--------------------------|
| 7146E | Long | Semi-flush | 18 AWG .042" 1.05 mm |
| 7246E | Molded | Semi-flush | 18 AWG .042" 1.05 mm |
| 7147E | Long | Optimum-flush | 18 AWG .040" 1.00 mm |
| 7247E | Molded | Optimum-flush | 18 AWG .040" 1.00 mm |
| 7148E | Long | Lazer-flush | 19 AWG .036" 0.90 mm |
| 7248E | Molded | Lazer-flush | 19 AWG .036" 0.90 mm |

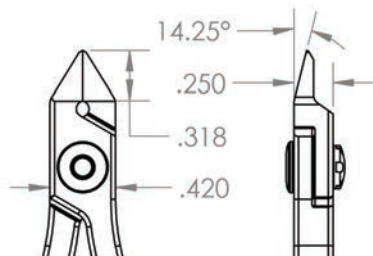

LARGE HEAD CUTTERS

7000 SERIES



★★★★★ ULTRA PRECISION
 ★★★★★ EXTREME PRECISION

7200 Series **MOLDED Grip** - ESD Safe (10⁸ ohms/sq.)



Medium Oval Relieved Head ★★★★★

| Part# | Grip | Length | Cutting Edge | Maximum Cutting Capacity |
|-------|--------|---------------|--------------|--------------------------|
| 7210E | Molded | 4.75" (119mm) | Semi-flush | 16 AWG .050" 1.25 mm |

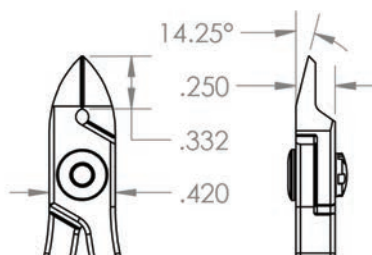

Large Oval Head ★★★★★

| Part# | Grip | Length | Cutting Edge | Maximum Cutting Capacity |
|-------|--------|---------------|---------------|--------------------------|
| 7250E | Molded | 5.00" (125mm) | Semi-Flush | 14 AWG .050" 1.5 mm |
| 7251E | Molded | 5.00" (125mm) | Optimum-Flush | 14 AWG .050" 1.5 mm |

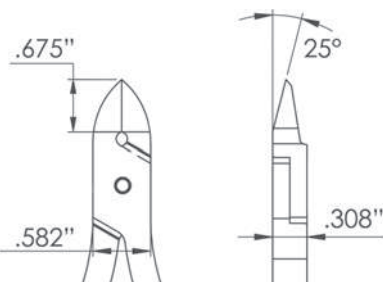

Very Large Oval Head ★★★★★

| Part# | Grip | Length | Cutting Edge | Maximum Cutting Capacity |
|-------|--------|---------------|---------------|--------------------------|
| 7260E | Molded | 5.25" (131mm) | Semi-flush | 12 AWG .080" 2.0 mm |
| 7261E | Molded | 5.25" (131mm) | Optimum-Flush | 12 AWG .080" 2.0 mm |

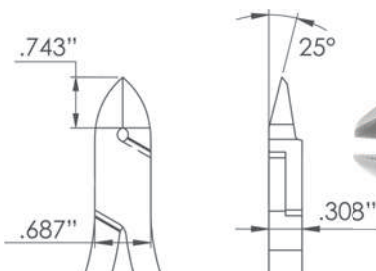

7000 SERIES | TAPERED FINE TIPS

MADE IN USA

★★★★★ ULTRA PRECISION

7100 Series **Long Cushion Grip** - ESD Safe (10^{10} ohms/sq.)

7200 Series **Molded Grip** - ESD Safe (10^8 ohms/sq.)

7300 Series **SL Molded Grip** - ESD Safe (10^8 ohms/sq.)



Smallest Fine Tapered Tips

| Part# | Grip | Length | Cutting Edge | Maximum Cutting Capacity |
|-------|-----------|---------------|--------------|--------------------------|
| 7371E | SL Molded | 4.25" (106mm) | Lazer-Flush | 30 AWG .010" 0.25 mm |

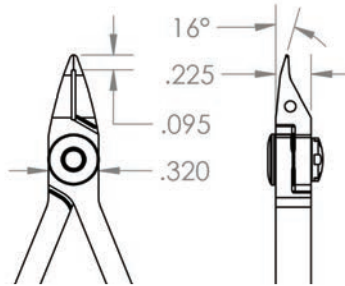

Small Tapered Tips

| Part# | Grip | Length | Cutting Edge | Maximum Cutting Capacity |
|-------|--------|---------------|--------------|--------------------------|
| 7171E | Long | 5.75" (144mm) | Lazer-Flush | 30 AWG .010" 0.25 mm |
| 7271E | Molded | 5.25" (131mm) | Lazer-Flush | 30 AWG .010" 0.25 mm |

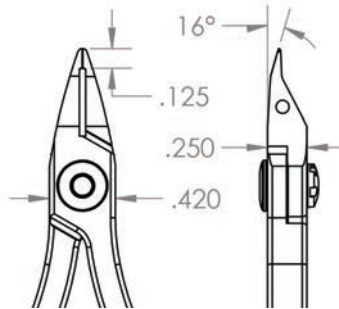

Medium Tapered Tips

| Part# | Grip | Length | Cutting Edge | Maximum Cutting Capacity |
|-------|--------|---------------|--------------|--------------------------|
| 7170E | Long | 6.25" (156mm) | Lazer-Flush | 24 AWG .020" 0.50 mm |
| 7270E | Molded | 4.75" (119mm) | Lazer-Flush | 24 AWG .020" 0.50 mm |

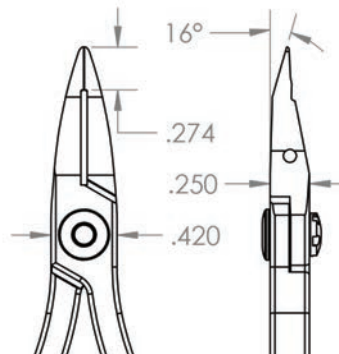

TAPERED/RELIEVED FINE TIPS

7000 SERIES



★★★★★ ULTRA PRECISION

MADE IN USA

7100 Series **Long Cushion Grip** - ESD Safe (10^{10} ohms/sq.)

7200 Series **Molded Grip** - ESD Safe (10^9 ohms/sq.)



Tapered/Relieved Fine Tips

| Part# | Grip | Length | Cutting Edge | Maximum Cutting Capacity |
|--------|--------|---------------|--------------|--------------------------|
| 7170EA | Long | 6.25" (156mm) | Lazer-Flush | 24 AWG .020" 0.50 mm |
| 7270EA | Molded | 5.25" (131mm) | Lazer-Flush | 24 AWG .020" 0.50 mm |

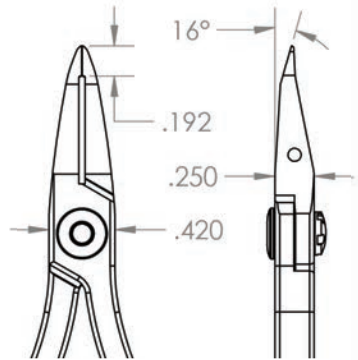

Tapered/Relieved Fine Tips

| Part# | Grip | Length | Cutting Edge | Maximum Cutting Capacity |
|-------|--------|---------------|--------------|--------------------------|
| 7149E | Long | 5.75" (143mm) | Lazer-Flush | 22 AWG .025" 0.63 mm |
| 7249E | Molded | 5.00" (125mm) | Lazer-Flush | 22 AWG .025" 0.63 mm |

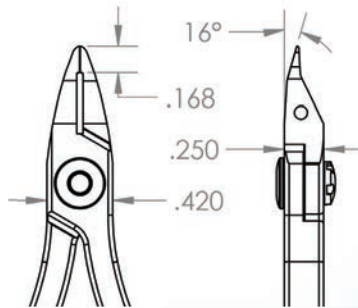

7000 SERIES | ANGULATED CUTTERS

MADE IN USA

★★★★★ ULTRA PRECISION



7300 Series SL Molded Grip - ESD Safe (10⁸ ohms/sq.)

Small Angulated Head

| Part# | Grip | Length | Cutting Edge | Maximum Cutting Capacity |
|-------|-----------|---------------|--------------|--------------------------|
| 7375E | SL Molded | 4.25" (106mm) | Lazer-Flush | 30 AWG .010" 0.25 mm |

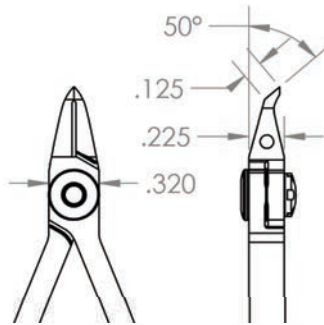

Small Angulated Head

| Part# | Grip | Length | Cutting Edge | Maximum Cutting Capacity |
|-------|-----------|---------------|--------------|--------------------------|
| 7376E | SL Molded | 4.25" (106mm) | Lazer-Flush | 30 AWG .010" 0.25 mm |



NEW ITEM

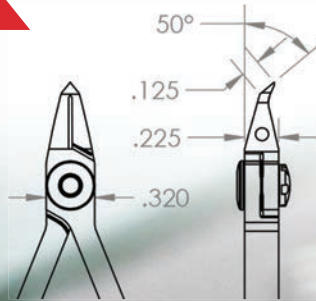

ANGULATED CUTTERS | 7000 SERIES

★★★★★ ULTRA PRECISION

MADE IN USA



7100 Series **Long Cushion Grip** - ESD Safe (10¹⁰ ohms/sq.)

7200 Series **Molded Grip** - ESD Safe (10⁸ ohms/sq.)



Medium Angulated Head

| Part# | Grip | Length | Cutting Edge | Maximum Cutting Capacity |
|-------|--------|---------------|---------------|--------------------------|
| 7175E | Long | 6.00" (150mm) | Optimum-Flush | 25 AWG .018" 0.45 mm |
| 7275E | Molded | 4.75" (119mm) | | |

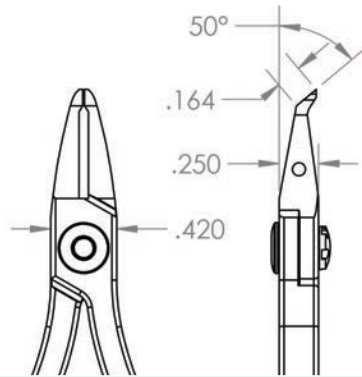

Medium Angulated Head

| Part# | Grip | Length | Cutting Edge | Maximum Cutting Capacity |
|-------|--------|---------------|---------------|--------------------------|
| 7182E | Long | 6.00" (150mm) | Optimum-Flush | 22 AWG .025" 0.63 mm |
| 7282E | Molded | 5.00" (125mm) | | |

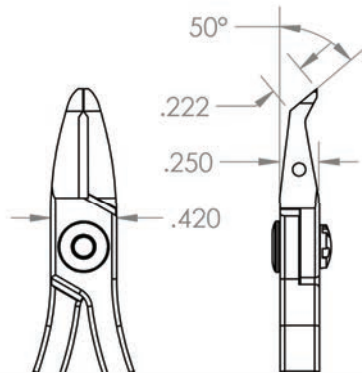

7000 SERIES | ANGULATED CUTTERS

MADE IN USA

★★★★★ ULTRA PRECISION

7100 Series **Long Cushion Grip** - ESD Safe (10^{10} ohms/sq.)

7200 Series **Molded Grip** - ESD Safe (10^8 ohms/sq.)



Large Angulated Head

★★★★★

| Part# | Grip | Length | Cutting Edge | Maximum Cutting Capacity |
|-------|--------|---------------|---------------|--------------------------|
| 7172E | Long | 6.00" (150mm) | Optimum-Flush | 20 AWG .032" 0.80 mm |
| 7272E | Molded | 4.75" (119mm) | | |

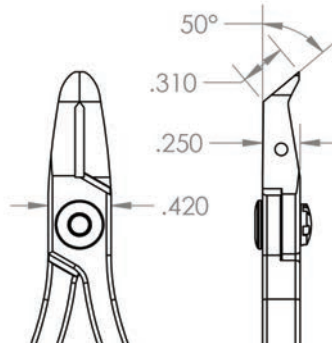

Very Large Angulated Head

★★★★★

| Part# | Grip | Length | Cutting Edge | Maximum Cutting Capacity |
|-------|--------|---------------|---------------|--------------------------|
| 7104E | Long | 6.00" (150mm) | Optimum-Flush | 21 AWG .028" 0.70 mm |
| 7204E | Molded | 5.00" (125mm) | | |

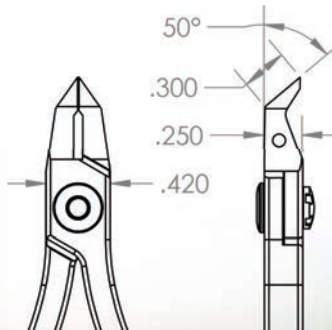

ANGULATED CUTTERS | EI SERIES

★★★ HIGH PRECISION



EI Series **Molded Grip** - ESD Safe (10^8 ohms/sq.)



Very Large Angulated Head ★★★

| Part# | Grip | Length | Cutting Edge | Maximum Cutting Capacity |
|-------|--------|---------------|---------------|--------------------------|
| 90EI | Molded | 4.75" (119mm) | Optimum-Flush | 22 AWG .025" 0.63 mm |

NEW ITEM

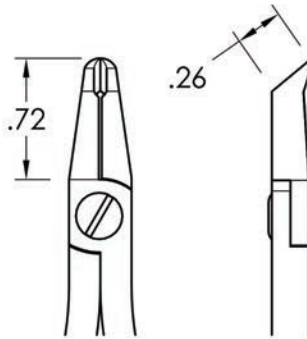

Very Large Angulated Head ★★★

| Part# | Grip | Length | Cutting Edge | Maximum Cutting Capacity |
|-------|--------|---------------|---------------|--------------------------|
| 67EI | Molded | 4.75" (119mm) | Optimum-Flush | 22 AWG .025" 0.63 mm |

NEW ITEM

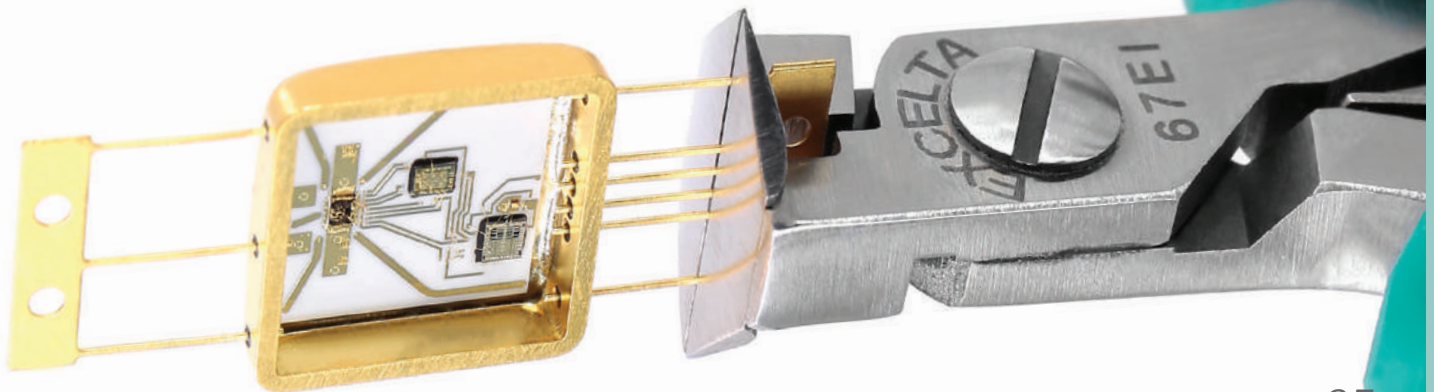
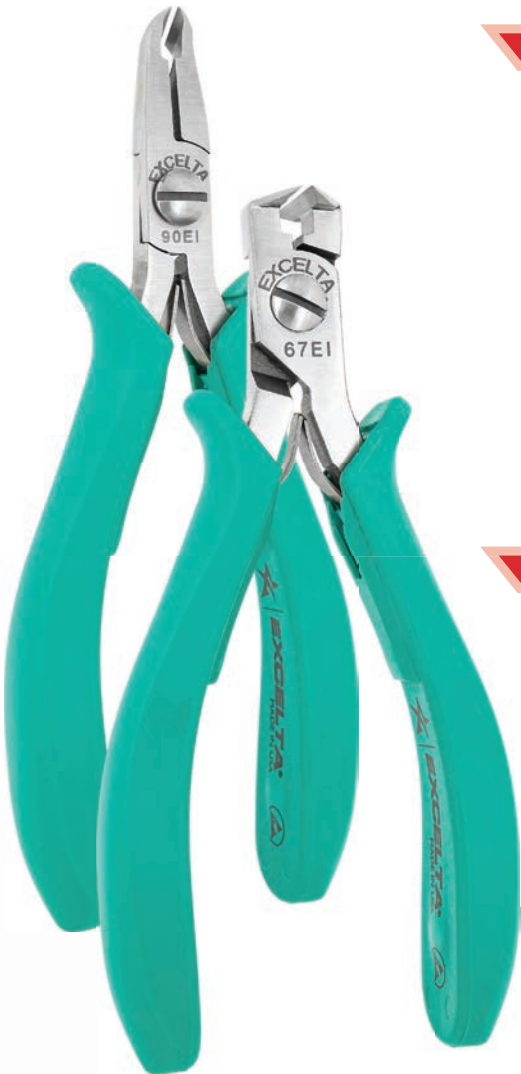
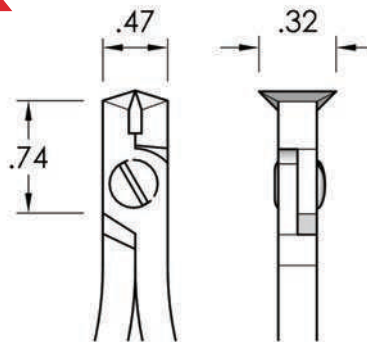

7000/EI SERIES | TRANSVERSE CUTTERS

★★★★★ ULTRA PRECISION
 ★★★★★ HIGH PRECISION

7100 Series Long Cushion Grip - ESD Safe (10¹⁰ ohms/sq.)
 7200 / EI Series Molded Grip - ESD Safe (10⁸ ohms/sq.)



Small Transverse Head

★★★★★

| Part# | Grip | Length | Cutting Edge | Maximum Cutting Capacity |
|-------|--------|---------------|--------------|--------------------------|
| 7174E | Long | 6.00" (150mm) | Lazer-Flush | 24 AWG .020" 0.50 mm |
| 7274E | Molded | 4.75" (119mm) | Lazer-Flush | 24 AWG .020" 0.50 mm |

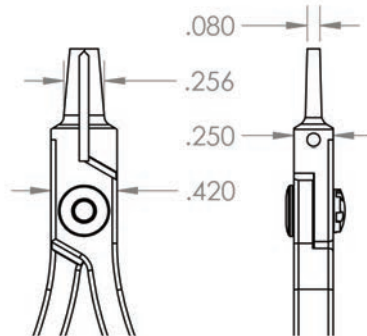

Medium Transverse Head

★★★★★

| Part# | Grip | Length | Cutting Edge | Maximum Cutting Capacity |
|-------|--------|---------------|--------------|--------------------------|
| 7173E | Long | 6.00" (150mm) | Lazer-Flush | 24 AWG .020" 0.50 mm |
| 7273E | Molded | 4.75" (119mm) | Lazer-Flush | 24 AWG .020" 0.50 mm |

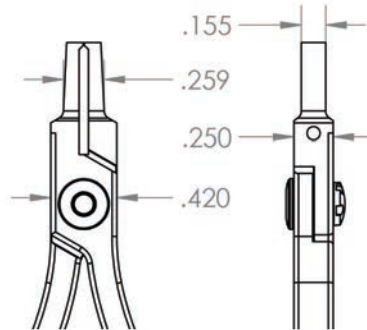

Medium Transverse Head

★★★

| Part# | Grip | Length | Cutting Edge | Maximum Cutting Capacity |
|-------|--------|----------------|--------------|--------------------------|
| 73E-I | Molded | 5.5" (137.5mm) | Lazer-Flush | 22 AWG .025" 0.63 mm |

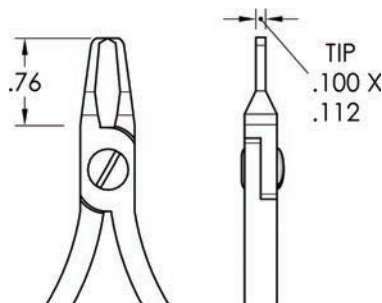

HARD WIRE CUTTERS | 2800 SERIES

★★ FINE PRECISION | TUNGSTEN INSERT



2800 Series **Standard Cushion Grip** - ESD Safe (10¹⁰ ohms/sq.)
 2800 CR Cleanroom Safe - No Grip - Serrated Handles



Small Tapered Head

| Part# | Grip | Length | Cutting Edge | Maximum Cutting Capacity |
|---------|----------|---------------|--------------|-------------------------------------|
| 2876EHT | Standard | 4.25" (106mm) | Semi-Flush | 30 AWG .010" 0.25 mm (Hard Wire) |

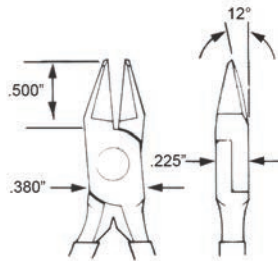

Small Round Head

| Part# | Grip | Length | Cutting Edge | Maximum Cutting Capacity |
|------------|----------|---------------|--------------|-------------------------------------|
| 2899EHT | Standard | 4.50" (112mm) | Semi-Flush | 28 AWG .012" 0.30 mm |
| 2899EHT-CR | No Grip | 4.50" (112mm) | Semi-Flush | 28 AWG .012" 0.30 mm (Hard Wire) |

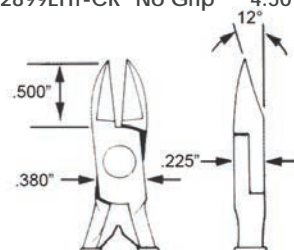

Medium Round Head

| Part# | Grip | Length | Cutting Edge | Maximum Cutting Capacity |
|---------|----------|---------------|--------------|-------------------------------------|
| 2897EHT | Standard | 4.50" (112mm) | Semi-Flush | 24 AWG .020" 0.50 mm (Hard Wire) |

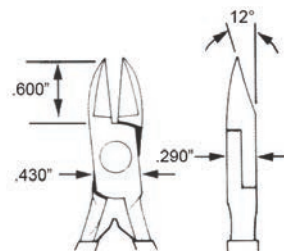

Large Round Head

| Part# | Grip | Length | Cutting Edge | Maximum Cutting Capacity |
|---------|----------|--------------|--------------|-------------------------------------|
| 2896EHT | Standard | 5.5" (137mm) | Semi-Flush | 20 AWG .032" 0.80 mm (Hard Wire) |

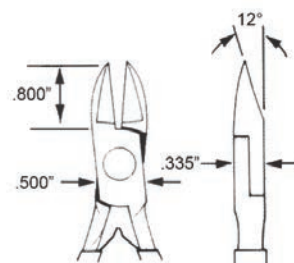

STANDOFF SHEAR CUTTERS

★★★★★ ULTRA PRECISION

SHEAR CUTTERS

Application specific shear cutters are used to shear off leads on printed circuit boards and leave a specific length of the lead protruding. There are a variety of options shown and all can be modified to your exact specifications.



STANDOFF SHEAR CUTTERS

500 SERIES



ULTRA PRECISION

MADE IN USA

500 Series **Molded Grip** - Surface Resistivity 10^8 ohms/sq.
 500L Series **Long Cushion Grip** - ESD Safe (10^{10} ohms/sq.)



Relieved Fine Tips

Length 5" (125mm)

| Part# | Grip | Maximum Cutting Capacity |
|----------|--------|--------------------------|
| 530EA-US | Molded | 22 AWG .025" 0.63 mm |

Please specify cut length when ordering (0.30", 0.40", 0.50", 0.60", or 'CUSTOM'). Example: 530EA-US-030

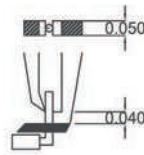

Medium Fine Tips

Length 6" (150mm)

| Part# | Grip | Maximum Cutting Capacity |
|------------|------|--------------------------|
| 530E-5-USL | Long | 22 AWG .025" 0.63 mm |

Please specify cut length when ordering (0.30", 0.40", 0.50", 0.60", or 'CUSTOM'). Example: 530E-5-USL-040

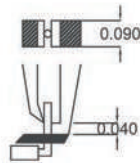

Smallest Fine Tips

Length 5" (125mm)

| Part# | Grip | Maximum Cutting Capacity |
|---------|--------|--------------------------|
| 530E-US | Molded | 22 AWG .025" 0.63 mm |

Please specify cut length when ordering (0.30", 0.40", 0.50", 0.60", or 'CUSTOM'). Example: 530E-US-040

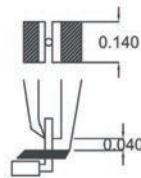

Small Fine Tips - Adjustable

Length 6" (150mm)

| Part# | Grip | Maximum Cutting Capacity |
|------------|--------|--------------------------|
| 530E-15-US | Molded | 22 AWG .025" 0.63 mm |

Replacement Slide 530E-15-US-RSS

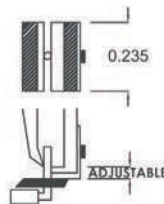

500/900 SERIES

STANDOFF SHEAR CUTTERS

MADE IN USA

★★★★★ ULTRA PRECISION

500 Series **Molded Grip** - Surface Resistivity 10^8 ohms/sq.
 900 Series **Cushion Grip** - Surface Resistivity 10^{10} ohms/sq.



Long Head

Length 5.75" (144mm)

| Part# | Grip | Maximum Cutting Capacity |
|-----------|--------|--------------------------|
| 530E-4-US | Molded | 22 AWG .025" 0.63 mm |

Please specify cut length when ordering (.030", .040", .050", .060", or 'CUSTOM'). Example: 530E-4-US-040

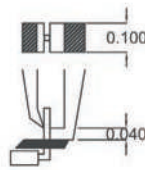

Thin Head

Length 6" (150mm)

| Part# | Grip | Maximum Cutting Capacity |
|-------|---------|--------------------------|
| 907-4 | Cushion | 20 AWG .032" 0.80mm |

Please specify cut length when ordering (.030", .040", .050", .060", or 'CUSTOM'). Example: 907-4-040

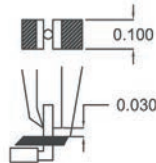

Large Head

Length 6" (150mm)

| Part# | Grip | Maximum Cutting Capacity |
|-------|---------|--------------------------|
| 907-1 | Cushion | 22 AWG .025" 0.63 mm |

Please specify cut length when ordering (.030", .040", .050", .060", or 'CUSTOM'). Example: 907-1-040

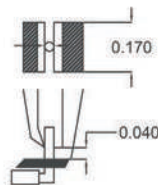

STANDOFF SHEAR CUTTERS | 900 SERIES

★★★★★ ULTRA PRECISION | MADE IN USA



900 Series Cushion Grip - Surface Resistivity 10^{10} ohms/sq.



Grooved Head

Length 5.25" (131mm)

| Part# | Grip | Maximum Cutting Capacity |
|-------|------|--------------------------|
|-------|------|--------------------------|

| | | |
|-------|---------|----------------------|
| 907-5 | Cushion | 22 AWG .025" 0.63 mm |
|-------|---------|----------------------|

Please specify cut length when ordering (0.30", 0.40", 0.50", 0.60", or 'CUSTOM'). Example: 907-5-040

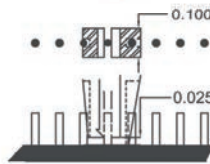

Large Head

Length 5.5" (138mm)

| Part# | Grip | Maximum Cutting Capacity |
|-------|------|--------------------------|
|-------|------|--------------------------|

| | | |
|-----|---------|----------------------|
| 903 | Cushion | 18 AWG .040" 1.00 mm |
|-----|---------|----------------------|

Please specify cut length when ordering (0.30", 0.40", 0.50", 0.60", or 'CUSTOM'). Example: 903-040

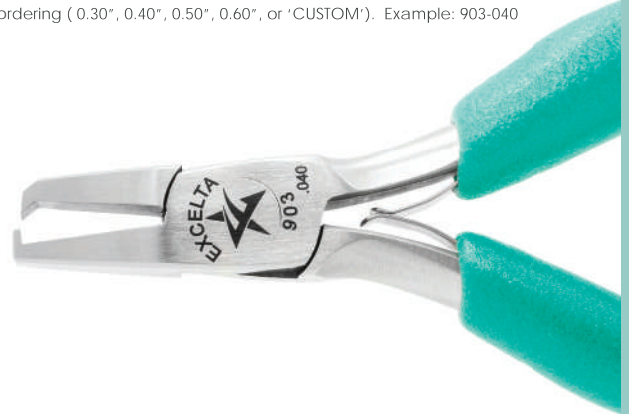
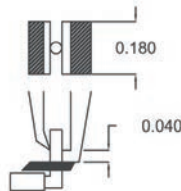

Large Narrow Head

Length 5.5" (138mm)

| Part# | Grip | Maximum Cutting Capacity |
|-------|------|--------------------------|
|-------|------|--------------------------|

| | | |
|------|---------|----------------------|
| 903A | Cushion | 18 AWG .040" 1.00 mm |
|------|---------|----------------------|

Please specify cut length when ordering (0.30", 0.40", 0.50", 0.60", or 'CUSTOM'). Example: 903A-040

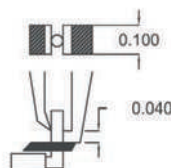

500/900 SERIES

STANDOFF SHEAR CUTTERS

MADE IN USA

★★★★★ ULTRA PRECISION

500 Series **Molded Grip** - Surface Resistivity 10⁸ ohms/sq.
 900 Series **Cushion Grip** - Surface Resistivity 10¹⁰ ohms/sq.



Small Angled Head

Length 5.5" (138mm)

Part# Grip Maximum Cutting Capacity

549E-US Molded 22 AWG .025" 0.63 mm

Please specify cut length when ordering (0.30", 0.40", 0.50", 0.60", or 'CUSTOM'). Example: 549E-US-040

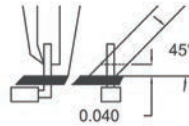

Large Angled Head

Length 5.75" (144mm)

Part# Grip Maximum Cutting Capacity

907-59 Cushion 18 AWG .040" 1.00 mm

Please specify cut length when ordering (0.30", 0.40", 0.50", 0.60", or 'CUSTOM'). Example: 907-59-040

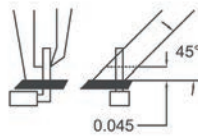

Very Large Head

Length 5.25" (131mm)

Part# Grip Maximum Cutting Capacity

509-42A-US Molded 22 AWG .025" 0.63 mm

Please specify cut length when ordering (0.30", 0.40", 0.50", 0.60", or 'CUSTOM'). Example: 509-42A-US-040

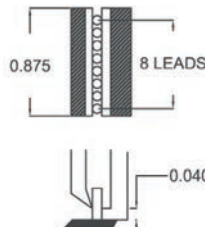

Very Large Head

Length 5.5" (138mm)

Part# Grip Maximum Cutting Capacity

907-42A Cushion 24 AWG .020" 0.50 mm

Please specify cut length when ordering (0.30", 0.40", 0.50", 0.60", or 'CUSTOM'). Example: 907-42A-040

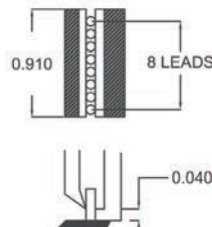

SHEAR CUTTER | CABLE CUTTER

★★★ FINE PRECISION | DEPANELIZER



Cushion Grip - Surface Resistivity 10^{10} ohms/sq.



51I-6 - Cable Cutter

Precision cable cutter is recommended for cutting stranded soft cables and wire up to .5" (12.5mm) in diameter. The locking device keeps cutting jaws in closed position when not in use. The tool is 6" (150mm) long and made of Stainless Steel.

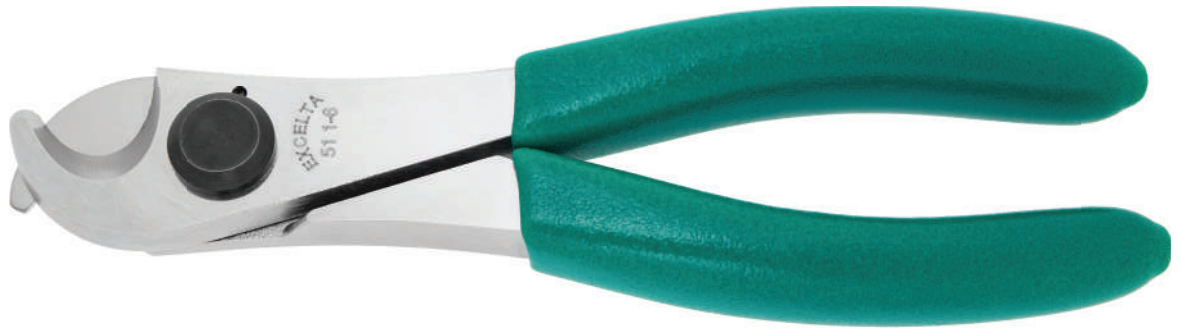

51I-6DP - Depanelizer

Depanelizing tool has a thin jaw designed to cut the tabs on PC boards. Longer handles provide more leverage when cutting. The head is designed to fit a .07" (1.75mm) or larger slot, is 6" (150mm) long and made of Stainless Steel it features a locking device which keeps cutting jaws closed at rest.





EXCELTA[®]
PRECISION PLIERS

PRECISION PLIERS

Excelta makes a wide range of pliers for general electronics repair and fine mechanical work. Precision lap joints ensure precise jaw alignment. ESD safe grips and available ergonomic handles make finding the exact plier you need easier than ever.



★★★★★ ULTRA PRECISION
 ★★★ HIGH PRECISION
 ★★ FINE PRECISION

Plier Nose Shape



Chain Nose



Needle Nose



Bent Nose



Flat Nose



Round Nose

The Size

Miniature Pliers are self-opening and have the smallest tips. They are made of stainless steel to prevent oxidation, are cleanroom safe and the overall length is 3" (75mm).

Small Pliers feature dual leaf springs and soft cushion ESD safe (10^{10} ohms/sq) grips. They are made of stainless steel to prevent oxidation and are 4.75" (120mm) in overall length.

Small Ergonomic Pliers feature dual leaf springs and soft cushion ESD safe (10^{10} ohms/sq) grips. They are made of stainless steel to prevent oxidation and are 6" (150mm) in overall length.

Medium Pliers are offered in three different precision levels:

- ★★★★★ The **700 series** features ESD safe (10^9 ohms/sq) molded grips, polished and hand-finished jaws and are made in the USA of carbon steel with flame hardened tips. The overall length is 5" (125mm).
- ★★★ The **11 series** features cushion ESD safe (10^{10} ohms/sq) grips and dual leaf springs, made of stainless steel with flame hardened tips. The overall length is 4.8" (120mm).
- ★★ The **2800 series** feature molded ESD Safe (10^9 ohms/sq) grips and dual leaf springs, and made of stainless steel. The overall length is 5.75" (145mm). The 2800L series are 6" (150mm) in overall length and feature cushioned ESD safe grips (10^{10} ohms/sq) and dual leaf springs.

Large Pliers

- ★★ The **2900 series** Large Pliers all feature dual leaf springs and soft cushion ESD safe (10^{10} ohms/sq) grips. They are made of stainless steel. The overall length is 6.5" (165mm).

Tip Modifications

- D** **Single Cut Serrations** can be added to the inside jaws of most plier tips. Serrations help hold parts when handling and manipulating. Example: 2949D
- DX** **Double Cut Serrations** can be added to the inside jaws of most pliers. These serrations are finer and should be used when handling small parts and wires. Example: 2949DX

Specialty Pliers

Soft Tip Replaceable Jaw Pliers - Soft tips are used for straightening wire or leads without nicking or scratching the lead.

Wide Jaw Pliers - Have very wide jaws for straightening, picking, & placing wide items. The jaws are replaceable.

Concave/Convex Pliers - Feature one concave jaw and one round jaw for bending/forming wires or leads.

MINIATURE | STAINLESS STEEL

Self-Opening Pliers

★ ★ FINE PRECISION

These miniature pliers are ideal for handling small items too large to handle with tweezers, but too small to handle with conventional pliers. They are open at rest and cleanroom safe.



Miniature Chain Nose

Length 3" (75mm)

| Part# | Jaw Finish |
|-------|------------|
| 382 | Smooth |



Miniature Needle Nose

Length 3" (75mm)

| Part# | Jaw Finish |
|-------|------------|
| 383 | Smooth |



Miniature Curved Nose

Length 3" (75mm)

| Part# | Jaw Finish |
|-------|------------|
| 381 | Smooth |



Miniature Bent Nose

Length 3" (75mm)

| Part# | Jaw Finish |
|-------|------------|
| 384 | Smooth |



Miniature Round Nose

Length 3" (75mm)

| Part# | Jaw Finish |
|-------|------------|
| 386 | Smooth |



Miniature Flat Nose

Length 3" (75mm)

| Part# | Jaw Finish |
|-------|------------|
| 385 | Smooth |



STAINLESS STEEL | SMALL HEAD

★★ FINE PRECISION PLIERS



2600 Series Standard Cushion Grip - Surface Resistivity - 10^{10} ohms/sq



Small Chain Nose

Length 4.75" (119mm)

| Part# | Grip | Jaw Finish |
|-------|----------|------------|
| 2644 | Standard | Smooth |
| 2644D | Standard | Serrated |

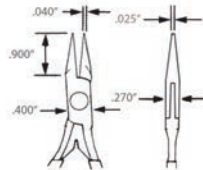

Small Needle Nose

Length 4.75" (119mm)

| Part# | Grip | Jaw Finish |
|-------|----------|------------|
| 2647 | Standard | Smooth |
| 2647D | Standard | Serrated |

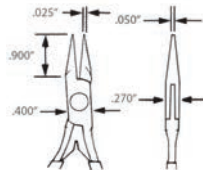

Small Bent Nose

Length 4.75" (119mm)

| Part# | Grip | Jaw Finish |
|-------|----------|------------|
| 2629 | Standard | Smooth |

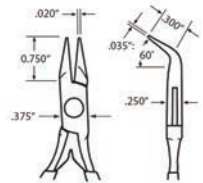

Small Flat Nose

Length 4.75" (119mm)

| Part# | Grip | Jaw Finish |
|-------|----------|------------|
| 2642 | Standard | Smooth |

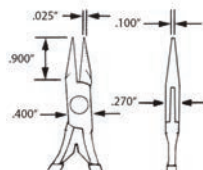

Small Round Nose

Length 4.75" (119mm)

| Part# | Grip | Jaw Finish |
|-------|----------|------------|
| 2643 | Standard | Smooth |

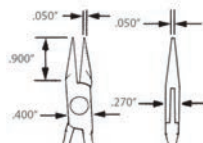

SMALL HEAD | STAINLESS STEEL

ERGONOMIC GRIP PLIERS

★★★ FINE PRECISION

2600S Series Long Cushion Grip - Surface Resistivity 10¹⁰ ohms/sq



Small Chain Nose

Length 6.25" (156mm)

| Part# | Grip | Jaw Finish |
|--------|------|------------|
| 2644S | Long | Smooth |
| 2644SD | Long | Serrated |

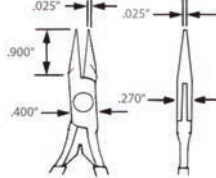

Small Needle Nose

Length 6.25" (156mm)

| Part# | Grip | Jaw Finish |
|--------|------|------------|
| 2647S | Long | Smooth |
| 2647SD | Long | Serrated |

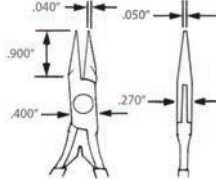

Small Bent Nose

Length 6.25" (156mm)

| Part# | Grip | Jaw Finish |
|--------|------|------------|
| 2629S | Long | Smooth |
| 2629SD | Long | Serrated |

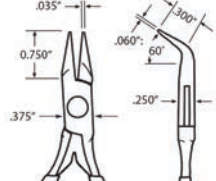

Small Flat Nose

Length 6.25" (156mm)

| Part# | Grip | Jaw Finish |
|--------|------|------------|
| 2642S | Long | Smooth |
| 2642SD | Long | Serrated |

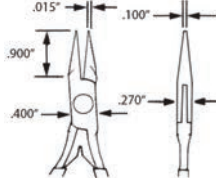

Small Round Nose

Length 6.25" (156mm)

| Part# | Grip | Jaw Finish |
|-------|------|------------|
| 2643S | Long | Smooth |

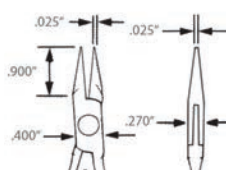

STAINLESS STEEL

SMALL HEAD



HIGH PRECISION

PLIERS

Molded Grip - Surface Resistivity 10⁸ ohms/sq



Small Chain Nose

Length 5.5" (137.5mm)

| Part# | Grip | Jaw Finish |
|-------|--------|------------|
| 441 | Molded | Smooth |

NEW ITEM

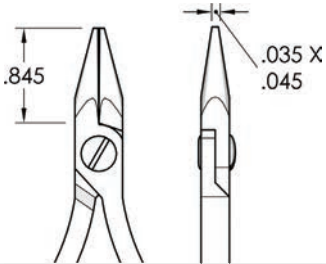

Small Needle Nose

Length 5.5" (137.5mm)

| Part# | Grip | Jaw Finish |
|-------|--------|------------|
| 471 | Molded | Smooth |

NEW ITEM

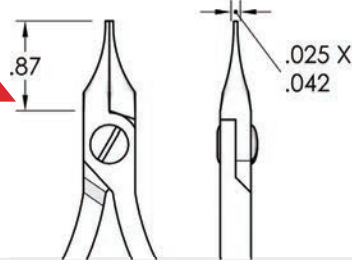

Small Flat Nose

Length 5.5" (137.5mm)

| Part# | Grip | Jaw Finish |
|-------|--------|------------|
| 421 | Molded | Smooth |

NEW ITEM

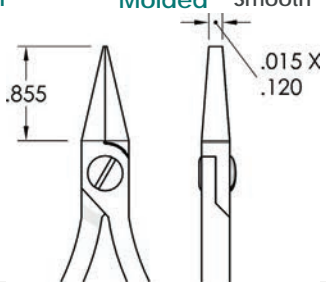

Small Round Nose

Length 5.5" (137.5mm)

| Part# | Grip | Jaw Finish |
|-------|--------|------------|
| 431 | Molded | Smooth |

NEW ITEM

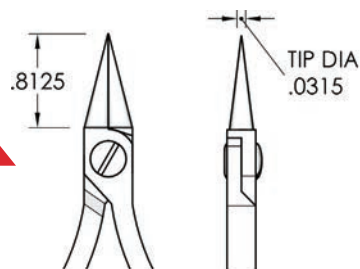

MEDIUM HEAD | STAINLESS/CARBON STEEL

Standard Pliers

★★★★★ ULTRA PRECISION
 ★★★★★ HIGH PRECISION

743 & 744 - Molded Grip - Surface Resistivity - 10^8 ohms/sq
 111 & 11DI - Cushion Grip - Surface Resistivity 10^{10} ohms/sq



Medium Chain Nose ★★★★★ Length 5" (125mm)

| Part# | Grip | Jaw Finish | Material |
|-------|--------|------------|--------------|
| 744 | Molded | Smooth | Carbon Steel |

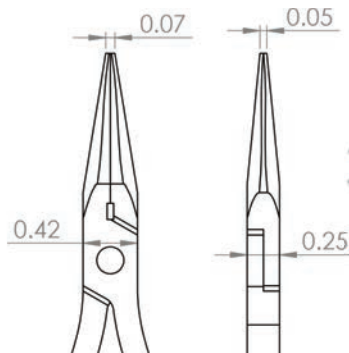

Medium Round Nose ★★★★★ Length 5" (125mm)

| Part# | Grip | Jaw Finish | Material |
|-------|--------|------------|--------------|
| 743 | Molded | Smooth | Carbon Steel |

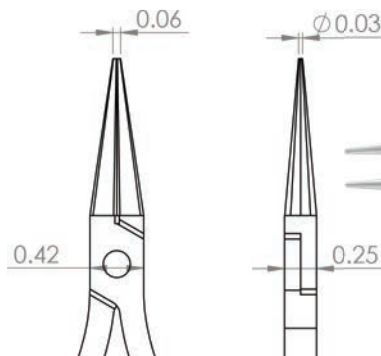

Medium Chain Nose ★★★ Length 4.8" (120mm)

| Part# | Grip | Jaw Finish | Material |
|-------|---------|------------|-----------------|
| 11DI | Cushion | Serrated | Stainless Steel |
| 11I | Cushion | Smooth | Stainless Steel |

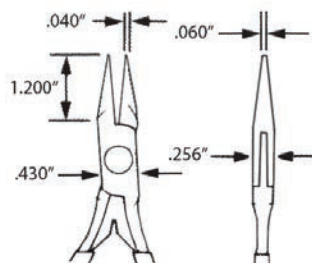

STAINLESS STEEL | MEDIUM HEAD

★★ FINE PRECISION

STANDARD PLIERS



2800 Series Molded Grip - Surface Resistivity 10^9 ohms/sq

2800L Series Long Cushion Grip - Surface Resistivity 10^{10} ohms/sq

2800SL Series SL Molded Grip - ESD Safe (10^8 ohms/sq.)



Medium Chain Nose

| Part# | Grip | Jaw Finish | Length |
|---------|-----------|------------|---------------|
| 2844 | Molded | Smooth | 5.75" (144mm) |
| 2844D | Molded | Serrated | 5.75" (144mm) |
| 2844L | Long | Smooth | 6.25" (156mm) |
| 2844LD | Long | Serrated | 6.25" (156mm) |
| 2844SL | SL Molded | Smooth | 5.25" (133mm) |
| 2844SLD | SL Molded | Serrated | 5.25" (133mm) |

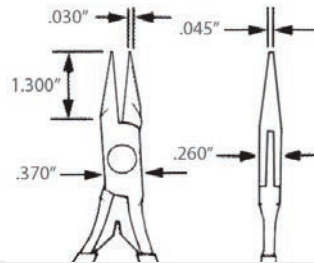

Medium Needle Nose

| Part# | Grip | Jaw Finish | Length |
|---------|-----------|------------|---------------|
| 2847 | Molded | Smooth | 5.75" (144mm) |
| 2847D | Molded | Serrated | 5.75" (144mm) |
| 2847L | Long | Smooth | 6.25" (156mm) |
| 2847LD | Long | Serrated | 6.25" (156mm) |
| 2847SL | SL Molded | Smooth | 5.25" (133mm) |
| 2847SLD | SL Molded | Serrated | 5.25" (133mm) |

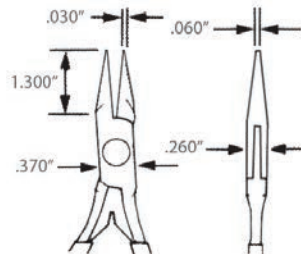

Medium Bent Nose

| Part# | Grip | Jaw Finish | Length |
|---------|-----------|------------|---------------|
| 2829 | Molded | Smooth | 5.75" (144mm) |
| 2829L | Long | Smooth | 6" (150mm) |
| 2829LD | Long | Serrated | 6" (150mm) |
| 2829SL | SL Molded | Smooth | 5.25" (133mm) |
| 2829SLD | SL Molded | Serrated | 5.25" (133mm) |

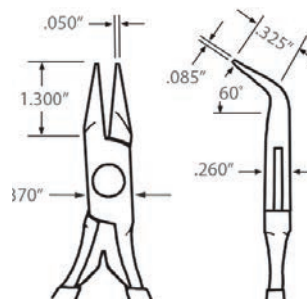

MEDIUM HEAD | STAINLESS STEEL

STANDARD PLIERS ★★ FINE PRECISION

2800 Series **Molded Grip** - Surface Resistivity 10^8 ohms/sq
 2800L Series **Long Cushion Grip** - Surface Resistivity 10^{10} ohms/sq
 2800SL Series **SL Molded Grip** - ESD Safe (10^8 ohms/sq.)



Medium Flat Nose

| Part# | Grip | Jaw Finish | Length |
|-------|--------|------------|---------------|
| 2842 | Molded | Smooth | 5.75" (144mm) |
| 2842D | Molded | Serrated | 5.75" (144mm) |
| 2842L | Long | Smooth | 6.25" (156mm) |

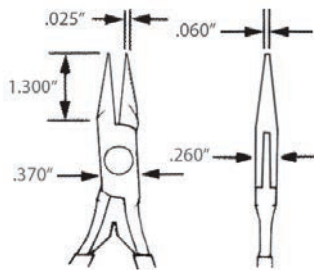

Medium Flat Nose

| Part# | Grip | Jaw Finish | Length |
|-------|--------|------------|---------------|
| 2818 | Molded | Smooth | 5.75" (144mm) |

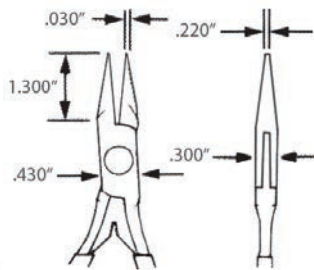

Medium Round Nose

| Part# | Grip | Jaw Finish | Length |
|--------|-----------|------------|---------------|
| 2843 | Molded | Smooth | 5.75" (144mm) |
| 2843L | Long | Smooth | 6.25" (156mm) |
| 2843SL | SL Molded | Smooth | 5.50" (156mm) |

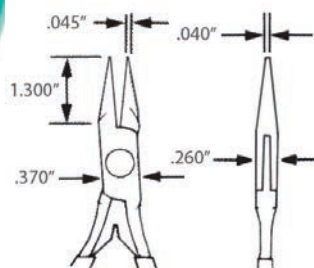

STAINLESS STEEL | LARGE HEAD

★★ FINE PRECISION | STANDARD PLIERS



2900 Series Cushion Grip - Surface Resistivity 10^{10} ohms/sq



Large Chain Nose

Length 6.25" (156mm)

| Part# | Grip | Jaw Finish |
|-------|---------|------------|
| 2949 | Cushion | Smooth |

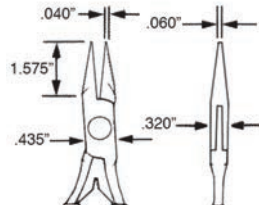

Large Needle Nose

Length 6.5" (163mm)

| Part# | Grip | Jaw Finish |
|-------|---------|------------|
| 2910 | Cushion | Smooth |

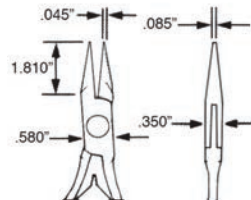

Large Needle Nose

Length 5.75" (144mm)

| Part# | Grip | Jaw Finish |
|-------|---------|------------|
| 2905 | Cushion | Smooth |

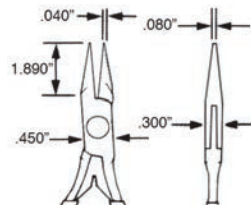

Large 90° Bent Nose

Length 5.75" (144mm)

| Part# | Grip | Jaw Finish |
|-------|---------|------------|
| 2904 | Cushion | Smooth |

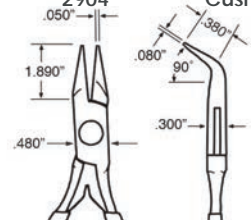

Large 45° Bent Nose

Length 6.5" (163mm)

| Part# | Grip | Jaw Finish |
|-------|---------|------------|
| 2914 | Cushion | Smooth |

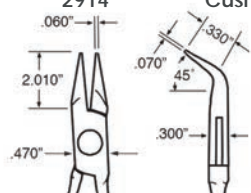

CLEANROOM | STAINLESS STEEL

STANDARD PLIERS ★★ FINE PRECISION

Corrosion-resistant stainless steel can be autoclaved up to 600° F.



Medium Chain Nose ★★

Length 5.75" (144mm)

| Part# | Jaw Finish |
|----------|------------|
| 2844-CR | Smooth |
| 2844D-CR | Serrated |

NEW ITEM

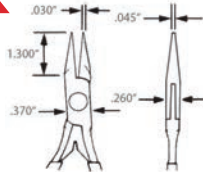

Medium Needle Nose ★★

Length 5.75" (144mm)

| Part# | Jaw Finish |
|----------|------------|
| 2847-CR | Smooth |
| 2847D-CR | Serrated |

NEW ITEM

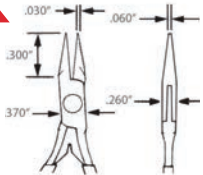

Medium Bent Nose ★★

Length 5.75" (144mm)

| Part# | Jaw Finish |
|----------|------------|
| 2829-CR | Smooth |
| 2829D-CR | Serrated |

NEW ITEM

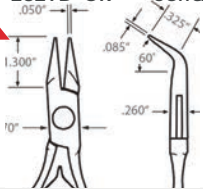

Medium Flat Nose ★★

Length 5.75" (144mm)

| Part# | Jaw Finish |
|----------|------------|
| 2842-CR | Smooth |
| 2842D-CR | Serrated |

NEW ITEM

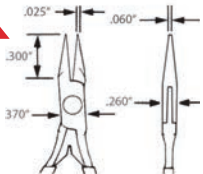

Medium Round Nose ★★

Length 5.75" (144mm)

| Part# | Jaw Finish |
|---------|------------|
| 2843-CR | Smooth |

NEW ITEM

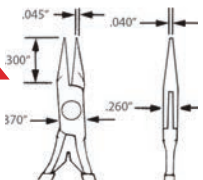

CARBON STEEL

SPECIALTY

★★★★★ ULTRA PRECISION

SOFT TIP PLIERS
REPLACEABLE JAWS



500 Series **Molded Grip** - Surface Resistivity 10⁸ ohms/sq



Medium Round Blunt Nose

Length 5.75" (144mm)

| Part# | Grip | Jaw Material |
|---------|--------|--------------|
| 531-US | Molded | Nylon |
| 531A-US | Molded | Acetal |
| 531B-US | Molded | Brass |



Medium Square Blunt Nose

Length 5.75" (144mm)

| Part# | Grip | Jaw Material |
|---------|--------|--------------|
| 532-US | Molded | Acetal |
| 532B-US | Molded | Brass |



Medium Flat/Round Nose

Length 6" (150mm)

| Part# | Grip | Jaw Material |
|--------|--------|--------------|
| 533-US | Molded | Steel/Acetal |



SPECIALTY CARBON STEEL

WIDE JAW PLIERS
CONCAVE/CONVEX

★★★★★ ULTRA PRECISION

500 Series **Molded Grip** - Surface Resistivity 10⁸ ohms/sq



Medium Wide Nose

| Part# | Grip | Jaw Material | Length |
|---------|--------|--------------|---------------|
| 508-US | Molded | Carbon Steel | 6.25" (156mm) |
| 508B-US | Molded | Brass | 5.5" (138mm) |
| 508D-US | Molded | Acetal | 5.5" (138mm) |



Medium Wide Nose

Length 5.5" (138mm)

| Part# | Grip | Jaw Material |
|---------|--------|--------------|
| 508C-US | Molded | Carbon Steel |



Small Concave/Convex Nose

Length 5.25" (131mm)

| Part# | Grip | Jaw Material |
|------------|--------|--------------|
| 500-101-US | Molded | Carbon Steel |



Medium Concave/Convex Nose

Length 5.5" (138mm)

| Part# | Grip | Jaw Material |
|-------------|--------|--------------|
| 500-101A-US | Molded | Carbon Steel |



STAINLESS STEEL

★ ★ ★ HIGH PRECISION
★ ★ FINE PRECISION

SPECIALTY

TUBING CUTTERS
EXPANDERS



2900 Series **Cushion Grip** - Surface Resistivity 10^{10} ohms/sq

2900 Series ★★ Tubing Cutters (Replaceable Blade)

Length 5.25" (131mm)

These tubing cutters give a nice clean square cut to a variety of soft tubing materials for inserting fittings, couplings and quick release valves. The stainless steel blades are replaceable and come with soft cushioned ESD safe grips (10^{10} ohms/sq). They will cut most types of medical tubing including silicone, rubber, vinyl, nylon, polyurethane, polypropylene, polyethylened, Tygon®, Bio-Sik®, Autoprene® and Viton®. Replacement Blade 2922-14-X.

| Part# | O.D. Tubing |  ESD SAFE |
|---------|---------------|---|
| 2922-18 | .13" (3.25mm) | |
| 2922-14 | .25" (6.25mm) | |
| 2922-38 | .38" (9.5mm) | |



51-T ★★★ Tubing Cutter

Length 7" (175mm)

These tubing cutters are stainless steel and offer a smooth clean shear cut on plastic tubing. The cutting capacity is .38" (9.5mm) and they feature an ergonomic plastic molded handle with a locking feature to keep the jaws closed while idle.



379 SERIES ★★ Tubing Expanders

Length 5" (125mm)

These stainless steel reverse action pliers have been specifically designed to expand the end of flexible tubing for inserting into plastic or metal fittings and connectors. As the handles are squeezed, the tips separate.

| Part# | Tube I.D. | Expanded I.D. |
|-------|---------------|---------------|
| 379A | .13" (3.25mm) | .19" (4.75mm) |
| 379B | .10" (2.50mm) | .13" (3.25mm) |
| 379C | .07" (1.75mm) | .10" (2.50mm) |





EXCELTA[®]
CUSTOM DESIGN SPECIALS

CUSTOM DESIGN SPECIALS

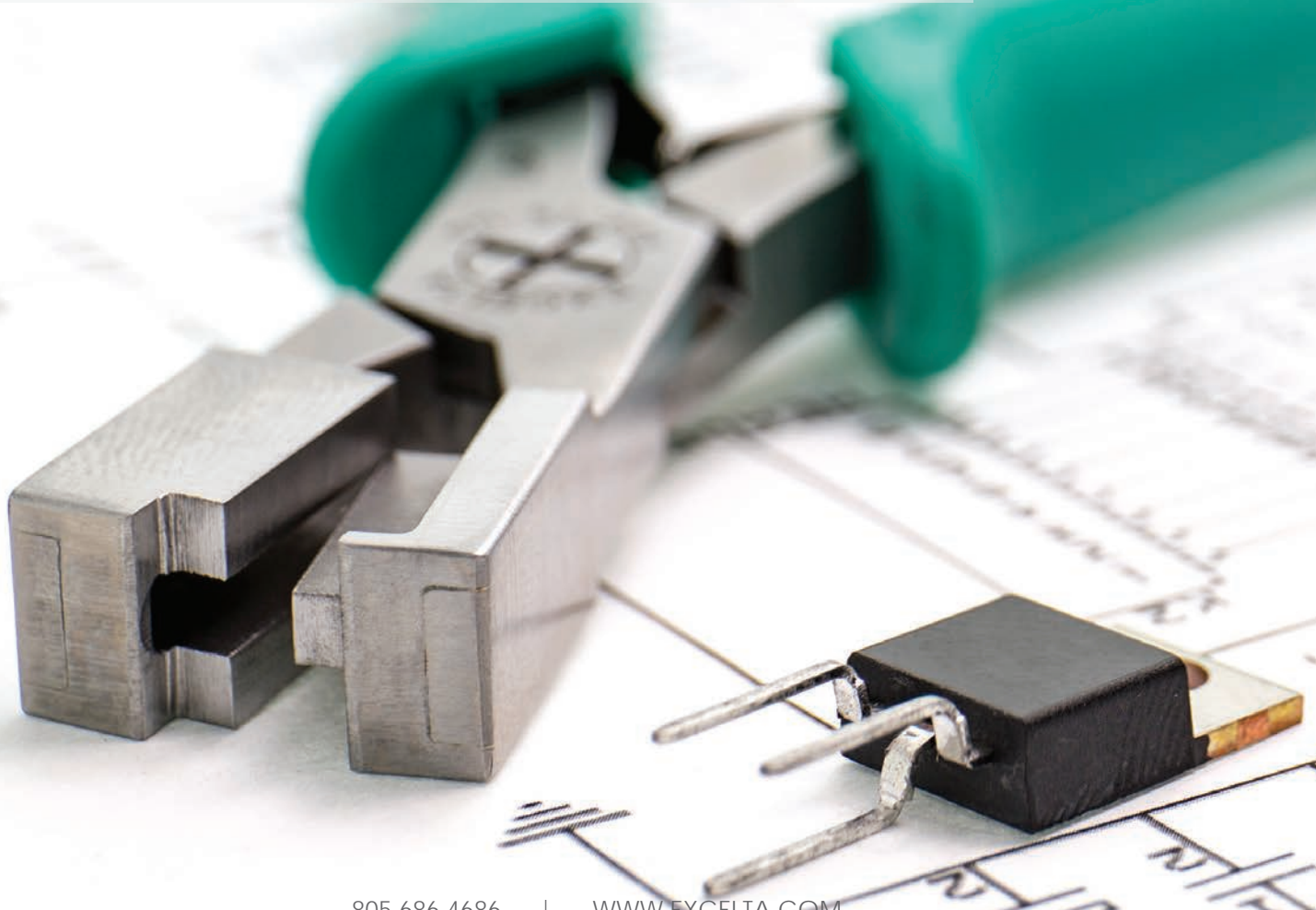



ULTRA PRECISION

As the leader in tool technology, Excelta knows every application is unique. Our Custom Design facility can work from your schematic to manufacture any tool to your specifications. Or, if you prefer, our experienced designers can diagnose your needs and design the tool “Precisely Right” for your unique application.

Whether you need a single tool to handle special parts under unique conditions, or a supply of custom tools to crimp, cut, place or extract parts, Excelta’s Custom Design Service has the experience, ingenuity and capability to meet your needs.

The following pages include Excelta tools that have been designed with a very special application in mind. If you don’t see the tool you’re looking for, contact our Custom Design Department at **(805) 686-4686** or log on to www.exceltacustomtools.com and we will design the custom tool to fit your application.

LEAD FORMING

CUSTOM TOOLS

Cutters/Formers

★★★★★ ULTRA PRECISION

500 Series **Molded Grip** - Surface Resistivity - 10^8 ohms/sq
900 Series **Cushion Grip** - Surface Resistivity - 10^{10} ohms/sq



500-108-US

5.5" (137mm)

Designed to bend leads to 45° then cut the lead to .050" keeping component in place when soldering. Recommended cutting capacity is .025" (.63mm) dia. soft wire. Featuring a molded ergonomic grip with dual leaf springs.



930E-1

5.5" (137mm)

Designed to cut leads to .060" (1.5mm) then bend the lead keeping the component in place when soldering. Cutting capacity is .032" (.8mm) dia. soft wire. Featuring soft cushioned ergonomic grips with dual leaf springs.



530E-1-US

5" (125mm)

Designed to cut leads to .060" (1.5mm) from the PC board, then bend the lead to 30° keeping components in place when soldering. Cutting capacity is .025" (.63mm) dia. soft wire. Featuring molded ergonomic grips with dual leaf springs.



500-88-US

5" (125mm)

Designed to form a consistent standoff and cut the lead to length on most popular radial lead components. Cutting capacity is .025" (.63mm) dia. soft wire. Featuring a molded ergonomic grip with dual leaf springs.



907

6" (150mm)

Designed to cut leads to .030" (.75mm) and swages the end of the lead to prevent it from falling out of the P.C. board. Cutting capacity is .032" (.8mm) dia. soft wire. Featuring soft cushioned ergonomic grips with dual leaf springs.



500-89-US

5.5" (137mm)

Dog leg lead forming plier/cutter is designed to increase or decrease the center dimension on radial lead components. The added shear cutter saves component prep time. Cutting capacity is .025" (.63mm) dia. soft wire. Featuring a molded ergonomic grip with dual leaf springs.





500 Series Molded Grip - Surface Resistivity - 10^8 ohms/sq
900 Series Cushion Grip - Surface Resistivity - 10^{10} ohms/sq



500-89B-US

5.5" (137mm)

Dog leg lead forming plier/cutter is designed to increase or decrease the center dimension on radial lead components. The added shear cutter saves component prep time. Cutting capacity is .025" (.63mm) dia. soft wire. Featuring a molded ergonomic grip and dual leaf springs.



900-88B

5.75" (144mm)

This stress relief forming plier/cutter is designed to form stress relief and cut leads to a specific dimension in one easy step. Cutting capacity is .020" (.5mm) dia. soft wire. Featuring soft cushioned ergonomic grips with dual leaf springs.



907-88

6" (150mm)

This stress relief forming plier/cutter is designed to form a standoff and cut leads to length on most popular radial lead components. Cutting capacity is .030" (.75mm) dia. soft wire. Featuring soft cushioned ergonomic grips with dual leaf springs.



907-89

5.75" (144mm)

Dog leg lead forming plier/cutter is designed to increase or decrease the center dimension on radial lead component prep time. Cutting capacity is .030" (.75mm) dia. soft wire. Featuring soft cushioned ergonomic grips with dual leaf springs.



907-88C

6" (150mm)

The smaller design of this tool will "Standoff" the component closer to the PC board. The added Shear cutter saves on component prep time. Cutting capacity is .025" (.63mm) dia. soft wire. Featuring soft cushioned ergonomic grips with dual leaf springs.

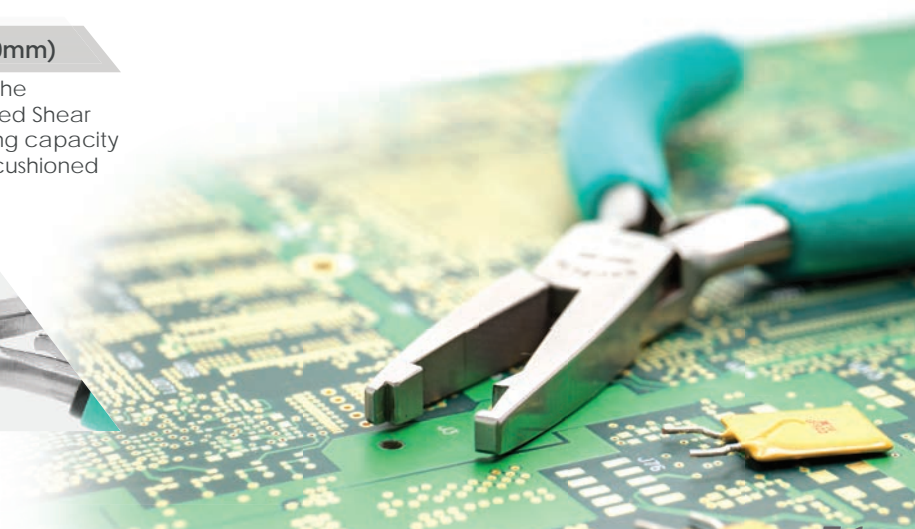

LEAD FORMING

CUSTOM TOOLS

Cutters/Formers

★★★★★ ULTRA PRECISION

500 Series **Molded Grip** - Surface Resistivity - 10^8 ohms/sq
900 Series **Cushion Grip** - Surface Resistivity - 10^{10} ohms/sq



554-TXC-US

5.5" (137mm)

Will form one lead in and one lead out at the same time on most radial type components. The added shear cutter saves component prep time. Cutting capacity is .025" (.63mm) dia. soft wire. Featuring a molded ergonomic grip with dual leaf springs.

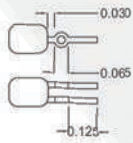

500-13A-US

5" (125mm)

.375" (9.38mm) flat pack forming plier/cutter will form a "Gull Wing" and cut multiple leads to length on various types of flat packs. Cutting capacity is .010" (.25mm) soft wire. Featuring molded ergonomic grips with dual leaf springs.

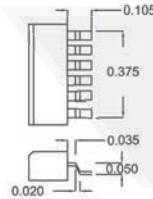

900-10

5.5" (137mm)

Will cut and form 3 or 5 leads on a TO-220 style component. Leads will be formed to the bottom of component body for surface mounting. Featuring soft cushioned ergonomic grips with dual leaf springs.

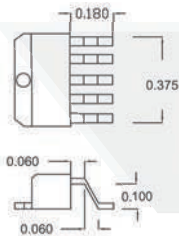

500-13B-US

5.5" (137mm)

.250" (6.25mm) flat pack forming plier/cutter will form a "Gull Wing" and cut multiple leads to length on various types of QFP and SOIC packages. Cutting capacity is .010" (.25mm) soft wire. Featuring molded ergonomic grips with dual leaf springs.

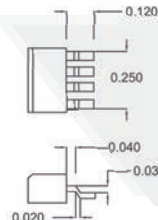

500-103-US

5.5" (137mm)

Designed to form TO-220 style transistors with 3 or 5 leads. Component leads are formed .200" (5mm) from the body of the component. Featuring molded ergonomic grips with dual leaf springs.

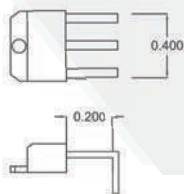

907-89B

5.75" (155mm)

Dog leg lead forming plier is a heavy duty plier designed to increase or decrease the center dimension on radial lead components. Featuring soft cushioned ergonomic grips with dual leaf springs.

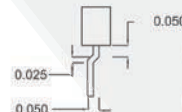



500 Series **Molded Grip** - Surface Resistivity - 10^8 ohms/sq
 900 Series **Cushion Grip** - Surface Resistivity - 10^{10} ohms/sq



500-92-US

5.5" (137mm)

TO-92 lead forming plier has slots on the outside jaw to help the plier fit between the leads of a TO-92 and flare them out .050" (1.25mm) forming a "Standoff" in the lead wires. Featuring molded ergonomic grips with dual leaf springs.

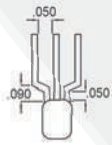

554B-US

5.5" (137mm)

Stress relief forming plier is designed to form a consistent relief of a variety of components. It's recommended for .020" (.5mm) or smaller wire. Featuring molded ergonomic grips with dual leaf springs.



500-11-US

5.5" (137mm)

Off-set lead forming plier is used to form a single lead on TO-220 style transistor. The lead can be formed .100" (2.5mm). Featuring a molded ergonomic grip with dual leaf springs.



554F-US

5.5" (137mm)

Stress relief forming plier is our smallest forming plier used to form a standoff on component leads of .020" (.5mm) dia. or smaller. Featuring molded ergonomic grips with dual leaf springs.



554A-US

5" (125mm)

Stress relief forming plier is designed to form stress relief for transistor and resistor leads. The tool design will make consistent standoff on a variety of components. Recommended for .025" (.63mm) and smaller wire. Featuring molded ergonomic grips with dual leaf springs.



954A

6" (150mm)

Stress relief forming plier is designed to form a consistent stress relief on a variety of components. Similar to the 554A-US, made on a larger frame, these pliers can form leads and wires up to .030" (.75mm) dia. Featuring soft cushioned ergonomic grips with dual leaf springs.



LEAD FORMING

CUSTOM TOOLS

Formers

★★★★★ ULTRA PRECISION

500 Series **Molded Grip** - Surface Resistivity - 10^8 ohms/sq
900 Series **Cushion Grip** - Surface Resistivity - 10^{10} ohms/sq



954B

5.75" (155mm)

Designed to form a consistent standoff in a variety of components. Similar to the 554A-US, made on a larger frame these pliers can form leads and wires up to .035" (.88mm) diameter. Featuring cushioned ergonomic grips with dual leaf springs.



554-TX-US

5.5" (137mm)

Stress relief forming plier will form stress relief in most radial lead components. Designed to form one lead in and one lead out in a single operation. It's recommended for .025" (.63mm) dia. or smaller wire. Featuring molded ergonomic grips with dual leaf springs.



909-4

5" (125mm)

Stress relief forming plier provides stress relief forming for transistor and resistor leads. Tool design is versatile in a variety of applications. Recommended for .035" (.88mm) wire or smaller. Featuring soft cushioned ergonomic grips with dual leaf springs.



554-TXB-US

5" (125mm)

Stress relief forming plier will form stress relief in most radial lead components. Designed to form one lead in and one lead out in a single operation. Recommended for .025" (.63mm) dia. or smaller leads and wires. Featuring a molded ergonomic grip with dual leaf springs.



909-4B

6.25" (156mm)

Stress relief forming plier may be used for many types of components. The smaller dimensions keep components close to the PC board. Recommended for .030" (.75mm) or smaller leads and wires. Featuring soft cushioned ergonomic grips with dual leaf springs.



554-3RB-US

5.25" (131mm)

Lock-in lead forming plier will form an "s" bend on a component lead, enabling the component to stay in place when soldering. Recommended for .025" (.63mm) dia. or smaller leads and wires. Featuring molded ergonomic grips with dual leaf springs.





500 Series **Molded Grip** - Surface Resistivity - 10^8 ohms/sq
 900 Series **Cushion Grip** - Surface Resistivity - 10^{10} ohms/sq



907-210A

6.75" (169mm)

90° forming tool that is adjustable and designed for TO-247 size components.



500-210C-US

5.5" (137mm)

90° lead forming tool with the bend length specified as required. Example of how to order: 500-210C-US-.050"



907-104A

5.5" (137mm)

90° forming tool designed for TO-247 package lead forming. Leads #1 and #3 will be formed at .150" (3.75mm) from the body. Lead #2 will be formed at .300".



500-15-US

5.5" (137mm)

TO-220 stagger lead forming vertical mount. Leads #1 and #3 will be formed with a .075" offset, and lead #2 with a .075" (1.88mm) offset in the opposite direction for .150" (3.75mm) lead centers.



LEAD FORMING

CUSTOM TOOLS

Formers

★★★★★ ULTRA PRECISION

500 Series **Molded Grip** - Surface Resistivity - 10^8 ohms/sq



500-104-US

5" (125mm)

Transistor forming plier is used in forming 3 leads on a TO-220 style transistor. The two outside leads will be bent .200" (5mm), while the center lead is bent .300" (7.5mm) from the body of the component. Featuring molded ergonomic grips with dual leaf springs.



500-210-US

5.5" (137mm)

Multiple lead forming plier is designed to bend the leads on LEDs and other multiple lead components. Leads are formed to 90° and .100" from the component body without damage. Recommended for use on .025" diameter leads and wires. Featuring molded ergonomic handles with dual leaf springs.



500-95B-US

5.5" (137mm)

Dog leg lead forming plier is designed to form a "Dog Leg" bend in the lead wire. This tool can be used to increase or decrease the center dimensions of the radial lead components. Recommended for .030" (.75mm) or smaller leads and wires. Featuring molded ergonomic grips with dual leaf springs.



500-210A-US

4.75" (119mm)

Adjustable multiple lead forming plier is designed to form transistor leads with .100" (2.5mm) center spacing. Leads are formed at 90° for through-hole mounting. The distance from the component body to the end is adjustable from .100" (2.5mm) to .300" (7.5mm). Featuring molded ergonomic grips with dual leaf springs.

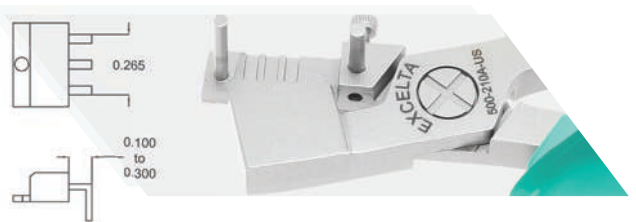

500-104B-US

5" (125mm)

Transistor forming plier is an elaborate design for forming 5 leads on a TO-220 component in one easy operation. The tool will ensure uniformity of difficult lead alignment. Featuring molded ergonomic grips with dual leaf springs.





500 Series **Molded Grip** - Surface Resistivity - 10^8 ohms/sq



505-US

5.5" (137mm)

Our 505 Series pliers have been designed to handle DIP/IC packages. The chart will help you quickly find the size you are looking for.



| Part# | A | B | C | Pins |
|--------------|--------------|-------------|------------------|-------|
| 505-US | .18" (4.5mm) | .4" (10mm) | 1.062" (26.55mm) | 18-22 |
| 505A-US | .18" (4.5mm) | .6" (15mm) | 1.260" (31.5mm) | 24 |
| 505B-US | .18" (4.5mm) | .6" (15mm) | 2.080" (52mm) | 40 |
| 505BG-US | .18" (4.5mm) | .6" (15mm) | 1.398" (35mm) | 28 |
| 505C-US | .18" (4.5mm) | .3" (7.5mm) | .7880" (19.7mm) | 14-16 |
| 505D-US | .18" (4.5mm) | .3" (7.5mm) | .3580" (.95mm) | 6-8 |
| 505E-US | .18" (4.5mm) | .3" (7.5mm) | 1.260" (31.5mm) | 24 |
| 505F-US | .18" (4.5mm) | .3" (7.5mm) | .2570" (6.43mm) | 4 |
| 505G-US | .18" (4.5mm) | .3" (7.5mm) | 1.660" (41.5mm) | 32 |
| 505J-US | .18" (4.5mm) | .3" (7.5mm) | .9660" (24.15mm) | 20 |
| 505K-US | .18" (4.5mm) | .3" (7.5mm) | 1.398" (35mm) | 28 |
| 505H-US | .18" (4.5mm) | .6" (15mm) | 3.30" (82.5mm) | 48 |
| 505-20-US-ST | .18" (4.5mm) | .4" (10mm) | 1.06" (26.5mm) | 18-22 |

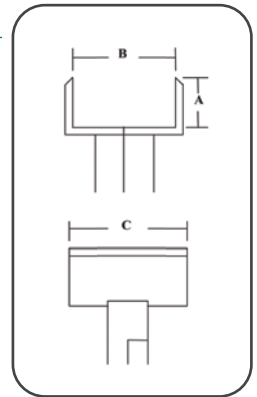

Custom size pliers available upon request.

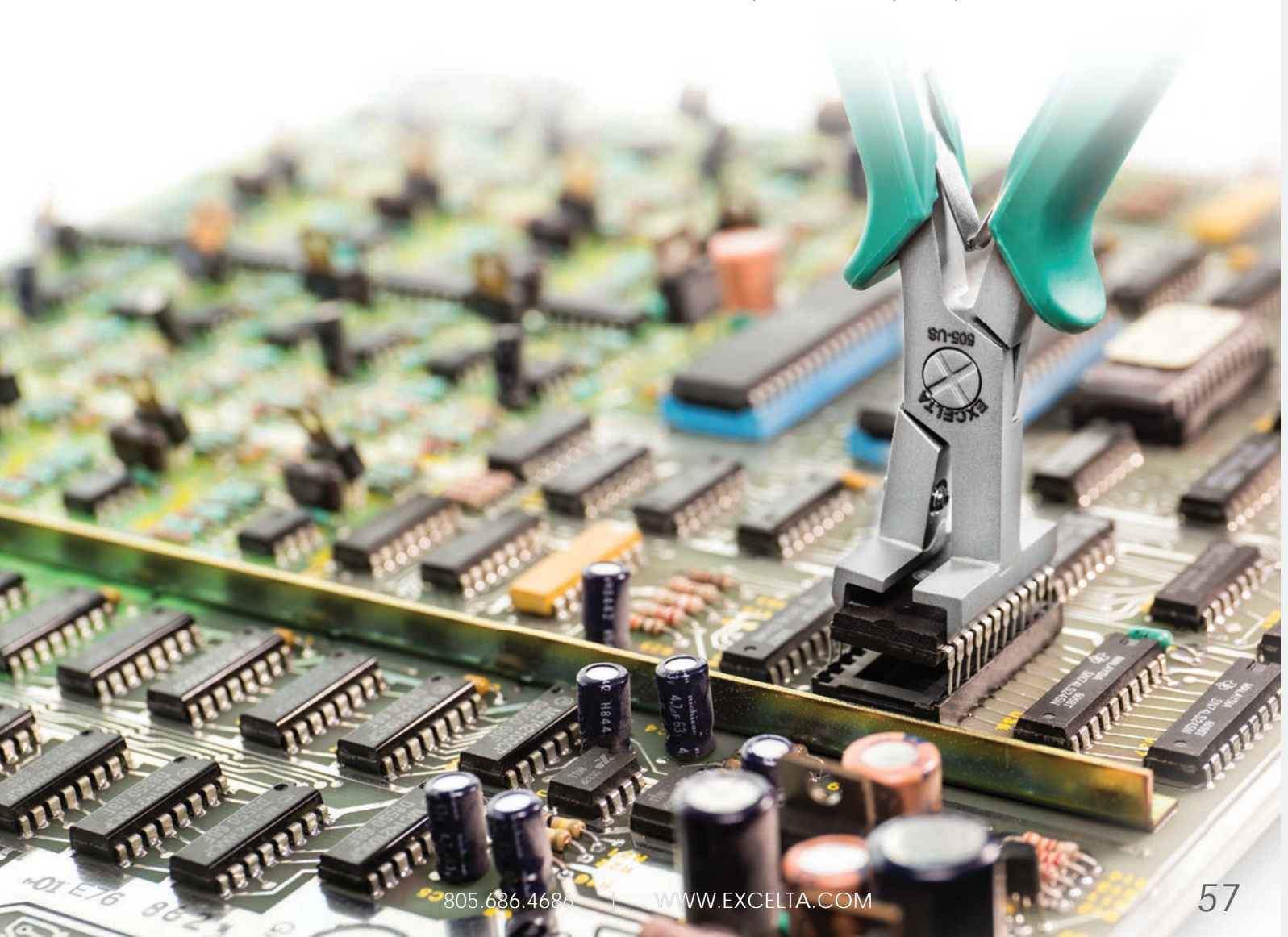

5 Levels of Precision

★★★★★
ULTRA PRECISION

Made in Switzerland from 40% cobalt alloy steel, harder than stainless steel, anti-magnetic, excellent resistance to corrosion and resistant to temperature up to 500°C (932°F). Used with very high magnification.



★★★★★
EXTREME PRECISION

Made of Titanium Alloy, Super Neverust (AISI 904L), Diamond Coated tips (AISI 316L) and Ceramic Coated tips (AISI 440). These three materials are stronger than the standard AISI 303/304 stainless steel, extending the life of the tips. In addition, solder will not stick to the titanium alloy and it is very light weight and temperature resistant.



★★★★
HIGH PRECISION

Precision grade tweezers made from neverust® anti-magnetic stainless steel, stainless steel, or carbon steel and are manufactured in Switzerland with high precision points. The perfect choice when working under 5X to 10X magnification.



★★★
FINE PRECISION

Standard grade "PI" tweezers have fine precision points at a lower cost. Used with low Magnification.



★
GENERAL PRECISION

General Precision Grade "SE" tweezers are manufactured for general purpose work when magnification is not required.



TWEEZER TECHNICAL INFORMATION

The most critical parts of any tweezer or forcep are the points. Finishing the points is an art form perfected over years of practice. Whether working on microchips or working on human cells, microscopy is playing a significant part in the work being done today. This work requires extremely precise tweezer points that meet perfectly. Excelta tweezers cover the spectrum!

Micro Fine Tips

When working under high magnification with tweezers/forceps it is critical that the points are exactly the same size and meet precisely. Many of these tweezers have relieved tips allowing for excellent visibility under a scope.

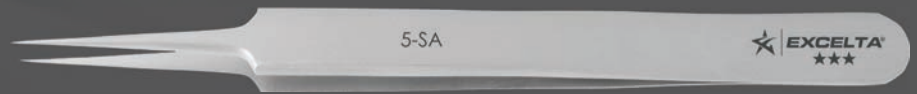

Fine Tips

These very fine tipped tweezers can be used for low magnification applications, or for work being done without the use of a scope.



Medium Tips

General purpose tweezers with semi-fine tips are used for any work done without a microscope.

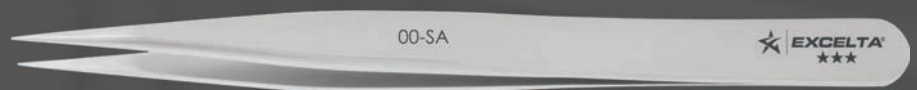

Blunt Strong Tips

Blunt strong tipped tweezers are the work horse of tweezers. Most of these tweezers can be dropped without much damage to the tips. They last much longer than fine or micro fine tipped tweezers, but lack the accuracy of finer tipped tweezers.



Flat Tips

Flat tip tweezers are used for everything from placing and removing labels, to picking up flat items like lenses. These tips are generally rounded.

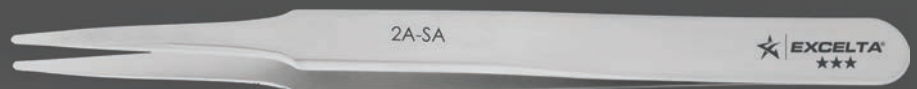

Application Specific Tips

We create application specific tweezers for ANY application. Over the years certain applications have repeated, prompting us to categorize these application specific tweezers. Those categories include cutting tweezers, paddle tip tweezers, wafer tweezers, miniature tweezers, cross-action tweezers, ergonomic tweezers and component handling tweezers.



Tweezer Add-ons

We offer a wide variety of customizations that can be added on to most items found in this tweezer section. The add-on code simply needs to be added to the part number (example 3C-SA-MP). If you have questions or would like more information about add-ons do not hesitate to call.



TC

PTFE Coating is applied 1 ½ " up the tip and helps prevent marring and scratching (metal to metal) contact. Can be applied in 1.5 mil, 3.0 mil, and 5.0 mil thickness.

Example - **3C-SA-TC15**



FLTC

Full length PTFE Coating is applied to the entire tweezer and helps prevent marring and scratching (metal to metal) contact. Can be applied in 1.5 mil, 3.0 mil, and 5.0 mil thickness.

Example - **3C-SA-FLTC50**



ET

Ergonomic Foam Cushion Padding for tweezers. The soft cushion grip helps to relieve the "PINCH GRIP" when using tweezers for long periods of time. The surface resistivity is 10^{10} ohms/sq.

Example - **3C-SA-ET**



MP

Mirror Polished tweezers have radiused edges and polished inside points to prevent nicking and scratching when handling delicate parts.

Example - **3C-SA-MP**

Tweezer Add-ons



D **Single Cut Serrations** can be added to the inside points of most tweezers. Serrations help hold parts when handling and manipulating.

Example - **3C-SA-D**

DX **Double Cut Serrations** can be added to the inside points of most tweezers. These serrations are finer and should be used when handling small parts and wires.

Example **3C-SA-DX**

MZ **MZ tweezers** feature radiused inside edges and blunted tips.

Example **3C-SA-MZ**

WO **Wide Opening tweezers** are designed to have the tips parallel .5" (12.5mm) apart at rest.

Example **3C-SA-WO**

COBALTIMA | MADE IN SWITZERLAND

TWEEZERS / FORCEPS ★★★★★ ULTRA PRECISION

WHY COBALTIMA®?

COBALTIMA® - The perfect combination of strength and durability. Superior to the best stainless steel, these tweezers and forceps have points insensitive to fatigue and they maintain elasticity. The hardness of the points is progressive, reaching its peak in the deployment zone where we have measured a Rockwell C hardness of 63/64 for model 5-CO.

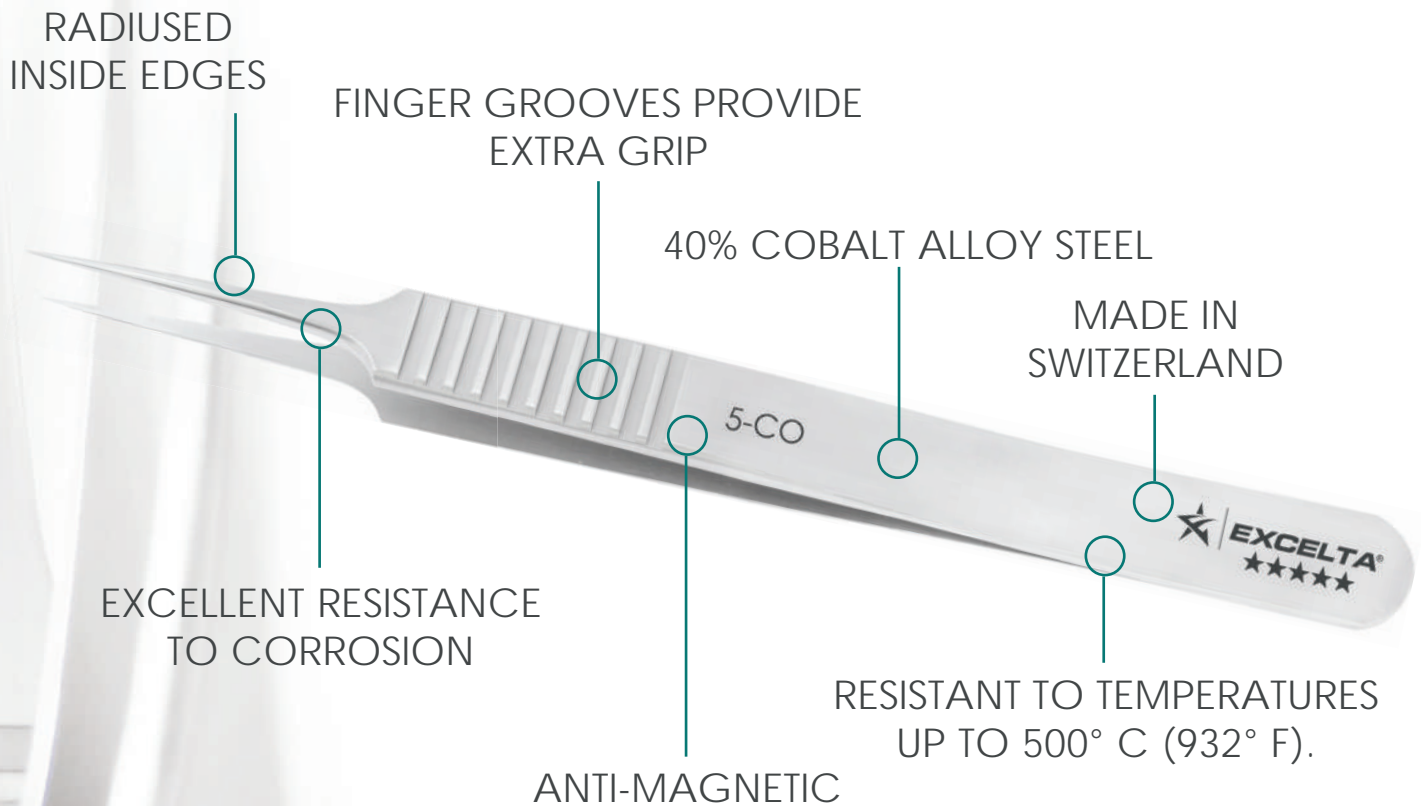

| | | |
|--|----------------------|-----------------------|
| Temperature of Fusion | (°C) | 450-1460 |
| Volunteer Mass | (g.cm ³) | 8.3 |
| Electrical Resistivity at 20° | (Ω Cm) | 90-95 |
| Thermo Co-efficient Between 0 and 3000°C | softened (°C) | 4.10 ⁴ |
| | crushed (°C) | 20,8.10 ⁻³ |
| Magnetic Properties | | anti-magnetic |



Our special Cobalt steel is harder than stainless steel and has excellent resistance to corrosion and temperatures of up to 500°C (932°F).

TAPERED TIPS WITH MICRO FINE POINTS

Length 4.25" (106mm)

This design has our finest points and is the ultimate tool for microscopy.

| Part# | Material | Critical Tip Measurement (CTM) |
|-------|----------|--------------------------------|
| 5-CO | Cobalt | .002"X .0004" .05mm X .01mm |



TAPERED TIPS WITH MICRO FINE POINTS

Length 4.25" (106mm)

This design has micro fine points and is the ideal tool for microscopy.

| Part# | Material | Critical Tip Measurement (CTM) |
|-------|----------|--------------------------------|
| 4-CO | Cobalt | .0024"X .0008" .06mm X .02mm |



TAPERED TIPS WITH STRONG FINE POINTS

Length 4.75" (119mm)

Used for microscopy, this tool has stronger points than the 5-CO or 4-CO.

| Part# | Material | Critical Tip Measurement (CTM) |
|-------|----------|--------------------------------|
| 2-CO | Cobalt | .009"X .0039" .24mm X .1mm |



STRAIGHT TIPS WITH VERY FINE POINTS

Length 4.75" (119mm)

Very popular design for handling and placing of small parts.

| Part# | Material | Critical Tip Measurement (CTM) |
|-------|----------|--------------------------------|
| 3-CO | Cobalt | .0031"X .0016" .08mm X .04mm |



COBALTIMA | MADE IN SWITZERLAND

TWEEZERS / FORCEPS

★★★★★ ULTRA PRECISION

The radiused inside edges protect parts from scratching, while the outside finger grooves provide extra grip and feel when handling very small parts.

STRAIGHT TIPS WITH VERY FINE POINTS

Length 4.25" (106mm)

Our most popular design for all types of micro assembly.

| Part# | Material | Critical Tip Measurement (CTM) |
|-------|----------|--------------------------------|
| 3C-CO | Cobalt | .0031" X .0016" .08mm X .04mm |



10° OFFSET TIPS WITH MICRO FINE POINTS

Length 4.5" (112mm)

The offset design offers better visibility in dense areas.

| Part# | Material | Critical Tip Measurement (CTM) |
|-------|----------|--------------------------------|
| 5A-CO | Cobalt | .0024" X .0008" .06mm X .02mm |



45° BENT TIPS WITH MICRO FINE POINTS

Length 4.5" (112mm)

The bent tips are helpful when reaching into confined areas.

| Part# | Material | Critical Tip Measurement (CTM) |
|-------|----------|--------------------------------|
| 51-CO | Cobalt | .0020" X .0004" .05mm X .01mm |



45° CURVED TIPS WITH VERY FINE POINTS

Length 4.5" (112mm)

Very popular design for handling and placing of small parts.

| Part# | Material | Critical Tip Measurement (CTM) |
|-------|----------|---|
| 7-CO | Cobalt | .0027" X .0012" .07mm X .03mm |
| 7B-CO | Cobalt | Serrated Tips .0027" X .0012" .07mm X .03mm |



MADE IN SWITZERLAND

★★★★★ ULTRA PRECISION

COBALTIMA
MINIATURE
TWEEZERS / FORCEPS



These miniature tweezers are designed for work under a microscope and engineered to fit small hands. The radiused inside edges protect parts from scratching.

TAPERED TIPS WITH MICRO FINE POINTS

Length 3.13" (78mm)

| Part# | Material | | Critical Tip Measurement (CTM) |
|-----------|----------|---------------|--------------------------------|
| M-5-CO | Cobalt | | .0020"X .0004" .05mm X .01mm |
| M-5-CO-ET | Cobalt | Ergo-Tweezer® | .0020"X .0004" .05mm X .01mm |



STRAIGHT TIPS WITH FINE POINTS

Length 3.13" (78mm)

| Part# | Material | | Critical Tip Measurement (CTM) |
|-----------|----------|---------------|--------------------------------|
| M-3-CO | Cobalt | | .0037"X .0016" .08mm X .04mm |
| M-3-CO-ET | Cobalt | Ergo-Tweezer® | .0037"X .0016" .08mm X .04mm |



75° ANGLED TIPS WITH SHARP POINTS

Length 3.13" (78mm)

| Part# | Material | | Critical Tip Measurement (CTM) |
|--------|----------|--|--------------------------------|
| M-6-CO | Cobalt | | .0027"X .0012" .07mm X .03mm |



EXOTIC METALS/COATINGS TWEEZERS

Several of our most popular style tweezers are now offered in alternative materials that add value compared to the standard tweezer metals.

SUPER NEVERUST®

Stronger than our 'SA' material

Hard
pg. 67

Non-Magnetic
Will not Oxidize
Resists most acids

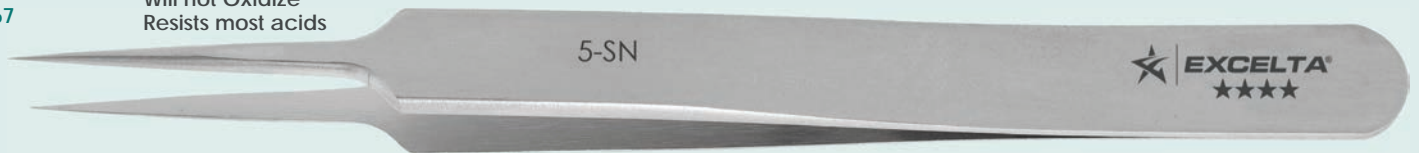

DIAMOND TIPPED

Neverust® material

Harder
pg. 68

Stronger than Super Neverust®
Anti-Magnetic
Will not Oxidize
Resists most acids



CERAMIC COATED

Stainless Steel

Harder
pg. 69

Stronger than Diamond Tipped (Cerakote™ C0105)
Stainless Steel – Magnetic (AISI 440)
Temperature resistant to 1600°F
Resists most acids



TITANIUM

Light Weight

Hardest
pg. 70

Soldering Applications - Solder will not adhere to tweezers
Temperature Resistant to 430°C (806°F)
Stronger than Super Neverust® or Diamond Tipped
Non-Magnetic
Will not Oxidize
Resists most acids



PTFE Coated

Non-Stick Material

Soft
pg. 71

Sensitive Applications - Non-Stick material helpful when handling delicate materials
PTFE Coating applied on the first 1.5" (37.5mm) of the tips.
Prevents marring and scratching (metal to metal) contact.

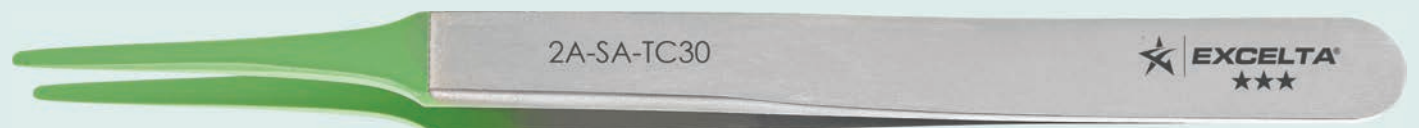



PRECISION

EXTREME

SUPER NEVERUST® EXOTIC METALS/COATINGS



Super Neverust® (AISI 904L) is non-magnetic and stronger than the standard 'SA' material. It will not oxidize and it resists most acids.

TAPERED TIPS WITH EXTRA FINE POINTS

Length 4.38" (109mm)

| Part# | Material | Critical Tip Measurement (CTM) | |
|-------|-----------------|--------------------------------|---------------|
| 5-SN | Super Neverust® | .003" X .003" | .08mm X .08mm |



STRAIGHT TIPS WITH FINE POINTS

| Part# | Material | Length | Critical Tip Measurement (CTM) | |
|-------|-----------------|---------------|--------------------------------|---------------|
| 3-SN | Super Neverust® | 4.75" (118mm) | .003" X .005" | .08mm X .12mm |
| 3C-SN | Super Neverust® | 4.38" (109mm) | .003" X .005" | .08mm X .12mm |



45° CURVED TIPS WITH VERY FINE POINTS

Length 4.5" (113mm)

| Part# | Material | Critical Tip Measurement (CTM) | |
|-------|-----------------|--------------------------------|--------------|
| 7-SN | Super Neverust® | .008" X .005" | .2mm X .12mm |



TAPERED TIPS WITH FLAT ROUND POINTS

Length 4.75" (118mm)

| Part# | Material | Critical Tip Measurement (CTM) | |
|-------|-----------------|--------------------------------|---------------|
| 2A-SN | Super Neverust® | .06" X .010" | 1.5mm X .25mm |



DIAMOND COATED EXOTIC METALS/COATINGS

EXTREME

PRECISION



Diamond Coating the tips strengthens the tips for added life over the conventional SA' material. These tweezers are anti-magnetic, anti-acid and stainless (AISI 316L).

TAPERED TIPS WITH MICRO FINE POINTS

Length 4.38" (109mm)

| Part# | Material | Critical Tip Measurement (CTM) |
|---------|-----------|--------------------------------|
| 5-SA-DC | Neverust® | .004" X .002" .1mm X .05mm |



STRAIGHT TIPS WITH FINE POINTS

Length 4.38" (109mm)

| Part# | Material | Critical Tip Measurement (CTM) |
|----------|-----------|--------------------------------|
| 3C-SA-DC | Neverust® | .008" X .003" .2mm X .08mm |



LONG STRAIGHT WITH FINE POINTS

Length 5.5" (137mm)

| Part# | Material | Critical Tip Measurement (CTM) |
|----------|-----------|--------------------------------|
| SS-SA-DC | Neverust® | .006" X .003" .15mm X .08mm |



45° CURVED TIPS WITH VERY FINE POINTS

Length 4.5" (113mm)

| Part# | Material | Critical Tip Measurement (CTM) |
|---------|-----------|--------------------------------|
| 7-SA-DC | Neverust® | .005" X .004" .13mm X .1mm |



TAPERED TIPS WITH FLAT ROUND POINTS

Length 4.75" (118mm)

| Part# | Material | Critical Tip Measurement (CTM) |
|----------|-----------|--------------------------------|
| 2A-SA-DC | Neverust® | .07" X .005" 1.75mm X .12mm |



STRAIGHT STRONG POINTS

Length 4.75" (118mm)

| Part# | Material | Critical Tip Measurement (CTM) |
|----------|-----------|--------------------------------|
| 00-SA-DC | Neverust® | .030" X .005" .75mm X .12mm |





PRECISION

EXTREME

CERAMIC COATED EXOTIC METALS/COATINGS



Ceramic Coating the tips strengthens the tips for added life over the diamond coated or conventional 'SA' material. These tweezers are magnetic (AISI 440), temperature resistant to 1600°F and resistant to most acids.

TAPERED TIPS WITH MICRO FINE POINTS

Length 4.38" (109mm)

| Part# | Material | Quality | Critical Tip Measurement (CTM) |
|--------|-----------------|---------|--------------------------------|
| 5-S-CC | Stainless Steel | ★★★★ | .004" X .002" .1mm X .05mm |



STRAIGHT TIPS WITH FINE POINTS

Length 4.38" (109mm)

| Part# | Material | Quality | Critical Tip Measurement (CTM) |
|---------|-----------------|---------|--------------------------------|
| 3C-S-CC | Stainless Steel | ★★★★ | .008" X .003" .2mm X .08mm |



45° CURVED TIPS WITH VERY FINE POINTS

Length 4.5" (113mm)

| Part# | Material | Quality | Critical Tip Measurement (CTM) |
|--------|-----------------|---------|--------------------------------|
| 7-S-CC | Stainless Steel | ★★★ | .005" X .004" .13mm X .1mm |



TAPERED TIPS WITH FLAT ROUND POINTS

Length 4.75" (118mm)

| Part# | Material | Quality | Critical Tip Measurement (CTM) |
|---------|-----------------|---------|--------------------------------|
| 2A-S-CC | Stainless Steel | ★★★★ | .07" X .005" 1.75mm X .12mm |



STRAIGHT STRONG POINTS

Length 4.75" (118mm)

| Part# | Material | Quality | Critical Tip Measurement (CTM) |
|---------|-----------------|---------|--------------------------------|
| 00-S-CC | Stainless Steel | ★★★★ | .030" X .005" .75mm X .12mm |



TITANIUM TWEEZERS

EXTREME

PRECISION



The Titanium alloy is very light, stronger than most metal tweezers, will not oxidize, resists most acids and is non-magnetic. Additionally, solder will not adhere to it, making it ideal for soldering applications. It is temperature resistant to 430°C (806°F).

TAPERED TIPS WITH EXTRA FINE POINTS

Length 4.38" (109mm)

| Part# | Material | Critical Tip Measurement (CTM) |
|-------|----------|---------------------------------|
| 5-TA | Titanium | .003" X .0075" .150mm X .0625mm |



STRAIGHT TIPS WITH FINE POINTS

Length 4.38" (109mm)

| Part# | Material | Critical Tip Measurement (CTM) |
|-------|----------|--------------------------------|
| 3C-TA | Titanium | .005" X .0031" .13mm X .08mm |



45° CURVED TIPS WITH VERY FINE POINTS

Length 4.5" (113mm)

| Part# | Material | Critical Tip Measurement (CTM) |
|-------|----------|--------------------------------|
| 7-TA | Titanium | .095" X .003" 2.375mm X .075mm |



TAPERED TIPS WITH FLAT ROUND POINTS

Length 4.75" (118mm)

| Part# | Material | Critical Tip Measurement (CTM) |
|-------|----------|--------------------------------|
| 2A-TA | Titanium | .059" X .008" 1.5mm X .2mm |





PRECISION

HIGH FINE GENERAL

PTFE - NON MARRING EXOTIC METALS/COATINGS



PTFE Coating applied on the first 1.5" (37.5mm) of the tips helps prevent marring and scratching (metal to metal) contact. This coating can be applied on any tweezer in 1.5 mil, 3.0 mil and 5.0 mil thickness. See pg. 60 for more details.

TAPERED TIPS WITH EXTRA FINE POINTS

Length 4.38" (109mm)

| Part# | Material | Quality | Critical Tip Measurement (CTM) |
|--------------|-----------------|---------|--------------------------------|
| 5-SA-SE-TC15 | Stainless Steel | ★ | |

NEW ITEM



45° CURVED TIPS WITH VERY FINE POINTS

Length 4.5" (113mm)

| Part# | Material | Quality | Critical Tip Measurement (CTM) |
|--------------|-----------------|---------|--------------------------------|
| 7-SA-SE-TC15 | Stainless Steel | ★ | |

NEW ITEM



STRAIGHT STRONG POINTS

Length 4.75" (118mm)

| Part# | Material | Quality | Critical Tip Measurement (CTM) |
|---------------|-----------------|---------|--------------------------------|
| 00-SA-SE-TC15 | Stainless Steel | ★ | |

NEW ITEM

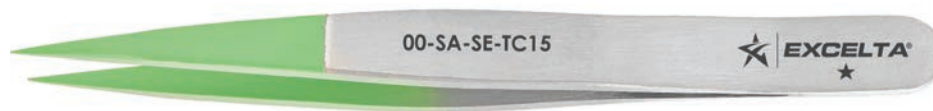

TAPERED TIPS WITH FLAT ROUND POINTS

Length 4.75" (118mm)

| Part# | Material | Quality | Critical Tip Measurement (CTM) |
|---------------|-----------------|---------|--------------------------------|
| 2A-SA-TC15 | Stainless Steel | ★★★★ | .11" X .066" 3mm X 1.7mm |
| 2A-SA-TC30 | Stainless Steel | ★★★★ | .11" X .066" 3mm X 1.7mm |
| 2A-SA-PI-TC15 | Stainless Steel | ★★★ | |
| 2A-SA-SE-TC15 | Stainless Steel | ★ | |

NEW ITEM



STANDARD STYLE TWEEZERS

STANDARD TWEEZERS

The following pages feature standard style tweezers. Most styles are available in three quality levels and materials. The stars are used to designate the quality level.

★★★ Three Star High Precision Grade

Three Star High Precision Grade tweezers are manufactured in Switzerland with high precision points. They are the perfect choice when working under 5X to 10x magnification.

★★ Two Star "PI" Fine Precision Grade

Two Star Fine Precision Grade "PI" tweezers are manufactured with fine precision points at a lower cost.

★ One Star "SE" General Precision Grade

One Star General Precision Grade "SE" tweezers are manufactured for general purpose use when magnification is not required

Materials

Stainless Steel, Anti-Magnetic - Code "SA" have superior anti-magnetic, anti-acid and anti-corrosion properties. Three Star tweezers feature NEVERUST® stainless steel.

Stainless Steel - Code "S" have a higher carbon content and harder tips than the "SA" material. This material will rust under extreme exposure and is highly magnetic.

Carbon Steel - No Code - The tips are flame hardened for long life and are highly magnetic with low rust resistance.





PRECISION

HIGH FINE GENERAL

STRAIGHT TAPERED TWEEZERS



The tapered tips on these tweezers afford the operator enhanced visibility when working under a microscope. The '5' style has the smallest points making it ideal for working under high magnification. The '2' style offers much stronger points than the '5' or '4' style.

TAPERED TIPS - VERY FINE POINTS

Length 4.25" (106mm)

| Part# | Material | Quality | Critical Tip Measurement (CTM) |
|-------------------------|---------------------|---------|--------------------------------|
| 5 | Carbon Steel | ★★★★ | .004" X .002" .1mm X .05mm |
| 5-S | Stainless Steel | ★★★★ | .004" X .002" .1mm X .05mm |
| 5-SA | Anti-Mag. Neverust® | ★★★★ | .004" X .002" .1mm X .05mm |
| 5-SA-EC* | Anti-Mag. Neverust® | ★★★★ | .004" X .002" .1mm X .05mm |
| 5-S-PI | Stainless Steel | ★★★ | |
| 5-SA-PI | Anti-Mag. SS | ★★★ | |
| 5-S-SE | Stainless Steel | ★★ | |
| 5-SA-SE | Anti-Mag. SS | ★★ | |
| 5-SA-EC* - Epoxy Coated | | ★ | |



TAPERED TIPS - VERY FINE POINTS

Length 4.25" (106mm)

| Part# | Material | Quality | Critical Tip Measurement (CTM) |
|---------|---------------------|---------|--------------------------------|
| 4-SA | Anti-Mag. Neverust® | ★★★★ | .005" X .003" .13mm X .08mm |
| 4-SA-PI | Anti-Mag. SS | ★★★ | |
| 4-SA-SE | Anti-Mag. SS | ★★ | |



TAPERED TIPS - STRONG FINE POINTS

Length 4.75" (119mm)

| Part# | Material | Quality | Critical Tip Measurement (CTM) |
|---------|---------------------|---------|--------------------------------|
| 2-S | Stainless Steel | ★★★★ | .013" X .006" .33mm x .14mm |
| 2-SA | Anti-Mag. Neverust® | ★★★★ | .013" X .006" .33mm x .14mm |
| 2-SA-PI | Anti-Mag. SS | ★★★ | |
| 2-S-SE | Stainless Steel | ★★ | |
| 2-SA-SE | Anti-Mag. SS | ★★ | |



STRAIGHT VERY FINE POINT TWEEZERS

HIGH
FINE
GENERAL
PRECISION



These tweezers are ideal for use under magnification. The fine points and slender body are perfect for handling very small items. Style numbers 3 and 3C are our most common, fine pointed tweezers.

VERY FINE POINTS

Length 4.5" (113mm)

| Part# | Material | Quality | Critical Tip Measurement (CTM) |
|---------|---------------------|---------|--------------------------------|
| 1-S | Stainless Steel | ★★★★ | .008" X .005" .20mm X .12mm |
| 1-SA | Anti-Mag. Neverust® | ★★★★ | .008" X .005" .20mm X .12mm |
| P-S | Stainless Steel | ★★★★ | .009" X .006" .24mm X .14mm |
| 1-PI | Carbon Steel | ★★ | |
| 1-SA-PI | Anti-Mag. SS | ★★ | |
| 1-S-SE | Stainless Steel | ★ | |
| 1-SA-SE | Anti-Mag. SS | ★ | |



VERY FINE POINTS

Length 4.75" (119mm)

| Part# | Material | Quality | Critical Tip Measurement (CTM) |
|---------|---------------------|---------|--------------------------------|
| 3-S | Stainless Steel | ★★★★ | .007" X .004" .17mm X .1mm |
| 3-SA | Anti-Mag. Neverust® | ★★★★ | .007" X .004" .17mm X .1mm |
| 3-S-PI | Stainless Steel | ★★ | |
| 3-SA-PI | Anti-Mag. SS | ★★ | |
| 3-S-SE | Stainless Steel | ★ | |
| 3-SA-SE | Anti-Mag. SS | ★ | |



VERY FINE POINTS

Length 4.25" (106mm)

| Part# | Material | Quality | Critical Tip Measurement (CTM) |
|-----------|---------------------|---------|--------------------------------|
| 3C | Carbon Steel | ★★★★ | .007" X .004" .17mm X .1mm |
| 3C-S | Stainless Steel | ★★★★ | .007" X .004" .17mm X .1mm |
| 3C-SA | Anti-Mag. Neverust® | ★★★★ | .007" X .004" .17mm X .1mm |
| 3C-SA-EC* | Anti-Mag. Neverust® | ★★★★ | .007" X .004" .17mm X .1mm |
| 3C-PI | Carbon Steel | ★★ | |
| 3C-S-PI | Stainless Steel | ★★ | |
| 3C-SA-PI | Anti-Mag. SS | ★★ | |
| 3C-SE | Carbon Steel | ★ | |
| 3C-S-SE | Stainless Steel | ★ | |
| 3C-SA-SE | Anti-Mag. SS | ★ | |



VERY FINE POINTS - ANTI-CRUSH FEATURE

Length 4.25" (106mm)

| Part# | Material | Quality | Critical Tip Measurement (CTM) |
|--------|---------------------|---------|--------------------------------|
| 53C-SA | Anti-Mag. Neverust® | ★★★★ | .007" X .004" .17mm X .1mm |

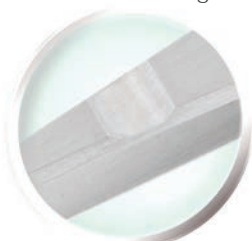



PRECISION

HIGH
FINE
GENERAL

STRAIGHT VERY FINE POINT TWEEZERS



These tweezers are ideal for use under magnification. The fine points and slender body are perfect for handling very small items. Style numbers SS and 60 are very long and slender making them ideal for handling items beyond the reach of a standard tweezer.

LONG VERY FINE POINTS

Length 5.5" (138mm)

| Part# | Material | Quality | Critical Tip Measurement (CTM) |
|----------|---------------------|---------|--------------------------------|
| SS-S | Stainless Steel | ★★★ | .008" X .005" .2mm X .12mm |
| SS-SA | Anti-Mag. Neverust® | ★★★★ | .008" X .005" .2mm X .12mm |
| SS-SA-PI | Anti-Mag. SS | ★★★ | |
| SS-S-SE | Stainless Steel | ★ | |
| SS-SA-SE | Anti-Mag. SS | ★ | |



LONG VERY FINE POINTS

Length 5.5" (138mm)

| Part# | Material | Quality | Critical Tip Measurement (CTM) |
|-------|---------------------|---------|--------------------------------|
| 60-SA | Anti-Mag. Neverust® | ★★★ | .008" X .008" .2mm X .2mm |



VERY FINE POINTS - SERRATED HANDLES

Length 4.75" (119mm)

| Part# | Material | Quality | Critical Tip Measurement (CTM) |
|-------|---------------------|---------|--------------------------------|
| 64-SA | Anti-Mag. Neverust® | ★★★ | .006" X .004" .15mm X .1mm |

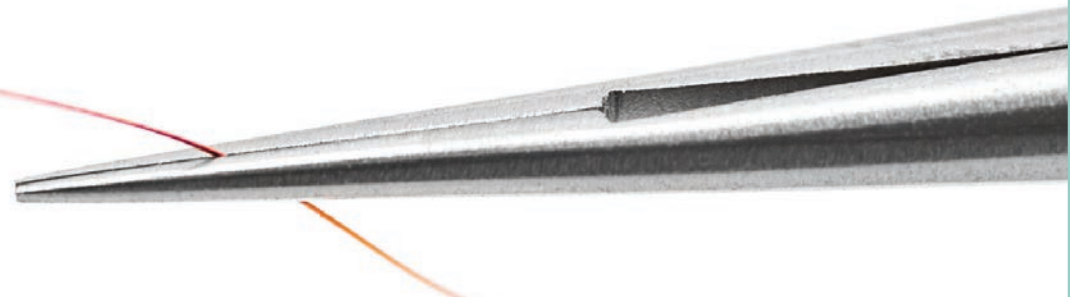

ANGLED VERY FINE POINT TWEEZERS

HIGH
FINE
GENERAL

PRECISION



These very fine pointed tweezers are offset or bent, to provide ideal visibility when working under high magnification. The '5A' and '5B' styles are also relieved at the tip for additional visibility. All of these tools offer very fine small points to handle the smallest of items.

TAPERED 10° OFFSET VERY FINE POINTS

Length 4.5" (113mm)

| Part# | Material | Quality | Critical Tip Measurement (CTM) |
|----------|---------------------|---------|--------------------------------|
| 5A-S | Stainless Steel | ★★★ | .005" X .003" .13mm X .08mm |
| 5A-SA | Anti-Mag. Neverust® | ★★★ | .005" X .003" .13mm X .08mm |
| 5A-SA-PI | Anti-Mag. SS | ★★★ | |
| 5A-S-SE | Stainless Steel | ★★ | |
| 5A-SA-SE | Anti-Mag. SS | ★ | |



TAPERED 45° BENT TIPS - MICRO FINE POINTS

Length 4.25" (106mm)

| Part# | Material | Quality | Critical Tip Measurement (CTM) |
|----------|---------------------|---------|--------------------------------|
| 5B-SA | Anti-Mag. Neverust® | ★★★ | .004" X .002" .1mm X .05mm |
| 5B-SA-PI | Anti-Mag. SS | ★★ | |



TAPERED 45° BENT TIPS - VERY FINE POINTS

Length 4.25" (106mm)

| Part# | Material | Quality | Critical Tip Measurement (CTM) |
|-------|-----------------|---------|--------------------------------|
| 3CB-S | Stainless Steel | ★★★ | .007" X .004" .17mm X .1mm |

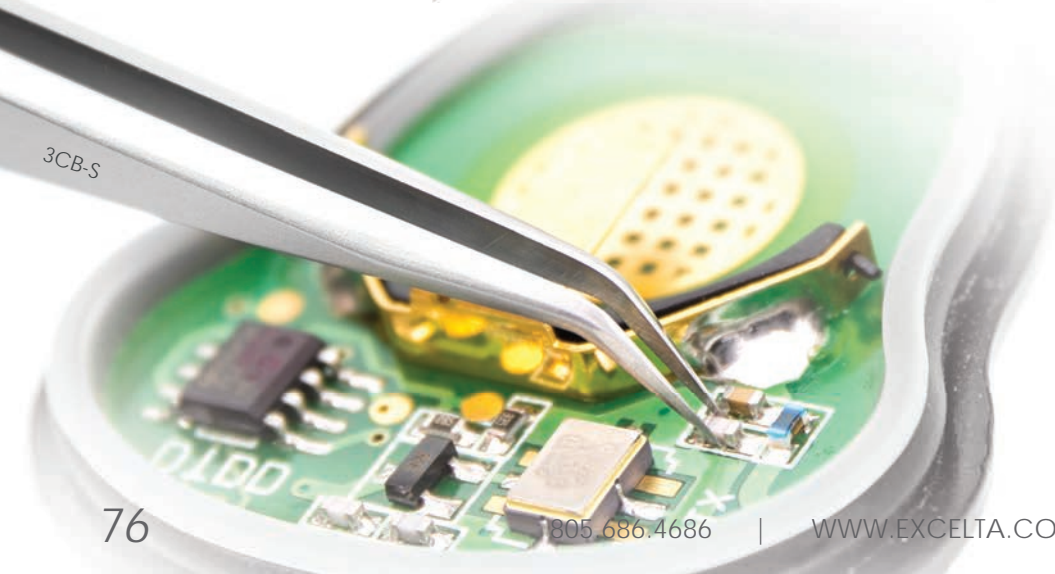



PRECISION

HIGH FINE

ANGLED VERY FINE POINT TWEEZERS



These very fine pointed tweezers are offset or bent to provide ideal visibility when working under high magnification. The '5C', '51' and '50' styles are also relieved at the tip for additional visibility. These tools offer very fine, small points to handle the smallest of items. The '65A' style is long for extended reach.

TAPERED 45° CIRCUMVENTED OBLIQUE MICRO FINE POINTS

Length 4.5" (113mm)

| Part# | Material | Quality | Critical Tip Measurement (CTM) |
|-------|---------------------|---------|--------------------------------|
| 5C-SA | Anti-Mag. Neverust® | ★★★ | .004" X .002" .1mm X .05mm |



TAPERED 45° OBLIQUE VERY FINE POINTS

Length 4.5" (113mm)

| Part# | Material | Quality | Critical Tip Measurement (CTM) |
|-------------------------|---------------------|---------|--------------------------------|
| 51-S | Stainless Steel | ★★★★ | .004" X .002" .1mm X .05mm |
| 51-SA | Anti-Mag. Neverust® | ★★★★ | .004" X .002" .1mm X .05mm |
| 51-SA-PI | Stainless Steel | ★★★ | |
| 50-SA-PI* | Anti-Mag. SS | ★★★ | |
| 50-SA-PI* (30° Oblique) | | | |



LONG 45° BENT VERY FINE POINTS

Length 5.5" (138mm)

| Part# | Material | Quality | Critical Tip Measurement (CTM) |
|--------|---------------------|---------|--------------------------------|
| 65A-SA | Anti-Mag. Neverust® | ★★★ | .008" X .005" .2mm X .12mm |



CURVED VERY FINE POINT TWEEZERS

HIGH
FINE
GENERAL

PRECISION



The '7' style is the most common curved tweezer and offers high visibility and very fine points. The '7B' style offers serrated points for better gripping power. The '6' style has 70° points for reaching into tight places while not restricting visibility.

45° CURVED VERY FINE POINTS

Length 4.5" (113mm)

| Part# | Material | Quality | Critical Tip Measurement (CTM) | |
|----------|---------------------|---------|--------------------------------|--------------|
| 7-S | Stainless Steel | ★★★ | .007" X .004" | .17mm X .1mm |
| 7-SA | Anti-Mag. Neverust® | ★★★ | .007" X .004" | .17mm X .1mm |
| 7-SA-EC* | Anti-Mag. Neverust® | ★★★ | .007" X .004" | .17mm X .1mm |
| 7-PI | Carbon Steel | ★★ | | |
| 7-S-PI | Stainless Steel | ★★ | | |
| 7-SA-PI | Anti-Mag. SS | ★★ | | |
| 7-S-SE | Stainless Steel | ★ | | |
| 7-SA-SE | Anti-Mag. SS | ★ | | |



45° CURVED VERY FINE POINTS - SERRATED

Length 4.5" (113mm)

| Part# | Material | Quality | Critical Tip Measurement (CTM) | |
|----------|---------------------|---------|--------------------------------|--------------|
| 7B-S | Stainless Steel | ★★★ | .007" X .004" | .17mm X .1mm |
| 7B-SA | Anti-Mag. Neverust® | ★★★ | .007" X .004" | .17mm X .1mm |
| 7B-SA-PI | Anti-Mag. SS | ★★ | | |
| 7B-SA-SE | Anti-Mag. SS | ★ | | |



70° ANGLED FLAT SHARP POINTS

Length 4.5" (113mm)

| Part# | Material | Quality | Critical Tip Measurement (CTM) | |
|---------|---------------------|---------|--------------------------------|--------------|
| 6-S | Stainless Steel | ★★★ | .007" X .004" | .17mm X .1mm |
| 6-SA | Anti-Mag. Neverust® | ★★★ | .007" X .004" | .17mm X .1mm |
| 6-PI | Carbon Steel | ★★ | | |
| 6-SA-PI | Anti-Mag. SS | ★★ | | |
| 6-S-SE | Stainless Steel | ★ | | |
| 6-SA-SE | Anti-Mag. SS | ★ | | |





PRECISION

HIGH FINE GENERAL

STRAIGHT MEDIUM POINT TWEEZERS



These 'Boley' style tweezers are general purpose tweezers which feature medium points, and are most commonly used for bench top work not requiring magnification. The 'GG' style is tapered and very strong.

MEDIUM POINT

Length 5" (125mm)

| Part# | Material | Quality | Critical Tip Measurement (CTM) |
|----------|----------------------|---------|--------------------------------|
| AA | Carbon/Nickel Plated | ★★★★ | .008" X .008" .2mm X .2mm |
| AA-S | Stainless Steel | ★★★★ | .008" X .008" .2mm X .2mm |
| AA-SA | Anti-Mag. Neverust® | ★★★★ | .008" X .008" .2mm X .2mm |
| AA-SA-PI | Anti-Mag. SS | ★★★ | |
| AA-SE | Carbon Steel | ★★ | |
| AA-S-SE | Stainless Steel | ★ | |
| AA-SA-SE | Anti-Mag. SS | ★ | |



MEDIUM POINTS - VINYL COATED HANDLE

Length 5" (125mm)

| Part# | Material | Quality |
|-------------|--------------|---------|
| AA-SA-SE-PH | Anti-Mag. SS | ★ |



MEDIUM POINTS

Length 4.75" (119mm)

| Part# | Material | Quality | Critical Tip Measurement (CTM) |
|----------|----------------------|---------|--------------------------------|
| MM | Carbon/Nickel Plated | ★★★★ | .012" X .012" .3mm X .3MM |
| MM-SA-PI | Anti-Mag. SS | ★★★ | |
| MM-SE | Carbon Steel | ★★ | |
| MM-SA-SE | Anti-Mag. SS | ★ | |



TAPERED MEDIUM POINTS

Length 5" (125mm)

| Part# | Material | Quality | Critical Tip Measurement (CTM) |
|-------|---------------------|---------|--------------------------------|
| GG-SA | Anti-Mag. Neverust® | ★★★★ | .02" X .012" .04mm X .012mm |



STRAIGHT STRONG POINT TWEEZERS

HIGH
FINE
GENERAL

PRECISION



The '00' series of tweezers are among the most common used today. Featuring a robust frame and strong points. The '000' style offers radius inside edges on the tips to prevent the marring of delicate wires. The '00B' style features serrated grips for better control. The '00D' style features serrated points & handle for better gripping.

STRONG POINTS

Length 4.5" (113mm)

| Part# | Material | Quality | Critical Tip Measurement (CTM) |
|-----------|---------------------|---------|--------------------------------|
| 00 | Carbon Steel | ★★★ | .018" X .010" .45mm X .25mm |
| 00-S | Stainless Steel | ★★★★ | .018" X .010" .45mm X .25mm |
| 00-SA | Anti-Mag. Neverust® | ★★★★ | .018" X .010" .45mm X .25mm |
| 00-SA-EC* | Anti-Mag. Neverust® | ★★★★ | .018" X .010" .45mm X .25mm |
| 00-PI | Carbon Steel | ★★★ | |
| 00-SA-PI | Anti-Mag. SS | ★★★ | |
| 00-SE | Carbon Steel | ★★ | |
| 00-SA-SE | Anti-Mag. SS | ★★ | |

00-SA-EC* - Epoxy Coated



STRONG POINTS - RADIUS INSIDE EDGES

Length 4.75" (119mm)

| Part# | Material | Quality | Critical Tip Measurement (CTM) |
|-----------|---------------------|---------|--------------------------------|
| 000-SA | Anti-Mag. Neverust® | ★★★★ | .018" X .010" .45mm X .25mm |
| 000-SA-PI | Anti-Mag. SS | ★★★ | |



STRONG POINTS - SERRATED HANDLES

Length 4.75" (119mm)

| Part# | Material | Quality | Critical Tip Measurement (CTM) |
|-----------|---------------------|---------|--------------------------------|
| 00B-SA | Anti-Mag. Neverust® | ★★★★ | .018" X .010" .45mm X .25mm |
| 00B-SA-PI | Anti-Mag. SS | ★★★ | |
| 00B-SA-SE | Anti-Mag. SS | ★★ | |



STRONG SERRATED POINTS - SERRATED HANDLES

Length 4.75" (119mm)

| Part# | Material | Quality | Critical Tip Measurement (CTM) |
|-----------|---------------------|---------|--------------------------------|
| 00D | Carbon Steel | ★★★★ | .018" X .010" .45mm X .25mm |
| 00D-SA | Anti-Mag. Neverust® | ★★★★ | .018" X .010" .45mm X .25mm |
| 00D-SA-PI | Anti-Mag. SS | ★★★ | |
| 00D-SA-SE | Anti-Mag. SS | ★★ | |





The following styles offer medium points. The 'AC' style is very strong and features serrated grips and robust points for better control. The other styles all feature serrated points for better gripping power.

STRONG MEDIUM POINTS - SERRATED HANDLES

Length 4.25" (106mm)

| Part# | Material | Quality | Critical Tip Measurement (CTM) |
|----------|---------------------|---------|--------------------------------|
| AC | Carbon Steel | ★★★ | .024" X .014" .6mm X .35mm |
| AC-SA | Anti-Mag. Neverust® | ★★★★ | .024" X .014" .6mm X .35mm |
| AC-PI | Carbon Steel | ★★★ | |
| AC-SA-PI | Anti-Mag. SS | ★★ | |
| AC-SA-SE | Anti-Mag. SS | ★ | |



MEDIUM SERRATED POINTS - SERRATED HANDLES

Length 6.5" (163mm)

| Part# | Material | Quality | Critical Tip Measurement (CTM) |
|-------|-----------------|---------|--------------------------------|
| 19-S | Stainless Steel | ★★★ | .027" X .024" .7mm X .6mm |



MEDIUM SERRATED POINTS - SERRATED HANDLES

Length 4.5" (113mm)

| Part# | Material | Quality |
|----------|--------------|---------|
| 20-SA-PI | Anti-Mag. SS | ★★ |



MEDIUM SERRATED POINTS - SERRATED HANDLES - GUIDE PIN

Length 4.5" (113mm)

| Part# | Material | Quality |
|----------|-----------------|---------|
| 20A-S-SE | Stainless Steel | ★ |



STRAIGHT ROUND FINE POINT TWEEZERS

HIGH
GENERAL

PRECISION



The '0A' style has the only round tips available. It is ideal for forming leads without marring the lead. The styles '0' and '00C' both are general purpose tweezers not normally associated with work under a scope.

ROUND MICRO FINE POINTS

Length 4.75" (119mm)

| Part# | Material | Quality | Critical Tip Measurement (CTM) |
|-------|--------------|---------|--------------------------------|
| 0A | Carbon Steel | ★★★ | .004" X .002" .1mm X .05mm |



FINE POINTS

Length 4.75" (119mm)

| Part# | Material | Quality | Critical Tip Measurement (CTM) |
|---------|---------------------|---------|--------------------------------|
| 0 | Carbon Steel | ★★★ | .007" X .004" .17mm X .1mm |
| 0-SA | Anti-Mag. Neverust® | ★★★ | .007" X .004" .17mm X .1mm |
| 0-SA-SE | Anti-Mag. SS | ★ | |



FINE POINTS

Length 4.25" (106mm)

| Part# | Material | Quality | Critical Tip Measurement (CTM) |
|-----------|---------------------|---------|--------------------------------|
| 00C | Carbon Steel | ★★★ | .018" X .010" .45mm X .25mm |
| 00C-SA | Anti-Mag. Neverust® | ★★★ | .018" X .010" .45mm X .25mm |
| 00C-SA-SE | Anti-Mag. SS | ★ | |

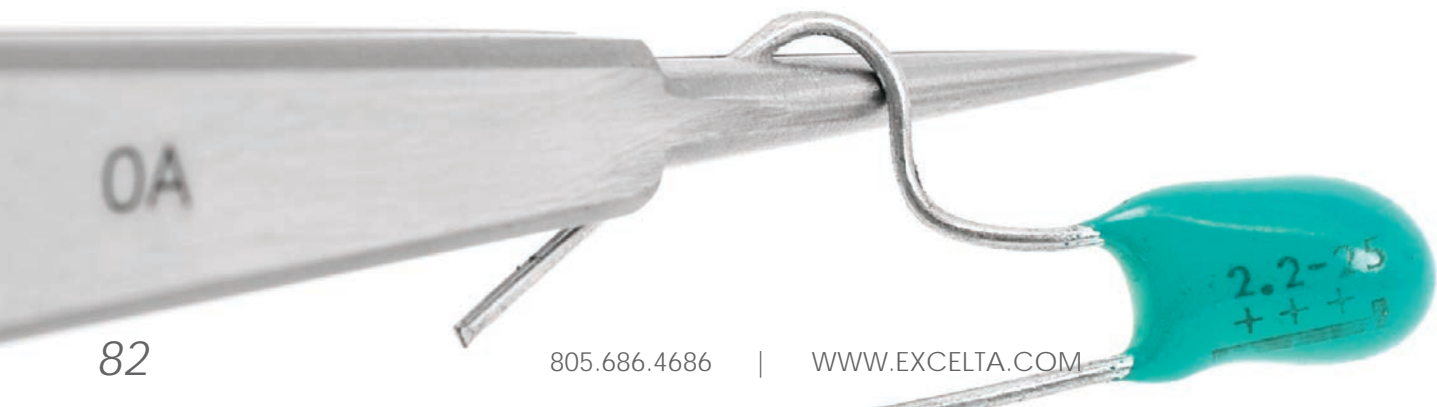



PRECISION

HIGH
FINE
GENERAL

STRAIGHT BROAD/MEDIUM POINT TWEEZERS



The '21' series are primarily used for handling large items. They are strong with serrated points and are offered from 6"-24" long with serrated bodies for better control of the tweezers. The '231' series is a general purpose tweezers offered with or without serrated points.

BROAD SERRATED POINTS - SERRATED HANDLES

| Part# | Material | Quality | Critical Tip Measurement (CTM) | | Length |
|-------------|---------------------|---------|--------------------------------|----------------|-------------|
| 21-6-SA | Anti-Mag. Neverust® | ★★★ | .078" X .039" | 2.00mm X 1.0mm | 6" (150mm) |
| 21-8-SA | Anti-Mag. Neverust® | ★★★ | .098" X .059" | 2.45mm X 1.5mm | 8" (200mm) |
| 21-SA-PI | Anti-Mag. SS | ★★★ | | | 6" (150mm) |
| 21-SA-SE | Anti-Mag. SS | ★★ | | | 6" (150mm) |
| 21-SA-SE-8 | Anti-Mag. SS | ★★ | | | 8" (200mm) |
| 21-SA-SE-12 | Anti-Mag. SS | ★★ | | | 12" (300mm) |
| 21-SA-SE-18 | Anti-Mag. SS | ★★ | | | 18" (450mm) |
| 21-SA-SE-24 | Anti-Mag. SS | ★★ | | | 24" (600mm) |



MEDIUM POINTS - *SERRATED POINTS

Length 4.75" (119mm)

| Part# | Material | Quality |
|------------|--------------|---------|
| 231-SA-SE* | Anti-Mag. SS | ★ |
| 231A-SA-SE | Anti-Mag. SS | ★ |



ANGLED MEDIUM POINT TWEEZERS

HIGH
FINE
GENERAL

PRECISION



These tweezers are primarily used for handling large items. They are strong with serrated points and are offered from 6" -8" long. The body is serrated for better control of the tweezers. All of these tools are angled for better visibility.

45° ANGLED MEDIUM SERRATED POINTS - SERRATED HANDLES - GUIDE PIN

Length 5.5" (138mm)

| Part# | Material | Quality | Critical Tip Measurement (CTM) |
|-------|---------------------|---------|--------------------------------|
| 22 | Carbon Steel | ★★★ | .032" X .025" .8mm X .63mm |
| 22-SA | Anti-Mag. Neverust® | ★★★ | .032" X .025" .8mm X .63mm |



45° ANGLED MEDIUM SERRATED POINTS - SERRATED HANDLES - GUIDE PIN

| Part# | Material | Quality | Critical Tip Measurement (CTM) | Length |
|------------|---------------------|---------|--------------------------------|------------|
| 24-6-SA | Anti-Mag. Neverust® | ★★★ | .019" X .012" .5mm X .3mm | 6" (150mm) |
| 24-SA-PI | Anti-Mag. SS | ★★ | | 6" (150mm) |
| 24-SA-SE | Anti-Mag. SS | ★ | | 6" (150mm) |
| 24-8-SA-SE | Anti-Mag. SS | ★ | | 8" (200mm) |



45° ANGLED MEDIUM SERRATED POINTS - VINYL HANDLES - GUIDE PIN

Length 6.0" (150mm)

| Part# | Material | Quality | Critical Tip Measurement (CTM) |
|-------------|--------------|---------|--------------------------------|
| 24-SA-SE-PH | Anti-Mag. SS | ★ | .018" X .010" .45mm X .25mm |



45° CURVED MEDIUM SERRATED POINTS - SERRATED HANDLES - GUIDE PIN

Length 4.5" (113mm)

| Part# | Material | Quality |
|----------|-----------------|---------|
| 24A-S-SE | Stainless Steel | ★ |





HIGH
FINE
GENERAL

TAPERED FLAT ROUND POINT TWEEZERS



Both the '2A' and the 'F' styles feature flat thin wide tips for handling items like labels or SMD components. The '52A' style is a modified 2A-SA with an 'anti-crush' feature which allows the tips to collapse when too much pressure is applied. The '2AB' style features curved tips.

STRAIGHT TAPERED FLAT ROUND POINTS

Length 4.75" (119mm)

| Part# | Material | Quality | Critical Tip Measurement (CTM) | |
|-----------|---------------------|---------|--------------------------------|--------------|
| 2A | Carbon Steel | ★★★ | .059" X .008" | 1.5mm X .2mm |
| 2A-S | Stainless Steel | ★★★★ | .059" X .008" | 1.5mm X .2mm |
| 2A-SA | Anti-Mag. Neverust® | ★★★★ | .059" X .008" | 1.5mm X .2mm |
| 2A-SA-EC* | Anti-Mag. Neverust® | ★★★★ | .059" X .008" | 1.5mm X .2mm |
| 2A-SA-PI | Anti-Mag. SS | ★★★ | | |
| 2A-S-SE | Stainless Steel | ★ | | |
| 2A-SA-SE | Anti-Mag. SS | ★ | | |

2A-SA-EC* - Epoxy Coated



STRAIGHT TAPERED FLAT ROUND POINTS - ANTI-CRUSH FEATURE

Length 4.75" (119mm)

| Part# | Material | Quality | Critical Tip Measurement (CTM) | |
|--------|---------------------|---------|--------------------------------|--------------|
| 52A-SA | Anti-Mag. Neverust® | ★★★ | .059" X .008" | 1.5mm X .2mm |



STRAIGHT TAPERED FLAT SQUARE POINTS

Length 4.75" (119mm)

| Part# | Material | Quality | Critical Tip Measurement (CTM) | |
|---------|---------------------|---------|--------------------------------|--------------|
| F-SA | Anti-Mag. Neverust® | ★★★★ | .072" X .008" | 1.8mm X .2mm |
| F-SA-PI | Anti-Mag. SS | ★★ | | |



43° CURVED FLAT ROUND POINTS

Length 4.5" (113mm)

| Part# | Material | Quality | Critical Tip Measurement (CTM) | |
|-----------|---------------|---------|--------------------------------|--------------|
| 2AB-N | Nickel/Silver | ★★★★ | .059" X .008" | 1.5mm X .2mm |
| 2AB-SA-PI | Anti-Mag. SS | ★★★ | | |
| 2AB-SA-SE | Anti-Mag. SS | ★ | | |



LARGE FLAT POINT TWEEZERS

HIGH
FINE
GENERAL

PRECISION



The following tweezers have thin flat wide tips for handling wafers, labels or other flat items. The '8' style is a robust tweezer for straightening component leads.

STRAIGHT LARGE FLAT ROUND POINTS - SERRATED HANDLES

Length 4.75" (119mm)

| Part# | Material | Quality | Critical Tip Measurement (CTM) |
|-------|---------------------|---------|--------------------------------|
| 25-SA | Anti-Mag. Neverust® | ★★★ | .137" X .016" 3.5mm X .4mm |



STRAIGHT BROAD FLAT POINTS - SERRATED HANDLES

Length 4.25" (106mm)

| Part# | Material | Quality | Critical Tip Measurement (CTM) |
|-------|---------------------|---------|--------------------------------|
| 27-SA | Anti-Mag. Neverust® | ★★★ | .247" X .016" .62mm X .04mm |

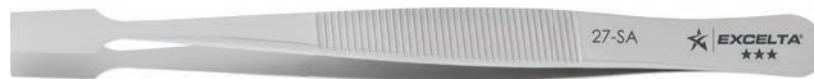

STRAIGHT BROAD FLAT POINTS - SERRATED HANDLES

Length 4.75" (119mm)

| Part# | Material | Quality | Critical Tip Measurement (CTM) |
|-----------|---------------------|---------|--------------------------------|
| 35A-SA | Anti-Mag. Neverust® | ★★★ | .288" X .016" .73mm X .04mm |
| 35A-SA-SE | Anti-Mag. SS | ★ | |



45° OFFSET BROAD FLAT POINTS - SERRATED HANDLES

Length 4.75" (119mm)

| Part# | Material | Quality | Critical Tip Measurement (CTM) |
|-----------|---------------------|---------|--------------------------------|
| 36A-SA | Anti-Mag. Neverust® | ★★★ | .247" X .016" 6.18mm X .4mm |
| 36A-SA-SE | Anti-Mag. SS | ★ | |



WIDE BODY - FLAT SHARP POINTS

Length 4.25" (106mm)

| Part# | Material | Quality |
|---------|--------------|---------|
| 8-SA-PI | Anti-Mag. SS | ★★ |





These tweezers, unlike standard tweezers, are closed at rest and are ideal for holding small parts over an extended period of time. Additionally, the TWEEZER defines the pressure exerted on the item being held, not the USER!

STRAIGHT VERY FINE POINT

Length 4.25" (106mm)

| Part# | Material | Quality |
|-------------|--------------|---------|
| DN-3C-SA-SE | Anti-Mag. SS | ★ |



STRAIGHT VERY FINE POINTS

Length 5" (125mm)

| Part# | Material | Quality | Critical Tip Measurement (CTM) |
|-------|---------------------|---------|--------------------------------|
| 31-SA | Anti-Mag. Neverust® | ★★★ | .012" X .008" .3mm X .2mm |



45° CURVED VERY FINE POINTS

Length 4.5" (113mm)

| Part# | Material | Quality |
|------------|--------------|---------|
| DN-7-SA-SE | Anti-Mag. SS | ★ |



CROSS ACTION TWEEZERS

HIGH
GENERAL

PRECISION



These tweezers, unlike standard tweezers, are closed at rest. They are ideal for holding small parts over an extended period of time. Additionally, the TWEEZER defines the pressure exerted on the item being held, not the USER!

STRAIGHT TAPERED FLAT ROUND POINTS

Length 4.75" (119mm)

| Part# | Material | Quality |
|-------------|--------------|---------|
| DN-2A-SA-SE | Anti-Mag. SS | ★ |



45° ANGLED FINE POINTS

Length 4.5" (113mm)

| Part# | Material | Quality | Critical Tip Measurement (CTM) |
|---------|---------------------|---------|--------------------------------|
| 31-SA-C | Anti-Mag. Neverust® | ★★★ | .012" X .008" .3mm X .2mm |



45° ANGLED STRONG BLUNT POINTS - FIBER HANDLES

Length 6" (150mm)

| Part# | Material | Quality | Critical Tip Measurement (CTM) |
|----------|---------------------|---------|--------------------------------|
| 30-SA | Anti-Mag. Neverust® | ★★★ | .08" X .08" 2mm X 2mm |
| 30-S-SE* | Stainless Steel | ★ | |

*Serrated Tips

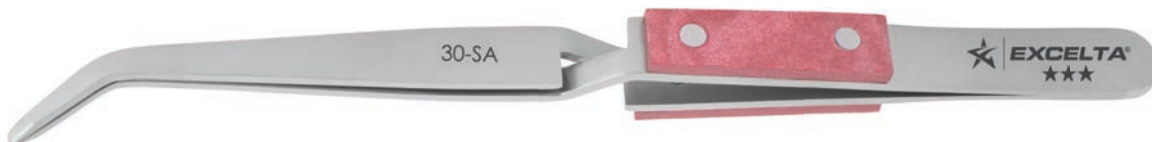

STRAIGHT STRONG BLUNT POINTS - FIBER HANDLES

Length 6" (150mm)

| Part# | Material | Quality | Critical Tip Measurement (CTM) |
|----------|---------------------|---------|--------------------------------|
| 29-SA | Anti-Mag. Neverust® | ★★★ | .09" X .07" 2.25mm X 1.75mm |
| 29-S-SE* | Stainless Steel | ★ | |

*Serrated Tips



MINIATURE TWEEZERS



MINIATURE TWEEZERS

Our miniature tweezers and forceps were specifically designed for work under a microscope and engineered to fit small hands. The tip sizes range from .004" X .002" for extremely precise handling of very small items, to .0058" X .008" for working with wider and larger items.

MINIATURE TWEEZERS

HIGH
FINE
GENERAL

PRECISION



The style 'M-5' has our smallest points and has relieved tips for greater visibility under high magnification. All of the styles shown below are made specifically for working under a microscope.

STRAIGHT TAPERED MICRO FINE POINTS

| Part# | Material | Quality | Critical Tip Measurement (CTM) | | Length |
|-----------|---------------------|---------|--------------------------------|--------------|--------------|
| M-5-S | Stainless Steel | ★★★ | .004" X .002" | .1mm X .05mm | 2.75" (69mm) |
| M-5-SA | Anti-Mag. Neverust® | ★★★ | .004" X .002" | .1mm X .05mm | 3.13" (78mm) |
| M-5-SA-ET | Anti-Mag. Neverust® | ★★★ | .004" X .002" | .1mm X .05mm | 3.75" (94mm) |



STRAIGHT TAPERED VERY FINE POINTS

Length 2.75" (69mm)

| Part# | Material | Quality | Critical Tip Measurement (CTM) | |
|-------|-----------------|---------|--------------------------------|---------------|
| M-4-S | Stainless Steel | ★★★ | .005" X .003" | .13mm X .08mm |



STRAIGHT TAPERED FINE POINTS

Length 3.5" (90mm)

| Part# | Material | Quality | Critical Tip Measurement (CTM) | |
|--------|-----------------|---------|--------------------------------|---------------|
| M-4A-S | Stainless Steel | ★★★ | .009" X .006" | .24mm X .14mm |



STRAIGHT FINE POINTS

Length 2.75" (69mm)

| Part# | Material | Quality | Critical Tip Measurement (CTM) | |
|-------|-----------------|---------|--------------------------------|--------------|
| M-3-S | Stainless Steel | ★★★ | .007" X .004" | .17mm X .1mm |



STRAIGHT FINE POINTS

Length 3.5" (90mm)

| Part# | Material | Quality | Critical Tip Measurement (CTM) | |
|----------|---------------------|---------|--------------------------------|--------------|
| 0C | Carbon Steel | ★★★ | .007" X .004" | .17mm X .1mm |
| 0C-SA | Anti-Mag. Neverust® | ★★★ | .007" X .004" | .17mm X .1mm |
| 0C-SA-PI | Anti-Mag. SS | ★★ | | |
| 0C-SA-SE | Anti-Mag. SS | ★ | | |





PRECISION

EXTREME HIGH

MINIATURE TWEEZERS



Most of the styles shown below have strong tips and are short for use under the scope. The M-179A-RT is a very fine soft tip tweezer with replaceable tips. It's main feature is, it will not mark or mar delicate items.

STRAIGHT TAPERED VERY FINE POINTS

Length 3.38" (85mm)

| Part# | Material | Quality | Critical Tip Measurement (CTM) |
|--------|---------------------|---------|--------------------------------|
| M-2-SA | Anti-Mag. Neverust® | ★★★ | .008" X .005" .2mm X .12mm |



STRAIGHT TAPERED FLAT ROUND POINTS

Length 2.75" (69mm)

| Part# | Material | Quality | Critical Tip Measurement (CTM) |
|---------|---------------------|---------|--------------------------------|
| M-2A-SA | Anti-Mag. Neverust® | ★★★ | .059" X .008" 1.5mm X .2mm |



STRAIGHT MEDIUM SERRATED POINTS - SERRATED HANDLES

Length 3.38" (85mm)

| Part# | Material | Quality | Critical Tip Measurement (CTM) |
|----------|---------------------|---------|--------------------------------|
| M-00D | Carbon Steel | ★★★ | .013" X .004" .33mm X .1mm |
| M-00D-SA | Anti-Mag. Neverust® | ★★★ | .013" X .004" .33mm X .1mm |



STRAIGHT MEDIUM POINTS - SERRATED HANDLES

Length 3.38" (85mm)

| Part# | Material | Quality | Critical Tip Measurement (CTM) |
|-------|--------------|---------|--------------------------------|
| M-AC | Carbon Steel | ★★★ | .015" X .008" .38mm X .2mm |



STRAIGHT STRONG POINTS

Length 3.5" (90mm)

| Part# | Material | Quality | Critical Tip Measurement (CTM) |
|--------|---------------------|---------|--------------------------------|
| M-H-S | Stainless Steel | ★★★ | .012" X .004" .3mm X .1mm |
| M-H-SA | Anti-Mag. Neverust® | ★★★ | .012" X .004" .3mm X .1mm |



STRAIGHT TAPERED VERY FINE REPLACEABLE POINTS

Length 3.13" (78mm)

| Part# | Material | Quality | Critical Tip Measurement (CTM) |
|-----------|-----------|---------|--------------------------------|
| M-179A-RT | Copolymer | ★★★★ | .025" X .025" .63mm X .63mm |

*Replacement tip 179A-RTX





CLEANROOM

Ergo-Tweeze

Our **CLEANROOM SAFE ERGONOMIC** tweezer grips are a cut above the rest. They are made of thermoplastic Vulcanizate (TPV) and will not particulate.

- *Recommended for controlled environments
- *ESD Safe (10^8 - 10^9 ohms/sq)
- *Protects from heat traveling up the tweezer
- *Adds comfort when using for prolonged periods



PRECISION

EXTREME

ERGO-TWEEZE®

CLEANROOM SAFE



These CLEANROOM SAFE ergonomic tweezers are made of thermoplastic Vulcanizate (TPV). They are ideal for controlled environments (cleanrooms) and are ESD Safe (10⁸-10⁹ ohms/sq).

TAPERED TIPS WITH EXTRA FINE POINTS

LENGTH 4.45" (111mm)

| Part# | Material | Quality | Critical Tip Measurement (CTM) |
|--------|---------------------|---------|--------------------------------|
| 5-SA-R | Anti-Mag. Neverust® | ★★★★ | .005" X .002" .125mm X .05mm |



STRAIGHT TIPS WITH FINE POINTS

LENGTH 4.5" (112mm)

| Part# | Material | Quality | Critical Tip Measurement (CTM) |
|---------|---------------------|---------|--------------------------------|
| 3C-SA-R | Anti-Mag. Neverust® | ★★★★ | .007" X .002" .17mm X .05mm |



45° CURVED TIPS WITH VERY FINE POINTS

LENGTH 4.75" (118mm)

| Part# | Material | Quality | Critical Tip Measurement (CTM) |
|--------|---------------------|---------|--------------------------------|
| 7-SA-R | Anti-Mag. Neverust® | ★★★★ | .007" X .002" .17mm X .05mm |



TAPERED TIPS WITH FLAT ROUND POINTS

LENGTH 4.75" (118mm)

| Part# | Material | Quality | Critical Tip Measurement (CTM) |
|---------|---------------------|---------|--------------------------------|
| 2A-SA-R | Anti-Mag. Neverust® | ★★★★ | .06" X .01" 1.5mm X .25mm |



STRAIGHT STRONG POINTS

LENGTH 4.75" (118mm)

| Part# | Material | Quality | Critical Tip Measurement (CTM) |
|---------|---------------------|---------|--------------------------------|
| 00-SA-R | Anti-Mag. Neverust® | ★★★★ | .02" X .005" .5mm X .29mm |



ERGO-TWEEZE® TWEEZERS

ERGO-TWEEZE® TWEEZERS

Our ERGONOMIC tweezer grips are a cut above the rest. These grips can be put on most metal tweezers.

- *ESD Safe (10^{10} ohms/sq)
- *Protects from heat traveling up the tweezer
- *Adds comfort when using for prolonged periods



ULTRA
HIGH
FINE

ERGO-TWEEZE®

ERGONOMIC TWEEZERS



Ergonomic handles protect the operator from heat, offer comfort and are ESD safe (10¹⁰ ohms/sq)

STRAIGHT TAPERED HIGH PRECISION POINTS

Length 4.75" (119mm)

| Part# | Material | Quality | Critical Tip Measurement (CTM) |
|------------|---------------------|---------|--------------------------------|
| 5-CO-ET | Cobalt Alloy | ★★★★★ | .002" X .0004" .05mm X .01mm |
| 5-S-ET | Stainless Steel | ★★★★ | .004" X .002" .1mm X .05mm |
| 5-SA-ET | Anti-Mag. Neverust® | ★★★ | .004" X .002" .1mm X .05mm |
| 5-SA-PI-ET | Anti-Mag. SS | ★★ | |



STRAIGHT TAPERED HIGH PRECISION POINTS

Length 4.75" (119mm)

| Part# | Material | Quality | Critical Tip Measurement (CTM) |
|---------|---------------------|---------|--------------------------------|
| 4-SA-ET | Anti-Mag. Neverust® | ★★★ | .005" X .003" .13mm X .08mm |



STRAIGHT TAPERED VERY FINE POINTS

Length 5.25" (131mm)

| Part# | Material | Quality | Critical Tip Measurement (CTM) |
|---------|---------------------|---------|--------------------------------|
| 2-SA-ET | Anti-Mag. Neverust® | ★★★ | .013" X .006" .33mm X .14mm |



STRAIGHT VERY FINE POINTS

Length 5" (125mm)

| Part# | Material | Quality | Critical Tip Measurement (CTM) |
|---------|---------------------|---------|--------------------------------|
| 1-SA-ET | Anti-Mag. Neverust® | ★★★ | .008" X .005" .2mm X .12mm |



ERGO-TWEEZE®

ERGONOMIC TWEEZERS

ULTRA
HIGH
FINE
GENERAL

PRECISION



Ergonomic handles protect the operator from heat, offer comfort and are ESD safe (10¹⁰ ohms/sq).

STRAIGHT VERY FINE POINTS

Length 4.75" (119mm)

| Part# | Material | Quality | Critical Tip Measurement (CTM) |
|-------------|---------------------|---------|--------------------------------|
| 3C-CO-ET | Cobalt Alloy | ★★★★★ | .0031" X .0016" .08mm X .04mm |
| 3C-SA-ET | Anti-Mag. Neverust® | ★★★★ | .0070" X .0040" .17mm X .10mm |
| 3C-SA-PI-ET | Anti-Mag. SS | ★★★ | |
| 3C-SA-SE-ET | Anti-Mag. SS | ★ | |



STRAIGHT VERY FINE POINTS

Length 5.25" (131mm)

| Part# | Material | Quality | Critical Tip Measurement (CTM) |
|------------|---------------------|---------|--------------------------------|
| 3-CO-ET | Cobalt Alloy | ★★★★★ | .0031" X .0016" .08mm X .04mm |
| 3-SA-ET | Anti-Mag. Neverust® | ★★★★ | .0070" X .0040" .17mm X .10mm |
| 3-SA-PI-ET | Anti-Mag. SS | ★★★ | |



LONG STRAIGHT VERY FINE POINTS

Length 6" (152mm)

| Part# | Material | Quality | Critical Tip Measurement (CTM) |
|----------|---------------------|---------|--------------------------------|
| SS-SA-ET | Anti-Mag. Neverust® | ★★★ | .008" X .005" .2mm X .12mm |





PRECISION

HIGH FINE

ERGO-TWEEZE® ERGONOMIC TWEEZERS



Ergonomic handles protect the operator from heat, offer comfort and are ESD safe (10¹⁰ ohms/sq).

STRAIGHT STRONG FINE POINTS

Length 5.5" (138mm)

| Part# | Material | Quality | Critical Tip Measurement (CTM) |
|-------------|---------------------|---------|--------------------------------|
| AA-SA-ET | Anti-Mag. Neverust® | ★★★ | .008" X .008" .2mm X .2mm |
| AA-SA-PI-ET | Anti-Mag. SS | ★★ | |



STRAIGHT STRONG MEDIUM POINTS

Length 5" (125mm)

| Part# | Material | Quality | Critical Tip Measurement (CTM) |
|-------------|---------------------|---------|--------------------------------|
| 00-SA-ET | Anti-Mag. Neverust® | ★★★ | .018" X .010" .45mm X .25mm |
| 00-SA-PI-ET | Anti-Mag. SS | ★★ | |



STRAIGHT STRONG MEDIUM SERRATED POINTS

Length 5" (125mm)

| Part# | Material | Quality | Critical Tip Measurement (CTM) |
|--------------|---------------------|---------|--------------------------------|
| 00D-SA-ET | Anti-Mag. Neverust® | ★★★ | .018" X .010" .45mm X .25mm |
| 00D-SA-PI-ET | Anti-Mag. SS | ★★ | |

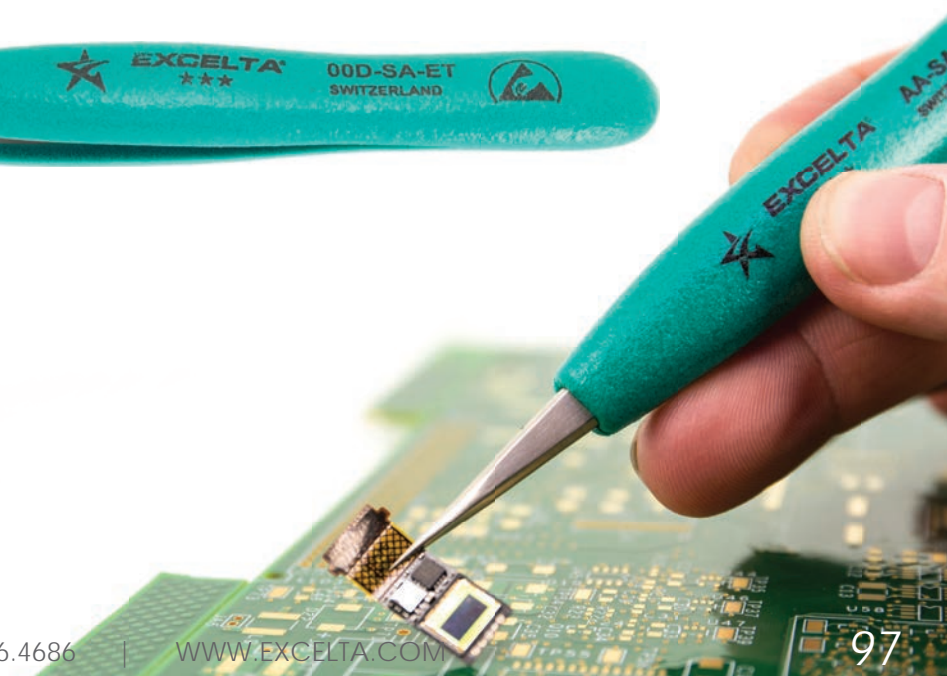

ERGO-TWEEZE®

ERGONOMIC TWEEZERS

ULTRA
HIGH
FINE

PRECISION

★★★★★
★★★★★
★★★

Ergonomic handles protect the operator from heat, offer comfort and are ESD safe (10¹⁰ ohms/sq).

45° CURVED VERY FINE POINTS

Length 5" (125mm)

| Part# | Material | Quality | Critical Tip Measurement (CTM) |
|------------|---------------------|---------|--------------------------------|
| 7-CO-ET | Cobalt Alloy | ★★★★★ | .0027" X .0012" .07mm X .03mm |
| 7-SA-ET | Anti-Mag. Neverust® | ★★★★ | .0070" X .0040" .17mm X .10mm |
| 7-SA-PI-ET | Anti-Mag. SS | ★★★ | |



10° OFFSET VERY FINE POINTS

Length 5" (125mm)

| Part# | Material | Quality | Critical Tip Measurement (CTM) |
|-------------|---------------------|---------|--------------------------------|
| 5A-SA-ET | Anti-Mag. Neverust® | ★★★ | .005" X .003" .13mm X .08mm |
| 5A-SA-PI-ET | Anti-Mag. SS | ★★ | |



45° BENT VERY FINE POINTS

Length 4.75" (119mm)

| Part# | Material | Quality | Critical Tip Measurement (CTM) |
|-------------|---------------------|---------|--------------------------------|
| 5B-SA-ET | Anti-Mag. Neverust® | ★★★ | .004" X .002" .1mm X .05mm |
| 5B-SA-PI-ET | Anti-Mag. SS | ★★ | |





ULTRA
HIGH
FINE

ERGO-TWEEZE®

ERGONOMIC TWEEZERS



Ergonomic handles protect the operator from heat, offer comfort and are ESD safe (10¹⁰ ohms/sq).

45° OBLIQUE WITH VERY FINE POINTS

Length 5" (125mm)

| Part# | Material | Quality | Critical Tip Measurement (CTM) |
|-------------|--------------|---------|--------------------------------|
| 51-CO-ET | Cobalt Alloy | ★★★★★ | .0020" X .0004" .05mm X .01mm |
| 51-SA-PI-ET | Anti-Mag. SS | ★★ | |



70° ANGLED WITH FLAT SHARP POINTS

Length 5" (125mm)

| Part# | Material | Quality | Critical Tip Measurement (CTM) |
|------------|---------------------|---------|--------------------------------|
| 6-SA-ET | Anti-Mag. Neverust® | ★★★ | .007" X .004" .17mm X .1mm |
| 6-SA-PI-ET | Anti-Mag. SS | ★★ | |



STRAIGHT TAPERED WITH FLAT ROUND POINTS

Length 5.25" (131mm)

| Part# | Material | Quality | Critical Tip Measurement (CTM) |
|-------------|---------------------|---------|--------------------------------|
| 2A-SA-ET | Anti-Mag. Neverust® | ★★★ | .059" X .008" 1.5mm X .2mm |
| 2A-SA-PI-ET | Anti-Mag. SS | ★★ | |



SMALL PARTS HANDLING TWEEZERS

SMALL PARTS HANDLING

These tweezers were developed to handle very small wires and parts. Each has its own unique characteristics.



PRECISION HIGH

PADDLE TIPPED TWEEZERS



These tweezers are specifically designed to handle surface mount components. They are also ideal for handling very small rectangular items. The paddles add more 'surface contact' for greater control. By design, the tips are much more robust than a pointed tweezer, hence a longer life.

ANGULATED - ANTI-CRUSH DEVICE

Length 4.5" (115mm)

102A-SA

The wider point is designed for easy manipulation of most chips and miniature components. Anti-crush device has been added to reduce chip breakage. They are made of Anti-Magnetic Neverust® Stainless Steel.

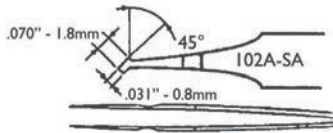

CURVED

Length 4.25" (110mm)

103-SA (.060" x .024" Paddle)

123-SA (.028" x .020" Paddle)

The angled tips are very helpful for placing many types of S.M.D. resistors and capacitors. They are made of Anti-Magnetic neverust Stainless Steel (AISI 316L).

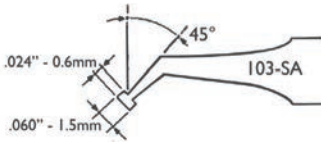

OFF-SET

Length 4.5" (115mm)

104-SA

The wider paddle points provide perfect control when manipulating and placing SOT-89 transistors and monolithic chip capacitors. It is made of Anti-Magnetic Neverust® Stainless Steel.

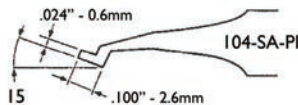

ANGLED

Length 4.5" (115mm)

109-SA

The small points are set at a 45° angle for working in dense areas. They are made of Anti-Magnetic Stainless Steel (AISI 316L).

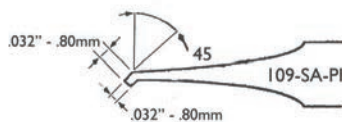

S.M.D. HANDLING TWEEZERS

HIGH
PRECISION ★★★

The following tweezers have small grooves or holes in the tips for handling small wires.

TRANSVERSE

Length 4.25" (110mm)

110-SA ★★★

The small groove on the inside of the points provides better control when placing small parts and wires. It is made of Anti-Magnetic Neverust® Stainless Steel.

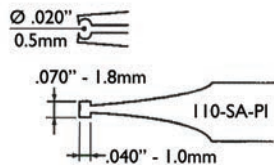

STRAIGHT

Length 5.5" (140mm)

121-SA ★★★

The thin flat tips are cut at an angle making this tweezers ideal for picking parts from a Gel Pak. It is made of Anti-Magnetic Neverust® Stainless Steel.

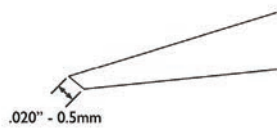

CURVED

Length 4.25" (110mm)

111-SA ★★★

The angle of the tips and the small .02" (.5mm) hole will firmly hold many types of SMD components. It is made of Anti-Magnetic Neverust® Stainless Steel.

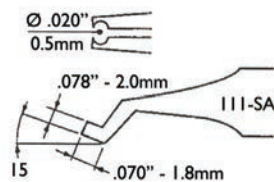

CURVED

Length 4.25" (110mm)

115-SA ★★★

The .02" (.5mm) groove on the inside of the tip is designed on an angle for holding and placing cylindrical devices. It is made of Anti-Magnetic Neverust® Stainless Steel.

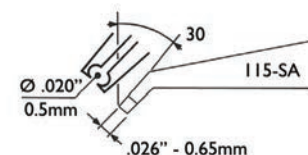



PRECISION HIGH

S.M.D. HANDLING TWEEZERS



The following tweezers have grooved tips or holes in the tips for handling small wires or cylindrical devices or, tips that meet in a parallel fashion. While they were designed for surface mount applications, they may be uniquely qualified to handle a variety of tasks where small items are being handled.

STRAIGHT

Length 4.25" (110mm)

116-SA ★★★

The tips have a .04" (1mm) groove for handling small cylindrical devices. It is made of Anti-Magnetic Neverust® Stainless Steel.

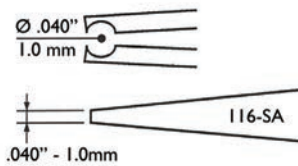

BENT TIP

Length 4.25" (110mm)

125-SA ★★★

The tips have a .02" (.5mm) slot in the end which is great for picking and placing of 402 resistors. It is made of Anti-Magnetic Neverust® Stainless Steel.

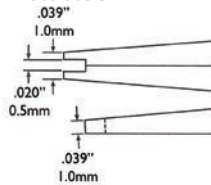

STRAIGHT TIP

Length 4.5" (115mm)

122-SA ★★★

The strong flat tips will firmly hold components when desoldering. It is made of Anti-Magnetic Neverust® Stainless Steel.

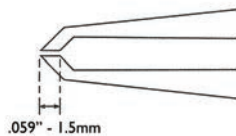

CURVED TIP

Length 4.25" (110mm)

124-SA ★★★

The unique shape tips are helpful in placing SOT-23 and TO-236 packages. It is made of Anti-Magnetic Neverust® Stainless Steel.

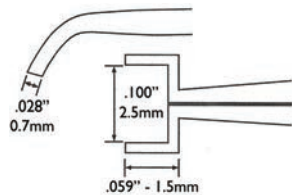

STRAIGHT TIP

Length 4.25" (110mm)

126-SA ★★★

The fine tip and parallel closing jaws are very useful for routing jumper wires on PC boards. It is made of Anti-Magnetic Neverust® Stainless Steel.

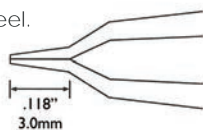

SMALL PARTS HANDLING TWEEZERS

ULTRA
HIGH
GENERAL

PRECISION



These tweezers have been developed to handle very specific tasks. It is important to note we encourage the tip dimensions to fit your exact application.

FOR HOLDING CYLINDRICAL PARTS

Length 4.5" (115mm)

815-SA-SE ★

This tweezers can handle many types of round components and electronic devices. The inside hole diameter is .060" (1.5mm). It is made of Anti-Magnetic Stainless Steel.



FOR HOLDING CYLINDRICAL PARTS

Length 4.5" (115mm)

815B-SA-SE ★

This tweezers can handle many types of round components and electronic devices. The inside hole diameter is .060" (1.5mm). The 45° offset tip is great for confined areas. It is made of Anti-Magnetic Stainless Steel.



FOR HOLDING SMALL WIRES

Length 4.25" (110mm)

40-S ★★★

This tweezers was specifically made to hold very small wires via the .015" (.38mm) diameter hole near the tips. It is made of Stainless Steel.



FOR HOLDING SMALL WIRES

Length 5" (127mm)

116-CF ★★★★★

This straight Carbon Fiber tipped tweezers features a .039" (1mm) hole in the tips. This tool is ideal for handling delicate wires and small screws. The body is made of stainless steel. The tips are conductive (10² ohms/sq). **Replacement tips - 116-CF-RTX**



FOR HOLDING SMALL SCREWS

Length 6.5" (165mm)

31B-SA-SE ★

The special grooves in the tips hold small screws. It is ideal for 'starting' the screws. Also useful when working in dense and hard to reach areas. It is made of Anti-Magnetic Stainless Steel.



WAFER HANDLING TWEEZERS



WAFER HANDLING

These tweezers are ideal for handling very thin wafers up to and exceeding 8" in diameter. The large, thin, flat tips easily slip under and securely hold the wafers. They also feature a special engaging slot, which facilitates handling. Each wafer tweezer is available in a variety of head styles and made of anti-magnetic Stainless Steel.

WAFER HANDLING TWEEZERS

FINE
PRECISION ★★

Our Wafer Handling Tweezers include a special engaging slot for easy handling of wafers.

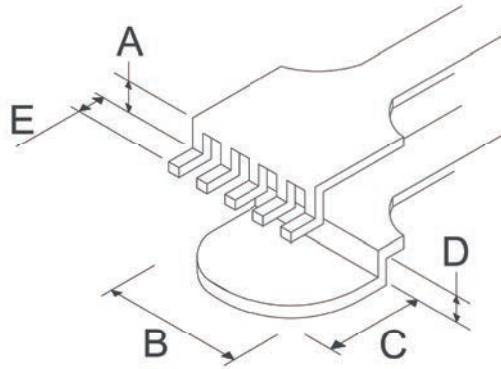

3" WAFER HANDLING TWEEZERS

Length 4.75" (119mm)



390-SA-PI ★★

A. .157" (4mm)
B. .257" (6.5mm)
C. .197" (5mm)
D. .138" (3.5mm)

390L-SA-PI ★★

A. .157" (4.0mm)
B. .257" (6.5mm)
C. .197" (5.0mm)
D. .138" (3.5mm)
E. .060" (1.5mm)

390T-SA-PI ★★

A. .285" (7.2mm)
B. .257" (6.5mm)
C. .197" (5.0mm)
D. .138" (3.5mm)

391-SA-PI ★★

A. .157" (4.0mm)
B. .257" (6.5mm)
C. .197" (5.0mm)
D. .138" (3.5mm)
E. .060" (1.5mm)

391P-SA-PI ★★

A. .157" (4.0mm)
B. .257" (6.5mm)
C. .197" (5.0mm)
D. .138" (3.5mm)
E. .060" (1.5mm)

4" WAFER HANDLING TWEEZERS

Length 5" (125mm)



490-SA-PI ★★

A. .157" (4.0mm)
B. .472" (12mm)
C. .275" (7.0mm)
D. .125" (3.1mm)

490L-SA-PI ★★

A. .157" (4.0mm)
B. .472" (12mm)
C. .275" (7.0mm)
D. .138" (3.5mm)
E. .125" (3.1mm)

490T-SA-PI ★★

A. .157" (4.0mm)
B. .472" (12mm)
C. .275" (7.0mm)
D. .138" (3.5mm)

491-SA-PI ★★

A. .157" (4.0mm)
B. .472" (12mm)
C. .275" (7.0mm)
D. .138" (3.5mm)
E. .125" (3.1mm)

491D-SA-PI ★★

A. .157" (4mm)
B. .472" (12mm)
C. .275" (7mm)
D. .138" (3.5mm)
E. .125" (3.1mm)

491P-SA-PI ★★

A. .157" (4.0mm)
B. .472" (12mm)
C. .275" (7.0mm)
D. .138" (3.5mm)
E. .125" (3.1mm)



*Add a 'B' to any model for a 20° bend in the body to improve handling



PRECISION

HIGH FINE

WAFER HANDLING TWEEZERS



Made from Anti-magnetic Stainless Steel.

5" WAFER HANDLING TWEEZERS

Length 5" (125mm)



590-SA-PI ★★

- A. .157" (4.0mm)
- B. .638" (16.2mm)
- C. .355" (9.0mm)
- D. .106" (2.7mm)

590L-SA-PI ★★

- A. .180" (4.5mm)
- B. .638" (16.2mm)
- C. .355" (9.0mm)
- D. .106" (2.7mm)
- E. .125" (3.1mm)

590T-SA-PI ★★

- A. .257" (6.5mm)
- B. .638" (16.2mm)
- C. .355" (9.0mm)
- D. .106" (2.7mm)

591-SA-PI ★★

- A. .157" (4.0mm)
- B. .638" (16.2mm)
- C. .355" (9.0mm)
- D. .106" (2.7mm)
- E. .125" (3.1mm)

591D-SA-PI ★★

- A. .157" (4.0mm)
- B. .638" (16.2mm)
- C. .355" (9.0mm)
- D. .106" (2.7mm)
- E. .125" (3.1mm)

591P-SA-PI ★★

- A. .157" (4.0mm)
- B. .638" (16.2mm)
- C. .355" (9.0mm)
- D. .106" (2.7mm)
- E. .125" (3.1mm)

6" WAFER HANDLING TWEEZERS

Length 5" (125mm)



690-SA-PI ★★

- A. .150" (3.8mm)
- B. .780" (19.8mm)
- C. .355" (9.0mm)
- D. .106" (2.7mm)

690L-SA-PI ★★

- A. .140" (3.5mm)
- B. .780" (19.8mm)
- C. .355" (9.0mm)
- D. .106" (2.7mm)
- E. .125" (3.1mm)

690T-SA-PI ★★

- A. .257" (6.5mm)
- B. .780" (19.8mm)
- C. .355" (9.0mm)
- D. .106" (2.7mm)

691-SA-PI ★★

- A. .118" (3.0mm)
- B. .780" (19.8mm)
- C. .355" (9.0mm)
- D. .106" (2.7mm)
- E. .125" (3.1mm)

691D-SA-PI ★★

- A. .118" (3.0mm)
- B. .780" (19.8mm)
- C. .355" (9.0mm)
- D. .106" (2.7mm)
- E. .125" (3.1mm)

691P-SA-PI ★★

- A. .118" (3.0mm)
- B. .780" (19.8mm)
- C. .355" (9.0mm)
- D. .106" (2.7mm)
- E. .125" (3.1mm)

8" WAFER HANDLING TWEEZERS

Length 5" (125mm)



891-SA ★★★

- A. .150" (3.8mm)
- B. 1.12" (28.5mm)
- C. .450" (11.5mm)
- D. .100" (2.15mm)

890L-SA ★★★

- A. .150" (3.8mm)
- B. 1.12" (28.5mm)
- C. .450" (11.5mm)
- D. .100" (2.15mm)



*Add a 'B' to any model for a 20° bend in the body to improve handling

REPLACEABLE TIP TWEEZERS

REPLACEABLE TIP TWEEZERS

Replaceable Tip Tweezers are offered in a variety of different tip materials. The frames are made of stainless steel and are anti-magnetic.

Page 109 Peek - for high temperature - non-scratching or marring
Page 110 Copolymer - cleanroom safe - non-scratching or marring
Page 111 Carbofib® - conducive - non-scratching or marring
Page 113/114 Acetal - very soft - non-scratching or marring





PRECISION

ULTRA

PEEK REPLACEABLE TIP TWEEZERS



These tweezers are constructed from a Neverust® stainless steel anti-magnetic frame and feature PEEK tips. PEEK is a high temperature thermoplastic with excellent chemical resistance. Inert to all common solvents, it resists a wide range of inorganic liquids. These tools have a working temperature of 249°C (480°F). Peek is static dissipative (10⁷ ohms/sq). Peek tweezers are designed for safe handling of delicate parts and feature finger serrations for more control.

STRAIGHT POINTS

Length 5" (125mm)

| Part# | Replacement Tip | Critical Tip Measurement (CTM) | |
|---------|-----------------|--------------------------------|-------------|
| 162A-RT | 162A-RTX | .02" X .02" | .5mm X .5mm |



STRAIGHT POINTS

Length 5" (125mm)

| Part# | Replacement Tip | Critical Tip Measurement (CTM) | |
|---------|-----------------|--------------------------------|-------------|
| 162B-RT | 162B-RTX | .03" X .03" | .7mm X .7mm |



STRAIGHT POINTS

Length 5" (125mm)

| Part# | Replacement Tip | Critical Tip Measurement (CTM) | |
|---------|-----------------|--------------------------------|-----------|
| 162C-RT | 162C-RTX | .04" X .04" | 1mm X 1mm |

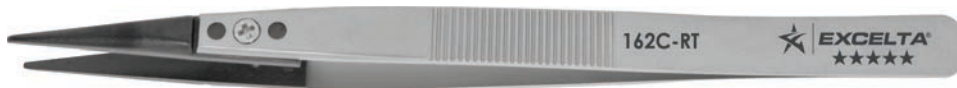

STRAIGHT POINTS

Length 5" (125mm)

| Part# | Replacement Tip | Critical Tip Measurement (CTM) | |
|---------|-----------------|--------------------------------|------------|
| 162D-RT | 162D-RTX | .08" X .016" | 2mm X .4mm |



50° CURVED POINTS

Length 5" (125mm)

| Part# | Replacement Tip | Critical Tip Measurement (CTM) | |
|---------|-----------------|--------------------------------|-------------|
| 762A-RT | 762A-RTX | .02"x.012" | .5mm X .3mm |



COPOLYMER REPLACEABLE TIP TWEEZERS

EXTREME

PRECISION



Copolymer tips are designed for handling delicate items. They are static dissipative (10^7 - 10^9 ohms/sq), temperature resistant to 90°C (195°F) and are silicon & chloride free. The frames are made of Neverust® stainless steel and are anti-magnetic. The tips are easily replaced and designed for safe handling of delicate parts in a cleanroom environment.

STRAIGHT POINTS

Length 5.125" (128mm)

| Part# | Replacement Tip | Critical Tip Measurement (CTM) | |
|---------|-----------------|--------------------------------|--------------|
| 179A-RT | 179A-RTX | .02" X .01" | .5mm X .25mm |



STRAIGHT POINTS

Length 5.125" (128mm)

| Part# | Replacement Tip | Critical Tip Measurement (CTM) | |
|---------|-----------------|--------------------------------|--------------|
| 179D-RT | 179D-RTX | .08" X .25" | 2mm X 6.25mm |



REVERSE ACTION STRAIGHT POINTS

Length 5.5" (138mm)

| Part# | Replacement Tip | Critical Tip Measurement (CTM) | |
|----------|-----------------|--------------------------------|--------------|
| 179DN-RT | 179D-RTX | .08" X .25" | 2mm X 6.25mm |

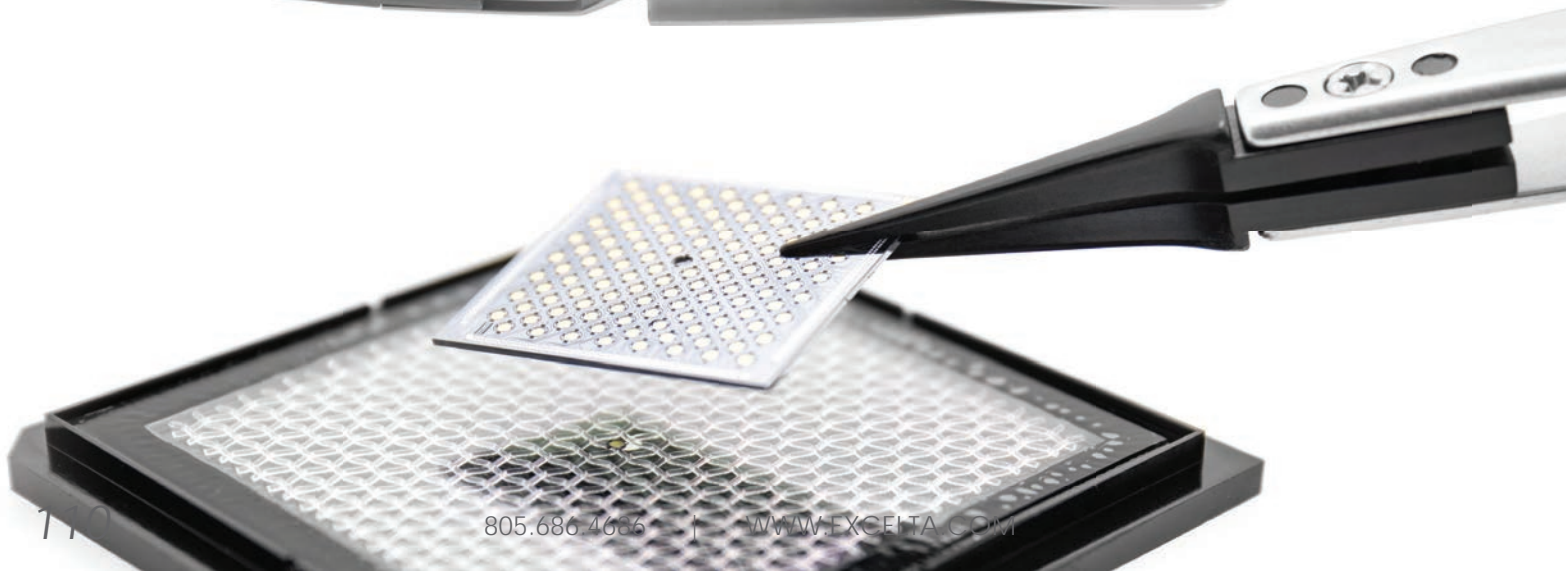



PRECISION

HIGH

CARBOFIB® REPLACEABLE TIP TWEEZERS



Carbofib® is a PTFE base material with 30% carbon fibers added. Carbofib is conductive with a surface resistivity of 10^2 ohms/sq., and temperature resistant up to 121°C (249°F).

STRAIGHT TAPERED POINTS

Length 5" (125mm)

| Part# | Replacement Tip | Critical Tip Measurement (CTM) |
|---------|-----------------|--------------------------------|
| 159-RT | 159-RTX | .012" X .008" .3mm X .2mm |
| 159G-RT | 159G-RTX | .005" X .025" .125mm X .625mm |

*Cross-Action version - 159-RTN
Ergo Version - 159-RT-ET



STRAIGHT POINTS

Length 5" (125mm)

| Part# | Replacement Tip | Critical Tip Measurement (CTM) |
|---------|-----------------|--------------------------------|
| 159A-RT | 159A-RTX | .02" X .015" .5mm X .38mm |



STRAIGHT POINTS

Length 5" (125mm)

| Part# | Replacement Tip | Critical Tip Measurement (CTM) |
|---------|-----------------|--------------------------------|
| 159B-RT | 159B-RTX | .04" X .038" 1mm X .95mm |



51° CURVED POINTS

Length 5" (125mm)

| Part# | Replacement Tip | Critical Tip Measurement (CTM) |
|--------|-----------------|--------------------------------|
| 759-RT | 759-RTX | .012" X .025" .3mm X .63mm |

*Cross-Action version - 759-RTN



CARBOFIB® REPLACEABLE TIP TWEEZERS

HIGH
PRECISION ★★★

These frames are made of Neverust® stainless steel and are anti-magnetic. The tips are easily replaced and are designed for safe handling of delicate parts.

STRAIGHT POINTS

Length 5" (125mm)

| Part# | Replacement Tip | Critical Tip Measurement (CTM) | |
|---------|----------------------------------|--------------------------------|---------------|
| 159D-RT | 159D-RTX | .06" X .015" | 1.5mm X .38mm |
| | *Cross-Action version - 159D-RTN | | |



STRAIGHT POINTS

Length 5" (125mm)

| Part# | Replacement Tip | Critical Tip Measurement (CTM) | |
|---------|-----------------|--------------------------------|---------------|
| 159C-RT | 159C-RTX | .08" X .055" | .2mm X 1.38mm |
| 159F-RT | 159F-RTX | .08" X .05" | .2mm X 1.25mm |



STRAIGHT POINTS

Length 5" (125mm)

| Part# | Replacement Tip | Critical Tip Measurement (CTM) | |
|---------|-----------------|--------------------------------|-------------|
| 159E-RT | 159E-RTX | .12" X .038" | 3mm X .95mm |



40° CURVED POINTS

Length 5" (125mm)

| Part# | Replacement Tip | Critical Tip Measurement (CTM) | |
|---------|-----------------|--------------------------------|---------------|
| 759D-RT | 759D-RTX | .06" X .018" | 1.5mm X .45mm |





PRECISION HIGH

REPLACEABLE TIP MINIATURE TWEEZERS



These frames are made of Neverust stainless steel and are anti-magnetic. The tips are easily replaced and designed for safe handling of delicate parts. The miniature size makes them ideal for use under magnification.

- CARBOFIB™ TIPS - Conductive (10² Ohms/Sq)
- ACETAL TIPS - Cleanroom Safe (Insulative)

CARBOFIB™ TIPS (10² Ohms/Sq)

Length 4.45" (111.25mm)

| Part # | Style | Critical Tip Measurement (CTM) | | Replacement Tip |
|-----------|------------|--------------------------------|-----------------|-----------------|
| M-159G-RT | Straight | .005" x .025" | .125mm x .625mm | 159G-RTX |
| M-159-RT | Straight | .012" x .008" | .3mm x .2mm | 159-RTX |
| M-159A-RT | Straight | .02" x .015" | .5mm x .38mm | 159A-RTX |
| M-159B-RT | Straight | .04" x .038" | 1mm x .95mm | 159B-RTX |
| M-159D-RT | Straight | .06" x .015" | 1.5mm x .38mm | 159D-RTX |
| M-159F-RT | Straight | .08" x .05" | 2mm x 1.25mm | 159F-RTX |
| M-159C-RT | Straight | .08" x .055" | 2mm x 1.38mm | 159C-RTX |
| M-159E-RT | Straight | .12" x .038" | 3mm x .95mm | 159E-RTX |
| M-759D-RT | 40° Curved | .06" x .015" | 1.5mm x .38mm | 759D-RTX |



ACETAL TIPS (Insulative)

Length 4.45" (111.25mm)

| Part # | Style | Critical Tip Measurement (CTM) | | Replacement Tip |
|------------|------------|--------------------------------|-----------------|-----------------|
| M-159B-RTW | Straight | .04" x .038" | 1mm x .95mm | 159B-RTWX |
| M-159D-RTW | Straight | .06" x .015" | 1.5mm x .38mm | 159D-RTWX |
| M-159C-RTW | Straight | .08" x .055" | 2mm x 1.38mm | 159C-RTWX |
| M-759-RTW | 40° Curved | .005" x .025" | .125mm x .625mm | 759-RTWX |
| M-759D-RTW | 40° Curved | .06" x .015" | 1.5mm x .38mm | 759D-RTWX |



ACETAL REPLACEABLE TIP TWEEZERS

HIGH

PRECISION



Acetal replaceable tip tweezers are electrically insulative and resistant to temperatures up to 85°C (185°F). The frame is anti-magnetic stainless steel and excellent for cleanroom applications.

STRAIGHT POINTS

Length 5" (125mm)

| Part# | Replacement Tip | Critical Tip Measurement (CTM) | |
|----------|-----------------|--------------------------------|-------------|
| 159B-RTW | 159B-RTWX | .04" X .038" | 1mm X .95mm |



STRAIGHT POINTS

Length 5" (125mm)

| Part# | Replacement Tip | Critical Tip Measurement (CTM) | |
|----------|-----------------|--------------------------------|---------------|
| 159D-RTW | 159D-RTWX | .06" X .015" | 1.5mm X .38mm |



STRAIGHT POINTS

Length 5" (125mm)

| Part# | Replacement Tip | Critical Tip Measurement (CTM) | |
|----------|-----------------|--------------------------------|---------------|
| 159C-RTW | 159C-RTWX | .08" X .055" | .2mm X 1.38mm |

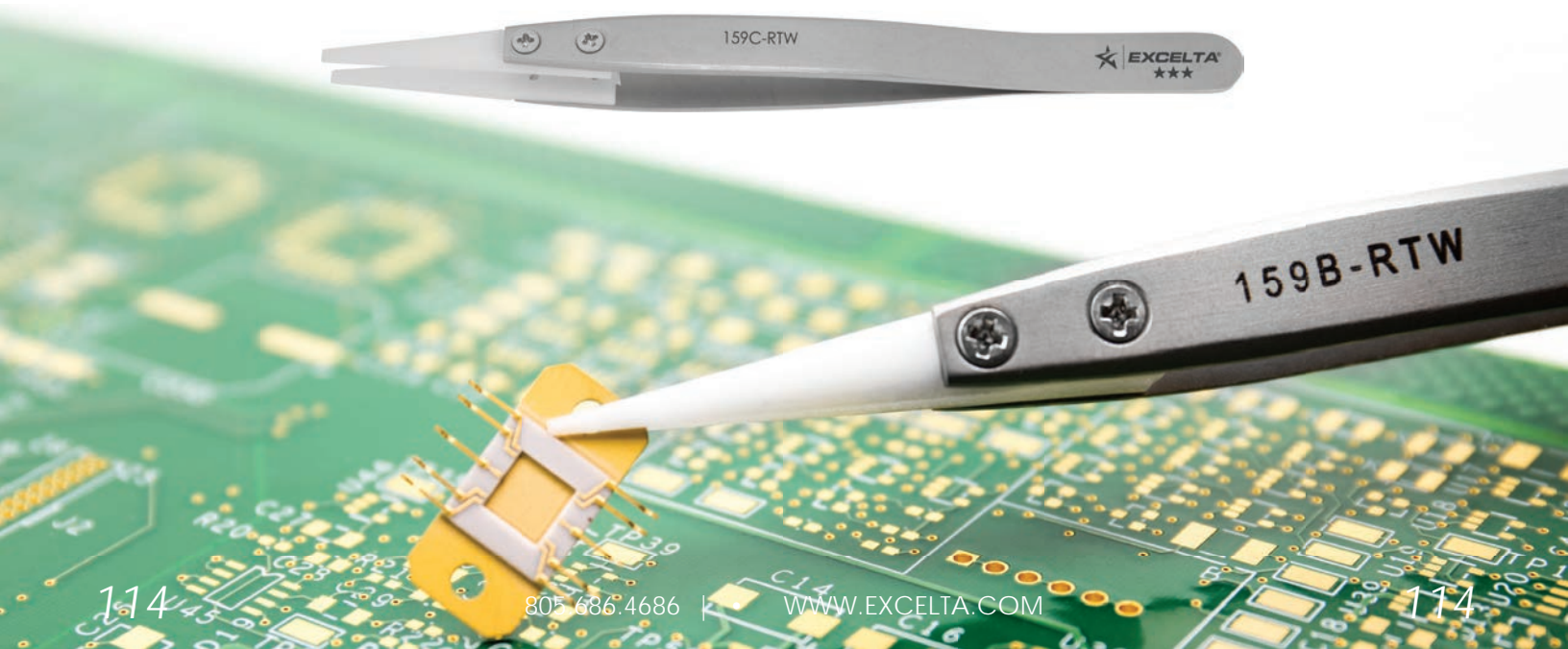



PRECISION

ULTRA FINE

CERAMIC TIP TWEEZERS



These Zirconia ceramic tipped tweezers are ideal for high temperature applications as they withstand up to 2000°F. Solder will not adhere to them. They are cleanroom safe.
These items do not have replaceable tips.

STRAIGHT TIPS WITH FINE POINTS

LENGTH 5" (125mm)

| Part# | Material | Quality | Critical Tip Measurement (CTM) | |
|--------|--------------|---------|--------------------------------|-------|
| 277-CE | Anti-Mag. SS | ★★★★★ | .04" | 1.0mm |



TAPERED TIPS WITH FLAT ROUND POINTS

LENGTH 5.5" (137.5mm)

| Part# | Material | Quality | Critical Tip Measurement (CTM) | |
|-----------|--------------|---------|--------------------------------|-------|
| 277-CE-ET | Anti-Mag. SS | ★★★★★ | .04" | 1.0mm |



STRAIGHT TIPS WITH FINE POINTS

LENGTH 5" (125mm)

| Part# | Material | Quality | Critical Tip Measurement (CTM) | |
|---------|--------------|---------|--------------------------------|--------|
| 149B-CE | Anti-Mag. SS | ★★ | .030" | 0.75mm |



45° ANGLED TIPS WITH FINE POINTS

LENGTH 5" (125mm)

| Part# | Material | Quality | Critical Tip Measurement (CTM) | |
|---------|--------------|---------|--------------------------------|--------|
| 749A-CE | Anti-Mag. SS | ★★ | .020" | 0.50mm |



PLASTIC TWEEZERS

PLASTIC HANDLING TWEEZERS

Plastic tweezers are an inexpensive alternative to other types of tweezers. In addition, they will not scratch or mar delicate items.

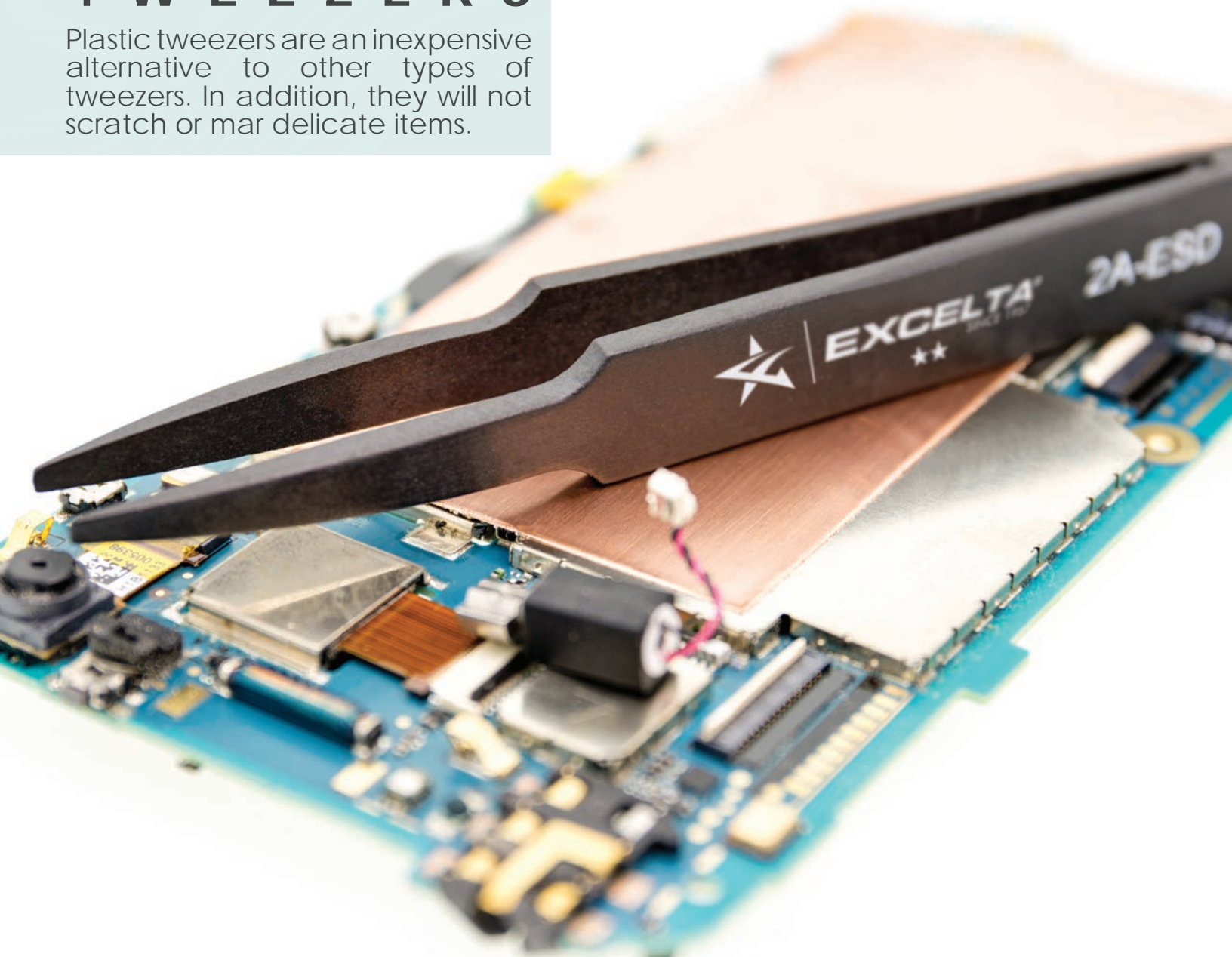



PRECISION

FINE

PLASTIC HANDLING TWEEZERS



These plastic tweezers have a temperature resistance of 100°C (212°F). Surface resistivity is 10⁵ ohms/sq. which puts them in the conductive range. They are ideally used to prevent marring or scratching of delicate parts.

STRAIGHT TAPERED FLAT ROUND POINTS

Length 4.625" (115mm)

| Part# | Critical Tip Measurement (CTM) |
|--------|--------------------------------|
| 2A-ESD | .075" X .02" 1.88mm X .5mm |



STRAIGHT FLAT POINTS

Length 4.63" (116mm)

| Part# | Critical Tip Measurement (CTM) |
|---------|--------------------------------|
| 609-ESD | .005" X .12" .13mm X 3mm |



STRAIGHT FLAT WIDE POINTS

Length 4.5" (113mm)

| Part# | Critical Tip Measurement (CTM) |
|---------|--------------------------------|
| 35A-ESD | .24" X .005" 6mm X .13mm |



STRAIGHT FINE POINTS

Length 4.5" (113mm)

| Part# | Critical Tip Measurement (CTM) |
|--------|--------------------------------|
| 3C-ESD | .025" X .025" .63mm X .63mm |



84° ANGLED BLUNT POINTS

Length 4.75" (119mm)

| Part# | Critical Tip Measurement (CTM) |
|-------|--------------------------------|
| 6-ESD | .05" X .04" 1.25mm X 1mm |



CUTTING TWEEZERS



CUTTING TWEEZERS

Cutting tweezers are used in a variety of manufacturing applications, including hearing aids, stents, pacemakers and many applications in the miniature electronics field.



PRECISION

HIGH FINE

PRECISION CUTTING TWEEZERS



The 15A-GW series angled tip cutting tweezer is ideal for general purpose cutting of soft wire up to 0.010". This tool is considered a tip cutter in that the blades meet most predominantly at the tips. All of the force applied to the tweezer gets transferred to the very tip of the tool. The exception is the 'PB' adder, featuring parallel cutting edges. The cut is 'maximum flush' which leaves a very small 'pinch' on the wire.

15A-GW

★★★

Length 4.5" (115mm)

Most common cutting tweezer design in use today. Recommended materials which this tweezer will safely cut are soft copper, gold, silver and magnet wire not larger than .010 in diameter. Flat blades. The epoxy coating is ESD safe (10⁵-10⁶ ohms/sq) and also prevents oxidation. Made in Switzerland.

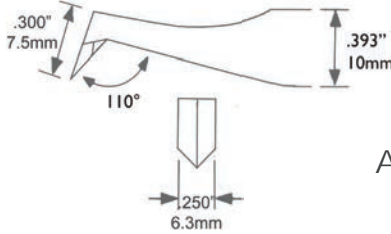

Also Available

- 15A-GW-OF - Optimum-Flush cutting blades
- 15A-GW-PB - Parallel cutting blades
- 15A-GW-M - No epoxy coating
- 15A-GW-S - Stainless Steel (no epoxy coating)
- 15A-GW-ET - With ergonomic cushion grip - Shown on pg. 121

15A-GW-PI

★★

Length 4.5" (115mm)

Same as above with a slightly larger head and face. It does not have Epoxy coating. Carbon steel with flame hardened flat blades.

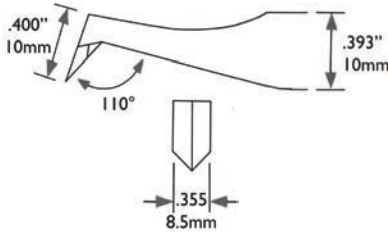

PRECISION CUTTING TWEEZERS

HIGH
PRECISION ★★ ★

The 15A-RW series angled round tip cutting tweezer is ideal for general purpose cutting of soft wire up to 0.010". The cutting blade is much shorter than the 15A-GW and the top of the head has been rounded for better visibility. The cut is 'maximum flush' which leaves a very small 'pinch' on the wire.

15A-RW

Length 4.5"(115mm)

With fine tips and smaller cutting blades, this cutting tweezer can fit into small areas other cutters cannot. Comes with Epoxy coating ESD safe (10^5 - 10^6 ohms/sq) to prevent rusting. Maximum cutting capacity 32 AWG .008 in. Made in Switzerland.

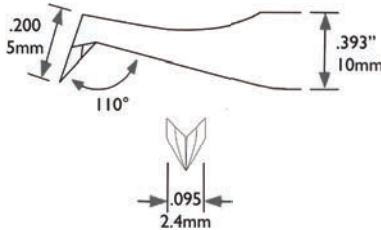

Also Available

- 15A-RW-OF - Optimum-Flush cutting blades
- 15A-RW-PB - Parallel cutting blades - Shown Below
- 15A-RW-M - No epoxy coating
- 15A-RW-S - Stainless Steel (no epoxy coating)
- 15A-RW-ET - With ergonomic cushion grip - Shown on pg. 121

15A-RW-PB

PARALLEL BLADES

Length 4.5"(115mm)

Same as above with parallel cutting blades. Carbon steel with corrosion preventing epoxy coating, ESD safe (10^5 - 10^6 ohms/sq) . Maximum cutting capacity 32 AWG .008 soft copper, gold, silver and magnet wire. Extremely useful in trimming soft silicon or plastic flashing. Made in Switzerland.

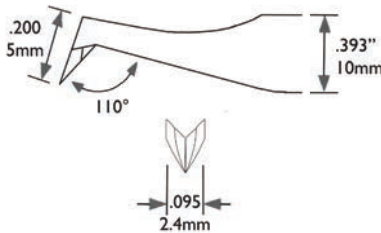



PRECISION

HIGH

PRECISION CUTTING TWEEZERS



Variations of the standard 15A-GW are shown below. The cutting capacity for these tools are .010" soft wire.

15A-SW

RADIUS FACED

Length 4.5"(115mm)

Similar to the 15A-GW with rounded blades. Designed to cut soft copper wire, gold, silver and magnet wire. Carbon Steel with corrosion preventing epoxy coating ESD safe (10⁵-10⁶ ohms/sq). Made in Switzerland.

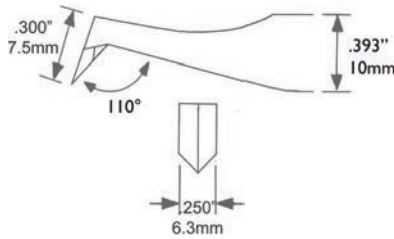

15A-C

SHORT FINE BLADE

Length 4.5"(115mm)

Very fine cutting tweezers. Can be used either vertically or horizontally. Short .275in blade. Excellent for use in difficult cutting areas. Carbon Steel with corrosion preventing epoxy coating ESD safe (10⁵-10⁶ ohms/sq). Made in Switzerland.

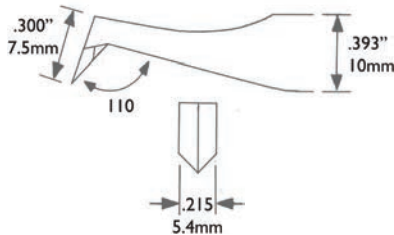

15A-RW-ET

ERGONOMIC

Length 4.5"(115mm)

Same as the 15A-RW with an added Ergonomic cushion grip designed to combat operator fatigue. Also acts as a heat shield. Made in Switzerland.

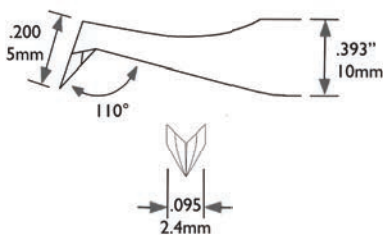

15A-GW-ET

ERGONOMIC

Length 4.5" (115mm)

Same as the 15A-GW with an added Ergonomic cushion grip designed to combat operator fatigue. Used in Electronic, Military and Biomedical assembly applications where prolonged use is required. Made in Switzerland.

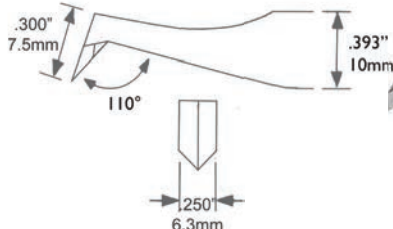

PRECISION CUTTING TWEEZERS

HIGH
PRECISION ★★★

The following tweezers are application specific and primarily used for work in a restricted area.

14A-GW

SLIM HIGH PRECISION

Length 4.38"(113mm)

Small head and 100° angle enables work to be done in confined areas and allows greater surface clearance. High Carbon steel designed to cut plastic and silicon flashing as well as soft copper wire no greater than .010. Made in Switzerland.

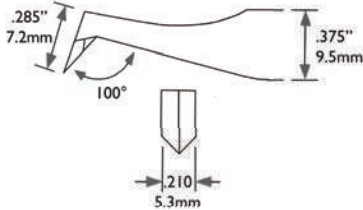

14A-N

LONG PRECISION

Length 4.5"(115mm)

Thin, fine cutting blades enables the tool to be used either vertically or horizontally. Durable carbon steel cutting edges. Maximum cutting capacity .005 Thinner blade design for lightweight and easy handling. Made in Switzerland.

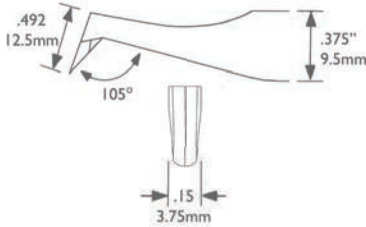

15

TRANSVERSE END

Length 4.5"(115mm)

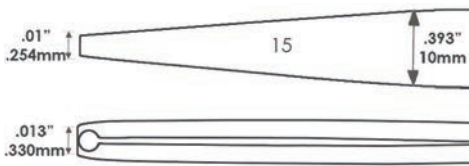



PRECISION

HIGH

PRECISION CUTTING TWEEZERS



For those applications which require work in a restricted area or under magnification, the following cutting tweezers allow the accessibility needed. The 52-MW, 53-MW and 54-MW are our smallest cutters.

52-MW

HIGH PRECISION MICRO POINTS

Length 4.5" (115mm)

Excellent for working in dense access areas. Durable carbon steel with black conductive ESD safe (10^5 - 10^6 ohms/sq) corrosion inhibitor. Cutting capacity .005 soft wire and flashings. Made in Switzerland.

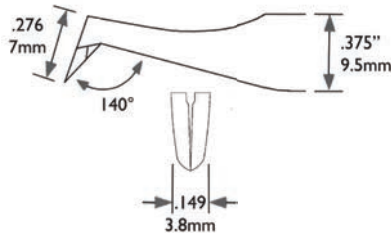

CUTTING CAPACITY .005" (.13mm)



54-MW

HIGH PRECISION MICRO ANGLED POINTS

Length 4.25" (110mm)

Designed for maximum visibility when working under magnification. Black conductive ESD safe (10^5 - 10^6 ohms/sq) corrosion inhibitor and sharp carbon steel cutting blades. Excellent for work in confined applications. Made in Switzerland.

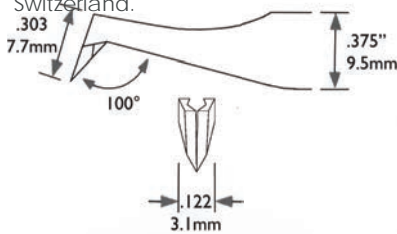

CUTTING CAPACITY .008" (.20mm)



55-MW

ULTRA FINE CUTTING BLADES

Length 4.5" (115mm)

The very finest and smallest cutting blades available. Durable carbon steel blades and black conductive ESD safe (10^5 - 10^6 ohms/sq) epoxy coating to reduce corrosion and rust. Ultra-fine point makes this cutting tweezer easily fit into areas traditional cutting tweezer cannot fit. Maximum cutting capacity .005 soft wire and flashings. Light weight and easy to manipulate. Made in Switzerland.

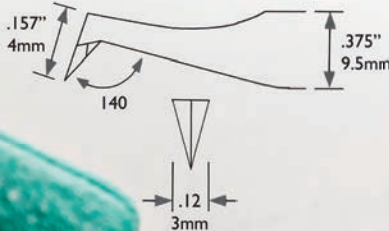

CUTTING CAPACITY .005" (.13mm)



PRECISION WIRE STRIPPING TWEEZERS

ULTRA
PRECISION ★★★★★

Unlike generic wire strippers, the following tools are 'precision' wire strippers. The 15A-ST-PE-XX and the 15A-ST-PE-XX-X tools are individually manufactured for a specific size wire.

15A-ST-PE-XX

INSULATED WIRE

Length 4.5" (115mm)

70° angulated stripping tweezer will strip PTFE and other coated wire exactly to AWG gauge without nicking. The unique 'cutting slot' prevents wire alignment issues thus accelerating the process. It is made of carbon steel with flame hardened edges and is epoxy coated to prevent oxidation. It will strip wires from 30AWG to 46AWG. Simply add the wire size to the 15A-ST-PE (i.e. 15A-ST-PE-30 for 30AWG)

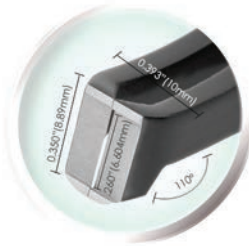

15A-ST-PE-XX-X

MAGNET WIRE

Length 4.5" (115mm)

70° angulated stripping tweezer designed to strip Magnet Wire to AWG gauge without nicking. The unique 'cutting slot' prevents wire alignment issues thus accelerating the process. It is made of carbon steel with flame hardened edges and is epoxy coated to prevent oxidation.

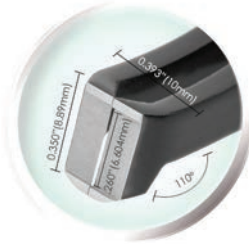

NEW
ITEM





PRECISION

ULTRA

PRECISION WIRE STRIPPING PLIERS



The 510E-US will strip from 18-30AWG wire and, unlike other strippers which can only cut two sides of the insulation, this tool cuts four sides, thus making a very 'clean' strip. The 502E-US-XX is individually manufactured for a specific size wire (insulate).

510E-US

Length 5.5" (137.5mm)

Adjustable V-notch stripper is a precision wire stripper with locking set-screw and can be adjusted for stripping 18-30AWG wire. It features a molded static dissipative (10⁹ohms/sq) ergonomic handle with dual leaf springs for smooth action.



502E-US-XX

Length 5.5" (137.5mm)

High precision stripping plier is ideal for stripping PTFE coated wires. It features molded ergonomic static dissipative (10⁹ohms/sq) grips with dual leaf springs for smooth action. To order, specify the wire gauge size by indicating the gauge at the end of the reference number (i.e 502E-US-030 for AWG 30). Available in 22, 24, 26, 28, and 30 AWG.



- ★★★ HIGH PRECISION
- ★★ FINE PRECISION
- ★ GENERAL PRECISION

KITSETS

We can design a kit for your exact application, whether it be for dissection or electronic re-work.





KST-5



The high precision 5 piece tweezer kitset comes complete with a wooden case. All are made in Switzerland from Neverust® Anti-magnetic Stainless Steel.

| Part # | Description | Length |
|--------|-------------------------------|---------------|
| 1-SA | Slender Fine Points | 4.50" (115mm) |
| 2-SA | Tapered Medium Points | 4.75" (120mm) |
| 3C-SA | Very Fine Precision Points | 4.25" (110mm) |
| 5-SA | Tapered High Precision Points | 4.25" (110mm) |
| 7-SA | Curved High Precision Points | 4.25" (110mm) |



KST-5-SE



The general precision 5 piece tweezer kitset comes complete with a wooden case. All are made of Anti-magnetic Stainless Steel.

| Part # | Description | Length |
|----------|-------------------------------|---------------|
| 1-SA-SE | Slender Fine Points | 4.50" (115mm) |
| 2-SA-SE | Tapered Medium Points | 4.75" (120mm) |
| 3C-SA-SE | Very Fine Precision Points | 4.25" (110mm) |
| 5-SA-SE | Tapered High Precision Points | 4.25" (110mm) |
| 7-SA-SE | Curved High Precision Points | 4.25" (110mm) |



KST-10



The high precision 10 piece tweezer kitset comes complete with a wooden case. All are made in Switzerland from Neverust® Anti-magnetic Stainless Steel.

| Part # | Description | Length |
|--------|-------------------------------|---------------|
| AA-SA | Straight Medium Points | 5.00" (127mm) |
| 00-SA | Strong Precision Points | 4.25" (110mm) |
| 00D-SA | Serrated Precision Points | 4.75" (120mm) |
| 1-SA | Slender Fine Points | 4.50" (115mm) |
| 2-SA | Tapered Medium Points | 4.75" (120mm) |
| 2A-SA | Tapered Flat Round Points | 4.75" (120mm) |
| 3C-SA | Very Fine Precision Points | 4.25" (110mm) |
| 5-SA | Tapered High Precision Points | 4.25" (110mm) |
| 5A-SA | Offset High Precision Points | 4.50" (115mm) |
| 7-SA | Curved High Precision Points | 4.25" (110mm) |



KST-10-SE



The general precision 10 piece tweezer kitset comes complete with a wooden case. All are made of Anti-magnetic Stainless Steel.

| Part # | Description | Length |
|-----------|-------------------------------|---------------|
| AA-SA-SE | Straight Medium Points | 5.00" (127mm) |
| 00-SA-SE | Strong Precision Points | 4.25" (110mm) |
| 00D-SA-SE | Serrated Precision Points | 4.75" (120mm) |
| 1-SA-SE | Slender Fine Points | 4.50" (115mm) |
| 2-SA-SE | Tapered Medium Points | 4.75" (120mm) |
| 2A-SA-SE | Tapered Flat Round Points | 4.75" (120mm) |
| 3C-SA-SE | Very Fine Precision Points | 4.25" (110mm) |
| 5-SA-SE | Tapered High Precision Points | 4.25" (110mm) |
| 5A-SA-SE | Offset High Precision Points | 4.50" (115mm) |
| 7-SA-SE | Curved High Precision Points | 4.25" (110mm) |



KITSETS

TWEEZERS

FINE
PRECISION ★★

TW-700

This kitset comes complete in a nylon pouch. All are made of Anti-magnetic Stainless Steel.

| Part # | Description | Length |
|----------|-------------------------------|---------------|
| 0C-SA-PI | Straight Fine Points | 4.50" (115mm) |
| 1-SA-PI | Very Fine Points | 4.75" (120mm) |
| AA-SA-PI | Medium Points | 4.25" (110mm) |
| 20-SA-PI | Medium Serrated Points | 4.25" (110mm) |
| 24-SA-PI | Angled Medium Serrated Points | 4.25" (110mm) |
| SS-SA-PI | Long Fine Points | 5.50" (137mm) |

TW-900

This kitset comes complete in a nylon pouch. All are made of Anti-magnetic Stainless Steel.

| Part # | Description | Length |
|----------|--------------------------|---------------|
| 00-SA-PI | Medium Points | 4.50" (115mm) |
| 2A-SA-PI | Strong Flat Round Points | 4.75" (120mm) |
| 3-SA-PI | Very Fine Points | 4.75" (120mm) |
| 7-SA-PI | Curved Very Fine Points | 4.50" (115mm) |
| 5-SA-PI | Very Fine Points | 4.25" (110mm) |
| AA-SA-PI | Medium Points | 5.00" (127mm) |





KST-DIS-1

This kit comes complete with a zippered black vinyl case.

| Part # | Description | Length |
|----------|--|------------------|
| RU-1 | Plastic ruler | 6.00" (150.00mm) |
| DR-1 | Glass dropper with rubber bulb | 4.75" (120.00mm) |
| 292 | Scissors - Stainless Steel - Blade 1.5"(37.5mm) | 4.50" (112.50mm) |
| 20A-1-SE | Forceps with guide pin and serrated handles | 4.50" (112.50mm) |
| 333 | Teasing needle with plastic handle | 5.75" (143.75mm) |
| 333F | 45° Angulated teasing needle with plastic handle | 6.00" (150.00mm) |

KST-DIS-2

The KST-DIS-2 comes complete with a zippered black vinyl case.

| Part # | Description | Length |
|---------|---|------------------|
| RU-1 | Plastic ruler | 6.00" (150.00mm) |
| 181-SE | #3 scalpel handle | 5.00" (125.00mm) |
| 181-10 | 10 pieces #10 scalpel blades | |
| 181A-SE | #4 scalpel handle | 5.50" (137.50mm) |
| 181-22 | 10 pieces #22 scalpel blades | |
| 179A | One piece straight scalpel with blade | 6.50" (162.50mm) |
| 333B | Straight Probe - Stainless Steel | 5.00" (125.00mm) |
| 333C | 55° Angled Probe - Stainless Steel | 4.87" (121.88mm) |
| 333D | 45° Angled Probe - Stainless Steel | 6.00" (150.00mm) |
| 333E | Straight Paddle Tip w/Eye Hole - Stainless Steel | 6.00" (150.00mm) |
| F-7-SE | Straight Dressing Forceps | 4.25" (110.00mm) |
| F-6-SE | Straight Tissue Forceps - 1 X 2 teeth | 4.50" (115.00mm) |
| 36A-SE | 25° Curved Clamp - Stainless Steel - Serrated | 5.50" (137.50mm) |
| 277A | Dressing Scissors - Stainless Steel - 1.5"(37.5mm) Blade Length | 5.50" (137.50mm) |
| 274A | Dissection Scissors - Stainless Steel - 1.5"(37.5mm) Blade Length | 4.62" (115.50mm) |



LAB SPECIFIC TOOLS



LAB SPECIFIC FORCEPS

The forceps shown in this section are just a few of many used in schools and industry labs around the world. We offer over 200 styles of forceps in up to 17 different materials. Let us know your specific application and our sales department can direct you to the correct tool for your application, or design a pair of forceps to your exact application.



Lab tools are made specifically for laboratory use. All feature serrated tips and grips for more control and all are cleanroom safe. They can be autoclaved.

DISSECTING - ADSON

Length 4.75" (119mm)

| Part# | Material | Quality | Critical Tip Measurement (CTM) |
|---------|-----------------|---------|--------------------------------|
| AF-1-SE | Stainless Steel | ★ | .030" X .050" .75mm X 1.25mm |



DISSECTING - ADSON

Length 4.75" (119mm)

| Part# | Material | Quality | Critical Tip Measurement (CTM) |
|----------|-----------------|---------|--------------------------------|
| 10H-S-SE | Stainless Steel | ★ | .02" X .384" 5mm X 9.6mm |



DISSECTING - ADSON

Length 4.75" (119mm)

| Part# | Material | Quality | Critical Tip Measurement (CTM) |
|--------|---------------------|---------|--------------------------------|
| 10G-SA | Anti-Mag. Neverust® | ★★★ | .023" X .023" .58mm X .58mm |



DISSECTING - ADSON

Length 4.87" (122mm)

| Part# | Material | Quality | Critical Tip Measurement (CTM) |
|--------|-----------------|---------|--------------------------------|
| F-5-SE | Stainless Steel | ★ | .02" X .035" .5mm X .88mm |



LAB SPECIFIC

SOFT TISSUE HANDLING FORCEPS

FINE
GENERAL

PRECISION



These forceps are ideal for handling soft tissue. Both handles as well as the points are serrated for better gripping. They are all made of surgical stainless steel and can be autoclaved.

SOFT TISSUE HANDLING

With Guide Pin

Length 4.25" (106mm)

| Part# | Material | Quality | Critical Tip Measurement (CTM) | |
|--------|-----------------|---------|--------------------------------|--------------|
| F-7-SE | Stainless Steel | ★★ | .02" X .03" | .5mm X .75mm |



SOFT TISSUE HANDLING

Length 4.5" (113mm)

| Part# | Material | Quality |
|----------|-----------------|---------|
| 20A-1-SE | Stainless Steel | ★ |



SOFT TISSUE HANDLING

Length 4.5" (113mm)

| Part# | Material | Quality | Critical Tip Measurement (CTM) | |
|----------|-----------------|---------|--------------------------------|-------------|
| 23B-S-SE | Stainless Steel | ★ | .12" X .06" | 3mm X 1.5mm |



SOFT TISSUE HANDLING

Length 4.75" (144mm)

| Part# | Material | Quality | Critical Tip Measurement (CTM) | |
|----------|-----------------|---------|--------------------------------|-------------|
| 23D-S-SE | Stainless Steel | ★ | .12" X .06" | 3mm X 1.5mm |





These forceps are ideal for handling soft tissue. The handles are serrated for better gripping. The 1 X 2 teeth configuration allows for complete gripping of soft tissue. They are all made of surgical stainless steel and can be autoclaved.

SMALL SOFT TISSUE HANDLING

Length 4.75"(119mm)

| Part# | Material | Quality | Critical Tip Measurement (CTM) |
|---------|-----------------|---------|--------------------------------|
| AF-2-SE | Stainless Steel | ★ | .065" X .071" 1.63mm X 1.78mm |



MEDIUM SOFT TISSUE HANDLING

Length 4.75"(119mm)

| Part# | Material | Quality | Critical Tip Measurement (CTM) |
|---------|-----------------|---------|--------------------------------|
| AF-3-SE | Stainless Steel | ★ | .083" X .074" 2.08mm X 1.85mm |



MEDIUM SOFT TISSUE HANDLING

Length 4.75"(119mm)

| Part# | Material | Quality | Critical Tip Measurement (CTM) |
|---------|-----------------|---------|--------------------------------|
| AF-4-SE | Stainless Steel | ★ | .063" X .084" 1.58mm X 2.10mm |



LARGE SOFT TISSUE HANDLING

Length 4.5" (113mm)

| Part# | Material | Quality | Critical Tip Measurement (CTM) |
|--------|-----------------|---------|--------------------------------|
| F-6-SE | Stainless Steel | ★★ | .098" X .128" 2.45mm X 3.2mm |



LAB SPECIFIC DRESSING FORCEPS

GENERAL

PRECISION



These curved/bent forceps are perfect for dressings. The curved/bent points allow for excellent visibility. Serrations assure positive gripping and are made of surgical stainless steel and can be autoclaved.

45° Curved With Serrated Tips & Guide Pin

Length 4" (100mm)

| Part# | Material | Quality | Critical Tip Measurement (CTM) |
|---------|-----------------|---------|--------------------------------|
| 24-4-SE | Stainless Steel | ★ | .02" X .030" .5mm X .75mm |



90° Bent With Smooth Tips & Guide Pin

Length 4" (100mm)

| Part# | Material | Quality | Critical Tip Measurement (CTM) |
|--------|-----------------|---------|--------------------------------|
| F-2-SE | Stainless Steel | ★ | .02" X .030" .5mm X .75mm |



90° Bent With Serrated Tips

Length 3.5" (88mm)

| Part# | Material | Quality | Critical Tip Measurement (CTM) |
|--------|-----------------|---------|--------------------------------|
| F-3-SE | Stainless Steel | ★ | .025" X .030" .63mm X .75mm |



45° Curved With Serrated Tips

Length 3.75" (94mm)

| Part# | Material | Quality | Critical Tip Measurement (CTM) |
|--------|-----------------|---------|--------------------------------|
| F-4-SE | Stainless Steel | ★ | .015" X .025" .38mm X .63mm |





These 'scoop' end Rongeurs are used to remove small pieces of bone and tissue. They are made of AISI 440 stainless steel and include serrated handles.

Scooped Shaped Tips - .03"

Length 5.75"(144mm)

| Part # | Tip Angle |
|---------|-----------|
| R-275-S | Straight |
| R-275-C | 20° |

NEW
ITEM



Scooped Shaped Tips - .20"

Length 5.75"(144mm)

| Part # | Tip Angle |
|---------|-----------|
| R-277-S | Straight |
| R-277-C | 20° |

NEW
ITEM



SCISSORS

TUNGSTEN CARBIDE BLADES

STAINLESS STEEL

★★★★ EXTREME PRECISION

These extremely precise stainless steel scissors are ideal for delicate applications. They feature Tungsten Carbide blades which have two times the tensile strength of stainless steel and double the density, producing long life. Acid-proof, sterilizable and rust proof.

Miniature Self-Opening Scissors For Confined Areas

| Part # | Shape | Length | Blade Length |
|----------|----------|---------------|----------------|
| 346-6-HT | Straight | 5.50" (137mm) | .63" (15.90mm) |
| 347-6-HT | Curved | 6.00" (150mm) | .56" (14.23mm) |



Short Thin Blade - Tight Intricate Work

| Part # | Shape | Length | Blade Length |
|--------|----------|--------------|--------------|
| 279-HT | Straight | 3.50" (88mm) | .8" (20mm) |



Medium Thin Blade - Intricate Work

| Part # | Shape | Length | Blade Length |
|--------|----------|---------------|-----------------|
| 271-HT | Straight | 4.50" (113mm) | 1.17" (29.70mm) |
| 270-HT | 60° | 4.50" (113mm) | 1.27" (32.38mm) |



Extra Long Blades - Round Blunt Tips For Safety

| Part # | Shape | Length | Blade Length |
|--------|----------|---------------|--------------|
| 371A | Straight | 6.00" (150mm) | 2" (50mm) |
| 371B | 20° | 6.00" (150mm) | 2" (50mm) |



DELICATE APPLICATIONS

SCISSORS



★★★★ EXTREME PRECISION

STAINLESS STEEL

These extremely precise stainless steel scissors are ideal for delicate applications. They are acid resistant, rust proof and autoclavable.

Extra Fine Blade Relieved Tip

| Part # | Shape | Length | Blade Length |
|--------|----------|--------------|--------------|
| 361 | 17° | 3.25" (81mm) | 1" (25mm) |
| 361S | Straight | 3.25" (81mm) | 1" (25mm) |



Fine Blade Relieved Tip

| Part # | Shape | Length | Blade Length |
|--------|----------|--------------|--------------|
| 362 | 17° | 3.13" (78mm) | .88" (22mm) |
| 362S | Straight | 3.13" (78mm) | .88" (22mm) |



Round Blade

| Part # | Shape | Length | Blade Length |
|--------|-------|--------------|--------------|
| 363 | 17° | 3.75" (94mm) | 1.25" (31mm) |



Fine Blade

| Part # | Shape | Length | Blade Length |
|--------|-------|--------------|--------------|
| 364 | 17° | 3.75" (94mm) | 1.25" (31mm) |



Fine Thin Blade

| Part # | Shape | Length | Blade Length |
|--------|-------|------------|--------------|
| 365 | 10° | 4" (100mm) | 1.09" (27mm) |



SCISSORS | DELICATE APPLICATIONS

STAINLESS STEEL ★★ ★ HIGH PRECISION

These extremely precise stainless steel scissors are ideal for delicate applications. The sleek, twisted frame gives them a professional and unique look. They are acid proof and autoclavable.

Extra Fine Blade Relieved Tip

| Part# | Blade Length | Style | Length |
|-------|--------------|--------|------------|
| 355 | .88" (22mm) | Angled | 4" (100mm) |

Angled and tapered sharp pointed blades for confined areas.



Fine Blade Relieved Tip

| Part# | Blade Length | Style | Length |
|-------|--------------|--------|--------------|
| 354 | .88" (22mm) | Angled | 3.75" (94mm) |

Angled sharp pointed blades for those hard to get to cutting applications.



Fine Blade

| Part# | Blade Length | Style | Length |
|-------|--------------|----------|--------------|
| 357 | 1.11" (28mm) | Straight | 3.85" (96mm) |

Extremely precise for delicate applications



Curved Flat Blade

| Part# | Blade Length | Style | Length |
|-------|--------------|--------|------------|
| 356 | .88" (22mm) | Angled | 4" (100mm) |

Thick angled sharp pointed blades for more difficult, strong cuts.



Extra Fine Blade Relieved Tip

| Part# | Blade Length | Style | Length |
|-------|--------------|----------|---------------|
| 358 | 1.79" (45mm) | Straight | 5.35" (134mm) |

Sharp tips are designed for a variety of applications.





These extremely precise stainless steel scissors are ideal for delicate applications. The sleek, twisted frame gives them a professional and unique look. They are acid proof and autoclavable.

Round Fine Blade

| Part# | Blade Length | Style | Length |
|-------|-----------------|----------|--------------|
| 351 | 1.13" (28.25mm) | Straight | 3.75" (95mm) |

Blunt tips are designed to be compatible with latest safety standards



Fine Blade

| Part# | Blade Length | Style | Length |
|-------|--------------|----------|--------------|
| 352 | 1.08" (27mm) | Straight | 3.85" (96mm) |

Blunt tips are designed to be compatible with latest safety standards



Fine Blade

| Part# | Blade Length | Style | Length |
|-------|---------------|----------|------------|
| 353 | 1.9" (47.5mm) | Straight | 6" (150mm) |

Blunt tips are designed to be compatible with latest safety standards



Fine Blade Relieved Tip

| Part# | Blade Length | Style | Length |
|-------|--------------|----------|--------------|
| 359 | 2.4" (60mm) | Straight | 6.5" (163mm) |

Sharp tips are designed for a variety of applications.



SCISSORS | STAINLESS STEEL

★★ FINE PRECISION

These precision miniature scissors are ideal for delicate operations in a confined area. They are made of stainless steel and can be autoclaved.

Miniature Cutting

| Part # | Shape | Length | Blade Length |
|--------|----------|---------------|--------------|
| 346 | Straight | 4.50" (113mm) | .63" (016mm) |
| 346A | Straight | 3.75" (094mm) | .50" (013mm) |
| 346B | Straight | 3.50" (088mm) | .38" (010mm) |
| 366 | Straight | 3.00" (075mm) | .19" (005mm) |
| 349 | 45° | 4.50" (113mm) | .63" (016mm) |
| 349A | 45° | 3.75" (094mm) | .50" (013mm) |
| 349B | 45° | 3.50" (088mm) | .38" (010mm) |
| 367 | 45° | 3.00" (075mm) | .19" (005mm) |
| 368 | 56° | 2.00" (050mm) | .25" (006mm) |

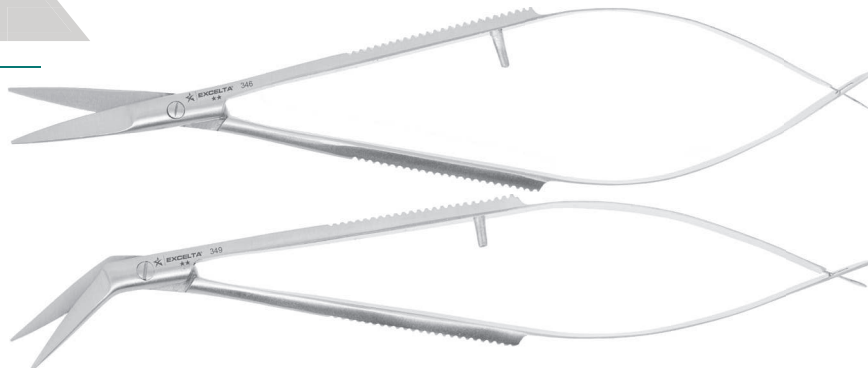

Miniature Cutting - Blunt Safety Tips

| Part # | Shape | Length | Blade Length |
|--------|----------|---------------|--------------|
| 348 | Straight | 5.00" (125mm) | .40" (10mm) |



NEW
ITEM

Extra Fine Blade Relieved Tip

| Part # | Shape | Length | Blade Length |
|--------|----------|--------------|--------------|
| 289 | 17° | 3.25" (81mm) | .75" (19mm) |
| 288 | Straight | 3.25" (81mm) | .75" (19mm) |



STAINLESS STEEL | SCISSORS

★★ FINE PRECISION



These stainless steel scissors are acid resistant, rust proof and autoclavable.

Very Fine Blade - Angled For Accessibility

| Part # | Shape | Length | Blade Length |
|--------|-------|---------------|--------------|
| 270 | 60° | 4.25" (110mm) | 1.25" (31mm) |
| 270EC* | 60° | 4.25" (110mm) | 1.25" (31mm) |

*EC-Epoxy Coated Grips



Serrated Outside Edges

| Part # | Shape | Length | Blade Length |
|--------|----------|---------------|--------------|
| 299 | Straight | 5.00" (125mm) | 1.75" (44mm) |
| 299EC* | Straight | 5.00" (125mm) | 1.75" (44mm) |

*EC-Epoxy Coated Grips



SCISSORS | STAINLESS STEEL

★ ★ FINE PRECISION

These stainless steel scissors are acid resistant, rust proof and autoclavable.

Fine Blade

| Part # | Shape | Length | Blade Length |
|----------|----------|---------------|--------------|
| 298B | Straight | 5.00" (125mm) | 2.00" (50mm) |
| 298B-EC* | Straight | 5.00" (125mm) | 2.00" (50mm) |
| 298AB | Curved | 4.63" (115mm) | 1.87" (47mm) |
| 298A | Straight | 4.50" (113mm) | 1.75" (44mm) |
| 298 | Straight | 4.00" (100mm) | 1.50" (38mm) |
| 298EC* | Straight | 4.00" (100mm) | 1.50" (38mm) |
| 297 | Straight | 3.50" (88mm) | 1.25" (31mm) |
| 295 | Straight | 4.11" (103mm) | 1.13" (29mm) |

*EC-Epoxy Coated Grips



Very Fine Blade

| Part # | Shape | Length | Blade Length |
|--------|----------|--------------|--------------|
| 292 | Straight | 4.5" (113mm) | 1.50" (38mm) |
| 290 | Straight | 3.75" (94mm) | 1.00" (25mm) |
| 290EC* | Straight | 3.75" (94mm) | 1.00" (25mm) |
| 291 | 20° | 3.75" (94mm) | 1.00" (25mm) |



STAINLESS STEEL | SCISSORS

★★ FINE PRECISION



These extremely precise surgical stainless steel scissors are ideal for delicate applications. They are acid resistant, rust proof and autoclavable.

Very Fine Blade

| Part # | Shape | Length | Blade Length |
|--------|----------|---------------|--------------|
| 275 | Straight | 4.50" (113mm) | 1.10" (28mm) |
| 275A | 10° | 5.00" (125mm) | 1.00" (25mm) |
| 271 | Straight | 4.75" (120mm) | 1.25" (31mm) |
| 274A | Straight | 4.62" (116mm) | 1.50" (38mm) |
| 274 | Straight | 4.62" (116mm) | 1.20" (30mm) |
| 273 | Straight | 4.56" (114mm) | 1.10" (28mm) |



Fine Blade - Round Blunt Tips For Safety

| Part # | Shape | Length | Blade Length |
|--------|----------|---------------|--------------|
| 376 | 14° | 7.00" (175mm) | 1.56" (39mm) |
| 277 | Straight | 4.12" (103mm) | 1.25" (31mm) |
| 278 | Straight | 4.50" (113mm) | 1.25" (31mm) |

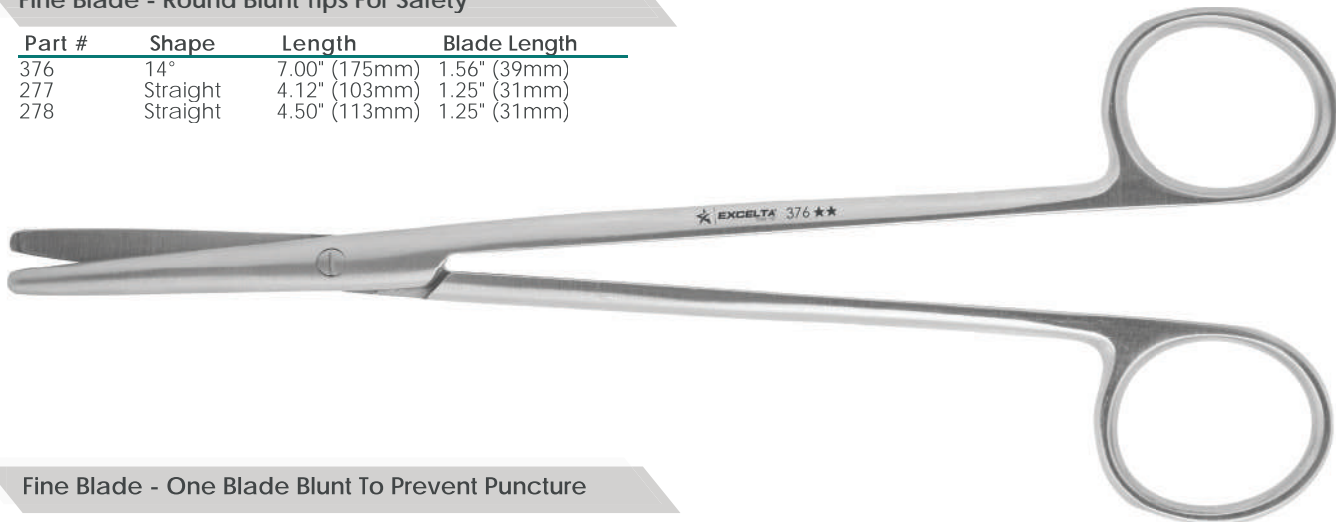

Fine Blade - One Blade Blunt To Prevent Puncture

| Part # | Shape | Length | Blade Length |
|--------|----------|---------------|--------------|
| 276 | Straight | 5.56" (139mm) | 1.25" (31mm) |
| 277A | Straight | 5.50" (138mm) | 1.50" (38mm) |
| 272 | Straight | 4.56" (114mm) | 1.50" (38mm) |



LARGE SCISSORS

STAINLESS STEEL

★★★ HIGH PRECISION
★★ FINE PRECISION

The following scissors feature robust blades which are ideal for heavy duty cutting. They are made of surgical stainless steel.

Short Round Blades

★★

| Part # | Shape | Length | Blade Length |
|--------|----------|---------------|--------------|
| 309 | Straight | 4.00" (100mm) | 1.25" (31mm) |



Ideal for Pattern Cutting

★★

| Part # | Shape | Length | Blade Length |
|--------|----------|---------------|---------------|
| 339 | Straight | 6.00" (150mm) | 2.75" (69mm) |
| 340 | Straight | 7.00" (175mm) | 3.25" (81mm) |
| 341 | Straight | 8.00" (200mm) | 4.00" (100mm) |



Serrations On One Edge - Great For Cutting Kevlar

★★★

| Part # | Shape | Length | Blade Length |
|--------|----------|---------------|--------------|
| 299P | Straight | 5.50" (138mm) | 1.75" (44mm) |



STAINLESS STEEL | HEMOSTATS

★★ FINE PRECISION



Precision hemostats come with or without vinyl-coated handles. Those without vinyl may be autoclaved. They are made of stainless steel and feature a locking mechanism.

35-SE

Length 5" (125mm)

Locking hemostat with straight serrated jaws, cleanroom safe. Also available in non-serrated 35-A-SE.



35PH

Length 5" (125mm)

Locking hemostat with straight serrated jaws and vinyl-coated handles.



36-SE

Length 5" (125mm)

Locking hemostat with 25° curved serrated jaws, cleanroom safe.



36PH

Length 5" (125mm)

Locking hemostat with 25° curved serrated jaws and vinyl-coated handles.



37-SE

Length 6" (150mm)

Locking hemostat with straight serrated jaws, cleanroom safe.



37PH

Length 6" (150mm)

Locking hemostat with straight serrated jaws and vinyl-coated handles.



HEMOSTATS | STAINLESS STEEL

★ ★ FINE PRECISION

38-SE

Length 6" (150mm)

Locking hemostat with 30° curved serrated jaws and cleanroom safe.



38PH

Length 6" (150mm)

Locking hemostat with 30° curved serrated jaws has vinyl-coated handles.



39-SE

Length 8" (200mm)

Locking hemostat with straight serrated jaws and cleanroom safe.



39PH

Length 8" (200mm)

Locking hemostat with straight serrated jaws has vinyl-coated handles.



40-SE

Length 8" (200mm)

Locking hemostat with 30° curved serrated jaws and cleanroom safe.



40PH

Length 8" (200mm)

Locking hemostat with 30° curved serrated jaws has vinyl-coated handles.





Mosquito clamps are used to clamp small blood vessels. They are made of autoclavable surgical stainless steel and feature a locking mechanism.

Mosquito Clamp Length 5" (127mm)

| Part# | Jaws | Style |
|-------|----------|------------|
| 31-SE | Serrated | 30° Curved |



Mosquito Clamp Length 5" (127mm)

| Part# | Jaws | Style |
|--------|----------|----------|
| 33-SE | Smooth | Straight |
| 33A-SE | Serrated | Straight |



Mosquito Clamp Length 5" (127mm)

| Part# | Jaws | Style |
|--------|----------|------------|
| 36A-SE | Serrated | 30° Curved |



Webster needle holders are used to securely hold needles for sewing tissue. They are made of autoclavable surgical stainless steel and feature a locking mechanism.

Webster Needle Holder Length 5" (127mm)

| Part# | Jaws | Style |
|----------|--------|----------|
| NH-35-SE | Smooth | Straight |



Webster Needle Holder Length 6" (150mm)

| Part# | Jaws | Style |
|----------|--------|----------|
| NH-38-SE | Smooth | Straight |



BRUSHES | INSTRUMENT CLEANING

SPECIALTY

★★★★ EXTREME PRECISION

Instrument Cleaning Brushes

Designed for general cleaning in tight areas. The handle is .25" (6.25mm) in diameter. Fibers are mechanically clamped into the stainless steel tube and inserted in the Acetal handle. Available with straight or bent tips.



210S-N *210B-H 210S-S *210B-S

Heat Resistant Brushes

The nylon fibers are epoxy set into the Acetal handles with a high temperature adhesive to resist deterioration in an autoclave. The soft non-shedding nylon fibers are perfect for working on delicate parts. Brushes should be cleaned prior to cleanroom use.



211A-N 211B-N 211C-N 211D-N

| Part # | Shape | Length | Blade Length |
|---------|----------|-----------------|---------------|
| *210B-H | Bent 50° | Horse Hair | 5.50" (138mm) |
| 210B-N | Bent 50° | Nylon | 5.50" (138mm) |
| 210B-P | Bent 50° | Hog Hair | 5.50" (138mm) |
| 210B-S | Bent 50° | Stainless Steel | 5.50" (138mm) |
| *210S-H | Straight | Horse Hair | 5.75" (144mm) |
| 210S-N | Straight | Nylon | 5.75" (144mm) |
| 210S-P | Straight | Hog Hair | 5.75" (144mm) |
| 210S-S | Straight | Stainless Steel | 5.75" (144mm) |

| Part # | Shape | Length | Blade Length |
|--------|----------|--------|---------------|
| 211A-N | Straight | Nylon | 4.50" (115mm) |
| 211B-N | Straight | Nylon | 4.50" (115mm) |
| 211C-N | Straight | Nylon | 4.50" (115mm) |
| 211D-N | Straight | Nylon | 4.50" (115mm) |

Materials

Hog Hair: Strong and stiff with natural taper and split end. Water resistant and heat tolerant to 500°F.

***Horse Hair:** Soft and slightly stiff. Used for scratch-free dry brushing. Heat resistant to 370°F. ESD Safe (10⁸-10¹¹ ohms/sq)

Nylon: Resilient and durable. Impervious to solvents and common chemicals. Resistant to bacteria and heat resistance to 250°F.

Stainless Steel: Resistant to heat, rust and corrosion. Used for wet or dry applications.

CLEANROOM SAFE | BRUSHES

★★★★ EXTREME PRECISION | SPECIALTY



ESD Safe Brushes

(10^8 - 10^{11} ohms/sq)

Made with stainless steel handles and horse hair bristles to provide ESD protection. The bristles are mechanically clamped into the handle for maximum fiber retention without the use of adhesives which could contaminate the work area. Soft and slightly stiff, heat resistant to 370°F.



212A-H 212B-H 212C-H 212D-H

| Part# | Bristles | Length |
|--------|------------|---------------|
| 212A-H | Horse Hair | 3.5" (88mm) |
| 212B-H | Horse Hair | 4.75" (120mm) |
| 212C-H | Horse Hair | 4.75" (120mm) |
| 212D-H | Horse Hair | 6" (150mm) |

Cleanroom Safe Brushes

(10^8 ohms/sq)

Designed for general cleaning in tight areas. Bristles are mechanically clamped into the handle for maximum fiber retention without the use of adhesives which could contaminate the work area. New Stratigo9 fibers are similar to nylon fibers, except they are Static Dissipative.



213A-N 213B-N 213C-N 213D-N

| Part# | Bristles | Length |
|--------|-----------|---------------|
| 213A-N | Stratigo9 | 3.5" (88mm) |
| 213B-N | Stratigo9 | 4.75" (120mm) |
| 213C-N | Stratigo9 | 4.75" (120mm) |
| 213D-N | Stratigo9 | 6" (150mm) |

Materials

Horse Hair: Soft and slightly stiff. Used for scratch-free dry brushing. Heat resistant to 370°F. ESD Safe (10^8 - 10^{11} ohms/sq)

Stratigo9: A static dissipative acetal which is as durable as nylon, thick enough to perform mechanical work and does not shed or slough and is cleanroom compatible.

BRUSHES | SCRATCH/CLEANING

SPECIALTY ★★ FINE PRECISION

Fiberglass Cleaning Brush

| Part# | Length | Diameter |
|-------|---------------|---------------|
| 264 | 5.25" (131mm) | .05" (1.25mm) |

Fiberglass refillable cleaning brush has a long thin handle. It is ideal for use in very confined areas, which are not accessible with larger diameter brushes. Refill **264A**



Brush Kit

| Part# | Length | Diameter |
|-------|---------------|------------|
| 262 | 4.25" (106mm) | .13" (3mm) |

This kit includes one handle and four replaceable brushes (**265A, 266A, 267A, 268A**).



Fiberglass Scratch Brush

| Part# | Length | Diameter |
|-------|---------------|----------------|
| 263 | 4.25" (106mm) | .63" (15.75mm) |

Fiberglass retractable and refillable scratch brush with plastic handle. Very useful when cleaning and polishing. Refill - **263A**



Nylon Bench Brush

| Part# | Length | Width |
|-------|--------------|------------|
| 186 | 8.5" (213mm) | .5" (13mm) |

Bench brush with wooden handle has four rows of white nylon bristles 3.75" (93.75mm) long. The bristles will not shed.



Scratch Brushes

| Part# | Material | Length | Diameter | Refill |
|-------|------------|---------------|------------|--------|
| 265 | Brass | 4.75" (120mm) | .13" (3mm) | 265A |
| 266 | Steel | 4.75" (120mm) | .13" (3mm) | 266A |
| 267 | Fiberglass | 4.75" (120mm) | .13" (3mm) | 267A |
| 268 | Nylon | 4.75" (120mm) | .13" (3mm) | 268A |

Retractable and refillable scratch brushes have a plastic handle. They can be used for fine de-burring, polishing, rust removal, or cleaning and erasing the chemical etching processes. They are excellent for pre-solder and contact cleaning.



Bench Brushes - ESD Safe (10⁸-10¹¹) ohms/sq

| Part# | Length | Width | Firmness |
|-------|-------------|------------|-----------|
| 187 | 10" (250mm) | .5" (13mm) | Soft |
| 189 | 10" (250mm) | .5" (13mm) | Half Soft |
| 190 | 10" (250mm) | .5" (13mm) | Half Hard |

Soft bench brush is made of high grade bristles with a wooden handle. There are four rows of bristles 4.5" (112.5mm) long. They will not shed.



Applicator Brush - ESD Safe (10⁸-10¹¹) ohms/sq

| Part# | Length | Diameter |
|-------|--------------|-------------|
| 214-H | 4.5" (115mm) | .188" (5mm) |

Double-ended applicator brush has a short flat end and an extra stiff chiseled end. The bristles are soft horse hair.



Applicator Brush - ESD Safe (10⁸-10¹¹) ohms/sq

| Part# | Length | Diameter |
|-------|--------------|-------------|
| 215-H | 4.5" (115mm) | .375" (9mm) |

Double-ended applicator brush has a short flat end and an extra stiff chiseled end. The bristles are soft horse hair.



ESD SAFE | BRUSHES

★★ FINE PRECISION | SPECIALTY



ESD Safe - Surface Resistivity 10^8 - 10^{10} ohms/sq

Soft Cleaning Brush

| Part# | Length | Height | Width |
|---------|------------|---------------|------------|
| 194-ESD | 6" (150mm) | .019" (.48mm) | .5" (13mm) |

Two rows of soft bristles. Round plastic handle.



Soft Cleaning Brush

| Part# | Length | Height | Width |
|---------|---------------|------------|-------------|
| 196-ESD | 5.75" (144mm) | .13" (3mm) | 1.5" (38mm) |

One row of soft bristles. Flat plastic handle.



Toothbrush Style Brush

| Part# | Length | Height | Width |
|---------|---------------|--------------|--------------|
| 197-ESD | 6.76" (170mm) | .38" (9.5mm) | 1.25" (31mm) |

Three rows of medium stiff bristles. Square plastic handle with finger grooves.



SCALPELS & HANDLES

★★★ HIGH PRECISION
★★ FINE PRECISION

#3 Stainless Steel Scalpel Blades ★★

- 177-10 - Large Curved
- 177-11 - 10° Triangular
- 177-11-R - Relieved 10° Triangular
- 177-12 - Crescent
- 177-13 - Small Curved
- 177-15 - Fine



177-10 177-11 177-12 177-13 177-15

#3 Stainless Steel Scalpel Handles

- 177 ★★★
- 177-SE ★★



#3 Stainless Steel Scalpel Blade

- 181-10 ★★



#3 Stainless Steel Scalpel Handle

- 181-SE ★★



#4 Stainless Steel Scalpel Blade ★★

- 181-22 ★★



#4 Stainless Steel Scalpel Handle ★★

- 181A-SE ★★



SMALL HAND TOOLS

★★★ HIGH PRECISION
★ GENERAL PRECISION

SCALPELS RAZOR BLADES



Scalpel Handles / Disposable Scalpels ★★★

| Part# | Description | Length |
|----------|----------------------------|---------------|
| 178-11-S | Disposable Sterile Scalpel | 5.75" (144mm) |
| 175-11 | Disposable Scalpel | 3.25" (81mm) |



Scalpel Accessories

| | | |
|------|-----|--------------------------------------|
| 174 | ★ | Stainless Steel Blade Holder/Breaker |
| 177A | ★★★ | Scalpel Blade Remover |



Carbon Steel Razor Blades ★★★

| | | | |
|---|---|---|---|
| 176-1 .009" Single Edge 2 facet Wrapped | 176-2 .009" Single Edge 2 facet Unwrapped | 176-3 .009" Single Edge 2 facet Unwrapped & Washed | 176-4 .009" Single Edge 3 facet Wrapped |
|---|---|---|---|

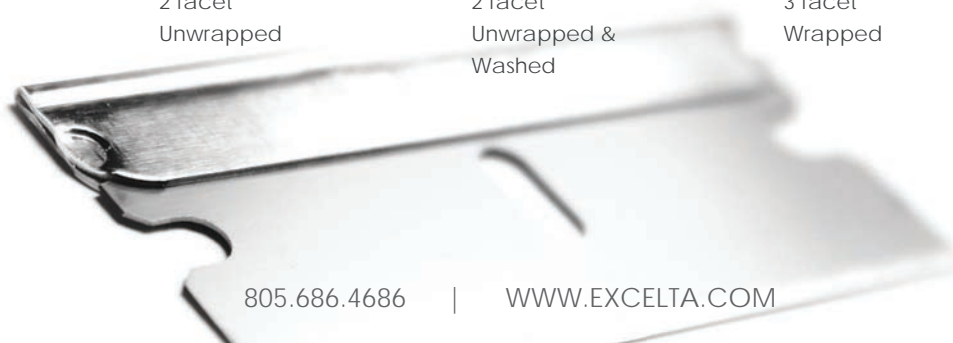

MINIATURE OILERS

SMALL HAND TOOLS

★★★ HIGH PRECISION

Ideal for placing very small amounts of epoxies or lubricants into tight places.

Miniature Spatulas ★★★ Plastic Handle

Length 2.5" (62mm)

| Part# | Tip Size | Color | |
|--------|---------------|-------|------------|
| 260AA | .005" (.13mm) | Teal | |
| 260A | .010" (.25mm) | Black | |
| 260A-R | .010" (.25mm) | Black | Radius tip |
| 260B | .015" (.38mm) | Blue | |
| 260C | .020" (.50mm) | Green | |
| 260D | .030" (.75mm) | Red | |
| 260D-R | .030" (.75mm) | Red | Radius tip |



Miniature Spatulas ★★★ Aluminum Handle

Length 2.5" (62mm)

| Part# | Tip Size | Color |
|----------|---------------|-------|
| 260A-ESD | .010" (.25mm) | Black |
| 260B-ESD | .015" (.38mm) | Blue |
| 260C-ESD | .020" (.50mm) | Green |
| 260D-ESD | .030" (.75mm) | Red |
| 260E-ESD | .010" (.25mm) | Gold |



SMALL HAND TOOLS

★★★ HIGH PRECISION
★★ FINE PRECISION

MINIATURE OILERS



Miniature Spatulas

★★★ Ergonomic Foam Grip

Length 3" (75mm)

| Part# | Tip Size | Color |
|---------|---------------|-------|
| 260A-ET | .010" (.25mm) | Black |
| 260B-ET | .015" (.38mm) | Blue |
| 260C-ET | .020" (.50mm) | Green |
| 260D-ET | .030" (.75mm) | Red |



260H

★★ Extension Handle

Length 2.75" (69mm)

Extension handle for the 260 series mini-spatulas are made of polished stainless steel. Reduces hand fatigue and provides increased control for delicate application.



320-DP

★★ Dotting Pen Set

Length 2.75" (69mm)

The 320-DP deluxe Dotting Pen Set is stainless steel with a double-sided handle and includes 1 tapered tip, 1 spear tip and 8 different diameter ball tips. Ball Dia. .041", .062", .070", .085", .1", .110", .120".86" (.86" is 30° Angled. Others are straight)

NEW
ITEM



SPATULAS MIRRORS

SMALL HAND TOOLS

★★★ HIGH PRECISION
★★ FINE PRECISION

Spatulas ★★

| Part# | Description | Length |
|-------|-----------------------|------------|
| 342 | Double Ended Spatula | 7" (175mm) |
| 343 | Double Ended Spatula | 7" (175mm) |
| 345 | Wooden Handle Spatula | 8" (200mm) |



Inspection Mirrors ★★★ ESD Safe

| Part# | Shape | Length | Head Size |
|-------|-------|--------------|--------------------------|
| 415 | Round | 8.0" (200mm) | 1.25" (31mm) dia. |
| 416 | Oval | 8.5" (213mm) | 1.00" (25mm) X 2" (50mm) |
| 417 | Round | 7.5" (188mm) | 0.88" (22mm) dia. |





These small pin vises provide a 'handle' for probes, drill bits or any other small cylindrical items.

Double Ended Pin Vise - Stainless Steel

| Part# | Length | Chuck Opening | Surface Resistivity |
|-------|--------------|---------------------------|---------------------|
| 220 | 4.5" (115mm) | .035"-.115" (.88mm-2.8mm) | Conductive |



Brass Handle Pin Vise

| Part# | Length | Chuck Opening | Surface Resistivity |
|-------|-------------|-------------------|---------------------|
| 227A | 3.5" (90mm) | 0 - .015" (.38mm) | Conductive |
| 227B | 4" (100mm) | 0 - .025" (.63mm) | Conductive |



Ergonomic Pin Vise

| Part# | Length | Chuck Opening | Surface Resistivity |
|---------|--------------|-------------------|--------------------------|
| 227A-ET | 4" (100mm) | 0 - .015" (.38mm) | 10 ¹⁰ ohms/sq |
| 227B-ET | 4.5" (115mm) | 0 - .025" (.63mm) | 10 ¹⁰ ohms/sq |



Ergonomic Pin Vise with .010" (.75mm) Probe

| Part# | Length | Chuck Opening | Surface Resistivity |
|---------|-------------------|-------------------|--------------------------|
| 227C-ET | 4" (100mm) | 0 - .015" (.38mm) | 10 ¹⁰ ohms/sq |
| 227D-ET | 4.5" (115mm) | 0 - .025" (.63mm) | 10 ¹⁰ ohms/sq |
| 227C-P | Replacement Probe | | |



PROBES AND SCRIBES

SMALL HAND TOOLS

★★★ HIGH PRECISION

Stainless steel probes and scribes are cleanroom safe and autoclaveable.

Micro Tip Probes Length 6.5" (163mm)

| Part # | Tip Size | Style |
|--------|----------------|------------|
| 332A | .001" (.025mm) | Straight |
| 332B | .001" (.025mm) | 45° Angled |
| 332C | .001" (.025mm) | 25° Angled |
| 332D | .001" (.025mm) | 90° Angled |
| 332E | .001" (.025mm) | Hooked |



Short Fine Tip Probes Length 3" (75mm)

| Part # | Tip Size | Style |
|--------|----------------|-------------------------|
| 331A | .001" (.025mm) | Straight |
| 331B | .001" (.025mm) | 90° Angled |
| 331C | .001" (.025mm) | 35° Curved |
| 331D | .001" (.025mm) | .5"(12.5mm) Radius Hook |



Short Micro Tip Probes Length 4.75" (119mm)

| Part # | Tip Size | Style |
|--------|----------------|------------|
| 335A | .001" (.025mm) | Straight |
| 335B | .001" (.025mm) | 90° Angled |



Diamond Tip Scribes Length 4.5" (115mm)

| Part # | Tip Size | Style |
|--------|-------------|------------|
| 475A | .02" (.5mm) | Straight |
| 475B | .02" (.5mm) | 20° Angled |



Fine Tip Probes Length 6" (150mm)

| Part # | Tip Size | Style |
|--------|--------------|-----------------------------------|
| 330A | .01" (.25mm) | Straight |
| 330B | .01" (.25mm) | 90° Angled |
| 330C | .01" (.25mm) | 35° Curved |
| 330D | .01" (.25mm) | .5"(12.5mm) Radius Hook |
| 330E | .03" (.75mm) | 45° Angled |
| 333A | N/A | Knife |
| 330K | Kit | Includes 330A,330B,330C,330D,330E |



Double Ended Scribes/Probes

| Part # | Tip Size | Style | Length |
|--------|---------------|-----------------|--------------|
| 477 | .015" (.38mm) | Straight/90° | 8.5" (213mm) |
| 478 | .015" (.38mm) | Straight/Hook | 7.5" (188mm) |
| 344C | .01" (.25mm) | Angled/90° | 5.5" (137mm) |
| 344D | .01" (.25mm) | Curved/45° | 5.5" (137mm) |
| 344 | .01" (.25mm) | Kit - 11 pieces | 5.5" (137mm) |



SMALL HAND TOOLS

LAB SPECIFIC PROBES



FINE PRECISION
GENERAL PRECISION

While the stainless steel probes below are specifically designed for labs, they also fit a variety of applications.

Knurled Handle Probe ★★ Length 5" (150mm)

| Part# | Tip Size | Style |
|-------|-------------|----------|
| 333B | .02" (.5mm) | Straight |



Knurled Handle Probe ★★ Length 4.875" (122mm)

| Part# | Tip Size | Style |
|-------|-------------|-------|
| 333C | .02" (.5mm) | 55° |



Stainless Steel Handle Probe ★★ Length 6" (150mm)

| Part# | Tip Size | Style |
|-------|----------------|-------|
| 333D | .055" (1.38mm) | 45° |



Plastic Handle Probe ★★ Length 6" (150mm)

| Part# | Tip Size | Style |
|-------|----------------|----------|
| 333 | .001" (.025mm) | Straight |



Plastic Handle Probe ★ Length 5.75" (144mm)

| Part# | Tip Size | Style |
|-------|---------------|-------|
| 333F | .025" (.63mm) | 45° |



Ligature Probe ★ Length 6" (150mm)

| Part# | Tip Size | Style |
|-------|-------------------------|-------|
| 333E | .04" X .4" (1mm X 10mm) | Slot |

These are used to explore and gauge the depth of non-visible cavities. The eye may be used for carrying ligatures.



TEST AND MEASURING | MAGNIFIERS & LOUPES

TEST AND MEASURING

★★★★★ ULTRA PRECISION
 ★★★ HIGH PRECISION

455A ★★★

The **Super Optimisor** has a magnifying power of 2.2 and can be used for precise viewing with the added 3.3 power lens. The exclusive clear-view lens has no center post to increase viewing. Shatter-resistant precision and optical lens bring the smallest detail up to a larger and sharper image. Comes with an adjustable headband and can be worn over regular glasses.



401 ★★★

Magna-Life illuminated Optical Magnifier is a 4X power hand held magnifier. Lens dimension is 1.5" (37.5mm) square. Perfect for quality control and inspection personnel. Comes in a durable impact resistant case. Length 4.75" (120mm)

407 ★★★

Magna-Life illuminated Optical Magnifier is a 10X power hand held magnifier. Lens dimension is 1.5" (37.5mm) square. Perfect for quality control and inspection personnel. Comes in a durable impact resistant case. Length 4.85" (121.5mm)



405 - 410 - 422 Eye Loupes ★★★★★

Used for magnification in assembly or inspection. Two element optical glass construction. Bright, sharp focus loupes with 360° clear acrylic base to admit light from all directions and a wide range of view.



405
5 Power Eye Loupe



410
10 power Eye Loupe



422
22 power Eye Loupe

POCKET BEEPER | TEST AND

★★★ HIGH PRECISION | MEASURING



PB-1

As a continuity tester, Pocket-Beeper affords the operator quick discernment of point-to-point continuity testing by a clear audible tone. As a transistor and diode tester, the Pocket-Beeper analyzes "in circuit" junctions for go/no go normality.

The Model PB-1 indicates leakage, short or open conditions of transistors. Pocket-Beeper's portability, combined with its unique self-contained design and rugged enclosure, make it ideal for production and field service applications.

Applications:

- Point-to-point continuity
- Rapid in-circuit scanning of transistors and diodes
- Detects shorts, open and leakage in components
- Positive go/no go testing
- Field servicing and maintenance

Features:

- Automatic power shut-off when not in use
- Audibly indicates conditions
- Low power drain for long battery life
- Will not harm any solid-state device or delicate circuits

Specifications:

- Power (internally supplied) 1.5 VDC "C" dry cell
- Probe signal voltage 1.6 volts peak-to-peak
- Dimensions: 4" high X 1" deep X 2" wide
- Ambient temperature range +10°F to +120°F
- Weight: 12 ounces maximum



Replacement Probes: PB-1L

IntelliTweeze®

TM-500



Features

0.2-0.5% base measurement accuracy
 Manual C,R,L,Z and ESR modes
 Adjustable test signal levels
 Diode Polarity/Short Testing
 Secondary D,Q and ESR parameters

Physical Specifications

| | |
|--------------------------------------|---|
| Operating Temperature: | 0°C to +50°C |
| Storage Temperature: | -40°C to +70°C |
| Relative Humidity: | 0% to 90% (0°C to 35°C) 0% to 70% (35°C to 55°C) |
| Altitude Operating: | 0-2000 meters |
| Battery Type: | 3.7V LIPO rechargeable 150 mA |
| Typical Charge Time: | 2.5 Hours |
| Electromagnetic Compatibility (EMC): | Susceptibility and Emission: CE85 |
| Size: | 14.0 x 2.5 x 3.0 cm (3.94 x 0.9 x 1.18) |
| Weight: | 53 grams (0.11LB) |
| Warranty: | 1 year |

Basic Specifications

| | |
|------------------------|-------------------------------|
| Measured Parameters: | L,C,R,ESR,D,Q |
| Measuring Frequencies: | 100 Hz, 120 Hz, 1 kHz, 10 kHz |
| Measurement Rate: | 1 time per second |
| Resistance: | 0.05 Ohms to 9.9 Mohms |
| Capacitance: | 0.5 pF to 4.999 uF |
| Inductance: | 0.5 uH to 999 mH |
| Dissipation Factor: | 0.001 to 1000 |

Accuracy Specifications

Accuracy is specified at 18°C to 28°C (64°F to 82°F), with relative humidity to 90%

| | |
|-----------------------|---|
| Resistance Accuracy: | 0.2% in range 100 R to 10 K, 0.5% in range 1 R to 1 M |
| Capacitance Accuracy: | 0.2% in range 10 nF to 10 uF, 0.5% in range 100 pF to 1mF |
| Inductance Accuracy: | 0.2% in range 10 mH to 100 mH, 0.5% in range 100 uH to 1H |

Technical Specifications

| | |
|------------------------------|-------------------------------|
| AC test mode Test frequency: | 1 kHz, 10 kHz, 120 Hz, 100 Hz |
| Test frequency accuracy: | 50 PPM (0.005%) |
| Test signal level: | 0.5/1.0 +/-5% Vrms Sine wave |
| Source impedance: | 100 Ohms +/- 1% |

Replacement Tips

| Part# | Shape |
|-----------|---------------|
| TM-500-BX | Bent |
| TM-500-X | Straight |
| TM-500-PX | Straight,Fine |



Intelligently designed to make locating a faulty component a breeze.

The new IntelliTweeze® features a unique patented mechanical and electronic design which incorporates a built-in direct precision SMD probe designed for component evaluation on the production line, component impedance testing and sorting of SMD components.



EXCELTA[®]

VACUUM SYSTEMS

VACUUM SYSTEMS

Hi-Performance vacuum systems are ideal for handling wafers, disk media, flat panels, or any item with a flat hard surface.

★★★★★ ULTRA PRECISION
★★★★★ EXTREME PRECISION
★★★ HIGH PRECISION

Quality Vacuum Systems

Continuous Vacuum Systems

Roto-Pic® - Vacuum system features thumb-wheel control to rotate tip 360° for perfect alignment of items without rotating the wrist.

4000-ST - Complete work bench general purpose vacuum kit.

4000-HP - Complete work bench high performance vacuum kit.

Portable Vacuum Systems

Pen-Vac® - Self-contained 6" vacuum pens with storage compartments in most pens for storage of various tips.

Handi-Vac® - Self-contained vacuum bulb kit for convenient use anytime, anywhere.

EXCELTA®
www.excelta.com

VACUUM PEN
MADE IN U.S.A. - EXCELTA

VACUUM | ROTO-PIC® SYSTEM

HANDLING TOOLS

★★★★★ ULTRA PRECISION

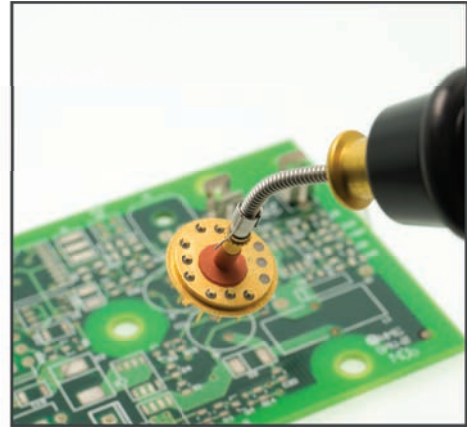
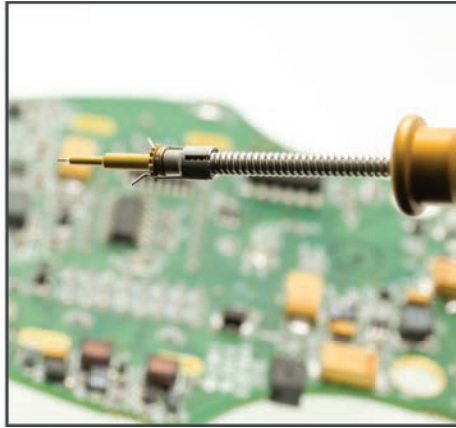
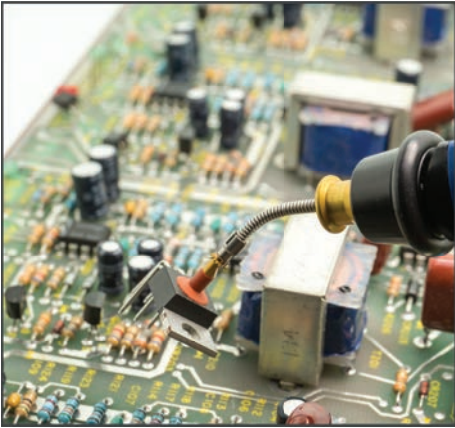

The most revolutionary vacuum pick-up available. Designed to reduce manual handling of both chips and wafers. The Roto-Pic® has a smooth positive hold-and-release slide bar. The round nose wheel rotates 360° so components can be picked up and aligned with ease. Easily replaceable tips come in a variety of sizes and silicon rubber cups which can be inserted on Roto-Pic for pick-up and manipulation.

VACUUM KITS

2000RK Complete Vacuum System Kit

Complete vacuum handling system includes one each of the following kits:

2000R, 2000P, 2000WP, 2000DA

2000R Vacuum System Kit

Contains one each of the following:

2000A, 2000V, 2000C

2000P Probe Kit

Contains one each of the following probes:

2020, 2021, 2022, 2023, 2024

2000WP Vacuum Cup Kit

Contains one each of the following cup assemblies:

2050, 2051, 2052, 2060, 2071

2000DA Vacuum Tip Kit

Contains one each of the following tip assemblies:

2040, 2041, 2043, 2044



2000R Roto-Pic Vacuum System

| Ref. No | Description |
|---------|---------------------|
| 2000A | Roto-Pic® Handpiece |
| 2000V | Vacuum Pump |
| 2000C | 3' Plastic Hose |



Vacuum Probes

For use with Roto-Pic® Handpiece (2000A)

| Ref. No | Description |
|---------|-------------|
| 2020 | 45° |
| 2021 | 60° |
| 2022 | 45° short |
| 2023 | 90° |
| 2024 | straight |



Vacuum Cup Assemblies

High temperature vacuum cups made of silicon rubber with brass fittings.

| Ref. No | Description |
|---------|-------------------------------|
| 2050 | .38"(.950mm) Cup |
| 2051 | .50"(.12.50mm) Cup |
| 2052 | .25"(.06.25mm) Cup |
| 2060 | Circo-Vac Cup |
| 2071 | Verto-Vac w/high temp support |



Small Tip Assemblies

Vacuum Tips for handling small parts, for use with Roto-Pic® Probes and Handpiece

| Ref. No | Description | Tip Material |
|---------|--------------|--------------|
| 2040 | .006"(.15mm) | Teflon |
| 2041 | .005"(.13mm) | Polyethylene |
| 2043 | .012"(.30mm) | Polyethylene |
| 2044 | .035"(.88mm) | Polyethylene |



VACUUM

HANDLING TOOLS

CONTINUOUS VACUUM

★★★★ EXTREME PRECISION

★★★★ HIGH PRECISION

4000-ST ★★★★★

General Purpose Vacuum System

A general purpose vacuum handling tool which plugs directly into 110 VAC. This compact unit will handle most of the surface mount components used in the industry today. The long life diaphragm vacuum pump generates up to 10 inches of mercury with an open air flow of 2.3 lpm. The unit connects to ground automatically with a three-wire power cord.

The 4000-ST comes complete with the following features:

- Whisper-quiet operation.
- 5 feet of coiled vacuum hose.
- Vacuum pick-up handpiece.
- No-skid rubber feet.
- Produces vacuum of over 10 inches of mercury.
- Side mounted handpiece holder.
- Set of nine vacuum tips: PVS-CB-12, PVS-CB-14, PVS-CB-18, PVS-CB-38, PVB-CB-332, PVB-CB-316, PVB-CB-14, PVB-CB-18, PVB-CB-38.



Individual System Components ★★★★★

4000-H Handle for 4000-HP/ST

4000-RF Replacement Filter for 4000-HP



PV-HV ★★★

Length 3" (75mm)

Handi-Vac® is a vacuum bulb pick-up tool that is simple and easy to use. When the vacuum bulb is squeezed, place the soft suction cup on the part to be handled. A second squeeze releases the part.

Kit Contains:

Hand Piece - PV-HV-B

Probe/Cup Assemblies - PVB-CB-18, PVB-CB-14
PVS-CB-18, PVS-CB-38



PEN-VAC® KITS

★★★ HIGH PRECISION

VACUUM

HANDLING TOOLS



Pen-Vac® and Handi-Vac® tools are ESD Safe with a surface resistivity of 10^{11} - 10^{12} ohms/sq. They are excellent tools for picking up and placing standard and odd size flat surface items. These systems are mechanical, making them extremely portable.

PV-1-ESD-CNX

Length 5" (125mm)

Kit Contains:

- Hand Piece - PV-JR
- Probe/Cup Assemblies - PVS-CB-12, PVB-CB-12
- Other Cups - CB-14, CB-38



PV-2A-ESD

Length 6" (150mm)

Kit Contains:

- Hand Piece PV-ST (Rear Storage)
- Probe/Cup Assemblies - PVB-CB-18, PVB-CB-14, PVB-CB-38
- PVS-CB-18, PVS-CB-14, PVS-CB-38



PV-2-ESD

Length 6" (150mm)

Kit Contains:

- Hand Piece PV-ST (Rear Storage)
- Probe/Cup Assemblies - PVB-CB-18, PVB-CB-14



PV-3A-ESD

Length 5" (125mm)

Kit Contains:

- Hand Piece - PV-JR
- Probe/Cup Assemblies - PVB-CB-18, PVB-CB-14, PVB-CB-38
- PVS-CB-18, PVS-CB-14, PVS-CB-38



VACUUM | PEN-VAC® HAND PIECES

HANDLING TOOLS | ★★★ HIGH PRECISION

The following hand pieces can be ordered in kit form on page 169, or you can create your own kit by adding cups and probes from page 171.

PV-JR Length 5" (125mm)

Pen-Vac® Junior comes with a handpiece and pocket clip. Depressing the button compresses the bellows to create the vacuum. Great for handling small flat items.

(Replacement hand piece for PV-1-ESD-CNX kit and PV-3A-ESD kit)



PV-ST Length 6" (150mm)

Pen-Vac® Standard comes with a handpiece and pocket clip. Unlike the PV-JR, the PV-ST includes a rear storage compartment for cups and probes. Depressing the button compresses the bellows to create the vacuum. Great for handling small flat items

(Replacement hand piece for PV-2-ESD kit and PV-2A-ESD kit)



PV-HV-B Length 3" (75mm)

Handi-Vac® is a vacuum bulb pick-up tool that is simple and easy to use. When the vacuum bulb is squeezed, place the soft suction cup on the part to be handled. A second squeeze releases the part.

(Replacement hand piece for PV-HV Kit.)





Finest Quality Replacement Cups and Probes

- Cup sizes from .10" (2.5mm) to .75" (18.75mm)
- Made of Buna-N ESD Safe (10⁹-10¹² ohms/sq) non-marking material
- Working temperature -5° to 250°F
- Interchangeable with Pen-Vac® Junior, Pen-Vac® Standard, Pen-Vac® Pro, Handi-Vac®, 4000-ST and 4000HP

Straight Probes



Angulated Probes



Cups

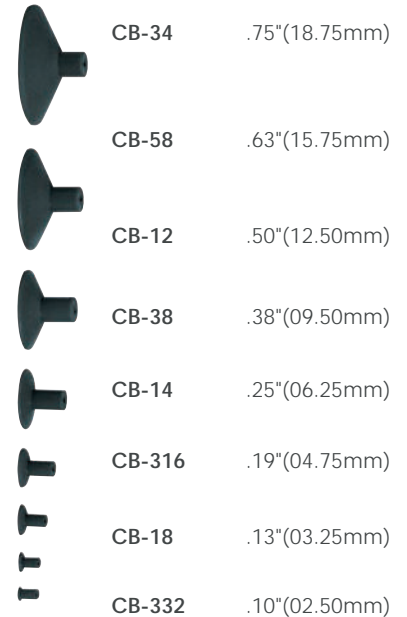

Small Tips

Designed for handling very small parts. Tips are made in ESD Safe Acetal Plastic so there is no chance of static or mechanical damage. These small tips are used ONLY with the 4000-ST or 4000HP.

Angulated Tips



Straight Tips

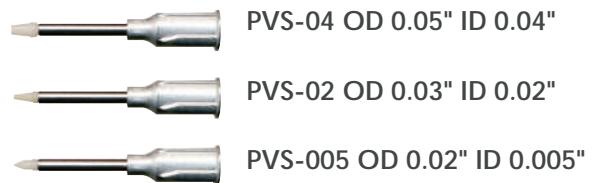

INDEX BY TYPE

BRUSHES

Cleanroom Safe

| | |
|--------|-----|
| 212A-H | 149 |
| 212B-H | 149 |
| 212C-H | 149 |
| 212D-H | 149 |
| 213A-N | 149 |
| 213B-N | 149 |
| 213C-N | 149 |
| 213D-N | 149 |

ESD Safe

| | |
|---------|-----|
| 194-ESD | 151 |
| 196-ESD | 151 |
| 197-ESD | 151 |

Instrument Cleaning

| | |
|--------|-----|
| 210B-H | 148 |
| 210B-N | 148 |
| 210B-P | 148 |
| 210B-S | 148 |
| 210S-H | 148 |
| 210S-N | 148 |
| 210S-P | 148 |
| 210S-S | 148 |
| 211A-N | 148 |
| 211B-N | 148 |
| 211C-N | 148 |
| 211D-N | 148 |

Scratch/Cleaning

| | |
|-------|-----|
| 186 | 150 |
| 187 | 150 |
| 189 | 150 |
| 190 | 150 |
| 214-H | 150 |
| 215-H | 150 |
| 262 | 150 |
| 263 | 150 |
| 263A | 150 |
| 264 | 150 |
| 264A | 150 |
| 265 | 150 |
| 265A | 150 |
| 266 | 150 |
| 266A | 150 |
| 267 | 150 |
| 267A | 150 |
| 268 | 150 |
| 268A | 150 |

CUTTERS

Angled

| | |
|-------|----|
| 67EI | 25 |
| 90EI | 25 |
| 7104E | 24 |
| 7172E | 24 |
| 7175E | 23 |
| 7182E | 23 |
| 7204E | 24 |
| 7272E | 24 |
| 7275E | 23 |
| 7282E | 23 |
| 7375E | 22 |
| 7376E | 22 |

Cable

| | |
|---------|----|
| 511-6 | 33 |
| 511-6DP | 33 |

Hard Wire

| | |
|------------|----|
| 2876EHT | 27 |
| 2896EHT | 27 |
| 2897EHT | 27 |
| 2899EHT | 27 |
| 2899EHT-CR | 27 |

CUTTERS (Cont)

Oval

| | |
|----------|----|
| 7140E | 18 |
| 7141E | 18 |
| 7142E | 18 |
| 7240E | 18 |
| 7241E | 18 |
| 7242E | 18 |
| 7210E | 19 |
| 7250E | 19 |
| 7251E | 19 |
| 7260E | 19 |
| 7261E | 19 |
| 9231SL | 14 |
| 9232SL | 14 |
| 9231E | 15 |
| 9232E | 15 |
| 9240E | 17 |
| 9240SL | 16 |
| 9241E | 17 |
| 9241E-GM | 17 |
| 9241SL | 16 |
| 9242E | 17 |
| 9242SL | 16 |

Standoff-Shear

| | |
|----------------|----|
| 509-42A-US-XX | 32 |
| 530E-US-XX | 29 |
| 530E-4-US-XX | 30 |
| 530E-5-USL-XX | 29 |
| 530E-15-US | 29 |
| 530E-15-US-RSS | 29 |
| 530EA-US-XX | 29 |
| 549E-US-XX | 32 |
| 903-XX | 31 |
| 903A-XX | 31 |
| 907-1-XX | 30 |
| 907-4-XX | 30 |
| 907-5-XX | 31 |
| 907-42A-XX | 32 |
| 907-59-XX | 32 |

Tapered

| | |
|----------|----|
| 9235SL | 14 |
| 7143E | 18 |
| 7144E | 18 |
| 7145E | 18 |
| 7243E | 18 |
| 7244E | 18 |
| 7245E | 18 |
| 9243SL | 16 |
| 9244SL | 16 |
| 9245SL | 16 |
| 9243E | 17 |
| 9244E | 17 |
| 9244E-GM | 17 |
| 9245E | 17 |

Tapered and Relieved

| | |
|--------|----|
| 7146E | 18 |
| 7147E | 18 |
| 7148E | 18 |
| 7246E | 18 |
| 7247E | 18 |
| 7248E | 18 |
| 9238SL | 14 |
| 9238E | 15 |
| 9246E | 17 |
| 9246SL | 16 |
| 9247E | 17 |
| 9247SL | 16 |
| 9248E | 17 |
| 9248SL | 16 |

CUTTERS (Cont)

Tip Cutters

| | |
|--------------|----|
| 7149E | 21 |
| 7170E | 20 |
| 7170EA | 21 |
| 7171E | 20 |
| 7249E | 21 |
| 7270E | 20 |
| 7271E | 20 |
| 7270EA | 21 |
| 7371E | 20 |
| Transverse | |
| 73E-I | 26 |
| 7173E | 26 |
| 7174E | 26 |
| 7273E | 26 |
| 7274E | 26 |

HEMOSTATS

Standard

| | |
|-------|-----|
| 35PH | 145 |
| 35-SE | 145 |
| 36PH | 145 |
| 36-SE | 145 |
| 37PH | 145 |
| 37-SE | 145 |
| 38PH | 146 |
| 38-SE | 146 |
| 39PH | 146 |
| 39-SE | 146 |
| 40PH | 146 |
| 40-SE | 146 |

Mosquito/Needle Clamps

| | |
|----------|-----|
| NH-35-SE | 147 |
| NH-38-SE | 147 |
| 31-SE | 147 |
| 33A-SE | 147 |
| 33-SE | 147 |
| 36A-SE | 147 |

KITS

| | |
|-----------|-----|
| KST-DIS-1 | 129 |
| KST-DIS-2 | 129 |
| KST-10 | 127 |
| KST-10-SE | 127 |
| KST-5 | 127 |
| KST-5-SE | 127 |
| TW-700 | 128 |
| TW-900 | 128 |

LAB FORCEPS

Adson Tissue

| | |
|---------|-----|
| AF-2-SE | 133 |
| AF-3-SE | 133 |
| AF-4-SE | 133 |
| F-6-SE | 133 |

Dissection

| | |
|----------|-----|
| AF-1-SE | 131 |
| F-5-SE | 131 |
| 10G-SA | 131 |
| 10H-S-SE | 131 |

Dressing

| | |
|---------|-----|
| F-2-SE | 134 |
| F-3-SE | 134 |
| F-4-SE | 134 |
| 24-4-SE | 134 |

Rogeur

| | |
|---------|-----|
| R-275-C | 135 |
| R-275-S | 135 |
| R-277-C | 135 |
| R-277-S | 135 |

LAB FORCEPS

Soft Tissue Handling

| | |
|----------|-----|
| F-7-SE | 132 |
| 20A-1-SE | 132 |
| 23B-S-SE | 132 |
| 23D-S-SE | 132 |

MAGNIFIERS/LOUPES

| | |
|------|-----|
| 401 | 160 |
| 405 | 160 |
| 407 | 160 |
| 410 | 160 |
| 422 | 160 |
| 455A | 160 |

MINIATURE OILERS

| | |
|----------|-----|
| 260A | 154 |
| 260A-ESD | 154 |
| 260A-ET | 155 |
| 260A-R | 154 |
| 260AA | 154 |
| 260B | 154 |
| 260B-ESD | 154 |
| 260B-ET | 155 |
| 260C | 154 |
| 260C-ESD | 154 |
| 260C-ET | 155 |
| 260D | 154 |
| 260D-ESD | 154 |
| 260D-ET | 155 |
| 260D-R | 154 |
| 260E-ESD | 154 |
| 260H | 155 |
| 320-DP | 155 |

PIN VISES

| | |
|---------|-----|
| 220 | 157 |
| 227A | 157 |
| 227A-ET | 157 |
| 227B | 157 |
| 227B-ET | 157 |
| 227C-ET | 157 |
| 227C-P | 157 |
| 227D-ET | 157 |

PLIERS

Bent Nose

| | |
|----------|----|
| 381 | 36 |
| 384 | 36 |
| 2629 | 37 |
| 2829-CR | 44 |
| 2829D-CR | 44 |
| 2629S | 38 |
| 2629SD | 38 |
| 2829 | 41 |
| 2829L | 41 |
| 2829L | 41 |
| 2829LD | 41 |
| 2829SLD | 41 |
| 2904 | 43 |
| 2914 | 43 |

Chain Nose

| | |
|--------|----|
| 111 | 40 |
| 11DI | 40 |
| 441 | 39 |
| 382 | 36 |
| 744 | 40 |
| 2644 | 37 |
| 2644D | 37 |
| 2644S | 38 |
| 2644SD | 38 |

PLIERS (Cont)

Chain Nose (Cont)

| | |
|----------|----|
| 2844 | 41 |
| 2844-CR | 44 |
| 2844D | 41 |
| 2844D-CR | 44 |
| 2844L | 41 |
| 2844LD | 41 |
| 2844SL | 41 |
| 2844SLD | 41 |
| 2949 | 43 |

Concave/Convex

| | |
|-------------|----|
| 500-101-US | 46 |
| 500-101A-US | 46 |

Flat Nose

| | |
|----------|----|
| 42I | 39 |
| 385 | 36 |
| 2642 | 37 |
| 2642S | 38 |
| 2642SD | 38 |
| 2818 | 42 |
| 2842 | 42 |
| 2842-CR | 44 |
| 2842D | 42 |
| 2842D-CR | 44 |
| 2842L | 42 |

Needle Nose

| | |
|------------|----|
| 47I | 39 |
| 383 | 36 |
| 2647 | 37 |
| 2647D | 37 |
| 2647S | 38 |
| 2647SD | 38 |
| 2847 | 41 |
| 2847-CR | 44 |
| 2847D | 41 |
| 2847D-CR | 44 |
| 2847L | 41 |
| 2847LD | 41 |
| 2847SL | 41 |
| 2847SLD | 41 |
| 2905 | 43 |
| 2910 | 43 |

Round Blunt Nose

| | |
|---------|----|
| 531-US | 45 |
| 531A-US | 45 |
| 531B-US | 45 |
| 532-US | 45 |
| 532B-US | 45 |

Round/Flat Nose

| | |
|--------|----|
| 533-US | 45 |
|--------|----|

Round Nose

| | |
|---------|----|
| 43I | 39 |
| 386 | 36 |
| 743 | 40 |
| 2643 | 37 |
| 2643S | 38 |
| 2843 | 42 |
| 2843-CR | 44 |
| 2843L | 42 |
| 2843SL | 42 |

Tubing

| | |
|-----------|----|
| 51-T | 47 |
| 379A | 47 |
| 379B | 47 |
| 379C | 47 |
| 2922-14 | 47 |
| 2922-14-X | 47 |
| 2922-18 | 47 |
| 2922-38 | 47 |

PLIERS (Cont)

Wide Nose

| | |
|---------|----|
| 508-US | 46 |
| 508B-US | 46 |
| 508C-US | 46 |
| 508D-US | 46 |

PROBES/SCRIBES

Lab Specific

| | |
|------|-----|
| 333 | 159 |
| 333B | 159 |
| 333C | 159 |
| 333D | 159 |
| 333E | 159 |
| 333F | 159 |

Standard

| | |
|------|-----|
| 330A | 158 |
| 330B | 158 |
| 330C | 158 |
| 330D | 158 |
| 330E | 158 |
| 330K | 158 |
| 331A | 158 |
| 331B | 158 |
| 331C | 158 |
| 331D | 158 |
| 332A | 158 |
| 332B | 158 |
| 332C | 158 |
| 332D | 158 |
| 332E | 158 |
| 333A | 158 |
| 335A | 158 |
| 335B | 158 |
| 334 | 158 |
| 334C | 158 |
| 334D | 158 |
| 475A | 158 |
| 475B | 158 |
| 477 | 158 |
| 478 | 158 |

SCALPEL/RAZOR BLADES

| | |
|----------|-----|
| 177 | 152 |
| 177-10 | 152 |
| 177-11 | 152 |
| 177-11-R | 152 |
| 177-12 | 152 |
| 174 | 153 |
| 175-11 | 153 |
| 176-1 | 153 |
| 176-2 | 153 |
| 176-3 | 153 |
| 176-4 | 153 |
| 177A | 153 |
| 177-13 | 152 |
| 177-15 | 152 |
| 177-SE | 152 |
| 178-11-S | 153 |
| 181-10 | 152 |
| 181-22 | 152 |
| 181-SE | 152 |
| 181A-SE | 152 |

SCISSORS

Delicate Applications

| | |
|-----|-----|
| 351 | 139 |
| 352 | 139 |
| 353 | 139 |
| 354 | 138 |
| 355 | 138 |

SCISSORS (Cont)

Delicate Applications (Cont)

| | |
|------|-----|
| 356 | 138 |
| 357 | 138 |
| 358 | 138 |
| 359 | 139 |
| 361 | 137 |
| 361S | 137 |
| 362 | 137 |
| 362S | 137 |
| 363 | 137 |
| 364 | 137 |
| 365 | 137 |

Standard Fine Precision

| | |
|---------|-----|
| 270 | 141 |
| 270EC | 141 |
| 271 | 143 |
| 272 | 143 |
| 273 | 143 |
| 274 | 143 |
| 274A | 143 |
| 275 | 143 |
| 275A | 143 |
| 276 | 143 |
| 277 | 143 |
| 277A | 143 |
| 278 | 143 |
| 288 | 140 |
| 289 | 140 |
| 290 | 142 |
| 290EC | 142 |
| 291 | 142 |
| 292 | 142 |
| 295 | 142 |
| 297 | 142 |
| 298 | 142 |
| 298A | 142 |
| 298AB | 142 |
| 298B | 142 |
| 298B-EC | 142 |
| 298EC | 142 |
| 299 | 141 |
| 299EC | 141 |
| 346 | 140 |
| 346A | 140 |
| 346B | 140 |
| 348 | 140 |
| 349 | 140 |
| 349A | 140 |
| 349B | 140 |
| 366 | 140 |
| 367 | 140 |
| 368 | 140 |
| 376 | 143 |

Large

| | |
|------|-----|
| 299P | 144 |
| 309 | 144 |
| 339 | 144 |
| 340 | 144 |
| 341 | 144 |

Tungsten Carbide Blades

| | |
|----------|-----|
| 270-HT | 136 |
| 271-HT | 136 |
| 279-HT | 136 |
| 346-6-HT | 136 |
| 347-6-HT | 136 |
| 371A | 136 |
| 371B | 136 |

SPATULAS/MIRRORS

| | |
|-----|-----|
| 342 | 156 |
|-----|-----|

SPATULAS/MIRRORS (Cont)

| | |
|-----|-----|
| 343 | 156 |
| 345 | 156 |
| 415 | 156 |
| 416 | 156 |
| 417 | 156 |

SPECIAL TOOLS

Cutters/Lead Formers

| | |
|------------|----|
| 500-13A-US | 52 |
| 500-13B-US | 52 |
| 500-88-US | 50 |
| 500-89-US | 50 |
| 500-89B-US | 51 |
| 500-103-US | 52 |
| 500-108-US | 50 |
| 530E-1-US | 50 |
| 554-TXC-US | 52 |
| 900-10 | 52 |
| 900-88B | 51 |
| 907 | 50 |
| 907-88 | 51 |
| 907-88C | 51 |
| 907-89 | 51 |
| 907-89B | 52 |
| 930E-1 | 50 |

Insertion/Extraction Tools

| | |
|--------------|----|
| 505-US | 57 |
| 505-20-US-ST | 57 |
| 505A-US | 57 |
| 505B-US | 57 |
| 505BG-US | 57 |
| 505C-US | 57 |
| 505D-US | 57 |
| 505E-US | 57 |
| 505F-US | 57 |
| 505G-US | 57 |
| 505H-US | 57 |
| 505J-US | 57 |
| 505K-US | 57 |

Lead Forms

| | |
|-------------|----|
| 500-11-US | 53 |
| 500-15-US | 55 |
| 500-92-US | 53 |
| 500-95B-US | 56 |
| 500-104-US | 56 |
| 500-104B-US | 56 |
| 500-210-US | 56 |
| 500-210A-US | 56 |
| 500-210C-US | 55 |
| 554A-US | 53 |
| 554B-US | 53 |
| 554F-US | 53 |
| 554-3RB-US | 54 |
| 554-TX-US | 54 |
| 554-TXB-US | 54 |
| 907-104A | 55 |
| 907-210A | 55 |
| 909-4 | 54 |
| 909-4B | 54 |
| 954A | 53 |
| 954B | 54 |

TEST/MEASUREMENT

Continuity Tester

| | |
|-------|-----|
| PB-1 | 161 |
| PB-1L | 161 |

R-C-L Meter

| | |
|-----------|-----|
| TM-500 | 162 |
| TM-500-BX | 162 |
| TM-500-PX | 162 |

INDEX BY TYPE

TWEEZERS

5 Star Cobalt Alloy

| | |
|-----------|----|
| 2-CO | 63 |
| 3-CO | 63 |
| 4-CO | 63 |
| 5-CO | 63 |
| 3C-CO | 64 |
| 5A-CO | 64 |
| 7-CO | 64 |
| 7B-CO | 64 |
| 51-CO | 64 |
| M-3-CO | 65 |
| M-3-CO-ET | 65 |
| M-5-CO | 65 |
| M-5-CO-ET | 65 |
| M-6-CO | 65 |

Acetal Replaceable Tip

| | |
|------------|-----|
| M-159B-RTW | 113 |
| M-159C-RTW | 113 |
| M-159D-RTW | 113 |
| M-759-RTW | 113 |
| M-759D-RTW | 113 |
| 159B-RTW | 114 |
| 159B-RTWX | 114 |
| 159C-RTW | 114 |
| 159C-RTWX | 114 |
| 159D-RTW | 114 |
| 159D-RTWX | 114 |

Angled Medium Point

| | |
|-------------|----|
| 22 | 84 |
| 22-SA | 84 |
| 24-6-SA | 84 |
| 24-8-SA-SE | 84 |
| 24A-S-SE | 84 |
| 24-SA-PI | 84 |
| 24-SA-SE | 84 |
| 24-SA-SE-PH | 84 |

Angled Very Fine Point

| | |
|----------|----|
| 3CB-S | 76 |
| 5A-S | 76 |
| 5A-S-SE | 76 |
| 5A-SA | 76 |
| 5A-SA-PI | 76 |
| 5A-SA-SE | 76 |
| 5B-SA | 76 |
| 5B-SA-PI | 76 |
| 5C-SA | 77 |
| 6-PI | 78 |
| 6-S | 78 |
| 6-S-SE | 78 |
| 6-SA | 78 |
| 6-SA-PI | 78 |
| 6-SA-SE | 78 |
| 50-SA-PI | 77 |
| 51-S | 77 |
| 51-SA | 77 |
| 51-SA-PI | 77 |
| 65A-SA | 77 |

Carbon Fiber Replaceable Tip

| | |
|-----------|-----|
| M-159-RT | 113 |
| M-159A-RT | 113 |
| M-159B-RT | 113 |
| M-159C-RT | 113 |
| M-159D-RT | 113 |
| M-159E-RT | 113 |
| M-159F-RT | 113 |
| M-159G-RT | 113 |
| M-759D-RT | 113 |
| 159-RT | 111 |
| 159-RTX | 111 |
| 159A-RT | 111 |

TWEEZERS (Cont)

Carbon Fiber Replaceable Tip

| | |
|----------|-----|
| 159A-RTX | 111 |
| 159B-RT | 111 |
| 159B-RTX | 111 |
| 159C-RT | 112 |
| 159C-RTX | 112 |
| 159D-RT | 112 |
| 159D-RTX | 112 |
| 159E-RT | 112 |
| 159E-RTX | 112 |
| 159F-RT | 112 |
| 159F-RTX | 112 |
| 159G-RT | 111 |
| 159G-RTX | 111 |
| 759-RT | 111 |
| 759-RTX | 111 |
| 759D-RT | 112 |
| 759D-RTX | 112 |

Ceramic

| | |
|-----------|-----|
| 149B-CE | 115 |
| 277-CE | 115 |
| 277-CE-ET | 115 |
| 749A-CE | 115 |

Copolymer Replaceable Tip

| | |
|----------|-----|
| 179A-RT | 110 |
| 179A-RTX | 110 |
| 179D-RT | 110 |
| 179D-RTX | 110 |
| 179DN-RT | 110 |

Cross Action

| | |
|-------------|----|
| DN-2A-SA-SE | 88 |
| DN-3C-SA-SE | 87 |
| DN-7-SA-SE | 87 |
| 29-SA | 88 |
| 29-S-SE | 88 |
| 30-SA | 88 |
| 30-S-SE | 88 |
| 31-SA | 87 |
| 31-SA-C | 88 |

Curved Very Fine Point

| | |
|----------|----|
| 7-PI | 78 |
| 7-S | 78 |
| 7-S-PI | 78 |
| 7-S-SE | 78 |
| 7-SA | 78 |
| 7-SA-EC | 78 |
| 7-SA-PI | 78 |
| 7-SA-SE | 78 |
| 7B-S | 78 |
| 7B-SA | 78 |
| 7B-SA-PI | 78 |
| 7B-SA-SE | 78 |

Cutting

| | |
|-----------|-----|
| 14A-GW | 122 |
| 14A-N | 122 |
| 15 | 122 |
| 15A-C | 121 |
| 15A-GW | 119 |
| 15A-GW-ET | 121 |
| 15A-GW-M | 119 |
| 15A-GW-OF | 119 |
| 15A-GW-PB | 119 |
| 15A-GW-PI | 119 |
| 15A-GW-S | 119 |
| 15A-RW | 120 |
| 15A-RW-ET | 121 |
| 15A-RW-M | 120 |
| 15A-RW-OF | 120 |
| 15A-RW-PB | 120 |
| 15A-RW-S | 120 |

TWEEZERS (Cont)

Cutting (cont)

| | |
|--------|-----|
| 15A-SW | 121 |
| 52-MW | 123 |
| 54-MW | 123 |
| 55-MW | 123 |

Ergonomic

| | |
|--------------|----|
| AA-SA-ET | 97 |
| AA-SA-PI-ET | 97 |
| SS-SA-ET | 96 |
| 00-SA-ET | 97 |
| 00-SA-PI-ET | 97 |
| 00D-SA-ET | 97 |
| 00D-SA-PI-ET | 97 |
| 00-SA-R | 93 |
| 1-SA-ET | 95 |
| 2-SA-ET | 95 |
| 2A-SA-ET | 99 |
| 2A-SA-PI-ET | 99 |
| 2A-SA-R | 93 |
| 3-CO-ET | 96 |
| 3-SA-ET | 96 |
| 3-SA-PI-ET | 96 |
| 3C-CO-ET | 96 |
| 3C-SA-ET | 96 |
| 3C-SA-PI-ET | 96 |
| 3C-SA-SE-ET | 96 |
| 3C-SA-R | 93 |
| 4-SA-ET | 95 |
| 5-CO-ET | 95 |
| 5-S-ET | 95 |
| 5-SA-ET | 95 |
| 5-SA-PI-ET | 95 |
| 5-SA-R | 93 |
| 5A-SA-ET | 98 |
| 5A-SA-PI-ET | 98 |
| 5B-SA-ET | 98 |
| 5B-SA-PI-ET | 98 |
| 6-SA-ET | 99 |
| 6-SA-PI-ET | 99 |
| 7-CO-ET | 98 |
| 7-SA-ET | 98 |
| 7-SA-PI-ET | 98 |
| 7-SA-R | 93 |
| 51-CO-ET | 99 |
| 51-SA-PI-ET | 99 |

Exotic Metals

| | |
|---------------|----|
| 00-S-CC | 69 |
| 00-SA-DC | 68 |
| 00-SA-SE-TC15 | 71 |
| 2A-S-CC | 69 |
| 2A-SA-DC | 68 |
| 2A-SA-PI-TC15 | 71 |
| 2A-SA-SE-TC15 | 71 |
| 2A-SA-TC15 | 71 |
| 2A-SA-TC30 | 71 |
| 2A-SN | 67 |
| 2A-TA | 70 |
| 3C-S-CC | 69 |
| 3C-SA-DC | 68 |
| 3C-SN | 67 |
| 3C-TA | 70 |
| 5-S-CC | 69 |
| 5-SA-DC | 68 |
| 5-SA-SE-TC15 | 71 |
| 5-SN | 67 |
| 5-TA | 70 |
| 7-S-CC | 69 |
| 7-SA-DC | 68 |
| 7-SA-SE-TC15 | 71 |
| 7-SN | 67 |

TWEEZERS (Cont)

Exotic Metals (Cont)

| | |
|------------------------------------|-----|
| 7-TA | 70 |
| SS-SA-DC | 68 |
| Large Flat Point | |
| 8-SA-PI | 86 |
| 25-SA | 86 |
| 27-SA | 86 |
| 35A-SA | 86 |
| 35A-SA-SE | 86 |
| 36A-SA | 86 |
| 36A-SA-SE | 86 |
| Miniature | |
| M-AC | 91 |
| M-H-S | 91 |
| M-H-SA | 91 |
| M-00D | 91 |
| M-00D-SA | 91 |
| M-2-SA | 91 |
| M-2A-SA | 91 |
| M-3-S | 90 |
| M-4-S | 90 |
| M-4A-S | 90 |
| M-5-S | 90 |
| M-5-SA | 90 |
| M-5-SA-ET | 90 |
| 0C | 90 |
| 0C-SA | 90 |
| 0C-SA-PI | 90 |
| 0C-SA-SE | 90 |
| M-179A-RT | 91 |
| Plastic | |
| 2A-ESD | 117 |
| 3C-ESD | 117 |
| 6-ESD | 117 |
| 35A-ESD | 117 |
| 609-ESD | 117 |
| Peek Replaceable Tip | |
| 162A-RT | 109 |
| 162A-RTX | 109 |
| 162B-RT | 109 |
| 162B-RTX | 109 |
| 162C-RT | 109 |
| 162C-RTX | 109 |
| 162D-RT | 109 |
| 162D-RTX | 109 |
| 762A-RT | 109 |
| 762A-RTX | 109 |
| Small Parts Handling | |
| 31B-SA-SE | 104 |
| 40-S | 104 |
| 102A-SA | 101 |
| 103-SA | 101 |
| 104-SA | 101 |
| 109-SA | 101 |
| 110-SA | 102 |
| 111-SA | 102 |
| 115-SA | 102 |
| 116-CF | 104 |
| 116-CF-RTX | 104 |
| 116-SA | 103 |
| 121-SA | 102 |
| 122-SA | 103 |
| 123-SA | 101 |
| 124-SA | 103 |
| 125-SA | 103 |
| 126-SA | 103 |
| 815-SA-SE | 104 |
| 815B-SA-SE | 104 |
| Straight Broad/Medium Point | |
| 21-SA-PI | 83 |

TWEEZERS (Cont)

Straight Broad/Medium Point

| | |
|-------------|----|
| 21-SA-SE | 83 |
| 21-SA-SE-8 | 83 |
| 21-SA-SE-12 | 83 |
| 21-SA-SE-18 | 83 |
| 21-SA-SE-24 | 83 |
| 21-6-SA | 83 |
| 21-8-SA | 83 |
| 231-SA-SE | 83 |
| 231A-SA-SE | 83 |

Straight Medium Point

| | |
|-------------|----|
| AA | 79 |
| AA-S | 79 |
| AA-S-SE | 79 |
| AA-SA | 79 |
| AA-SA-PI | 79 |
| AA-SA-SE | 79 |
| AA-SA-SE-PH | 79 |
| AA-SE | 79 |
| AC | 81 |
| AC-PI | 81 |
| AC-SA | 81 |
| AC-SA-PI | 81 |
| AC-SA-SE | 81 |
| GG-SA | 79 |
| MM | 79 |
| MM-SA-PI | 79 |
| MM-SA-SE | 79 |
| MM-SE | 79 |
| 19-S | 81 |
| 20A-S-SE | 81 |
| 20-SA-PI | 81 |

Straight Strong Point

| | |
|-----------|----|
| 00 | 80 |
| 00-PI | 80 |
| 00-S | 80 |
| 00-SA | 80 |
| 00-SA-EC | 80 |
| 00-SA-PI | 80 |
| 00-SA-SE | 80 |
| 00-SE | 80 |
| 00B-SA | 80 |
| 00B-SA-PI | 80 |
| 00B-SA-SE | 80 |
| 00D | 80 |
| 00D-SA | 80 |
| 00D-SA-PI | 80 |
| 00D-SA-SE | 80 |
| 000-SA | 80 |
| 000-SA-PI | 80 |

Straight Round Fine Point

| | |
|-----------|----|
| 0 | 82 |
| 0-SA | 82 |
| 0-SA-SE | 82 |
| 0A | 82 |
| 00C | 82 |
| 00C-SA | 82 |
| 00C-SA-SE | 82 |

Straight Tapered

| | |
|---------|----|
| 2-S | 73 |
| 2-S-SE | 73 |
| 2-SA | 73 |
| 2-SA-PI | 73 |
| 2-SA-SE | 73 |
| 4-SA | 73 |
| 4-SA-PI | 73 |

TWEEZERS (Cont)

Straight Tapered (cont)

| | |
|---------|----|
| 4-SA-SE | 73 |
| 5 | 73 |
| 5-S | 73 |
| 5-S-PI | 73 |
| 5-S-SE | 73 |
| 5-SA | 73 |
| 5-SA-EC | 73 |
| 5-SA-PI | 73 |
| 5-SA-SE | 73 |

Straight Very Fine Point

| | |
|----------|----|
| P-S | 74 |
| 1-PI | 74 |
| 1-S | 74 |
| 1-S-SE | 74 |
| 1-SA | 74 |
| 1-SA-PI | 74 |
| 1-SA-SE | 74 |
| 3-S | 74 |
| 3-S-PI | 74 |
| 3-S-SE | 74 |
| 3-SA | 74 |
| 3-SA-PI | 74 |
| 3-SA-SE | 74 |
| 3C | 74 |
| 3C-SE | 74 |
| 3C-PI | 74 |
| 3C-S | 74 |
| 3C-S-PI | 74 |
| 3C-S-SE | 74 |
| 3C-SA | 74 |
| 3C-SA-EC | 74 |
| 3C-SA-PI | 74 |
| 3C-SA-SE | 74 |
| 53C-SA | 74 |
| 60-SA | 75 |
| 64-SA | 75 |
| SS-S | 75 |
| SS-S-SE | 75 |
| SS-SA | 75 |
| SS-SA-PI | 75 |
| SS-SA-SE | 75 |

Tapered Flat Round Point

| | |
|-----------|----|
| F-SA | 85 |
| F-SA-PI | 85 |
| 2A | 85 |
| 2A-S | 85 |
| 2A-S-SE | 85 |
| 2A-SA | 85 |
| 2A-SA-EC | 85 |
| 2A-SA-PI | 85 |
| 2A-SA-SE | 85 |
| 2AB-N | 85 |
| 2AB-SA-PI | 85 |
| 2AB-SA-SE | 85 |
| 52A-SA | 85 |

Wafer

| | |
|--------------|-----|
| 390-SA-PI | 106 |
| 390-SA-PI-B | 106 |
| 390L-SA-PI | 106 |
| 390L-SA-PI-B | 106 |
| 390T-SA-PI | 106 |
| 390T-SA-PI-B | 106 |
| 391-SA-PI | 106 |
| 391-SA-PI-B | 106 |
| 391P-SA-PI | 106 |

TWEEZERS (Cont)

Wafers (Cont)

| | |
|--------------|-----|
| 391P-SA-PI-B | 106 |
| 490-SA-PI | 106 |
| 490-SA-PI-B | 106 |
| 490L-SA-PI | 106 |
| 490L-SA-PI-B | 106 |
| 490T-SA-PI | 106 |
| 490T-SA-PI-B | 106 |
| 491-SA-PI | 106 |
| 491-SA-PI-B | 106 |
| 491D-SA-PI | 106 |
| 491D-SA-PI-B | 106 |
| 491P-SA-PI | 106 |
| 491P-SA-PI-B | 106 |
| 590-SA-PI | 107 |
| 590-SA-PI-B | 107 |
| 590L-SA-PI | 107 |
| 590L-SA-PI-B | 107 |
| 590T-SA-PI | 107 |
| 590T-SA-PI-B | 107 |
| 591-SA-PI | 107 |
| 591-SA-PI-B | 107 |
| 591D-SA-PI | 107 |
| 591D-SA-PI-B | 107 |
| 591P-SA-PI | 107 |
| 591P-SA-PI-B | 107 |
| 690-SA-PI | 107 |
| 690-SA-PI-B | 107 |
| 690L-SA-PI | 107 |
| 690L-SA-PI-B | 107 |
| 690T-SA-PI | 107 |
| 690T-SA-PI-B | 107 |
| 691-SA-PI | 107 |
| 691-SA-PI-B | 107 |
| 691D-SA-PI | 107 |
| 691D-SA-PI-B | 107 |
| 691P-SA-PI | 107 |
| 691P-SA-PI-B | 107 |
| 890L-SA | 107 |
| 890L-SA-B | 107 |
| 891-SA | 107 |
| 891-SA-B | 107 |

VACUUM SYSTEMS

Continous Vacuum

| | |
|--------|-----|
| PV-HV | 168 |
| 2000DA | 166 |
| 2000P | 166 |
| 2000R | 166 |
| 2000RK | 166 |
| 2000WP | 166 |
| 2000A | 167 |
| 2000C | 167 |
| 2000V | 167 |
| 2020 | 167 |
| 2021 | 167 |
| 2022 | 167 |
| 2023 | 167 |
| 2024 | 167 |
| 2040 | 167 |
| 2041 | 167 |
| 2043 | 167 |
| 2044 | 167 |
| 2050 | 167 |
| 2051 | 167 |
| 2052 | 167 |

VACUUM SYSTEMS(Cont)

| | |
|-----------------|-----|
| 2060 | 167 |
| 2071 | 167 |
| 4000-H | 168 |
| 4000-RF | 168 |
| 4000-ST | 168 |
| Pen Vacs | |
| CB-12 | 171 |
| CB-14 | 171 |
| CB-18 | 171 |
| CB-34 | 171 |
| CB-38 | 171 |
| CB-58 | 171 |
| CB-316 | 171 |
| CB-332 | 171 |
| PV-1-ESD-CNX | 169 |
| PV-2-ESD | 169 |
| PV-2A-ESD | 169 |
| PV-3A-ESD | 169 |
| PV-HV | 168 |
| PV-HV-B | 170 |
| PV-JR | 170 |
| PV-ST | 170 |
| PVB-02 | 171 |
| PVB-04 | 171 |
| PVB-05 | 171 |
| PVB-CB-12 | 171 |
| PVB-CB-14 | 171 |
| PVB-CB-18 | 171 |
| PVB-CB-34 | 171 |
| PVB-CB-38 | 171 |
| PVB-CB-58 | 171 |
| PVB-CB-316 | 171 |
| PVB-CB-332 | 171 |
| PVS-02 | 171 |
| PVS-04 | 171 |
| PVS-05 | 171 |
| PVS-CB-12 | 171 |
| PVS-CB-14 | 171 |
| PVS-CB-18 | 171 |
| PVS-CB-34 | 171 |
| PVS-CB-38 | 171 |
| PVS-CB-58 | 171 |
| PVS-CB-316 | 171 |
| PVS-CB-332 | 171 |

WIRE STRIPPERS

Pliers

| | |
|------------|-----|
| 502E-US-22 | 125 |
| 502E-US-24 | 125 |
| 502E-US-26 | 125 |
| 502E-US-28 | 125 |
| 502E-US-30 | 125 |
| 502E-US-50 | 125 |
| 510E-US | 125 |

Tweezers

| | |
|----------------|-----|
| 15A-ST-P3-38 | 124 |
| 15A-ST-PE-30 | 124 |
| 15A-ST-PE-32 | 124 |
| 15A-ST-PE-34 | 124 |
| 15A-ST-PE-36 | 124 |
| 15A-ST-PE-36-G | 124 |
| 15A-ST-PE-40 | 124 |
| 15A-ST-PE-40-R | 124 |
| 15A-ST-PE-42 | 124 |
| 15A-ST-PE-42-Y | 124 |
| 15A-ST-PE-46 | 124 |

LIMITED WARRANTY: There are no express warranties or implied warranties including, but not limited to, merchantability and fitness for a particular purpose.

COPYRIGHT © 2020 BY EXCELTA CORPORATION, Buellton, CA.

No part of this publication may be reproduced, stored in a retrieval system, or transmitted in any form or by any means, mechanical, photocopying, recording or otherwise, without the prior written permission of the Excelta Corporation.

The words Excelta®, Altima®, Precista®, Optima®, Cobaltima®, Neverust®, Selecta®, Lazer Line™, Ergo-Tweezer®, Intellitweezer® and TweezerMeter® are registered trademarks of Excelta Corporation.

Produced by Jim LaFrance & Daniel Graef. Photography by Daniel Graef.



Lazerline® Cutters



Pliers



Tweezers



Custom Tools



visit us @
excelta.com

