

Pen Multimeter with Voltage Detector

Model 381676A

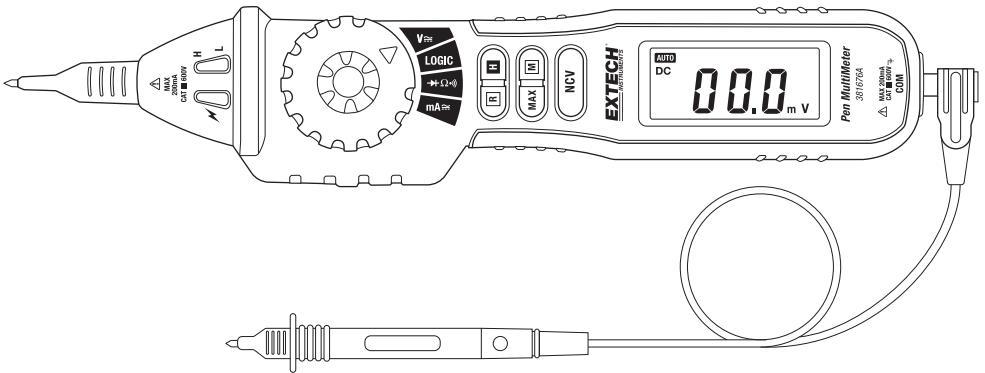

Introduction

Thank you for selecting the Extech Model 381676A. This instrument measures AC/DC Voltage and Current, Resistance, Diode, Continuity, Logic, and includes a non-contact Voltage Detector (NCV). Features include MAX Hold, Data Hold, Automatic Power OFF (APO), and Auto/Manual Range. This device is shipped fully tested and calibrated and, with proper use, will provide years of reliable service. Please visit the Extech Instruments website (www.extech.com) to check for the latest version of this User Guide.

Safety



WARNING: Improper use of this device can result in electric shock or damage to the meter. Follow all safety guidelines presented in this manual and the usual safety precautions used when working with electrical circuits.

This instrument conforms to GB/T 13978-92 for digital Multimeter technical standards, as well as GB4793.1-1995 (IEC -61010-1:2001) safety standards for electronic measuring instruments with a safety category of CAT III 600V and pollution degree 2.

Preliminary Safety

When using the meter, observe all normal safety rules concerning:

- Protection against the dangers of electrical current
- Protection of the meter against misuse

When the meter is delivered, check for transit damage. When checking voltage, always test the meter on a known live circuit first. Test leads must be in good condition. Before use, verify that the test lead insulation is intact and free from lead wire exposure or other damage. Use only the supplied test leads.

Safety during use

- Be sure to set the appropriate function and range before use
- Never exceed the limits indicated in the specification table of this manual.
- Never touch probes, test leads, or alligator clip when connected to live circuit.
- Do not measure voltage on terminals that exceed 600V above earth ground.
- Always use caution when working with voltages above 60VDC or 30VACrms. Keep fingers behind probe barrier when taking measurements.
- Never connect test leads across a voltage source while the rotary switch is in the resistance, continuity, or diode mode of operation.
- Never perform resistance, continuity, or diode tests on live circuits.
- When taking non-contact voltage measurements ensure that the positive test lead is NOT exposed and that the negative (common) test lead is not connected to the bottom of the meter.
- Before changing functions using the rotary function dial, be sure to disconnect the meter's test leads from any circuit under test.
- Never use the meter in an explosive environment or where dust, dirt, or steam exists.
- Never use the meter if the housing or battery compartment is open.
- Do not store meter in direct sunlight, high temperature/humidity, or condensation.
- If the equipment is used in a manner not specified by the manufacturer, the protection provided by the equipment may be impaired.
- ALWAYS discharge filter capacitors in power supplies and disconnect the power when making resistance or diode tests.

Safety Symbols



This symbol adjacent to another symbol, terminal or operating device indicates that the operator must refer to an explanation in the Operating Instructions to avoid personal injury or damage to the meter.



This symbol indicates that a device is protected throughout by double insulation or reinforced insulation.



This symbol advises the user that the terminal(s) so marked must not be connected to a circuit point at which the voltage with respect to earth ground exceeds 600V.

Controls and Jacks

1. Positive test probe (+)
2. Removable probe cover
3. NCV alert LED indicator
4. Logic (High/Low) LED Indicators
5. Finger guard
6. Rotary function switch
7. Range (R) button
8. Data Hold (H) button
9. Maximum Hold (MAX) button
10. Mode (M) button
11. NCV (non-contact volt detector) button
12. LCD display
13. Jack for Common (negative) test lead
14. Common (negative) test lead

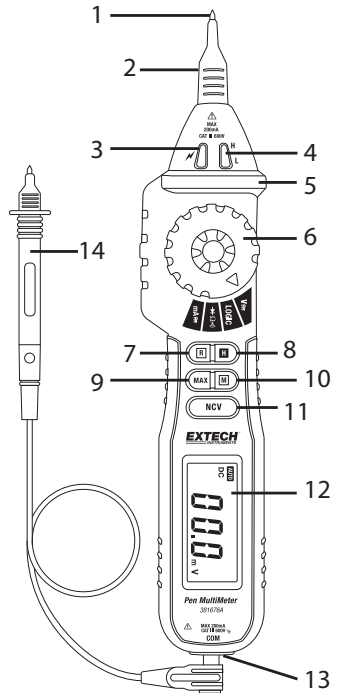

Note: The battery compartment is located on the rear of the instrument

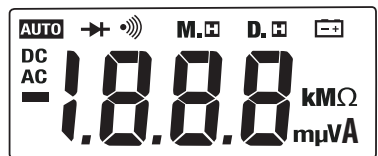

Display Symbols

•)))	Audible Continuity	V	Volts
▶	Diode function	Ω	Ohms
⊖	Low battery	D. H	Data Hold
μ	micro (10^{-12})	A	Amperes
m	milli (10^{-3}) (volts)	DC	Direct current
k	kilo (10^3) ohms	AC	Alternating current
M	Meg (10^6) ohms	M. H	Maximum Hold



Button Descriptions

Button Overview

BUTTON	MODE	DESCRIPTION
H (Data Hold)	Any Mode	Press to hold a reading on the display. Press and hold while turning the meter on to defeat APO
R (Range)	V, A, Ω	Press to Manually Range. Press and hold to return to AUTO Range
MAX (Maximum Hold)	Any Mode	Press to hold the Maximum reading on the display
NCV (Non-contact Voltage Detector)	Any Mode	Press and hold for Non-Contact Voltage Detector (set the Function switch to any position other than OFF)
M (Mode)	V, A, Ω ,  ,  , 	Switch between AC and DC Voltage/Current. Hold down to do Logic level testing. Switch between resistance, diode, and continuity

Button Details



DATA HOLD (H) Button

To freeze a displayed reading, press the **DATA HOLD (H)** button. The reading will freeze and the **D.H.** display icon will be visible on the LCD. To release the display, press the DATA HOLD (H) button again. The **D.H.** indicator will switch off and the display will again show real time readings.

MAXIMUM HOLD (MAX) Button

To display only the highest reading, press the **MAX** button. The **M.H.** display icon will be visible on the display while in the Max Hold mode. Now, the display will only change when a higher reading than the displayed reading is encountered. To return to normal operation, press the MAX button again (the **M.H.** display icon will switch off).

MODE (M) BUTTON

The **Mode (M)** button is used to select **AC** or **DC** while in the VOLTAGE (**V**) or CURRENT (**mA**) modes. The Mode (M) button is used to select diode () , Continuity () , or Resistance (Ω). Press and hold the Mode (M) button to take LOGIC tests while in the LOGIC mode.

RANGE (R) Button

The meter automatically selects the optimum range; however, the meter's ranges can be selected manually. When using the **Range (R)** button to manually select a range, start with the highest range and then select successively lower ranges until the desired range is reached. The decimal place will move with each press of the RANGE button. Press and hold the Range (R) button to return to the AUTO Range mode.

Test Lead Notes

The supplied black test leads (standard test lead and alligator clip probe) have protective plugs that must be removed before being inserted in the bottom of the meter. This protective apparatus must be removed from the end of the lead that plugs into the meter.

The positive (+) red probe cover is used when making Category III or higher measurements. Twist to remove this probe cover when making Category II or lower measurements.

Maximum Input Limits

Measurements	Input Limits
Voltage DC or AC	200mV range: 250V DC or AC rms 2~600V range: 600V DC or AC rms
Current DC or AC	Fuse protection (FF400mA/600V)
Logic, Resistance, Continuity, and Diode	250V DC or AC rms

Automatic Power OFF (APO)

The meter is equipped with an automatic power off feature to preserve battery energy. After 14 minutes of inactivity the meter will emit 5 short beeps. After another minute the meter will emit one long beep before finally turning off. To turn the meter on again, simply rotate the function switch to the desired function.

To defeat the APO feature, press and hold the **H** button while turning the meter on. The APO feature will re-enable after the meter is turned off again.

Operating Instructions

WARNING: Risk of electrocution. High-voltage circuits, both AC and DC, are very dangerous and should be measured with great care.

NOTE: On some low AC and DC voltage ranges, with the test leads not connected to a device, the display may show a random, changing reading. This is normal and is caused by the high-input sensitivity. Readings will stabilize and give proper measurement when test leads are connected to a circuit.

NON-CONTACT AC VOLTAGE DETECTOR (NCV)

WARNING: Test the AC voltage detector on a known live circuit before each use.

WARNING: Before using the meter in the AC Voltage Detector mode, verify that the batteries are fresh by confirming characters appear on the LCD when the function dial is turned to the voltage (V) position. Do not attempt to use the meter as an AC Voltage Detector if the batteries are weak or bad.

Notes:

Voltage may still exist even with no indication given by the meter. Do not solely rely on NCV detection to determine the presence of voltage. Socket design, insulation thickness and other factors may affect readings.

The NCV indicator LED may flash while measuring AC/DC voltage due to the presence of induced voltage.

External environmental interference from additional sources can falsely trigger NCV detection.

1. Disconnect the common (negative) test lead from the bottom of the meter.
2. With the function switch set to any position except OFF, press and hold the NCV button.
3. Move the tip of the meter near the voltage source or conductor as shown.
4. If the voltage detected is $> 110\text{VAC}$, the beeper will sound and the NCV indicator near the tip of the meter will flash. Always test the detector on a known live circuit first before attempting other tests.

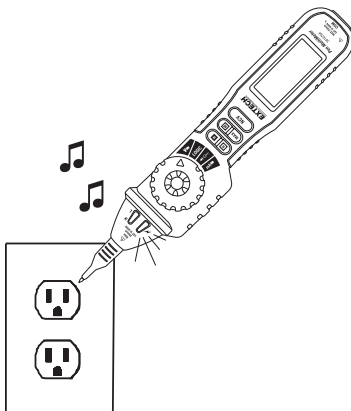

AC and DC VOLTAGE MEASUREMENTS

WARNING: Risk of Electrocution for AC Measurements. The probe tips may not be long enough to contact the live parts inside some 240V outlets for appliances because the contacts are recessed deep in the outlets. As a result, the reading may show 0 volts when the outlet actually has voltage present. Make sure the probe tips are touching the metal contacts inside the outlet before determining that no voltage is present.

CAUTION: Do not measure AC or DC voltage if a motor on the circuit is being switched ON or OFF. Large surges may occur that can damage the meter.

WARNING: To prevent electric shock and damage to the meter or personal injury, do not measure voltages that may exceed 600V DC or AC rms.

NOTES:

Before connecting the probe and test lead at lower voltage ranges, the display may show erratic readings. This is normal because the meter is highly sensitive. Once a connection is made, the true reading will be displayed.

'OL' indicates an over-range condition in manual mode. A higher range should then be selected.

In manual mode, select the highest range first if the value to be measured is unknown then lower the range as needed.

The AC millivolt range is only available in the manual range mode.

1. Use the probe cover if making measurements on category III or above installations.
2. Set the function dial to the **V** position.
3. Use the **Mode (M)** button to select **AC** or **DC**.
4. Insert the black test lead banana plug into the negative jack at the bottom of the meter.
5. Touch the black test probe tip to the neutral side of the circuit for AC measurements or to the positive side of the circuit for DC measurements.
6. Touch the positive test probe tip to the "hot" side of circuit for AC measurements or to the negative side of the circuit for DC measurements.
7. Read the voltage on the display. The meter automatically selects optimum range or the user may manually select a range by pressing the **Range (R)** button. Press and hold the Range (R) button to return to the AUTO Range mode.

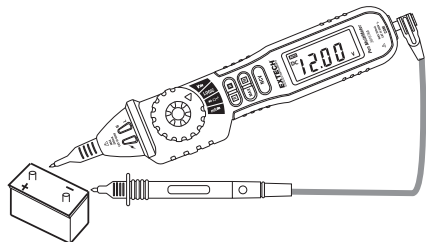
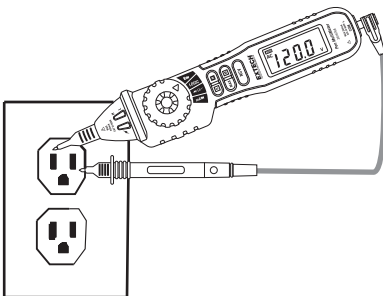

AC and DC CURRENT MEASUREMENTS

WARNING: Risk of electric shock. To prevent damage to the meter or personal injury, never measure current where open circuit voltages exceed 250V.

NOTE: 'OL' indicates an over-range condition in manual mode. A higher range should then be selected.

1. Use the probe cover if making measurements on category III or above installations
2. Set the function dial to the **mA** position.
3. Use the **Mode (M)** button to select **AC** or **DC**.
4. Insert the black test lead banana plug into the negative jack at the bottom of the meter.
5. Connect the test leads in series with the circuit under test.
6. Touch the black test probe tip to the negative side of the circuit.
7. Touch the positive test probe tip to the positive side of the circuit.
8. Read the current reading on the display. The meter automatically selects the optimum range or the user may manually select a range by pressing the **Range (R)** button. Press and hold the Range (R) button to return to the AUTO Range mode.

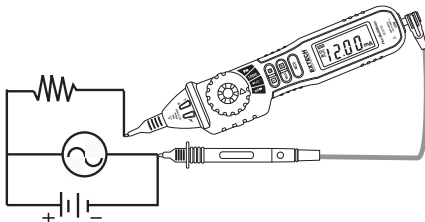

DIODE TEST

NOTES: The display shows the approximate forward voltage drop. If the connections are reversed or the leads are not connected, the display will show 'OL'.

1. Use the probe cover if making measurements on category III or above installations
2. Set the function switch to the Ω \rightarrow \rightarrow position.
3. Use the **Mode (M)** button to select the diode function \rightarrow .
4. Insert the black test lead banana plug into the negative (common) jack at the bottom of the meter.
5. Touch the test probes to the diode under test.
6. A good diode will indicate approx. 0.3V (germanium diodes) to 0.7V (silicon diodes) for the forward test and "OL" for the reverse test.
7. A shorted diode will indicate the same value of voltage in both the reverse and forward test directions. An open diode will indicate "OL" in both test directions.

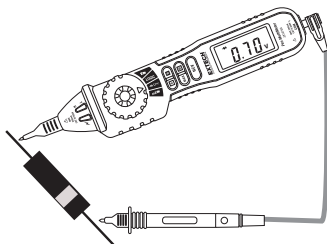

RESISTANCE MEASUREMENTS

WARNING: To avoid electric shock, disconnect power to the unit under test and discharge all capacitors before taking any resistance measurements.

NOTES:

'OL' indicates an over-range condition in manual mode. A higher range should then be selected.

If the resistance measured is greater than $1M\Omega$, the meter may take a few seconds to obtain a stable reading. This is normal for high resistance measurements.

When the leads are not connected or when measuring an open circuit, the display will read 'OL'.

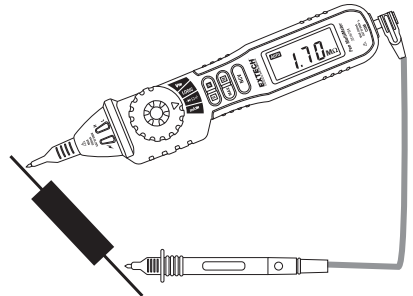

1. Use the probe cover if making measurements on category III or above installations
2. Set the function switch to the Ω  position.
3. Use the **Mode (M)** button to select the resistance mode (Ω).
4. Insert the black test lead banana plug into the negative jack at the bottom of the meter.
5. Touch the test probe tips across the circuit or part under test. It is best to disconnect one side of the part under test from the circuit so the rest of the circuit will not interfere with the resistance reading.
6. Read the resistance on the display. The meter automatically selects the optimum range or the user may manually select a range by pressing the **Range (R)** button. Press and hold the Range (R) button to return to the AUTO Range mode.



CONTINUITY CHECK

WARNING: Risk of electric shock. Ensure that all power to the circuit is off and capacitors have fully discharged before measuring continuity.

NOTE: If the resistance measured is greater than 200Ω , the test leads are not connected, or when measuring an open circuit, the display will read 'OL'.

1. Use the probe cover if making measurements on category III or above installations
2. Set the function switch to the Ω  position.
3. Use the **Mode (M)** button to select the audible continuity  mode.
4. Insert the black test lead banana plug into the negative jack at the bottom of the meter.
5. Touch the test probe tips to the circuit or wire under test.
6. If the resistance is less than approximately 50Ω , the audible tone will sound.

LOGIC TEST

WARNING: To prevent electric shock and damage to the meter or personal injury, do not measure voltages that may exceed 100V AC rms.

NOTE: If the test leads are disconnected or if the voltage measured is $< 1.5V$ the LED will be green.

1. Use the probe cover if making measurements on category III or above installations
2. Set the function switch to the **LOGIC** position.
3. Insert the black test lead banana plug into the negative (common) jack at the bottom of the meter.
4. Connect the black test lead to the circuit's ground (-) terminal.
5. Hold down the **Mode (M)** button and touch the test probe to the circuit for measurement. The LEDs near the tip of the meter will indicate the current logic level.
6. If the measurement is $0\sim 1.5V$, the Green LED will light and the display will show a down arrow, indicating that the logic test result is a LOW ('0') condition.
7. If the measurement is $1.5\sim 3.5V$, the Green and Red LEDs will be OFF.
8. If the measurement is $3.5\sim 5V$, the Red LED will light and the display will show an up arrow, indicating that the logic test result is a HIGH ('1') condition. See diagram.



Maintenance

WARNING: To avoid electrical shock, disconnect the test leads from any source of voltage before removing the back cover or the battery cover.

WARNING: To avoid electrical shock, do not operate the meter until the battery cover is in place and fastened securely.

This meter was designed to provide years of dependable service. However, if the following guidelines are not followed, the dependability of the meter can be compromised:

1. **KEEP THE METER DRY.** If it gets wet, wipe it off and allow it to dry before use.
2. **USE AND STORE THE METER IN NORMAL TEMPERATURES.** Environmental extremes can shorten the life of the electronic parts and distort or melt plastic parts.
3. **HANDLE THE METER GENTLY AND CAREFULLY.**
4. **KEEP THE METER CLEAN.** Wipe the case occasionally with a damp cloth. Do not use chemicals, cleaning solvents, abrasives, or detergents.
5. **USE ONLY FRESH BATTERIES OF THE RECOMMENDED SIZE/TYPE.**
6. **IF THE METER IS TO BE STORED FOR A LONG PERIOD REMOVE THE BATTERIES**
7. Repairs should only be implemented by trained personnel.

Battery Replacement

WARNING: To avoid electrical shock, disconnect the test leads from any source of voltage before removing the battery cover. Do not operate meter unless the batteries are in place.

1. The  icon will appear when battery voltage is low.
2. Turn the Function dial to the OFF position.
3. Disconnect the negative (common) test lead from the meter.
4. Remove the Phillips head screw at the rear center of the meter housing.
5. Remove the battery compartment cover to access the batteries.
6. Replace the two (2) 1.5V 'AAA' batteries observing polarity.
7. Secure the battery compartment cover.



All EU users are legally bound by the Battery Ordinance to return all used batteries to community collection points or wherever batteries / accumulators are sold. Disposal in household trash or refuse is prohibited.

Disposal: Follow the valid legal stipulations in respect of the disposal of the device at the end of its lifecycle

Other Battery Safety Reminders

- Never dispose of batteries in a fire. Batteries may explode or leak.
- Never mix battery types. Always install new batteries of the same type.

Test Lead or Alligator Clip Replacements

WARNING: Replacement leads must be of the same rating (or higher) as the leads supplied with the meter: 600V/10A

If the test leads' insulation is damaged or have wires exposed, the leads need to be replaced. Contact the original point of sale for details on ordering test leads or alligator clips or visit the Extech website www.extech.com for support.

Remember to use the positive (+) red probe cover for Category III (or higher) installations. Remove the positive probe cover for Category II (or lower) installations.

Cleaning

Use a damp cloth and a mild detergent to clean the meter; do not use abrasives or solvents. Do not operate the meter if it is wet or damp; allow it to fully dry before use.

Specifications

Function	Range	Resolution	Accuracy
NCV	50~600V	NA	
DC Voltage	200mV	0.1mV	±(0.7% reading + 2 digits)
	2.000V	1mV	
	20V	0.01V	
	200V	0.1V	
	600V	1V	
<i>Input Impedance: 10MΩ</i> <i>Overload protection: 200mV range: 250VDC or AC rms; 2V~600V ranges: 600VDC or AC rms</i> <i>Max. input voltage 600V DC</i>			
AC Voltage	200mV	0.1V	±(0.8% reading + 3 digits)
	2.000V	1mV	
	20V	0.01V	
	200V	0.1V	
	600V	1V	±(1.0% reading + 3 digits)
<i>Input Impedance: 10MΩ</i> <i>Overload protection: 200mV range: 250VDC or AC rms; 2V~600V ranges: 600VDC or AC rms</i> <i>Frequency range 40~400Hz</i> <i>Response: Average</i> <i>Max. input voltage 600V DC</i>			
DC Current	20mA	0.01mA	±(1.5% reading + 3 digits)
	200mA	0.1mA	
<i>Overload protection: Fuse (FF400mA/600V)</i>			
AC Current	20mA	0.01mA	±(2.0% reading + 3 digits)
	200mA	0.1mA	
<i>Overload protection: Fuse (FF400mA/600V)</i>			
<i>Frequency range: 4~200Hz</i>			
<i>Response: Average</i>			
Resistance	200 Ω	0.1 Ω	±(1.0% of reading + 3 digits)
	2k Ω	0.001k Ω	±(1.0% of reading + 1 digit)
	20k Ω	0.01k Ω	
	200k Ω	0.1k Ω	
	2M Ω	0.001M Ω	
	20M Ω	0.01M Ω	±(1.0% of reading + 5 digits)
<i>Open Circuit Voltage: approx. 250mV; Overload protection: 250V DC or AC rms</i>			
Continuity	If measured resistance is < 50 Ω beeper will sound		
<i>Open Circuit Voltage: approx. 500mV; Overload protection: 250V DC or AC rms</i>			
Diode	0.001V	Displays approx. forward-biased voltage)	
<i>Forward DC current: approx. 1mA</i>			
<i>Reverse DC voltage: approx. 1.5V</i>			
<i>Overload protection: 250V DC or AC rms</i>			
Logic	0~1.5V (Low '0') Green LED ON; 1.5~3.5V Green/Red LEDs OFF; 3.5~5V (High '1') Red LED ON		
<i>Input Impedance: 1MΩ; Overload protection: 250V DC or AC rms</i>			

Accuracy Notes: Accuracy specifications consist of two elements:

- (% reading) – This is the accuracy of the measurement circuit
- (+ digits) – This is the accuracy of the analog to digital converter

Accuracy is stated at 18°C to 28°C (64°F to 82°F) and less than 75% RH

General Specifications

Display	2000 count (0 to 1999) LCD
Ranging	Automatic and Manual
Over-range indication	'OL' is displayed
Auto Power Off	After 15 minutes (approx.) of inactivity
Polarity	Automatic (no indication for positive readings) Minus (-) sign for negative readings.
Measurement Rate	Approx. 2 times per second
Max. Voltage between Terminals and Earth Ground:	600V DC or AC
Fuse Protection	FF400mA/600V (for AC and DC Current modes)
Operating Temperature	0 °C to 40 °C (32 °F to 104 °F)
Storage Temperature	-10 °C to 50 °C (14 °F to 122 °F)
Operating Humidity	80% max., non-condensing
Storage Humidity	70% maximum with battery removed
Operating Altitude	2000m (6560') operating
Low Battery Indication	"  is displayed to alert battery replacement
Batteries	Two (2) 1.5V 'AAA' batteries
Weight / Size	129g (4.5oz) / 208 x 38 x 29mm (8.2 x 1.5 x 1.1")
Safety	For indoor use and in accordance with the requirements for double insulation to IEC1010-1 (1995); EN61010-1 (1995) Overvoltage Category III 600V, Pollution Degree 2.

Copyright © 2015 FLIR Systems, Inc.

All rights reserved including the right of reproduction in whole or in part in any form
ISO-9001 Certified

www.extech.com